

A photograph of a beach scene. In the foreground, there is a sandy dune with several tall, thin grasses with brown, feathery seed heads. The grasses are leaning slightly to the right. In the middle ground, the ocean waves are breaking, creating white foam. The water is a deep blue-green color. The background shows a vast, overcast sky with soft, diffused light. The overall mood is serene and natural.

PARTIAL DIFFERENTIAL EQUATIONS

An Introduction to Theory and Applications

MICHAEL SHEARER AND RACHEL LEVY

Partial Differential Equations

Partial Differential Equations

An Introduction to Theory and Applications

Michael Shearer

Rachel Levy

PRINCETON UNIVERSITY PRESS

Princeton and Oxford

Copyright © 2015 by Princeton University Press

Published by Princeton University Press, 41 William Street, Princeton, New Jersey 08540

In the United Kingdom: Princeton University Press, 6 Oxford Street, Woodstock, Oxfordshire OX20 1TW

press.princeton.edu

Cover photograph courtesy of Michael Shearer and Rachel Levy.

Cover design by Lorraine Betz Doneker.

All Rights Reserved

Library of Congress Cataloging-in-Publication Data

Shearer, Michael.

Partial differential equations : an introduction to theory and applications / Michael Shearer, Rachel Levy.

Pages cm

Includes bibliographical references and index.

ISBN 978-0-691-16129-7 (cloth : alk. paper)—ISBN 0-691-16129-1 (cloth : alk. paper)

1. Differential equations, Partial. I. Levy, Rachel, 1968– II. Title.

QA374.S45 2015

515'.353—dc23

2014034777

British Library Cataloging-in-Publication Data is available

This book has been composed in Minion Pro with Myriad Pro and DIN display using ZzT_EX by Princeton Editorial Associates Inc., Scottsdale, Arizona

Printed on acid-free paper. 

Printed in the United States of America

10 9 8 7 6 5 4 3 2 1

Contents

Preface ix

1. Introduction 1

1.1. Linear PDE 2

1.2. Solutions; Initial and Boundary Conditions 3

1.3. Nonlinear PDE 4

1.4. Beginning Examples with Explicit Wave-like Solutions 6

Problems 8

2. Beginnings 11

2.1. Four Fundamental Issues in PDE Theory 11

2.2. Classification of Second-Order PDE 12

2.3. Initial Value Problems and the Cauchy-Kovalevskaya Theorem 17

2.4. PDE from Balance Laws 21

Problems 26

3. First-Order PDE 29

3.1. The Method of Characteristics for Initial Value Problems 29

3.2. The Method of Characteristics for Cauchy Problems in Two Variables 32

3.3. The Method of Characteristics in \mathbb{R}^n 35

3.4. Scalar Conservation Laws and the Formation of Shocks 38

Problems 40

4. The Wave Equation 43

4.1. The Wave Equation in Elasticity 43

4.2. D'Alembert's Solution 48

4.3. The Energy $E(t)$ and Uniqueness of Solutions 56

4.4. Duhamel's Principle for the Inhomogeneous Wave Equation 57

4.5. The Wave Equation on \mathbb{R}^2 and \mathbb{R}^3 59

Problems 61

5. The Heat Equation 65

5.1. The Fundamental Solution 66

5.2. The Cauchy Problem for the Heat Equation 68

5.3. The Energy Method 73

- 5.4. The Maximum Principle 75
- 5.5. Duhamel's Principle for the Inhomogeneous Heat Equation 77
- Problems 78
- 6. Separation of Variables and Fourier Series 81**
- 6.1. Fourier Series 81
- 6.2. Separation of Variables for the Heat Equation 82
- 6.3. Separation of Variables for the Wave Equation 91
- 6.4. Separation of Variables for a Nonlinear Heat Equation 93
- 6.5. The Beam Equation 94
- Problems 96
- 7. Eigenfunctions and Convergence of Fourier Series 99**
- 7.1. Eigenfunctions for ODE 99
- 7.2. Convergence and Completeness 102
- 7.3. Pointwise Convergence of Fourier Series 105
- 7.4. Uniform Convergence of Fourier Series 108
- 7.5. Convergence in L^2 110
- 7.6. Fourier Transform 114
- Problems 117
- 8. Laplace's Equation and Poisson's Equation 119**
- 8.1. The Fundamental Solution 119
- 8.2. Solving Poisson's Equation in \mathbb{R}^n 120
- 8.3. Properties of Harmonic Functions 122
- 8.4. Separation of Variables for Laplace's Equation 125
- Problems 130
- 9. Green's Functions and Distributions 133**
- 9.1. Boundary Value Problems 133
- 9.2. Test Functions and Distributions 136
- 9.3. Green's Functions 144
- Problems 149
- 10. Function Spaces 153**
- 10.1. Basic Inequalities and Definitions 153

10.2.	Multi-Index Notation	157
10.3.	Sobolev Spaces $W^{k,p}(U)$	158
	Problems	159
11.	Elliptic Theory with Sobolev Spaces	161
11.1.	Poisson's Equation	161
11.2.	Linear Second-Order Elliptic Equations	167
	Problems	173
12.	Traveling Wave Solutions of PDE	175
12.1.	Burgers' Equation	175
12.2.	The Korteweg-deVries Equation	176
12.3.	Fisher's Equation	179
12.4.	The Bistable Equation	181
	Problems	186
13.	Scalar Conservation Laws	189
13.1.	The Inviscid Burgers Equation	189
13.2.	Scalar Conservation Laws	196
13.3.	The Lax Entropy Condition Revisited	201
13.4.	Undercompressive Shocks	204
13.5.	The (Viscous) Burgers Equation	206
13.6.	Multidimensional Conservation Laws	208
	Problems	211
14.	Systems of First-Order Hyperbolic PDE	215
14.1.	Linear Systems of First-Order PDE	215
14.2.	Systems of Hyperbolic Conservation Laws	219
14.3.	The Dam-Break Problem Using Shallow Water Equations	239
14.4.	Discussion	241
	Problems	242
15.	The Equations of Fluid Mechanics	245
15.1.	The Navier-Stokes and Stokes Equations	245
15.2.	The Euler Equations	247
	Problems	250

Appendix A. Multivariable Calculus	253
Appendix B. Analysis	259
Appendix C. Systems of Ordinary Differential Equations	263
References	265
Index	269

Preface

The field of partial differential equations (PDE for short) has a long history going back several hundred years, beginning with the development of calculus. In this regard, the field is a traditional area of mathematics, although more recent than such classical fields as number theory, algebra, and geometry. As in many areas of mathematics, the theory of PDE has undergone a radical transformation in the past hundred years, fueled by the development of powerful analytical tools, notably, the theory of functional analysis and more specifically of function spaces. The discipline has also been driven by rapid developments in science and engineering, which present new challenges of modeling and simulation and promote broader investigations of properties of PDE models and their solutions.

As the theory and application of PDE have developed, profound unanswered questions and unresolved problems have been identified. Arguably the most visible is one of the Clay Mathematics Institute Millennium Prize problems¹ concerning the Euler and Navier-Stokes systems of PDE that model fluid flow. The Millennium problem has generated a vast amount of activity around the world in an attempt to establish well-posedness, regularity and global existence results, not only for the Navier-Stokes and Euler systems but also for related systems of PDE modeling complex fluids (such as fluids with memory, polymeric fluids, and plasmas). This activity generates a substantial literature, much of it highly specialized and technical. Meanwhile, mathematicians use analysis to probe new applications and to develop numerical simulation algorithms that are provably accurate and efficient. Such capability is of considerable importance, given the explosion of experimental and observational data and the spectacular acceleration of computing power.

Our text provides a gateway to the field of PDE. We introduce the reader to a variety of PDE and related techniques to give a sense of the breadth and depth of the field. We assume that students have been exposed to elementary ideas from ordinary differential equations (ODE) and analysis; thus, the book is appropriate for advanced undergraduate or beginning graduate mathematics students. For the student preparing for research, we provide a gentle introduction to some current theoretical approaches to PDE. For the applied mathematics student more interested in specific applications and models, we present tools of applied mathematics in the setting of PDE. Science and engineering students will find a range of topics in the mathematics of PDE, with examples that provide physical intuition.

Our aim is to familiarize the reader with modern techniques of PDE,

introducing abstract ideas straightforwardly in special cases. For example, struggling with the details and significance of Sobolev embedding theorems and estimates is more easily appreciated after a first introduction to the utility of specific spaces. Many students who will encounter PDE only in applications to science and engineering or who want to study PDE for just a year will appreciate this focused, direct treatment of the subject. Finally, many students who are interested in PDE have limited experience with analysis and ODE. For these students, this text provides a means to delve into the analysis of PDE before or while taking first courses in functional analysis, measure theory, or advanced ODE. Basic background on functions and ODE is provided in [Appendices A–C](#).

To keep the text focused on the analysis of PDE, we have not attempted to include an account of numerical methods. The formulation and analysis of numerical algorithms is now a separate and mature field that includes major developments in treating nonlinear PDE. However, the theoretical understanding gained from this text will provide a solid basis for confronting the issues and challenges in numerical simulation of PDE.

A student who has completed a course organized around this text will be prepared to study such advanced topics as the theory of elliptic PDE, including regularity, spectral properties, the rigorous treatment of boundary conditions; the theory of parabolic PDE, building on the setting of elliptic theory and motivating the abstract ideas in linear and nonlinear semigroup theory; existence theory for hyperbolic equations and systems; and the analysis of fully nonlinear PDE.

We hope that you, the reader, find that our text opens up this fascinating, important, and challenging area of mathematics. It will inform you to a level where you can appreciate general lectures on PDE research, and it will be a foundation for further study of PDE in whatever direction you wish.

We are grateful to our students and colleagues who have helped make this book possible, notably David G. Schaeffer, David Uminsky, and Mark Hoefer for their candid and insightful suggestions. We are grateful for the support we have received from the fantastic staff at Princeton University Press, especially Vickie Kern, who has believed in this project from the start.

Rachel Levy thanks her parents Jack and Dodi, husband Sam, and children Tula and Mimi, who have lovingly encouraged her work.

Michael Shearer thanks the many students who provided feedback on the course notes from which this book is derived.

Partial Differential Equations

Introduction

Partial differential equations (PDE) describe physical systems, such as solid and fluid mechanics, the evolution of populations and disease, and mathematical physics. The many different kinds of PDE each can exhibit different properties. For example, the heat equation describes the spreading of heat in a conducting medium, smoothing the spatial distribution of temperature as it evolves in time; it also models the molecular diffusion of a solute in its solvent as the concentration varies in both space and time. The wave equation is at the heart of the description of time-dependent displacements in an elastic material, with wave solutions that propagate disturbances. It describes the propagation of p-waves and s-waves from the epicenter of an earthquake, the ripples on the surface of a pond from the drop of a stone, the vibrations of a guitar string, and the resulting sound waves. Laplace's equation lies at the heart of potential theory, with applications to electrostatics and fluid flow as well as other areas of mathematics, such as geometry and the theory of harmonic functions. The mathematics of PDE includes the formulation of techniques to find solutions, together with the development of theoretical tools and results that address the properties of solutions, such as existence and uniqueness.

This text provides an introduction to a fascinating, intricate, and useful branch of mathematics. In addition to covering specific solution techniques that provide an insight into how PDE work, the text is a gateway to theoretical studies of PDE, involving the full power of real, complex and functional analysis. Often we will refer to applications to provide further intuition into specific equations and their solutions, as well as to show the modeling of real problems by PDE.

The study of PDE takes many forms. Very broadly, we take two approaches in this book. One approach is to describe methods of constructing solutions, leading to formulas. The second approach is more theoretical, involving aspects of analysis, such as the theory of distributions and the theory of function spaces.

1.1. Linear PDE

To introduce PDE, we begin with four linear equations. These equations are basic to the study of PDE, and are prototypes of classes of equations, each with different properties. The primary elementary methods of solution are related to the techniques we develop for these four equations.

For each of the four equations, we consider an unknown (real-valued)

function u on an open set $U \subset \mathbb{R}^n$. We refer to u as the *dependent variable*, and $\mathbf{x} = (x_1, x_2, \dots, x_n) \in U$ as the vector of *independent variables*. A *partial differential equation* is an equation that involves \mathbf{x} , u , and partial derivatives of u . Quite often, \mathbf{x} represents only spatial variables. However, many equations are *evolutionary*, meaning that $u = u(\mathbf{x}, t)$ depends also on time t and the PDE has time derivatives. The *order* of a PDE is defined as the order of the highest derivative that appears in the equation.

The Linear Transport Equation:

$$u_t + cu_x = 0. \quad (1.1)$$

This simple first-order linear PDE describes the motion at constant speed c of a quantity u depending on a single spatial variable x and time t . Each solution is a *traveling wave* that moves with the speed c . If $c > 0$, the wave moves to the right; if $c < 0$, the wave moves left. The solutions are all given by a formula $u(x, t) = f(x - ct)$. The function $f = f(\xi)$, depending on a single variable $\xi = x - ct$, is determined from side conditions, such as boundary or initial conditions.

The next three equations are prototypical second-order linear PDE.

The Heat Equation:

$$u_t = k\Delta u. \quad (1.2)$$

In this equation, $u(\mathbf{x}, t)$ is the temperature in a homogeneous heat-conducting material, the parameter $k > 0$ is constant, and the Laplacian Δ is defined by

$$\Delta f(\mathbf{x}) = \nabla \cdot \nabla f(\mathbf{x}) = \sum_{i=1}^n \frac{\partial^2 f(\mathbf{x})}{\partial x_i^2}$$

in Cartesian coordinates. The heat equation, also known as the diffusion equation, models diffusion in other contexts, such as the diffusion of a dye in a clear liquid. In such cases, u represents the concentration of the diffusing quantity.

The Wave Equation:

$$u_{tt} = c^2 \Delta u. \quad (1.3)$$

As the name suggests, the wave equation models wave propagation. The parameter c is the wave speed. The dependent variable $u = u(\mathbf{x}, t)$ is a displacement, such as the displacement at each point of a guitar string as the string vibrates, if $\mathbf{x} \in \mathbb{R}$, or of a drum membrane, in which case $\mathbf{x} \in \mathbb{R}^2$. The acceleration u_{tt} , being a second time derivative, gives the wave equation quite different properties from those of the heat equation.

Laplace's Equation:

$$\Delta u = 0. \tag{1.4}$$

Laplace's equation models equilibria or steady states in diffusion processes, in which $u(\mathbf{x}, t)$ is independent of time t ,¹ and appears in many other contexts, such as the motion of fluids, and the equilibrium distribution of heat.

These three second-order equations arise often in applications, so it is very useful to understand their properties. Moreover, their study turns out to be useful theoretically as well, since the three equations are prototypes of second-order linear equations, namely, elliptic, parabolic, and hyperbolic PDE.

1.2. Solutions; Initial and Boundary Conditions

A *solution* of a PDE such as any of (1.1)–(1.4) is a real-valued function u satisfying the equation. Often this means that u is as differentiable as the PDE requires, and the PDE is satisfied at each point of the domain of u . However, it can be appropriate or even necessary to consider a more general notion of solution, in which u is not required to have all the derivatives appearing in the equation, at least not in the usual sense of calculus. We will consider this kind of *weak solution* later (see [Chapter 11](#)).

As with ordinary differential equations (ODE), solutions of PDE are not unique; identifying a unique solution relies on side conditions, such as initial and boundary conditions. For example, the heat equation typically comes with an *initial condition* of the form

$$u(\mathbf{x}, 0) = u_0(\mathbf{x}), \quad \mathbf{x} \in U, \tag{1.5}$$

in which $u_0 : U \rightarrow \mathbb{R}$ is a given function.

Example 1. (Simple initial condition) The functions $u(x, t) = ae^{-t} \sin x + be^{-4t} \sin(2x)$ are solutions of the heat equation $u_t = u_{xx}$ for any real numbers a, b . However, $a = 3, b = -7$ would be uniquely determined by the initial condition $u(x, 0) = 3 \sin x - 7 \sin(2x)$. Then $u(x, t) = 3e^{-t} \sin x - 7e^{-4t} \sin(2x)$.

Boundary conditions are specified on the boundary ∂U of the (spatial) domain. *Dirichlet boundary conditions* take the following form, for a given function $f : \partial U \rightarrow \mathbb{R}$:

$$u(\mathbf{x}, t) = f(\mathbf{x}), \quad \mathbf{x} \in \partial U, \quad t > 0.$$

Neumann boundary conditions specify the normal derivative of u on the boundary:

$$\frac{\partial u}{\partial \nu}(\mathbf{x}, t) = f(\mathbf{x}), \quad \mathbf{x} \in \partial U, \quad t > 0,$$

where $\nu(\mathbf{x})$ is the unit outward normal to the boundary at \mathbf{x} . These boundary conditions are called *homogeneous* if $f \equiv 0$. Similarly, a linear PDE is called *homogeneous* if $u = 0$ is a solution. If it is not homogeneous, then the equation or boundary condition is called *inhomogeneous*.

Equations and boundary conditions that are linear and homogeneous have the property that any linear combination $u = av + bw$ of solutions v, w , with $a, b \in \mathbb{R}$, is also a solution. This special property, sometimes called the principle of superposition, is crucial to constructive methods of solution for linear equations.

1.3. Nonlinear PDE

We introduce a selection of nonlinear PDE that are significant by virtue of specific properties, special solutions, or their importance in applications.

The Inviscid Burgers Equation:

$$u_t + uu_x = 0 \tag{1.6}$$

is an example of a nonlinear first-order equation. Notice that this equation is *nonlinear* due to the uu_x term. It is related to the linear transport [equation \(1.1\)](#), but the wave speed c is now u and depends on the solution. We shall see in [Chapter 3](#) that this equation and other first-order equations can be solved systematically using a procedure called the *method of characteristics*. However, the method of characteristics only gets you so far; solutions typically develop a singularity, in which the graph of u as a function of x steepens in places until at some finite time the slope becomes infinite at some x . The solution then continues with a shock wave. The solution is not even continuous at the shock, but the solution still makes sense, because the PDE expresses a *conservation law* and the shock preserves conservation.

For higher-order nonlinear equations, there are no methods of solution that work in as much generality as the method of characteristics for first-order equations. Here is a sample of higher-order nonlinear equations with interesting and accessible solutions.

Fisher's Equation:

$$u_t = \Delta u + f(u),$$

with $f(u) = u(1 - u)$. This equation is a model for population dynamics when the spatial distribution of the population is taken into account. Notice the resemblance to the heat equation; also note that the ODE $u'(t) = f(u(t))$ is the *logistic equation*, describing population growth limited by a maximum population normalized to $u = 1$. In [Chapter 12](#), we shall construct *traveling waves*, special

solutions in which the population distribution moves with a constant speed in one direction. Recall that all solutions of the linear transport [equation \(1.1\)](#) are traveling waves, but they all have the same speed c . For Fisher's equation, we have to determine the speeds of traveling waves as part of the problem, and the traveling waves are special solutions, not the general solution.

The Porous Medium Equation:

$$u_t = \Delta(u^m). \quad (1.7)$$

In this equation, $m > 0$ is constant. The porous medium equation models flow in porous rock or compacted soil. The variable $u(\mathbf{x}, t) \geq 0$ measures the density of a compressible gas in a given location \mathbf{x} at time t . The value of m depends on the equation of state relating pressure in the gas to its density. For $m = 1$, we recover the heat equation, but for $m \neq 1$, the equation is nonlinear. In fact, $m \geq 2$ for gas flow.

The Korteweg-deVries (KdV) Equation:

$$u_t + uu_x + u_{xxx} = 0.$$

This third-order equation is a model for water waves in which the height of the wave is $u(x, t)$. The KdV equation has particularly interesting traveling wave solutions called *solitary waves*, in which the height is symmetric about a single crest. The equation is a model in the sense that it relies on an approximation of the equations of fluid mechanics in which the length of the wave is large compared to the depth of the water.

Burgers' Equation:

$$u_t + uu_x = \nu u_{xx}.$$

The parameter $\nu > 0$ represents viscosity, hence the name *inviscid* Burgers equation for the first-order [equation \(1.6\)](#) having $\nu = 0$. Burgers' equation is a combination of the heat equation with a nonlinear term that convects the solution in a way typical of fluid flow. (See the Navier-Stokes system later in this list.) This important equation can be reduced to the heat equation with a clever change of dependent variable, called the *Cole-Hopf transformation* (see [Chapter 13, Section 13.5](#)).

Finally, we mention two *systems* of nonlinear PDE.

The Shallow Water Equations:

$$\begin{aligned} h_t + (hv)_x &= 0, \\ v_t + vv_x - gh_x &= 0, \end{aligned}$$

in which $g > 0$ is the gravitational acceleration. The dependent variables h, v

represent the height and velocity, respectively, of a shallow layer of water. The variable x is the horizontal spatial variable, along a flat bottom, and it is assumed that there is no dependence or motion in the orthogonal horizontal direction. Moreover, the velocity v is taken to be independent of depth.

The Navier-Stokes Equations:

$$\begin{aligned} \mathbf{u}_t + \mathbf{u} \cdot \nabla \mathbf{u} &= -\nabla p + \nu \Delta \mathbf{u}, \\ \nabla \cdot \mathbf{u} &= 0. \end{aligned}$$

describe the velocity $\mathbf{u} \in \mathbb{R}^3$ and pressure p in the flow of an incompressible viscous fluid. In this system of four equations, the parameter $\nu > 0$ is the viscosity, the first three equations (for \mathbf{u}) represent conservation of momentum, and the final equation is a constraint that expresses the incompressibility of the fluid. In an incompressible fluid, local volumes are unchanged in time as they follow the flow. Apart from special types of flow (such as in a stratified fluid), incompressibility also means that the density is constant (and is incorporated into ν , the kinematic viscosity).

Interestingly, the momentum equation, regarded as an evolution equation for \mathbf{u} , resembles Burgers' equation in structure. The pressure p does not have its own evolution equation; it serves merely to maintain incompressibility. In the limit $\nu \rightarrow 0$, we recover the incompressible Euler equations for an inviscid fluid. This is a singular limit in the sense that the order of the momentum equation is reduced. It is also a singular limit for Burgers' equation.

1.4. Beginning Examples with Explicit Wave-like Solutions

The linear and nonlinear first order equations described in [Sections 1.1](#) and [1.3](#) nicely illustrate mathematical properties and representation of wave-like solutions. We discuss these equations and their solutions as a starting point for more general considerations.

1.4.1. The Linear Transport Equation

Solutions of the linear transport equation,

$$u_t + cu_x = 0, \tag{1.8}$$

where $c \in \mathbb{R}$ is a constant (the wave speed), are traveling waves $u(x, t) = f(x - ct)$. We can determine a unique solution by specifying the function $f : \mathbb{R} \rightarrow \mathbb{R}$ from an initial condition

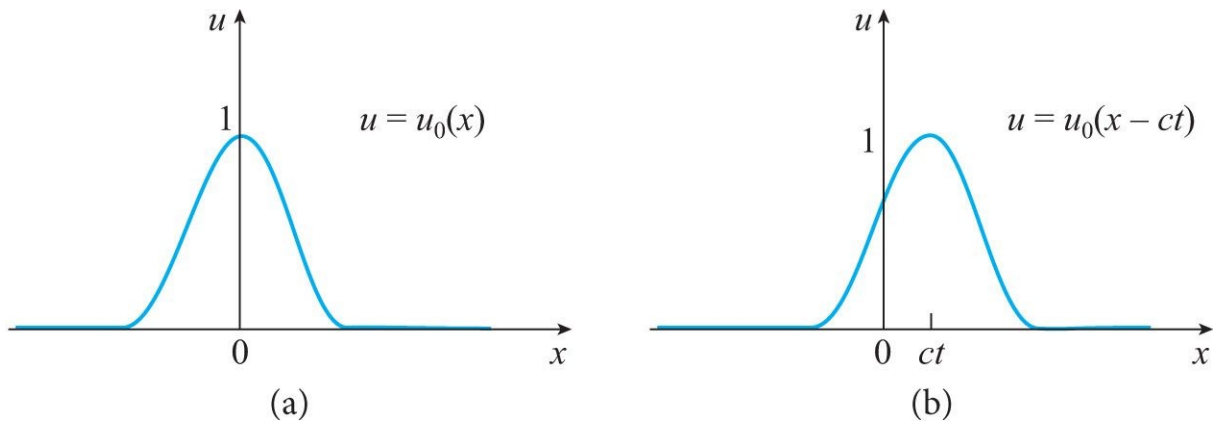

Figure 1.1. Linear transport equation: traveling wave solution. (a) $t = 0$; (b) $t > 0$.

$$u(x, 0) = u_0(x), \quad -\infty < x < \infty, \quad (1.9)$$

in which $u_0 : \mathbb{R} \rightarrow \mathbb{R}$ is a given function. Then the unique solution of the *initial value problem* (1.8), (1.9) is the traveling wave $u(x, t) = u_0(x - ct)$. A typical traveling wave is shown in Figure 1.1.

Instead of initial conditions, we can also specify a *boundary condition* for this PDE. Here is an example of how this would look, for functions ϕ, ψ given on the interval $[0, \infty)$:

$$\begin{aligned} \text{(initial condition)} \quad & u(x, 0) = \phi(x), \quad \text{if } x \geq 0, \\ \text{(boundary condition)} \quad & u(0, t) = \psi(t), \quad \text{if } t \geq 0. \end{aligned} \quad (1.10)$$

The solution u of (1.8), (1.10) will be a function defined on the first quadrant $Q_1 = \{(x, t) : x \geq 0, t \geq 0\}$ in the x - t plane. The general solution of the PDE is $u(x, t) = f(x - ct)$; the initial condition specifies $f(y)$ for $y > 0$, and the boundary condition gives $f(y)$ for $y < 0$. Both are needed to determine the solution $u(x, t)$ on Q_1 .

1.4.2. The Inviscid Burgers Equation

This equation,

$$u_t + uu_x = 0, \quad (1.11)$$

has wave speed u that depends on the solution, in contrast to the linear transport equation (1.8) in which the wave speed c is constant. If we use the wave speed to track the solution, we can sketch its evolution. In Figure 1.2 we show how an initial condition (1.9) evolves for small $t > 0$. Points nearer the crest travel faster, since u is larger there, so the front of the wave tends to steepen, while the back spreads out. Notice how Figure 1.2 differs from Figure 1.1. The solution $u = u(x, t)$ can be specified implicitly in an equation without derivatives:

$$u = u_0(x - ut). \quad (1.12)$$

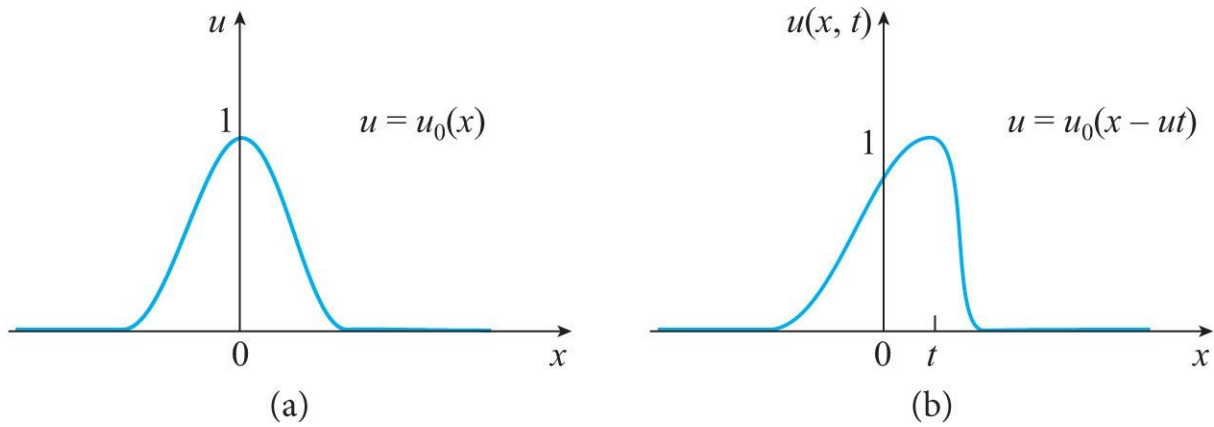

Figure 1.2. Inviscid Burgers equation: nonlinear wave propagation. (a) $t = 0$; (b) $t > 0$.

Eventually, the graph becomes infinitely steep, and the implicit solution in (1.12) is no longer valid. The solution is continued to larger time by including a shock wave, defined in Chapter 13.

PROBLEMS

1. Show that the traveling wave $u(x, t) = f(x - 3t)$ satisfies the linear transport equation $u_t + 3u_x = 0$ for any differentiable function $f: \mathbb{R} \rightarrow \mathbb{R}$.
2. Find an equation relating the parameters k, m, n so that the function $u(x, t) = e^{mt} \sin(nx)$ satisfies the heat equation $u_t = ku_{xx}$.
3. Find an equation relating the parameters c, m, n so that the function $u(x, t) = \sin(mt) \sin(nx)$ satisfies the wave equation $u_{tt} = c^2 u_{xx}$.
4. Find all functions $a, b, c: \mathbb{R} \rightarrow \mathbb{R}$ such that $u(x, t) = a(t)e^{2x} + b(t)e^x + c(t)$ satisfies the heat equation $u_t = u_{xx}$ for all x, t .
5. For $m > 1$, define the conductivity $k = k(u)$ so that the porous medium equation (1.7) can be written as the (quasilinear) heat equation

$$u_t = \nabla \cdot (k(u) \nabla u).$$

6. Solve the initial value problem

$$\begin{aligned} u_t + 4u_x &= 0, & -\infty < x < \infty, & t > 0, \\ u(x, 0) &= (1 + x^2)^{-1}, & -\infty < x < \infty. \end{aligned}$$

7. Solve the initial boundary value problem

$$\begin{aligned} u_t + 4u_x &= 0, & 0 < x < \infty, & t > 0, \\ u(x, 0) &= 0, & 0 < x < \infty, \\ u(0, t) &= te^{-t}, & t > 0. \end{aligned}$$

Explain why there is no solution if the PDE is changed to $u_t - 4u_x = 0$.

8. Consider the linear transport equation (1.8) with initial and boundary conditions (1.10).

(a) Suppose the data ϕ, ψ are differentiable functions. Show that the function $u : Q_1 \rightarrow \mathbb{R}$ given by

$$u(x, t) = \begin{cases} \phi(x - ct), & \text{if } x \geq ct, \\ \psi(t - x/c), & \text{if } x \leq ct \end{cases} \quad (1.13)$$

satisfies the PDE away from the line $x = ct$, the boundary condition, and initial condition. To see where (1.13) comes from, start from the general solution $u(x, t) = f(x - ct)$ of the PDE and substitute into the side conditions (1.10).

(b) In solution (1.13), the line $x = ct$, which emerges from the origin $x = t = 0$, separates the quadrant Q_1 into two regions. On the line, the solution has one-sided limits given by ϕ, ψ . Consequently, the solution will in general have singularities on the line.

(i) Find conditions on the data ϕ, ψ so that the solution is continuous across the line $x = ct$.

(ii) Find conditions on the data ϕ, ψ so that the solution is differentiable across the line $x = ct$.

9. Let $f : \mathbb{R} \rightarrow \mathbb{R}$ be differentiable. Verify that if $u(x, t)$ is differentiable and satisfies (1.12), that is, $u = f(x - ut)$, then $u(x, t)$ is a solution of the initial value problem

$$u_t + uu_x = 0, \quad -\infty < x < \infty, \quad t > 0, \quad u(x, 0) = f(x), \quad -\infty < x < \infty.$$

10. Let $u_0(x) = 1 - x^2$ if $-1 \leq x \leq 1$, and $u_0(x) = 0$ otherwise.

(a) Use (1.12) to find a formula for the solution $u = u(x, t)$ of the inviscid Burgers equation (1.11), (1.9) with $-1 < x < 1, 0 < t < \frac{1}{2}$.

(b) Verify that $u(1, t) = 0, 0 < t < \frac{1}{2}$.

(c) Differentiate your formula to find $u_x(1^-, t)$, and deduce that $u_x(1^-, t) \rightarrow -\infty$ as $t \rightarrow \frac{1}{2}^-$.

Note: $u_x(x, t)$ is discontinuous at $x = \pm 1$; the notation $u(1^-, t)$ means the one-sided limit: $u_x(1^-, t) = \lim_{x \rightarrow 1^-, x < 1} u_x(x, t)$. Similarly, $t \rightarrow \frac{1}{2}^-$ means, $t \rightarrow \frac{1}{2}$, with $t < \frac{1}{2}$.

1. However, there are time-dependent solutions, for example $u(x, t)$ linear in x or independent of x .

Beginnings

In the previous chapter we constructed solutions for example equations. However, much of the study of PDE is theoretical, revolving around issues of existence and uniqueness of solutions, and properties of solutions derived without writing formulas for the solutions. Of course, existence and uniqueness issues are resolved if it is possible to construct all solutions of a given PDE, but commonly this constructive approach is not available, and more abstract methods of analysis are required. In this chapter we outline theoretical considerations that will come up from time to time, give a somewhat general classification of single equations, and then give a flavor of theoretical approaches by presenting the Cauchy-Kovalevskaya theorem and discussing some of its ramifications. Finally, we show how PDE can be derived from balance laws (otherwise known as conservation laws) that come from fundamental considerations underlying the modeling of most applications.

2.1. Four Fundamental Issues in PDE Theory

Generally, the theoretical study of PDE focuses on four basic issues, three of which are lumped together as *well-posedness* in the sense of Hadamard.¹

1. *Existence*: Is there a solution of the PDE satisfying a specific set of boundary and initial conditions?
2. *Uniqueness*: Is there only one solution for a specific set of boundary and initial conditions?
3. *Continuous dependence on data*: Do small changes in initial conditions, boundary conditions, and parameters create only small changes in the solution? We might say the solution is *robust* to changes in the data. Sometimes, this property is called *structural stability*, or more loosely, *stability*.

The fourth property is generally separated from considerations of well-posedness:

4. *Regularity*: How many derivatives does the solution have? We sometimes refer to this property as the *smoothness* of the solution.

Well-posedness is a desirable property if the goal is to model a repeatable experiment, for example. Of the four properties, one could argue that the most important property is existence. After all, what use is a PDE model if it does not have a solution? In the theory of ODE, showing the existence of solutions is generally straightforward, at least locally, based on the classical existence and

uniqueness theorem for initial value problems. In the previous chapter we established existence by constructing solutions. However, in general the theory of existence of solutions for PDE is a complex and highly technical subject.

Existence. The approach of this book is to study existence issues only for classes of equations (and classes of solutions) for which the theory is elementary, such as classical (i.e., continuously differentiable) solutions of first-order equations. For second-order equations, we begin by choosing problems for which we can construct explicit solutions, thus avoiding the technicalities of proving general existence theorems. Toward the end of the book (see [Chaps. 9–11](#)), we introduce some of the theoretical underpinnings of more general theories of PDE, such as the theory of distributions, the use of Sobolev spaces, and maximum principles.

Uniqueness. Uniqueness is often the easiest property to establish. Moreover, it does not require the existence of solutions, as we can state: “There exists *at most* one solution.”

Continuous dependence. Continuous dependence can be established using techniques from analysis that estimate the closeness of distinct solutions with different data, in terms of the closeness of the data. Closeness of course involves defining a suitable notion of distance—a metric—on both the space in which solutions reside and on the space of data. These notions will be formally introduced as needed.

Regularity. Regularity is generally the hardest property to characterize, requiring the most delicate analysis. In this text we make observations about regularity from explicit solutions; regularity more generally and theoretically involves more technical machinery.

2.2. Classification of Second-Order PDE

When studying ODE, it is convenient to be able to distinguish among different kinds of equations based on such criteria as linear vs. nonlinear and separable vs. nonseparable. For PDE, there are also multiple ways to distinguish among equations, some similar to the criteria for ODE. In the next chapter we discuss first-order PDE in detail, showing that the theory is linked closely to systems of first-order ODE.

For second-order equations, there are distinct families of equations, distinguished by typical properties of their solutions. We identify the class of hyperbolic equations, with wave-like solutions, and elliptic equations, representing steady-state or equilibrium solutions. Between these two general classes are the parabolic equations, which, like hyperbolic equations, have a

time-like independent variable but also have properties akin to those of elliptic equations. The heat equation, the wave equation, and Laplace's equation are second-order linear constant-coefficient prototypes of parabolic, hyperbolic, and elliptic PDE, respectively. Although this chapter is primarily about linear equations in two variables, we include some remarks about equations with more independent variables and nonlinear equations.

2.2.1. Constant Coefficients

To explain how the terms *hyperbolic*, *elliptic*, and *parabolic* come to be associated with PDE, it is simplest to consider a second-order equation of the form

$$au_{xx} + 2bu_{xy} + cu_{yy} = f, \quad (2.1)$$

where the coefficients a, b, c are real numbers, and the right-hand side $f = f(x, y, u, u_x, u_y)$ is a given function containing any lower-order derivatives of u . The type of the equation is determined by the nature of the quadratic form obtained from the left-hand side of (2.1) by replacing each partial derivative by a real variable. More formally, we define the *principal part* of the PDE as the left-hand side of (2.1). Then the corresponding differential operator with *principal* indicated by the superscript (p) is

$$L^{(p)}[\partial_x, \partial_y] = a\partial_x^2 + 2b\partial_x\partial_y + c\partial_y^2.$$

Associated with this differential operator is the quadratic form, known as *the principal symbol*,

$$L^{(p)}[\xi_1, \xi_2] = a\xi_1^2 + 2b\xi_1\xi_2 + c\xi_2^2, \quad (2.2)$$

in which $\xi = (\xi_1, \xi_2) \in \mathbb{R}^2$. The connection between principal part and principal symbol is the observation

$$L^{(p)}[\partial_x, \partial_y]e^{i(\xi_1x + \xi_2y)} = -L^{(p)}[\xi_1, \xi_2]e^{i(\xi_1x + \xi_2y)}.$$

This conversion from differential operators ∂_x, ∂_y to multiplication by $i\xi_1, i\xi_2$ is typical of integral transforms; in this case, the connection is to Fourier transforms. The vector (ξ_1, ξ_2) is the Fourier transform variable, or wave number. Fourier transforms and their importance for the analysis of PDE are discussed in [Chapter 7](#).

The quadratic form (2.2) is associated with either a hyperbola (if $b^2 > ac$), an ellipse (if $b^2 < ac$), or is degenerate (if $b^2 = ac$). Correspondingly, we say the PDE (2.1) is *hyperbolic* if $b^2 > ac$, *elliptic* if $b^2 < ac$, and *parabolic* if $b^2 = ac$, provided the equation is second order (i.e., not all of a, b, c are zero).

Example 1. (Classification) The partial differential operator $L = \partial^2x + a\partial^2y$, is

elliptic for $\alpha > 0$, hyperbolic for $\alpha < 0$, and parabolic for $\alpha = 0$.

2.2.2. More General Second-Order Equations

A similar classification applies to second-order equations in any number of variables. As usual, write $\mathbf{x} = (x_1, x_2, \dots, x_n) \in \mathbb{R}^n$. Consider the equation

$$\sum_{i,j=1}^n a_{ij} u_{x_i x_j} = f, \quad (2.3)$$

where $f = f(\mathbf{x}, u, u_{x_1}, \dots, u_{x_n})$. We assume the real coefficients a_{ij} in the principal part $L^{(p)}u$ (given by the left-hand side) are constant and symmetric in i, j : $a_{ij} = a_{ji}$. (If they were not symmetric, we could rearrange the PDE using the equality of mixed partial derivatives to achieve symmetry.) The principal symbol is then

$$L^{(p)}[\xi] = \sum_{i,j=1}^n a_{ij} \xi_i \xi_j, \quad \xi = (\xi_1, \dots, \xi_n)^T. \quad (2.4)$$

The type of the PDE depends on the nature of this quadratic expression, which we can write in matrix form:

$$L^{(p)}[\xi] = \xi^T A \xi,$$

where $A = (a_{ij})$ is a real symmetric $n \times n$ matrix. If we change independent variables with an invertible linear transformation B ,

$$y = Bx,$$

then the chain rule changes the PDE (2.3). It is instructive (see [Problem 2](#)) to work out that the principal symbol now has coefficient matrix BAB^T . If B is an orthogonal matrix, then $B^{-1} = B^T$, so that the linear change of independent variables corresponds to a similarity transformation of A . Now let's choose B to diagonalize A , so that BAB^T has the n eigenvalues of A on the diagonal and zeroes elsewhere. This is achieved by letting the columns of B be the orthonormal eigenvectors of A . The effect on the PDE is to convert the principal part into a linear combination of pure second-order derivatives, in which the coefficients are the eigenvalues of A .

We say the PDE is *elliptic* if the eigenvalues of A are all nonzero, and all have the same sign. The PDE is called *hyperbolic* if all eigenvalues are nonzero, and all but one of them have the same sign. (There is the third possibility that, for $n \geq 4$, all but k eigenvalues, with $2 \leq k \leq n/2$, have the same sign. This case is called *ultrahyperbolic*, but it does not occur much, so we ignore it.) Finally, if there is at least one zero eigenvalue, then we could consider the PDE to be parabolic. In practice, parabolic equations occur most commonly as time-

dependent PDE like the heat equation, with a single zero eigenvalue. Such *parabolic* equations typically have the form

$$u_t = Lu + f,$$

where $u = u(\mathbf{x}, t)$, L is a linear elliptic operator with respect to the spatial variables, and $f = f(\mathbf{x}, t, u, u_{x_1}, \dots, u_{x_n})$. In this equation, only one eigenvalue of the coefficient matrix A is zero.

For each type of linear second-order PDE, we can find a change of independent variables to transform the equation into a canonical form, in which the corresponding matrix A is diagonal, so that only pure second-order derivatives occur (i.e., no cross derivatives). In fact, the change of variables can be done in general by observing how a linear change of independent variables corresponds to a similarity transformation of A . Then we can reverse the process to find the appropriate change of variables from a diagonalization of A .

Let $\mathbf{x} \in \mathbb{R}^n$ be the independent variable, and suppose we introduce a linear change of variables to \mathbf{y} , through the orthogonal matrix B defined above, so that BAB^T is diagonal:

$$\mathbf{y} = B\mathbf{x}.$$

In coordinates, this reads $y_i = \sum_{j=1}^n B_{ij}x_j$. If $u = u(\mathbf{x})$, we define $w(\mathbf{y}) = u(C\mathbf{y})$, where $C = B^{-1}$. Then a careful calculation gives

$$\sum_{i,j=1}^n a_{ij}u_{x_i x_j} = \sum_{i=1}^n \lambda_i w_{y_i y_i},$$

where $\lambda_1, \dots, \lambda_n$ are the eigenvalues of A .

Example 2. (Sample PDE operators) Let's adopt the notation ∂_j interchangeably with $\partial/\partial x_j$. Here we display a PDE operator, the corresponding matrix A , and the type of the operator:

1. $L = \partial_1^2 + 4\partial_2^2$; $A = \begin{pmatrix} 1 & 0 \\ 0 & 4 \end{pmatrix}$; elliptic.

2. $L = \partial_t^2 - 3\partial_x^2 - 7\partial_y^2$; $x_1 = t, x_2 = x, x_3 = y$; $A = \begin{pmatrix} 1 & 0 & 0 \\ 0 & -3 & 0 \\ 0 & 0 & -7 \end{pmatrix}$; hyperbolic.

Notice that for a hyperbolic equation, the one eigenvalue with a different sign suggests a time-like direction (associated with the corresponding eigenvalue). After diagonalizing A , we can scale each independent variable so that in the new variables, we have

$$L = \partial_1^2 - \sum_{j=2}^n \partial_j^2.$$

Variable coefficients and nonlinear equations. When the coefficients a_{ij} in (2.3) are functions of \mathbf{x} , u , u_{x_1} , ..., u_{x_n} , then the classification can vary with \mathbf{x} and can also depend on the solution. Here are some examples:

1. *The Tricomi Equation* (related to steady transonic flow): $u_{yy} = yu_{xx}$. This linear equation is hyperbolic for $y > 0$, elliptic for $y < 0$, and the x -axis $y = 0$ is called the parabolic line. We say the equation *changes type*.
2. *The Nonlinear Small Disturbance Equation*: $(\varphi_x - \frac{1}{2}\varphi_x^2)_x + \varphi_{yy} = 0$. This equation changes type on the line $\varphi_x = 1$.
3. *The Quasilinear Wave Equation*: $u_{tt} = F(u_x)_x$ is hyperbolic when $F'(u_x) > 0$. To see that it is hyperbolic, we write the equation as

$$u_{tt} = F'(u_x) u_{xx}.$$

However, when $F'(u_x) < 0$, the equation is elliptic. For a given solution, the change from hyperbolic to elliptic occurs on a curve $F'(u_x(x, t)) = 0$, where the equation is parabolic.

4. *The Semilinear Wave Equation*: $u_{tt} = \Delta u + f(u, \nabla u, u_t)$. For $u = u(\mathbf{x}, t)$, $\mathbf{x} \in \mathbb{R}^n$, the principal part is linear and hyperbolic, but the equation is nonlinear if $f: \mathbb{R}^{n+2} \rightarrow \mathbb{R}$ is nonlinear, for example $f = f(u) = u^2$.

2.2.3. Dispersion Relations

For time-dependent linear PDE with constant coefficients, we can sometimes get more information about solutions from a *dispersion relation*, which is connected to the Fourier transform in the same way as the principal symbol (2.4). It is easiest to see how this works in one space dimension and time, where $u = u(x, t)$. The basic idea is to consider a Fourier mode $u_0(x) = e^{i\xi x}$ as an initial condition. The parameter $\xi \geq 0$ is the *wave number*; it is the spatial frequency of u_0 . It is convenient to use the complex form, because then derivatives are also exponentials. Solutions will be of the form $u(x, t) = e^{i\xi x + \sigma t}$ for some complex number σ . But $\sigma = \sigma(\xi)$ depends on the wave number. This dependence is called the *dispersion relation*. In general, $\sigma(\xi)$ is not a homogeneous function, unlike $L^{(p)}[\xi]$, because $\sigma(\xi)$ involves the entire PDE, not just the principal part.

For the linear transport equation $u_t + cu_x = 0$, we find $\sigma = -ic\xi$. Corresponding solutions $u(x, t) = e^{i\xi(x-ct)}$ of the PDE are traveling waves (which is no surprise, since all solutions of this equation are traveling waves). The linear

wave equation $u_{tt} = c^2 u_{xx}$ has $\sigma(\xi) = \pm ic\xi$, corresponding to the traveling waves $u(x, t) = e^{i\xi(x \pm ct)}$.

For the heat equation $u_t = ku_{xx}$, we have $\sigma = -k\xi^2$. Therefore, every Fourier mode decays exponentially, provided $k > 0$, and the rate of decay increases quadratically with frequency. However, if $k < 0$, then each Fourier mode has exponential growth in time, and the growth $\sigma(\xi)$ is unbounded as a function of wave number ξ . This corresponds to ill-posedness, as it implies that a general initial condition (which involves arbitrarily high wave numbers) will blow up immediately. The same issue arises for initial value problems for elliptic equations, such as Laplace's equation. (See [Section 2.3.3](#).)

The linearized KdV equation $u_t + cu_x + \beta u_{xxx} = 0$ is an example of a dispersive equation. We find that $\sigma = -i\omega$ is imaginary for all wave numbers, and $\omega = c\xi - \beta\xi^3$. The corresponding solutions $u(x, t) = e^{i\xi(x - (c - \beta\xi^2)t)}$ are traveling waves, but the speed $c - \beta\xi^2$ depends quadratically on the wave number. From another point of view, ω is the temporal frequency, so that different Fourier modes oscillate in time at different frequencies. This is dispersion in the mathematical sense of different spatial wave numbers giving rise to traveling waves with different speeds and to oscillations at different frequencies.

The linear Benjamin-Bona-Mahoney (BBM) equation $u_t + cu_x + \beta u_{xxt} = 0$ is also dispersive, but the dispersion relation involves a bounded function ω . Another example of a dispersive equation is the beam equation $u_{tt} + k^2 u_{xxxx} = 0$.

For dispersive equations the traveling wave speed $\omega = \omega(\xi)$ is called the *phase speed* or *phase velocity*. Another speed of interest is the *group velocity*, defined as $c(\xi) = \frac{d}{d\xi}\omega(\xi)$. The group velocity of dispersive equations is different from the phase velocity. For nondispersive equations, such as the linear transport and wave equations, both velocities are the same as the single traveling wave speed or transport velocity. The roles of group velocity and phase velocity in linear and nonlinear wave equations are discussed in detail by Whitham in his classic text [46].

2.3. Initial Value Problems and the Cauchy-Kovalevskaya Theorem

Up to this point we have only constructed solutions with explicit formulas. In this section we outline an approach that constructs solutions as power series, leading to a version of the celebrated Cauchy-Kovalevskaya² Theorem. We consider *initial value problems* in a fairly general context, that of the second-order [equation \(2.1\)](#):

$$a(x, y)u_{xx} + 2b(x, y)u_{xy} + c(x, y)u_{yy} = f(x, y, u, u_x, u_y). \quad (2.5)$$

An initial value problem consists of the PDE, together with initial conditions:

$$\begin{aligned} u(x, 0) &= g(x) \\ u_y(x, 0) &= h(x). \end{aligned} \quad (2.6)$$

We assume that all functions a, b, c, f, g, h are all C^∞ .

In this problem, y is time-like, in the sense that $y = 0$ is an initial time, and we want to solve the initial value problem at least for a short time interval. The analysis of this section applies to both positive and negative y . In this section we discuss the existence of solutions that can be represented as a formal power series about $y = 0$. Such a series would take the form

$$u(x, y) = \sum_{k=0}^{\infty} \frac{1}{k!} u_k(x) y^k. \quad (2.7)$$

Remark. If (2.7) is a convergent series, then u has y derivatives of all orders, and

$$u_k(x) = \partial_y^k u(x, 0), \quad k = 0, 1, 2, \dots \quad (2.8)$$

Here the superscript indicates repeated derivatives: $\partial_y^k u = \frac{\partial^k}{\partial y^k} u$. Let's make the key assumption in (2.5) that $c(x, y)$ is nonzero for all x in some interval I (and all y near zero).³ Then (2.7) can be written (by dividing by c):

$$\partial_{yy} u = G(x, y, u, \partial_x u, \partial_y u, \partial_{xx} u, \partial_{xy} u), \quad (2.9)$$

where $G = \frac{1}{c(x, y)} (f(x, y, u, u_x, u_y) - a(x, y)u_{xx} - 2b(x, y)u_{xy})$.

Claim 2.1. For any $g, h \in C^\infty(I)$, (2.9) plus initial conditions (2.6) uniquely determine the C^∞ functions $u_k(x)$, $k = 0, 1, \dots$

Remarks. While the claim seems to be a uniqueness result, it is also an existence result, because it asserts that the functions $u_k(x)$ exist.

We are not going to prove the claim, but it is instructive to consider why it is true. The terms in (2.8) with $k = 0$ and $k = 1$ are given by the initial conditions (2.6). Differentiating these $m \geq 1$ times with respect to x gives $\partial_x^m u(x, 0) = g^{(m)}(x)$, and $\partial_x^m \partial_y u(x, 0) = h^{(m)}(x)$. In particular, this gives us G on the right-hand side of (2.9) when $y = 0$. Hence we have found $\partial_{yy} u(x, 0)$, which is $u_2(x)$.

To get $u_k(x)$ for $k \geq 3$, we differentiate the PDE (2.9) with respect to x and y , successively calculating derivatives of higher and higher order in terms of derivatives of the functions a, b, c, f, g, h , and G . For example, to calculate $u_3(x) = \partial_y^3 u(x, 0)$, we differentiate the PDE with respect to y and set $y = 0$. Then

(from the chain rule) the right-hand side has a term with $\partial_y u_{xx}(x, 0)$. But we already know this from (2.6): $\partial_x^m \partial_y u(x, 0) = h^{(m)}(x)$.

2.3.1. Limitations of the Power Series Representation of Functions

To examine the issue of convergence of the series (2.7) to a solution, we focus on some properties of power series. Taylor's Theorem with remainder (in one variable) is the formula

$$f(x) = \sum_{k=0}^N \frac{1}{k!} f^{(k)}(x_0)(x - x_0)^k + \frac{1}{(N+1)!} f^{(N+1)}(\xi)(x - x_0)^{N+1}.$$

A stringent condition (see (2.11)) is needed to be able to pass to the limit $N \rightarrow \infty$ and ensure that the infinite series converges.

Example 3. (A function $\zeta(x)$ that is C^∞ , but the Taylor series for ζ fails to converge to $\zeta(x)$ except at $x = 0$) Let

$$\zeta(x) = \begin{cases} 0 & \text{if } x \leq 0, \\ e^{-\frac{1}{x}} & \text{if } x > 0. \end{cases} \quad (2.10)$$

Note that

$$\zeta^{(k)}(0) = 0, \quad k = 0, 1, 2, \dots,$$

so the power series

$$\sum_{k=0}^{\infty} \frac{1}{k!} \zeta^{(k)}(0)x^k$$

converges to zero for all x , but not to the function $\zeta(x)$, which is nonzero for $x > 0$.

The term *real analytic* is reserved for C^∞ functions with convergent Taylor series: A function $f \in C^\infty(I)$ is called *real analytic* on the interval I if, for every $x_0 \in I$, the power series

$$\sum_{k=0}^{\infty} \frac{1}{k!} f^{(k)}(x_0)(x - x_0)^k$$

converges to $f(x)$ for all x in some neighborhood of x_0 .

Proposition 2.2. Let $f \in C^\infty(I)$. If there exist positive constants C and ϵ such that (for all $x \in I$)

$$\left| \frac{f^{(k)}(x)}{k!} \right| \leq \frac{C}{\epsilon^k}, \quad (2.11)$$

then f is real analytic on I .

This result makes sense if you are familiar with the root test for convergence of series of numbers. The converse of the proposition is true with a restriction: if f is real analytic on I , then the estimate (2.11) is uniform for x (C independent of x) in compact subintervals of I .

We can extend the concept of real analytic to functions of two variables in an open set $\Omega \subset \mathbb{R}^2$, which will be relevant for the theorem below.

Definition. If $u \in C^\infty(\Omega)$, u is real analytic if for every $(x_0, y_0) \in \Omega$, there is a neighborhood $\mathcal{N}_{(x_0, y_0)}$ of (x_0, y_0) such that for all $(x, y) \in \mathcal{N}_{(x_0, y_0)}$, the double series

$$\sum_{j=0}^{\infty} \sum_{k=0}^{\infty} \frac{1}{j!k!} \partial_x^j \partial_y^k u(x_0, y_0) (x - x_0)^j (y - y_0)^k \quad (2.12)$$

converges to $u(x, y)$.

2.3.2. The Cauchy-Kovalevskaya and Holmgren Theorems

These two theorems are part of the classical culture of the study of PDE. The Cauchy-Kovalevskaya Theorem establishes the existence of real analytic solutions of initial value problems for PDE (or systems of PDE) with analytic coefficients. The Holmgren Theorem states that, under the conditions of the Cauchy-Kovalevskaya Theorem, the real analytic solution is the unique C^2 solution locally.

Theorem 2.3. (Cauchy-Kovalevskaya) Suppose that the functions a, b, c in (2.5) are real analytic in $I \times (-\delta, \delta)$, f is real analytic, and g, h are real analytic in I . Assume (as before) that $c(x, 0) \neq 0$ for $x \in I$. Then the series (2.7) converges to a real analytic solution of the initial value problem, for (x, y) in some neighborhood Ω of $I \times \{0\}$.

Remark. The real analytic solution of the theorem is the sum of the series (2.7), but it also has a double series expansion (2.12), since it is real analytic in a two-dimensional open set.

There is only one real analytic solution, since a real analytic function is determined by its derivatives at one point, and by Claim 2.1, these derivatives are uniquely determined. The next result shows that even if the analyticity assumption on solutions is relaxed, the solution is still unique.

Theorem 2.4. (Holmgren) Under the above hypotheses, there is a neighborhood Ω of $I \times \{0\}$ in \mathbb{R}^2 with the property that if $v \in C^2(\Omega)$ satisfies (2.5) and (2.6), then $v(x, y)$ is the solution [Theorem 2.3](#).

These theorems are proved elegantly in the classic text of Garabedian [16].

2.3.3. An Important Cautionary Example

Despite its generality, the Cauchy-Kovalevskaya Theorem is of limited utility in the theory of PDE, because the assumption of real analyticity of the data is too restrictive. For example, we cannot find a power series solution to solve initial value problems with the function (2.10) as initial data, because the function is not real analytic.

However, initial value problems raise other significant issues, connected with Hadamard's notion of a *well-posed* problem, as discussed in Section 2.1. The following classic example illustrates Hadamard ill-posedness for the initial value problem for Laplace's equation:

$$\begin{aligned}\partial_{xx}u + \partial_{yy}u &= 0, \\ u(x, 0) &= e^{-\sqrt{k}} \cos kx, \\ \partial_y u(x, 0) &= 0.\end{aligned}$$

Let $k > 0$ be a parameter that is fixed for now. The parameter k is a spatial frequency, and in this context is referred to as *the wave number*. The corresponding wavelength (of the periodic function $\cos kx$) is $2\pi/k$. The Cauchy-Kovalevskaya Theorem implies there is a unique solution of this initial value problem, and indeed we can find it using the important technique of separation of variables. For each $k > 0$, we have the explicit solution

$$u(x, y) = e^{-\sqrt{k}} \cos kx \cosh ky.$$

Now consider the solutions as $k \rightarrow \infty$. We observe that:

1. The initial condition: $e^{-\sqrt{k}} \cos kx \rightarrow 0$ (along with all x -derivatives).
2. For any $y \neq 0$,

$$\max_x |u(x, y)| = e^{-\sqrt{k}} \cosh ky \rightarrow \infty.$$

These two observations mean that there is not continuous dependence of the solution on the initial data. Moreover, these are the analytic solutions of the Cauchy-Kovalevskaya Theorem, which guarantees a solution even when the initial value problem is not well-posed. It is also interesting to note that the solutions grow exponentially in y for each $k > 0$, and the rate of growth increases exponentially with k . In this sense, the general solution is not just unstable (growing exponentially), but is catastrophically unstable, a manifestation of ill-posedness.

2.4. PDE from Balance Laws

The theory describing the mechanics of continuous materials, such as solids, fluids, and gases, is called *continuum mechanics*. It is based on conservation laws of mass, momentum, and energy. The independent variables are \mathbf{x} , representing a point in the material, and time t . Typical dependent variables are density, velocity, stress, and internal energy. They are defined at each point and at each time in a specified region of space-time.

A *balance law* is an equation expressing a conservation principle; it equates the rate of change of a quantity in a region with the sum of two effects: the rate at which the quantity is entering or leaving through the boundary (the *flux through the boundary*), and the rate at which the quantity is being created or destroyed in the region. The derivation of a PDE from a balance law typically involves the following steps:

1. Write the balance law in an arbitrary bounded region V with smooth boundary ∂V .
2. Use the Divergence Theorem to relate the flux through the boundary ∂V to an integral over V , and deduce that the sum of the integrands in the integrals over V must balance. This gives an equation or a system of equations. However, both the quantity and the flux are unknowns; consequently, there are more variables than equations.
3. Close the system by relating the variables through additional equations (not necessarily PDE) called *constitutive laws*, resulting in the same number of equations as variables.

Let's consider a region $U \subset \mathbb{R}^n$ ($n = 1, 2, \text{ or } 3$, generally), and a quantity (such as mass, momentum, or energy) that is to be conserved, represented by a density function u . That is, the quantity is represented by $u(\mathbf{x}, t)$ measured at each point \mathbf{x} in U at each time t . For example, the material density $u = \rho$ is the density function for mass (since it is the mass per unit volume), $u = \rho v$ is the density function for momentum (where v is a velocity), and the temperature $u = \theta$ is the density function for heat energy.

Let V be an open subset of U , with smooth boundary ∂V having unit outward normal $\mathbf{v} = \mathbf{v}(\mathbf{x})$. The *amount of u in V* is a quantity that depends on time:

$$\mathcal{A}(t) = \int_V u(\mathbf{x}, t) d\mathbf{x}.$$

The time rate of change of \mathcal{A} is then

$$\frac{d\mathcal{A}(t)}{dt} = \frac{d}{dt} \int_V u(\mathbf{x}, t) d\mathbf{x} = \int_V \frac{\partial u}{\partial t}(\mathbf{x}, t) d\mathbf{x}.$$

Suppose the quantity u can flow in or out of V , and can be created or destroyed within V . Then the rate of change of u in V is balanced by the flux of u across the boundary ∂V plus the creation (due to a source) or the destruction (a sink) of u in V .

The net flux through the boundary is represented by an integral $\int_{\partial V} \mathbf{Q}(\mathbf{x}, t) \cdot \mathbf{v} dS$, where the vector-valued function $\mathbf{Q}(\mathbf{x}, t)$, $\mathbf{x} \in U$, is called the *flux function*. Note that $\int_{\partial V} \mathbf{Q}(\mathbf{x}, t) \cdot \mathbf{v} dS > 0$ if \mathbf{Q} points out of V ; this has the effect of decreasing the amount $\mathcal{A}(t)$. The creation or destruction of u in V is likewise specified by a function, this time a scalar function $f(\mathbf{x}, t)$; the net rate of creation/destruction is given by $\int_V f(\mathbf{x}, t) d\mathbf{x}$.

Step 1. Now we can write a balance law:

$$\frac{d\mathcal{A}}{dt} = \int_V \frac{\partial u}{\partial t} d\mathbf{x} = - \int_{\partial V} \mathbf{Q}(\mathbf{x}, t) \cdot \mathbf{v} dS + \int_V f(\mathbf{x}, t) d\mathbf{x}.$$

Step 2. Next we apply the Divergence Theorem to convert the surface integral into a volume integral and combine terms (since they are all integrals over V):

$$\int_V \left(\frac{\partial u}{\partial t} + \operatorname{div} \mathbf{Q} - f \right) d\mathbf{x} = 0, \quad \text{for all } V \subset U. \quad (2.13)$$

If we assume the integrand is continuous, then (2.13) implies that it is zero everywhere in U . Thus, we have the PDE

$$\frac{\partial u}{\partial t} + \operatorname{div} \mathbf{Q} = f.$$

In this equation, we regard $u = u(\mathbf{x}, t)$ as the unknown, but there are additional functions $\mathbf{Q}(\mathbf{x}, t)$ and $f(\mathbf{x}, t)$. These must be determined from additional equations that could specify \mathbf{Q} and f as functions of \mathbf{x} and t . However, \mathbf{Q} in particular is more often related to u and derivatives of u , or to additional dependent variables. This leads to the final step.

Step 3. Specify constitutive laws to close the system, as in the following examples.

Example 4. (Balance laws and the heat and wave equations) The heat and wave equations are examples of PDE derived from balance laws. Conservation of heat energy $e = \rho c u$ relates the temperature $u(\mathbf{x}, t)$ to the heat flux \mathbf{Q} and source terms $F(\mathbf{x}, t)$. Here, the density ρ of the material, and its specific heat c are taken to be constant. The balance law leads to the equation

$$\rho c u_t + \operatorname{div} \mathbf{Q} = F(\mathbf{x}, t). \quad (2.14)$$

Fourier's Law of heat conduction expresses the thermodynamic property that heat energy flows from higher temperatures to lower. Specifically, this constitutive law links the heat flux linearly to the temperature gradient:

$$\mathbf{Q} = -\kappa \nabla u. \quad (2.15)$$

When the thermal conductivity $\kappa > 0$ is constant, we obtain from (2.14) the heat equation with source term f :

$$u_t = k \Delta u + f(\mathbf{x}, t), \quad k = \kappa / \rho c, \quad f = F / \rho c.$$

The same equation also models the diffusion of a solute in solution, with solute concentration u . In this context, the heat equation is called the *diffusion equation*. The proportionality between flux and concentration gradient is then termed *Fick's Law*.

We will derive the one-dimensional wave equation carefully in [Section 4.1](#), but here is the idea of how the wave equation arises from conservation of momentum.

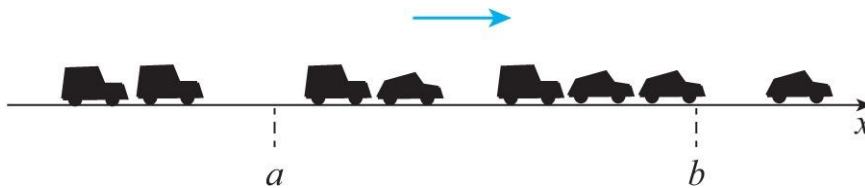

Figure 2.1. Traffic flow: cars traveling on a section of highway.

The balance law equates the rate of change of momentum with the divergence of the momentum flux:

$$\frac{\partial}{\partial t} \rho u_t = -\operatorname{div} \mathbf{Q}.$$

Here $\rho > 0$ is the density, which we take to be constant, and $u_t = \frac{\partial u}{\partial t}$ is a velocity, the time derivative of displacement u . In some applications, such as elasticity, a reasonable constitutive law specifies that the momentum flux is proportional to the gradient of the displacement: $\mathbf{Q} = -k \nabla u$, where $k > 0$ is the constant of proportionality. This leads directly to the wave equation:

$$u_{tt} = c^2 \Delta u,$$

with $c^2 = k/\rho$.

Example5. (Traffic flow) Traffic flow models help to illustrate how the conservation law and constitutive equation are formulated separately. Since these models are one dimensional, the Fundamental Theorem of Calculus replaces the Divergence Theorem in [step 2](#). Consider a single lane highway and let $u(x, t)$ be

the density of cars at location $x \in \mathbb{R}$ on the highway at time t :

$$u(x, t) = \text{number of cars per unit length of highway.}$$

That is, each time t and every point x on the highway is associated with a traffic density $u(x, t)$. Suppose the cars are moving to the right, as shown in [Figure 2.1](#).

To formulate the balance law, we consider the number of cars in a section of highway between fixed locations $x = a$ and $x = b$ at time t :

$$N(t) = \int_a^b u(x, t) dx.$$

The time rate of change of N should be equal to the net rate at which cars enter at $x = a$ and leave from $x = b$. (We assume no cars are manufactured or scrapped in the middle of the highway, so there are no source or sink terms: $f \equiv 0$.) Let $Q(x, t)$ denote the flux of cars past a particular point x at time t :

$$Q(x, t) = \text{number of cars past } x \text{ per unit of time.}$$

Then, since cars enter the section $[a, b]$ at a rate $Q(a, t)$, and leave at the rate $Q(b, t)$, we have

$$\frac{dN}{dt} = \int_a^b \frac{\partial u}{\partial t}(x, t) dx = Q(a, t) - Q(b, t).$$

That is, the rate of change of the number of cars in the region (section of the highway) is balanced by the flux of cars through the boundary.

Now use the Fundamental Theorem of Calculus to obtain

$$\int_a^b \left(\frac{\partial u}{\partial t} + \frac{\partial Q}{\partial x} \right) dx = 0, \quad \text{for all } a < b.$$

If we assume continuity of the integrand, then

$$\frac{\partial u}{\partial t} + \frac{\partial Q}{\partial x} = 0. \tag{2.16}$$

[Equation \(2.16\)](#) has two unknowns, Q and u , and we need an additional equation. In traffic flow models, typically we add a constitutive law that relates the flux Q to the density u . First, it makes sense that Q should be the product of speed and density, the number of cars per unit time across a fixed location:

$$Q = \text{speed} \times \text{density} = v \times u.$$

To complete the description of Q as a function of density alone, we need to specify the speed v as a function of density. We can attempt to fit data from real observations of traffic, or, as is often done when first formulating a mathematical

model, we introduce a functional form that is consistent with natural qualitative or physical properties. In the current context a simple model takes the traffic speed v to be a linear and decreasing function of traffic density:

$$v = v(u) = \beta \left(1 - \frac{u}{\alpha} \right)$$

(see Fig. 2.2). Here the parameters α , β have the interpretation of maximum density and maximum speed. The equation $u_t + Q_x = 0$ is now a single equation for the unknown $u(x, t)$:

$$u_t + \left(\beta u \left(1 - \frac{u}{\alpha} \right) \right)_x = 0. \quad (2.17)$$

Equation (2.17) is known as the Lighthill-Whitham-Richards model. Whitham [46] identifies various scenarios, such as the timing of traffic lights, in which solutions of the equation describe the behavior of traffic. Modeling traffic flow with PDE is of considerable interest, as the equations are easy to work with numerically. However, there are significant challenges in devising realistic models that incorporate important behavior, such as multilane traffic and how traffic divides at intersections or entrances and exits to freeways.

Equation (2.17) is related to the inviscid Burgers equation

$$u_t + \left(\frac{u^2}{2} \right)_x = 0,$$

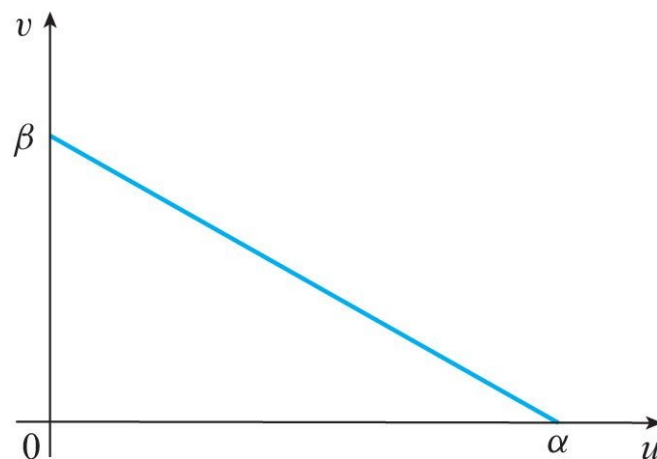

Figure 2.2. Traffic flow: speed v vs. density u .

in that both have a quadratic flux, but the convexity is different. This difference in convexity is relevant when considering blow-up of u_x (i.e., the steepening observed in Fig. 1.2). In traffic flow, in which the flux is convex down, there will be a jam (indicated by blow-up of u_x to infinity—the cars get really scrunched!) if the traffic density u increases ahead (i.e., is an increasing function of x). However, in the inviscid Burgers equation, for which the flux $u^2/2$ is convex up,

we saw in [Section 1.4.2](#) that there is blow-up of u_x (to $-\infty$) when u is a decreasing function of x (see [Fig. 1.2](#)).

PROBLEMS

1. (a) Determine the type of the equation $u_{xx} + u_{xy} + u_x = 0$.
 (b) Determine the type of the equation $u_{xx} + u_{xy} + \alpha u_{yy} + u_x + u = 0$ for each real value of the parameter α .
 (c) Determine the type of the equation $u_{tt} + 2u_{xt} + u_{xx} = 0$. Verify that there are solutions $u(x, t) = f(x - t) + tg(x - t)$ for any twice differentiable functions f, g .
 (d) The equation $(1 + y)u_{xx} - x^2u_{xy} + xu_{yy} = 0$ is hyperbolic or elliptic or parabolic, depending on the location of (x, y) in the plane. Find a formula to describe where in the x - y plane the equation is hyperbolic. Sketch the x - y plane and label where the equation is hyperbolic, where it is elliptic, and where it is parabolic.
2. Show that with the change of variables $\mathbf{y} = B\mathbf{x}$, the principal symbol of (2.4) corresponding to (2.3) has coefficients c_{ij} given by $C = BAB^T$, where $C = (c_{ij})$. One approach to this is to write everything in coordinate form, such as $y_k = (B\mathbf{x})_k = \sum_{m=1}^n B_{km}x_m$, $BA = (ba_{kj})$, $ba_{kj} = \sum_{i=1}^n B_{ki}a_{ij}$, and use the chain rule to convert x_j derivatives to sums of y_k derivatives.
3. For the series (2.7), write formulas for $u_3(x)$ and $u_4(x)$ in terms of derivatives of the functions a, b, c, f, g, h , and G .
4. Show that $\zeta \in C^\infty(\mathbb{R})$, where ζ is given by (2.10).
5. Find the dispersion relation $\sigma = \sigma(\xi)$ for the following dispersive equations.
 - (a) The beam equation $u_{tt} = -u_{xxxx}$. Why is the equation dispersive and not dissipative? What makes this equation dispersive, whereas the wave equation is not dispersive?
 - (b) The linear Benjamin-Bona-Mahoney (BBM) equation $u_t + cu_x + \beta u_{xxt} = 0$. Deduce that the equation is dispersive, and show that the corresponding solutions $u = e^{i\xi x + \sigma(\xi)t}$ are traveling waves. Write a formula for their speed as a function of wave number ξ . Identify a significant difference between this formula and the wave speeds of KdV traveling waves.
6. Suppose in the traffic flow model discussed in [Section 2.4](#) that the speed v of cars is taken to be a positive monotonic differentiable function of density:
 $v = v(u)$.

(a) Should v be increasing or decreasing?

(b) How would you characterize the maximum velocity v_{\max} and the maximum density u_{\max} ?

(c) Let $Q(u) = uv(u)$. Prove that Q has a maximum at some density u^* in the interval $(0, u_{\max})$.

(d) Can there be two local maxima of the flux? (Hint: Make $Q(u)$ quartic.)

1. Jacques S. Hadamard (1865–1963) is well known for contributions to number theory, matrices, differential equations, geometry, elasticity, geometrical optics, and hydrodynamics. His papers of 1901 and 1902 discuss ill-posed and well-posed problems, respectively.

2. Augustin-Louis Cauchy (1789–1857) made many contributions to mathematics, including fundamental developments in real and complex analysis, modern algebra, and the theory of elasticity. Sofia Vasilyevna Kovalevskaya (1850–1891) made important contributions to analysis, differential equations, and mechanics.

3. Since we shall be discussing solutions only locally in (x, y) we could simply assume $c(0, 0) \neq 0$.

First-Order PDE

First-order equations enjoy a special place in theory of PDE, as they can generally be solved explicitly using the method of characteristics. Although this method applies more generally to fully nonlinear equations, such as Hamilton-Jacobi equations, we will restrict attention to linear and quasilinear equations, in which the first-order derivatives of the dependent variable u occur linearly, with coefficients that may depend on u . The method of characteristics reduces the determination of explicit solutions to solving ODE. We develop the theory in several stages, with increasing sophistication, but really the idea is the same all along: first-order PDE become ODE when the PDE are regarded as specifying directional derivatives in several dimensions.

3.1. The Method of Characteristics for Initial Value Problems

Initial value problems in one space variable x and time t take the form

$$u_t + c(x, t, u)u_x = r(x, t, u), \quad t > 0, \quad u(x, 0) = f(x). \quad (3.1)$$

Let's assume that c and r are given C^1 (continuously differentiable) functions, and the initial condition $f: \mathbb{R} \rightarrow \mathbb{R}$ is a given C^1 function. The coefficient c will be established as a wave speed, and the notation r simply stands for the right-hand side of the PDE.

We can solve (3.1) at least for a short time interval (and perhaps only locally in space) using the *method of characteristics*, which reduces the initial value problem (3.1) to an initial value problem for a system of ODE. In this method, we depend on the observation that if $\{(x(t), t) : t \geq 0\}$ is a smooth curve, then along the curve, $u(x(t), t)$ has rate of change

$$\frac{d}{dt}u(x(t), t) = u_t + \frac{dx}{dt}u_x, \quad (3.2)$$

given by the chain rule. Comparing (3.2) with the PDE in (3.1), it looks as though we can make progress by setting $\frac{dx}{dt} = c$ and interpreting c as a speed. The left-hand side of the PDE can also be interpreted as the derivative of $u(x, t)$, in the direction $(c, 1)$ in x - t space.¹

Now the PDE (3.1) can be replaced by the ODE system

$$\frac{dx}{dt} = c, \quad \frac{du}{dt} = r. \quad (3.3)$$

These ODE are called *the characteristic equations*. Note that the characteristic

equations are autonomous only if c and r are independent of t .

Initial conditions for the ODE system are derived from the initial condition $u(x, 0) = f(x)$ for the PDE problem (3.1). To see what the ODE initial conditions should be, let's write $x(0) = x_0$, and $u(t)$ in place of $u(x(t), t)$. Then the initial conditions for (3.3) are

$$x(0) = x_0; \quad u(0) = f(x_0). \quad (3.4)$$

From the theory of ODE, we know that the initial value problem (3.3), (3.4) has a unique solution $(x(t), u(t))$, at least locally in time for each x_0 . To emphasize that we have a solution for each x_0 , let's write the solution as $x = \hat{x}(t; x_0), u = \hat{u}(t; x_0)$. The semicolon indicates that x_0 is regarded as a parameter in the ODE initial value problem, but now we are going to treat x_0 as a second variable, so that x and u are functions of the two variables t, x_0 .

The parameter x_0 specifies the curve in the x - t plane $\mathcal{C}(x_0) : x = \hat{x}(t, x_0)$, which we refer to as the characteristic through $x = x_0, t = 0$. As long as curves with different values of x_0 do not cross, the family of characteristics fills a region of the upper half-plane $\{(x, t) : t \geq 0\}$, thereby parameterizing points in the region with x_0, t . At each point $P : (x, t)$ of this region, we know the solution u , since $u = \hat{u}(t; x_0)$ on each characteristic. Figure 3.1 illustrates the characteristic originating at x_0 that passes through point P . Once we have identified the value of x_0 , then $u(x, t) = \hat{u}(t; x_0)$.

There is a nice physical interpretation of this construction. The parameter x_0 , called the *Lagrangian variable*, labels a material point. Then $x = \hat{x}(t; x_0)$ is the *Eulerian variable* describing the location at time t of that material point. The value u of the variable can be thought of either in Lagrangian variables, for which $u = \hat{u}(t; x_0)$, or in Eulerian variables, for which u is observed at a fixed location: $u = u(x, t)$, the solution we seek.

Mathematically, to get the solution u explicitly at each point (x, t) , we need to invert the change of variables $(x, t) = (\hat{x}(t, x_0), t)$. To do so, we eliminate x_0 and write $x_0 = \tilde{x}_0(x, t)$ as the solution of the equation $x = \hat{x}(t; x_0)$. Then $u(x, t) = \hat{u}(t; \tilde{x}_0(x, t))$ is the solution of (3.1).

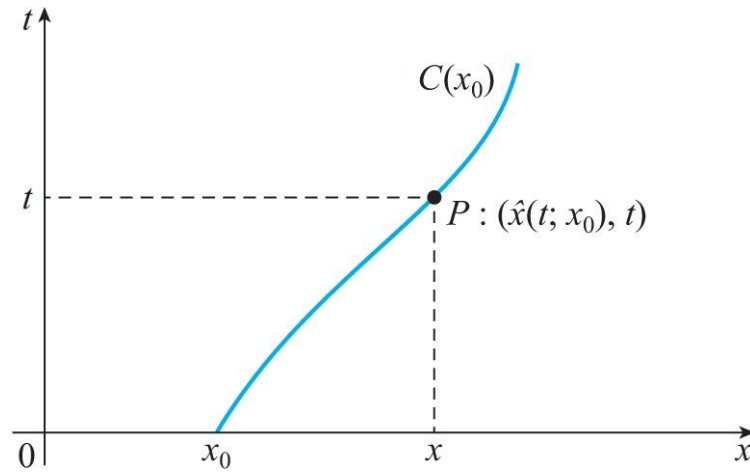

Figure 3.1. Characteristic $C(x_0) = \{(\hat{x}(t; x_0), t) : t \geq 0\}$, along which $u = \hat{u}(t; x_0)$, for the initial value problem (3.1).

For this kind of initial value problem, the method of characteristics is summarized as:

1. Rewrite the initial value problem (3.1) as a system of ODE consisting of the characteristic equations (3.3) with initial conditions (3.4).
2. Solve the ODE and initial conditions for $x(t)$, $u(t)$, with parameter $x_0 = x(0)$ to get the solution along each characteristic.
3. Solve for x_0 as a function of x , t . This effectively changes variables from t , x_0 to x , t .
4. Write the solution $u = u(x, t)$.

Example 1. (Initial value problem) Solve

$$u_x + u_y = u, \quad u(x, 0) = \cos x. \quad (3.5)$$

In this example, y is time-like in the sense that the initial condition is posed at $y = 0$. The PDE written as $\nabla u \cdot (1, 1) = u$ shows that the left-hand side is the directional derivative of u in the direction $(1, 1)$. Consider the lines $x = y + k$ parallel to $(1, 1)$, where the parameter k plays the same role as x_0 above. The rate of change of u along each line is

$$\frac{d}{dy}u(y + k, y) = \frac{\partial u}{\partial x} \cdot 1 + \frac{\partial u}{\partial y} = u.$$

Therefore,

$$u(y + k, y) = A(k)e^y,$$

where $A(k)$ is an arbitrary function. Thus, since $k = x - y$,

$$u(x, y) = A(x - y)e^y \quad (3.6)$$

is the general solution of the PDE, depending on the arbitrary function $A(k)$ of a

single variable.

To complete the solution, we use the initial condition to determine $A(k)$. Setting $y = 0$ in (3.6) gives

$$u(x, 0) = A(x) = \cos x.$$

Thus, the solution of the problem is

$$u(x, y) = \cos(x - y)e^y.$$

Since the left-hand side of (3.5) is a directional derivative, it is an ordinary derivative in that direction. Thus, $u' = u$ in this direction, explaining the exponential growth of the solution along each characteristic $x = y + k$. Likewise, the solution would be $u(x, y) = \cos(x - y)$ if the right-hand side of the PDE were zero.

In this example, we found the characteristics before determining the behavior of u along them. Generally, the characteristics for (3.1) will also depend on the solution, if c depends on u .

3.2. The Method of Characteristics for Cauchy Problems in Two Variables

In this section we present a more general version of the method of characteristics for first-order quasilinear PDE in two independent variables. First-order quasilinear PDE in two independent variables take the form

$$a(x, y, u)u_x + b(x, y, u)u_y = c(x, y, u), \quad (3.7)$$

where a, b, c are given C^1 functions from $\mathbb{R}^2 \times \mathbb{R}$ to \mathbb{R} . In this equation, neither of the variables necessarily has a special role, such as time. Consequently, the notation is somewhat different from the previous section.

Rather than posing an initial condition, we pose a more general side condition for (3.7) in the form

$$u = z_0(s) \quad \text{on the curve} \quad \gamma : x = x_0(s), y = y_0(s), \quad (3.8)$$

where x_0, y_0, z_0 are given C^1 functions on an interval I . This is sometimes referred to as the *initial curve* Γ . Problem (3.7), (3.8) is referred to as the *Cauchy problem*.

We shall show that for C^1 solutions, the PDE is really an ODE in disguise (as we saw in Example 1). Suppose $u(x, y)$ is a solution of the Cauchy problem. Then the graph $z = u(x, y)$ is a two-dimensional surface in x - y - z space that includes the curve Γ . Equation (3.7) states that the vector field $(a(x, y, z), b(x, y, z), c(x, y, z))$ is tangent to the solution surface $z = u(x, y)$, since the solution surface has normal

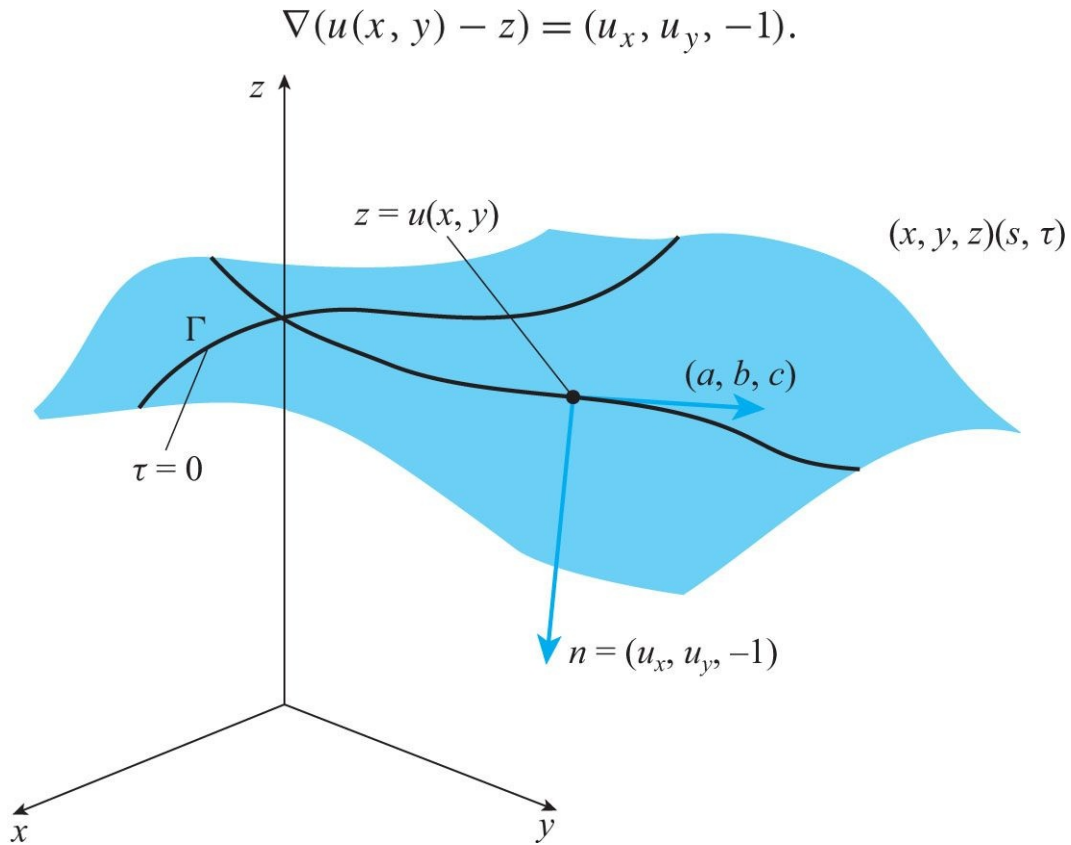

Figure 3.2. Initial curve Γ , the characteristic curve tangent to (a, b, c) , and the solution surface.

The solution surface can therefore be generated by integrating along the vector field, starting at each point of the curve $\Gamma = \{(x, y, z) : x = x_0(s) \dots, s \in I\}$. (See [Fig. 3.2.](#)) If τ is the variable of integration along these integral curves, then the surface generated is parameterized by $(s, \tau) : x = x(s, \tau), y = y(s, \tau), z = z(s, \tau)$. To recover $u(x, y)$, we transform from (s, τ) back to (x, y) in z and set $u(x, y) = z(s, \tau)$, establishing the existence of the inverse using the Inverse Function Theorem (see [Appendix A](#)).

This procedure to solve the Cauchy problem (3.7), (3.8) is divided into three steps:

1. *Generate the solution surface from integral curves.* In this step we solve the one-parameter family of initial value problems

$$\begin{aligned} \frac{dx}{d\tau} &= a(x, y, z), & \frac{dy}{d\tau} &= b(x, y, z), & \frac{dz}{d\tau} &= c(x, y, z), \\ x(0) &= x_0(s), & y(0) &= y_0(s), & z(0) &= z_0(s), \end{aligned} \quad (3.9)$$

for each $s \in I$. Denote the solution $(x, y, z)(s, \tau)$. From ODE theory, the solution exists, is C^1 , and is unique, at least in a neighborhood of Γ . The solution curves in \mathbb{R}^3 are known as *characteristic curves*. We reserve the term *characteristics* to mean the projection of the characteristic curves onto the x - y

plane.

2. *Apply the Inverse Function Theorem.* In this step we solve the equations

$$\begin{aligned}x &= x(s, \tau), \\y &= y(s, \tau)\end{aligned}\tag{3.10}$$

for (s, τ) as a function of $(x, y) : (s, \tau) = (s, \tau)(x, y)$. The solution is guaranteed by the Inverse Function Theorem.

3. *Write the solution surface as a graph $z = u(x, y)$.*

Now we are able to write the solution as a function of x, y :

$$u(x, y) = z(s(x, y), \tau(x, y)).$$

This procedure will work as long as the transformation (3.10) is invertible. We can guarantee this locally by appealing to the Inverse Function Theorem. Specifically, let $P = (x_0(s_0), y_0(s_0), z_0(s_0))$ be a point on Γ . For (3.10) to be invertible near $(x, y) = (x_0(s_0), y_0(s_0))$, we require the Jacobian matrix $\partial(x, y)/\partial(s, \tau)$ to be invertible at this point. That is, at P we require

$$\left| \frac{\partial(x, y)}{\partial(s, \tau)} \right| = \begin{vmatrix} \frac{\partial x}{\partial s} & \frac{\partial y}{\partial s} \\ \frac{\partial x}{\partial \tau} & \frac{\partial y}{\partial \tau} \end{vmatrix} = \begin{vmatrix} x'_0(s_0) & y'_0(s_0) \\ a(P) & b(P) \end{vmatrix} \neq 0,\tag{3.11}$$

where we have used (3.8), (3.9). This condition means that the tangent (a, b) to the characteristic at $(x_0(s_0), y_0(s_0))$ is not parallel to the tangent $(x'_0(s_0), y'_0(s_0))$ of the projection γ of Γ at P onto the x - y plane. Consequently, when (3.11) holds, we say that the curve Γ is *noncharacteristic* at P . Thus, provided the initial data are noncharacteristic in the sense of (3.11), we have a unique C^1 solution $u(x, y)$ of (3.7), (3.8) for (x, y) near $(x_0(s_0), y_0(s_0))$.

Example 2. (A Cauchy problem) Solve the Cauchy problem

$$uu_x + u_y = 1, \quad u(x, x) = 0.$$

Here $a = z, b = 1, c = 1$, and the initial condition is $u = 0$ on the line $y = x$. We parameterize the initial condition as follows:

$$x_0(s) = s \quad y_0(s) = s \quad z_0(s) = 0.$$

Characteristic equations are

$$x' = z, \quad y' = 1, \quad z' = 1,$$

with corresponding initial conditions $x(0) = s, y(0) = s, z(0) = 0$. Thus, $z = \tau$, so that $x' = z = \tau$. Now we can solve for x and y :

$$x = \frac{\tau^2}{2} + s, \quad y = \tau + s.$$

Eliminating s , we get a quadratic equation for $\tau: x - y = \frac{\tau^2}{2} - \tau$. Thus,

$$\tau = 1 \pm \sqrt{1 + 2x - 2y}.$$

But $\tau = z = u(x, y)$, and to satisfy the initial condition, we have to take the negative square root:

$$u(x, y) = 1 - \sqrt{1 + 2x - 2y}.$$

The solution is valid only for $2y - 2x < 1$ (i.e., $y < x + \frac{1}{2}$). In fact, the solution surface $z = u(x, y)$ is the lower half of the smooth parabolic surface $(z - 1)^2 = 1 + 2x - 2y$, which has a fold along the line $y = x + \frac{1}{2}, z = 1$. Since the surface becomes vertical at the fold, the solution $u(x, y)$ has a singularity on the line $y = x + \frac{1}{2}$, where the derivative $u_x - u_y$ blows up.

3.3. The Method of Characteristics in \mathbb{R}^n

In this section we repeat the method of characteristics for a single quasilinear first-order equation to show how the method works for any number of independent variables. Characteristic curves are of course one dimensional, and thus contribute one dimension to the solution surface, which is $n - 1$ dimensional. The remaining dimensions in the surface are provided by the initial conditions.

Consider $\mathbf{x} \in \mathbb{R}^n; u = u(\mathbf{x}) \in \mathbb{R}$. The first-order equation we consider has the general form

$$\mathbf{a}(\mathbf{x}, u) \cdot \nabla u = c(\mathbf{x}, u), \quad (3.12)$$

where $\mathbf{a} : \mathbb{R}^n \times \mathbb{R} \rightarrow \mathbb{R}^n$, a vector of coefficients, and $c : \mathbb{R}^n \times \mathbb{R} \rightarrow \mathbb{R}$, a scalar, are given C^1 functions.

The Cauchy problem involves an $(n - 1)$ -dimensional hypersurface $\gamma \subset \mathbb{R}^n$ that provides initial conditions for characteristic curves:

$$\mathbf{x} = \mathbf{x}_0(\mathbf{s}), \quad u = u_0(\mathbf{s}), \quad \mathbf{s} \in \mathbb{R}^{n-1}. \quad (3.13)$$

Characteristic curves in (\mathbf{x}, z) space (\mathbb{R}^{n+1}) are solution curves of the system

$$\frac{d\mathbf{x}}{d\tau} = \mathbf{a}(\mathbf{x}, z), \quad \frac{dz}{d\tau} = c(\mathbf{x}, z), \quad (3.14)$$

$$\mathbf{x}(0) = \mathbf{x}_0(\mathbf{s}), \quad z(0) = u_0(\mathbf{s}) \quad \text{for each } \mathbf{s}.$$

Note that for each \mathbf{s} , we have existence and uniqueness of solutions of (3.14) for |

τ small, since \mathbf{a} and c are C^1 . Moreover, since the data are C^1 , the solutions are C^1 in \mathbf{s} also.

As before, we write the solutions in the form

$$\mathbf{x} = \mathbf{x}(\mathbf{s}, \tau), \quad (3.15a)$$

$$z = z(\mathbf{s}, \tau). \quad (3.15b)$$

The solution $u(\mathbf{x}) = z(\mathbf{s}, \tau)$ is expressed in physical variables \mathbf{x} if we can invert (3.15a) to get $\mathbf{s} = \mathbf{s}(\mathbf{x})$, $\tau = \tau(\mathbf{x})$. This is guaranteed by the Inverse Function Theorem, at least locally, if we assume the hypersurface is noncharacteristic, i.e., $\partial\mathbf{x}/\partial(\mathbf{s}, \tau)$ is invertible on γ (where $\tau = 0$), with $z = u_0(\mathbf{s})$, and recall that $\partial\mathbf{x}/\partial\tau = \mathbf{a}$:

$$\det \left[\frac{\partial\mathbf{x}_0(\mathbf{s})}{\partial\mathbf{s}}, \mathbf{a}(\mathbf{x}_0(\mathbf{s}), u_0(\mathbf{s})) \right] \neq 0. \quad (3.16)$$

In components:

$$\mathbf{x}_0 = (x_0^1(s_1, \dots, s_{n-1}), \dots, x_0^n(s_1, \dots, s_{n-1}))^T$$

$$\mathbf{a} = (a^1, \dots, a^n)^T$$

$$\frac{\partial\mathbf{x}_0}{\partial\mathbf{s}} = \begin{pmatrix} \frac{\partial x_0^1}{\partial s_1} & \dots & \frac{\partial x_0^1}{\partial s_{n-1}} \\ \frac{\partial x_0^2}{\partial s_1} & & \vdots \\ \vdots & & \vdots \\ \frac{\partial x_0^n}{\partial s_1} & \dots & \frac{\partial x_0^n}{\partial s_{n-1}} \end{pmatrix}.$$

Then we have the solution

$$u(\mathbf{x}) = z(\mathbf{s}(\mathbf{x}), \tau(\mathbf{x})).$$

More precisely, the method of characteristics and the Inverse Function Theorem have been used to prove the following result.

Theorem 3.1. *Suppose the data \mathbf{x}_0, u_0 are C^1 in a neighborhood of $\mathbf{s} = 0$ and are noncharacteristic in the sense of (3.16) at $\mathbf{s} = 0$. Then there exists a neighborhood N of $\mathbf{x}_0(0)$ and a C^1 function $u : N \rightarrow \mathbb{R}$ that solves the Cauchy problem (3.12), (3.13) in N .*

Example 3. (Particle size segregation in an avalanche) Avalanches and rock slides are examples of granular flow, typically involving particles of different sizes. In this example, we write a PDE for the transport of two sizes of particles (a

bidisperse mixture) that have the same density. We assume that as the avalanche flows down the hillside, it establishes a constant depth, and that the velocity varies linearly with depth. We ignore all but the component of velocity that is parallel to the hillside. In these circumstances, Gray and Thornton [20] formulated a model that describes the distribution of particles in the avalanche.

Let x, y denote the spatial variables, and let $v(y) = y$ denote the parallel velocity. These are shown in Figure 3.3. The dependent variable $u = u(x, y, t)$ is the volume fraction of small particles. In the flow, large particles tend to rise, and small particles tend to fall. Gray and Thornton argued that small particles fall at a speed proportional to the volume fraction $1 - u$ of large particles, essentially because they depend on space opened up by the motion of large particles. Then large particles have to move upward to balance the motion of the small particles. With these assumptions, the PDE is

$$u_t + yu_x + S(u(u - 1))_y = 0, \quad (3.17)$$

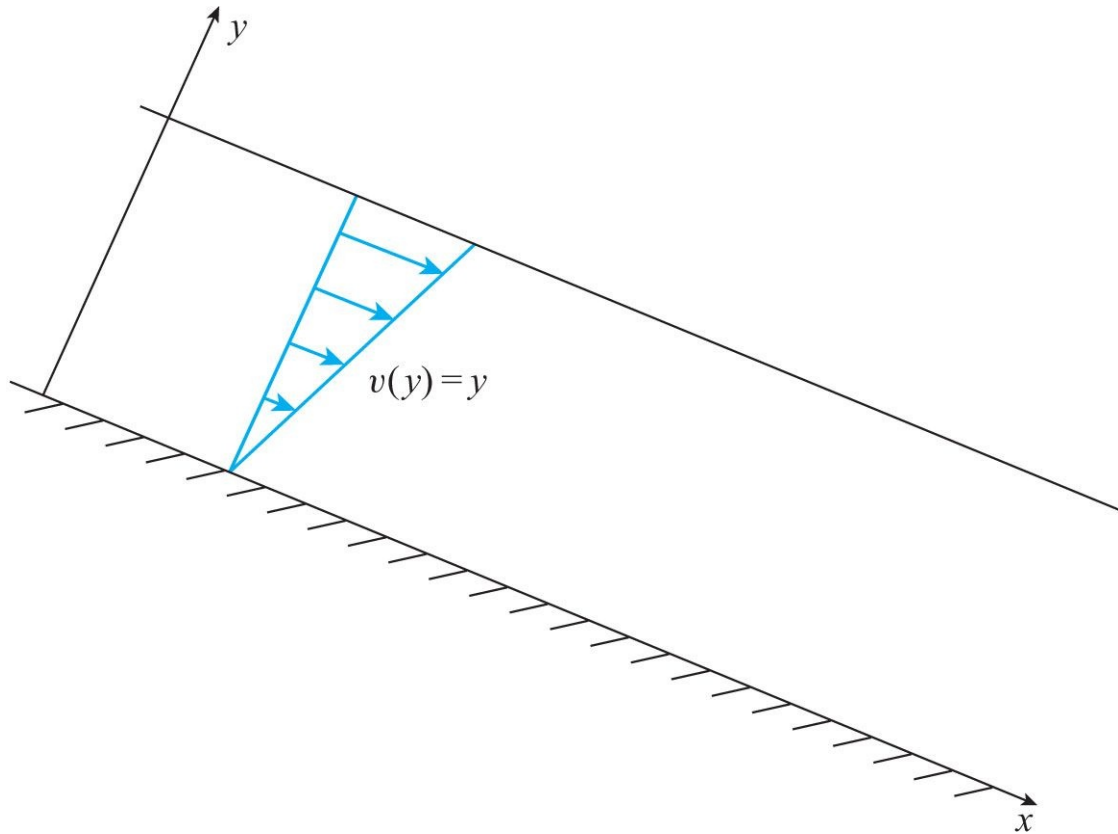

Figure 3.3. Coordinates and velocity profile $v(y)$ for avalanche flow model.

where $S > 0$ is a constant of proportionality. Let's suppose there is an initial distribution of small particles given by

$$u(x, y, 0) = u_0(x, y). \quad (3.18)$$

Characteristic equations for this equation can be written

$$\frac{dx}{dt} = y, \quad \frac{dy}{dt} = S(2u - 1), \quad \frac{du}{dt} = 0. \quad (3.19)$$

Thus, $u = u_0(x_0, y_0)$ is constant on the characteristic curve through (x_0, y_0) at $t = 0$. Consequently,

$$y = S(2u - 1)t + k, \quad x = \frac{1}{2}S(2u - 1)t^2 + kt + c, \quad u = u_0(x_0, y_0).$$

At $t = 0$, we have $x = x_0, y = y_0$, so that

$$y = S(2u - 1)t + y_0, \quad x = \frac{1}{2}S(2u - 1)t^2 + y_0t + x_0.$$

Thus, characteristics are parabolas in the x - t plane. Now we solve for x_0, y_0 in terms of u, x, y, t :

$$y_0 = y - S(2u - 1)t, \quad x_0 = x + \frac{1}{2}S(2u - 1)t^2 - yt.$$

Finally, we have a formula for the solution $u = u(x, y, t)$, defined implicitly by the equation

$$u = u_0 \left(x + \frac{1}{2}S(2u - 1)t^2 - yt, y - S(2u - 1)t \right). \quad (3.20)$$

This solution technique can be used to study the dynamics of avalanche flow with various initial and boundary conditions.

3.4. Scalar Conservation Laws and the Formation of Shocks

In this section we consider the initial value problem for the inviscid Burgers equation. We show that solutions generated by the method of characteristics typically break down in finite time. This nonlinear wave behavior occurs in such applications as gas dynamics, combustion and detonation, and nonlinear elasticity. The breakdown of solutions signals the formation of a shock wave, across which the solution is discontinuous.

Consider the initial value problem

$$u_t + uu_x = 0, \quad -\infty < x < \infty, \quad t > 0, \quad (3.21)$$

with initial condition

$$u(x, 0) = u_0(x), \quad -\infty < x < \infty. \quad (3.22)$$

The method of characteristics of [Section 3.1](#) is applicable here:

$$\frac{dx}{dt} = u, \quad \frac{du}{dt} = 0.$$

Thus, u is constant on each characteristic, and characteristics are therefore straight lines with speed u :

$$x = ut + x_0, \quad u = \text{constant} = u_0(x_0).$$

The solution $u = u(x, t)$ is then given implicitly by the equation

$$u = u_0(x - ut). \quad (3.23)$$

Let $F(u, x, t) = u - u_0(x - ut)$. Generally, we cannot solve for u explicitly, but we can use the equation to prove local existence near any initial point $x = x_0$, by applying the Implicit Function Theorem to the equation $F(u, x, t) = 0$. (See [problem 11](#).)

3.4.1. Breakdown of Smooth Solutions

As we saw in [Section 1.4.2](#), the graph of the solution $u(x, t)$ steepens where it has negative slope, because larger positive values of u travel faster than smaller values. For negative values of u , the characteristics travel to the left, but the same is true: the graph steepens where the slope is negative. Mathematically, we find $u_x \rightarrow -\infty$ at some x as t increases to a time t^* . The notion that some values of u travel faster than others, leading to steepening, may be expressed in the following statement:

Characteristics $x = ut + x_0$ that originate at points x_0 in an interval where $u'_0(x_0) < 0$ cross one another in finite time.

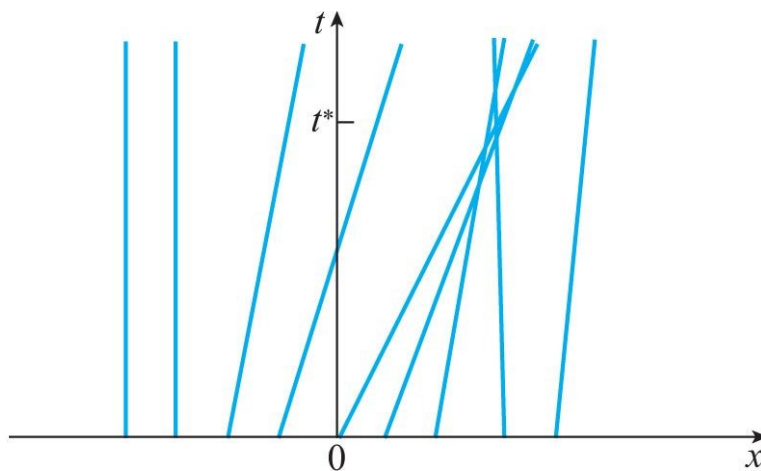

Figure 3.4. Inviscid Burgers' equation: crossing characteristics associated with the breakdown of a smooth solution.

In [Figure 3.4](#) we show the characteristics for the solution shown in [Figure 1.2](#) and see that characteristics ahead of the crest of the wave eventually cross one another. If this first occurs at a time $t = t^*$, then the method of characteristics gives a multivalued function of (x, t) , for $t > t^*$ in the region where the characteristics cross. We say the solution *breaks down* at $t = t^*$.

Our goal is to make this argument rigorous and to find a formula for the breakdown time t^* . To do so, we derive an equation for u_x by taking $\frac{\partial}{\partial x}$ of the PDE, thus deriving an ODE for the evolution of u_x along characteristics. First we

differentiate (3.21):

$$\frac{\partial}{\partial x}(u_t + uu_x) = u_{xt} + u_x^2 + uu_{xx} = 0.$$

Let $v = u_x$. Then we have

$$v_t + uv_x = -v^2.$$

Along characteristics $x = ut + x_0$ we get the ODE

$$\frac{dv}{dt} = -v^2. \quad (3.24)$$

This equation (known as a *Riccati equation* due to the quadratic nonlinearity) is solved easily. Notice that it states that v decreases in t , and the more it decreases through negative values, the more rapidly it continues to decrease.

Now we differentiate the initial condition $u(x, 0) = u_0(x)$ to obtain a corresponding initial condition for v :

$$v(0) = u'_0(x_0). \quad (3.25)$$

We solve (3.24), (3.25) to find v along the characteristic $x = ut + x_0$:

$$v = \frac{u'_0(x_0)}{1 + u'_0(x_0)t}. \quad (3.26)$$

We distinguish two cases:

1. If $u'_0(x_0) > 0$, then v stays finite for all $t > 0$. Consequently, if u_0 is monotonically increasing, then $u(x, t)$ is defined for all x, t . Note from (3.23) that $u(x, t)$ only takes on values of $u_0(x_0)$, $x_0 \in \mathbb{R}$. Therefore, if u_0 is bounded by m, M , $m \leq u_0(x) \leq M$, $x \in \mathbb{R}$, then $m \leq u(x, t) \leq M$ for all $x \in \mathbb{R}$, $t > 0$.
2. If u_0 is not monotonically increasing, so that $u'_0(x_0) < 0$ for some values of x_0 , then

$$v \rightarrow -\infty \quad \text{as } t \rightarrow -\frac{1}{u'_0(x_0)} > 0$$

in (3.26). Thus, the solution breaks down ($u_x \rightarrow -\infty$) at different times t on each characteristic (depending on x_0). Consequently, the solution $u(x, t)$ of the initial value problem breaks down at the earliest such time $t = t^*$:

$$t^* = \min_{-\infty < x < \infty} \left\{ -\frac{1}{u'_0(x)} : u'_0(x) < 0 \right\} = -\frac{1}{\min_x u'_0(x)}.$$

Note that the minimum is achieved where u_0 has minimum slope, which will

be at an inflection point if u_0 is C^2 .

To continue the solution beyond $t = t^*$, we define *weak solutions*, in which the function $u(x, t)$ is allowed to be discontinuous. We pursue this topic in [Chapter 13](#), after first considering solution and analysis techniques for second-order equations.

PROBLEMS

1. Use the substitution $v = u_y$ to solve for $u = u(x, y)$:

$$u_{xy} = 5u_y, \quad u(x, x) = 0, \quad u_y(x, x) = 2.$$

2. Solve for $u = u(x, t)$:

$$(1 + t^2)u_t + u_x = 0, \quad u(x, 0) = \sin x.$$

3. Solve for $u = u(x, t)$:

$$u_t + u_x + 3u = e^{2x+t}, \quad u(x, 0) = x.$$

4. Solve (3.5) using the general method of characteristics. You will need to set up the initial condition with a parameter s . Show that the initial curve Γ is noncharacteristic.

5. Verify that $u(x, t)$ constructed in general in [Section 3.1](#) is indeed a solution of (3.1). Start by working out what calculation you have to do to carry out this check. You will have to use the chain rule repeatedly to check carefully.

6. Take an alternative direct approach to [Example 1](#), reversing the roles of x and y , by setting $y = x + k$. The PDE then becomes the ODE $\frac{d}{dx}u(x, x+k) = u$ along characteristics. Solve and incorporate the initial condition, finally obtaining the solution $u(x, y)$.

7. For the avalanche flow [equation \(3.17\)](#), suppose an initial distribution of particles is given by

$$u(x, y, 0) = u_0(x, y) = x + y, \quad 0 < x, \quad 0 < y < 1,$$

and an inlet boundary condition is specified by

$$u(0, y, t) = y, \quad 0 < y < 1, \quad t > 0.$$

Find the solution $u(x, y, t)$, $0 < x$, $0 < y < 1$, $t > 0$ by the method of characteristics. (The side conditions and hence the solution do not obey the physical constraint $0 \leq u \leq 1$, and hence are not intended to be physically significant. This problem is an exercise in using the method of characteristics.)

8. (a) Use the method of characteristics to solve the initial value problem

$$u_t + tu_x = u^2, \quad -\infty < x < \infty, \quad 0 < t < 1,$$

$$u(x, 0) = \frac{1}{1 + x^2}, \quad -\infty < x < \infty.$$

(b) Show that the solution blows up as $t \rightarrow 1$:

$$\lim_{t \rightarrow 1^-} \max_x u(x, t) = \infty.$$

9. Sketch the graph of the traffic flow flux Q (see (2.16), (2.17) in Chapter 2) as a function of density u . Explain each zero of Q in terms of the physical model.

10. Formulate constitutive laws for the traffic flux Q (see Example 2 in Chapter 2) as a function of density assuming that traffic speed $v(\rho)$ is a quadratic decreasing function of density ρ . How many parameters are there in the model? Is it possible to make the flux nonconcave as a function of density?

11. Write the details of how to use the Implicit Function Theorem on (3.23) to prove: If u_0 is smooth and bounded on $(-\infty, \infty)$ then for each $x_0 \in \mathbb{R}$, there is an interval $I \subset \mathbb{R}$ containing x_0 such that the solution $u(x, t)$ exists, is C^1 , and is unique for all $x \in I$ and all small enough t .

12. Let $u_0(x) = H(x)x^2$, where $H(x) = 0$ for $x < 0$ and $H(x) = 1$ for $x \geq 0$ is the Heaviside function. Write the solution $u(x, t)$ of (3.21), (3.22) as an explicit formula for $t > 0$.

13. Get the answer (3.26) by differentiating the implicit solution (3.23):

$$\frac{\partial}{\partial x} (u = u_0(x - ut)), \quad \text{with } u = u(x, t).$$

(This simpler approach depends on having the implicit equation for u available, which is not the case for systems of equations.)

14. Use the method of characteristics to prove global (for all $t > 0$) existence of a smooth solution of (3.21), (3.22) when the initial data are given by a strictly increasing but bounded C^1 function u_0 .

15. Carry through the analysis presented in Section 3.4 for a general scalar conservation law

$$u_t + f(u)_x = 0,$$

where $f : \mathbb{R} \rightarrow \mathbb{R}$ is a given C^2 function. Derive an implicit equation for the solution $u(x, t)$ of the Cauchy problem, and formulate a condition for the solution to remain smooth for all time. Likewise, if the condition is violated, find an expression for the time at which the solution first breaks down.

1. Strictly speaking, the direction is $(c, 1)/\sqrt{1+c^2}$; the magnitude $\sqrt{1+c^2}$ sets the parameterization to be by t rather than by arclength.

The Wave Equation

The wave equation

$$u_{tt} = c^2 \Delta u$$

is the prototype for second-order hyperbolic PDE, modeling the propagation of sound waves; electromagnetic waves, such as light; and waves in elastic solids. We show in detail how the wave equation describes the deformation of one-dimensional elastic solids, specifically, thin rods and elastic strings.

Central to the study of the one-dimensional equation is d'Alembert's solution, an explicit formula for solutions of initial value problems. The method of spherical means provides a corresponding explicit formula in two and three dimensions. In three dimensions, this formula embodies Huygens' principle of light propagation. From the wave equation we derive an energy principle in which the total energy (the sum of kinetic and potential energy) is conserved.

4.1. The Wave Equation in Elasticity

We introduce the wave equation with a simple derivation from one-dimensional elasticity theory. The derivation illustrates the basic notions of conservation laws and constitutive equations introduced in [Chapter 2](#). Then we discuss a second application, to an elastic string vibrating in a plane. Conservation of momentum leads to a system of nonlinear PDE. Considering small-amplitude vibrations near a stationary string, we linearize the equations, thereby deriving two wave equations with different wave speeds. One equation represents longitudinal motion along the string, and the other represents transverse motion—the vibrations seen in a guitar or violin string.

4.1.1. Longitudinal Motion of a Thin Elastic Rod

Consider a thin elastic rod undergoing only longitudinal deformation (extension or compression), with no bending.

We label locations of cross sections in the rod by using points in a *reference configuration*, an interval, say $0 \leq x \leq 1$. (See [Fig. 4.1](#).) The *physical configuration* is also an interval $0 \leq u \leq L$, depending on the deformation. The cross section labeled x in the reference configuration has coordinate $u(x, t)$ in the physical configuration at time t . It is convenient, but not essential, to think of the reference configuration as being the rod in equilibrium, with no forces acting on it. The function u is called the *displacement*; it is the unknown, or dependent

variable. We assume the density ρ (mass per unit volume in the reference configuration) is constant, and that the cross-sectional area A of the rod is constant along its length.

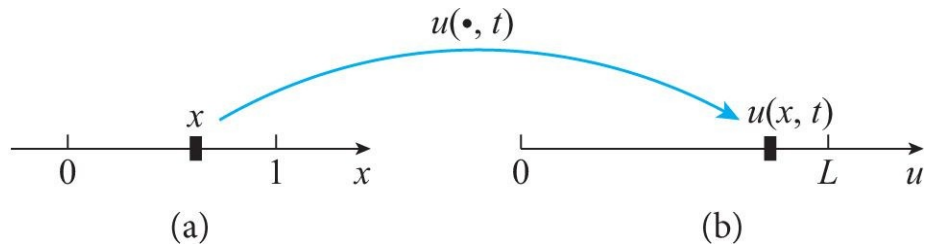

Figure 4.1. Deformation u in a one-dimensional rod. (a) Reference configuration (Lagrangian variables); (b) physical configuration (Eulerian variables).

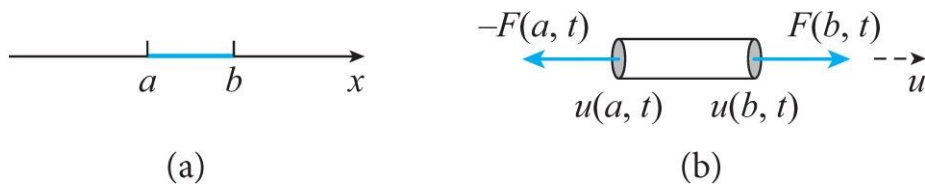

Figure 4.2. Forces on a small section of the rod. (a) Reference configuration (Lagrangian variables); (b) physical configuration (Eulerian variables).

Consider forces on a cross section labeled x_0 in the rod, at a specific time t . The part of the rod with $x > x_0$ exerts a force $F(x_0, t)$ on the part with $x < x_0$, and the part with $x < x_0$ exerts an equal and opposite force $-F(x_0, t)$ on the part with $x > x_0$, so that across each cross section, forces are balanced (see Fig. 4.2). However, the variation of these forces along the rod means that the net force acting on a *segment* of rod may be nonzero and induces a change in momentum.

In our formulation of the equation of motion, it is convenient to express the force distribution as a function of *Lagrangian* variable x rather than *Eulerian* variable u , even though we think of the force acting in the physical domain rather than the reference configuration. In fact, if we were to label forces in the physical domain as $f(u, t)$, then $F(x, t) = f(u(x, t), t)$. Moreover, it is convenient to consider the stress σ , which is force per unit area, rather than force F . In the present context $F = A\sigma$.

Since u_t is the velocity of a point (i.e., cross section) in the rod, the momentum density (meaning momentum per unit volume) is the quantity ρu_t . Now consider a short segment of the rod $a < x < b$. The momentum of this section is $\int_a^b \rho u_t(x, t) A dx$. The balance law states that the rate of change of momentum is equal to the net force:

$$\frac{d}{dt} \int_a^b \rho u_t(x, t) A dx = F(b, t) - F(a, t).$$

Notice that if $u_t(x, t)$ is constant in x , then this is precisely Newton's law:

$$\text{mass} \times \text{acceleration} = \text{force},$$

where mass means the mass of the little section of rod.

As in [Chapter 2](#), we can now derive a PDE from the balance law by writing both sides of the equation as integrals over $a < x < b$:

$$\int_a^b \rho u_{tt}(x, t) A dx = \int_a^b F_x(x, t) dx = \int_a^b \sigma_x(x, t) A dx.$$

Thus, provided u_{tt} , σ_x are continuous, we have the PDE

$$\rho u_{tt} = \sigma_x, \tag{4.1}$$

which expresses conservation of momentum.

To this equation we add a constitutive law, an equation that relates σ to u in a different way. In elasticity, this constitutive law states that the stress σ is a function of the strain. The strain is the deformation gradient; in the one-dimensional context of the rod, we have

$$\text{strain} = u_x.$$

In engineering, it is common to define strain to be $u_x - 1$, so that zero strain corresponds to no deformation: $u(x, t) = x$. In both cases, elasticity is expressed by a functional relationship between σ and u_x :

$$\sigma = \sigma(u_x).$$

Substituting into the PDE (4.1), we obtain

$$\rho u_{tt} = \sigma(u_x)_x.$$

As we observed earlier, this equation is hyperbolic if $\sigma'(u_x) > 0$, in which case, *stress increases with strain*, but it is elliptic if $\sigma'(u_x) < 0$. The hyperbolic case is more significant, especially for small deformations (more precisely, for small strains), but the elliptic case is also important for large deformations; it is associated with an effect called *strain softening*.

Perhaps the most important form of the constitutive law is *Hooke's law*, which states that increases in stress are proportional to increases in strain. This is expressed in the formula

$$\sigma(u_x) = k(u_x - 1). \tag{4.2}$$

Note that this can also be stated as *stress is proportional to strain* if we define the strain to be $u_x - 1$.

Substituting (4.2) into (4.1), we obtain the one-dimensional wave equation

$$u_{tt} = c^2 u_{xx}, \quad (4.3)$$

in which $c^2 = \frac{k}{\rho}$.

Remarks on Hooke's law. The constant $k > 0$ is a *constitutive parameter* called the *elastic modulus* that depends on the elastic properties of the material; it can be measured in experiments. The same experiments assess the range of strains in which Hooke's law is reasonable.

The parameter c has dimensions of a speed, that is, L/T , where L and T are a typical reference length (perhaps the length of the rod) and a typical time scale, respectively. Correspondingly, density (mass per unit volume) has dimensions M/L^3 , where M is the mass of the rod. It follows that k has dimensions LM/T^2 , that is, the dimensions of mass \times acceleration, the same dimensions as force. Note that this is consistent with (4.2), since both u and x have dimensions of length, so that u_x is dimensionless.

Hooke's law is familiar from elementary mechanics or the study of ODE. It arises in relating the extension of a spring to the tension in the spring. To see the connection with the rod, consider a uniform deformation given by $u(x) = Lx$. Then $\sigma(u_x) = k(L - 1)$. But $L - 1$ is the extension (if $L > 1$); the stress σ is constant and corresponds to the tension in the spring. Thus, the tension is proportional to the extension. Indeed, just as for springs, the constant k in Hooke's law can be found by performing simple extension experiments.

4.1.2. The Vibrating String

Consider a thin elastic string, such as a guitar string or bungee cord, which we treat as a one-dimensional curve. For simplicity, we assume that the string moves only in two dimensions, and that the tension in the string is high enough that we can ignore gravity. Another scenario with no effect of gravity would be an experiment with a string constrained to a horizontal frictionless table. The effectively one-dimensional elastic body is called a string when we assume that it can be bent with no resulting force. Then we say *there is no resistance to bending*. Let's consider the motion of a point on the string labeled by $x \in [0, 1]$. At each time t , this point will be located in the plane at $(r_1, r_2) = \mathbf{r}(x, t) \in \mathbb{R}^2$ (see Fig. 4.3). Then the tangent to the string is $\mathbf{r}_x(x, t)$. Since there is no resistance to bending and no gravity, the only force on the string is due to the tension $\hat{\mathbf{t}}$, which acts tangentially and is the only nonzero component of the stress. If the string has a uniform cross-sectional area A and constant density ρ (gm/cm³), then the equations of motion (Newton's second law, or conservation of momentum) are

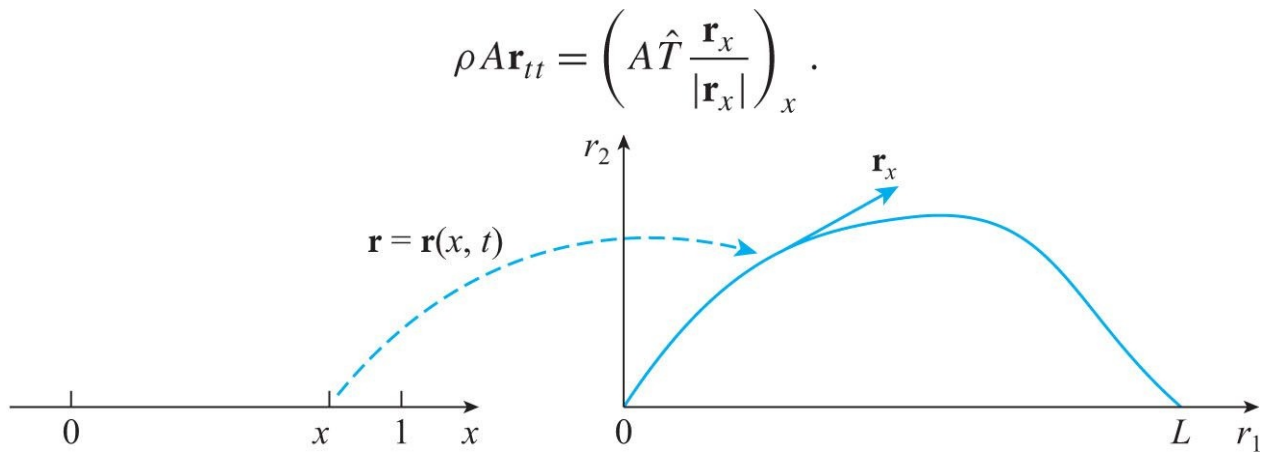

Figure 4.3. The elastic string; one-dimensional string deforming in two dimensions.

Now we make the constitutive assumption that the tension \hat{T} depends only on the strain $|\mathbf{r}_x|$ and write $\hat{T}/\rho = T(|\mathbf{r}_x|)$. Thus, the string equations are

$$\mathbf{r}_{tt} = \left(T(|\mathbf{r}_x|) \frac{\mathbf{r}_x}{|\mathbf{r}_x|} \right)_x , \quad 0 < x < 1, \quad t > 0. \quad (4.4)$$

Suitable boundary conditions, in which the string is fixed at two locations, are

$$\mathbf{r}(0, t) = \mathbf{0}; \quad \mathbf{r}(1, t) = (L, 0). \quad (4.5)$$

With these boundary conditions, there is an equilibrium solution $\mathbf{r}_0 = (xL, 0)$ in which the string is stretched between the two fixed ends, as in a guitar string before it is plucked or strummed. We assume that the tension at equilibrium is positive: $T(L) > 0$, and also that it is increasing with strain: $T'(L) > 0$.

Now consider small deviations (u, v) from the equilibrium solution, and write $\mathbf{r} = (xL + u, v)$. We aim to find equations for the new variables u, v as functions of x, t . Of course, we can simply substitute this expression into the string equations and get exact equations for u, v . However, we want to take advantage of the smallness of u, v . To do this, we substitute into the PDE system (4.4) and then use a Taylor expansion about the equilibrium solution, which is now $u = v = 0$.

When we substitute into (4.4) and expand each term as a Taylor series in u, v retaining only constant and first-order terms (linear in u, v), we get a lot of terms. For example, we need

$$|\mathbf{r}_x| = \sqrt{(L + u_x)^2 + v_x^2} = L \left(\left(1 + \frac{u_x}{L} \right)^2 + \frac{v_x^2}{L^2} \right)^{1/2} = L + u_x + h.o.t.,$$

where *h.o.t.* represents the remaining higher-order terms in the Taylor series; specifically, $h.o.t. = O(u_x^2 + v_x^2)$. Similarly,

$$T(|\mathbf{r}_x|) = T(L) + T'(L)u_x + h.o.t.,$$

$$\frac{\mathbf{r}_x}{|\mathbf{r}_x|} = \begin{pmatrix} L + u_x \\ v_x \end{pmatrix} (L + u_x)^{-1} + h.o.t. = \begin{pmatrix} 1 \\ v_x/L \end{pmatrix} + h.o.t.$$

Thus,

$$T(|\mathbf{r}_x|) \frac{\mathbf{r}_x}{|\mathbf{r}_x|} = \begin{pmatrix} T(L) + T'(L)u_x \\ T(L)v_x/L \end{pmatrix} + h.o.t. \quad (4.6)$$

Finally, the [equation \(4.4\)](#) becomes a pair of wave equations if we retain only terms linear in u and v ; that is, drop the *h.o.t.* terms in [\(4.6\)](#):

$$\begin{aligned} u_{tt} &= c^2 u_{xx}, \\ v_{tt} &= s^2 v_{xx}. \end{aligned} \quad (4.7)$$

In these linear wave equations, $c = \sqrt{T'(L)}$ is the *longitudinal* wave speed, and $s = \sqrt{\frac{T(L)}{L}}$ is the *transverse* wave speed. It can be argued that the longitudinal motion represented by u is smaller than the transverse motion if the string is displaced laterally. Thus, a good approximation is to take the equation for v alone and represent the string simply by the transverse displacement $v(x, t)$, $0 < x < 1$.

This is a useful way to think of solutions of the wave equation; for each fixed time t the graph of $v(x, t)$ represents the string. As time varies, the graph evolves as a string in motion.

4.2. D'Alembert's Solution

In 1747, d'Alembert¹ published a paper on vibrating strings that included his famous solution of the wave equation in one space variable x and time t :

$$u_{tt} = c^2 u_{xx}. \quad (4.8)$$

The first, and fundamental, step in deriving d'Alembert's solution is to show that the general solution of [\(4.8\)](#) is

$$u(x, t) = F(x - ct) + G(x + ct), \quad (4.9)$$

where F and G are arbitrary C^2 functions. The lines $x - ct = \text{const.}$, $x + ct = \text{const.}$, where $F(x - ct)$, $G(x + ct)$ (respectively) are constant, are called *characteristics*.

Since $c > 0$ is constant, we can factor the partial differential operator $\partial_t^2 - c^2 \partial_x^2$ and write the PDE as

$$(\partial_t - c \partial_x) (\partial_t + c \partial_x) u = 0. \quad (4.10)$$

Then since $(\partial_t + c\partial_x)F(x - ct) = 0$, and $(\partial_t - c\partial_x)G(x + ct) = 0$, we see that (4.9) is a solution.

It will be useful when discussing solutions of the wave equation to interpret (4.9) as the *superposition* of two waves: the graph of $F(x - ct)$ as a function of x for various times t is a wave traveling with speed c to the right, and $G(x + ct)$ represents a wave moving to the left with speed c . Thus, the wave equation (4.8) models waves of speed c moving in both directions, to the left and right, just as the linear transport equation models waves of speed $c > 0$ moving to the right only. We can add the two waves in (4.9), because the PDE (4.8) is linear and homogeneous.

To see that every solution can be represented in the form (4.9) for some choice of functions F, G , we introduce characteristic variables suggested by the factorized equation (4.10):

$$\xi = x + ct, \quad \eta = x - ct,$$

and write $z(\xi, \eta) = u(x, t)$. Then we have

$$\partial_t u = \frac{\partial z}{\partial \xi} \frac{\partial \xi}{\partial t} + \frac{\partial z}{\partial \eta} \frac{\partial \eta}{\partial t} = c \frac{\partial z}{\partial \xi} - c \frac{\partial z}{\partial \eta}, \quad c \partial_x u = c \frac{\partial z}{\partial \xi} + c \frac{\partial z}{\partial \eta}.$$

Adding and subtracting as in (4.10), the equation becomes

$$\left(-2c \frac{\partial}{\partial \eta}\right) \left(2c \frac{\partial}{\partial \xi}\right) z = -4c^2 \frac{\partial}{\partial \eta} \frac{\partial}{\partial \xi} z = 0.$$

Integrating over η , we find

$$\frac{\partial z}{\partial \xi} = g(\xi)$$

for some function g (which is constant with respect to η).

Thus, $z(\xi, \eta) = G(\xi) + F(\eta)$, where $G(\xi) = \int g(\xi) d\xi$, and F is another arbitrary function. Back in the original variables, we arrive at

$$u(x, t) = z(x + ct, x - ct) = F(x - ct) + G(x + ct).$$

4.2.1. Initial Value Problem (Cauchy Problem)

We use the general solution (4.9) of the wave equation to solve the Cauchy problem

$$\begin{aligned} u_{tt} &= c^2 u_{xx}, & -\infty < x < \infty, & t > 0, \\ u(x, 0) &= \phi(x), & -\infty < x < \infty, & \\ u_t(x, 0) &= \psi(x), & -\infty < x < \infty. & \end{aligned} \tag{4.11}$$

Just as for ODE, since the PDE is second order in t , to have a well-posed problem (cf. [Section 2.1](#)) we have to specify both the initial displacement u and the initial velocity u_t .

Theorem 4.1. *If ϕ is C^2 and ψ is C^1 , then the unique C^2 solution of (4.11) is given by*

$$u(x, t) = \frac{1}{2} (\phi(x + ct) + \phi(x - ct)) + \frac{1}{2c} \int_{x-ct}^{x+ct} \psi(y) dy. \quad (4.12)$$

Proof. The general solution of the PDE is

$$u(x, t) = F(x - ct) + G(x + ct). \quad (4.13)$$

Then the initial conditions give

$$\begin{aligned} u(x, 0) &= F(x) + G(x) = \phi(x), \\ u_t(x, 0) &= -cF'(x) + cG'(x) = \psi(x). \end{aligned}$$

Integrating the second equation yields $-F(x) + G(x) = \frac{1}{c} \int_0^x \psi(y) dy + A$.

Now we can solve for F and G , leading to (4.12). We leave it as an exercise to verify that the initial conditions are satisfied.

It is clear from (4.12) that $u(x, t)$ is a C^2 function. Uniqueness is a consequence of the fact that F and G in the general solution are determined by the initial condition. ■

Formula (4.12) is known as *d'Alembert's solution*. Note that since ψ specifies u_t at $t = 0$, it is consistent that it should be integrated in a formula for u . In integrating ψ , we gain a derivative. Thus, we have the following *regularity* of the solution:

If ϕ is C^n , and ψ is C^{n-1} , for some $n \geq 2$, then u is C^n .

In other words, the solution inherits regularity from the initial data. There is no gain or loss of regularity, a property typical of hyperbolic PDE. In fact, (4.12) makes sense even if ϕ or ψ are less regular than in the theorem; the corresponding function $u(x, t)$ is then known as a *weak solution*, even though the derivatives of the solution seemingly required by the PDE may not exist.

D'Alembert's solution allows us to establish another part of well-posedness, namely, *continuous dependence on the data*.

Proof of continuous dependence. Let $u = u_1$, $u = u_2$ be solutions of problem (4.11) with initial data ϕ_k, ψ_k , $k = 1, 2$, that are bounded and uniformly close in the sense of continuous functions:

$$|\phi_1(x) - \phi_2(x)| < \epsilon; \quad |\psi_1(x) - \psi_2(x)| < \epsilon, \quad -\infty < x < \infty,$$

where $\epsilon > 0$ is small. From (4.12), we have

$$\begin{aligned}
 & |u_1(x, t) - u_2(x, t)| = \\
 & = \left| \frac{1}{2}(\phi_1 - \phi_2)(x + ct) + \frac{1}{2}(\phi_1 - \phi_2)(x - ct) + \frac{1}{2c} \int_{x-ct}^{x+ct} (\psi_1 - \psi_2)(y) dy \right| \\
 & \leq \frac{1}{2}|(\phi_1 - \phi_2)(x + ct)| + \frac{1}{2}|(\phi_1 - \phi_2)(x - ct)| + \frac{1}{2c} \int_{x-ct}^{x+ct} |(\psi_1 - \psi_2)(y)| dy \\
 & \leq \frac{1}{2}\epsilon + \frac{1}{2}\epsilon + \frac{1}{2c} 2ct\epsilon = (1 + t)\epsilon.
 \end{aligned}$$

In this calculation, we have used the triangle inequality and the integral estimate $|\int f(x)dx| \leq \int |f(x)|dx$.

It follows that if $|\phi_1 - \phi_2|$ and $|\psi_1 - \psi_2|$ are uniformly small, then $|u_1(x, t) - u_2(x, t)|$ is small at each x , $t < \infty$. Note that the estimate gets worse with increasing time, so that to make $u_1 - u_2$ uniformly small in x and t , we have to take a finite time interval, unless we include $\int_{-\infty}^{\infty} |\psi_1(y) - \psi_2(y)| dy$ in the smallness condition. ■

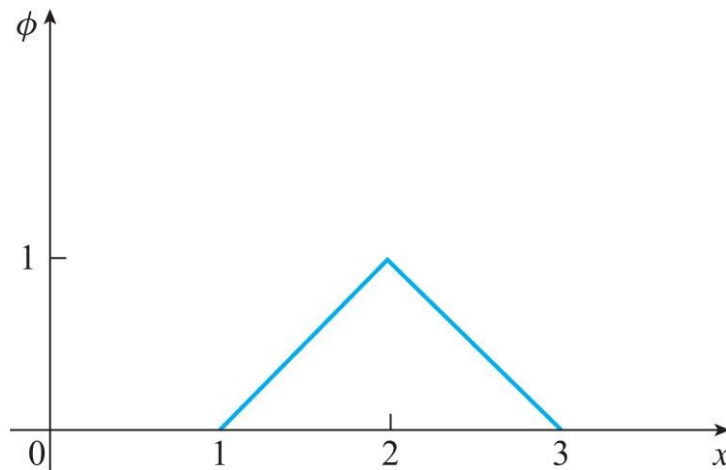

Figure 4.4. Initial displacement $\phi(x)$.

Example 1. (Representing d’Alembert’s solution graphically) For simplicity, let’s take the initial velocity to be zero, $\psi(x) \equiv 0$, choose $c = 2$, and take the support of ϕ to be the interval $[1, 3]$. The *support* of a function ϕ is defined to be the closure (including boundary points) of the set where ϕ is nonzero. Thus, $\text{supp } \phi \equiv \overline{\{x : \phi(x) \neq 0\}}$.

The solution of (4.11) in this example is

$$u(x, t) = \frac{1}{2}(\phi(x + 2t) + \phi(x - 2t)). \tag{4.14}$$

The initial data are piecewise linear, with changes in slope at $x = 1, 2, 3$ (Fig. 4.4). Correspondingly, the solution (at a fixed t) will be piecewise linear, with changes in slope expected at values of x for which

$$x \pm 2t = 1; \quad x \pm 2t = 2; \quad x \pm 2t = 3.$$

The graph of $\phi(x + 2t)$ as a function of x has the shape of a triangle moving to the left with speed 2, and $\phi(x - 2t)$ has the same shape and speed, but moving to the right. The solution (4.14) is the average of these two graphs.

We can represent the solution in the $x-t$ plane, as shown in Figure 4.5. The leading edge of the left-moving triangular wave lies on the characteristic $x + 2t = 1$; it gets to $x = 0$ when $t = \frac{1}{2}$. Starting at $x = 1$, and moving left with speed 2, the wave takes until $t = \frac{1}{2}$ to reach 0.

Domain of dependence and region of influence. The structure of the characteristics in the $x-t$ plane in Figure 4.5 suggests how the initial data propagate and influence the solution. Likewise, we can consider the dependence on the initial data of the solution at a point (x, t) .

The *backward characteristics* through a point a point (x_0, t_0) with $t_0 > 0$ are the lines

$$x \pm ct = x_0 \pm ct_0, \quad 0 \leq t \leq t_0.$$

The backward characteristics intersect the x -axis at $x = x_0 \pm ct_0$; the solution of the Cauchy problem at (x_0, t_0) depends only on the initial data in the interval between these points. The interval is referred to as the *interval of dependence* of the point (x_0, t_0) . More common terminology is to refer to the triangle with base given by the interval of dependence and sides given by the backward characteristics as the *domain of dependence* of the point (x_0, t_0) .

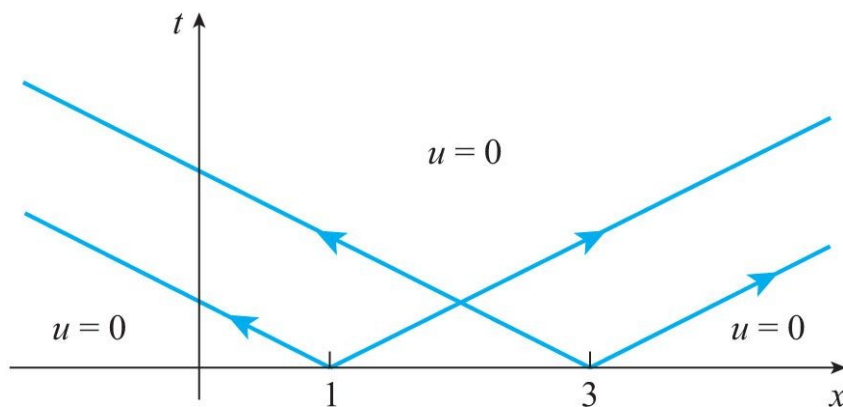

Figure 4.5. The $x-t$ plane for Example 1. Note that the slope of the characteristics is the reciprocal of the wave speed.

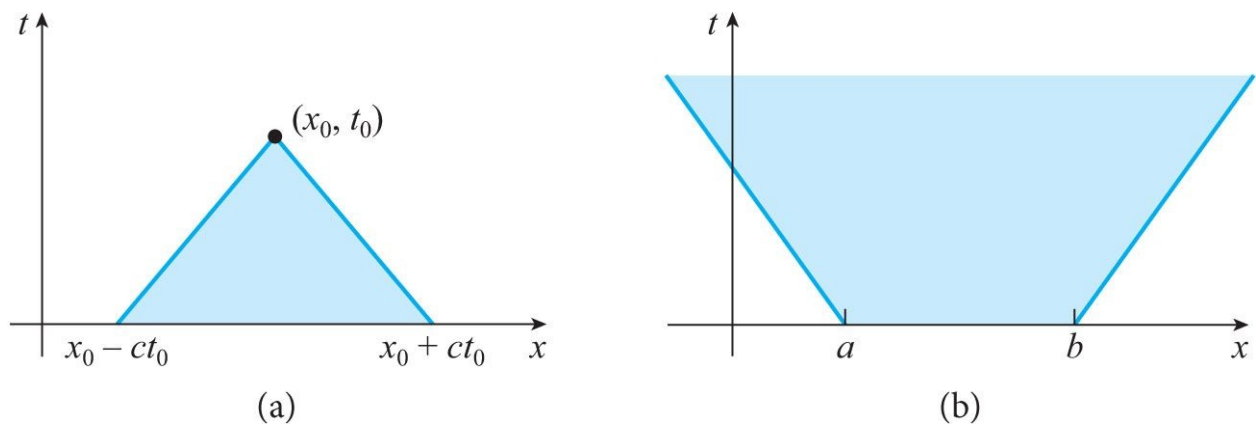

Figure 4.6. (a) Domain of dependence (x_0, t_0) and (b) region of influence of $[a, b]$ for the wave equation.

The *region of influence* of a point (x_0, t_0) is the set bounded by the forward characteristics:

$$x \pm ct = x_0 \pm ct_0, \quad t \geq t_0.$$

We can also speak of the region of influence of a subset of the x - t plane, but more commonly we refer to the region of influence of an initial interval $a \leq x_0 \leq b$, with $t = 0$. The region of influence of the interval $[a, b]$ on the x -axis is the set bounded by characteristics $x + ct = a$, $x - ct = b$.

These notions give us a graphical means of understanding how initial data propagate forward in time, as shown in Figure 4.6. In particular, if the data have compact (i.e., bounded) support in an interval $[a, b]$, then the solution is necessarily zero outside the region of influence of the initial interval $[a, b]$, as can be seen by drawing backward characteristics from any point outside this region of influence. We say that initial disturbances (meaning where ϕ or ψ are nonzero) propagate with finite speed c .

4.2.2. The Wave Equation on a Semi-Infinite Domain

The Cauchy problem shows how initial disturbances propagate as waves in free space. To describe how these waves are reflected at a boundary, we formulate and solve an initial boundary value problem on the quarter-plane $\{(x, t) : x > 0, t > 0\}$ with a single boundary.

Consider the initial boundary value problem

$$\begin{aligned} u_{tt} &= c^2 u_{xx}, & x > 0, \quad t > 0, \\ u(0, t) &= 0, & t > 0, \\ u(x, 0) &= \phi(x), & x > 0, \\ u_t(x, 0) &= \psi(x), & x > 0. \end{aligned} \tag{4.15}$$

The boundary condition specifying $u(0, t)$ means that the end of the string is held

in place. We could instead specify the slope $u_x(0, t)$, which would mean the stress is specified. In particular, the boundary condition $u_x(0, t) = 0$ is referred to as a *stress-free* boundary condition.

For $x > ct$, we have d'Alembert's solution (4.12)

$$u(x, t) = \frac{1}{2}[\phi(x + ct) + \phi(x - ct)] + \frac{1}{2c} \int_{x-ct}^{x+ct} \psi(y) dy, \quad (4.16)$$

with ϕ, ψ evaluated only for positive values of their arguments.

To obtain an expression for the solution in the region $0 < x < ct$, we have to use the boundary condition, since (4.16) does not apply for $x - ct < 0$. Notice that characteristics with positive speed c propagate into the domain from the boundary $x = 0$ as t increases (see Fig. 4.7). These characteristics carry information from the boundary condition. Moreover, each point in the quarter-plane also has a characteristic moving left with speed c that originated on the initial line $x > 0, t = 0$. Therefore, the solution for $x < ct$ will involve both the initial condition and the boundary condition.

The solution can be found from the general solution (4.13), obtaining expressions for the functions F, G from the initial and boundary conditions, much as was done in the proof of Theorem 4.1. The result of this calculation is

$$u(x, t) = \frac{1}{2} (\phi(x + ct) - \phi(ct - x)) + \frac{1}{2c} \int_{ct-x}^{x+ct} \psi(y) dy, \quad 0 < x < ct. \quad (4.17)$$

Observe that this formula satisfies the boundary condition $u(0, t) = 0$. Formula (4.17) can be interpreted as the solution of the Cauchy problem with initial data on the entire real line obtained by extending both ϕ and ψ to be odd functions, so that $\phi(-x) = -\phi(x), \psi(-x) = -\psi(x), x > 0$. Then (4.17) uses the oddness of the extension to express the solution entirely in terms of the given data on the positive x -axis.

Moreover, there is another interpretation of this construction. The solution of the Cauchy problem with odd initial data involves waves moving left and right in the upper half-plane. Those with $x < 0$ and moving right have the property that along the line $x = 0$ (the t -axis), they exactly cancel waves moving left. This cancellation explains how the boundary condition $u(0, t) = 0$ is satisfied.

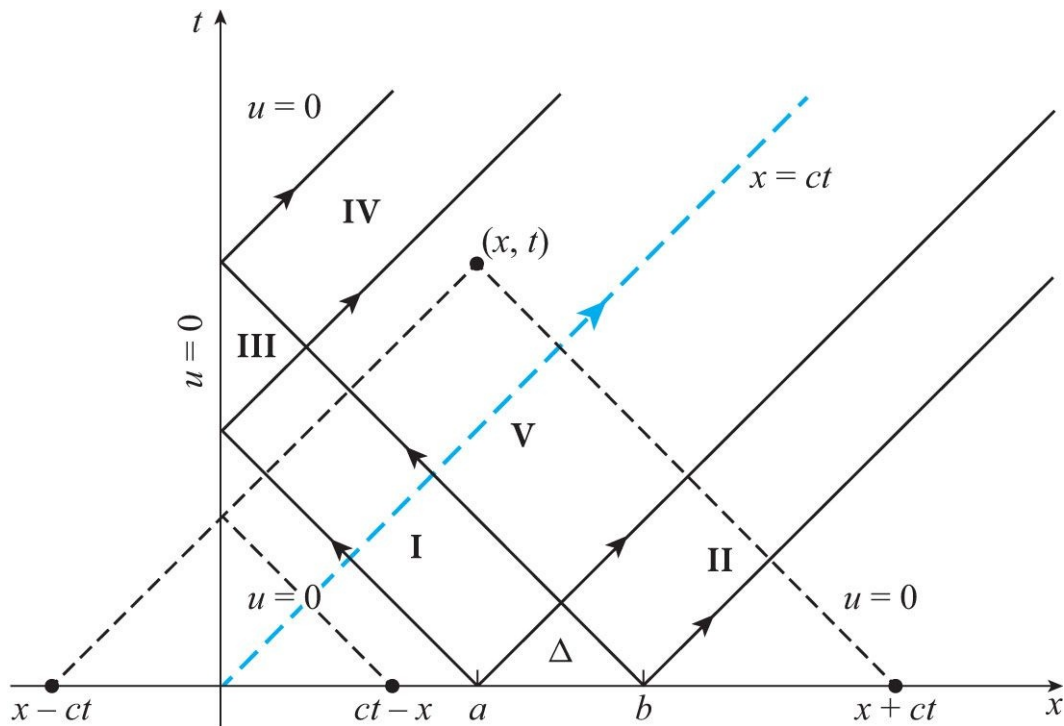

Figure 4.7. Characteristics for the quarter-plane problem.

Example 2. (Representing a quarter-plane solution graphically) Let's suppose $\text{supp } \phi \subset [a, b]$ and $\text{supp } \psi \subset [a, b]$. The solution is represented in the x - t plane in [Figure 4.7](#), where we have drawn forward characteristics from the boundary of the support of the initial data, including their reflections from the boundary $x = 0$. The reflected characteristics record the switch from $x - ct$ to $ct - x$ in the solution; equally, we can think of the reflected characteristics as originating from the x -axis and carrying information from the extended initial data. Finally, the reflected characteristics carry information from the boundary (specifically, the boundary condition) into the interior of the domain. This last point of view is helpful when considering nonzero boundary data. In [Figure 4.7](#) the domain is divided into sectors in which we can write the solution in more detail. For example, the solution is zero in three of the regions. In each of the other regions, we use backward characteristics to see which part of the support of the initial data is used in calculating the solution.

For (x, t) in the triangular region labeled Δ in [Figure 4.7](#), the backward characteristics hit the x -axis at $x - ct$ and $x + ct$, both of which lie in the interval $[a, b]$. Thus, there is no simplification, and u is given by d'Alembert's formula ([4.16](#)).

In region I, $x - ct < a$, and $ct - x < a$, while $a < x + ct < b$, so that both ([4.16](#)) and ([4.17](#)) reduce to

$$u(x, t) = \frac{1}{2}\phi(x + ct) + \frac{1}{2c} \int_a^{x+ct} \psi(y) dy,$$

which is a wave traveling to left, a function of $x + ct$.

In region II, $u(x, t)$ is likewise a function of $x - ct$; the graph is a wave traveling to the right.

In region III, part of the wave is reflected by the boundary and interacts with the wave traveling toward the boundary. In fact there is just enough cancellation so that the boundary condition is satisfied at $x = 0$. The reflected wave emerges as a function of $(x - t)$ in region IV. Thus in region III, where both waves are present, and $a < ct - x < x + ct < b$, $u(x, t)$ is given by the full formula (4.17).

In region IV, after the left-moving wave has been fully reflected and is now moving to the right, we have $x + ct > b$, and thus

$$u(x, t) = -\frac{1}{2}\phi(ct - x) + \frac{1}{2c} \int_{t-x}^b \psi(y) dy.$$

In region V, $x - ct$ and $ct - x$ are less than a , while $x + ct > b$. (This case is also shown in Fig. 4.7.) Therefore, there is no contribution from the initial displacement ϕ , and the contribution from the initial velocity is constant:

$$u(x, t) = \frac{1}{2c} \int_a^b \psi(y) dy.$$

Similarly, in the region between IV and the t -axis, we find $u \equiv 0$. We see this by noting that both $x + ct$ and $ct - x$ are larger than b . Equivalently, since $x - ct < -b < b < x + ct$, we find that u is the integral of the odd extension of ψ from $-b$ to b and hence is zero.

It is instructive to graph the solution carefully for various values of t , say, for Example 2, with ϕ triangular (see Fig. 4.4) and ψ zero.

Example 3. (Nonzero boundary condition) Consider the initial boundary value problem with nonzero boundary condition

$$\begin{aligned} u_{tt} &= c^2 u_{xx}, & x > 0, & t > 0, \\ u(0, t) &= h(t), & t > 0, \\ u(x, 0) &= \phi(x), & x > 0, \\ u_t(x, 0) &= \psi(x), & x > 0. \end{aligned} \tag{4.18}$$

The solution is similar to (4.16), except there is an additional term that propagates the boundary data into the domain $x > 0$. To derive the additional term, first observe that if ϕ and ψ are zero, then the string is initially horizontal and at rest. The displacement $h(t)$, specified at the boundary, propagates into the interior, and induces motion of the string. Consequently, this disturbance

propagates as a wave $u(x, t) = F(x - ct)$ with speed c . Setting $x = 0$ in this solution, we match the boundary condition: $F(-ct) = h(t)$. Consequently, $F(\xi) = h(-\xi/c)$, for $\xi < 0$, and the solution

$$u(x, t) = h\left(\frac{ct - x}{c}\right)$$

follows immediately. The full solution is obtained by simply superimposing the solution with $h \equiv 0$. Note that right-moving characteristics carry only half the information of the solution for the Cauchy problem, but they carry all the boundary information, since the boundary data travel only to the right in the physical domain $x > 0$.

4.3. The Energy $E(t)$ and Uniqueness of Solutions

In this section we define an energy function for the wave equation, show that energy is conserved for the Cauchy problem (4.11), and use this property to establish uniqueness of solutions of the Cauchy problem.

Let's assume that $u = u(x, t)$ is a smooth solution of the Cauchy problem and the derivatives $u_t(x, t)$, $u_x(x, t)$ are square integrable (i.e., in $L^2(\mathbb{R})$) for each $t \geq 0$. Then the total energy defined by

$$E(t) = \int_{-\infty}^{\infty} \left(\frac{1}{2} u_t^2 + \frac{c^2}{2} u_x^2 \right) dx$$

is finite.²

Note that $E(t)$ is the sum of the kinetic and potential energies. The potential energy $PE(t) = \int_{-\infty}^{\infty} \frac{c^2}{2} u_x^2 dx$ is the energy stored in the string due to tension, and the kinetic energy $KE(t) = \int_{-\infty}^{\infty} \frac{1}{2} u_t^2 dx$ is akin to the quantity $\frac{1}{2}mv^2$ in classical mechanics of a rigid body with mass m and velocity v .

To see how $E(t)$ is connected to the one-dimensional wave equation (4.8), we multiply the PDE by u_t and integrate by parts:

$$\int_{-\infty}^{\infty} u_t u_{tt} dx = \int_{-\infty}^{\infty} c^2 u_{xx} u_t dx.$$

Thus, we have

$$\begin{aligned} \int_{-\infty}^{\infty} \frac{\partial}{\partial t} \frac{u_t^2}{2} dx &= c^2 u_x u_t \Big|_{x=-\infty}^{+\infty} - c^2 \int_{-\infty}^{\infty} u_x u_{xt} dx \\ &= -c^2 \int_{-\infty}^{\infty} \frac{\partial}{\partial t} \frac{u_x^2}{2} dx. \end{aligned}$$

That is,

$$E'(t) = \frac{d}{dt} \int_{-\infty}^{\infty} \left(\frac{1}{2} u_t^2 + \frac{c^2}{2} u_x^2 \right) dx = 0.$$

Therefore, we have conservation of total energy: $E(t) = \text{constant}$, from which we deduce

$$E(t) = E(0) = \frac{1}{2} \int_{-\infty}^{\infty} \left(\psi(x)^2 + c^2 \phi'(x)^2 \right) dx, \quad t > 0.$$

This identity is an important tool for existence and regularity of solutions, but also for uniqueness of solutions, as we now discuss.

Uniqueness of solutions. Consider the Cauchy problem

$$\begin{aligned} u_{tt} &= c^2 u_{xx} + f(x, t), & -\infty < x < \infty, \quad t > 0, \\ u(x, 0) &= \phi(x), \quad u_t(x, 0) = \psi(x), & -\infty < x < \infty, \end{aligned} \quad (4.19)$$

in which the inhomogeneity $f(x, t)$ is a specified function representing a time-dependent distribution of force along the one-dimensional elastic body. For example, if the PDE represents small transverse vertical vibrations of an elastic string, then $f(x, t) = -g$ could be the force distribution due to gravity. (Note that the density ρ has been absorbed into c^2 .)

We can use the energy calculation to prove uniqueness of C^2 solutions of (4.19). Consider two C^2 solutions u_1, u_2 with the same data ϕ, ψ, f . To prove uniqueness, we show $u_1 = u_2$. Define $u(x, t) = u_1(x, t) - u_2(x, t)$. Then u satisfies the homogeneous version of (4.19), with zero initial data:

$$\begin{aligned} u_{tt} &= c^2 u_{xx}, \\ u(x, 0) &= 0, \quad u_t(x, 0) = 0. \end{aligned}$$

Since $E(t) = E(0) = 0$ for this problem, we have

$$\int_{-\infty}^{\infty} \left(\frac{1}{2} u_t^2 + \frac{c^2}{2} u_x^2 \right) dx = 0.$$

Therefore,

$$u_t = 0, \quad u_x = 0.$$

Thus, u is constant in x and t . But $u(x, 0) = 0$, so the constant is zero. Hence $u = u_1 - u_2 \equiv 0$.

4.4. Duhamel's Principle for the Inhomogeneous Wave Equation

Duhamel's principle is used to solve inhomogeneous initial boundary value problems when we have the solution of the homogeneous problem in hand.

Consider the initial value problem

$$\begin{aligned} u_{tt} &= c^2 u_{xx} + f(x, t), & -\infty < x < \infty, & t > 0, \\ u(x, 0) &= 0, \quad u_t(x, 0) = 0, & -\infty < x < \infty. \end{aligned} \quad (4.20)$$

To solve (4.20) using Duhamel's principle, let $\tilde{u}(x, t; s)$ be the solution (for each $s > 0$) of

$$\begin{aligned} \tilde{u}_{tt} &= c^2 \tilde{u}_{xx}, & t > s, & -\infty < x < \infty, \\ \tilde{u}(x, s; s) &= 0, \\ \tilde{u}_t(x, s; s) &= f(x, s). \end{aligned} \quad (4.21)$$

To understand why \tilde{u} might be helpful, consider the special case in which $f(x, t) = F(t)$ is independent of x , and we seek a solution $v(t)$ independent of x . Then we have

$$v''(t) = F(t), \quad v(0) = 0 = v'(0).$$

Integrating twice and reversing the order of integration, we see that

$$v(t) = \int_0^t (t - s) F(s) ds.$$

But for each $s > 0$, $w(s, t) = (t - s) F(s)$ solves the x -independent version of (4.21), namely,

$$w_{tt} = 0, \quad w(s, s) = 0, \quad w_t(s, s) = F(s),$$

and $v(t) = \int_0^t w(t, s) ds$.

This calculation suggests that $u(x, t) = \int_0^t \tilde{u}(x, t, s) ds$ solves (4.20). To complete the solution, it remains to find \tilde{u} . But \tilde{u} satisfies a Cauchy problem for the homogenous wave equation with initial condition at time $t = s$. We can adapt d'Alembert's solution by translating t by s in d'Alembert's formula, with $\phi(x) = 0$; $\psi(x) = f(x, s)$. This gives a formula for \tilde{u} :

$$\tilde{u}(x, t; s) = \frac{1}{2c} \int_{x-c(t-s)}^{x+c(t-s)} f(y, s) dy.$$

Now let $u(x, t) = \int_0^t \tilde{u}(x, t, s) ds$. That is,

$$u(x, t) = \frac{1}{2c} \int_0^t \int_{x-c(t-s)}^{x+c(t-s)} f(y, s) dy ds.$$

The double integral is an integration of f over the triangular domain of dependence of (x, t) shown in [Figure 4.6](#).

Claim 4.2. *The function $u(x, t)$ satisfies (4.20).*

Proof. Let (x_0, t_0) be fixed with $t_0 > 0$. The proof involves integrating the PDE (4.20) over the domain of dependence $\Delta = \{(x, t) : x_0 - c(t - t_0) < x < x_0 + c(t - t_0), 0 < t < t_0\}$ and using Green's theorem in the plane (see Appendix A). With the exact differential $du = u_x dx + u_t dt$, the integral on the boundary is reduced to $u(x_0, t_0)$. ■

It is straightforward to use this procedure to solve the more general initial value problem in which the initial data can be nonzero:

$$\begin{aligned} u_{tt} &= c^2 u_{xx} + f(x, t), & -\infty < x < \infty, t > 0, \\ u(x, 0) &= \phi(x), & u_t(x, 0) = \psi(x), & -\infty < x < \infty. \end{aligned}$$

We solve this problem by considering each of f , ϕ , ψ separately, setting the others to zero; the solution is then the sum of the corresponding solutions:

$$\begin{aligned} u(x, t) &= \frac{1}{2c} \int_0^t \int_{x-c(t-s)}^{x+c(t-s)} f(y, s) dy ds \\ &\quad + \frac{1}{2} (\phi(x+ct) + \phi(x-ct)) + \frac{1}{2c} \int_{x-ct}^{x+ct} \psi(y) dy. \end{aligned}$$

4.5. The Wave Equation on \mathbb{R}^2 and \mathbb{R}^3

The method of spherical means uses the rotational and translational invariance of the wave equation to find solutions that are the analog in \mathbb{R}^n , $n \geq 2$, of d'Alembert's solution in one dimension. The resulting formulas allow us to understand the Huygens principle of wave propagation. Huygens originally expressed his principle geometrically, using spheres centered at points of a wavefront with radius given by an incremental time and arguing that the intensities would cancel except along the expanding surface formed as the envelope of the overlapping spheres.

Here we show briefly how to derive an explicit formula for the solution of initial value problems in \mathbb{R}^2 and \mathbb{R}^3 . It is in fact easier to start with \mathbb{R}^3 . Suppose $u(\mathbf{x}, t)$ is a solution of the wave equation

$$u_{tt} = c^2 \Delta u, \quad \mathbf{x} \in \mathbb{R}^3, \quad t \geq 0,$$

with Cauchy data $u(\mathbf{x}, 0) = \phi(\mathbf{x})$, $u_t(\mathbf{x}, 0) = \psi(\mathbf{x})$. For $r > 0$, define the spherical means $v(r, t) = \bar{u}(r, t) = \int_{S(\mathbf{x}, r)} u(\mathbf{x}, t) dS$, where $S(\mathbf{x}, r)$ denotes the sphere with center \mathbf{x} and radius r . (See Appendix A for the integral average notation \bar{f} .) If we can find $v(r, t)$, then we recover $u(\mathbf{x}, t) = \lim_{r \rightarrow 0} v(r, t)$. But this will give a formula

for $u(x, t)$ for any x, t , by centering the spheres at a general point $\mathbf{x} \in \mathbb{R}^3$ instead of at $\mathbf{x} = 0$. Here are the main steps in constructing the formula.

1. Observe that $v(r, t)$ is a rotationally invariant solution of the wave equation

$$v_{tt} = c^2 \left(v_{rr} + \frac{2}{r} v_r \right),$$

with initial data given by the averages of the data for u : $v(r, 0) = \bar{\phi}(r)$, $v_t(r, 0) = \bar{\psi}(r)$. Notice that $v(r, t)$ is symmetric about the origin, but we could equally well have centered the spheres at any point \mathbf{x} in space, taking integral averages over the resulting spheres $S(\mathbf{x}, r)$, leading to the same statement of the Cauchy problem for v , but with different $\bar{\phi}, \bar{\psi}$.

2. Let $w(r, t) = rv(r, t)$. Then w satisfies the one-dimensional wave equation

$$w_{tt} = c^2 w_{rr}, \quad r > 0, \quad t > 0,$$

with initial data $w(r, 0) = r\bar{\phi}(r)$, $w_t(r, 0) = r\bar{\psi}(r)$, and boundary condition $w(0, t) = 0$. Consequently, d'Alembert's solution can be used to solve this quarter-plane problem, effectively using the even extensions of $\bar{\phi}(r), \bar{\psi}(r)$ or equivalently, the odd extensions of $r\bar{\phi}(r), r\bar{\psi}(r)$.

3. Since we are interested only in $u(0, t) = \lim_{r \rightarrow 0} v(r, t) = \lim_{r \rightarrow 0} w(r, t)/r$, we write the solution with $r < ct$:

$$w(r, t) = \frac{1}{2c} \int_{ct-r}^{ct+r} s \bar{\psi}(s) ds + \frac{\partial}{\partial t} \frac{1}{2c} \int_{ct-r}^{ct+r} s \bar{\phi}(s) ds. \quad (4.22)$$

Notice that we write the final ϕ term as the derivative of an integral, which turns out to be more convenient than the equivalent form used in [Section 4.2.1](#).

4. Now we compute the limit as $r \rightarrow 0$:

$$u(0, t) = \lim_{r \rightarrow 0} w(r, t)/r = \frac{\partial w}{\partial r}(0, t),$$

since $w(0, t) = 0$. Computing this derivative using (4.22) and including the formulas for the integral averages (see [Appendix A](#)), we find

$$u(0, t) = t \int_{S(0, ct)} \psi(\mathbf{y}) dS + \frac{\partial}{\partial t} \left\{ t \int_{S(0, ct)} \phi(\mathbf{y}) dS \right\}.$$

5. Finally, we observe that by translation invariance, the corresponding formula applies by centering the spheres at any point $\mathbf{x} \in \mathbb{R}^3$:

$$u(\mathbf{x}, t) = t \int_{S(\mathbf{x}, ct)} \psi(\mathbf{y}) dS + \frac{\partial}{\partial t} \left\{ t \int_{S(\mathbf{x}, ct)} \phi(\mathbf{y}) dS \right\}. \quad (4.23)$$

Solution in the plane ($n = 2$). The formula (4.23) can be adapted to find the solution of the wave equation in two space dimensions. The idea is to consider solutions $v(x_1, x_2, t) = u(x_1, x_2, x_3, t)$ that are independent of x_3 . Then v satisfies the wave equation in two dimensions and in three dimensions. Since initial data ϕ, ψ are in two dimensions, we consider them as functions of x_1, x_2, x_3 but independent of x_3 . Then we calculate the integrals in (4.23) by representing the spheres over the projections onto the $x_1 - x_2$ plane, which are disks. This process gives the formula

$$v(\mathbf{x}, t) = \frac{1}{2\pi c} \int_{B(\mathbf{x}, ct)} \frac{\psi(\mathbf{y})}{[c^2 t^2 - |\mathbf{x} - \mathbf{y}|^2]^{1/2}} d\mathbf{y} + \frac{\partial}{\partial t} \frac{1}{2\pi c} \int_{B(\mathbf{x}, ct)} \frac{\phi(\mathbf{y})}{[c^2 t^2 - |\mathbf{x} - \mathbf{y}|^2]^{1/2}} d\mathbf{y}. \quad (4.24)$$

Everything here is to be interpreted in two dimensions. Thus, $\mathbf{x} = (x_1, x_2)$, $\mathbf{y} = (y_1, y_2)$, $B(\mathbf{x}, ct)$ is the two-dimensional disk centered at \mathbf{x} , and with radius ct , and $d\mathbf{y} = dy_1 dy_2$.

Because of the way (4.24) in two dimensions is related to (4.23) in three dimensions, it is not surprising that the integrals are over the disks $B(\mathbf{x}, ct)$. However, this has a profound consequence, because now the solution depends on values of ϕ and ψ inside the disk $B(\mathbf{x}, ct)$, in contrast to the three-dimensional case, in which the dependence is only on values of the data on the expanding sphere $S(\mathbf{x}, ct)$. Thus, the Huygens principle does not hold in two dimensions. For example, waves generated by dropping a stone into the flat surface of a body of water generates not just a circular expanding wave, but also lots of concentric ripples behind the leading wave.

PROBLEMS

1. Consider the initial value problem

$$\begin{aligned} u_{tt} &= u_{xx}, & -\infty < x < \infty, & t > 0, \\ u(x, 0) &= \phi(x), & -\infty < x < \infty, \\ u_t(x, 0) &= \psi(x), & -\infty < x < \infty. \end{aligned}$$

Let $\phi(x)$ be the function with graph shown in Figure 4.4, and $\psi(x) \equiv 0$. In the x - t plane representation of the solution in Figure 4.5, we find $u \equiv 0$ in the middle section, with $t > \frac{1}{2}$. Show that if we keep the same ϕ but make ψ nonzero, with

supp $\psi = [1, 3]$, then u will still be constant in this middle section. Find a condition on ψ that is necessary and sufficient to make this constant zero.

2. Consider C^3 solutions of the wave equation

$$u_{tt} = c^2 u_{xx}. \quad (4.25)$$

For $c = 1$, define the energy density $e = \frac{1}{2}(u_t^2 + u_x^2)$, and let $p = u_t u_x$ (the momentum density).

(a) Show that $e_t = p_x$, $p_t = e_x$.

(b) Conclude that both e and p satisfy the wave equation.

3. Suppose $u(x, t)$ satisfies the wave equation (4.25). Show that:

(a) For each $y \in \mathbb{R}$, the function $u(x - y, t)$ also satisfies (4.25).

(b) Both u_x and u_t satisfy (4.25).

(c) For any $a > 0$, the function $u(ax, at)$ satisfies (4.25). Note that the restriction $a > 0$ is not necessary.

4. (a) Let $u(x, t)$ be a solution of the wave equation (4.25) with $c = 1$, valid for all x, t . Prove that for all x, t, h, k ,

$$u(x + h, t + k) + u(x - h, t - k) = u(x + k, t + h) + u(x - k, t - h).$$

(b) Write a corresponding identity if u satisfies (4.25) with $c = 2$.

5. Consider the quarter-plane problem

$$\begin{aligned} u_{tt} &= 4u_{xx}, & x > 0, & t > 0, \\ u(0, t) &= 0, & t > 0, \\ u(x, 0) &= \phi(x), & x > 0, \\ u_t(x, 0) &= \psi(x), & x > 0. \end{aligned}$$

Let $\phi(x)$ be the function with graph shown in Figure 4.4, and let $\psi(x) \equiv 0$. Sketch the solution $u(x, t)$ as a function of x for $t = \frac{1}{4}, \frac{3}{8}, \frac{1}{2}, 1, 2$.

6. Consider the quarter-plane problem with a homogeneous Neumann boundary condition

$$\begin{aligned} u_{tt} &= u_{xx}, \\ u_x(0, t) &= 0, & t > 0, \\ u(x, 0) &= \phi(x), & x > 0, \\ u_t(x, 0) &= \psi(x), & x > 0. \end{aligned}$$

Suppose supp $\phi = [1, 2] = \text{supp } \psi$.

(a) Solve for $u(x, t)$, $x \geq 0$, $t > 0$.

(b) Where can you guarantee $u = 0$ in the first quadrant of the x - t plane?

(c) Consider $\phi \equiv 0$; write a formula for u .

(d) If 0 is in the support of ϕ or ψ (e.g., if $\lim_{x \rightarrow 0^+} \phi(x) \neq 0$), write conditions that guarantee u is (a) continuous and (b) C^1 . Explain your answers in terms of the behavior of the data around the boundary of the domain. (Any compatibility condition will be effectively at the origin, but you will need to match u , u_x , and u_t across $x = t$.)

7. Consider [problem 6](#), but in the more general case in which $u_x(0, t) = h(t)$ is not identically zero. Here, the general solution can be employed with the boundary condition to find $F(\xi)$ for $\xi < 0$ in terms of $G(-\xi)$ and h . Using this approach, derive the solution

$$u(x, t) = - \int_0^{t-x} h(y) dy + \frac{1}{2} (\phi(x+t) + \phi(t-x)) + \frac{1}{2} \int_{t-x}^{x+t} \psi(y) dy$$

for $x < t$. Derive a suitable compatibility condition at the origin that ensures the solution is continuous when the data are continuous. What about the first derivatives across $x = t$?

8. Consider the wave equation that includes frictional damping:

$$u_{tt} + \mu u_t = c^2 u_{xx},$$

in which $\mu > 0$ is a damping constant. Show that if $u(x, t)$ is a C^2 solution with $u_x \rightarrow 0$ as $x \rightarrow \infty$, then the total energy $E(t) = \int_{-\infty}^{\infty} \frac{1}{2}(u_t^2 + c^2 u_x^2) dx$ is a decreasing function.

Incidentally, can you devise a C^2 function $f(x)$ with the property $f(x)$ approaches a constant as $x \rightarrow \pm \infty$, but $f'(x)$ does not approach zero?

9. Consider the quarter-plane problem [\(4.15\)](#).

(a) Formulate the mechanical energy $E(t)$ for solutions, and show that it is conserved. Specify any assumptions you need on the initial data.

(b) For the nonzero boundary conditions [\(4.18\)](#) of [Example 3](#) evaluate $E'(t)$ in terms of the data ϕ , ψ , h .

10. Let $f(x, t)$ be a continuous function, and let $\Delta(x, t)$ denote the domain of dependence of the point (x, t) for [\(4.25\)](#). Use the Fundamental Theorem of Calculus to show directly that $u(x, t) = \frac{1}{2c} \int \int_{\Delta(x,t)} f(y, \tau) dy d\tau$ satisfies

$$u_{tt} = c^2 u_{xx} + f(x, t), \quad u(x, 0) = 0 = u_t(x, 0).$$

11. Consider the wave equation in three dimensions, with initial conditions in which $\phi(\mathbf{x}) = f(|\mathbf{x}|)$ is rotationally symmetric, the function f satisfies $f(r) = 0$, $r \geq \epsilon$, and $\psi \equiv 0$. Show that the solution $u(\mathbf{x}, t)$ is (a) rotationally symmetric, and (b) zero outside a circular strip centered at the origin and having width ϵ .

1. Jean le Rond d'Alembert (1717–1783).

2. Since the constant density ρ has been absorbed into c^2 , the physical energy is actually $\rho E(t)$.

The Heat Equation

The heat equation

$$u_t = k\Delta u$$

is the prototype of parabolic PDE and models diffusion processes, including heat flow and the spread of a solute in a fluid. The heat equation also plays a significant role in models of combustion, fluid flow with temperature dependence (for example, when density depends on temperature), and population dynamics. In chemical and biological systems, diffusive processes are commonly modeled by random walks and Brownian motion, which are closely related to the heat equation.

The heat equation has the remarkable property that even for rough initial data, solutions are immediately smoothed. This property is in contrast to hyperbolic equations, such as the wave equation, for which rough initial data remains just as rough through its evolution. Solutions of the heat equation also exhibit infinite propagation speed, meaning that a change in temperature in one location is immediately detected everywhere. (But the effect decays exponentially with distance from the source of the change.) Since characteristics are defined only for hyperbolic equations, the method of characteristics does not apply to the heat equation. Instead, we introduce several new PDE techniques that are applicable in general to linear PDE.

The fundamental solution lies at the heart of the theory of infinite domain problems. On bounded domains, the fundamental solution is adapted to take account of boundary conditions. The adapted functions are called *Green's functions*.

The maximum principle applies to the heat equation on domains bounded in space and time. This important property of parabolic equations is used to prove a variety of results, such as uniqueness of solutions and comparison principles.

The energy method for the heat equation has a few key differences from the method for the wave equation. For example, the physical heat energy is not very useful, and instead we introduce a mathematical energy function. Typically, this energy is not conserved and decays in time. The decay of the energy leads to straightforward uniqueness results, just as for the wave equation. The energy decay is also useful for obtaining estimates that are part of the existence and regularity theory for solutions of parabolic equations.

Separation of variables is a procedure for solving certain initial boundary value problems. The procedure is straightforward for the heat equation, and with small modifications it also applies to the wave equation and Laplace's equation. The method yields solutions represented as infinite series of eigenfunctions associated with the PDE and boundary conditions. We first demonstrate the technique on specific examples. More generally, in the next chapter we analyze eigenvalue problems for ODE and PDE, and the convergence of Fourier series.

5.1. The Fundamental Solution

The fundamental solution is important for problems on infinite domains. In this section we define the fundamental solution $\Phi(x, t)$ and show how it is used to solve the *Cauchy problem*:

$$\begin{aligned} u_t &= ku_{xx}, & -\infty < x < \infty, & t > 0, \\ u(x, 0) &= g(x), & -\infty < x < \infty. \end{aligned}$$

To derive the fundamental solution, we use the scale invariance property of the heat equation. Let $a > 0$ be a constant and introduce the change of variables $\bar{t} = a^2t, \bar{x} = ax$. Then the heat equation is unchanged but is expressed in the new variables:

$$u_{\bar{t}} = ku_{\bar{x}\bar{x}}.$$

This scale invariance suggests that we seek solutions of the self-similar form

$$u(x, t) = t^\alpha v\left(\frac{x}{\sqrt{t}}\right)$$

for some $\alpha \in \mathbb{R}$. Substituting into the heat equation, we see that whatever the value of α , the function v satisfies an ODE with nonconstant coefficients:

$$kv''(y) + \frac{1}{2}yv'(y) + \frac{1}{2}v(y) = 0, \quad \text{where } y = \frac{x}{\sqrt{t}}. \quad (5.1)$$

To select α , we introduce the property of conservation of heat energy, which we wish to have satisfied by our solution. Suppose u is a solution of the heat equation with the property that $|\int_{-\infty}^{\infty} u(x, 0) dx| < \infty$, and $u_x(x, t) \rightarrow 0$ as $x \rightarrow \pm \infty$. Then, integrating the PDE, we find

$$\frac{d}{dt} \int_{-\infty}^{\infty} u(x, t) dx = 0,$$

so that the total heat energy is conserved:

$$\int_{-\infty}^{\infty} u(x, t) dx = \text{const}. \quad (5.2)$$

However,

$$\int_{-\infty}^{\infty} v\left(\frac{x}{\sqrt{t}}\right) dx = t^{\frac{1}{2}} \int_{-\infty}^{\infty} v(y) dy,$$

which suggests we should scale the function v by $t^{-\frac{1}{2}}$:

$$u(x, t) = \frac{1}{\sqrt{t}} v\left(\frac{x}{\sqrt{t}}\right), \quad (5.3)$$

that is, choose $\alpha = -\frac{1}{2}$. With this scaling, heat is conserved in the sense of (5.2).

Now we solve (5.1). Since it is a second-order equation, there will be two independent solutions. First rewrite the ODE as

$$kv''(y) + \frac{1}{2}(y v(y))' = 0.$$

Thus,

$$kv'(y) + \frac{1}{2}y v(y) = \text{const.}$$

Since we are really only seeking one solution, it is convenient to set the constant to zero, resulting in a homogeneous first-order equation that has general solution

$$v(y) = Ae^{-\frac{y^2}{4k}}.$$

Converting back to (x, t) , with $y = \frac{x}{\sqrt{t}}$, we obtain the similarity solution

$$u(x, t) = A \frac{1}{\sqrt{t}} e^{-\frac{x^2}{4kt}}. \quad (5.4)$$

Usually, we choose a particular value of A so that the constant in (5.2) is one; for this choice of constant, we have the *fundamental solution* of the heat equation:

$$\Phi(x, t) = \frac{1}{\sqrt{4\pi kt}} e^{-\frac{x^2}{4kt}}$$

(see Fig. 5.1). In higher dimensions, $\mathbf{x} \in \mathbb{R}^n$, the fundamental solution takes a similar form:

$$\Phi(\mathbf{x}, t) = \frac{1}{(4\pi kt)^{n/2}} e^{-|\mathbf{x}|^2/(4kt)}.$$

Then $u(\mathbf{x}, t) = \Phi(\mathbf{x}, t)$ satisfies $u_t = k\Delta u$.

Properties of the fundamental solution $\Phi(\mathbf{x}, t)$.

1. $\Phi(\mathbf{x}, t) > 0$ for all $\mathbf{x} \in \mathbb{R}^n$, $t > 0$.

2. Φ is C^∞ in (\mathbf{x}, t) , $t > 0$.
3. $\int_{\mathbb{R}^n} \Phi(\mathbf{x}, t) d\mathbf{x} = 1$ for all $t > 0$.

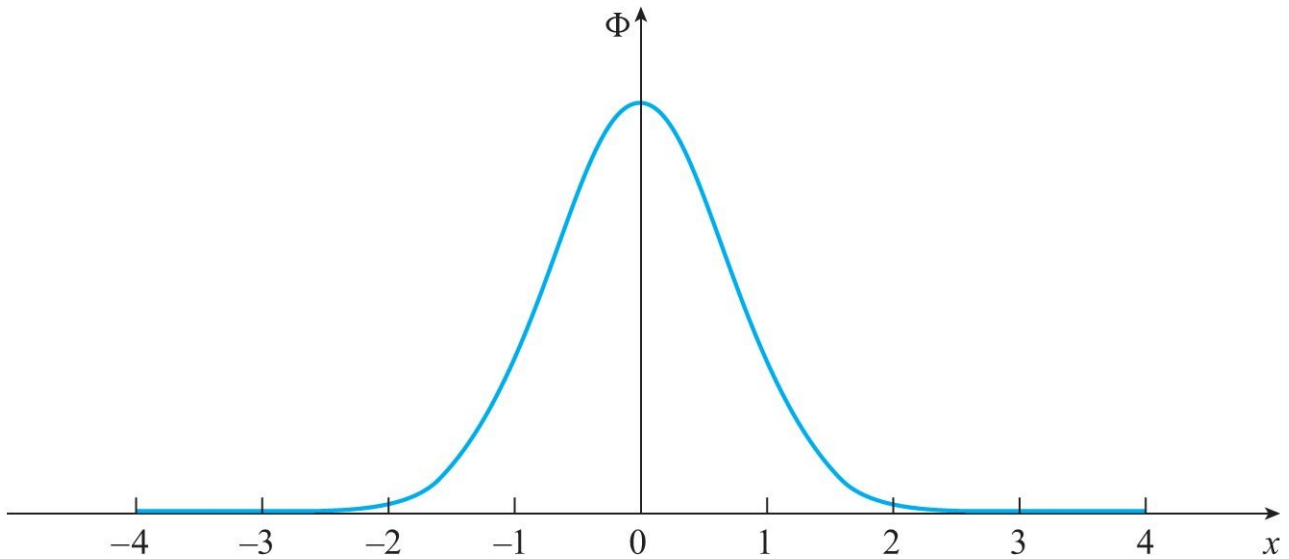

Figure 5.1. Graph of the fundamental solution $\Phi(x, t)$ for the heat equation, with $t > 0$.

Properties 1 and 2 follow directly from the formula for the fundamental solution. For $n = 1$, property 3 is verified by direct calculation:

$$\begin{aligned} \int_{-\infty}^{\infty} \Phi(x, t) dx &= \frac{1}{\sqrt{4\pi kt}} \int_{-\infty}^{\infty} e^{-\frac{x^2}{4kt}} dx \\ &= \frac{1}{\sqrt{\pi}} \int_{-\infty}^{\infty} e^{-y^2} dy \quad \left(\text{let } y = \frac{x}{\sqrt{4kt}}, \quad dy = \frac{dx}{\sqrt{4kt}} \right) \\ &= 1. \end{aligned}$$

For $n > 1$, property 3 follows from $e^{-|y|^2} = e^{-y_1^2} e^{-y_2^2} \dots e^{-y_n^2}$.

From properties 1 and 3, we see that $\Phi(x, t)$ is a probability distribution. In fact Φ is a normal distribution for each $t > 0$ with interesting dependence on t in the limits $t \rightarrow \infty$ and $t \rightarrow 0$. The area under the graph is 1 for all $t > 0$, yet as $t \rightarrow \infty$, $\max_x \Phi(x, t) \rightarrow 0$; the tail spreads out to maintain $\int \Phi = 1$. As $t \rightarrow 0$ the maximum (at $x = 0$) blows up like $\frac{1}{\sqrt{t}}$, but the integral remains constant. We also observe $\Phi(x, t) \rightarrow 0$ for $x \neq 0$, as $t \rightarrow 0^+$.

5.2. The Cauchy Problem for the Heat Equation

We are now ready to solve the Cauchy problem

$$u_t = ku_{xx}, \quad -\infty < x < \infty, \quad t > 0, \quad (5.5a)$$

$$u(x, 0) = g(x), \quad -\infty < x < \infty, \quad (5.5b)$$

using the fundamental solution

$$\Phi(x, t) = \frac{1}{\sqrt{4\pi kt}} e^{-\frac{x^2}{4kt}},$$

which satisfies (5.5a) for $t > 0$.

By translation invariance, $\Phi(x - y, t)$ is a solution of (5.5a) for all y . Thus,

$$\Phi(x - y, t)g(y)$$

is also a solution of (5.5a).

By linearity and homogeneity of the PDE, we can take linear combinations of solutions, which suggests that

$$u(x, t) = \int_{-\infty}^{\infty} \Phi(x - y, t)g(y)dy \quad (5.6)$$

should be a solution. Moreover, properties of Φ suggest that as $t \rightarrow 0^+$, $u(x, t) \rightarrow g(x)$, since $\Phi(x - y, t)$ collapses to zero away from $y = x$ and blows up at $y = x$ while preserving $\int \Phi = 1$.

Because of the exponential in $\Phi(x, t)$, the integrals for u , u_t , u_{xx} all converge for $t > 0$ provided $g \in C(\mathbb{R})$ is bounded. Then

$$u_t = \int_{-\infty}^{\infty} \frac{\partial \Phi}{\partial t}(x - y, t)g(y) dy, \quad u_{xx} = \int_{-\infty}^{\infty} \frac{\partial^2 \Phi}{\partial x^2}(x - y, t)g(y) dy,$$

so that u satisfies the PDE for $t > 0$.

It is more complicated to prove rigorously that the initial condition (5.5b) is satisfied, since $t = 0$ is a singular point for Φ (in that $\Phi(x, t)$ is not defined at $t = 0$). To get a rough idea of how (5.5b) holds as a limit as $t \rightarrow 0^+$, let's fix x . Then, for $\delta > 0$,

$$\begin{aligned} & \int_{-\infty}^{\infty} \Phi(x - y, t)g(y)dy \\ &= \int_{|x-y|<\delta} \Phi(x - y, t)g(y)dy + \int_{|x-y|>\delta} \Phi(x - y, t)g(y)dy \\ &\approx \int_{|x-y|<\delta} \Phi(x - y, t)g(x)dy. \end{aligned}$$

The second line has two integrals. In the first integral, $g(y) \approx g(x)$ for small δ since g is continuous. The second integral approaches zero as $t \rightarrow 0^+$, because $\Phi \rightarrow 0$ uniformly and exponentially away from $y = x$ as $t \rightarrow 0^+$. In the following theorem we state this limit carefully and prove it by estimating the integrals. The final integral gives $g(x)$, since it is independent of y , and the integral of Φ over a small interval around $y = x$ becomes unity as $t \rightarrow 0^+$, since Φ approaches zero

sufficiently fast elsewhere.

Theorem 5.1. *Let $g \in C(\mathbb{R})$ be bounded, and let $u(x, t)$ be given by (5.6). Then*

1. u is C^∞ in (x, t) for $t > 0$; and
2. u satisfies the heat equation $u_t = ku_{xx}$, $x \in \mathbb{R}$, $t > 0$; and
- 3 $\lim_{(x, t) \rightarrow (x_0, 0^+)} u(x, t) = g(x_0)$ for all $x_0 \in \mathbb{R}$.

Proof. Property 1 follows because Φ is C^∞ for $t > 0$, and since derivatives of Φ all decay exponentially as $|x| \rightarrow \infty$, the integrals converge. Property 2 follows from $\Phi_t = k\Phi_{xx}$, $t > 0$.

To prove property 3, we consider the difference $|u(x, t) - g(x_0)|$, and estimate the integrals, guided by the discussion above. This is the first time we have encountered these kinds of estimates, so we provide the details.

Let $\epsilon > 0$. We wish to show $|u(x, t) - g(x_0)| < \epsilon$ for (x, t) close to $(x_0, 0)$. Since $\int \Phi dx = 1$, we can express the number $g(x_0)$ as an integral, so that

$$|u(x, t) - g(x_0)| = \left| \int_{-\infty}^{\infty} \Phi(x - y, t)(g(y) - g(x_0)) dy \right|. \quad (5.7)$$

Let $\delta > 0$ (we choose δ below), break up the integrals in (5.7), and use the triangle inequality:

$$\begin{aligned} |u(x, t) - g(x_0)| &\leq \left| \int_{|x_0 - y| < \delta} \Phi(x - y, t)(g(y) - g(x_0)) dy \right| \\ &\quad + \left| \int_{|x_0 - y| \geq \delta} \Phi(x - y, t)(g(y) - g(x_0)) dy \right|. \end{aligned} \quad (5.8)$$

Now we use δ in two ways to show the two integrals are small.

In the first integral, by continuity of g we can choose $\delta > 0$ small enough that $|g(y) - g(x_0)| < \epsilon$ for $|x_0 - y| < \delta$, which is the domain of the integral. We are left with an integral of $\Phi(x - y, t)$, which is bounded uniformly by 1, even though $\Phi(x - y, t)$ blows up as $t \rightarrow 0$.

In the second integral we observe that $\int_{|x_0 - y| \geq \delta} \Phi(x - y, t) dy \rightarrow 0$ as $t \rightarrow 0$, provided $|x - x_0| < \frac{\delta}{2}$, while $g(y)$ is bounded. To make this observation more precise, we write the right-hand side of (5.8) as $I_\delta + J_\delta$. Choose $\delta > 0$ so that $|g(y) - g(x_0)| < \epsilon$ for $|y - x_0| < \delta$. Then

$$\begin{aligned}
I_\delta &\leq \int_{|x_0-y|<\delta} \Phi(x-y, t) |g(y) - g(x_0)| dy \\
&\leq \epsilon \int_{|x_0-y|<\delta} \Phi(x-y, t) dy \leq \epsilon.
\end{aligned}$$

The integral J_δ is somewhat trickier. Since g is bounded, there is $K > 0$ such that $|g(y)| \leq K$, for all y . Thus,

$$\begin{aligned}
J_\delta &\leq \int_{|x_0-y|\geq\delta} \Phi(x-y, t) |g(y) - g(x_0)| dy \\
&\leq 2K \int_{|x_0-y|\geq\delta} \frac{1}{\sqrt{4\pi kt}} e^{-\frac{(x-y)^2}{4kt}} dy.
\end{aligned}$$

Consider x satisfying $|x - x_0| < \frac{\delta}{2}$. (Recall that we are considering the limit as $x \rightarrow x_0$.) Then $|x - y| > \frac{\delta}{2}$ in the range of integration $|x_0 - y| > \delta$. However, this is not a good enough estimate of the exponential, because we would still be left with an integral over an infinite interval of a small but positive quantity. To get a more useful estimate, we observe (see [Problem 1](#)) that in the region of integration, $|x - y| \geq \frac{1}{2}|y - x_0|$. Then

$$\begin{aligned}
J_\delta &\leq \frac{K}{\sqrt{\pi k}} \int_{|x_0-y|\geq\delta} \frac{1}{\sqrt{t}} e^{-\frac{(x_0-y)^2}{16kt}} dy \\
&\leq C \int_{|z|\geq\frac{\delta}{4\sqrt{kt}}} e^{-z^2} dz < \epsilon
\end{aligned}$$

for $t > 0$ sufficiently small. Here we have used the change of variables $z = (y - x_0)/(4\sqrt{kt})$ and the constant $C = 4K/\sqrt{\pi}$. Now it follows that $|u(x, t) - g(x_0)| < 2\epsilon$ for $|x - x_0| < \frac{\delta}{2}$, $t > 0$ sufficiently small. This proves property 3 and completes the proof of the theorem. ■

The solution (5.6) is a *convolution* $(\Phi(\cdot, t) * g)(x)$ for each $t > 0$. For integrable functions ϕ, ψ on \mathbb{R} the convolution product of ϕ and ψ is a function $\phi * \psi$ defined by

$$\phi * \psi(x) = \int_{-\infty}^{\infty} \phi(x-y)\psi(y) dy.$$

The convolution product provides a useful construction of the product of two integrable functions. It is used widely in signal processing and Fourier analysis. Property 3 of the theorem shows that $\Phi(\cdot, t) * g \rightarrow g$ as $t \rightarrow 0$. In this sense, the functions $\Phi(\cdot, t)$ converge as $t \rightarrow 0$ to a *generalized function* δ defined informally

by

$$(\delta * g)(x) = \int_{\mathbb{R}} \delta(x - y)g(y) dy = g(x).$$

We make this precise in [Chapter 9](#), where δ is defined as *the Dirac delta function*, a distribution.

Recall that for first-order equations and for the wave equation, solutions propagate with finite speed, meaning that the region of influence of any point is bounded over finite time. However, the heat equation has the property, typical of parabolic equations, that solutions propagate with infinite speed: the region of influence of a point is immediately all of space.

To make this concept a bit more precise, consider an initial temperature distribution $u(x, 0) = g(x)$ that is nonnegative and has compact support (see [Appendix A](#)). An example is the function $g(x) = \phi(x)$ in [Figure 4.4](#) that we considered for the wave equation. For the wave equation, such an initial disturbance propagates with finite speed, the wave speed. But for the heat equation, the solution $u(x, t)$ is immediately positive everywhere, meaning that for all $t > 0$, no matter how small, $u(x, t) > 0$ for all $x \in \mathbb{R}$. You can see this directly from the solution (5.6). Thus, the initial data, confined to a bounded set, has induced a positive temperature everywhere immediately. Of course, the temperature drops off exponentially with distance from the support of g and is tiny outside the support for small t , but nonetheless, the initial temperature distribution has propagated with infinite speed.

This is pretty clearly not physical (we cannot have signals propagating faster than the speed of light!) and is a limitation of the heat equation, and in particular of Fourier's law of heat transfer. From a different point of view, it is a consequence of taking a finite speed effect, namely, the exchange of thermal energy between molecules, and describing the process in a continuum in a seemingly natural way that introduces this anomaly. Nonetheless, the heat equation is an extremely useful PDE that describes heat transfer accurately in many situations.

5.2.1. Using the Fundamental Solution to Solve Quarter-Plane Problems

To introduce a boundary condition, consider the *quarter-plane* problem

$$u_t = ku_{xx}, \quad x > 0, \quad t > 0, \quad (5.9a)$$

$$u(0, t) = 0, \quad t > 0, \quad (5.9b)$$

$$u(x, 0) = g(x), \quad x > 0. \quad (5.9c)$$

As in the strategy for the wave equation, we reflect the initial data, so the solution satisfies the boundary condition. Let $\tilde{g}(x)$ be the odd extension of $g(x)$:

$$\tilde{g}(x) = \begin{cases} g(x), & x > 0, \\ -g(-x), & x < 0, \end{cases}$$

and define

$$u(x, t) = \int_{-\infty}^{\infty} \Phi(x - y, t) \tilde{g}(y) dy. \quad (5.10)$$

Then

$$\begin{aligned} u_t &= ku_{xx}, \\ u(x, 0) &= \tilde{g}(x) = g(x), \quad x > 0, \\ u(0, t) &= \int_{-\infty}^{\infty} \Phi(-y, t) \tilde{g}(y) dy = 0, \quad t > 0, \end{aligned}$$

since $\Phi(y, t)$ is an even function of y , and \tilde{g} is an odd function. Note that $u(x, t)$ is an odd function of $x \in \mathbb{R}$. That is, the symmetry in the initial data is carried through to the same symmetry in the solution.

Now replace $\tilde{g}(y)$ with $g(y)$ using $\tilde{g}(y) = -g(-y)$ for $y < 0$. Then

$$\begin{aligned} u(x, t) &= \int_0^{\infty} \Phi(x - y, t) g(y) dy + \int_{-\infty}^0 \Phi(x - y, t) (-g(-y)) dy \\ &= \int_0^{\infty} (\Phi(x - y, t) - \Phi(x + y, t)) g(y) dy. \end{aligned}$$

For a quarter-plane problem with a homogeneous Neumann boundary condition, corresponding to an insulated end at $x = 0$, the calculation involves the even extension of the initial data:

$$\begin{aligned} u_t &= ku_{xx}, \quad x > 0, \quad t > 0, \\ u_x(0, t) &= 0, \\ u(x, 0) &= g(x), \quad x > 0. \end{aligned}$$

The solution is obtained by extending g using the even extension \hat{g} , so that the first derivative is zero at $x = 0$. Then

$$u(x, t) = \int_0^{\infty} (\Phi(x - y, t) + \Phi(x + y, t)) g(y) dy$$

satisfies the heat equation. To check the boundary condition, we calculate $u_x(0, t) = \int_0^{\infty} (\Phi_x(-y, t) + \Phi_x(y, t)) g(y) dy$. Now $\Phi(y, t)$ is even in y , so $\Phi_x(y, t)$ is odd. Thus, $u_x(0, t) = 0$, as required.

5.3. The Energy Method

In this section we show the sense in which heat energy is conserved on both bounded and unbounded domains. The function $H(t) = \int u(x, t) dx$ is proportional to the *physical* heat energy when $u(x, t)$ is the temperature distribution. We also consider a mathematical energy integral $E(t) = \int u^2(x, t) dx$, which is useful for the heat equation, just as the mechanical energy was for the wave equation. The treatment of energy integrals is very significant for the study of PDE, especially nonlinear PDE, where estimates of mathematical energies help establish existence and uniqueness.

Consider a C^2 solution $u(x, t)$ of the heat equation on a bounded interval:

$$u_t = ku_{xx}, \quad a \leq x \leq b, \quad t > 0. \quad (5.11)$$

The heat energy $H(t) = \int_a^b u(x, t) dx$ satisfies

$$H'(t) = \int u_t(x, t) dx = \int_a^b ku_{xx} dx = ku_x(x, t) \Big|_a^b.$$

Thus, the evolution of heat energy is controlled by the heat flux $-ku_x$ through the ends $x = a, b$. If the ends are insulated, then $u_x = 0$ there, and the heat energy is constant.

On an unbounded domain, the calculation works similarly, except it is natural to assume there is no heat loss at infinity and that the temperature $u(x, t)$ is integrable as well as smooth. Suppose $u_t = ku_{xx}$, $-\infty < x < \infty$, $t > 0$. Let $H(t) = \int_{-\infty}^{\infty} u(x, t) dx$. Then

$$H'(t) = \int_{-\infty}^{\infty} ku_{xx} dx = ku_x(x, t) \Big|_{-\infty}^{\infty} = 0.$$

To analyze the mathematical energy $E(t) = \int \frac{1}{2}u^2(x, t) dx$, we multiply (5.11) by u and integrate over $[a, b]$:

$$\int_a^b uu_t dx = k \int_a^b uu_{xx} dx.$$

Therefore,

$$\frac{d}{dt} \int_a^b \frac{1}{2}u^2 dx = kuu_x \Big|_a^b - k \int_a^b u_x^2 dx.$$

Thus, the energy integral $E(t) = \int_a^b \frac{1}{2}u^2(x, t) dx$ is decreasing in time t if $uu_x \Big|_a^b \leq 0$. For example, if either u or u_x is zero at each end point $x = a, x = b$, then the energy integral $E(t)$ decreases in t . In this case, we have the important comparison to the

initial data:

$$E(t) \leq E(0), \quad t > 0. \quad (5.12)$$

That is,

$$\int_a^b u^2(x, t) dx \leq \int_a^b u^2(x, 0) dx, \quad t > 0. \quad (5.13)$$

On an infinite domain, we assume the solution $u(x, t)$ is square integrable, so that $E(t) = \int_{-\infty}^{\infty} \frac{1}{2} u^2(x, t) dx$ is defined. Then, since it is reasonable to assume $u(x, t) \rightarrow 0$ as $x \rightarrow \pm \infty$, and u_x is bounded in x , we obtain $E'(t) \leq 0$. Once again the energy is decreasing, and we have the comparison (5.12) to the initial energy.

5.3.1. Using the Energy Method to Prove Uniqueness

Decay of the mathematical energy allows us to prove uniqueness of solutions of the initial boundary value problem

$$\begin{aligned} u_t &= k u_{xx} + f(x, t), \quad 0 < x < L, \quad t > 0, \\ u(0, t) &= g(t), \quad u(L, t) = h(t), \quad t > 0, \\ u(x, 0) &= \phi(x), \quad 0 < x < L, \end{aligned} \quad (5.14)$$

where f, g, h, ϕ are given functions. Because the following result and proof are very similar to the uniqueness argument for the wave equation, we demonstrate the method for the initial boundary value problem rather than for the Cauchy problem.

Theorem 5.2. *If u_1, u_2 solve (5.14) and are C^2 functions, then $u_1 = u_2$ everywhere.*

Proof. Let $u = u_1 - u_2$. Then u satisfies (5.14) with zero data: $f \equiv g \equiv h \equiv \phi \equiv 0$. Thus, from (5.13),

$$0 \leq \int_0^L (u(x, t))^2 dx \leq \int_0^L u(x, 0)^2 dx = 0.$$

Therefore, $u \equiv 0$, so that $u_1 \equiv u_2$. ■

5.3.2. The Energy Principle in Higher Dimensions

The same argument works in the more realistic context of higher dimensions but uses multivariable calculus. Consider a bounded open subset U of \mathbb{R}^n and the initial boundary value problem

$$\begin{aligned} u_t &= k \Delta u, \quad \mathbf{x} \in U \quad t > 0, \\ u(\mathbf{x}, t) &= 0, \quad \mathbf{x} \in \partial U, \quad t > 0, \\ u(\mathbf{x}, 0) &= \phi(\mathbf{x}), \quad \mathbf{x} \in U. \end{aligned}$$

We begin by defining the energy integral as in one dimension:

$$E(t) = \frac{1}{2} \int_U u(\mathbf{x}, t)^2 d\mathbf{x}.$$

Then

$$\begin{aligned} E'(t) &= \int_U uu_t d\mathbf{x} = k \int_U u\Delta u d\mathbf{x} \\ &= k \int_{\partial U} u\nabla u \cdot \mathbf{n} dS - k \int_U \nabla u \cdot \nabla u d\mathbf{x} \\ &= -k \int_U |\nabla u|^2 d\mathbf{x} \leq 0. \end{aligned}$$

In conclusion, the mathematical energy $E(t)$ decreases in time unless the boundary conditions inject energy into U . In particular, with either homogeneous Dirichlet or Neumann boundary conditions, $E(t)$ is decreasing in time.

5.4. The Maximum Principle

Maximum principles provide a powerful alternative to the energy method for analyzing parabolic equations. We prove the maximum principle for the heat equation, noting that similar ideas apply to more general linear and nonlinear second-order parabolic equations, but not in general to systems of equations, nor to higher-order equations.

The maximum principle states that the maximum of any (smooth) solution of the heat equation occurs either initially (at $t = 0$) or on the boundary of the domain. For a time interval $[0, T]$ with $T > 0$ and a spatial domain $U \subset \mathbb{R}^n$, we use the notation $U_T = U \times (0, T]$, shown schematically in [Figure 5.2](#). Note that U_T includes both the interior and the *top* portion of the boundary $U \times \{t = T\}$. The part of the boundary of U_T defined by

$$\Gamma_T = \overline{U_T} - U_T = (\partial U \times [0, T]) \cup (U \times \{t = 0\})$$

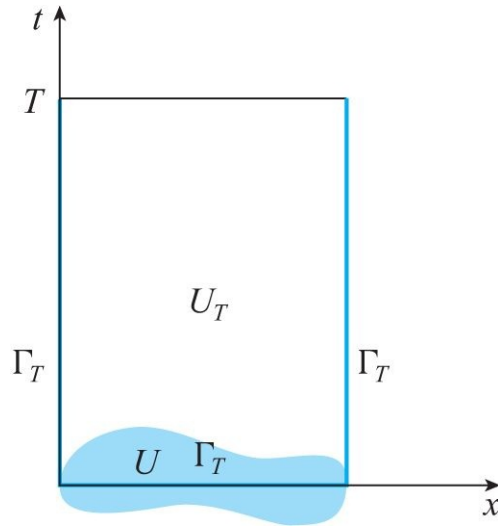

Figure 5.2. Domain U_T for the maximum principle.

is known as the *parabolic boundary*. Here, ∂U denotes the boundary of U . Solutions of the heat equation should have two spatial derivatives and one time derivative, so we define the appropriate space of functions on U_T :

$$C_1^2(U_T) = \{u = u(x, t) : u, u_t, \partial_j u, \partial_{ij}^2 u \in C(U_T), i, j = 1, \dots, n\}.$$

To compare values of u in U_T with values on the boundary, in the following theorem we require that u should be continuous on $\overline{U_T}$.

Theorem 5.3. (*The Maximum Principle*) Let $u \in C(\overline{U_T}) \cap C_1^2(U_T)$ satisfy

$$u_t = k\Delta u, \quad (\mathbf{x}, t) \in U_T.$$

Then $\max_{\overline{U_T}} u(\mathbf{x}, t) = \max_{\Gamma_T} u(\mathbf{x}, t)$.

Remarks. Suppose u has a local maximum at $(\mathbf{x}, t) \in U \times (0, T)$. Then (by calculus) $u_t = 0$, $\nabla_{\mathbf{x}} u = 0$ and $\Delta u \leq 0$. If we knew $\Delta u < 0$ at (\mathbf{x}, t) , then the PDE would immediately give us a contradiction:

$$0 = u_t = k\Delta u < 0.$$

Although this is not a proof, since we have to handle the degenerate case in which $\Delta u = 0$, it has the main idea. The actual proof merely perturbs u to remove a possibly degenerate maximum.

$\overline{U_T}$ is closed and bounded, so the continuous function u achieves its maximum somewhere in $\overline{U_T}$. That is, there is an (\mathbf{x}_0, t_0) such that $u(\mathbf{x}_0, t_0) = \max_{\overline{U_T}} u(\mathbf{x}, t)$.

Proof of Theorem 5.3. Let $M = \max_{\Gamma_T} u(\mathbf{x}, t)$. Our goal is to prove that $u(\mathbf{x}, t) \leq M$ for all $(\mathbf{x}, t) \in U_T$. To deal with the possibility $\Delta u = 0$ at a maximum, we perturb u a bit. Let $v(\mathbf{x}, t) = u(\mathbf{x}, t) + \epsilon|\mathbf{x}|^2$, $\epsilon > 0$. Then (recalling that $\mathbf{x} \in \mathbb{R}^n$),

$$v_t - k\Delta v = u_t - k\Delta u - 2k\epsilon < 0, \quad (5.15)$$

since $u_t - k\Delta u = 0$.

Suppose v has a local maximum in U_T , at $P_0 = (\mathbf{x}_0, t_0)$ with $t_0 < T$. Then $v_t = 0$, $\nabla v = 0$, and $\Delta v \leq 0$ at P_0 . But this contradicts (5.15), so v cannot have a maximum in the interior of U_T .

Now suppose v has a maximum on the line $t = T$, at $P_1 = (\mathbf{x}_1, t = T)$. Then $\nabla v = 0$, $\Delta v \leq 0$, and $v_t \geq 0$ at P_1 .¹ Now we have $v_t - k\Delta v \geq 0$, again contradicting (5.15).

Therefore the maximum of v on \overline{U}_T occurs on $\Gamma_T: v(\mathbf{x}, t) \leq \max_{(\mathbf{y}, t) \in \overline{\Gamma}_T} v(\mathbf{y}, t)$ for all $(\mathbf{x}, t) \in \overline{U}_T$. We have proved

$$u(\mathbf{x}, t) + \epsilon|\mathbf{x}|^2 \leq \max_{(\mathbf{y}, t) \in \Gamma_T} (u(\mathbf{y}, t) + \epsilon|\mathbf{y}|^2) \leq \max_{\Gamma_T} u + \epsilon C \quad \text{for all } (\mathbf{x}, t) \in \overline{U}_T,$$

where $C = \max_{\mathbf{y} \in \overline{U}} |\mathbf{y}|^2$. Thus,

$$\begin{aligned} u(\mathbf{x}, t) &\leq M + \epsilon(C - |\mathbf{x}|^2) \\ &\leq M + \epsilon C. \end{aligned}$$

Since $\epsilon > 0$ is arbitrary, we have $u(\mathbf{x}, t) \leq M$ for all $(\mathbf{x}, t) \in \overline{U}_T$. ■

Remarks. The weak maximum principle is easy to prove. The related *strong maximum principle* is somewhat harder to prove. The strong maximum principle states that, provided U is connected, the maximum of u is achieved *only* on the parabolic boundary, unless u is constant throughout \overline{U}_T [12].

By applying the maximum principle to $-u$, which also satisfies the conditions of Theorem 5.3, we see that there is a corresponding minimum principle:

$$\min_{\overline{U}_T} u(\mathbf{x}, t) = \min_{\Gamma_T} u(\mathbf{x}, t).$$

5.5. Duhamel's Principle for the Inhomogeneous Heat Equation

Duhamel's principle gives a formula for the solution of an inhomogeneous PDE using solutions of the homogeneous equation. For the heat equation on the whole real line, Duhamel's principle utilizes the fundamental solution.

Let $f(x, t)$ be a given function representing a heat source or sink, and consider the initial value problem

$$\begin{aligned} u_t &= ku_{xx} + f(x, t), \quad -\infty < x < \infty, \quad t > 0, \\ u(x, 0) &= 0, \quad -\infty < x < \infty. \end{aligned} \tag{5.16}$$

The fundamental solution $\Phi(x, t)$ of the homogeneous heat equation satisfies $u_t =$

ku_{xx} for $t > 0$. But then for any $y \in \mathbb{R}$ and $s > 0$, the shifted function $\Phi(x - y, t - s)$ satisfies the equation for $t > s$. We can multiply by an *amplitude* $f(y, s)$, so that we have a collection of solutions $\Phi(x - y, t - s)f(y, s)$ of the heat equation, with $y \in \mathbb{R}$ and $t > s$. Summing (i.e., integrating) these solutions over $y \in \mathbb{R}$ with s fixed, we have that

$$\tilde{u}(x, t; s) = \int_{-\infty}^{\infty} \Phi(x - y, t - s) f(y, s) dy$$

is a solution for all $t > s$, satisfying $\tilde{u}(x, t = s; s) = f(x, s)$.

Now the idea is to integrate $\tilde{u}(x, t; s)$ with respect to s from 0 to t . Define $u(x, t) = \int_0^t \tilde{u}(x, t, s) ds$. Then

$$\begin{aligned} u_t - ku_{xx} &= \tilde{u}(x, t; t) + \int_0^t (\tilde{u}_t(x, t; s) - k\tilde{u}_{xx}(x, t; s)) ds \\ &= f(x, t). \end{aligned}$$

In this calculation we differentiated under the integral sign, ignoring the singularity of $\Phi(x - y, t - s)$ at $x = y, t = s$ on the boundary of the domain of integration. However, this singularity can be handled with the appropriate limit, and the result is the same. (See Evans [12], p. 50 for the details.)

Finally, we observe

$$u(x, 0) = 0, \quad -\infty < x < \infty.$$

In summary, the formula

$$u(x, t) = \int_0^t \int_{-\infty}^{\infty} \Phi(x - y, t - s) f(y, s) dy ds$$

solves the initial value problem (5.16). General initial conditions can be incorporated easily, just as for the wave equation.

In this chapter, we have constructed solutions of initial value problems for the heat equation; derived some basic principles, such as the maximum principle; and examined certain properties, such as uniqueness of solutions. The solution of initial value problems is described using the fundamental solution of the heat equation, whereas for the wave equation, the solutions are given by propagating disturbances with waves, expressed through d'Alembert's solution. Using the two formulas, we can make some comparisons, which are a good guide to the differences between solutions of hyperbolic equations and those of parabolic equations.

Solutions of hyperbolic equations preserve the regularity of the initial data,

propagating disturbances and singularities along characteristics, which have finite speed. By contrast, solutions of the heat equation and other parabolic equations immediately smooth initial data, and information is propagated with infinite speed.

Nonlinear equations may have different properties. For example, the porous medium equation $u_t = \Delta(u^m)$ is degenerate at $u = 0$ for $m > 1$, a consequence being that initial data with compact support spread but with finite speed; the solution $u(\mathbf{x}, t)$ continues to have compact support for each time $t > 0$.

PROBLEMS

1. Fill in the following details used in the proof of [Theorem 5.1](#), property 3.

(a) Use the triangle inequality to prove that if $\delta > 0$, and $\mathbf{x}, \mathbf{x}_0, \mathbf{y} \in \mathbb{R}^n$ satisfy $|\mathbf{y} - \mathbf{x}_0| > \delta$, $|\mathbf{x} - \mathbf{x}_0| < \frac{\delta}{2}$, then $|\mathbf{x} - \mathbf{y}| > \frac{1}{2}|\mathbf{y} - \mathbf{x}_0|$. (Hint: Draw a picture in the one-dimensional case, $n = 1$, to visualize how the argument works.)

(b) Prove that $\lim_{a \rightarrow \infty} \int_a^\infty e^{-z^2} dz = 0$.

2. Show that $\Delta\phi(r, t) = \phi_{rr} + \frac{n-1}{r}\phi_r$. Consequently, the heat equation for rotationally symmetric functions $u(\mathbf{x}, t) = \phi(r, t)$, $r = |\mathbf{x}|$, is

$$\phi_t = k \left(\phi_{rr} + \frac{n-1}{r}\phi_r \right).$$

3. (a) Let $g : [0, \infty) \rightarrow \mathbb{R}$ be a bounded integrable function. Prove directly that

$$u(x, t) = \int_0^\infty (\Phi(x - y, t) - \Phi(x + y, t))g(y)dy$$

is an odd function of $x \in \mathbb{R}$ for each $t > 0$.

(b) Let $h : \mathbb{R} \rightarrow \mathbb{R}$ be an odd bounded integrable function. Prove that

$$u(x, t) = \int_{-\infty}^\infty \Phi(x - y, t)h(y)dy$$

is an odd function of $x \in \mathbb{R}$ for each $t > 0$. That is, the symmetry in the initial data is carried through to the same symmetry in the solution.

4. Write the solution of the Cauchy problem for the heat equation

$$u_t = ku_{xx}, \quad -\infty < x < \infty, \quad t > 0, \quad (5.17)$$

with initial condition $u(x, 0) = \frac{1}{2}(H(x+1) - H(1-x))$ in terms of the error function

$$\operatorname{Erf}(x) = \frac{2}{\sqrt{\pi}} \int_0^x e^{-y^2} dy.$$

5. Solve the heat equation (5.17) with initial condition $u(x, 0) = e^{px}$, where $p > 0$ is a constant. You can use the identity $\int_{-\infty}^{\infty} e^{-x^2} dx = \sqrt{\pi}$.
6. Solve the heat equation (5.17) with initial condition $u(x, 0) = H(x)e^{-x}$.
7. Prove the energy inequality for $u_t = \nabla \cdot (k(\mathbf{x}, u)\nabla u)$, where $k = k(\mathbf{x}, u) \in \mathbb{R}$ is a given positive function.
8. Consider the Cauchy problem for (5.17), with initial condition $u(x, 0) = x^2$.
- (a) Show that if $u(x, t)$ is the solution, then $v(x, t) = u_{xxx}(x, t)$ satisfies the heat equation with $v(x, 0) = 0$.
- (b) Find $u(x, t)$ as an explicit formula.
9. Consider the initial value problem

$$u_t + du = ku_{xx}, \quad -\infty < x < \infty, \quad t > 0, \quad u(x, 0) = g(x), \quad -\infty < x < \infty \quad (5.18)$$

with constant d , and given integrable function g .

- (a) Use the change of variable $u(x, t) = e^{-dt}v(x, t)$ to find u using the fundamental solution.
- (b) What is the effect of the constant d ?
- (c) Suppose $d = d(t)$ is a given continuous function. What would be a suitable change of variable to solve the problem?
10. Devise a change of variable corresponding to a moving frame of reference to solve the initial value problem for the convection-diffusion equation with constant speed c

$$u_t + cu_x = ku_{xx}, \quad -\infty < x < \infty, \quad t > 0, \quad u(x, 0) = g(x), \quad -\infty < x < \infty. \quad (5.19)$$

11. Formulate and prove a statement regarding conservation of energy for the wave equation on a bounded domain in \mathbb{R}^n :

$$u_{tt} = c^2 \Delta u, \quad \mathbf{x} \in U, \quad t > 0, \\ u(\mathbf{x}, 0) = \phi(\mathbf{x}), \quad u_t(\mathbf{x}, 0) = \psi(\mathbf{x}), \quad \mathbf{x} \in U,$$

under homogeneous Dirichlet or Neumann boundary conditions.

1. The final inequality is easily proved by contradiction: if $v_t < 0$ at P_1 , then $v(\mathbf{x}_1, t) > v(\mathbf{x}_1, T)$ for $t < T$ close to $t = T$, contradicting the assumption that v has a maximum at P_1 .

Separation of Variables and Fourier Series

In this chapter we find explicit solutions of the heat equation and wave equation on bounded domains using the powerful method of separation of variables. The method allows us to express solutions of constant-coefficient equations as infinite series of functions. Recall that infinite series of functions were used for the Cauchy-Kovalevskaya Theorem of [Section 2.3](#), where solutions were expressed as power series. In this chapter the solutions are series of trigonometric functions of the spatial variable x with coefficients that depend on time t . Such series are called *Fourier series*. We introduce them here, show how they relate to the method of separation of variables, and study them more extensively in the next chapter.

Fourier series solutions have several advantages over power series. Fourier series can be used to represent functions that are not analytic, for example, continuous functions. Moreover, solutions expressed as Fourier series are typically designed to have each term in the series satisfy both the PDE and the boundary conditions, provided the boundary conditions are homogeneous. Consequently, the only issues with such an approach are: (1) how to construct the series and (2) convergence. We deal with the construction in this chapter, and give rigorous convergence results in the next chapter.

6.1. Fourier Series

In this section we introduce the notation and basic formulas for Fourier series. Consider a continuous function $f: \mathbb{R} \rightarrow \mathbb{R}$ that is periodic with period $2L$. Then f can be represented by a Fourier series, which takes the form:

$$f(x) = \frac{a_0}{2} + \sum_{n=1}^{\infty} \left[a_n \cos\left(\frac{n\pi x}{L}\right) + b_n \sin\left(\frac{n\pi x}{L}\right) \right]. \quad (6.1)$$

An important property of the trigonometric functions in this series is that they are *orthogonal* on the interval $x \in [-L, L]$. Thus, for all $j, k = 0, 1, 2, \dots$,

$$\int_{-L}^L \cos\left(\frac{j\pi x}{L}\right) \sin\left(\frac{k\pi x}{L}\right) dx = 0, \quad (6.2)$$

and

$$\int_{-L}^L \cos\left(\frac{j\pi x}{L}\right) \cos\left(\frac{k\pi x}{L}\right) dx = L\delta_{jk} = \int_{-L}^L \sin\left(\frac{j\pi x}{L}\right) \sin\left(\frac{k\pi x}{L}\right) dx, \quad (6.3)$$

where $\delta_{jk} = \begin{cases} 1, & j=k, \\ 0, & j \neq k \end{cases}$

is the Kronecker delta. By multiplying (6.1) by one of the sine or cosine functions and integrating, the coefficients a_n, b_n are readily obtained from f , in the *Euler formulas*:

$$\begin{pmatrix} a_n \\ b_n \end{pmatrix} = \frac{1}{L} \int_{-L}^L f(x) \begin{pmatrix} \cos\left(\frac{n\pi x}{L}\right) \\ \sin\left(\frac{n\pi x}{L}\right) \end{pmatrix} dx, \quad (6.4)$$

with $n = 0, 1, 2, \dots$. The coefficients a_n are called *Fourier cosine coefficients*, and the b_n are *Fourier sine coefficients*.

For an odd function f , all the cosine coefficients are zero, and the sine coefficients are

$$b_n = \frac{2}{L} \int_0^L f(x) \sin\left(\frac{n\pi x}{L}\right) dx, \quad n = 0, 1, 2, \dots \quad (6.5)$$

The resulting series of sine functions is called the *Fourier sine series* of f . Note that the coefficients (6.5) are defined even if f is specified only on the interval $[0, L]$. Then the Fourier sine series is the Fourier series of the *odd periodic extension* of f , wherein f is extended to be an odd function \tilde{f} that is $2L$ periodic and such that $\tilde{f}(x) = f(x), 0 < x < L$.

Similarly, if f is an even function, then it has a Fourier cosine series, in which all the sine coefficients are zero, and the cosine coefficients are given by integrals over the interval $[0, L]$:

$$a_n = \frac{2}{L} \int_0^L f(x) \cos\left(\frac{n\pi x}{L}\right) dx, \quad n = 0, 1, 2, \dots \quad (6.6)$$

If f is an integrable function on $[-L, L]$, then the Fourier coefficients are well defined, and we say that f has a Fourier series. The series may converge to f only in a weak sense that we make precise in [Chapter 7](#), where the convergence of Fourier series is discussed in detail.

6.2. Separation of Variables for the Heat Equation

The method of separation of variables works most simply for the heat equation in one space dimension with homogeneous Dirichlet boundary conditions. If you follow the method in this case, then using separation of variables in other

circumstances becomes a matter of changing some details.

Consider the initial boundary value problem with homogeneous Dirichlet boundary conditions and initial data given by a continuous function $f : [0, L] \rightarrow \mathbb{R}$,

$$\begin{aligned} u_t &= k u_{xx}, & 0 < x < L, \quad t > 0, \\ u(0, t) &= 0 = u(L, t), & t > 0, \\ u(x, 0) &= f(x), & 0 < x < L. \end{aligned} \tag{6.7}$$

We summarize the method in two steps. In the first step, we seek solutions in the special separated form

$$u(x, t) = v(x)w(t),$$

a function of x times a function of t . Substituting into the PDE and the boundary conditions, we obtain ODE for the functions v, w with corresponding boundary conditions. This step leads to a family of solutions $\{u_n(x, t), n = 1, 2, \dots\}$.

In the second step, we write a linear combination of the u_n (actually, an infinite series):

$$u(x, t) = \sum_{n=1}^{\infty} b_n u_n(x, t).$$

This series is a representation of the general solution of the PDE and boundary conditions. It remains to choose the coefficients $b_n \in \mathbb{R}, n = 1, 2, \dots$ to satisfy the initial condition.

Claim 6.1. *This process leads to the series solution of (6.7):*

$$\begin{aligned} u(x, t) &= \sum_{n=1}^{\infty} b_n u_n(x, t), & u_n(x, t) &= e^{-k\lambda_n t} \sin \frac{n\pi x}{L}, \\ \lambda_n &= \frac{n^2\pi^2}{L^2}, & b_n &= \frac{2}{L} \int_0^L f(x) \sin \frac{n\pi x}{L} dx. \end{aligned} \tag{6.8}$$

Proof. As indicated above, the proof is organized around constructing the solution in two steps.

Step 1. Substitute $u(x, t) = v(x)w(t)$ into the PDE:

$$v(x)w'(t) = k v''(x)w(t).$$

Dividing by $k v(x)w(t)$ and simplifying, we get

$$\frac{w'(t)}{k w(t)} = \frac{v''(x)}{v(x)} = -\lambda, \tag{6.9}$$

a constant. Note that physical constants such as k are always included with the time portion, so that the spatial piece becomes a standard equation. Also, the minus sign on the right-hand side of (6.9) is included so that values of λ all turn out to be real and positive.

From (6.9) we have two ODE for $v(x)$, $w(t)$, with an additional unknown, the parameter λ :

$$w'(t) + k\lambda w(t) = 0, \quad (6.10a)$$

$$v''(x) + \lambda v(x) = 0. \quad (6.10b)$$

To summarize, $u(x, t) = v(x)w(t)$ satisfies the PDE if and only if $v(x)$, $w(t)$ satisfy (6.10) for some $\lambda \in \mathbb{R}$.

Now we substitute into the boundary conditions for u , and note that to get solutions u that are not identically zero, we must have corresponding boundary conditions on v . For example, $u(0, t) = 0 = v(0)w(t)$, so that either $w(t) = 0$ for all t (implying that $u(x, t) \equiv 0$) or $v(0) = 0$. Incorporating boundary conditions at both $x = 0$ and $x = L$ completes the *eigenvalue problem* to be solved for $v(x)$:

$$\begin{aligned} v''(x) + \lambda v(x) &= 0, \\ v(0) &= 0, \quad v(L) = 0. \end{aligned} \quad (6.11)$$

The eigenvalue/eigenfunction pairs for (6.11) are

$$\lambda_n = \frac{n^2\pi^2}{L^2}, \quad v_n(x) = \sin \frac{n\pi x}{L}.$$

With these eigenvalues, we turn to (6.10a) for $w(t)$, setting $\lambda = \lambda_n$. The general solution of this simple first-order ODE is an arbitrary multiple of

$$w = w_n(t) = e^{-k\lambda_n t}.$$

Note the important property that all the w_n decay in time, because the eigenvalues are real and positive.

Now we complete [step 1](#) by setting $u = u_n(x, t) = v_n(x)w_n(t)$, $n = 1, 2, \dots$

Step 2. To satisfy the initial condition, we form the series

$$u(x, t) = \sum_{n=1}^{\infty} b_n u_n(x, t).$$

Substituting $t = 0$ into the series and using the initial condition in (6.7), we get

$$\sum_{n=1}^{\infty} b_n v_n(x) = \sum_{n=1}^{\infty} b_n \sin \frac{n\pi x}{L} = f(x), \quad 0 < x < L. \quad (6.12)$$

Now we can extract the formula for b_n from the Euler formulas (6.4). ■

Having completed a procedure to generate a formula, it is natural to ask whether the formula in the claim really solves the initial boundary value problem. In particular, we have not proved that the series converges, or indeed whether all initial functions f can be represented by a Fourier sine series. Even if the series for $u(x, t)$ converges, we need to know whether the limit is sufficiently differentiable to be a solution of the heat equation. We postpone these important considerations for now, with the remark that the rapid decay of the coefficients $b_n e^{-k\lambda_n t}$ of $\sin \frac{n\pi x}{L}$ as $n \rightarrow \infty$ for $t > 0$ implies that the series converges uniformly to a C^∞ function, and differentiation term-by-term can be used to verify that $u(x, t)$ does indeed solve the problem.

It is worth noting that the boundary conditions are satisfied for $t > 0$, even though they may not be satisfied by the initial data. For the wave equation such a discontinuity is propagated along characteristics, but for the heat equation the discontinuity is immediately smoothed and does not propagate into the interior of the domain.

We next illustrate the method of separation of variables with two worked problems. In the first problem we set the constants k, L and choose the initial f to show that the infinite series may have only a finite number of nonzero terms.

Example 1. (Homogeneous Dirichlet boundary conditions) Solve the initial boundary value problem

$$\begin{aligned} u_t &= 7u_{xx}, & 0 < x < 1, \quad t > 0, \\ u(0, t) &= 0 = u(1, t), & t > 0, \\ u(x, 0) &= 3 \sin \pi x - 7 \sin 5\pi x, & 0 < x < 1. \end{aligned}$$

Separation of variables with these homogeneous Dirichlet boundary conditions and $L = 1$ gives eigenfunctions $\sin n\pi x$. Therefore, since $k = 7$,

$$u_n(x, t) = e^{-7n^2\pi^2 t} \sin n\pi x; \quad u(x, t) = \sum b_n u_n(x, t).$$

Now we choose the coefficients b_n so the series agrees with the initial condition when $t = 0$. Since the initial condition is a Fourier sine series with just two terms, the series for $u(x, t)$ also has only two terms. Let

$$b_1 = 3, \quad b_5 = -7, \quad b_i = 0, \quad \text{for other values of } i.$$

Then

$$u(x, t) = 3e^{-7\pi^2 t} \sin \pi x - 7e^{-175\pi^2 t} \sin 5\pi x$$

is the solution.

Example2. (Homogeneous Neumann boundary conditions) In this example we change the boundary condition and consequently get different eigenfunctions. Consider the initial boundary value problem, in which we have $L = \pi$, $k = 4$:

$$\begin{aligned} u_t &= 4u_{xx}, & 0 < x < \pi, \quad t > 0, \\ u_x(0, t) &= 0 = u_x(\pi, t), & t > 0, \\ u(x, 0) &= x, & 0 < x < \pi. \end{aligned} \tag{6.13}$$

Recall that in the first step of separation of variables, we consider the PDE and boundary conditions only; then in [step 2](#) we form a series of separated solutions to satisfy the initial condition. Neumann boundary conditions support a constant solution, which differs from the Dirichlet case: a nonzero constant does *not* satisfy the homogeneous Dirichlet boundary conditions.

Let $u(x, t) = v(x)w(t)$. The ODE for v , w with boundary conditions are now

$$\begin{aligned} w'(t) + 4\lambda w(t) &= 0, \\ v''(x) + \lambda v(x) &= 0, \\ v'(0) &= 0 = v'(\pi). \end{aligned}$$

We solve the eigenvalue problem for $\lambda = \lambda_n$, $v = v_n$. First note that $\lambda_0 = 0$ gives $v''(x) = 0$, so that v is linear. But $v'(0) = 0 = v'(\pi)$ implies that v is flat at the ends, so it must be flat everywhere. That is, v is constant:

$$v = v_0(x) = 1; \quad \lambda = \lambda_0 = 0.$$

For $\lambda > 0$, the general solution of the ODE is a combination of sines and cosines. Using the boundary conditions, we arrive at

$$v = v_n(x) = \cos nx, \quad \lambda_n = n^2.$$

The time-dependent part of the solution is the same as for Dirichlet boundary conditions, since the eigenvalues are the same, except that the constant solution is included here as well:

$$w = w_n(t) = e^{-4n^2 t}, \quad n \geq 0.$$

To complete the separation of variables step, we form the solutions

$$u = u_n(x, t) = e^{-4n^2 t} \cos nx, \quad n \geq 0.$$

Now we can form the series solution of the PDE and boundary conditions:

$$u(x, t) = \frac{a_0}{2} + \sum_{n=1}^{\infty} a_n e^{-4n^2 t} \cos nx.$$

Finally, we satisfy the initial condition by determining the coefficients a_n using orthogonality of the eigenfunctions. Setting $t = 0$ in the series, the initial condition becomes

$$u(x, 0) = x = \frac{a_0}{2} + \sum_{n=1}^{\infty} a_n \cos nx.$$

Multiplying by $\cos mx$ and integrating both sides from 0 to π , we see that all terms become zero, except where $m = n$. Consequently, integrating by parts and using $\cos n\pi = (-1)^n$, we have

$$a_0 = \frac{2}{\pi} \int_0^{\pi} x dx = \pi, \quad a_n = \frac{2}{\pi} \int_0^{\pi} x \cos nx dx = \frac{2}{n^2 \pi} (1 - (-1)^n), n \geq 1.$$

Thus, the solution is

$$u(x, t) = \frac{\pi}{2} - \frac{4}{\pi} \sum_{k=1}^{\infty} \frac{1}{(2k-1)^2} e^{-4(2k-1)^2 t} \cos(2k-1)x, \quad (6.14)$$

in which we have written $n = 2k - 1$, $k \geq 1$. We discuss convergence of Fourier series comprehensively in [Chapter 7](#), but it is easy to show that the specific series (6.14) converges.

Claim 6.2. *The series (6.14) converges uniformly for $t \geq 0$.*

Proof. To prove the claim, we estimate the k th term of the series:

$$\left| \frac{1}{(2k-1)^2} e^{-4(2k-1)^2 t} \cos((2k-1)x) \right| \leq \frac{1}{(2k-1)^2}.$$

Since $\sum \frac{1}{(2k-1)^2}$ is a convergent series of constants, the Weierstrass M -test (see [Appendix B](#)) implies the series (6.14) converges uniformly in x for each $t \geq 0$. ■

To examine whether the series satisfies the PDE, we need to be able to differentiate term by term. For $t > 0$, the coefficient of the k th term in the series decays exponentially in k , since the exponential $e^{-4(2k-1)^2 t}$ is multiplied only by a rational function (a ratio of polynomials). The same is true of the coefficients after differentiating any number of times in x and t . Consequently, from the standard result on uniform convergence and differentiating series of differentiable functions term by term, the series converges uniformly to a C^∞ function.

The situation at $t = 0$ is rather different. While the Fourier series converges uniformly for each $x \in \mathbb{R}$ to the continuous even periodic extension of $f(x) = x$, this function has jump discontinuities in the derivative. Consequently, the series differentiated with respect to x does *not* converge uniformly at $t = 0$, and the twice differentiated series converges only in a much weaker sense, specifically, in the sense of distributions (see [Section 9.2](#)).

Because Neumann boundary conditions correspond to insulated ends, heat energy is conserved, which we can see explicitly in the series solution. The heat energy at time t is proportional to

$$H(t) = \int_0^\pi u(x, t) dx.$$

Then we have

$$\frac{dH}{dt} = \int_0^\pi \frac{\partial u}{\partial t} dx = \int_0^\pi 4u_{xx} dx = 4u_x \Big|_{x=0}^{x=\pi} = 0$$

from the boundary conditions. Therefore,

$$H(t) = H(0) = \int_0^\pi u(x, 0) dx = \int_0^\pi x dx = \frac{\pi^2}{2}.$$

Now, as $t \rightarrow \infty$, the series converges to a constant: $u \rightarrow \frac{a_0}{2}$. From conservation of energy, we calculate

$$H(t) = \frac{\pi^2}{2} \rightarrow \int_0^\pi \frac{a_0}{2} dx = \frac{a_0}{2} \pi \text{ as } t \rightarrow \infty.$$

Therefore,

$$a_0 = \pi.$$

This conclusion agrees with the calculation of a_0 from orthogonality.

6.2.1. Robin Boundary Conditions

Robin-type boundary conditions relate the normal derivative of the function on the boundary to the function itself. We relate the analysis of these boundary conditions to physical considerations, such as the direction in which heat is being transported across the boundary. Consider the following problem:

$$\begin{aligned} u_t &= ku_{xx}, & 0 < x < L, & t > 0, \\ u_x - a_0 u &= 0, & x = 0, & t > 0, \\ u_x + a_L u &= 0, & x = L, & t > 0, \\ u(x, 0) &= f(x), & 0 < x < L. & \end{aligned}$$

The physical interpretation of the boundary conditions depends on the signs of the coefficients:

radiating boundary conditions: $a_0 > 0$, $a_L > 0$,

absorbing boundary conditions: $a_0 < 0$, $a_L < 0$.

Since heat energy flows from warm to cool, at $x = L$ if $u > 0$, a radiating boundary condition will give $u_x > 0$, so that heat will flow out of the boundary (the heat flux is negative), whereas for an absorbing boundary condition, $u_x < 0$, and heat will flow into the domain through the boundary at $x = L$. Consequently, for radiating boundary conditions, all eigenvalues are positive, because heat is transported out of the domain. For absorbing boundary conditions, there may be one or more negative eigenvalues.

Separation of variables leads to the eigenvalue problem

$$\begin{aligned} v'' + \lambda v &= 0, & 0 < x < L, \\ v' - a_0 v &= 0, & x = 0, \\ v' + a_L v &= 0, & x = L. \end{aligned} \tag{6.15}$$

We consider the implications of radiating and absorbing boundary conditions separately.

Radiating boundary conditions $a_0 > 0$, $a_L > 0$. For positive eigenvalues $\lambda = \beta^2 > 0$, the general solution of the ODE is

$$v(x) = A \cos \beta x + B \sin \beta x.$$

Now we use the boundary conditions to find equations for A , B , and β :

$$x = 0: \quad B\beta - a_0 A = 0, \quad \text{thus, } A = \frac{B}{a_0} \beta.$$

$$x = L: \quad -A\beta \sin \beta L + B\beta \cos \beta L + a_L A \cos \beta L + a_L B \sin \beta L = 0.$$

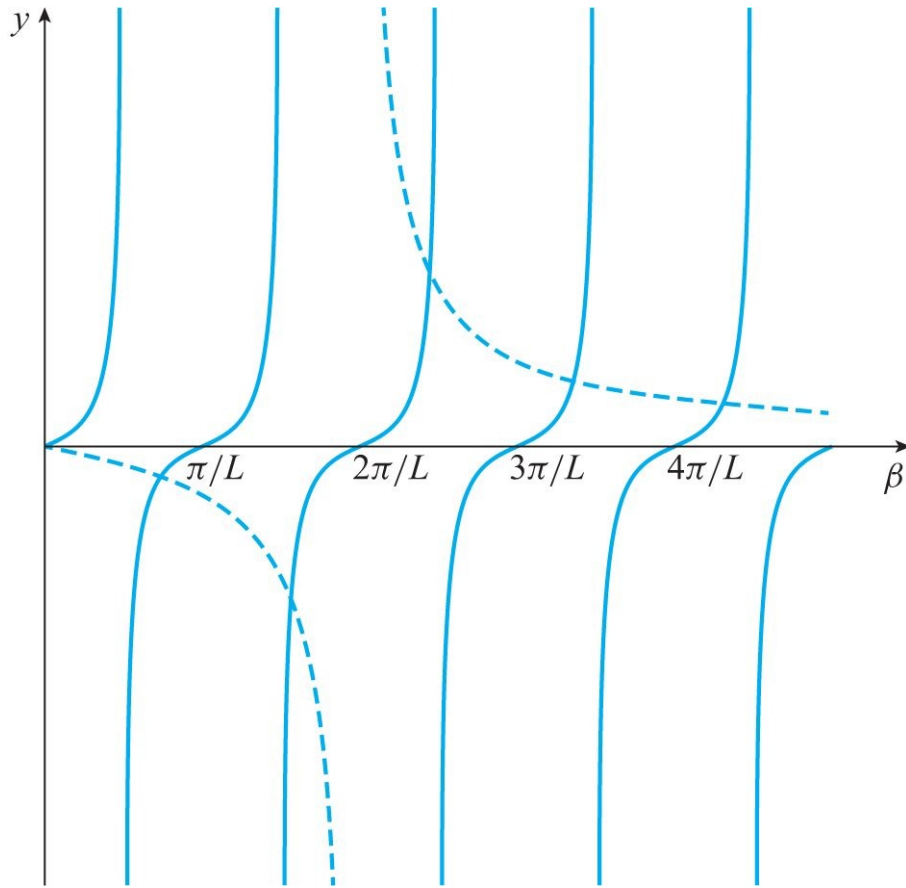

Figure 6.1. Plots of $\tan \beta L$ (solid curves) and $\beta(a_0 + a_L)/(\beta^2 - a_0 a_L)$ (dashed curves) with $L = \pi$, $a_0 = 1$, $a_L = 2$.

Dividing by $\cos \beta L$ and substituting in for A , we find either $B = 0$ or

$$\tan \beta L = \frac{\beta(a_0 + a_L)}{\beta^2 - a_0 a_L}, \quad (6.16)$$

which is an equation for β , since all the other constants are given. We reject $B = 0$, because it leads only to the trivial solution $u \equiv 0$.

From [Figure 6.1](#), we observe that there are solutions $\beta_1 < \beta_2 < \dots$:

$$\frac{\pi}{L}(n-1) < \beta_n < \frac{\pi}{L}(2n-1), \quad \text{for } \beta_n > \sqrt{a_0 a_L}.$$

As $n \rightarrow \infty$ the β_n s are approaching the lower limit to leading order:

$$\beta_n \sim \frac{\pi}{L}(n-1).$$

Thus, as $n \rightarrow \infty$ the eigenvalues $\lambda_n = \beta_n^2$ approach the eigenvalues $\lambda_n = \frac{n^2 \pi^2}{L^2}$ that we found for either Neumann or Dirichlet boundary conditions.

The corresponding eigenfunctions are given by

$$v = v_n(x) = \beta_n \cos \beta_n x + a_n \sin \beta_n x.$$

Absorbing boundary conditions. In the case of absorbing boundary conditions,

$a_0 < 0$, $a_L < 0$, heat energy is absorbed through the boundaries. Consequently, we might expect the temperature to rise when both boundaries are absorbing. Correspondingly, at least one eigenvalue should be negative. Positive eigenvalues $\lambda = \beta^2$ satisfy (6.16) and can be represented as intersections of the graphs of $\tan \beta L$ and the right-hand side of the equation, similar to Figure 6.1.

The issue is less clear when one boundary is absorbing and one is radiating, a situation explored in the exercises.

6.2.2. Inhomogeneous Boundary Conditions

Up to now the method of separation of variables has relied on homogeneity in boundary conditions and in the PDE. Here we consider a sample initial boundary value problem showing how to handle inhomogeneous problems. Consider the initial boundary value problem

$$\begin{aligned} u_t &= u_{xx} + f(x, t), & 0 < x < \pi, & t > 0, \\ u(0, t) &= u_0(t), & u(\pi, t) &= u_\pi(t), & t > 0, \\ u(x, 0) &= \phi(x), & 0 < x < \pi. \end{aligned} \tag{6.17}$$

The strategy is to first ignore the inhomogeneities f , u_0 , u_π so that we can identify suitable eigenfunctions $v_n(x)$. Then we form a series $\sum_{n=1}^{\infty} w_n(t)v_n(x)$ with time-dependent coefficients $w_n(t)$ that are determined in a new way to accommodate the inhomogeneities.

From the homogeneous version of problem (6.17), we know that the eigenfunctions are sines, due to the boundary conditions. Thus, we consider the Fourier sine series for u :

$$u(x, t) = \sum_{n=1}^{\infty} w_n(t) \sin nx. \tag{6.18}$$

To satisfy the PDE, we also expand $f(x, t)$ as a Fourier sine series:

$$f(x, t) = \sum_{n=1}^{\infty} f_n(t) \sin nx,$$

where the coefficients are defined by

$$f_n(t) = \frac{2}{\pi} \int_0^\pi f(x, t) \sin nx \, dx.$$

The series (6.18) apparently does not satisfy the inhomogeneous boundary conditions, because when evaluated at $x = 0$ or $x = \pi$ the series gives the value zero. However, we shall see in the next chapter that Fourier series can converge to a function that is discontinuous. Where the boundary condition is nonzero, it is

satisfied by the series (6.18) in the sense that $u(x, t)$ approaches the specified value ($u_0(t)$ or $u_\pi(t)$) as x approaches the boundary:

$$\lim_{x \rightarrow 0^+} u(x, t) = u_0(t), \quad \lim_{x \rightarrow \pi^-} u(x, t) = u_\pi(t).$$

To find the coefficients $w_n(t)$, we could substitute the series (6.18) into the PDE and equate terms. However, this procedure would omit the effect of the boundary conditions, so instead, we use the Euler formulas for the coefficients $w_n(t)$:

$$w_n(t) = \frac{2}{\pi} \int_0^\pi u(x, t) \sin nx \, dx. \quad (6.19)$$

Guided by the expectation of an ODE for $w_n(t)$, we differentiate and then use the PDE:

$$\begin{aligned} w_n'(t) &= \frac{2}{\pi} \int_0^\pi u_t \sin nx \, dx = \frac{2}{\pi} \int_0^\pi u_{xx} \sin nx \, dx + f_n(t) \\ &= -n^2 w_n(t) + f_n(t) + \frac{2}{\pi} \{-n(-1)^n u_\pi(t) + n u_0(t)\}, \end{aligned}$$

integrating by parts twice. We can rewrite this as an inhomogeneous ODE,

$$w_n'(t) = -n^2 w_n(t) + F_n(t), \quad (6.20)$$

where $F_n(t) = f_n(t) + \frac{2}{\pi} \{-n(-1)^n u_\pi(t) + n u_0(t)\}$. Setting $t = 0$ in (6.19), we obtain the initial condition

$$w_n(0) = \frac{2}{\pi} \int_0^\pi \phi(x) \sin nx \, dx. \quad (6.21)$$

The solution of the initial boundary value problem (6.17) is given by the series (6.18), where the coefficients $w_n(t)$ are obtained by solving the ODE initial value problem (6.20), (6.21).

6.3. Separation of Variables for the Wave Equation

Separation of variables works for the wave equation on bounded domains in much the same way it works for the heat equation. Differences arise because the wave equation has two time derivatives, rather than the one time derivative that appears in the heat equation. Previously we emphasized the traveling wave structure of solutions of the wave equation through d'Alembert's solution, whereas separation of variables highlights the role of vibrations, which are time-periodic solutions. The typical physical context for these solutions is a vibrating string of finite length, where the eigenfunctions for the wave equation are modes of vibration for different frequencies.

Consider the initial value problem for the wave equation

$$\begin{aligned} u_{tt} &= c^2 u_{xx}, & 0 < x < L, & \quad t > 0, \\ u(0, t) &= 0 = u(L, t), & & \quad t > 0, \\ u(x, 0) &= \phi(x), & u_t(x, 0) &= \psi(x), & \quad 0 < x < L. \end{aligned} \tag{6.22}$$

We solve this problem by following the separation-of-variables procedure used for the corresponding initial boundary value problem (6.7) for the heat equation. Because there are two t derivatives in the PDE, we need two initial conditions instead of one. Also, the constant $k > 0$ in the heat equation is replaced by the constant $c^2 > 0$ in the wave equation.

Claim 6.3. *The solution of (6.22) is the series*

$$u(x, t) = \sum_{n=1}^{\infty} \left(a_n \cos \frac{n\pi ct}{L} + b_n \sin \frac{n\pi ct}{L} \right) \sin \frac{n\pi x}{L}, \tag{6.23}$$

with

$$a_n = \frac{2}{L} \int_0^L \phi(x) \sin \frac{n\pi x}{L} dx, \quad b_n = \frac{2}{n\pi c} \int_0^L \psi(x) \sin \frac{n\pi x}{L} dx. \tag{6.24}$$

Proof. We substitute $u(x, t) = v(x)w(t)$ into the PDE and boundary conditions, and divide by $c^2 w(t)$. This leads to

$$\frac{w''(t)}{c^2 w(t)} = \frac{v''(x)}{v(x)} = -\lambda,$$

which is a constant. Now we have two ODE for $v(x)$, $w(t)$, with an additional unknown, the parameter λ :

$$w''(t) + c^2 \lambda w(t) = 0, \tag{6.25a}$$

$$v''(x) + \lambda v(x) = 0. \tag{6.25b}$$

Just as for the heat equation, the PDE boundary conditions become boundary conditions for $v(x)$:

$$v(0) = v(L) = 0. \tag{6.26}$$

We already know the eigenvalues λ and eigenfunctions v for this problem:

$$\lambda = \lambda_n = \frac{n^2 \pi^2}{L^2}, \quad v = v_n(x) = \sin \frac{n\pi x}{L}.$$

The difference between the heat equation and the wave equation solutions is in the time-dependent part $w(t)$. The ODE (6.25a), with $\lambda = \lambda_n$, has the general solution

$$w = w_n(t) = a_n \cos\left(\frac{n\pi}{L}ct\right) + b_n \sin\left(\frac{n\pi}{L}ct\right).$$

Now we let $u_n(x, t) = v_n(x)w_n(t)$, $n = 1, 2, \dots$, which is a family of solutions of the PDE and boundary conditions. Next we form the infinite series

$$u(x, t) = \sum_{n=1}^{\infty} u_n(x, t),$$

and it remains to show how the coefficients a_n, b_n are determined from the initial conditions.

The initial condition $u(x, 0) = \phi(x)$ is

$$\sum_{n=1}^{\infty} a_n \sin \frac{n\pi x}{L} = \phi(x), \quad 0 < x < L,$$

leading to the expression for a_n in the claim.

Similarly, the initial condition $u_t(x, 0) = \psi(x)$ leads to the formula for b_n , since (differentiating the series with respect to t),

$$\sum_{n=1}^{\infty} b_n \frac{n\pi c}{L} \sin \frac{n\pi x}{L} = \psi(x), \quad 0 < x < L.$$

Thus,

$$b_n \frac{n\pi c}{L} = \frac{2}{L} \int_0^L \psi(x) \sin \frac{n\pi x}{L} dx,$$

from which the formula in the claim follows. ■

The form of these solutions of the wave equation leads us to note several differences between solutions of the wave equation and those of the heat equation:

1. The individual terms in the series for the wave equation oscillate in time. Indeed, this is the behavior of the solution as a whole; it is periodic in time, with period $2\pi L/c$.
2. Using trigonometric identities, you can write (6.23) in the form $u(x, t) = F(x + ct) + G(x - ct)$. After all, we know that every solution of the wave equation in one dimension is of this form. It is a good exercise to find F and G in terms of ϕ and ψ , and their periodic extensions.

6.4. Separation of Variables for a Nonlinear Heat Equation

Separation of variables is very useful for linear equations. However, for nonlinear equations, it is not nearly as useful, partly because the technique depends on linear combinations of solutions also being solutions, which is not the case for nonlinear equations. Although there generally will not be solutions in which the independent variables are separated, the porous medium equation has a structure that admits separated solutions (See Evans [12], p. 170.). This equation is a simplified model of fluid flow in a porous medium, such as compacted sand or soil.

Let $m > 1$ be a given constant, and consider the porous medium equation for the unknown function $u = u(x, t) > 0$, $x \in \mathbb{R}^n$, $t > 0$:

$$u_t = \Delta(u^m).$$

Let $u(x, t) = v(x)w(t)$. Then

$$v(x)w'(t) = (w(t))^m \Delta(v(x))^m,$$

and therefore,

$$\frac{w'(t)}{(w(t))^m} = \frac{\Delta(v(x))^m}{v(x)} = \mu = \text{const.}$$

Note that the function $F(u) = u^m$ is *homogeneous of degree m* , meaning $F(\alpha u) = \alpha^m F(u)$, for $\alpha > 0$. The homogeneity allows us to separate variables. We thus obtain the pair of equations

$$w'(t) = \mu(w(t))^m, \tag{6.27}$$

$$\Delta(v(x))^m = \mu v(x). \tag{6.28}$$

To solve (6.27), we integrate once to get $\frac{w^{1-m}}{1-m} = \mu t + k$. Hence,

$$w(t) = (\mu(1-m)t + \lambda)^{1/(1-m)},$$

in which λ, μ are constants; we need $\lambda > 0$ to ensure that $w(0)$ is defined.

Next, we find spherically symmetric solutions of the v equation (6.28). Consider $v(x) = r^\alpha$, $r = |x|$, with α a constant to be determined. Then

$$\begin{aligned} \Delta(v^m) &= \Delta(r^{m\alpha}) = \phi''(r) + \frac{n-1}{r}\phi'(r) \\ &= m\alpha(m\alpha-1)r^{m\alpha-2} + \frac{n-1}{r}m\alpha r^{m\alpha-1} = \mu r^\alpha \end{aligned}$$

(where $\phi(r) = r^{m\alpha}$). Equating powers of r yields

$$\begin{aligned}
m\alpha - 2 &= \alpha, \\
\alpha &= \frac{2}{m-1}.
\end{aligned}
\tag{6.29}$$

Equating coefficients results in

$$\mu = m\alpha(m\alpha + n - 2) > 0. \tag{6.30}$$

Finally, combining v and w gives

$$u(x, t) = (\mu(1 - m)t + \lambda)^{\frac{1}{1-m}} |x|^\alpha,$$

where α , μ are given by (6.29), (6.30), but $\lambda > 0$ is a free parameter. The solution $u(x, t)$ is well defined as $t \rightarrow 0+$. However, as t increases, the negative fractional power means that u blows up as t increases to $\frac{\lambda}{\mu(m-1)} > 0$, since $m > 1$.

6.5. The Beam Equation

The beam equation

$$u_{tt} = -Gu_{xxxx} + q(x, t) \tag{6.31}$$

is a fourth-order PDE for the deflection of a homogeneous beam under an applied external load distribution $q(x, t)$. The beam equation is written here in nondimensional form, in which the dimensionless parameter $G = EI/\rho > 0$ is related to the elastic modulus E , the bending modulus I , and the density (mass per unit length) ρ . This equation models small deflections from a straight beam and is based on assuming that cross sections bend around the center line and exert forces on one another due to bending, leading to compression on one side of the center line and stretching on the opposite side.

The dispersion relation is obtained by seeking solutions related to the Fourier transform of (6.31). Let $q \equiv 0$ and $u = \exp(i\omega t + i\xi x)$. Then

$$\omega^2 = G\xi^4$$

gives the temporal frequency ω as a function of the spatial frequency ξ . However, it is somewhat more informative to consider the full separated equations, as we did in Sections 6.2 and 6.3 for second-order equations.

Let $u(x, t) = v(x)w(t)$. Substituting into the beam equation (6.31) and dividing by vw , we get two ODE:

$$\begin{aligned}
w''(t) + \omega^2 w(t) &= 0, \\
v^{(4)}(x) - \mu^4 v(x) &= 0,
\end{aligned}$$

where $\omega^2 > 0$ is constant, and $\mu^2 = \omega/\sqrt{G}$. Thus $w(t) = A \cos \omega t + B \sin \omega t$, and the general solution for $v(x)$ is

$$v(x) = a \cos(\mu x) + b \sin(\mu x) + c \cosh(\mu x) + d \sinh(\mu x), \quad (6.32)$$

with arbitrary constants a, b, c, d .

Since the equation is fourth order in space, we need four boundary conditions, and two initial conditions are also needed, since the equation is second order in time. For example, for a beam fixed at both ends $x = 0, x = L$, the boundary conditions are

$$u(0, t) = u_x(0, t) = 0, \quad u(L, t) = u_x(L, t) = 0.$$

These *clamped-beam boundary conditions* translate to the four boundary conditions on $v(x)$ that require v and v' to be zero at each end. Then by processing the conditions on v given by (6.32), we find the spatial wave numbers $\mu = \mu_n, n = 1, 2, \dots$, are determined from the equation

$$\cos(\mu L) = \operatorname{sech}(\mu L).$$

It is easy to see that $\mu_n \in ((n - 1)\pi/L, n\pi/L)$, and (since $\operatorname{sech} \xi \rightarrow 0$ as $\xi \rightarrow \infty$), $\mu_n \sim n\pi$ as $n \rightarrow \infty$.

A *cantilevered beam* is taken to be clamped at one end $x = 0$, and free at the other. The boundary conditions are

$$u(0, t) = u_x(0, t) = 0, \quad u_{xx}(L, t) = u_{xxx}(L, t) = 0.$$

In this case, we also find (see [problem 8](#)) $\mu_n \in ((n - 1)\pi/L, n\pi/L)$.

In this chapter we have seen how to implement the method of separation of variables in several example problems. In the next chapter we place the method in a rigorous theoretical framework. In particular, we explore eigenvalue problems and prove results on the convergence of infinite series of eigenfunctions, including Fourier series.

PROBLEMS

1. Solve the initial boundary value problem

$$\begin{aligned} u_t &= 4u_{xx}, & 0 < x < \pi, \quad t > 0, \\ u(0, t) &= 0 = u(\pi, t), & t > 0, \\ u(x, 0) &= \sin x - 3 \sin 5x, & 0 < x < \pi. \end{aligned}$$

2. Solve the initial boundary value problem

$$\begin{aligned} u_{tt} &= 9u_{xx}, & 0 < x < 1, \quad t > 0, \\ u(0, t) &= 0 = u(1, t), & t > 0, \\ u(x, 0) &= 2 \sin(\pi x) + 7 \sin(3\pi x), & 0 < x < 1, \\ u_t(x, 0) &= 2 \sin(\pi x), & 0 < x < 1. \end{aligned}$$

3. Consider the eigenvalue problem (6.15) with Robin boundary conditions. Suppose $\lambda = 0$ is an eigenvalue.

(a) Find the eigenfunction.

(b) Find a necessary condition on the coefficients a_0, a_L .

(c) Prove that this condition is also sufficient to guarantee that $\lambda = 0$ is an eigenvalue.

4. Consider the eigenvalue problem (6.15) with Robin boundary conditions.

(a) Prove that there is at least one negative eigenvalue in the absorbing case $a_0 < 0, a_L < 0$.

(b) Find a condition on a_0, a_L that is necessary and sufficient to have two negative eigenvalues.

5. Consider the eigenvalue problem (6.15) with Robin boundary conditions. In the radiating case $a_0 > 0, a_L > 0$, prove the properties shown graphically in Figure 6.1. (Hint: As in the text, it is easier to let $\lambda = \beta^2$. You can also use $\tan(n\pi + \theta) = \tan \theta$.)

(a) There are an infinite number of eigenvalues $\lambda_n, n \geq 1$.

(b)
$$\frac{(n-1)^2\pi^2}{L^2} < \lambda_n < \frac{(2n-1)^2\pi^2}{4L^2}.$$

(c)
$$\lambda_n - \frac{(n-1)^2\pi^2}{L^2} \rightarrow 0 \text{ as } n \rightarrow \infty.$$

(d) If $\beta_n = (n-1)\pi/L + \theta_n$, with $\theta_n \rightarrow 0$ as $n \rightarrow \infty$, find the leading-order behavior of θ_n : $\theta_n = A/n + O(1/n^2)$.

6. This problem is a graphical summary of problems 3–5. Sketch the hyperbola $a_0 a_L L + a_0 + a_L = 0$ in the a_0, a_L plane, showing the asymptotes. In your sketch, label the (three) regions corresponding to values of (a_0, a_L) for which there are two, one, or zero negative eigenvalues. Label the point corresponding to Neumann boundary conditions. Where in the plane are Dirichlet boundary conditions represented?

7. For constants $0 < m < L$, let

$$p(x) = \begin{cases} p_1 & x < m \\ p_2 & x > m \end{cases}, \quad r(x) = \begin{cases} r_1 & x < m \\ r_2 & x > m \end{cases},$$

where $p_j, r_j, j = 1, 2$, are positive constants. Assuming that eigenfunctions are continuously differentiable, find an equation for the eigenvalues λ for the eigenvalue problem

$$(p(x)v')' + \lambda r(x)v = 0, \quad 0 < x < L, \quad v(0) = 0 = v(L).$$

You may assume that the eigenvalues are real and positive.

8. The beam equation is associated with eigenvalue problems for the fourth-order ODE

$$v^{(4)}(x) - \lambda v(x) = 0.$$

Using the general solution (6.32), find an equation for the positive eigenvalues $\lambda = \mu^4$ for the cantilevered beam, with boundary conditions

$$v(0) = v'(0) = 0, \quad v''(L) = v'''(L) = 0.$$

From this equation, or using a graph, show that there are an infinite number of positive eigenvalues λ_n , corresponding to

$$(2k - 1)\pi/L < \mu_{2k} < (2k - \frac{1}{2})\pi/L,$$

$$(2k - \frac{3}{2})\pi/L < \mu_{2k-1} < (2k - 1)\pi/L, \quad k \geq 1.$$

State the leading-order dependence of λ_n on n as $n \rightarrow \infty$.

9. (a) Calculate the Fourier series of the function $f(x)$ that is odd and 2π periodic, with $f(x) = 1$, $0 < x < \pi$.

(b) Assuming the series converges to $f(x) = 1$ at $x = \pi/4$, calculate the sum of the series

$$1 + \frac{1}{3} - \frac{1}{5} - \frac{1}{7} + \frac{1}{9} + \frac{1}{11} + \dots$$

Eigenfunctions and Convergence of Fourier Series

In the previous chapter we used the technique of separation of variables to solve a variety of initial boundary value problems for the heat and wave equations. We showed how the technique leads naturally to eigenvalue problems for the spatial dependence of the solutions. The resulting eigenfunctions (sines and cosines in the previous chapter) are then combined into infinite series with time-dependent coefficients to represent the solution of the PDE and its initial conditions.

In this chapter we show that the technique can also be used for nonconstant-coefficient equations, such as

$$u_t = (p(x)u_x)_x + q(x)u,$$

in which the coefficients p , q are specified functions. However, the eigenvalues and eigenfunctions are generally not available explicitly for such equations. Nonetheless, with the aid of the Sturm-Liouville Theory of eigenvalue problems in [Section 7.1](#), we place on a firm footing the method of separation of variables to construct infinite series of functions representing solutions of the PDE and its boundary conditions. There remains the issue of convergence of the infinite series, even for the explicit series of the previous chapter. For example, so far we have examined convergence of such a series in just one example. In [Section 7.2](#), we introduce notions of pointwise, uniform, and L^2 convergence, proving typical convergence results in subsequent sections. Finally in [Section 7.6](#), we introduce the Fourier transform, and show how it is related to Fourier series before demonstrating the use of the transform in PDE, and discussing its utility in a range of areas.

7.1. Eigenfunctions for ODE

Consider the following ODE eigenvalue problem, known as a *Sturm-Liouville problem*. Let p , q , r be given real C^2 functions on the bounded interval $[a, b]$. We assume $p(x) > 0$, $r(x) > 0$, $a \leq x \leq b$. The eigenvalue problem consists of the ODE

$$-\frac{d}{dx} \left(p(x) \frac{dv}{dx} \right) + q(x)v = \lambda r(x)v, \quad a < x < b, \quad (7.1)$$

in which $\lambda \in \mathbb{C}$ is a parameter, together with linear and homogeneous boundary conditions. The treatment of eigenvalue problems in the previous chapter

corresponds to the special case $p \equiv 1$, $q \equiv 0$, $r \equiv 1$. In this section we derive properties of the eigenvalues λ and eigenfunctions v that help make the method of separation of variables work for linear PDE with variable coefficients. In particular, we show that the orthogonality of the sine and cosine eigenfunctions in the previous chapter was not an accident and can be established easily in the more general context of (7.1).

We define a *differential operator* \mathcal{L} by $\mathcal{L}v(x) = -\frac{d}{dx} \left(p(x) \frac{dv}{dx} \right) + q(x)v$. Then for any $v \in C^2[a, b]$, $\mathcal{L}v$ is a new function (in $C[a, b]$). To write (7.1) as an eigenvalue problem

$$\mathcal{L}v = \lambda r v,$$

we restrict the domain of \mathcal{L} to functions that satisfy the boundary conditions.

We consider complex-valued functions, so as to include the possibility of complex eigenvalues λ . In this context, we need the weighted L^2 space of square-integrable complex-valued functions, with weight $r(x)$ and inner product defined by

$$(u, v) \equiv \int_a^b u(x) \overline{v(x)} r(x) dx. \quad (7.2)$$

The corresponding norm (see [Appendix B](#)) is

$$\|f\| = (f, f)^{\frac{1}{2}}.$$

For simplicity, we assume $r \equiv 1$ and leave to [problem 2](#) the consideration of more general functions $r(x) > 0$.

Notice that \mathcal{L} has a special form, in which the first- and second-order derivatives are combined into a single term that can be integrated. This allows us to use integration by parts as follows. For $u, v \in C^2[a, b]$,

$$\begin{aligned} (\mathcal{L}u, v) &= \int_a^b (-(p(x)u')' + q(x)u) \bar{v} dx \\ &= [-pu'\bar{v} + pu\bar{v}']_a^b + \int_a^b (-(p\bar{v}')'u + qu\bar{v}) dx \\ &= [p(u\bar{v}' - u'\bar{v})]_a^b + (u, \mathcal{L}v). \end{aligned} \quad (7.3)$$

If the boundary conditions are such that the boundary term vanishes:

$$[p(u\bar{v}' - u'\bar{v})]_a^b = 0, \quad (7.4)$$

then we have the identity

$$(\mathcal{L}u, v) = (u, \mathcal{L}v). \quad (7.5)$$

In this case, we say \mathcal{L} is *symmetric*. Notice that this depends on two properties, namely, the special form of the second-order differential operator and condition (7.4) on the boundary conditions.

Theorem 7.1. *Let \mathcal{L} be symmetric. Then*

1. *all eigenvalues of \mathcal{L} are real, and*
2. *eigenfunctions of different eigenvalues are orthogonal.*

Proof. The proof is the same as the proof of the corresponding properties of a symmetric matrix. It depends on the calculation (7.3) formalized in (7.5) and elementary properties of the complex inner product.

1. Suppose $\mathcal{L}u = \lambda u$, $u \neq 0$, and suppose u satisfies the boundary conditions.

Then

$$\begin{aligned} \lambda \|u\|^2 &= \lambda(u, u) = (\lambda u, u) = (\mathcal{L}u, u) \\ &= (u, \mathcal{L}u) = (u, \lambda u) = \bar{\lambda}(u, u) = \bar{\lambda} \|u\|^2 \end{aligned}$$

But $\|u\| \neq 0$, since $u \neq 0$, so we must have $\lambda = \bar{\lambda}$. Therefore, λ is real.

2. Let u, v be eigenvectors for different eigenvalues $\lambda \neq \mu$: $\mathcal{L}u = \lambda u$, $\mathcal{L}v = \mu v$.

Then

$$\lambda(u, v) = (\lambda u, v) = (\mathcal{L}u, v) = (u, \mathcal{L}v) = (u, \mu v) = \mu(u, v).$$

Therefore, $(\lambda - \mu)(u, v) = 0$, so that $(u, v) = 0$. ■

Remarks. For the eigenvalue problem to make sense, the boundary conditions have to be linear and homogeneous. Clearly, both homogeneous Dirichlet or Neumann boundary conditions are symmetric. We leave as an exercise the property that Robin boundary conditions of the form

$$\begin{aligned} u' - a_0 u &= 0, & \text{at } x = a, \\ u' + a_1 u &= 0, & \text{at } x = b \end{aligned} \quad (7.6)$$

are also symmetric.

As we noted earlier, an important property of eigenvalues for the heat equation is that they are positive, except possibly for a finite number of them. For symmetric Sturm-Liouville problems we can find a sufficient condition for all the eigenvalues to be nonnegative.

Suppose $\mathcal{L}u = \lambda u$. Then

$$\lambda \|u\|^2 = (\mathcal{L}u, u) = -pu'u|_a^b + \int_a^b (p(u')^2 + qu^2) dx \geq 0,$$

if

$$-pu'u|_a^b \geq 0 \quad \text{and} \quad q(x) \geq 0, \quad a < x < b. \quad (7.7)$$

For Dirichlet or Neumann boundary conditions, the first of these conditions is satisfied, but it need not be for Robin boundary conditions (7.6) without restrictions on the coefficients a_0, a_1 . However, if both coefficients are positive, then the boundary term in (7.7) is nonnegative, so the eigenvalues are nonnegative (providing the second condition $q(x) \geq 0$ is satisfied.)

In Chapter 6, Claim 6.2, we proved uniform convergence of the Fourier series solving an initial boundary value problem for the heat equation. In the next three sections we prove more general convergence results for series: pointwise convergence, uniform convergence, and mean-square convergence.

7.2. Convergence and Completeness

Before proving results on the convergence of Fourier series and other series of functions, we introduce some general concepts of convergence and completeness, and discuss their significance for PDE. The convergence of a sequence $\{\mathbf{v}_k\}_{k=1}^\infty$ in \mathbb{R}^n to a limit \mathbf{v} means that $\|\mathbf{v}_k - \mathbf{v}\| \rightarrow 0$ as $k \rightarrow \infty$. Here, $\|\mathbf{x}\|$ denotes the usual Euclidean norm of the distance of $\mathbf{x} \in \mathbb{R}^n$ to the origin. The idea of convergence of a sequence of numbers carries over naturally to functions. If $\{f_k(x)\}_{k=1}^\infty$ is a sequence of functions defined on a set S , then the sequence *converges pointwise* on S to a function f if the sequence of numbers $\{f_k(x)\}_{k=1}^\infty$ converges to $f(x)$ for each $x \in S$. In this definition, the functions can be vector valued, so that $f_k : S \rightarrow \mathbb{R}^n$, and they can be defined on a multidimensional set $S \subset \mathbb{R}^m$.

We also need to introduce *convergence in norm* in the sense that $\|f_k - f\| \rightarrow 0$ as $k \rightarrow \infty$, where $\|f\|$ denotes an appropriate norm on a space of functions. For example, if $C[a, b]$ denotes the space of continuous functions $f : [a, b] \rightarrow \mathbb{R}$ on a bounded interval $[a, b] \subset \mathbb{R}$, then one norm on $C[a, b]$ is the sup norm $\|f\|_{\max} = \max_{a \leq x \leq b} |f(x)|$. This is also called the *uniform norm*, because $\|f_k - f\|_{\max} \rightarrow 0$ means $f_k \rightarrow f$ uniformly, in which case $f \in C[a, b]$, a fundamental result in analysis. More generally, a sequence $\{f_k\}_{k=1}^\infty$ in a normed space X is a *Cauchy sequence* if $\|f_j - f_k\| \rightarrow 0$ as $j > k \rightarrow \infty$ (uniformly in j), so that for every $\epsilon > 0$, there is $N > 0$ such that if $\|f_j - f_k\| < \epsilon$ for all $j, k > N$. If X has the property

that Cauchy sequences converge to a limit in X , then X is *complete*. Complete normed vector spaces (such as \mathbb{R}^n , and $C[a, b]$ with the sup norm) are called *Banach spaces*. In a Banach space, a sequence converges if and only if it is a Cauchy sequence.

Another norm on $C[a, b]$ is the L^2 norm $\|f\|_2 = \left(\int_a^b f(x)^2 dx\right)^{\frac{1}{2}}$. This norm is more closely analogous to the Euclidean norm, if you think of $f(x)$, $a \leq x \leq b$ as a vector in an infinite-dimensional space, and the norm as the square root of a sum of values $f(x)^2$, thus measuring the distance of f from the origin $f \equiv 0$. Incidentally, the analog of the sup norm in \mathbb{R}^n is the norm $\|\mathbf{x}\|_{\max} = \max\{|x_j|, j = 1, 2, \dots, n\}$. Interestingly, all norms in \mathbb{R}^n are equivalent, so that convergence in the Euclidean norm and in $\|\cdot\|_{\max}$ are equivalent. In contrast, the sup norm and the L^2 norm on $C[a, b]$ are not equivalent. The following example shows how convergence in these two norms is different and moreover that the space $C[a, b]$ with the L^2 norm is not complete.

Example 1. (Pointwise and L^2 convergence but not uniform) Let $f_k : [0, 1] \rightarrow \mathbb{R}$ be the sequence of continuous functions defined by

$$f_k(x) = \begin{cases} 1 - kx, & 0 \leq x \leq \frac{1}{k}, \\ 0, & \text{otherwise.} \end{cases}$$

Then, as $k \rightarrow \infty$,

$$f_k(x) \rightarrow f(x) = \begin{cases} 1, & x = 0, \\ 0, & 0 < x \leq 1 \end{cases}$$

pointwise, and $\|f_k - f\|_2 \rightarrow 0$. However, f_k does not converge to f in the uniform (sup) norm, since $\sup_{0 \leq x \leq 1} |f_k(x) - f(x)| = 1$ for all k .

Example 2. (Pointwise but not uniform convergence) The sequence of continuous functions $g_n(x) = x^n$ on $[0, 1]$ converges pointwise to the discontinuous function

$$g(x) = \lim_{n \rightarrow \infty} x^n = \begin{cases} 0, & 0 \leq x < 1, \\ 1, & x = 1. \end{cases}$$

Consequently, g_n cannot converge uniformly on $[0, 1]$. In fact, $\sup_{0 \leq x \leq 1} |S_n(x) - S(x)| = 1$ does not go to zero as $n \rightarrow \infty$. For the same reason, the convergence also fails to be uniform on the open interval $0 < x < 1$, even though the limit is continuous there. However, the convergence is uniform on the interval $[0, a]$, for any $a \in (0, 1)$, since $|x^n| \leq a^n \rightarrow 0$ as $n \rightarrow \infty$.

When dealing with PDE, we often work in spaces of functions that are not

necessarily continuous, such as L^2 spaces. Since spaces of continuous or continuously differentiable functions are surely better suited to finding solutions of differential equations, it is natural to ask “Why bother?” Moreover, for elliptic and parabolic equations, the solutions tend to be very smooth, having even more derivatives than the equation would seem to require.

The short answer to this question is that existence of solutions is much easier to prove in the weaker L^2 spaces. A longer explanation is that, at least for the beginning theory, existence results and proofs rely on having a space that is complete in a norm with a corresponding inner product. Such a space is called a *Hilbert space*. Spaces of continuous functions on bounded closed sets are complete in the sup norm, but this norm does not have a corresponding inner product. In contrast, $L^2(U)$ is a Hilbert space with inner product (7.2). Having established the existence and uniqueness of weak solutions in such a space, then regularity results for the weak solution are established separately.

The precise definition of $L^2(U)$ as a Hilbert space requires some measure theory. In particular, the Riemann integral is not sufficiently general, and a more sophisticated theory of integration, based on Lebesgue measure, is most suitable. In this theory, the Riemann integral is generalized to enable some irregular functions to be integrable in the Lebesgue sense. Functions that are Lebesgue integrable are called *measurable*. More precisely, all measurable functions are Lebesgue integrable (see [Appendix B](#)).

For the $L^2(a, b)$ norm to make sense, we need to clarify how the property $\|f\| = 0 \Rightarrow f = 0$ is to be understood. This relies on the notation of sets of measure zero. A set $S \subset \mathbb{R}$ has *measure zero* if for every $\epsilon > 0$, S can be covered by a countable family $\{I_j : j = 1, 2, \dots\}$ of open intervals with lengths (i.e., measures) m_j , $j = 1, 2, \dots$, such that $S \subset \cup_{j=1}^{\infty} I_j$ and $\sum_{j=1}^{\infty} m_j < \epsilon$. For a measurable function $f : [a, b] \rightarrow \mathbb{C}$, we say $f(x) = 0$ *almost everywhere* if there is a set $S \subset [a, b]$ of measure zero such that $f(x) = 0$ for all $x \in [a, b]$ with $x \notin S$.

A key property of the Lebesgue integral applies to L^2 functions: If $f \in L^2(a, b)$, then $\|f\| = 0$ implies that $f(x) = 0$ almost everywhere in $[a, b]$. The space of L^2 functions is then defined by identifying functions that are equal almost everywhere (meaning that their difference is zero almost everywhere). This can be formalized by making this identification into an equivalence relation and defining L^2 to be the set of equivalence classes. Then the norm is defined on an equivalence class by defining it on any function in the equivalence class. Similar considerations apply to the L^p spaces and Sobolev spaces introduced in [Chapter 10](#).

The properties of $L^2(a, b)$ that we need can be summarized in the following theorem, which we state without proof. The theorem is proved in Rudin's text [38], where a more extensive treatment of Lebesgue integration can also be found.

Theorem 7.2. *The following properties hold for the $L^2(a, b)$ norm:*

1. $L^2(a, b)$ is complete in the L^2 norm, and
2. every $L^2(a, b)$ function f can be approximated in norm by continuous functions. That is, there is a sequence $\{f_k\}$ of continuous functions on $[a, b]$ such that $\|f - f_k\| \rightarrow 0$ as $k \rightarrow \infty$.

A series $\sum_{n=1}^{\infty} f_n(x)$ of functions converges pointwise in an interval I if the partial sums $S_N(x) = \sum_{n=1}^N f_n(x)$ converge as a sequence of numbers,

$$\lim_{N \rightarrow \infty} S_N(x) = S(x)$$

for each $x \in I$. The convergence is *uniform* on I if

$$\lim_{N \rightarrow \infty} \sup_{a \leq x \leq b} |S_N(x) - S(x)| = 0,$$

that is, $\|S_N - S\|_{\max} \rightarrow 0$ as $N \rightarrow \infty$. Note that if $S_N \rightarrow S$ uniformly, then $S_N \rightarrow S$ pointwise.

The series converges in L^2 if $\|S_N - S\|_2 \rightarrow 0$ as $N \rightarrow \infty$. This is also called *mean-square* convergence.

7.3. Pointwise Convergence of Fourier Series

A classic result in Fourier analysis is the proof of pointwise convergence for the full Fourier series (Chapter 6) of a 2π -periodic function f . To start, let's assume f is C^1 on \mathbb{R} . Then we want to show

$$f(x) = \frac{a_0}{2} + \sum_{n=1}^{\infty} (a_n \cos nx + b_n \sin nx),$$

in which the coefficients are given by the Euler formulas (Chapter 6):

$$\begin{pmatrix} a_n \\ b_n \end{pmatrix} = \frac{1}{\pi} \int_{-\pi}^{\pi} f(x) \begin{pmatrix} \cos nx \\ \sin nx \end{pmatrix} dx, \quad n \geq 0.$$

To prove pointwise convergence of the series, we fix $x \in [-\pi, \pi]$, and consider the partial sums:

$$S_N(x) = \frac{a_0}{2} + \sum_{n=1}^N (a_n \cos nx + b_n \sin nx).$$

We insert the Euler formulas for the coefficients and manipulate the finite sum:

$$\begin{aligned} S_N(x) &= \frac{1}{2\pi} \int_{-\pi}^{\pi} f(t) dt \\ &\quad + \frac{1}{\pi} \sum_{n=1}^N \left(\int_{-\pi}^{\pi} f(t) \cos nt \cos nx dt + \int_{-\pi}^{\pi} f(t) \sin nt \sin nx dt \right) \\ &= \frac{1}{\pi} \int_{-\pi}^{\pi} f(t) \left\{ \frac{1}{2} + \sum_{n=1}^N \cos nt \cos nx + \sin nt \sin nx \right\} dt \\ &= \frac{1}{\pi} \int_{-\pi}^{\pi} f(t) \left\{ \frac{1}{2} + \sum_{n=1}^N \cos n(t-x) \right\} dt. \end{aligned}$$

To make progress with the integral, consider the sum

$$P_N(\theta) = \frac{1}{2} + \sum_{n=1}^N \cos n\theta = \frac{1}{2} + \cos \theta + \cdots + \cos N\theta, \quad \theta = t - x. \quad (7.8)$$

It is convenient to use complex exponentials (recall that $e^{\pm i\xi} = \cos \xi \pm i \sin \xi$):

$$P_N(\theta) = \frac{1}{2} \left(1 + \sum_{n=1}^N (e^{in\theta} + e^{-in\theta}) \right) = \frac{1}{2} \sum_{n=-N}^N e^{in\theta}.$$

This is a partial sum of a geometric series with ratio $e^{i\theta}$, so that

$$P_N(\theta) = \frac{1}{2} \left(\frac{e^{-iN\theta} - e^{i(N+1)\theta}}{1 - e^{i\theta}} \right) = \frac{1}{2} \frac{\sin(N + \frac{1}{2})\theta}{\sin \theta/2}.$$

The *Dirichlet kernel* is defined to be $D_N(\theta) = \frac{1}{\pi} P_N(\theta)$. Considering the form (7.8) for $P_N(\theta)$, we deduce the following properties:

1. $D_N(\theta)$ is even and 2π periodic,
2. $\int_{-\pi}^{\pi} D_N(\theta) d\theta = 1$, and
3. $D_N(0) = \frac{1}{\pi} (N + \frac{1}{2})$.

From these properties, as $N \rightarrow \infty$, $D_N(0) \rightarrow \infty$ while the area $\int_{-\pi}^{\pi} D_N(\theta) d\theta$ remains constant. We found similar behavior in [Section 5.1](#) for the heat kernel $\Phi(x, t)$ as $t \rightarrow 0^+$. Consequently, as $N \rightarrow \infty$, we might expect that $D_N(\theta)$ approaches the Dirac delta function. If so, then for a continuous function f ,

$$\begin{aligned}
S_N(x) &= \int_{-\pi}^{\pi} f(t) D_N(t-x) dt \\
&= \int_{-\pi}^{\pi} f(x+\theta) D_N(\theta) d\theta \rightarrow f(x) \quad \text{as } N \rightarrow \infty.
\end{aligned}$$

However, in contrast to the heat kernel, $D_N(\theta)$ does not approach zero for $\theta \neq 0$, as $N \rightarrow \infty$. Instead, to take the limit, we appeal to the Riemann-Lebesgue Lemma.

Lemma 7.3. *(The Riemann-Lebesgue Lemma) If $f \in L^2(a, b)$, then*

$$\int_a^b f(x) \sin \beta x \, dx \rightarrow 0 \quad \text{as } \beta \rightarrow \infty.$$

When f is C^1 on $[a, b]$, the result follows easily by integration by parts, since both $|f|$ and $|f'|$ are bounded, and integrating $\sin \beta x$ introduces a factor of $1/\beta$. The proof is completed by approximating f by smooth functions, as in [Theorem 7.2](#). Details can be found in many analysis texts [\[38\]](#).

Proof of convergence of $S_N(x)$ to $f(x)$. Returning to the partial sums $S_N(x)$, we use property (2) of $D_N(\theta)$ to write

$$\begin{aligned}
|S_N(x) - f(x)| &= \left| \int_{-\pi}^{\pi} (f(x+\theta) - f(x)) D_N(\theta) d\theta \right| \\
&= \left| \frac{1}{\pi} \int_{-\pi}^{\pi} g(\theta) \sin(N + \frac{1}{2})\theta d\theta \right|, \tag{7.9}
\end{aligned}$$

where

$$g(\theta) = \begin{cases} \frac{f(x+\theta) - f(x)}{2 \sin \theta/2}, & \theta \neq 0, \\ f'(x), & \theta = 0, \end{cases} \tag{7.10}$$

from L'Hôpital's rule at $\theta = 0$. Since g is continuous, we can apply the Riemann-Lebesgue Lemma 7.3, which establishes that $|S_N(x) - f(x)| \rightarrow 0$ as $N \rightarrow \infty$. ■

With a bit more care, we can prove pointwise convergence for *piecewise smooth* periodic functions. These are periodic functions f that, in every bounded interval, are continuously differentiable apart from a finite number of points where either the function or its derivative has a jump discontinuity (meaning the left and right limits exist but are not equal).

Theorem 7.4. *Let f be piecewise smooth and 2π periodic. Then the Fourier series for f converges at each x to the average of the left and right limits of f :*

$$\frac{1}{2} (f(x^+) + f(x^-)) = \frac{a_0}{2} + \sum_{n=1}^{\infty} (a_n \cos nx + b_n \sin nx),$$

where

$$\begin{pmatrix} a_n \\ b_n \end{pmatrix} = \frac{1}{\pi} \int_{-\pi}^{\pi} f(x) \begin{pmatrix} \cos nx \\ \sin nx \end{pmatrix} dx, \quad n \geq 0.$$

Note that at points x of continuity, the theorem guarantees that the series converges to $f(x)$.

Proof. Using the notation defined in the theorem, we estimate the error made by the N th partial sum. Let x be a specific point, $-\pi < x \leq \pi$. Then

$$\begin{aligned} & |S_N(x) - \frac{1}{2}(f(x^+) + f(x^-))| \\ & \leq \left| \int_{-\pi}^0 (f(x + \theta) - f(x^-)) D_N(\theta) d\theta \right| \\ & \quad + \left| \int_0^{\pi} (f(x + \theta) - f(x^+)) D_N(\theta) d\theta \right| \\ & = I_- + I_+. \end{aligned}$$

In this calculation, we have split the integral, and used the fact that $P_N(\theta)$ is even in θ , followed by the triangle inequality. Note that the integrand in each integral is continuous at $\theta = 0$.

To show that each integral approaches zero, we use the Riemann-Lebesgue Lemma 7.3. Mimicking the development of (7.9) and (7.10), we have to check that the corresponding $g(\theta)$ here satisfies the conditions of the lemma. Consider the first integral. Paralleling the $f \in C^1$ case, we let

$$g(\theta) = \begin{cases} \frac{f(x + \theta) - f(x^-)}{2 \sin \theta/2}, & -\pi \leq \theta < 0, \\ f'(x^-), & \theta = 0. \end{cases}$$

Then g is piecewise continuous, and hence integrable, on $-\pi \leq \theta \leq 0$. A similar construction applies to the second integral, I_+ . ■

7.4. Uniform Convergence of Fourier Series

Theorem 7.4 shows that a Fourier series can converge pointwise even if the function it represents is not smooth everywhere. This can be important for the study of PDE. For example, solutions of the wave equation describing the vibrations of a violin string that has been plucked at one point are continuous but

not differentiable. Discontinuities in the derivative propagate along characteristics and are reflected at the ends of the string. Such a solution can also be represented by a Fourier series that converges pointwise.

In this section we prove in [Theorem 7.5](#) that the pointwise convergence of the previous section is in fact uniform if f is sufficiently smooth. This result uses Bessel's inequality, which will also arise in the context of L^2 convergence. Let $\{v_n\}_{n=1}^{\infty} \subset L^2(a, b)$ be a set of orthonormal functions, meaning that $(v_j, v_k) = \delta_{jk}$, $j, k = 1, 2, \dots$

For $f \in L^2[a, b]$ and $\{c_n\}_{n=1}^{\infty}$ a sequence of real numbers, the mean-square error E_N obtained from approximating f by the linear combination $\sum_{n=1}^N c_n v_n$ is defined to be

$$E_N = \|f - \sum_{n=1}^N c_n v_n\|^2.$$

Then

$$\begin{aligned} 0 \leq E_N &= \|f - \sum_{n=1}^N c_n v_n\|^2 = (f - \sum_{n=1}^N c_n v_n, f - \sum_{n=1}^N c_n v_n) \\ &= \|f\|^2 - 2 \sum_{n=1}^N c_n (f, v_n) + \sum_{n=1}^N \sum_{j=1}^N c_n c_j (v_n, v_j) \\ &= \|f\|^2 - 2 \sum_{n=1}^N c_n (f, v_n) + \sum_{n=1}^N c_n^2. \end{aligned}$$

Completing the square, we find

$$E_N = \|f\|^2 + \sum_{n=1}^N ((f, v_n) - c_n)^2 - \sum_{n=1}^N (f, v_n)^2.$$

Consequently, E_N is minimized by choosing the coefficients c_n to be the *Fourier coefficients*, defined in this general context by

$$c_n = (f, v_n). \tag{7.11}$$

With this choice, and since $E_N \geq 0$, we also conclude:

$$\sum_{n=1}^N (f, v_n)^2 \leq \|f\|^2, \tag{7.12}$$

which is known as *Bessel's inequality*. In terms of the coefficients of [\(7.11\)](#),

$$\sum_{n=1}^N c_n^2 \leq \int_a^b f(x)^2 dx = \|f\|^2.$$

Thus, the infinite series $\sum_{n=1}^{\infty} c_n^2$ is convergent and the limit is no larger than $\|f\|^2$. In particular, we have the important result that

$$(f, v_n) \rightarrow 0, \quad \text{as } n \rightarrow \infty,$$

a result closely related to the Riemann-Lebesgue Lemma 7.3.

We are ready to prove the following theorem on uniform convergence of Fourier series for smooth functions f . The essence of the proof is to apply Bessel's inequality to get a bound on the Fourier coefficients for the derivative f' . This is enough to give a strong uniform estimate on the Fourier series for f .

Theorem 7.5. *Let $f: \mathbb{R} \rightarrow \mathbb{R}$ be a C^1 2π -periodic function. Then the Fourier series of f converges uniformly.*

Proof. Since f' is continuous, it is integrable on $[-\pi, \pi]$. Therefore, f' has a Fourier series. Moreover, since f is periodic, the constant term in the series for f' is zero. Thus,

$$f'(x) \sim \sum_{n=1}^{\infty} (A_n \cos nx + B_n \sin nx),$$

and we have Bessel's inequality (7.12):

$$\sum_{n=1}^{\infty} (A_n^2 + B_n^2) \leq \frac{1}{\pi} \int_{-\pi}^{\pi} f'(x)^2 dx, \quad (7.13)$$

Therefore, $\sum_{n=p}^q (|A_n|^2 + |B_n|^2) \rightarrow 0$ as $p, q \rightarrow \infty$.

Not surprisingly, the Fourier coefficients a_n, b_n of f are related to the coefficients A_n, B_n of f' by integration:

$$a_n = \frac{1}{\pi} \int_{-\pi}^{\pi} f(x) \cos nx dx = \frac{1}{\pi} \frac{\sin nx}{n} f(x) \Big|_{-\pi}^{\pi} - \frac{1}{\pi} \int_{-\pi}^{\pi} f'(x) \frac{\sin nx}{n} dx, \quad (7.14)$$

so that

$$a_n = -\frac{1}{n} B_n, \quad n \geq 1,$$

and similarly,

$$b_n = \frac{1}{n} A_n, \quad n \geq 1.$$

To show uniform convergence, we verify the Cauchy criterion, for which we estimate how close the partial sums become:

$$\left| \sum_{n=p}^q (a_n \cos nx + b_n \sin nx) \right| \leq \sum_{n=p}^q (|a_n| + |b_n|) = \sum_{n=p}^q \frac{1}{n} (|A_n| + |B_n|).$$

Using the Schwarz inequality, we can make this sum small as $p, q \rightarrow \infty$:

$$\begin{aligned} & \sum_{n=p}^q \frac{1}{n} (|A_n| + |B_n|) \\ & \leq \sqrt{2} \left(\sum_{n=p}^q \frac{1}{n^2} \right)^{\frac{1}{2}} \left(\sum_{n=p}^q (|A_n|^2 + |B_n|^2) \right)^{\frac{1}{2}} \rightarrow 0, \quad \text{as } p, q \rightarrow \infty. \end{aligned}$$

■

Remark. The integration by parts in (7.14) to relate Fourier coefficients of the function to those of derivatives generalizes to higher derivatives when they are available. Since each integration pulls down another factor $\frac{1}{n}$, we see that the regularity of the function is closely linked to the rate of convergence of the Fourier coefficients.

7.5. Convergence in L^2

For PDE, it is often natural to work in L^2 spaces, using both the inner product and completeness.

Lemma 7.6. *Let $f \in L^2(a, b)$, and suppose $\{v_n\}_{n=1}^{\infty}$ is an orthonormal set in $L^2(a, b)$. Then the series $\sum_{n=1}^{\infty} (f, v_n)v_n$ is convergent in L^2 and*

$$\left\| \sum_{n=1}^{\infty} (f, v_n)v_n \right\| \leq \|f\|.$$

Proof. From Bessel's inequality, we see that the series of coefficients

$$\sum_{n=1}^{\infty} (f, v_n)^2$$

is convergent. Thus, the series satisfies the Cauchy condition for convergence, so that using orthogonality, we have

$$\left\| \sum_p^q (f, v_n)v_n \right\|^2 = \sum_p^q (f, v_n)^2 \rightarrow 0 \quad \text{as } p, q \rightarrow \infty.$$

That is, $S_N = \sum_{n=1}^N (f, v_n)v_n$ is a Cauchy sequence in $L^2(a, b)$. Completeness of the

space means that the series converges to an $L^2(a, b)$ function. Moreover, applying orthogonality and Bessel's inequality again, we have

$$\left\| \sum_{n=1}^{\infty} (f, v_n) v_n \right\|^2 = \lim_{N \rightarrow \infty} \|S_N\|^2 = \lim_{N \rightarrow \infty} \sum_{n=1}^N (f, v_n)^2 \leq \|f\|^2. \quad \blacksquare$$

Now that we know the infinite series $\sum_{n=1}^{\infty} (f, v_n) v_n$ is convergent, we would like to know whether it converges to f in $L^2(a, b)$. A necessary condition is that if f is orthogonal to all the v_n , then $f = 0$. That is, $(f, v_n) = 0$ for all n implies $f = 0$. In fact, we can now provide a simple proof that not only is this condition necessary and sufficient, but it is equivalent to having equality in Bessel's inequality.

Theorem 7.7. *If $\{v_n\}_{n=1}^{\infty}$ is an orthonormal set in $L^2(a, b)$, then the following three conditions are equivalent:*

1. *If $(f, v_n) = 0$ for all n , then $f = 0$.*
2. *For each $f \in L^2(a, b)$, $f = \sum_{n=1}^{\infty} (f, v_n) v_n$.*
3. *Parseval's identity holds for every $f \in L^2(a, b)$:*

$$\|f\|^2 = \sum_{n=1}^{\infty} (f, v_n)^2. \quad (7.15)$$

Proof. We write the proof in three parts, showing condition $1 \Rightarrow 2 \Rightarrow 3 \Rightarrow 1$.

Condition $1 \Rightarrow 2$: Let $f \in L^2(a, b)$. Then Lemma 7.6 shows that

$$\sum_{n=1}^{\infty} (f, v_n) v_n$$

converges. To see that it converges to f , consider the function

$$g = f - \sum_{n=1}^{\infty} (f, v_n) v_n.$$

Then g is orthogonal to every v_k :

$$(g, v_k) = (f, v_k) - \sum_{n=1}^{\infty} (f, v_n) (v_n, v_k) = 0.$$

Thus, by condition 1, we have $g = 0$.

Condition $2 \Rightarrow 3$: Suppose $f = \sum_{n=1}^{\infty} (f, v_n) v_n$. Then orthogonality of $\{v_n\}$ implies

$$\|f\|^2 = \lim_{N \rightarrow \infty} \left\| \sum_{n=1}^N (f, v_n) v_n \right\|^2 = \lim_{N \rightarrow \infty} \sum_{n=1}^N (f, v_n)^2 = \sum_{n=1}^{\infty} (f, v_n)^2.$$

Condition 3 \Rightarrow 1: Suppose Parseval's identity holds for $f \in L^2(a, b)$. If $(f, v_n) = 0$ for all n , then $\|f\| = 0$, which implies $f = 0$. ■

A given orthonormal set of functions $\{v_n\}_{n=1}^\infty$ is *complete* if any of the three conditions of the theorem hold. In this case, condition 2 means that the set is an *orthonormal basis* for $L^2(a, b)$.

Example 3. (An orthonormal basis) The set $\{\frac{1}{\sqrt{2\pi}}, \frac{1}{\sqrt{\pi}} \cos nx, \frac{1}{\sqrt{\pi}} \sin nx\}_{n=1}^\infty$ is an orthonormal basis for $L^2(-\pi, \pi)$. This can be proved by approximating $f \in L^2(-\pi, \pi)$ by a continuous function h on $[-\pi, \pi]$. Then h is approximated uniformly by the partial sums of its Fourier series, hence also in L^2 . Using orthogonality and the triangle inequality, we can show that f is approximated by the partial sums of its Fourier series.

7.5.1. More General Result for Sturm-Liouville Problems

It is convenient to state (without proof) two further properties of the eigenvalue problem, in addition to those of [Theorem 7.1](#). Recall that \mathcal{L} is the differential operator associated with the Sturm-Liouville problem of [Section 7.1](#).

Theorem 7.8. *Let \mathcal{L} be symmetric. Then*

1. *The eigenvalues form a countable set that is bounded below but not above:*

$$\lambda_1 < \lambda_2 \leq \dots \leq \lambda_n \leq \dots$$

Each eigenvalue has finite multiplicity, λ_1 is a simple eigenvalue, and $\lambda_n \rightarrow \infty$ as $n \rightarrow \infty$.

2. *The eigenfunctions v_n can be chosen to form a complete orthonormal set on $L^2(a, b)$.*

For a proof of this result, see Strauss [45]. Note that part 2 of the theorem tells us that Fourier series of $L^2(a, b)$ functions converge in L^2 .

Parseval's identity establishes that the correspondence between the L^2 function f and its sequence of Fourier coefficients $\{c_n\}$, is an *isometry*, in the sense that the mapping $f \rightarrow \{c_n\}$ preserves the norm.

7.5.2. Gibbs Phenomenon

The Fourier series of a discontinuous function does not converge uniformly, even though it converges pointwise. The Gibbs phenomenon¹ is the observation that at each discontinuity, the Fourier series overshoots the function by roughly 9%. The overshoot appears as a persistently excessive maximum in the oscillating partial sums of the Fourier series.

Without loss of generality, we can look at this phenomenon by considering a simple discontinuous function, namely, a step function. Although this seems like a special example, it in fact embodies the essence of how the Gibbs phenomenon is manifested. This is because a piecewise continuous function can be written as the sum of a smooth function and a weighted sum of a finite number of Heaviside functions.

Let f be the 2π -periodic extension of the function

$$f(x) = \begin{cases} 1, & \text{if } 0 < x < \pi, \\ -1, & \text{if } -\pi < x < 0, \\ 0, & \text{if } x = 0. \end{cases}$$

Since f is odd, it has a Fourier sine series, which we easily calculate, and by the pointwise convergence theorem, we have

$$f(x) = \sum_{n=1}^{\infty} b_n \sin nx, \quad -\pi < x < \pi,$$

where $b_n = (2/n\pi)(1 - (-1)^n)$, $n = 1, 2, \dots$. Thus,

$$f(x) = \frac{4}{\pi} \sum_{n \text{ odd}} \frac{1}{n} \sin nx, \quad -\pi < x < \pi. \quad (7.16)$$

We get a good idea of the Gibbs phenomenon by graphing the partial sums $S_N(x)$ for moderately large N . (See [Figure 7.1](#).) Note that the graph $y = S_N(x)$ (N odd) crosses the line $y = 1$ exactly $N + 1$ times in the interval $(0, \pi)$, and the maximum appears to be at approximately $x_N = \pi/(N + \frac{1}{2})$ (and at $\pi - x_N$.) In fact

$$S_N(x_N) \rightarrow \frac{1}{\pi} \int_{-\pi}^{\pi} \frac{\sin \theta}{\theta} d\theta \approx 1.18 \quad \text{as } N \rightarrow \infty$$

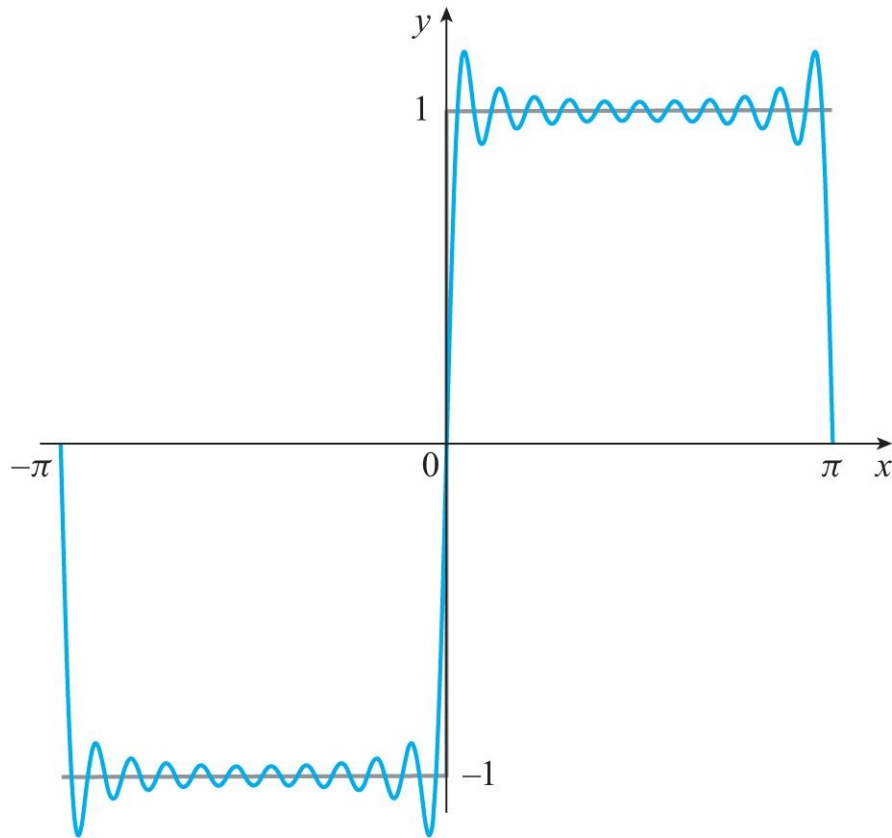

Figure 7.1. The Gibbs phenomenon. The partial sum $S_{21}(x)$ of Fourier series (7.16) is shown.

(see Strauss [45]). Thus, $S_N(x)$ overshoots $f(x) = 1$ by 0.18, or approximately 9% of the jump in $f(x)$ across $x = 0$. Incidentally, this example shows the danger in reversing the order of two limits:

$$\lim_{x \rightarrow 0^+} \lim_{N \rightarrow \infty} S_N(x) = 1 \neq 0 = \lim_{N \rightarrow \infty} \lim_{x \rightarrow 0^+} S_N(x).$$

7.6. Fourier Transform

Fourier transforms and other transforms, such as the Laplace transform, are useful tools to transform equations or data into forms that are easier to analyze or solve. In this section we explore some of the properties of the Fourier transform, drawing comparisons to Fourier series and showing how the Fourier transform is used to solve certain PDE.

The Fourier series of a periodic function, say of period 2π , decomposes the function into pieces each with a different integer frequency k , with the Fourier coefficients being the amplitude at that frequency. This point of view is clearest in the complex form

$$f(x) = \sum_{k=-\infty}^{\infty} c_k e^{ikx}, \quad (7.17)$$

with the (complex) amplitudes c_k given by

$$c_k = \frac{1}{2\pi} \int_{-\pi}^{\pi} f(x) e^{-ikx} dx. \quad (7.18)$$

Of course, for a real-valued function f , $\overline{c_k} = c_{-k}$. We can regard c_k as a function from the set \mathbb{Z} of integers to \mathbb{C} , the complex numbers. The periodic function f has been transformed into the sequence $\{c_k\}_{-\infty}^{\infty}$. Then the series (7.17) is the inverse transform; it gets us from the sequence $\{c_k\}_{-\infty}^{\infty}$ back to f . We have seen how this transform to Fourier coefficients and back again is useful when solving PDE on bounded domains. The Fourier transform is a similar technique for functions on unbounded domains.

The *Fourier transform* of a function $f: \mathbb{R} \rightarrow \mathbb{R}$ that is absolutely integrable,

$$\int_{-\infty}^{\infty} |f(x)| dx < \infty,$$

is a function $\hat{f}: \mathbb{R} \rightarrow \mathbb{C}$ that looks a bit like (7.18):

$$\hat{f}(\omega) = \int_{-\infty}^{\infty} f(x) e^{-i\omega x} dx. \quad (7.19)$$

Thus, $\hat{f}(\omega)$ is the complex amplitude contribution to the function f at frequency ω . We reconstruct the function f from these amplitudes with the inverse transform:

$$f(x) = \frac{1}{2\pi} \int_{-\infty}^{\infty} \hat{f}(\omega) e^{i\omega x} d\omega. \quad (7.20)$$

Notice that the infinite sum in (7.17) has been replaced by an integral. In the Fourier transform, the frequency is a continuous variable ω , and there is a sign change in the exponential between the transform and the inverse transform.

We have also placed the factor $1/(2\pi)$ in the inverse transform rather than in the transform. A more symmetric placement commonly used is to have a factor of $1/\sqrt{2\pi}$ in both the transform and its inverse. It is also consistent to have the $1/(2\pi)$ in only the transform. Of course, just as for the convergence of Fourier series to the periodic function $f(x)$, the identity (7.20) requires proof. You can find the proof in standard texts on Fourier analysis (for example, see Stade [44]); our purpose in this section is to illustrate how the transform is used. Along the way, we find some interesting properties.

One more bit of intuition about the Fourier transform. Consider an experiment that is performed over a long time, and the result is a measurement $f(t)$, $t_0 < t < t_1$ (known as a time series) that is very noisy. The measurement will be at discrete values of time t , but for the purpose of discussion (and you can imagine how to make sense of this), we regard f as a function of t , and extend f to

the whole real line. Now take the Fourier transform to get a new function $\hat{f}(\omega)$, and plot the graph of \hat{f} . Recall that the transform records the amplitude of f at each frequency, so if the graph of \hat{f} shows clear maxima at a finite number of frequencies ω_n , $n = 1, \dots, N$, then the function is dominated a combination of periodic functions at those frequencies, with the amplitudes given by $\hat{f}(\omega_n)$, $n = 1, \dots, N$. This is a central idea in signal processing, where some sense can be made out of a noisy signal—the time series—by investigating the Fourier transform.

Another transform you may be familiar with is the Laplace transform, which is most useful in the context of initial value problems for ODE and PDE, because it is defined for integrable functions on the half-line $[0, \infty)$. Other transforms are useful for different contexts. For example, the Radon transform of functions in two or three dimensions is used in tomography to express the function (typically a density) in terms of scattering data that might come from a scan, such as an x-ray, ultrasound, or magnetic resonance imaging.

Example 4. (Computing a transform) To show how the transform is computed in a simple example, let $f: \mathbb{R} \rightarrow \mathbb{R}$ be defined by

$$f(x) = \begin{cases} 1, & |x| < a, \\ 0, & |x| > a. \end{cases}$$

Then

$$\hat{f}(\omega) = \int_{-a}^a e^{-i\omega x} dx = \frac{2}{\omega} \sin \omega a.$$

To apply the transform to differential equations, we transform derivatives using integration by parts and observing that $f(\pm\infty) = 0$ (since $|f|$ is integrable on \mathbb{R}), to eliminate the boundary terms:

$$\frac{d\hat{f}}{d\omega}(\omega) = \frac{1}{2\pi} \int_{-\infty}^{\infty} f'(x) e^{-i\omega x} dx = (i\omega) \hat{f}(\omega).$$

Example 5. (The Cauchy problem for the heat equation) Consider the Cauchy problem for the heat equation

$$u_t = ku_{xx}, \quad -\infty < x < \infty, \quad t > 0, \quad u(x, 0) = f(x), \quad -\infty < x < \infty. \quad (7.21)$$

The solution $u = u(x, t)$ was obtained from the fundamental solution in [Section 5.2](#). Here we show how the same formula can be obtained using Fourier transform in x for each t .

The solution of (7.21) by Fourier transform depends on some further

properties of the transform. If f, g are in $L^2(\mathbb{R})$, then

$$\widehat{f * g} = \widehat{f} \widehat{g}. \quad (7.22)$$

The compactness of this formula is the reason for putting the $1/(2\pi)$ normalizing factor in the inverse rather than in the transform. The proof of (7.22) involves a simple change of variables $z = x - y$:

$$\begin{aligned} \widehat{f * g}(\omega) &= \int_{-\infty}^{\infty} f * g(x) e^{-i\omega x} dx = \int_{-\infty}^{\infty} \int_{-\infty}^{\infty} f(y)g(x - y) e^{-i\omega x} dy dx \\ &= \int_{-\infty}^{\infty} \int_{-\infty}^{\infty} f(y)g(z) e^{-i\omega z} e^{-i\omega y} dy dz = \widehat{f}(\omega) \widehat{g}(\omega). \end{aligned}$$

We also have

$$\begin{aligned} \widehat{e^{-ax^2}}(\omega) &= \int_{-\infty}^{\infty} e^{-ax^2} e^{-i\omega x} dx = \int_{-\infty}^{\infty} e^{-a(x + i\omega/(2a))^2} e^{-\omega^2/(4a)} dx \\ &= \frac{1}{\sqrt{a}} \int_{-\infty}^{\infty} e^{-y^2} dy e^{-\omega^2/(4a)} = \sqrt{\frac{\pi}{a}} e^{-\omega^2/(4a)}. \end{aligned} \quad (7.23)$$

We transform everything in (7.21) with respect to x , using $\widehat{u}_t(\omega, t) = \widehat{u}_t(\omega, t)$ to transform u_t :

$$\widehat{u}_t(\omega, t) = -k\omega^2 \widehat{u}(\omega, t); \quad \widehat{u}(\omega, 0) = \widehat{f}(\omega).$$

Thus, $\widehat{u}(\omega, t) = \widehat{f}(\omega) e^{-k\omega^2 t}$. Let $a = 1/(4kt)$ in (7.23). Then (7.22) and (7.23) imply that

$$u(x, t) = \frac{1}{\sqrt{4\pi kt}} \int_{-\infty}^{\infty} e^{-(x - y)^2/4kt} f(y) dy.$$

This is exactly the formula that we found in Section 5.2.

PROBLEMS

1. Let $\mathcal{L}u(x) = a(x)u''(x) + b(x)u'(x) + c(x)u(x)$, where a, b, c are given C^2 functions on the interval $0 \leq x \leq 1$. Consider C^2 functions u, v on $[0, 1]$ satisfying Dirichlet conditions $u = v = 0$ at $x = 0, 1$. Find an ordinary differential operator \mathcal{L}^* such that

$$(\mathcal{L}u, v) = (u, \mathcal{L}^*v).$$

2. Let $r : [a, b] \rightarrow (0, \infty)$ be C^2 , and consider the eigenvalue problem (7.1). Using the weighted L^2 space with inner product (7.2), prove that eigenvalues are real and the corresponding eigenfunctions are orthogonal.

3. Let the piecewise continuous function $f : \mathbb{R} \rightarrow \mathbb{R}$ be defined by

$$f(x) = \begin{cases} 1, & x < 0, \\ x, & 0 \leq x < 3, \\ e^{-x}, & 3 \leq x < 4, \\ 0, & x > 4. \end{cases}$$

Write $f(x)$ as a sum of a continuous function and a linear combination of Heaviside functions.

4. Fill in the details of [Example 3](#) in [Section 7.5](#): prove L^2 convergence of the Fourier series of an L^2 function, using approximation and uniform convergence.

5. Let $f, g : \mathbb{R} \rightarrow \mathbb{R}$ be differentiable and have the property that they and their first derivatives are absolutely integrable over \mathbb{R} . Prove that

$$(f * g)' = f' * g + f * g'.$$

6. Consider the Fourier transform of a band-limited function $f(x)$, in which $\hat{f}(\omega) = 0, |\omega| > \pi$.

(a) Show that $\hat{f}(\omega) = \sum_{-\infty}^{\infty} f(n)e^{-in\omega}$ for $|\omega| \leq \pi$.

(b) Hence deduce that $f(x)$ only depends on the sequence $\{f(n)\}$ of sampled values of f :

$$f(x) = \frac{1}{\pi} \sum_{n=-\infty}^{\infty} f(n) \frac{\sin(x - n)}{x - n}.$$

7. The pointwise convergence of Fourier series can be used to deduce the sums of certain kinds of infinite sequences.

(a) Start with calculating the Fourier series of the even 2π -periodic function $f(x) = |\sin x|$. Use the Fourier series to calculate the sums

$$\sum_{n=1}^{\infty} \frac{1}{4n^2 - 1}, \quad \sum_{n=1}^{\infty} \frac{(-1)^n}{4n^2 - 1}.$$

(b) Choose a suitable even 2 -periodic function $f(x)$ whose Fourier series allows you to determine the sums

$$\sum_{n=1}^{\infty} \frac{1}{n^2}, \quad \sum_{n=1}^{\infty} \frac{(-1)^n}{n^2}.$$

1. Josiah Willard Gibbs (1839–1903) made many contributions to thermodynamics, statistical mechanics, and other areas of science and mathematics, including vector analysis. The Gibbs phenomenon was discovered and explained by the English mathematician Henry Wilbraham in 1848; nearly 50 years later it was found independently by Gibbs.

Laplace's Equation and Poisson's Equation

In this chapter we consider Laplace's equation and its inhomogeneous counterpart, Poisson's equation, which are prototypical elliptic equations.¹ They may be thought of as time-independent versions of the heat equation, with and without source terms:

$$\begin{aligned}\Delta u(\mathbf{x}) &= 0 && \text{(Laplace's equation),} \\ -\Delta u(\mathbf{x}) &= f(\mathbf{x}) && \text{(Poisson's equation).}\end{aligned}$$

We consider these equations in a domain $U \subset \mathbb{R}^n$, $n \geq 2$, but also on all of \mathbb{R}^n . Applications of these equations include the classical field of potential theory, of importance in electrostatics and steady incompressible fluid flow. In electrostatics, $f(\mathbf{x})$ in Poisson's equation represents a charge density distribution, inducing the electric potential $u(\mathbf{x})$. In two-dimensional steady fluid flow, u is the velocity potential or stream function, both of which satisfy Laplace's equation.

Several properties of solutions of Laplace's equation parallel those of the heat equation: maximum principles, solutions obtained from separation of variables, and the fundamental solution to solve Poisson's equation in \mathbb{R}^n .

8.1. The Fundamental Solution

To solve Poisson's equation, we begin by deriving the *fundamental solution* $\Phi(\mathbf{x})$ for the Laplacian. This fundamental solution is rather different from the one for the heat equation, which is designed to solve initial value problems, and consequently has a singularity at the initial time $t = 0$. The fundamental solution for the Laplacian, being time independent, is used to represent solutions in space alone. To do this, $\Phi(\mathbf{x})$ is chosen to have a singularity at a point \mathbf{x}_0 in the domain; since the Laplacian is translation invariant, we can take $\mathbf{x}_0 = \mathbf{0}$. Moreover, the Laplacian is invariant under rotations, so we can seek a rotationally invariant fundamental solution.

Motivated by this discussion, we seek rotationally symmetric solutions $u(\mathbf{x}) = v(r)$, $r = |\mathbf{x}|$, of Laplace's equation. Then we have

$$\Delta u(x) = v''(r) + \frac{n-1}{r}v'(r) = 0.$$

Therefore,

$$\frac{v''}{v'} = -\frac{n-1}{r}.$$

Integrating, we obtain $\log v' = -(n-1) \log r + C$. That is, $v' = \frac{A}{r^{n-1}}$, where $A = \log C$ is the constant of integration. Integrating again, we get a two-parameter family of solutions

$$v(r) = \begin{cases} \frac{a}{r^{n-2}} + b, & \text{if } n \geq 3, \\ a \log r + b, & \text{if } n = 2. \end{cases}$$

The fundamental solution $\Phi(\mathbf{x})$ is defined by setting $b = 0$ and choosing the constant a to normalize $\Phi(\mathbf{x})$ depending on the volume $\alpha(n)$ of the unit ball:

$$\Phi(\mathbf{x}) = \begin{cases} \frac{1}{n(n-2)\alpha(n)} \frac{1}{|\mathbf{x}|^{n-2}}, & \text{if } n \geq 3, \\ -\frac{1}{2\pi} \log |\mathbf{x}|, & \text{if } n = 2. \end{cases}$$

The purpose of the normalization is to make the formula for the solution of Poisson's equation on \mathbb{R}^n as simple as possible. (See (8.1).) Note that although Φ has an integrable singularity at the origin (Φ is integrable on bounded sets, even though it is not defined at $\mathbf{x} = 0$), we will see that the singularity of $-\Delta\Phi$ is not integrable, and is in fact the singular distribution δ , which we define carefully in Section 9.2.

We say a function u is *harmonic* in an open set $U \subset \mathbb{R}^n$ if $u \in C^2(U)$ and $\Delta u(x) = 0$ for each $x \in U$. By construction, $\Phi(\mathbf{x})$ is harmonic in every open set not containing the origin.

8.2. Solving Poisson's Equation in \mathbb{R}^n

In this section we establish a formula for the solution of Poisson's equation in all space \mathbb{R}^n using the fundamental solution, much as we used the heat kernel to solve the Cauchy problem for the heat equation.

Let $f \in C^2(\mathbb{R}^n)$ have compact support and define

$$u(\mathbf{x}) = (\Phi * f)(\mathbf{x}) = \int_{\mathbb{R}^n} \Phi(\mathbf{x} - \mathbf{y}) f(\mathbf{y}) d\mathbf{y}, \quad (8.1)$$

the convolution product of Φ with f .

Remark. Note that $\Delta\Phi(x)$ has a nonintegrable singularity at the origin. Therefore, we cannot differentiate under the integral sign in this formula. If we could, we would have $\Delta u(x) = 0$, since Φ is harmonic away from the origin.

However, as we now show, the nonintegrable singularity makes the convolution product work to solve Poisson's equation.

Theorem 8.1. *If $f \in C^2(\mathbb{R}^n)$ has compact support and $u(\mathbf{x})$ is given by (8.1), then*

$$-\Delta u(\mathbf{x}) = f(\mathbf{x}), \quad \mathbf{x} \in \mathbb{R}^n.$$

Proof. Changing variables in (8.1), we have

$$u(x) = \int_{\mathbb{R}^n} \Phi(y) f(x - y) dy.$$

Therefore,

$$\Delta u(x) = \int_{\mathbb{R}^n} \Phi(y) \Delta_x f(x - y) dy = \int_{\mathbb{R}^n} \Phi(y) \Delta_y f(x - y) dy.$$

In this integral, and in subsequent calculations, we use subscripts to indicate the variable of differentiation or integration. Thus, Δ_y indicates that the Laplacian is taken with respect to the y variables. We would like to integrate by parts to put Δ back on $\Phi(y)$. However, $\Phi(y)$ has a singularity at $y = 0$, so we have to treat the integral as an improper integral. For $\epsilon > 0$, let $U_\epsilon = \mathbb{R}^n - \overline{B(0, \epsilon)}$, where $B(x, r)$ denotes the open ball of radius r centered at $x \in \mathbb{R}^n$. Then

$$\Delta u(x) = \int_{B(0, \epsilon)} \Phi(y) \Delta_x f(x - y) dy + \int_{U_\epsilon} \Phi(y) \Delta_y f(x - y) dy.$$

The first integral approaches zero as $\epsilon \rightarrow 0$, since Φ is integrable at the origin. We use Green's second identity on the second integral, observing that (since f has compact support) the integrand is identically zero outside a large enough ball centered at x . Thus,

$$\begin{aligned} & \int_{U_\epsilon} \Phi(y) \Delta_y f(x - y) dy \\ &= \int_{\partial B(0, \epsilon)} \left(\Phi(y) \frac{\partial f}{\partial \nu_y}(x - y) - f(x - y) \frac{\partial \Phi}{\partial \nu_y}(y) \right) dS_y \\ & \quad + \int_{U_\epsilon} \Delta \Phi(y) f(x - y) dy. \end{aligned}$$

Incidentally, there is no contribution from the boundary of the support of f , since the integrand is zero there. The final integral is zero since Φ is harmonic in U_ϵ . The integral on the boundary has two terms. The first term converges to zero as $\epsilon \rightarrow 0$, since Φ is integrable at the origin. We need to prove that the second integral converges to $f(x)$.

Since the unit normal ν is outward with respect to U_ϵ on the sphere $\partial B(0, \epsilon)$ we have $\nu = -y/\epsilon$. Therefore, since $\Phi(y)$ is a function of $r = |y|$,

$$\frac{\partial \Phi}{\partial \nu}(y) = - \frac{\partial \Phi}{\partial r}(y) \Big|_{|y|=\epsilon} = \frac{1}{n\alpha(n)\epsilon^{n-1}}.$$

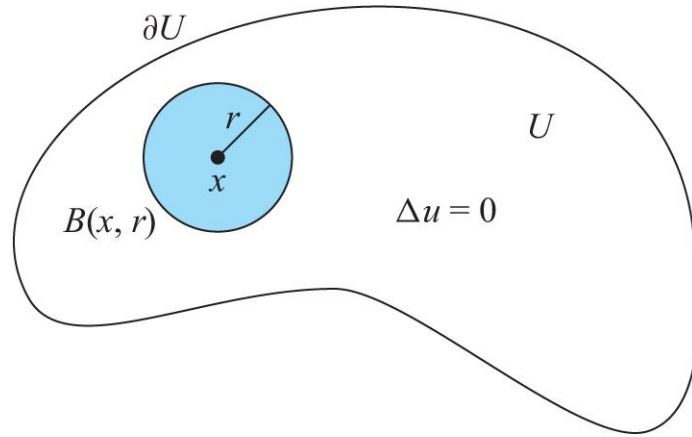

Figure 8.1. A bounded region U .

Note that this formula holds for $n \geq 2$ even though the formula for Φ is different for $n = 2$. Thus,

$$- \int_{\partial B(0, \epsilon)} f(x - y) \frac{\partial \Phi}{\partial \nu_y}(y) dS_y = - \int_{\partial B(0, \epsilon)} f(x - y) dS_y \frac{1}{|\partial B(0, \epsilon)|},$$

where $|\partial B(0, \epsilon)| = n\alpha(n)\epsilon^{n-1}$ denotes the measure of the sphere in \mathbb{R}^n . This integral converges to $f(x)$, because f is continuous. ■

8.3. Properties of Harmonic Functions

In this section we state and prove the mean-value property of harmonic functions, and use it to prove the maximum principle, leading to a uniqueness result for boundary value problems for Poisson's equation. We state the mean-value property in terms of integral averages.

Theorem 8.2. (Mean-Value Property) *Suppose $u \in C^2(U)$. Then u is harmonic in U if and only if it has the mean-value property:*

$$u(x) = \int_{\partial B(x, r)} u(y) dS = \int_{B(x, r)} u(y) dy,$$

for every ball $B(x, r) \subset U$.

Proof. Suppose u is harmonic. Then, for $B(x, r) \subset U$ (see Fig. 8.1),

$$0 = \int_{B(x, r)} \Delta u(y) dy = \int_{\partial B(x, r)} \frac{\partial u}{\partial \nu} dS = \int_{\partial B(x, r)} \nabla u(y) \cdot \frac{y - x}{r} dS_y.$$

Now let

$$\phi(r) = \int_{\partial B(x,r)} u(y) dS_y. \quad (8.2)$$

Since $\lim_{r \rightarrow 0} \phi(r) = u(x)$, we complete the proof by using (8.2) to show that $\phi(r)$ is constant. To do so, we calculate directly that $\phi'(r) = 0$. Let $y = x + rz$, $z \in B(0, 1)$, to facilitate differentiating the integral. Then

$$\begin{aligned} \phi'(r) &= \frac{d}{dr} \int_{\partial B(0,1)} u(x + rz) dS_z \\ &= \int_{\partial B(0,1)} \nabla u(x + rz) \cdot z dS_z \\ &= \int_{\partial B(x,r)} \nabla u(y) \cdot \frac{y - x}{r} dS_y = 0, \end{aligned}$$

by (8.2). Thus, $\phi(r)$ is constant, so that $\phi(r) = \lim_{s \rightarrow 0} \phi(s) = u(x)$.

We use this result to obtain the integral average over the ball $B(x, r)$:

$$\begin{aligned} \int_{B(x,r)} u(y) dy &= \int_0^r \int_{\partial B(x,\rho)} u(y) dS d\rho \\ &= u(x) \int_0^r n\alpha_n \rho^{n-1} d\rho = \alpha_n r^n u(x). \end{aligned}$$

Conversely, suppose u has the mean-value property. Then, as above, we get

$$\phi'(r) = \frac{r}{n} \int_{B(x,r)} \Delta u(y) dy = 0,$$

since $\phi(r) = u(x)$ is constant. Thus, $\int_{B(x,r)} \Delta u(y) dy \equiv 0$, and letting $r \rightarrow 0$, we obtain $\Delta u(x) = 0$, since Δu is continuous in U . ■

The mean-value property of harmonic functions is peculiar to solutions of Laplace's equation and has no counterpart for more general elliptic equations. However, it simplifies the proofs of key results that do generalize, in particular the maximum principle, which we now state in both weak and strong forms.

Theorem 8.3. *(The maximum principle) Let $U \subset \mathbb{R}^n$ be open and bounded, and suppose $u \in C^2(U) \cap C(\bar{U})$ is harmonic in U . Then*

1. *Weak form:* $\max_{x \in \bar{U}} u(x) = \max_{x \in \partial U} u(x)$.

2. *Strong form:* If U is connected, then either $u = \text{constant}$ in \bar{U} , or

$$u(x) < \max_{y \in \partial U} u(y) \quad \text{for all } x \in U.$$

Proof. We prove the strong form first. The weak form then follows easily. Suppose U is connected and there is a point $x_0 \in U$ such that

$$u(x_0) = \max_{x \in \bar{U}} u(x) = M.$$

Choose r so that $B(x, r) \subset U$. Then by the mean-value property,

$$u(x_0) = M = \int_{B(x_0, r)} u(y) dy.$$

But $u(y) \leq M$ everywhere, so equality implies that $u(y) = M$ throughout $B(x_0, r)$. Thus, the set $S = \{x \in U : u(x) = M\}$ is nonempty and open. However, S is also relatively closed in U : Let $x_n \in S$ converge to $x \in U$ as $n \rightarrow \infty$. Then, by continuity of u , we have $u(x) = \lim_{n \rightarrow \infty} u(x_n) = M$, so $x \in S$. But the only nonempty open and closed set in U is U itself, so we have $S = U$, implying that u is constant in \bar{U} . The weak form 1 follows from 2. ■

Remarks. The corresponding *minimum principle* follows by applying the maximum principle to $-u$.

If U is not connected (i.e., $U = U_1 \cup U_2$ with U_1, U_2 disjoint open sets in \mathbb{R}^n), then the weak maximum principle holds, but the strong maximum principle breaks down. To see this, define $u(\mathbf{x}) = k$, for $x \in U_k$, $k = 1, 2$. Then $u(\mathbf{x})$ is harmonic but fails to satisfy either conclusion of part 2 of [Theorem 8.3](#).

We can apply the maximum principle to the *Dirichlet problem*, which is the following boundary value problem on a bounded open set $U \subset \mathbb{R}^n$:

$$\begin{aligned} \Delta u(\mathbf{x}) &= 0, & \mathbf{x} \in U, \\ u(x) &= g(\mathbf{x}), & \mathbf{x} \in \partial U. \end{aligned}$$

Theorem 8.4. *Suppose g is continuous and $u \in C^2(U) \cap C(\bar{U})$ is a solution of the Dirichlet problem. If U is connected and g satisfies $g(x) \geq 0$ for all $x \in \partial U$, and $g(x) > 0$, for some $x \in \partial U$, then*

$$u(x) > 0 \quad \text{for all } x \in U.$$

Proof. From the weak minimum principle, we have $\min_{\bar{U}} u = \min_{\partial U} g$. But the strong version gives either $u(x) > \min_{\partial U} g$, for all $x \in U$, or $u(x) = \text{constant}$. In either case, the conclusion follows. ■

8.3.1. Uniqueness of Solutions of Boundary Value Problems

As with the heat equation, we can prove uniqueness of solutions of boundary value problems from the maximum principle or from energy considerations. Let $U \subset \mathbb{R}^n$ be open and bounded. Consider the boundary value problem with Dirichlet boundary conditions:

$$\begin{aligned} -\Delta u &= f & \text{in } U, \\ u &= g & \text{on } \partial U, \end{aligned} \tag{8.3}$$

where $f \in C(U)$, $g \in C(\partial U)$.

Theorem 8.5. *There is at most one solution $u \in C^2(U) \cap C(\bar{U})$ of the boundary value problem (8.3).*

Proof. Let u_1, u_2 both be solutions. Applying the weak maximum principle to $u_1 - u_2$ and to $u_2 - u_1$, both of which satisfy (8.3) with $f = 0$, $g = 0$, we deduce that $u_1 = u_2$. ■

Alternatively, the energy approach sets $u = u_1 - u_2$ and applies a version of Green's identity:

$$0 = \int_U u \Delta u \, dx = \int_{\partial U} u \frac{\partial u}{\partial \nu} \, dS - \int_U |\nabla u|^2 \, dx.$$

Thus, $\nabla u = 0$ in U , so that u is constant. Since $u = 0$ on ∂U , we conclude that $u = 0$ in \bar{U} , so that $u_1 = u_2$.

8.4. Separation of Variables for Laplace's Equation

If the domain $U \subset \mathbb{R}^n$ has special geometry, then separation of variables can work on Laplace's equation. Examples include rectangular, spherical, and cylindrical domains. Here we treat two examples to illustrate the differences from the heat and wave equations. We then make some remarks about other domains.

Of course, if the boundary conditions are homogeneous, then $u = 0$ is a solution, generally the only solution. So it is more natural to consider linear boundary conditions $\alpha u + \beta \frac{\partial u}{\partial \nu} = g$ on ∂U that are inhomogeneous over at least part of the boundary. If $\alpha \neq 0$, then the energy method discussed in [Section 8.3](#) above can be used to prove that this problem has at most one solution.

8.4.1. Laplace's Equation in a Rectangle

We consider Laplace's equation $\Delta u = 0$ in a rectangular domain $U = (0, a) \times (0, b) \subset \mathbb{R}^2$ with a mixture of Dirichlet and Neumann boundary conditions, representing parts of the boundary where we specify either the temperature u or

the heat flux, which is proportional to the normal derivative.

In this problem we can formulate an eigenvalue problem if boundary conditions on opposite sides of the rectangular boundary are homogeneous. We use this observation to implement a solution strategy. We split the boundary value problem into four problems, setting the boundary condition to zero on three sides in each problem. To illustrate the process, consider the example in [Figure 8.2](#). For $j = 1, 2, 3, 4$, let (P_j) be the problem with $f_k = 0, k \neq j$, and let u_j be the solution of (P_j) . Then by linearity, the solution of the full problem is

$$u = u_1 + u_2 + u_3 + u_4.$$

We solve (P_4) in detail to illustrate this approach.

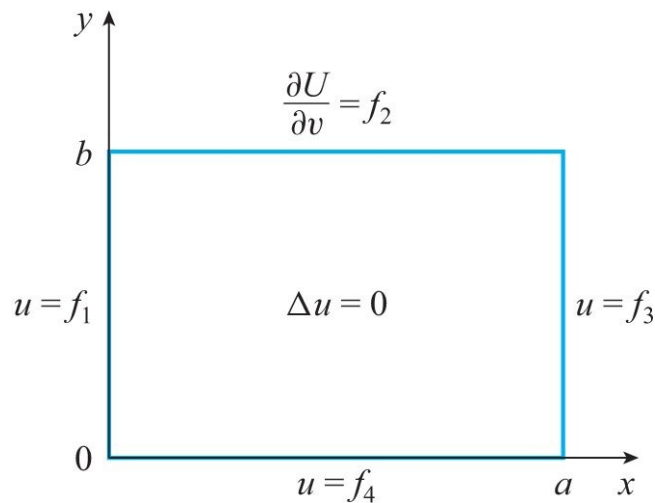

Figure 8.2. Example of a boundary value problem for Laplace's equation.

Let $u = u_4 = v(x)w(y)$. From the boundary conditions, we guess $v(x) = \sin n\pi x/a$, so that $u_4(x, y) = \sin(n\pi x/a) w(y)$. Then $\Delta u(x, y) = 0$ leads to an ODE for $w(y)$:

$$w''(y) - \left(\frac{n\pi}{a}\right)^2 w(y) = 0,$$

with general solution

$$w_n(y) = A_n \cosh \frac{n\pi y}{a} + B_n \sinh \frac{n\pi y}{a}.$$

We need to satisfy a homogeneous boundary condition at $y = b$,

$$\frac{\partial u}{\partial v}(x, b) = 0: \quad w'_n(b) = \frac{n\pi}{a} \left(A_n \sinh \frac{n\pi b}{a} + B_n \cosh \frac{n\pi b}{a} \right) = 0.$$

Thus,

$$B_n = - \tanh \frac{n\pi b}{a} A_n.$$

Now we can form a series to satisfy the nonzero boundary condition at $y = 0$:

$$u_4(x, y) = \sum_{n=1}^{\infty} A_n \sin \frac{n\pi x}{a} \left(\cosh \frac{n\pi y}{a} - \tanh \frac{n\pi b}{a} \sinh \frac{n\pi y}{a} \right). \quad (8.4)$$

On $y = 0$,

$$u(x, 0) = f_4(x) = \sum_{n=1}^{\infty} A_n \sin \frac{n\pi x}{a},$$

from which we get formulas for the coefficients A_n :

$$A_n = \frac{2}{a} \int_0^a f_4(x) \sin \frac{n\pi x}{a} dx.$$

The solution u_4 is then given by the series (8.4). Similarly, we can obtain u_1 , u_2 , u_3 , and finally put these series together to get the solution u of the original problem. Note that the series for u_2 is a sine series like (8.4), but the series for u_1 and u_3 have the form

$$u(x) = \sum_{n=0}^{\infty} v_n(x) \sin \left(n + \frac{1}{2} \right) \frac{\pi y}{b}$$

because of the combination of homogeneous boundary conditions at $y = 0, b$.

8.4.2. Laplace's Equation on Spherical and Cylindrical Domains

In spherical and cylindrical domains, it is natural to use curvilinear coordinates (i.e., polar coordinates and cylindrical coordinates, respectively). Since the Laplacian in these coordinates has nonconstant coefficients, the ODE that result will also have nonconstant coefficients. Moreover, the dimension of the space makes a difference to the type of equation that results. This leads to the study of special functions, specifically, Legendre functions (solutions of Legendre's equation) and Bessel functions (solutions of Bessel's equation). These special functions are typically expressed as series solutions of ODE, using the method of Frobenius. Some details may be found in the PDE book of Strauss [45], in engineering mathematics books, such as Jeffery [26] and Kreyszig [30], and in texts that typically have "PDE" and "Boundary Value Problems" in their titles.

Here we give the detailed solution of Laplace's equation in a disk, leading to Poisson's formula, a representation of the solution as an integral, which we eventually interpret in terms of Green's functions. The disk has the advantage that we do not need special functions to solve the eigenvalue problem.

Consider the Dirichlet problem in a disk of radius $a > 0$:

$$\begin{aligned}\Delta u &= 0 \quad \text{in } U = B(0, a) \subset \mathbb{R}^2, \\ u &= f \quad \text{on } \partial U.\end{aligned}$$

In plane polar coordinates,

$$x = r \cos \theta, \quad y = r \sin \theta,$$

we have the following problem for $u = u(r, \theta)$:

$$\begin{aligned}u_{rr} + \frac{1}{r}u_r + \frac{1}{r^2}u_{\theta\theta} &= 0, \quad 0 \leq \theta \leq 2\pi, \quad 0 < r < a, \\ u(a, \theta) &= f(\theta), \quad 0 \leq \theta \leq 2\pi.\end{aligned}\tag{8.5}$$

The boundary ∂U is the circle $r = a$, whereas the boundaries for the variables r, θ also include $r = 0, \theta = 0, 2\pi$. At the disk center, $r = 0$, we exclude nonphysical solutions by insisting that solutions remain bounded as $r \rightarrow 0^+$. The boundaries $\theta = 0, 2\pi$ represent the same line in the disk, across which the solution should be as smooth as elsewhere in the domain. These boundaries are accommodated by making the solution 2π periodic in θ . Similarly, the boundary function f is treated as a 2π -periodic function of θ .

Let

$$u(r, \theta) = R(r)H(\theta).$$

Substituting into the PDE (8.5), we obtain

$$\frac{r^2(R''(r) + \frac{1}{r}R'(r))}{R(r)} + \frac{H''(\theta)}{H(\theta)} = 0,$$

whence, separating r from θ ,

$$\frac{H''(\theta)}{H(\theta)} = -\lambda; \quad \frac{r^2(R''(r) + \frac{1}{r}R'(r))}{R(r)} = \lambda.$$

We then have an eigenvalue problem for H , in which the boundary condition is that $H(\theta)$ is 2π periodic:

$$H''(\theta) + \lambda H(\theta) = 0, \quad H(0) = H(2\pi).\tag{8.6}$$

The corresponding equation for $R(r)$ is

$$r^2 R''(r) + r R'(r) = \lambda R(r).\tag{8.7}$$

We can solve the eigenvalue problem (8.6), with the result $H = H_0 = A_0/2 = \text{const.}$, for $\lambda = 0$, and

$$H = H_n(\theta) = A_n \cos n\theta + B_n \sin n\theta, \quad n = 1, 2, \dots, \quad \text{with } \lambda = \lambda_n = n^2.$$

Note that each eigenvalue $\lambda_n, n \geq 1$, has two independent eigenfunctions. Setting $\lambda = n^2$ in (8.7), we get

$$r^2 R''(r) + r R'(r) = n^2 R(r), \quad 0 < r < a. \quad (8.8)$$

For $n = 0$, the general solution of (8.8) is

$$R(r) = C_0 + D_0 \log r.$$

However, we seek solutions that are bounded as $r \rightarrow 0$ so we set $D_0 = 0$ and consider only the solution

$$R = R_0(r) = 1.$$

The arbitrary multiple C_0 will be incorporated into A_0 .

For $n \geq 1$, we seek solutions $R(r) = r^\alpha$. Substituting into (8.8), we find $\alpha = \pm n$. However, r^{-n} is unbounded at the origin, so we retain only

$$R_n = r^n, \quad n \geq 1.$$

Again, the arbitrary coefficient multiplying this solution will be incorporated into $H_n(\theta)$.

So far, we have solutions

$$u_0(r, \theta) = \frac{A_0}{2}, \quad u_n(r, \theta) = r^n (A_n \cos n\theta + B_n \sin n\theta), \quad n \geq 1.$$

These functions are harmonic in the ball $B(0, a)$, and they reduce to functions of θ alone for $r = a$.

We form a series $u = \sum_{n=1}^{\infty} u_n$:

$$u(r, \theta) = \frac{A_0}{2} + \sum_{n=1}^{\infty} r^n (A_n \cos n\theta + B_n \sin n\theta), \quad (8.9)$$

and set $r = a$ to satisfy the boundary condition $u(a, \theta) = f(\theta)$. Thus,

$$f(\theta) = \frac{A_0}{2} + \sum_{n=1}^{\infty} a^n (A_n \cos n\theta + B_n \sin n\theta).$$

Consequently, $a^n A_n$, $a^n B_n$ are Fourier coefficients of the 2π -periodic function f :

$$\begin{pmatrix} A_n \\ B_n \end{pmatrix} = \frac{1}{a^n \pi} \int_0^{2\pi} f(\theta) \begin{pmatrix} \cos n\theta \\ \sin n\theta \end{pmatrix} d\theta, \quad n \geq 0. \quad (8.10)$$

If we substitute the coefficients given by (8.10) back into the series (8.9), we get the solution u in terms of the data, and we can sum the series, just as we summed the series to get the Dirichlet kernel in proving pointwise convergence. Thus,

$$\begin{aligned}
u(r, \theta) &= \frac{1}{2\pi} \int_0^{2\pi} f(\phi) \left(1 + 2 \sum_{n=1}^{\infty} \left(\frac{r}{a}\right)^n (\cos n\theta \cos n\phi + \sin n\theta \sin n\phi) \right) d\phi \\
&= \frac{1}{2\pi} \int_0^{2\pi} f(\phi) \left(1 + 2 \sum_{n=1}^{\infty} \left(\frac{r}{a}\right)^n \cos n(\theta - \phi) \right) d\phi.
\end{aligned}$$

After some manipulation of the sum of the geometric series

$$\sum_{n=-\infty}^{\infty} \left(\frac{r}{a}\right)^n e^{in(\theta-\phi)},$$

we obtain *Poisson's formula* for the solution of the Dirichlet problem in a disk:

$$u(r, \theta) = \frac{1}{2\pi} \int_0^{2\pi} \frac{a^2 - r^2}{a^2 - 2ar \cos(\theta - \phi) + r^2} f(\phi) d\phi. \quad (8.11)$$

This integral has the form of a convolution product of the Poisson kernel

$$P(r, \psi) = \frac{1}{2\pi} \frac{a^2 - r^2}{a^2 - 2ar \cos \psi + r^2}$$

with the boundary data $f(\psi) = u(a, \psi)$. The formula reduces to the mean-value property of harmonic functions when $r = 0$. In the special case $f \equiv 1$, we have the solution $u = 1$, from which we conclude that

$$\int_0^{2\pi} P(r, \psi) d\psi = 1.$$

Note that you could also have guessed this by integrating the series term by term.

Just as for fundamental solutions, which are singular integral kernels, the Poisson kernel, $P(r, \theta - \phi)$ is singular at the very place the function $u(r, \theta)$ is to be evaluated on the boundary: $r = a$, $\theta = \phi$. The singularity is needed for the convolution to converge to the boundary data: for f continuous,

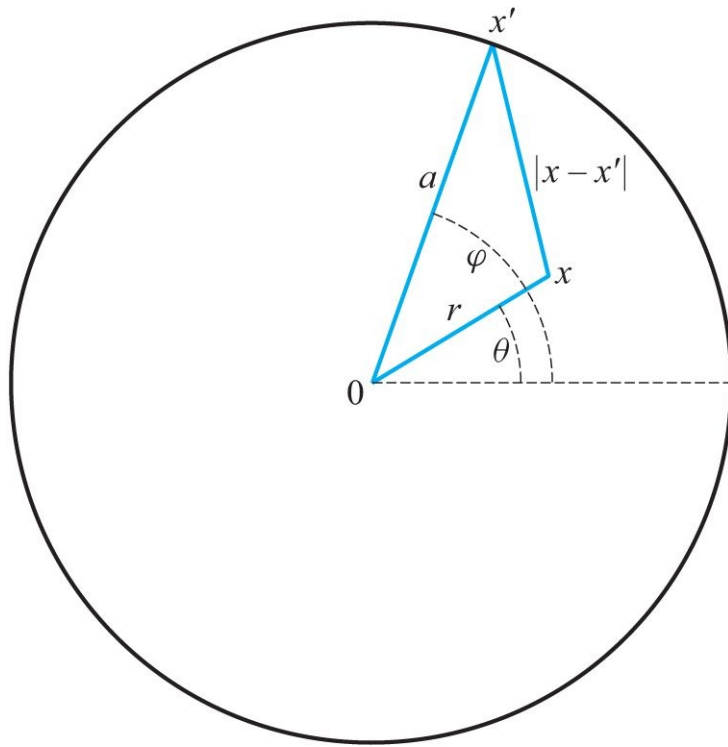

Figure 8.3. Geometric interpretation of Poisson's formula.

$$\lim_{(r, \theta) \rightarrow (a, \phi)} u(r, \theta) = f(\phi).$$

A more geometric interpretation of Poisson's formula generalizes to higher dimensions. Consider polar coordinates for

$$\mathbf{x} = (r \cos \theta, r \sin \theta) \in B(0, a), \quad \text{and} \quad \mathbf{x}' = (a \cos \phi, a \sin \phi) \in \partial B(0, a).$$

Then we have $a^2 - r^2 = |\mathbf{x}'|^2 - |\mathbf{x}|^2$, and $|\mathbf{x}' - \mathbf{x}|^2 = r^2 + a^2 - 2ar \cos(\theta - \phi)$ (see Fig. 8.3). Thus,

$$u(\mathbf{x}) = \int_{|\mathbf{x}'|=a} \frac{|\mathbf{x}'|^2 - |\mathbf{x}|^2}{|\mathbf{x}' - \mathbf{x}|^2} u(\mathbf{x}') ds(\mathbf{x}'), \quad |\mathbf{x}| < a.$$

The Poisson kernel is an example of a Green's function, which we study in detail in the next chapter.

PROBLEMS

1. Prove the weak maximum principle (Theorem 8.3, part 1) using an argument similar to the proof used for this principle for the heat equation (Theorem 5.2).
2. Prove the weak maximum principle (Theorem 8.3, part 2) from the strong form.
3. Consider Poisson's equation on a bounded open set $U \in \mathbb{R}^n$ with Robin boundary conditions

$$\Delta u(\mathbf{x}) = f(\mathbf{x}), \mathbf{x} \in U, \quad \frac{\partial u}{\partial \nu}(\mathbf{x}) + \alpha u(\mathbf{x}) = g(\mathbf{x}), \mathbf{x} \in \partial U.$$

(a) Prove that if $\alpha > 0$, then the energy method can be used to show uniqueness of solutions $u \in C^2(U) \cap C(\bar{U})$.

(b) For $\alpha = 0$, show that solutions are unique up to a constant.

(c) Design an example to show that uniqueness can fail if $\alpha < 0$. (Hint: Choose $n = 1$.)

4. Derive Poisson's formula (8.11) by summing the series for $u(r, \theta)$. Provide the details.

5. In \mathbb{R}^n let $V_r = |B(0, r)| = \alpha(n)r^n$, $S_r = |\partial B(0, r)|$. Explain why

$$V_r = \frac{r}{n} S_r.$$

6. Suppose $u \in C^2(U)$ has the mean-value property:

For all $x \in U$, $u(x) = \int_{\partial B(x, r)} u(y) dS_y$ for all $r > 0$ such that $B(x, r) \subset U$. Write a careful proof by contradiction that $\Delta u = 0$ in U .

7. Suppose $U \subset \mathbb{R}^n$ is open, bounded, and connected, and $u \in C^2(U) \cap C(\bar{U})$ satisfies

$$\Delta u = 0 \quad \text{in } U, \quad u|_{\partial U} = g.$$

Prove that if $g \in C(\partial U)$, $g(x) \geq 0$ for all x , and $g(x) > 0$ for some $x \in \partial U$, then

$$u(x) > 0 \quad \text{for all } x \in U.$$

1. Pierre-Simon Laplace, 1749–1827, made many contributions to mathematics, physics, and astronomy. Simeon Denis Poisson, 1781–1840, was a mathematician and physicist known for his contributions to the theory of electricity and magnetism.

Green's Functions and Distributions

Green's functions, integral kernels that allow linear boundary value problems to be expressed as integral equations, appear in many contexts.¹ The theory and construction of solutions for the basic linear PDE of mathematical physics use Green's functions or fundamental solutions. For example, in linear elasticity, a Green's function is the displacement of the elastic material (such as rubber) due to a point force, whereas in electrostatics, the Green's function relates an electric field to a point charge. Numerical analysts use Green's functions as a convenient way to convert PDE into integral equations that can be solved with numerical integration.

In this chapter we show how the Green's function is a solution of a PDE only in a generalized sense. This sense is elegantly expressed in terms of the theory of distributions, which we introduce in this chapter as a separate topic, before returning to the construction and properties of Green's functions for the Laplacian and other linear differential operators.

9.1. Boundary Value Problems

We would like to study boundary value problems, such as the following:

$$\begin{aligned} -\Delta u &= f && \text{in } U, \\ u &= g && \text{on } \partial U, \end{aligned} \tag{9.1}$$

where $U \subset \mathbb{R}^n$ is open and bounded with smooth boundary ∂U .

From [Section 8.2](#) we see how to solve Poisson's equation on all space by writing the solution as a convolution with the fundamental solution Φ (see [Theorem 8.1](#)):

$$u(\mathbf{x}) = \int_{\mathbb{R}^n} \Phi(\mathbf{x} - \mathbf{y}) f(\mathbf{y}) d\mathbf{y}. \tag{9.2}$$

The purpose of Green's functions is to find a similar formula that takes the boundary conditions into account. An immediate difficulty is that we have no reason to suppose that (9.2) will satisfy the boundary condition $u = g$ on ∂U . The idea is to first modify the fundamental solution so that a formula similar to (9.2) yields a solution of the inhomogeneous PDE that satisfies *homogeneous* boundary conditions (i.e., with $g \equiv 0$), a construction we explain in [Section 9.3](#). As a second step, we find a smooth solution of the homogeneous PDE (i.e., with $f \equiv 0$) that satisfies the *inhomogeneous* boundary condition $u = g$ on ∂U . Finally, we put

the two pieces together, relying on linearity, to give a solution of the boundary value problem (9.1).

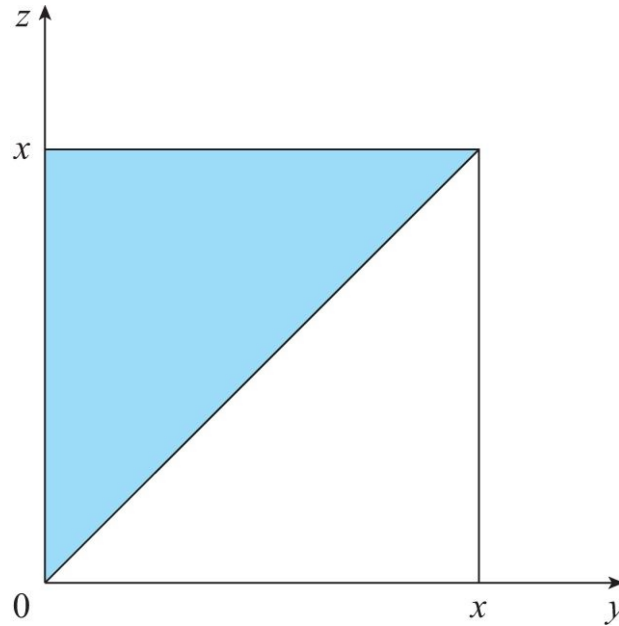

Figure 9.1. Area of integration. The diagonal line is $z = y$.

Let's start with problem (9.1) in one dimension with homogeneous Dirichlet boundary conditions:

$$\begin{aligned} -u''(x) &= f(x), & 0 < x < 1, \\ u(0) &= 0, & u(1) = 0. \end{aligned} \tag{9.3}$$

We solve this problem by integrating twice:

$$-u'(x) = \int_0^x f(y) dy + C, \quad -u(x) = \int_0^x \int_0^z f(y) dy dz + Cx + D,$$

where C, D are constants of integration.

The boundary condition $u(0) = 0$ leads immediately to $D = 0$. The boundary condition $u(1) = 0$ then gives an equation for C . It is convenient to simplify the double integral by reversing the order of integration in the shaded region of [Figure 9.1](#).

$$\int_0^x \int_0^z f(y) dy dz = \int_0^x \int_y^x f(y) dz dy = \int_0^x (x - y) f(y) dy.$$

Then

$$u(x) = - \int_0^x (x - y) f(y) dy - Cx. \tag{9.4}$$

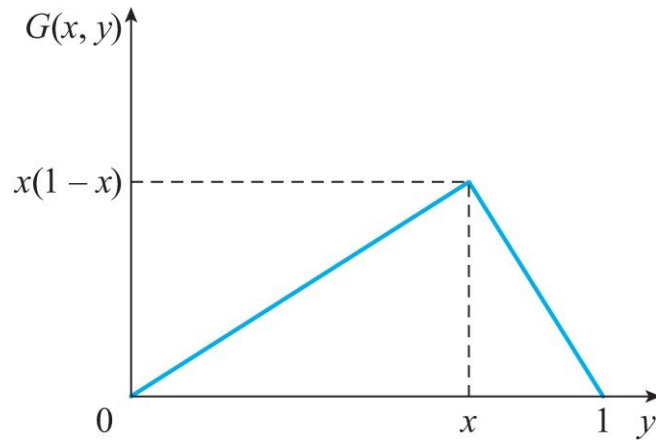

Figure 9.2. The integral kernel $G(x, y)$.

The boundary condition at $x = 1$ becomes

$$C = - \int_0^1 (1 - y) f(y) dy.$$

Substituting back into (9.4) and rearranging terms, we arrive at

$$\begin{aligned} u(x) &= \int_0^x (y - x) f(y) dy + \int_0^1 x(1 - y) f(y) dy \\ &= \int_0^x y(1 - x) f(y) dy + \int_x^1 x(1 - y) f(y) dy. \end{aligned}$$

We can write this formula in the compact form

$$u(x) = \int_0^1 G(x, y) f(y) dy, \quad 0 \leq x \leq 1, \quad (9.5)$$

using the integral kernel

$$G(x, y) = \begin{cases} y(1 - x), & \text{if } y \leq x, \\ x(1 - y), & \text{if } x \leq y. \end{cases} \quad (9.6)$$

The graph of $G(x, y)$ for fixed $x \in (0, 1)$ is shown in [Figure 9.2](#).

[Equation \(9.5\)](#) defines an integral operator \mathcal{G} :

$$(\mathcal{G}f)(x) = \int_0^1 G(x, y) f(y) dy, \quad 0 \leq x \leq 1.$$

The differential operator $\mathcal{L} = -\frac{d^2}{dx^2} : X \rightarrow C[0, 1]$ operates on functions u in the space X of C^2 functions that satisfy the homogeneous boundary conditions. The integral operator $\mathcal{G} : C[0, 1] \rightarrow X$ goes the other way; it acts on continuous functions and gives twice-differentiable functions that satisfy (9.3). In this sense, the integral operator is the inverse of the differential operator. In fact, G is the *Green's*

function for the boundary value problem, because (9.4) satisfies (9.3). Observe that (9.5) has some similarity to (9.2).

Here are some properties of $G : [0, 1] \times [0, 1] \rightarrow \mathbb{R}$:

1. G is nonnegative: $G(x, y) \geq 0$;
2. G is symmetric: $G(x, y) = G(y, x)$;
3. G is continuous; and
4. G is differentiable, except on the diagonal $x = y$. On the diagonal, $\frac{\partial G}{\partial y}$ has a jump discontinuity:

$$\left[\frac{\partial G}{\partial y} \right]_{x=y} = -1,$$

where the bracket notation $[F]$ means the jump in a function F , or difference between the right limit and left limit. While these properties are specific to the Green's function (9.6) for problem (9.3), they have their counterparts for different differential operators \mathcal{L} .

Now $\frac{\partial^2 G}{\partial y^2} = 0$ except on the diagonal, where $\frac{\partial G}{\partial y}$ may be thought to have infinite negative slope. We write

$$-\frac{\partial^2 G}{\partial y^2}(x, y) = \delta(x - y),$$

where $\delta(x)$ is the Dirac delta function. The function $\delta(x)$ is a measure that assigns mass one at $x = 0$ and zero mass elsewhere. We shall treat δ as a *distribution*, or *generalized function*, which leads us to the theory of distributions, a useful framework for considering PDE and Green's functions, such as $G(x, y)$.

It is also useful to relate the Green's function to the fundamental solution $\Phi(x, y) = -\frac{1}{2}|x - y|$. In fact, if we write

$$G(x, y) = -\frac{1}{2}|x - y| + \phi^y(x),$$

then $-\frac{d^2}{dx^2}\phi^y(x) = 0$ for each $y \in [0, 1]$. We write the superscript y in the function $\phi(x)$ to indicate that y is a parameter. Moreover, since G satisfies homogeneous boundary conditions, ϕ^y satisfies the boundary conditions (for each $y \in [0, 1]$):

$$\phi^y(x) = -\Phi(x - y), \quad x = 0 \text{ and } x = 1. \quad (9.7)$$

Thus, to modify the fundamental solution to obtain the Green's function, we construct for each y a solution $u = \phi^y$ of the homogeneous equation $u''(x) = 0$ that satisfies the boundary conditions (9.7).

9.2. Test Functions and Distributions

In the previous section we constructed a Green's function that is not twice differentiable in the classical sense but has a generalized second derivative that is a delta function, an example of a distribution. The space of distributions, defined in this section, is used to broaden the notion of solutions of PDE, especially linear PDE. We discuss distributions in a variety of contexts in the next couple of chapters, but this narrative begins with a space of smooth functions known as test functions. Test functions are instrumental in defining distributional solutions of PDE by using integration by parts to transfer derivatives from distributions onto the test functions.

9.2.1. Test Functions

To study test functions, we introduce some new notation and terminology. For simplicity, we start by considering smooth functions on \mathbb{R} . Let $\mathcal{D} = C_c^\infty(\mathbb{R})$ denote the space of C^∞ functions ϕ with compact support, $\text{supp } \phi$. Then \mathcal{D} is the space of *test functions*, with a specific notion of convergence defined as follows.

We denote the j th derivative of ϕ by $\phi^{(j)}$. A sequence $\{\phi_n\}$ converges to ϕ in \mathcal{D} as $n \rightarrow \infty$ if

1. there is a compact (closed and bounded) subset K of \mathbb{R} such that $\text{supp } \phi_n \subset K$ for all n , and $\text{supp } \phi \subset K$; and
2. $\phi_n^{(j)} \rightarrow \phi^{(j)}$ as $n \rightarrow \infty$, uniformly on K , for each $j \geq 0$:

$$\sup_{x \in K} |\phi_n^{(j)}(x) - \phi^{(j)}(x)| \rightarrow 0, \quad \text{as } n \rightarrow \infty.$$

Similarly, the space $\mathcal{D}(\mathbb{R}^n)$ of test functions on \mathbb{R}^n is defined by replacing ordinary derivatives by partial derivatives in the definition of convergence.

Example 1. (A test function) Let's consider an example of a test function in \mathbb{R}^n that we will refer to repeatedly.

Let

$$\eta(\mathbf{x}) = \begin{cases} C e^{-\frac{1}{1-|\mathbf{x}|^2}}, & \text{if } |\mathbf{x}| < 1, \\ 0, & \text{otherwise,} \end{cases}$$

where $C = 1 / \int_{|\mathbf{x}| < 1} e^{-\frac{1}{1-|\mathbf{x}|^2}} d\mathbf{x}$ is chosen so that

$$\int_{\mathbb{R}^n} \eta(\mathbf{x}) d\mathbf{x} = 1.$$

To see that η is a test function, we note that it has compact support $\{\mathbf{x} : |\mathbf{x}| \leq 1\}$, and it has continuous derivatives of all orders, even where the definition is split at $|\mathbf{x}| = 1$. For example, with $n = 1$, the derivatives approach zero at $x = 1$. To see this, observe that every derivative is the product of a rational function and the exponential $e^{-1/(1-x^2)}$; the exponential dominates the rational function as $x \rightarrow 1$, sending the derivatives to zero.

It is sometimes useful to rescale η using a parameter $\epsilon > 0$:

$$\eta^\epsilon(\mathbf{x}) = \frac{1}{\epsilon^n} \eta\left(\frac{\mathbf{x}}{\epsilon}\right). \quad (9.8)$$

Then the support is scaled by ϵ , while leaving the integral unchanged: $\text{supp } \eta^\epsilon = \{\mathbf{x} : |\mathbf{x}| \leq \epsilon\}$, and $\int_{\mathbb{R}^n} \eta^\epsilon(\mathbf{x}) d\mathbf{x} = 1$. The function η^ϵ is called a *mollifier*, because it can be used to smooth rough functions. The next lemma shows us how this works using the convolution product.

Lemma 9.1. *Let $f \in C(\mathbb{R}^n)$, and define, for $\epsilon > 0$, $f^\epsilon(x) = \eta^\epsilon f^\epsilon * f(x)$. Then $f^\epsilon \in C^\infty$, and $f^\epsilon(x) \rightarrow f(x)$ for all x , as $\epsilon \rightarrow 0$.*

Let $L_1^{\text{loc}}(\mathbb{R}^n)$ denote the space of *locally integrable functions* on \mathbb{R}^n :

$$g \in L_1^{\text{loc}}(\mathbb{R}^n) \quad \text{if} \quad \int_K |g(x)| dx < \infty \quad \text{for any compact } K \subset \mathbb{R}^n.$$

Then f^ϵ is defined and is C^∞ for $f \in L_1^{\text{loc}}$. In that case, it takes a little measure theory (the Lebesgue-dominated convergence theorem) to prove that $f^\epsilon \rightarrow f$ almost everywhere (see Evans [12], Appendix). Thus, the convolution of the mollifier η^ϵ with the only-once-differentiable function $f(x)$ provides an infinitely smooth function $f^\epsilon(x)$.

9.2.2. Distributions

Now that we have established properties of the space \mathcal{D} of test functions, we are ready to define distributions. Each distribution f is a function on \mathcal{D} , meaning that $f(\phi)$ is a number for each test function ϕ .

Specifically, the *space of distributions* \mathcal{D}' is defined to be the space of continuous linear functionals on the space \mathcal{D} of test functions. That is, $f \in \mathcal{D}'$ means $f : \mathcal{D} \rightarrow \mathbb{R}$, and f has the following properties:

1. f is *linear*: $f(a\phi_1 + b\phi_2) = af(\phi_1) + bf(\phi_2)$ for each $a, b \in \mathbb{R}$, $\phi_1, \phi_2 \in \mathcal{D}$; and
2. f is *continuous*: $\phi_n \rightarrow \phi$ in \mathcal{D} implies $f(\phi_n) \rightarrow f(\phi)$ (as a sequence of numbers).

The space of continuous linear functionals on a given topological space X is called the *dual space* of X and is typically denoted X' . Thus, \mathcal{D}' is the dual space of \mathcal{D} . Following the usual custom, we denote $f(\phi)$ by (f, ϕ) . The notation should not be confused with the L^2 inner product of integrable functions.

Not every functional is a distribution. For example, if we define $f : \mathcal{D} \rightarrow \mathbb{R}$ by $f(\phi) = \phi(0)^2$, then f is a continuous functional, but since it is nonlinear, it is not a distribution.

Example 2. (Four distributions) Here we provide four examples of distributions. For each j in \mathcal{D}' , $j = 1, \dots, 4$, test functions $\phi \in \mathcal{D}$ are assigned to numbers (j, ϕ) :

1. $(f_1, \phi) = \int_{\mathbb{R}} \phi(x) dx.$

2. $(f_2, \phi) = \int_0^{\infty} \phi(x) dx$

3. $(f_3, \phi) = (\delta, \phi) \equiv \phi(0).$

4. $(f_4, \phi) = \phi'(0).$

We leave to the problems verification that these examples are well defined, linear, and continuous.

Many distributions are associated with locally integrable functions. The first distribution f_1 is associated with \tilde{f}_1 , which is not integrable on \mathbb{R} , but it is in $L_1^{\text{loc}}(\mathbb{R})$. Then $(f_1, \phi) = \int_{\mathbb{R}} \tilde{f}_1(x)\phi(x) dx.$

The second distribution f_2 is associated with the Heaviside function:

$$\tilde{f}_2(x) = H(x) = \begin{cases} 0, & \text{if } x < 0, \\ 1, & \text{if } x \geq 0, \end{cases}$$

which is in $L_1^{\text{loc}}(\mathbb{R})$ and $(f_2, \phi) = \int_{\mathbb{R}} \tilde{f}_2(x)\phi(x) dx.$

More generally, we have the following lemma.

Lemma 9.2. *If $\tilde{g} \in L_1^{\text{loc}}(\mathbb{R}^n)$, then \tilde{g} defines a distribution $g \in \mathcal{D}'$ by*

$$(g, \phi) = \int_{\mathbb{R}^n} \tilde{g}(x)\phi(x) dx.$$

Proof. Linearity of g follows from the formula in the lemma; continuity follows from the formula and an estimate:

$$|(g, \phi) - (g, \phi_n)| = \left| \int_K \tilde{g}(\phi - \phi_n) d\mathbf{x} \right| \leq \int_K |\tilde{g}(\mathbf{x})| d\mathbf{x} \sup_K |\phi - \phi_n| \rightarrow 0$$

as $n \rightarrow \infty$, where $\text{supp } \phi, \text{supp } \phi_n \subset K$. ■

We say a distribution f is *regular* if it has an L_1^{loc} representative \tilde{f} :

$$(f, \phi) = \int_{\mathbb{R}^n} \tilde{f}(x)\phi(x) dx \quad \text{for all } \phi \in \mathcal{D}(\mathbb{R}^n).$$

Thus, regular distributions can be thought of as functions. For example, f_2 is a regular distribution; it can be identified with the Heaviside function.

However, not every distribution defines an L_1^{loc} function. A distribution f is called *singular* if it is not regular. There are many singular distributions; even the delta function $f_3 = \delta$ is singular, as we now show. It will then follow that f_4 in [Example 2](#) is also singular.

Lemma 9.3. *The delta function is a singular distribution.*

Proof. Suppose δ is regular, so that there is $g \in L_1^{\text{loc}}$ such that

$$(\delta, \phi) = \int_{\mathbb{R}^n} g(x)\phi(x) dx \quad \text{for all } \phi \in \mathcal{D}(\mathbb{R}^n). \quad (9.9)$$

Now define a one-parameter family of test functions with parameter ϵ , specifically, $\phi^\epsilon(x) = \eta(x/\epsilon)$:

$$\phi^\epsilon(x) = \begin{cases} \exp \left\{ -\frac{1}{1 - (|x|/\epsilon)^2} \right\}, & \text{if } |x| < \epsilon, \\ 0, & \text{if } |x| \geq \epsilon. \end{cases}$$

We calculate the effect of δ on ϕ^ϵ in two ways. First, from the definition of δ :

$$(\delta, \phi^\epsilon) = \phi^\epsilon(0) = e^{-1}.$$

Second, using the assumption (9.9):

$$(\delta, \phi^\epsilon) = \int_{\mathbb{R}^n} g(x)\phi^\epsilon(x) dx.$$

However, then

$$e^{-1} = \left| \int_{\mathbb{R}^n} g(x)\phi^\epsilon(x) dx \right| \leq \int_{|x| \leq \epsilon} |g(x)|e^{-1} dx.$$

Since the latter integral approaches zero as $\epsilon \rightarrow 0$, we can choose $\epsilon > 0$ small enough that the integral on the right is less than e^{-1} , contradicting the inequality. ■

We next discuss several general properties of distributions that are useful in the analysis of PDE, both specific ones (such as Laplace's equation) and in the

general theory of PDE, including both linear and nonlinear equations.

Convergence of Distributions

We observed in [Chapter 5](#) that the heat kernel $\Phi(\mathbf{x}, t)$ converges to $\delta(\mathbf{x})$ as $t \rightarrow 0^+$. Here we make this convergence precise by defining what it means for a sequence of distributions to converge to a limiting distribution.

Let $\{f_k\}_{k=1}^\infty \subset \mathcal{D}'(\mathbb{R}^n)$ be a sequence of distributions, and let $f \in \mathcal{D}'(\mathbb{R}^n)$. We say $f_k \rightarrow f$ in \mathcal{D}' in the sense of distributions if $(f_k, \phi) \rightarrow (f, \phi)$ as $k \rightarrow \infty$, for all $\phi \in \mathcal{D}(\mathbb{R}^n)$.

Example 3. (Sequence of distributions) Let $n = 1$, and define, for $k = 1, 2, \dots$:

$$f_k(x) = \begin{cases} k, & \text{if } |x| \leq \frac{1}{2k}, \\ 0, & \text{otherwise.} \end{cases}$$

Then, for $\phi \in \mathcal{D}(\mathbb{R})$,

$$\begin{aligned} (f_k, \phi) &= \int_{\mathbb{R}} f_k(x) \phi(x) dx = \int_{-\frac{1}{2k}}^{\frac{1}{2k}} k \phi(x) dx = \int_{-\frac{1}{2k}}^{\frac{1}{2k}} \phi(x) dx \\ &\rightarrow \phi(0) = (\delta, \phi) \quad \text{as } k \rightarrow \infty. \end{aligned}$$

Thus, $f_k \rightarrow \delta$ in the sense of distributions as $k \rightarrow \infty$.

Example 4. (Convergence of heat kernel $\Phi(\mathbf{x}, t)$ as $t \rightarrow 0$) Let $\Phi(x, t) = \frac{1}{\sqrt{4\pi t}} e^{-x^2/4t}$, $x \in \mathbb{R}$, $t > 0$. Then $\Phi(x, t) \rightarrow \delta(x)$ as $t \rightarrow 0^+$ means $(\Phi(\mathbf{x}, t), \phi(x)) \rightarrow \phi(0)$ as $t \rightarrow 0^+$.

Distributional Derivatives

Let $f \in C^1(\mathbb{R}^n)$. Then f is differentiable, and each partial derivative is locally integrable and therefore defines a distribution. We have

$$\begin{aligned} \left(\frac{\partial f}{\partial x_i}, \phi \right) &= \int_{\mathbb{R}^n} \frac{\partial f}{\partial x_i}(x) \phi(x) dx = - \int_{\mathbb{R}^n} f(x) \frac{\partial \phi}{\partial x_i}(x) dx \\ &= - \left(f, \frac{\partial \phi}{\partial x_i} \right). \end{aligned}$$

This calculation suggests that for any distribution f we define its *distributional derivative* $\partial f / \partial x_i$ to be a distribution given by

$$\left(\frac{\partial f}{\partial x_i}, \phi \right) = - \left(f, \frac{\partial \phi}{\partial x_i} \right), \quad \text{for all } \phi \in \mathcal{D}.$$

Then every distribution is differentiable *in the sense of distributions*, and hence has derivatives of all orders. It is not hard to show that $\partial f/\partial x_i$ is indeed a distribution by checking directly that it is continuous and linear.

Example 5. (Distributional derivative with $n = 1$) Consider the Heaviside function $H(x)$. As we saw earlier, H is in L_1^{loc} , and it acts on test functions by

$$(H, \phi) = \int_0^\infty \phi(x) dx. \quad \text{Thus, for any test function } \phi,$$

$$(H'(x), \phi) = -(H, \phi') = - \int_0^\infty \phi'(x) dx = \phi(0) = (\delta, \phi).$$

Therefore,

$$H' = \delta.$$

We can also differentiate the δ function directly from the definition of distributional derivative:

$$(\delta', \phi) = -(\delta, \phi') = -\phi'(0).$$

In fact, this is related to example f_4 in [Example 2](#).

As another example, let $f(x) = |x|$. Then because

$$f'(x) = \begin{cases} -1, & \text{if } x < 0, \\ 1, & \text{if } x > 0 \end{cases}$$

is an L_1^{loc} function, it defines a distribution. In fact, $f' = 2H - 1$; consequently, $f'' = 2\delta$. Here we have used the fact that differentiation is a linear operation on distributions, just as it is on differentiable functions.

Translation by $\mathbf{y} \in \mathbb{R}^n$ The delta function $\delta(\mathbf{x})$ is a distribution that places unit mass at $\mathbf{x} = 0$. To place the mass at a point \mathbf{y} , we define a new distribution with the notation $\delta(\mathbf{x} - \mathbf{y})$. In general, we can translate any distribution f by a constant \mathbf{y} as follows. We define the translation of $f \in \mathcal{D}'$, by $\mathbf{y} \in \mathbb{R}^n$, as a new distribution $g \in \mathcal{D}'$, for which

$$(g, \phi) = (f, \phi^{(-\mathbf{y})}),$$

where $\phi^{(-\mathbf{y})} \in \mathcal{D}$ is the test function defined by $\phi^{(-\mathbf{y})}(\mathbf{x}) = \phi(\mathbf{x} - \mathbf{y})$. To see that this makes sense, we simply check that it is consistent for any $f \in L_1^{\text{loc}}$:

$$(g, \phi) = (f, \phi^{(-\mathbf{y})}) = \int_{\mathbb{R}^n} f(\mathbf{z}) \phi(\mathbf{z} - \mathbf{y}) d\mathbf{z} = \int_{\mathbb{R}^n} f(\mathbf{x} + \mathbf{y}) \phi(\mathbf{x}) d\mathbf{x}.$$

Then we can associate the distribution g with the translation $f(\mathbf{x} + \mathbf{y})$ of the L_1^{loc} function $f(\mathbf{x})$ by \mathbf{y} .

An example where this translation is useful is the δ function. We often write $\delta(\mathbf{x} - \mathbf{y})$ to mean the distribution δ , translated by $-\mathbf{y}$, and it is common to leave \mathbf{x} in the arguments of both the distribution and the test function:

$$(\delta(\mathbf{x} - \mathbf{y}), \phi(\mathbf{x})) = \phi(\mathbf{y}).$$

To multiply a distribution $f \in \mathcal{D}'$ by a function $c \in C^\infty$, we define $cf \in \mathcal{D}'$ by

$$(cf, \phi) = (f, c\phi),$$

noting that $c\phi$ is a test function. Again, this definition is motivated by the case of a regular distribution f , in which case the formula makes sense interpreted as integrals.

The next two examples illustrate the connection between properties of distributions and differential equations.

Example 6. (Multiplication by a C^∞ function) Consider $c(x) = x$, $f = \delta$ in \mathbb{R} . Then

$$(x\delta(x), \phi(x)) = (\delta(x), x\phi(x)) = 0,$$

so that $x\delta = 0$. Since $\delta = H'$, we can interpret $x\delta = 0$ as saying that $y(x) = H(x)$ is a distribution solution of the differential equation

$$x \frac{dy}{dx} = 0.$$

In fact, the *general* distribution solution of this equation (which is singular at $x = 0$) is

$$y(x) = aH(x) + b,$$

for arbitrary constants a , b . Thus, we have a two-parameter family of distributional solutions for the first-order equation. This highlights a danger in enlarging the space of functions in which to define solutions, namely, that uniqueness of solutions may be lost in the larger space. Uniqueness can be restored by adding suitable boundary or initial conditions.

Example 7. (Application to shock wave solutions of conservation laws) Shock waves, introduced in [Chapter 2](#), are in fact distributional solutions of PDE, which we illustrate in this example for the scalar conservation law

$$u_t + f(u)_x = 0, \tag{9.10}$$

in which $f: \mathbb{R} \rightarrow \mathbb{R}$ is a given C^1 function. When we interpret (9.10) in the sense

of distributions, it allows us to give meaning to shock wave solutions, which are discontinuous. The equation simply states that if $u \in \mathcal{D}'(\mathbb{R}^2)$ and $f(u)$ can be interpreted as a distribution, then the combination of distributional derivatives on the left-hand side of the equation should be zero on every test function. Thus, for a test function $\phi(x, t)$:

$$(u, \phi_t) + (f(u), \phi_x) = 0.$$

In this way, we can define distribution solutions of differential equations, even nonlinear equations. To see that this interpretation has some substance, consider a jump discontinuity

$$u(x, t) = \begin{cases} u_-, & \text{if } x < st, \\ u_+, & \text{if } x > st, \end{cases}$$

where u_{\pm} and s are constants. Then

$$f(u)(x, t) = \begin{cases} f(u_-), & \text{if } x < st, \\ f(u_+), & \text{if } x > st. \end{cases}$$

We rewrite these functions using the Heaviside function:

$$\begin{aligned} u(x, t) &= (u_+ - u_-)H(x - st) + u_-, \\ f(u)(x, t) &= (f(u_+) - f(u_-))H(x - st) + f(u_-). \end{aligned}$$

Thus,

$$\frac{\partial u}{\partial t} = (u_+ - u_-)H'(x - st)(-s); \quad \frac{\partial}{\partial x} f(u) = (f(u_+) - f(u_-))H'(x - st),$$

and $H' = \delta$. Equation (9.10) becomes

$$(-s(u_+ - u_-) + f(u_+) - f(u_-)) \delta(x - st) = 0,$$

in the sense of distributions. But then the constant $-s(u_+ - u_-) + f(u_+) - f(u_-)$ must be zero:

$$-s(u_+ - u_-) + f(u_+) - f(u_-) = 0.$$

This equation is the *Rankine-Hugoniot condition* for shock wave solutions of (9.10). It is useful because it relates the shock speed s to the one-sided limits u_{\pm} of the solution on either side of the discontinuity. We will derive it for more general discontinuities in Chapter 13 on scalar conservation laws.

Distributions on Open Subsets of \mathbb{R}^n

It is straightforward to formulate the above ideas for distributions on subsets of \mathbb{R}^n . The key step is to define test functions appropriately and to use integration by

parts. Let $U \subset \mathbb{R}^n$ be open. Then we can define the space $\mathcal{D}(U) = C_c^\infty(U)$ of test functions on U (i.e., the C^∞ functions on U that have compact support in U). Then $\mathcal{D}'(U)$ is the space of continuous linear functionals on $\mathcal{D}(U)$. Now let $u : U \rightarrow \mathbb{R}$ be in $L_1^{\text{loc}}(U)$. Then u defines a distribution in $\mathcal{D}'(U)$. In particular, u is differentiable in the sense of distributions:

$$\left(\frac{\partial u}{\partial x_i}, \phi \right) = - \int_U u \frac{\partial \phi}{\partial x_i} dx.$$

We say u has a *weak derivative* $\frac{\partial u}{\partial x_i}$ if the distributional derivative is a regular distribution. Recall that this means it is represented by a locally integrable function: $\frac{\partial u}{\partial x_i} \in L_1^{\text{loc}}(U)$. In this way, we distinguish between the weak derivative and a distributional derivative.

9.3. Green's Functions

In this section we return to Green's functions, first giving a general framework within the theory of distributions and then showing how this applies to the Laplacian. The primary use of distributions here is related to the delta function and the notion of fundamental solution for a differential operator. Green's functions provide a means to invert the differential operator for boundary value problems.

9.3.1. General Framework

Consider a linear partial differential operator \mathcal{L} ($\mathcal{L} = -\Delta$ for example), that acts on functions $u : \mathbb{R}^n \rightarrow \mathbb{R}$. As we introduced for one dimension in [Section 9.1](#), Green's functions enable us to provide an integral representation for solutions of boundary value problems

$$\begin{aligned} \mathcal{L}u &= f \quad \text{in } U, \\ Bu &= g \quad \text{on } \partial U. \end{aligned} \tag{9.11}$$

Here f is a given function on U , and g is a given function on ∂U , but note that $U \subset \mathbb{R}^n$ may be unbounded. The term Bu represents a linear combination of u and derivatives of u of lower order than the order of the partial differential operator \mathcal{L} . Associated with \mathcal{L} we have the fundamental solution $\Phi(\mathbf{x}, \mathbf{y})$, which is required to satisfy

$$\mathcal{L}\Phi(\mathbf{x}, \mathbf{y}) = \delta(\mathbf{x} - \mathbf{y}), \quad \mathbf{x}, \mathbf{y} \in \mathbb{R}^n,$$

in the sense of distributions. To see why this is helpful, consider Φ to be locally integrable in \mathbf{y} for each $\mathbf{x} \in \mathbb{R}^n$, and let $f \in \mathcal{D}(\mathbb{R}^n)$. Then (using the L^2 inner

product notation, since Φ and f are integrable)

$$v(\mathbf{x}) = \int_{\mathbb{R}^n} \Phi(\mathbf{x}, \mathbf{y}) f(\mathbf{y}) d\mathbf{y} = (\Phi(\mathbf{x}, \mathbf{y}), f(\mathbf{y})) \quad (9.12)$$

satisfies $\mathcal{L}v = f$ in \mathbb{R}^n because

$$\mathcal{L}v(\mathbf{x}) = \mathcal{L}(\Phi(\mathbf{x}, \mathbf{y}), f(\mathbf{y})) = (\mathcal{L}\Phi(\mathbf{x}, \mathbf{y}), f(\mathbf{y})) = (\delta(\mathbf{x} - \mathbf{y}), f(\mathbf{y})) = f(\mathbf{x}).$$

That is, the fundamental solution is the key to solving the inhomogeneous PDE.

However, (9.12) does not generally satisfy the boundary condition $Bv = g$. To satisfy the boundary condition, we add a solution w of the homogeneous equation $\mathcal{L}w = 0$ so that $u(\mathbf{x}) = v(\mathbf{x}) + w(\mathbf{x})$ satisfies the boundary condition $Bu = g$. But then w must satisfy the boundary condition $Bw = g - Bv$. Thus, provided we have the fundamental solution $\Phi(\mathbf{x}, \mathbf{y})$, the boundary value problem (9.11) is reduced to solving the problem

$$\mathcal{L}w = 0 \quad \text{in } U, \quad Bw = g - Bv \quad \text{on } \partial U.$$

The boundary condition for w is a bit clumsy; it relies on applying the boundary operator to the integral (9.12) and restricting it to the boundary. The way to express this more smoothly is to introduce the Green's function for the differential operator \mathcal{L} with boundary operator B . For clarity, we consider \mathcal{L} and B to have independent variable $\mathbf{x} \in \bar{U}$, and we let $\mathbf{y} \in \bar{U}$ be a second independent variable, which is treated as a parameter for now.

The Green's function $G = G(\mathbf{x}, \mathbf{y})$ is defined as the solution of the problem

$$\begin{aligned} \mathcal{L}G(\mathbf{x}, \mathbf{y}) &= \delta(\mathbf{x} - \mathbf{y}), & \mathbf{x} \in U, \\ BG(\mathbf{x}, \mathbf{y}) &= 0, & \mathbf{x} \in \partial U, \end{aligned} \quad (9.13)$$

for each $\mathbf{y} \in \bar{U}$.

We construct G using the fundamental solution, by defining a function $\phi^{\mathbf{y}}(\mathbf{x})$:

$$G(\mathbf{x}, \mathbf{y}) = \Phi(\mathbf{x}, \mathbf{y}) - \phi^{\mathbf{y}}(\mathbf{x}).$$

Then $\phi^{\mathbf{y}}(\mathbf{x})$ satisfies

$$\begin{aligned} \mathcal{L}\phi^{\mathbf{y}}(\mathbf{x}) &= 0, & \mathbf{x} \text{ in } U, \\ B\phi^{\mathbf{y}}(\mathbf{x}) &= B\Phi(\mathbf{x}, \mathbf{y}), & \mathbf{x} \text{ in } \partial U. \end{aligned} \quad (9.14)$$

Now we can express the solution of (9.11) as a sum $u = v + w$, where $v(\mathbf{x}) = \int_U G(\mathbf{x}, \mathbf{y}) f(\mathbf{y}) d\mathbf{y}$, and $w(\mathbf{x})$ satisfies

$$\mathcal{L}w = 0 \quad \text{in } U, \quad Bw = g \quad \text{on } \partial U. \quad (9.15)$$

This formulation is useful even when we do not have the Green's function

explicitly, since estimates on the Green's function can be used to obtain estimates on the solution u . In special cases, we can complete the solution as an explicit formula by finding the Green's function and solving (9.15) for $w(x)$. We next demonstrate this for Poisson's equation, where $\mathcal{L} = -\Delta$.

9.3.2. Green's Functions for the Laplacian

We apply the ideas just developed to the Dirichlet boundary value problem for Poisson's equation:

$$\begin{aligned} -\Delta u &= f & \text{in } U, \\ u &= g & \text{in } \partial U. \end{aligned} \tag{9.16}$$

Here U is open and bounded, with piecewise smooth boundary ∂U ; and f, g are continuous on $U, \partial U$, respectively. In terms of the previous section, $\mathcal{L} = -\Delta$, and the boundary operator B is the identity: $Bu = u$.

The fundamental solution for $-\Delta$ is a function $\Phi(\mathbf{x} - \mathbf{y})$ of $\mathbf{x} - \mathbf{y}$, since the Laplacian Δ is translation invariant. (More generally, the fundamental solution for any constant-coefficient PDE operator \mathcal{L} will be a function of $\mathbf{x} - \mathbf{y}$.) The Green's function $G(\mathbf{x}, \mathbf{y}) = \Phi(\mathbf{x} - \mathbf{y}) - \phi^{\mathbf{y}}(\mathbf{x})$ is then expressed in terms of the solution of the boundary value problem

$$\begin{aligned} \Delta \phi^{\mathbf{y}}(\mathbf{x}) &= 0, & \mathbf{x} \in U, \\ \phi^{\mathbf{y}}(\mathbf{x}) &= \Phi(\mathbf{x} - \mathbf{y}), & \mathbf{x} \in \partial U. \end{aligned}$$

In particular, $\phi^{\mathbf{y}}$ is a harmonic function in U . In the proof of the following theorem, we use the symmetry property $\phi^{\mathbf{y}}(\mathbf{x}) = \phi^{\mathbf{x}}(\mathbf{y})$, which follows since $\Phi(\mathbf{z})$ is an even function of \mathbf{z} . With this construction, we can write a formula for the solution of the boundary value problem (9.16).

Theorem 9.4. *If $u \in C^2(\bar{U})$ solves (9.16), then*

$$u(\mathbf{x}) = \int_U G(\mathbf{x}, \mathbf{y}) f(\mathbf{y}) d\mathbf{y} - \int_{\partial U} \frac{\partial G}{\partial \nu_{\mathbf{y}}}(\mathbf{x}, \mathbf{y}) g(\mathbf{y}) dS_{\mathbf{y}}. \tag{9.17}$$

Proof. As explained above, the first integral in (9.17) solves the inhomogeneous PDE, with homogeneous boundary condition, so it remains to prove that the second integral is harmonic and satisfies the given boundary condition. The second integral is harmonic in \mathbf{x} , since $G(\mathbf{x}, \mathbf{y})$ is harmonic in $\mathbf{x} \in U$ for each $\mathbf{y} \in \partial U$, and the second term involves differentiating and integrating only with respect to the parameter $\mathbf{y} \in \partial U$. To verify the boundary condition, we effectively show that the normal derivative acts like a delta function as \mathbf{x} approaches the boundary. To do this, the proof uses the Divergence Theorem to recover the

boundary data.

Recall that $G(\mathbf{x}, \mathbf{y})$ has the same singularity at $\mathbf{y} = \mathbf{x}$ as does the fundamental solution. In the verification of the solution of Poisson's equation on all of space (Section 8.2), using the fundamental solution, we excluded a small ball around $\mathbf{x} \in U$ and integrated on the domain

$$V_\epsilon = U - \overline{B}(\mathbf{x}, \epsilon).$$

We do the same thing here to accommodate the singularity in $G(\mathbf{x}, \mathbf{y})$. To start, we work with Φ and a function $u \in C^2(\overline{U})$ (not necessarily a solution). Then, using Green's identity, we have

$$\begin{aligned} & \int_{V_\epsilon} (u(\mathbf{y})\Delta\Phi(\mathbf{x} - \mathbf{y}) - \Phi(\mathbf{x} - \mathbf{y})\Delta u(\mathbf{y})) \, d\mathbf{y} \\ &= \int_{\partial V_\epsilon} \left(u(\mathbf{y})\frac{\partial\Phi(\mathbf{x} - \mathbf{y})}{\partial\nu_{\mathbf{y}}} - \Phi(\mathbf{x} - \mathbf{y})\frac{\partial u(\mathbf{y})}{\partial\nu_{\mathbf{y}}} \right) \, dS_{\mathbf{y}}. \end{aligned}$$

Since $\Phi(\mathbf{x} - \mathbf{y})$ is harmonic away from $\mathbf{y} = \mathbf{x}$, the first term on the left-hand side is zero. On the right-hand side there are two terms, but there are also two parts of the boundary, namely, ∂U and $\partial B(\mathbf{x}, \epsilon)$. We now show that the contributions from $\partial B(\mathbf{x}, \epsilon)$ approach zero as $\epsilon \rightarrow 0$. Let

$$I_\epsilon = \int_{\partial B(\mathbf{x}, \epsilon)} u(\mathbf{y})\frac{\partial\Phi}{\partial\nu_{\mathbf{y}}}(\mathbf{x} - \mathbf{y}) \, dS_{\mathbf{y}}.$$

As with the solution of Poisson's equation, $I_\epsilon \rightarrow u(\mathbf{x})$ as $\epsilon \rightarrow 0$ (see Section 8.2).

Similarly, let

$$J_\epsilon = \int_{\partial B(\mathbf{x}, \epsilon)} \Phi(\mathbf{x} - \mathbf{y})\frac{\partial u(\mathbf{y})}{\partial\nu_{\mathbf{y}}} \, dS_{\mathbf{y}}.$$

We assume in the theorem that u is continuously differentiable. Since $\Phi(\mathbf{x} - \mathbf{y})$ is constant on $\partial B(\mathbf{x}, \epsilon)$, proportional to $\ln \epsilon$ for $n = 2$, and to $\epsilon^{-(n-2)}$ for $n > 2$, we conclude that $|J_\epsilon| \rightarrow 0$ as $\epsilon \rightarrow 0$.

Letting $\epsilon \rightarrow 0$, we now obtain

$$\begin{aligned} & - \int_U \Phi(\mathbf{x} - \mathbf{y})\Delta u(\mathbf{y}) \, d\mathbf{y} \\ &= u(\mathbf{x}) + \int_{\partial U} \left(u(\mathbf{y})\frac{\partial\Phi}{\partial\nu_{\mathbf{y}}}(\mathbf{x} - \mathbf{y}) - \Phi(\mathbf{x} - \mathbf{y})\frac{\partial u(\mathbf{y})}{\partial\nu_{\mathbf{y}}} \right) \, dS_{\mathbf{y}}. \end{aligned}$$

The next step is to use a similar argument, in which we replace $\Phi(\mathbf{x} - \mathbf{y})$ by

the harmonic function $\phi^{\mathbf{x}}(\mathbf{y})$ in the calculation. Since $\phi^{\mathbf{x}}$ has no singularity at $\mathbf{x} = \mathbf{y}$, and $\phi^{\mathbf{x}}(\mathbf{y}) = \Phi(\mathbf{x} - \mathbf{y})$ for $\mathbf{y} \in \partial U$, we have

$$-\int_U \phi^{\mathbf{x}}(\mathbf{y}) \Delta u(\mathbf{y}) d\mathbf{y} = \int_{\partial U} \left(u(\mathbf{y}) \frac{\partial \phi^{\mathbf{x}}(\mathbf{y})}{\partial \nu_{\mathbf{y}}} - \Phi(\mathbf{x} - \mathbf{y}) \frac{\partial u(\mathbf{y})}{\partial \nu_{\mathbf{y}}} \right) dS_{\mathbf{y}}.$$

Rearranging, and using $G(\mathbf{x}, \mathbf{y}) = \Phi(\mathbf{x} - \mathbf{y}) - \phi^{\mathbf{x}}(\mathbf{y})$, we obtain

$$-\int_U G(\mathbf{x}, \mathbf{y}) \Delta u(\mathbf{y}) d\mathbf{y} = u(\mathbf{x}) + \int_{\partial U} u(\mathbf{y}) \frac{\partial G}{\partial \nu_{\mathbf{y}}}(\mathbf{x}, \mathbf{y}) dS_{\mathbf{y}}.$$

Finally, when u is a solution of (9.16) we obtain (9.17), and the proof is complete. ■

9.3.3. The Method of Images

Theorem 9.4 gives a formula for the solution of (9.11) that relies on Green's functions. Here we show how the Green's function for the Laplacian can be calculated from the fundamental solution in special cases when the domain U has symmetry. The general idea is to construct image points $\tilde{\mathbf{x}}$ outside U for each $\mathbf{x} \in U$ such that the function $\Phi(C(\tilde{\mathbf{x}} - \mathbf{y}))$ exactly cancels $\Phi(\mathbf{x} - \mathbf{y})$ on the boundary ∂U , for some scale factor C , possibly depending on \mathbf{x} . Then the new function is harmonic with respect to $\mathbf{y} \in U$ (since the Laplacian is invariant under scaling and translation by a constant), so we can set $\phi^{\mathbf{x}}(\mathbf{y}) = \Phi(C(\tilde{\mathbf{x}} - \mathbf{y}))$.

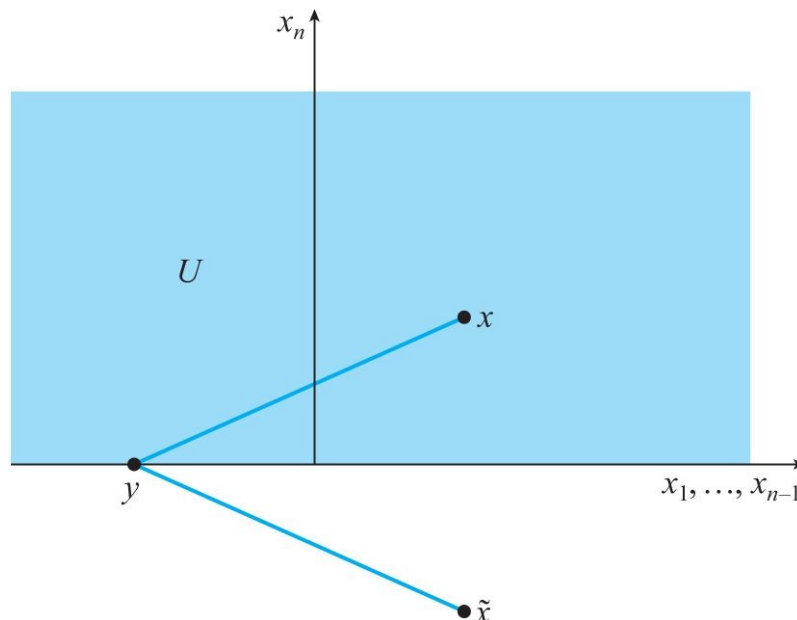

Figure 9.3. Method of images to derive Green's function for a half-plane.

We demonstrate this construction, which is known as the method of images, in two examples. In the first example U is a half-space, and in the second example U is a ball.

Example 8. (Method of images (half-space)) Let $U = \{\mathbf{x} \in \mathbb{R}^n : x_n > 0\}$. For $\mathbf{x} = (x_1, \dots, x_n) \in U$, define the image $\tilde{\mathbf{x}} = (x_1, \dots, x_{n-1}, -x_n)$ (see Fig. 9.3), and let

$$G(\mathbf{x}, \mathbf{y}) = \Phi(\mathbf{x} - \mathbf{y}) - \Phi(\tilde{\mathbf{x}} - \mathbf{y}), \quad x_n \geq 0, \quad y_n \geq 0.$$

Since $\tilde{\mathbf{x}} \notin U$, it follows that $\Phi(\tilde{\mathbf{x}} - \mathbf{y})$ is harmonic with respect to $\mathbf{y} \in U$ (for $\mathbf{x} \in U$). Then $G(\mathbf{x}, \mathbf{y})$ will be established as the Green's function if we can show $G(\mathbf{x}, \mathbf{y}) = 0$ for $y_n = 0, x_n > 0$. For $y_n = 0$, we have

$$|\mathbf{y} - \mathbf{x}| = \sqrt{\sum_{j=1}^{n-1} (y_j - x_j)^2 + x_n^2} = |\mathbf{y} - \tilde{\mathbf{x}}|.$$

Therefore, $\Phi(\mathbf{x} - \mathbf{y}) = \Phi(\tilde{\mathbf{x}} - \mathbf{y})$, as needed.

Example 9. (Method of images (unit ball)) Consider $U = B(0, 1)$, the unit ball in \mathbb{R}^n . Here, the image $\tilde{\mathbf{x}}$ includes a scaling, in addition to reflection through the boundary. (See Fig. 9.4.) We define $\tilde{\mathbf{x}} = \mathbf{x}/|\mathbf{x}|^2$, and let

$$G(\mathbf{x}, \mathbf{y}) = \Phi(\mathbf{x} - \mathbf{y}) - \Phi(|\mathbf{x}|(\tilde{\mathbf{x}} - \mathbf{y})). \quad (9.18)$$

(Note that $|\tilde{\mathbf{x}}| = 1/|\mathbf{x}|$.) To prove that $G(\mathbf{x}, \mathbf{y}) = 0$ for $\mathbf{x} \in U, \mathbf{y} \in \partial U$, we need to show that if $0 < |\mathbf{x}| < 1$, $\tilde{\mathbf{x}} = \mathbf{x}/|\mathbf{x}|^2$, and $|\mathbf{y}| = 1$, then

$$|\mathbf{x}||\tilde{\mathbf{x}} - \mathbf{y}| = |\mathbf{x} - \mathbf{y}|.$$

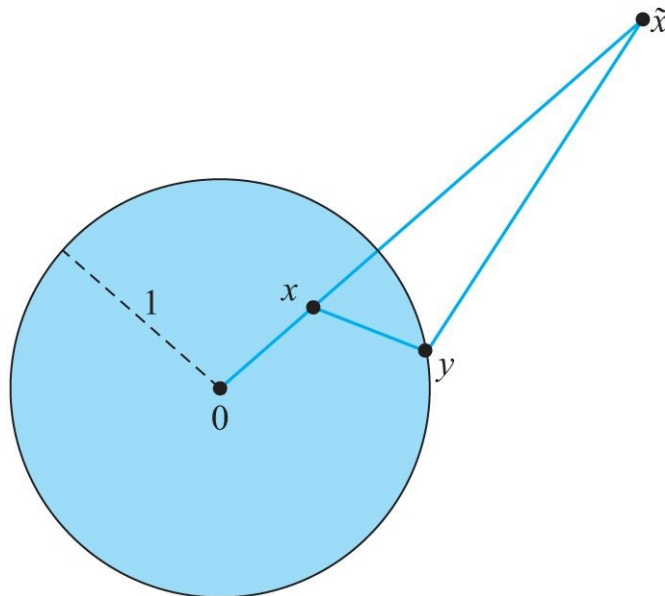

Figure 9.4. Method of images to derive Green's function for the unit ball.

But this follows because

$$|\mathbf{x}|^2|\tilde{\mathbf{x}} - \mathbf{y}|^2 = \left| \frac{\mathbf{x}}{|\mathbf{x}|} - |\mathbf{x}|\mathbf{y} \right|^2 = |\mathbf{x}|^2 - 2\mathbf{y} \cdot \mathbf{x} + 1 = |\mathbf{x} - \mathbf{y}|^2.$$

Consequently, $G(\mathbf{x}, \mathbf{y})$ given by (9.18) is the Green's function for the unit ball with Dirichlet boundary conditions.

In [Chapters 4–9](#) we have considered all three canonical second-order linear constant-coefficient PDE, emphasizing explicit solutions. In the next two chapters, we introduce more theoretical approaches to general linear elliptic equations.

PROBLEMS

1. Consider the boundary value problem

$$\begin{aligned} u'' &= f(x), & 0 < x < 1, \\ u'(0) &= 0 = u'(1), \end{aligned}$$

in which $f: [0, 1] \rightarrow \mathbb{R}$ is a given continuous function.

(a) Prove that there is no solution unless

$$\int_0^1 f(x) dx = 0 \tag{9.19}$$

(b) Assuming (9.19), prove that solutions are unique up to a constant. In other words, if u, v are two solutions, then

$$u(x) - v(x) = C, \quad 0 < x < 1$$

for some constant C .

(c) Write the solution $u(x)$ in the form

$$u(x) = \int_0^1 N(x, y) f(y) dy;$$

write a formula for the *Neumann function* $N(x, y)$.

2. Write an explicit formula for $\phi^y(x)$ for $G(x, y) = -\frac{1}{2}|x - y| + \phi^y(x)$, where G is given by (9.6), to verify that $\phi^y(x)$ is linear for each y .

3. Calculate the fundamental solution $u \in \mathcal{D}'(\mathbb{R})$ for the differential operator

$L = \frac{d}{dx} + c$, where $c \in \mathbb{R}$ and $c \neq 0$, satisfying $\lim_{|x| \rightarrow \infty} u(x) = 0$. That is, solve $\frac{du}{dx} + cu = \delta$. (Note: The sign of c will affect your solution.)

4. Compute $g * f$ for the functions

$$f(x) = \begin{cases} 1, & \text{if } 0 < x < 1, \\ 0, & \text{otherwise,} \end{cases} \quad g(x) = \begin{cases} x, & \text{if } |x| < 1, \\ 0, & \text{otherwise,} \end{cases}$$

and graph the convolution product $g * f$.

5. Verify that the examples of distributions f_1, f_2, f_3, f_4 in [Example 2](#) satisfy the conditions that define a distribution.

6. Prove that $\eta^\epsilon \rightarrow \delta$ in the sense of distributions, as $\epsilon \rightarrow 0$. (See (9.8).)

7. (a) Let $u(x, y) \in L_1^{loc}(\mathbb{R}^2)$. Define the distributional derivative $\frac{\partial u}{\partial x}$.

(b) Let $H : \mathbb{R} \rightarrow \mathbb{R}$ be the Heaviside function. Prove that $u(x, y) = H(y)$ satisfies $\frac{\partial u}{\partial x} = 0$ in the sense of distributions.

8. Let $k > 0$.

(a) Prove that $G_k(x, y) = C_k e^{-k|x-y|}$ is a fundamental solution for the equation

$$-u'' + k^2 u = f(x), \quad -\infty < x < \infty,$$

for some C_k . Find a formula for C_k .

(b) Find the Green's function for the boundary value problem

$$-u'' + k^2 u = f(x), \quad 0 < x < \infty, \quad u(0) = 0, \quad \lim_{x \rightarrow \infty} u(x) = 0.$$

9. Find a fundamental solution $\Phi(x)$ depending only on $r = |x|$, $x \in \mathbb{R}^3$, for the equation

$$-\Delta u(x) + k^2 u(x) = f(x), \quad x \in \mathbb{R}^3,$$

satisfying $\lim_{x \rightarrow \infty} \Phi(x) = 0$. Instead of having a delta function (on the right-hand side of the equation defining Φ), use the *source condition*

$$\lim_{\delta \rightarrow 0} \int_{|x|=\delta} \frac{\partial \Phi}{\partial \nu} dS = -1.$$

(Hint: Use a change of variable $u = rv$.)

10. Let $u(x) = |x_1^2 + x_2^2|^{-\alpha}$, $\mathbf{x} = (x_1, x_2) \in \mathbb{R}^2$. For what values of α is u in $L^2(B)$, where $B = \{\mathbf{x} : |\mathbf{x}| < 1\}$? Explain your answer.

11. Consider $f \in \mathcal{D}'(\mathbb{R})$, $g \in C^\infty(\mathbb{R})$.

(a) Derive the formula $(gf)' = gf' + g'f$ in the sense of distributions.

(b) Hence prove that

$$g(x)\delta'(x) = g(0)\delta'(x) - g'(0)\delta(x).$$

12. Let $u \in C(U)$ satisfy the mean-value property in a domain $U \subset \mathbb{R}^n$:

$$u(x) = \int_{\partial B(x,r)} u dS,$$

provided $B(x, r) \subset U$. Let $u^\epsilon = \eta_\epsilon * u$ in $U_\epsilon = \{x \in U : \text{dist}(x, \partial U) > \epsilon\}$, where $\text{dist}(x, S)$ denotes the shortest distance between a point x and a set S . Then $u^\epsilon \in$

$C^\infty(U)$. Prove the surprising result that $u^\epsilon = u$ on U_ϵ . Consequently, $u \in C^\infty(U)$ and is harmonic in U . In particular, harmonic functions are C^∞ ! (Hint: You will need a change of variables in the formula for u^ϵ to write the integral over $B(x, \epsilon)$ in polar coordinates ($dx = r^{n-1}drdS$) to take advantage of this version of the mean-value property.)

1. George Green, 1793–1841, was a self-taught British mathematician and physicist who made fundamental contributions to the theory of electricity and magnetism. Several theorems and functions related to these topics now carry his name.

Function Spaces

In this short chapter, we introduce function spaces that are used extensively in the analysis of partial differential equations.

10.1. Basic Inequalities and Definitions

Much of the theory of PDE relies on a variety of estimates, like the energy estimates we encountered in [Chapter 5](#) for the heat equation. Estimates are used to establish all aspects of well-posedness and regularity. PDE estimates routinely use the inequalities that we introduce and prove in this section, including some basic inequalities for function spaces, in particular, L^p spaces and Sobolev spaces.

10.1.1. Inequalities on \mathbb{R}

We begin with several inequalities between numbers, which form a basis for inequalities and estimates of functions.

Cauchy inequality. By rearranging $(a - b)^2 \geq 0$, we arrive at the inequality

$$ab \leq \frac{1}{2}(a^2 + b^2) \quad \text{for all } a, b \in \mathbb{R}.$$

Sometimes it is useful to weight the terms differently, as in the $\epsilon > 0$ version of the Cauchy inequality:

$$ab \leq \epsilon a^2 + \frac{b^2}{4\epsilon} \quad \text{for all } a, b \in \mathbb{R}. \quad (10.1)$$

Proof of (10.1). Apply Cauchy's inequality to $a\sqrt{2\epsilon} \cdot \frac{b}{\sqrt{2\epsilon}}$. ■

Young's inequality. This relation is a different generalization of the Cauchy inequality. For $p > 1$, define q by $\frac{1}{p} + \frac{1}{q} = 1$; we say q is *dual* to p . Then

$$ab \leq \frac{a^p}{p} + \frac{b^q}{q} \quad \text{for all } a > 0, b > 0.$$

This inequality is the Cauchy inequality when $p = q = 2$.

Proof. Minimize $f(a, b) = \frac{a^p}{p} + \frac{b^q}{q} - ab$. We leave the details to [Problem 2](#). ■

10.1.2. Function Spaces and Inequalities on Functions

Now we are prepared to define the function spaces we shall use. For each space,

we define a norm, and an inner product where possible.

For $1 \leq p < \infty$, define $L^p(U)$ to be the space of (measurable) functions whose p th power is integrable over $U \subset \int_U \mathbb{R}^n : |u|^p dx < \infty$. We define a norm on L^p by

$$\|u\|_{L^p(U)} = \left(\int_U |u|^p dx \right)^{\frac{1}{p}}.$$

As discussed for L^2 spaces in [Section 7.2](#), this defines a norm only if functions that are equal almost everywhere are considered equivalent. Then L^p is defined to be the space of equivalence classes, with the norm of an equivalence class defined as here, in which u is any element in the equivalence class. Sometimes we abbreviate the subscript and write $\|u\|_p$ for the L^p norm.

The space $L^\infty(U)$ is defined as the space of (measurable) functions that are *essentially bounded* over U , with norm given by the essential supremum (see [Appendix B](#)):

$$\|u\|_{L^\infty(U)} = \operatorname{ess\,sup}_U |u(x)| < \infty.$$

Of the following three defining properties of a norm, only the triangle inequality requires proof, as the first two follow directly from the definition of norm in L^p :

1. $\|u\| \geq 0$, with equality only for $u = 0$;
2. $\|\alpha u\| = |\alpha| \|u\|$ for all $\alpha \in \mathbb{R}$; and
3. $\|u + v\| \leq \|u\| + \|v\|$ (*the triangle inequality*).

The proof of the triangle inequality employs a further inequality involving integrals of functions.

Lemma 10.1. (*Hölder's inequality*) Let $u \in L^p(U)$, $v \in L^q(U)$, where $1 < p, q < \infty$ are dual: $\frac{1}{p} + \frac{1}{q} = 1$. Then

$$\int_U |uv| dx \leq \left(\int_U |u|^p dx \right)^{\frac{1}{p}} \left(\int_U |v|^q dx \right)^{\frac{1}{q}}. \quad (10.2)$$

Proof. Since Hölder's inequality is homogeneous, it is enough (and simpler to write) if we take $\|u\|_p = 1 = \|v\|_q$. Then we apply Young's inequality to $u(x)v(x)$ and integrate over U :

$$\begin{aligned} \int_U |u(x)v(x)| dx &\leq \int_U \left(\frac{1}{p}|u(x)|^p + \frac{1}{q}|v(x)|^q \right) dx \\ &= \frac{1}{p} + \frac{1}{q} = 1 = \|u\|_p \|v\|_q. \end{aligned}$$

■

The following case $p = q = 2$ is important enough to have its own name.

Theorem 10.2. (*The Cauchy-Schwartz inequality*) Let $u, v \in L^2(U)$. Then

$$\int_U |uv| dx \leq \left(\int_U |u|^2 dx \right)^{\frac{1}{2}} \left(\int_U |v|^2 dx \right)^{\frac{1}{2}}. \quad (10.3)$$

Now we can prove the triangle inequality for the L^p norm.

Proof of the triangle inequality. Let $u, v \in L^p(U)$. Then

$$\begin{aligned} \|u + v\|^p &= \int_U |u + v|^p dx \\ &\leq \int_U |u + v|^{p-1} (|u| + |v|) dx \\ &\leq \left(\int_U |u + v|^p dx \right)^{\frac{p-1}{p}} \left[\left(\int_U |u|^p dx \right)^{\frac{1}{p}} + \left(\int_U |v|^p dx \right)^{\frac{1}{p}} \right] \\ &= \|u + v\|^{p-1} (\|u\| + \|v\|). \end{aligned}$$

The triangle inequality now follows by dividing by $\|u + v\|^{p-1}$.

■

Recall that L^2 is special because it has an inner product

$$(f, g) = \int_U f(x) \overline{g(x)} dx, \text{ for } f, g \in L^2(U)$$

consistent with the L^2 norm $\|f\|_{L^2(U)} = (f, f)^{1/2}$. For the inner product (as for Hölder's inequality), we allow for the possibility of complex-valued functions. However, from now on unless otherwise stated, functions will be real valued.

It is sometimes helpful to think of L^p functions in terms of Fourier series. In the specific case of $L^2[0, \pi]$, we can explicitly and easily make the connection to the space ℓ^2 of sequences that are square-summable:

$$\ell^2 = \{ \{b_j\}_1^\infty : b_j \in \mathbb{R}, \sum_{j=1}^\infty b_j^2 < \infty \}$$

with inner product and norm defined by:

$$(x, y) = \sum_{j=1}^{\infty} x_j y_j, \quad \|x\|_{\ell^2} = \sqrt{(x, x)} = \left(\sum_{j=1}^{\infty} x_j^2 \right)^{\frac{1}{2}},$$

respectively, where $x = \{x_j\}$, $y = \{y_j\}$. In fact, Cauchy sequences in ℓ^2 converge, and their limits are in ℓ^2 . Thus, the linear inner product space ℓ^2 is complete, making it a Hilbert space.

To establish the connection between $L^2[0, \pi]$ and ℓ^2 , let $u \in L^2[0, \pi]$. Then

$$u = \sum_{j=1}^{\infty} (u, u_j) u_j,$$

where (\cdot, \cdot) is the L^2 inner product, and the sine functions $u_j = \sqrt{\frac{2}{\pi}} \sin jx$, $j = 1, 2, \dots$ form a complete orthonormal set. Now let $b_j = (u, u_j)$. Then Bessel's inequality (7.12) implies that the sequence $\{b_j\}$ is in ℓ^2 , and moreover, Parseval's identity is $\sum_{j=1}^{\infty} b_j^2 = \int_0^{\pi} u(x)^2 dx$. More concisely,

$$\|\{b_j\}\|_{\ell^2} = \|u\|_{L^2[0, \pi]}.$$

A fancy way to say this is that the mapping $J : L^2[0, \pi] \rightarrow \ell^2$ given by $J(u) = \{b_j\}$ is an *isometric isomorphism*.

Integrable functions are not necessarily continuous or even bounded. In the following examples, we examine the constraints between the nature of a singularity and the dimension of the space and the exponent p in order for the function to be in L^p . The first example examines the kind of singularity allowed in L^p functions. The second example is more sophisticated and shows that integrable functions can be very singular.

Example 1. (A singular function) Let $U = B(0, 1) \subset \mathbb{R}^n$. Consider the function

$$u(x) = \frac{1}{|x|^\beta}, \quad |x| > 0,$$

in which $\beta > 0$ is some constant, and $u(0) = 0$ (In fact, $u(0)$ does not have to be specified, since L^p functions need only be defined almost everywhere.)

To work out the values of n , β , p for which we have $u \in L^p(U)$, we need to understand when u^p is integrable. Note that u has a singularity at $x = 0$. To resolve this issue, we calculate $\int_U \frac{1}{|x|^{\beta p}} dx$, and find precisely when it is finite. For example, for $n = 1$, $\int_U \frac{1}{|x|^{\beta p}} dx = \int_0^1 \frac{1}{x^{\beta p}} dx < \infty$ if and only if $\beta p < 1$. Now we have to work out the effect of changing n on this condition. But in \mathbb{R}^n we have

$$\int_U \frac{1}{|x|^{\beta p}} dx = \int_{\partial B(0,1)} \int_0^1 \frac{1}{r^{\beta p}} r^{n-1} dr dS,$$

and this is finite precisely when the inner integral is finite, namely, when (as in the $n = 1$ case) the power of $1/r$ is less than unity: $\beta p - n + 1 < 1$:

$$\beta < \frac{n}{p}.$$

Example2. (A very singular integrable function) Let $\{q_j\}_{j=1}^{\infty}$ be an enumeration of the (countable) set of rationals in the interval $[0, 1]$. Define

$$u(x) = \sum_{j=1}^{\infty} 2^{-j} \frac{1}{|x - q_j|^{\beta}},$$

where $0 < \beta < 1$. Then the Monotone Convergence Theorem ([Appendix B](#)) implies that the series converges in $L^1[0, 1]$, but u is unbounded in every neighborhood of every point. Hence, although u is Lebesgue integrable, not only is it not Riemann integrable, it is *chronically* unbounded!

10.2. Multi-Index Notation

To further discuss function spaces, we use multi-index notation. This notation is also a convenient way to represent PDE of arbitrary order and with unspecified coefficients. A *multi-index*, $\alpha = \alpha_1 \dots \alpha_n$, is a sequence of nonnegative integers. We write the multi-index length as $|\alpha| = \alpha_1 + \dots + \alpha_n$. If $\mathbf{x} = (x_1, \dots, x_n) \in \mathbb{R}^n$, we write $\mathbf{x}^{\alpha} = (x_1^{\alpha_1}, \dots, x_n^{\alpha_n})$, and

$$D^{\alpha} = \left(\frac{\partial}{\partial x_1} \right)^{\alpha_1} \dots \left(\frac{\partial}{\partial x_n} \right)^{\alpha_n},$$

a differential operator of order $|\alpha|$. Be aware that for $\mathbf{x} \in \mathbb{R}^n$, the notation $|\mathbf{x}| = \left(\sum_{j=1}^n x_j^2 \right)^{\frac{1}{2}}$ is still the Euclidean norm. The multi-index length $|\alpha|$ is reserved for multi-indices.

Multi-index notation is useful for writing a polynomial of degree k in n variables \mathbf{x} as $\sum_{|\alpha| \leq k} a_{\alpha} \mathbf{x}^{\alpha} = 0$, with constant coefficients $a_{\alpha} \in \mathbb{R}$. Correspondingly, the notation allows us to write a general quasilinear PDE of order k as

$$\sum_{|\alpha| \leq k} a_{\alpha} D^{\alpha} u = f,$$

for theoretical purposes, where the coefficients a_{α} and right-hand side f are functions of u , derivatives of u , and of $\mathbf{x} \in \mathbb{R}^n$. In this form it is convenient to place assumptions on the coefficients (such as ellipticity of the PDE) to capture

whole classes of equations.

If u has a weak derivative $D^\alpha u$, then

$$\int_U D^\alpha u \phi \, dx = (-1)^{|\alpha|} \int_U u D^\alpha \phi \, dx$$

for all $\phi \in \mathcal{D}(U)$, the space of test functions.

Although multi-index notation is useful in some general contexts, such as in the next section, it is often simpler to use more conventional notation, such as $\frac{\partial}{\partial y}$ in place of D^{010} in \mathbb{R}^3 . Even a simple PDE like the wave equation $u_{xx} - u_{yy} - u_{zz} = 0$ looks ugly in multi-index notation:

$$D^{200}u - D^{020}u - D^{002}u = 0.$$

10.3. Sobolev Spaces $W^{k,p}(U)$

When studying solutions u of k th-order PDE, we need derivatives of u of order up to k . Sobolev spaces $W^{k,p}(U)$ consist of functions with *weak* derivatives up to order k , but with the additional requirement that the derivatives are in L^p ; that is, their p th powers are integrable. Thus, $W^{k,p}(U)$ is defined to be the space of functions u such that $D^\alpha u \in L^p(U)$ for all α such that $|\alpha| \leq k$. Sobolev spaces are used in the theory of PDE, for example, elliptic PDE in [Chapter 11](#).

The norm in $W^{k,p}(U)$ is defined for $1 \leq p < \infty$ by

$$\|u\|_{W^{k,p}(U)} = \left(\sum_{|\alpha| \leq k} \int_U |D^\alpha u|^p \, dx \right)^{\frac{1}{p}}.$$

For $p = \infty$, we define

$$\|u\|_{W^{k,\infty}(U)} = \sum_{|\alpha| \leq k} \operatorname{ess\,sup}_U |D^\alpha u|.$$

Just as we did for L^p spaces, we can ask when a function with an algebraic singularity is in $W^{k,p}$.

Example 3. (Another singular function) Consider the example $u(\mathbf{x}) = |\mathbf{x}|^{-\beta}$, $\mathbf{x} \in U = B(0, 1)$, $\mathbf{x} \neq 0$ (see [Example 1](#)). Then

$$\frac{\partial u}{\partial x_j} = -\frac{\beta x_j}{|\mathbf{x}|^{\beta+2}}, \tag{10.4}$$

which has a singularity like $\frac{1}{|\mathbf{x}|^{\beta+1}}$. Referring back to [Example 1](#), in L^p , we deduce that $\frac{\partial u}{\partial x_j} \in L^p(U)$ if and only if $(\beta + 1)p < n$. Thus, $u \in W^{1,p}(U)$ if and only if

$$\beta < \frac{n}{p} - 1.$$

When we study elliptic equations with homogeneous Dirichlet boundary conditions in the next chapter, the boundary conditions are built into the Sobolev spaces as follows. The space $W_0^{k,p}(U)$ is the completion of $C_c^\infty(U)$ in the $W^{k,p}(U)$ norm. That is, every element of $W_0^{k,p}(U)$ is the limit of a Cauchy sequence of smooth functions with compact support in U . In this sense we can think of $W_0^{k,p}(U)$ as the space of $W^{k,p}$ functions that are zero on the boundary ∂U . This notion is made precise with *trace theorems*, which are developed in Evans [12].

In the important case of $p = 2$, we write $H^k(U) = W^{k,2}(U)$. This space is a Hilbert space, in that it has an inner product and is complete (with respect to the norm defined by the inner product; see Appendix B). The inner product (\cdot, \cdot) on $H^k(U)$ is given by

$$(u, v)_{H^k(U)} = \sum_{|\alpha| \leq k} \int_U D^\alpha u D^\alpha v \, d\mathbf{x},$$

and the norm is $\|u\|_{H^k(U)} = (u, u)_{H^k(U)}^{1/2}$. We generally work with $H^1(U)$, for which the inner product is

$$(u, v)_{H^1(U)} = \int_U (uv + \nabla u \cdot \nabla v) \, d\mathbf{x}.$$

Moreover, we use the space $H_0^1 = W_0^{1,2}$ with the same H^1 norm.

Sobolev spaces are the natural environment in which to study general elliptic and parabolic PDE. In the next chapter we give a flavor of the theory of elliptic equations. A more extensive introduction to the subject is given in Evans [12].

PROBLEMS

1. Let X be a vector space with norm $\|\cdot\|$.

(a) Prove that for all $u, v \in X$,

$$| \|u\| - \|v\| | \leq \|u - v\|.$$

(b) Show that the function $f : X \rightarrow \mathbb{R}$ given by $f(u) = \|u\|$ is continuous but not linear.

2. Prove Young's inequality.

3. Use Hölder's inequality to prove the following.

(a) The generalization of Hölder's inequality to three functions $u \in L^p(U)$, $v \in L^q(U)$, $w \in L^r(U)$, with $p^{-1} + q^{-1} + r^{-1} = 1$:

$$\int_U |uvw| d\mathbf{x} \leq \|u\|_p \|v\|_q \|w\|_r.$$

(b) If $p \leq q \leq r$ and $1/q = \lambda/p + (1 - \lambda)/r$, then for $u \in L^r(U)$,

$$\|u\|_q \leq \|u\|_p^\lambda \|u\|_r^{1-\lambda}.$$

4. The partial derivative in (10.4) is not a function of r alone, so the calculation we did in Example 1 does not apply directly. Using coordinates $x = r\omega$, $|\omega| = 1$, do the integral that completes the argument to characterize when $u \in W^{1,p}(U)$.

5. Let $u^{(\alpha)}(x) = |x|(\sin |x|)^\alpha$, $x \in \mathbb{R}^3$. Find the precise range of $\alpha \in \mathbb{R}$ in which $u^{(\alpha)} \in H^1(B)$, where $B = \{x \in \mathbb{R}^3, |x| < 1\}$.

Elliptic Theory with Sobolev Spaces

We use Poisson's equation as a starting point to prove the existence of solutions of a boundary value problem in an appropriate Sobolev space. Then we show how a similar approach can be used for general linear second-order elliptic PDE. The structure of the more general results and their proofs provides insight into the techniques at the heart of the modern theory of elliptic PDE [12].

11.1. Poisson's Equation

Our previous approach to Poisson's equation involved finding the Green's function. Again we let $U \subset \mathbb{R}^n$ be open and bounded, let $f \in L^2(U)$, and consider the boundary value problem

$$\begin{aligned} -\Delta u &= f, & \text{in } U, \\ u &= 0, & \text{in } \partial U. \end{aligned} \tag{11.1}$$

The approach of finding the Green's function explicitly works only for special choices of U . Instead of relying on the shape of U , we can use functional analysis to establish the existence of a solution indirectly. The remainder of this section is devoted to using this approach to prove the following existence and uniqueness theorem.

Theorem 11.1. *For each $f \in L^2(U)$ there is a unique weak solution of (11.1).*

In this statement, note that $f \in L^2$ is no longer required to be smooth. Moreover, the theorem refers to weak solutions rather than classical solutions. A *weak solution* of (11.1) is a function $u \in H_0^1(U)$ such that

$$\int_U \nabla u \cdot \nabla v \, d\mathbf{x} = \int_U f v \, d\mathbf{x} \tag{11.2}$$

for all $v \in H_0^1(U)$. If $u \in C^2(U) \cap C(\bar{U})$ satisfies (11.1), we say that u is a *classical solution* of (11.1). In this case, u satisfies (11.2) for every $v \in C_c^\infty(U)$, as is easily checked by integration by parts. Since functions in $H_0^1(U)$ are approximated in the H^1 norm by smooth functions (see Section 10.3), so (11.2) makes sense as a definition of weak solution.

Weak solutions have the advantage that they require less regularity (one weak derivative rather than two classical derivatives), and moreover, we can look at weak solutions in a space of functions that has an inner product and is complete, which is not possible with smooth functions.

Since the proof of [Theorem 11.1](#) involves several subsidiary results, we outline the steps that make up the proof. The theorem establishes both existence and uniqueness of weak solutions of (11.1) satisfying (11.2). In this section we prove this result using the Riesz Representation Theorem. We first identify the left-hand side of (11.2) as an inner product in $H_0^1(U)$, thereby defining an equivalent norm for $H_0^1(U)$. Second we verify that the right-hand side defines a bounded linear functional on $H_0^1(U)$. We accomplish both using the Poincaré inequality. Then the conclusion of the Riesz Representation theorem is the existence and uniqueness of $u \in H_0^1(U)$ satisfying (11.2). This completes the proof of the theorem.

11.1.1. The Poincaré Inequality

The Poincaré inequality is an example of an estimate in a function space that allows a norm of a function to be estimated by the norm of a derivative of the function. The specific estimate in the Poincaré inequality bounds the L^2 norm of an H_0^1 function by the L^2 norm of its derivative, a crucial step in establishing the left-hand side of (11.2) as an inner product.

Lemma 11.2. *(The Poincaré inequality) Let $U \subset \mathbb{R}^n$ be open and bounded. There exists a constant C , depending only on U , such that*

$$\|u\|_{L^2(U)} \leq C \|\nabla u\|_{L^2(U)}$$

for all $u \in H_0^1(U)$.

Proof. We use the approximation idea here for the first time. We prove the lemma for $u \in C_c^\infty(U)$ and then argue by taking limits of sequences that it holds for $u \in H_0^1(U)$. The proof is simple in one dimension and is very similar in \mathbb{R}^n . Let $U = (a, b) \subset \mathbb{R}$, and suppose $u \in C_c^\infty(U)$. Then $u(a) = 0 = u(b)$. Now we calculate

$$\begin{aligned} \|u\|_{L^2(a,b)}^2 &= \int_a^b u(x)^2 dx \\ &= xu(x)^2 \Big|_a^b - \int_a^b x2uu' dx \quad (\text{integrating by parts}) \\ &\leq C \left| \int_a^b uu' dx \right| \quad (\text{where } C = 2 \max(|a|, |b|)) \\ &\leq C \|u\|_{L^2(a,b)} \|u'\|_{L^2(a,b)} \quad (\text{Cauchy-Schwartz inequality}). \end{aligned}$$

Dividing by $\|u\|_{L^2(a,b)}$ completes the proof in one dimension.

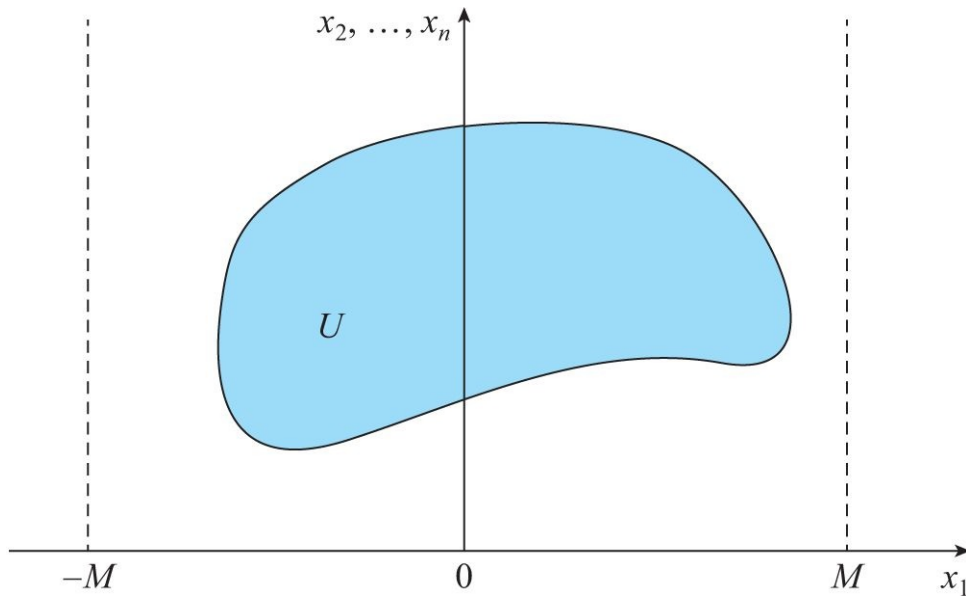

Figure 11.1. The domain U bounded by two hyperplanes.

In higher dimensions, we simply integrate by parts in one of the variables, say, x_1 . So, suppose U lies between the hyperplanes $\{x_1 = \pm M\}$, for some $M > 0$, as illustrated in [Figure 11.1](#). (This suggests that U could be unbounded, and indeed the Poincaré inequality is often stated for domains bounded in some direction, but not necessarily bounded in \mathbb{R}^n .) Mimicking the calculation above, let $u \in C_c^\infty(U)$. Then

$$\begin{aligned}
 \|u\|_{L^2(U)}^2 &= \int_U u(x)^2 dx \\
 &= - \int_U 2x_1 u \frac{\partial u}{\partial x_1} dx \quad (\text{integrating by parts in } x_1) \\
 &\leq 2M \left| \int_U u \frac{\partial u}{\partial x_1} dx \right| \\
 &\leq C \|u\|_{L^2(U)} \left\| \frac{\partial u}{\partial x_1} \right\|_{L^2(U)} \\
 &\leq C \|u\|_{L^2(U)} \|Du\|_{L^2(U)}.
 \end{aligned}$$

The second inequality relies on the Cauchy-Schwartz inequality with $C = 2M$. This proves the inequality for $u \in C_c^\infty(U)$.

Now let $\{u_m\} \subset C_c^\infty(U)$, $u_m \rightarrow u \in H_0^1(U)$. (Such a sequence exists from the definition of $H_0^1(U)$ as the completion of $C_c^\infty(U)$ in the H^1 norm.) Then $\|u_m\|_{L^2(U)} \rightarrow \|u\|_{L^2(U)}$, and $\|Du_m\|_{L^2(U)} \rightarrow \|Du\|_{L^2(U)}$, from which the lemma follows. ■

11.1.2. An Equivalent Norm on $H_0^1(U)$

We define the new norm

$$\|u\|_{1,2} = \|Du\|_{L^2(U)}, \quad \text{for } u \in H_0^1(U),$$

where the subscript 1, 2 refers to one derivative of u in L^p with $p = 2$. The new norm is useful because the weak formulation (11.2) only involves the gradient on the left-hand side, which will now be the inner product corresponding to this norm. For bounded U and $u \in H_0^1(U)$, the Poincaré inequality implies the new norm is equivalent to the H_0^1 norm:

$$\|u\|_{1,2} \leq \|u\|_{H_0^1(U)} \leq C_1 \|u\|_{1,2}.$$

The latter inequality involves a small amount of manipulation:

$$\begin{aligned} \|u\|_{H_0^1(U)} &= \left(\int_U u^2 dx + \int_U |Du|^2 dx \right)^{\frac{1}{2}} \\ &\leq \|u\|_{L^2(U)} + \|Du\|_{L^2(U)} \\ &\leq C \|Du\|_{L^2(U)} + \|Du\|_{L^2(U)} = C_1 \|u\|_{1,2}. \end{aligned}$$

Because the norms are equivalent, we conclude that $H_0^1(U)$ is a Hilbert space with the new inner product given by the left-hand side of (11.2).

To apply the Riesz Representation Theorem (Section 11.1.3), we need to show that $f \in L^2(U)$ defines a bounded linear functional on $H_0^1(U)$. This allows us to equate the right-hand side of the weak formulation (11.2) with a bounded linear functional.

Lemma 11.3. *Let $U \subset \mathbb{R}^n$ be open and bounded, and let $f \in L^2(U)$. Then the linear functional $F : H_0^1(U) \rightarrow \mathbb{R}$, defined by*

$$F(v) = \int_U f v dx, \quad v \in H_0^1(U)$$

is bounded, meaning there is a constant $K > 0$ such that

$$|F(v)| \leq K \|v\|_{H_0^1(U)} \quad \text{for each } v \in H_0^1(U).$$

Proof. Let $v \in H_0^1(U)$. Then

$$\begin{aligned} |F(v)| &= \left| \int_U f v dx \right| \\ &\leq \|f\|_{L^2(U)} \|v\|_{L^2(U)} \quad (\text{Cauchy-Schwartz}) \\ &\leq C \|f\|_{L^2(U)} \|v\|_{1,2} \leq K \|v\|_{H_0^1(U)}. \end{aligned}$$

Hence F is bounded. ■

11.1.3. The Riesz Representation Theorem

To complete the proof of [Theorem 11.1](#), we show that for each $f \in L^2(U)$ there is a unique $u \in H_0^1(U)$ such that (11.2) holds; that is, $(u, v)_{1,2} = F(v)$ for every $v \in H_0^1(U)$. This follows from the following *Riesz Representation Theorem* for a general Hilbert space X with inner product (\cdot, \cdot) . We only consider Hilbert spaces over the reals, but the result can also be stated for complex Hilbert spaces.

Theorem 11.4. (*Riesz Representation Theorem*) *Let X be a Hilbert space, and let $F : X \rightarrow \mathbb{R}$ be a bounded linear functional on X . Then there exists a unique $u \in X$ such that*

$$F(v) = (u, v) \tag{11.3}$$

for all $v \in X$.

Proof. The proof involves the null space N of F :

$$N = \{w \in X : F(w) = 0\}.$$

First, let's dispense with the trivial case, in which $N = X$. Then only $u = 0$ satisfies (11.3).

Now we consider $N \neq X$. In this case, (11.3) implies $u \notin N$. To see this, suppose $u \in N$, and let $v = u$ in (11.3). Then $0 = F(u) = (u, u)$, which implies $u = 0$. But then (11.3) fails for any $v \notin N$. Thus, we seek $u \notin N$.

We complete the proof in essentially three steps. First, we show there is a nonzero $z \in X$ that is orthogonal to N : $(z, v) = 0$ for all $v \in N$. Put another way, $F(v) = (z, v)$ for all $v \in N$, so z is the correct choice for u , except that if $u = z$, then (11.3) will not be satisfied in general for v in the complement of N . In the second step, we adjust z to get the correct u by noting that the complement of N is one dimensional (so N has codimension one). This follows since the range of F is one dimensional. Thus, the orthogonal complement N^\perp of N is one dimensional and hence is spanned by z . Therefore, $F(\alpha z)$ must range through all of \mathbb{R} as α ranges through \mathbb{R} , since $F(z) \neq 0$. So, we should be able to find u to satisfy (11.3) by scaling z : $u = \alpha z$, for some $\alpha \in \mathbb{R}$. In fact, setting $v = u = \alpha z$ in (11.3), we can calculate what α must be for this special case, leading to

$$u = \frac{F(z)}{\|z\|^2} z. \tag{11.4}$$

Then $F(u) = \|u\|^2$. In the third step of the proof, we show that (11.3) holds for this choice of u .

To find $z \in N^\perp$, we use standard functional analysis arguments. First we show that N is closed. Suppose $\{u_n\} \subset N$ and $u_n \rightarrow u$ as $n \rightarrow \infty$. N is closed if $u \in N$. But

$$|F(u)| = |F(u_n) - F(u)| = |F(u_n - u)| \leq K \|u_n - u\| \rightarrow 0,$$

as $n \rightarrow \infty$, using linearity and then boundedness of F . Therefore, $F(u) = 0$, meaning $u \in N$.

Since N is not the entire space, there is $x \in X$ such that $x \notin N$. But N is closed, so the distance from x to N (defined in [problem 12, Chapter 9](#)) is positive:

$$\text{dist}(x, N) = \inf_{y \in N} \|x - y\| = d > 0.$$

We now prove that there is $w \in N$ such that $\text{dist}(x, N) = \|x - w\|$. Indeed, there is a sequence $\{w_n\} \subset N$ such that $\|x - w_n\| \rightarrow \text{dist}(x, N)$. It takes a tricky calculation to show that $\{w_n\}$ is a Cauchy sequence. First, we appeal to the parallelogram law

$$\|u + v\|^2 + \|u - v\|^2 = 2(\|u\|^2 + \|v\|^2),$$

which is verified by expressing the norms in terms of the inner product. Now we set $u = x - \frac{1}{2}(w_n + w_m)$, $v = \frac{1}{2}(w_n - w_m)$ in the parallelogram law:

$$\|x - w_m\|^2 + \|x - w_n\|^2 = 2\|x - \frac{1}{2}(w_n + w_m)\|^2 + \frac{1}{2}\|(w_n - w_m)\|^2.$$

As $m, n \rightarrow \infty$, the left-hand side of this identity approaches $2d^2$. However, the first term on the right is no smaller than $2d^2$, and so the second term must approach zero: $\|w_n - w_m\| \rightarrow 0$ as $m, n \rightarrow \infty$. Hence $\{w_n\}$ is a Cauchy sequence, and is therefore convergent to an element $w \in N$, since X is complete and N is closed. Moreover, $\|x - w\| \leq \|x - w_n\| + \|w_n - w\| \rightarrow d$ as $n \rightarrow \infty$. Thus, $\|x - w\| \leq d$, which implies $\|x - w\| = d$, since $w \in N$, and $d = \inf_{y \in N} \|x - y\|$.

Now let $z = x - w$. We show that $z \in N^\perp$. Let $y \in N$. Then for any $\lambda \in \mathbb{R}$, $w + \lambda y \in N$, so

$$d^2 = \|z\|^2 \leq \|z - \lambda y\|^2 = \|z\|^2 - 2\lambda(z, y) + \lambda^2\|y\|^2.$$

If we choose $\lambda = (z, y)/\|y\|^2$, then the inequality becomes

$$\|z\|^2 \leq \|z\|^2 - \frac{(z, y)^2}{\|y\|^2},$$

which implies $(z, y) = 0$. Since $y \in N$ is arbitrary, we have $z \in N^\perp$.

Next we prove that u given by (11.4) satisfies (11.3). Since $u \notin N$, we have $F(u) \neq 0$. Moreover, using linearity of F , we observe that

$$F\left(v - \frac{F(v)}{F(u)}u\right) = 0 \quad \text{for any } v \in X, \text{ so } v - \frac{F(v)}{F(u)}u \in N.$$

Thus, since $u \in N^\perp$,

$$\left(u, v - \frac{F(v)}{F(u)}u \right) = 0.$$

But this leads immediately to (11.3), since u was constructed to satisfy $F(u) = \|u\|^2$.

It remains to prove uniqueness of $u \in X$ satisfying (11.3). Suppose there are two values of u , say $u = u_k$, $k = 1, 2$, both of which satisfy (11.3). Then $(u_k, v) = F(v)$, $k = 1, 2$, from which we get $(u_1 - u_2, v) = 0$ for all $v \in X$. Hence $u_1 = u_2$.

This completes the proof of the Riesz Representation Theorem. ■

The proof of Theorem 11.1 is now complete.

11.2. Linear Second-Order Elliptic Equations

In this section we prove Theorem 11.1 for more general second-order linear elliptic partial differential equations. First we frame the boundary value problems that we will consider. Let $U \subset \mathbb{R}^n$ be open and bounded, and let $u: \bar{U} \rightarrow \mathbb{R}$. Define

$$Lu = - \sum_{i,j=1}^n \left(a^{ij}(\mathbf{x})u_{x_i} \right)_{x_j} + c(\mathbf{x})u. \quad (11.5)$$

Note that we suppress the independent variable in u , but retain it in the coefficients to emphasize that they are functions of \mathbf{x} . We will see that L is associated with a *symmetric* operator in which the leading-order (i.e., second-order) terms are written in *divergence form*. A more general form of a linear second-order linear differential operator (with leading-order terms in divergence form), is given by

$$Lu = - \sum_{i,j=1}^n \left(a^{ij}(\mathbf{x})u_{x_i} \right)_{x_j} + \sum_{i=1}^n b^i(\mathbf{x})u_{x_i} + c(\mathbf{x})u, \quad (11.6)$$

which is nonsymmetric when the coefficients b^i are not all zero.

The coefficients a^{ij} , c are given L^∞ functions on U . Without loss of generality, we can assume that the a^{ij} s are symmetric in ij : $a^{ij} = a^{ji}$. We place additional conditions on the coefficients as we go along. Generalizing problem (11.1), we let $f \in L^2(U)$ and consider the boundary value problem

$$\begin{aligned} Lu &= f, & \text{in } U, \\ u &= 0, & \text{in } \partial U. \end{aligned} \quad (11.7)$$

To define weak solutions, we multiply $Lu = f$ by a test function and integrate by parts over U . Thus, a weak solution of (11.7) is a function $u \in H_0^1(U)$ such that

$$B[u, v] = (f, v)_{L^2(U)} \quad \text{for all } v \in H_0^1(U), \quad (11.8)$$

where

$$B[u, v] = \sum_{i,j=1}^n \int_U a^{ij}(\mathbf{x}) u_{x_i} v_{x_j} d\mathbf{x} + \sum_{i=1}^n \int_U b^i(\mathbf{x}) u_{x_i} v d\mathbf{x} + \int_U c(\mathbf{x}) uv d\mathbf{x}. \quad (11.9)$$

As in Poisson's equation, boundary terms from integration by parts are all zero, due to the choice of $u = 0$ as the boundary condition. Note that in the symmetric case $b^i(\mathbf{x}) \equiv 0$, $i = 1, \dots, n$, the middle term is absent, and indeed then B is symmetric:

$$B[u, v] = B[v, u].$$

In the symmetric case, treated in [Section 11.2.1](#), we relate $B[u, v]$ to the inner product on $H_0^1(U)$, and to do so, we require L to be elliptic. In fact, we shall require L to be *uniformly elliptic*, meaning that there is $\theta > 0$ such that

$$\sum_{i,j=1}^n a^{ij}(x) \xi_i \xi_j \geq \theta |\xi|^2 \quad (11.10)$$

for all $x \in U$, $\xi \in \mathbb{R}^n$.

11.2.1. Existence and Uniqueness of Solutions in the Symmetric Case

Here we give the existence and uniqueness theorem for solutions of problem (11.7) when L is symmetric. An immediate difficulty is that the zeroth-order term $c(x)u$ is not controlled, in the sense that unless we make assumptions about $c(x)$, the corresponding term in the bilinear functional (11.9) is not bounded. An analogous issue arises in the finite-dimensional case, where the operators are square matrices. Consider a symmetric matrix A with positive eigenvalues, say, $\lambda \geq \theta > 0$, and a given $c \in \mathbb{R}$. Then we consider the equation

$$Lv = Av + cv = F,$$

for a given vector F , where $L = A + cI$. (I is the identity matrix.) To obtain existence and uniqueness, we require that c not be an eigenvalue of $-A$. This would be guaranteed if we know $c > 0$. For the PDE case, we state this slightly differently, to accommodate the dependence of coefficients on $x \in U$. In terms of the matrix problem, we require that there exists a $\gamma > 0$ such that for all $\mu > \gamma$ and any F , there is a unique solution of the equation

$$Lv + \mu v = F.$$

Of course, this is merely the condition that $c + \gamma$ be larger than the largest eigenvalue of $-A$.

In the PDE version, to make the bilinear functional nonnegative when $v = u$, we add a large enough number μ to $c(x)$ so that the final term in (11.9) resembles a weighted L^2 norm when $v = u$. Effectively this guarantees that μ is away from eigenvalues of the PDE operator L .

Theorem 11.5. *Let L be the symmetric operator given by (11.5). There exists $\gamma \in \mathbb{R}$ such that for all $\mu > \gamma$ and any $f \in L^2(U)$, there is a unique weak solution $u \in H_0^1(U)$ of the problem*

$$\begin{aligned} Lu + \mu u &= f, & \text{in } U \\ u &= 0, & \text{on } \partial U. \end{aligned}$$

To prove this theorem, we will use the Riesz Representation Theorem, but to establish a suitable inner product in terms of $B[u, v]$, we need two key estimates provided by the following lemma. One estimate establishes that B is bounded, and the second estimate allows us to modify $B[u, v]$ in order to define a norm.

Lemma 11.6. *There are constants $\alpha > 0$, $\beta > 0$, $\gamma \geq 0$ such that for all u, v in $H_0^1(U)$,*

1. $|B[u, v]| \leq \alpha \|u\|_{H_0^1(U)} \|v\|_{H_0^1(U)}$, and
2. $\beta \|u\|_{H_0^1(U)}^2 \leq B[u, u] + \gamma \|u\|_{L^2(U)}^2$.

Proof of Lemma 11.6. To prove estimate 1, we work directly with B :

$$\begin{aligned} |B[u, v]| &\leq \int_U \sum_{i,j=1}^n |a^{ij} u_{x_j} v_{x_i}| dx + \int_U |cuv| dx \\ &\leq \sum_{i,j=1}^n \|a^{ij}\|_{L^\infty(U)} \int_U |Du| |Dv| dx + \|c\|_{L^\infty(U)} \int_U |u| |v| dx \\ &\leq C_1 \left(\int_U |Du|^2 dx \right)^{\frac{1}{2}} \left(\int_U |Dv|^2 dx \right)^{\frac{1}{2}} + C_2 \|u\|_{L^2(U)} \|v\|_{L^2(U)} \\ &\hspace{20em} \text{(by Cauchy-Schwartz)} \\ &\leq \alpha \|u\|_{H_0^1(U)} \|v\|_{H_0^1(U)}. \end{aligned}$$

For estimate 2, we use ellipticity, replacing ξ_i by u_{x_i} in the definition (11.10). First note that the Poincaré inequality (Lemma 11.2) implies

$$\|u\|_{H_0^1(U)}^2 = \|u\|_{L^2(U)}^2 + \|Du\|_{L^2(U)}^2 \leq K \|Du\|_{L^2(U)}^2,$$

with $K = 1 + C$. Then we have

$$\begin{aligned}
\frac{\theta}{K} \|u\|_{H_0^1(U)}^2 &\leq \theta \|Du\|_{L^2(U)}^2 \leq \int_U \sum_{i,j=1}^n |a^{ij} u_{x_i} u_{x_j}| \\
&\leq B[u, u] + \left| \int_U c(x) u^2 dx \right| \\
&\leq B[u, u] + \|c\|_{L^\infty(U)} \|u\|_{L^2(U)}^2.
\end{aligned}$$

This proves the lemma, with $\gamma = \|c\|_{L^\infty(U)}$, $\beta = \theta/K$. ■

Proof of Theorem 11.5. We modify $B[u, v]$ in Lemma 11.6 to be

$$B^\mu[u, v] = B[u, v] + \mu(u, v)_{L^2(U)}.$$

Then B^μ is symmetric and satisfies

$$B^\mu[u, u] \geq \beta \|u\|_{H_0^1(U)}^2 + (\mu - \gamma) \|u\|_{L^2(U)}^2.$$

Thus, for $\mu > \gamma$, $B^\mu[u, u] \geq 0$, and $B^\mu[u, u] = 0$ only for $u = 0$. Consequently, $B^\mu[u, v]$ defines an inner product on $H_0^1(U)$. The Riesz Representation Theorem (Theorem 11.4) completes the proof. ■

11.2.2. The Nonsymmetric Case

When L is nonsymmetric, $B[u, v]$ cannot define an inner product, because it is not symmetric in u, v . Nonetheless, a natural generalization of the Riesz Representation Theorem can be formulated to cover the situation. That is, the functional F is represented by an element $f \in H_0^1(U)$ as before, and there is a unique u satisfying (11.8). The proof of this generalization, the Lax-Milgram Theorem, uses the Riesz Representation Theorem in a different, more subtle way. To overcome the lack of symmetry in $B[u, v]$, we start by fixing u so that $B[u, v]$ defines a bounded linear functional, as a function of v . Then the Riesz Representation Theorem gives an element w depending linearly on u so that $B[u, v] = (w, v)$ for all v . The subtle part of the proof involves showing that u can be varied so that $w = f$, the representative of the functional $F(v)$ used in the symmetric case. That is, we need to show that the linear mapping $u \rightarrow w$ is onto; uniqueness follows by showing it is one-to-one.

Theorem 11.7. (Lax-Milgram Theorem) *Let H be a Hilbert space with inner product (\cdot, \cdot) and norm $\|\cdot\|$. Let $B : H \times H \rightarrow \mathbb{R}$ be a bilinear functional such that the following properties hold*

1. B is bounded, meaning $|B[u, v]| \leq \alpha \|u\| \|v\|$ for all $u, v \in H$ (for some constant $\alpha > 0$); and

2. there exists $\beta > 0$ such that $B[u, u] \geq \beta \|u\|^2$ for all $u \in H$.

Then for any bounded linear functional $F : H \rightarrow \mathbb{R}$, there exists a unique $u \in H$ such that

$$B[u, v] = F(v) \quad \text{for all } v \in H. \quad (11.11)$$

Proof. Let $u \in H$. Then $v \mapsto B[u, v]$ defines a bounded linear functional on H , by property 1 of the theorem. Therefore, by the Riesz Representation Theorem, there exists a unique $w \in H$ such that

$$B[u, v] = (w, v) \quad \text{for all } v \in H.$$

Let's define the mapping $A : H \rightarrow H$ by $Au = w$. Then

$$B[u, v] = (Au, v) \quad \text{for all } v \in H.$$

Here is how the rest of the argument goes. Since F is a bounded linear functional, the Riesz Representation Theorem implies there is a representative $w \in H$ for F :

$$F(v) = (w, v) \quad \text{for all } v \in H.$$

Suppose we can show that w is in the range of A . Then there is a $u \in H$ such that $Au = w$. But this implies $F(v) = (w, v) = (Au, v) = B[u, v]$ for all $v \in H$, which completes the proof of existence. Uniqueness follows if we show that A is one-to-one. Of course, we have no control over w , so to show it is in the range of A , we must show that the range of A is all of H . We do this in several steps.

First, note that A is linear. It is also easy to see that property 1 implies that A is bounded:

$$\|Aw\|^2 = (Aw, Aw) = B[w, Aw] \leq \alpha \|w\| \|Aw\|.$$

Dividing by $\|Aw\|$, we obtain $\|Aw\| \leq \alpha \|w\|$ for all $w \in H$.

Next we prove that A is one-to-one. From property 2, we have

$$\beta \|u\|^2 \leq B[u, u] = (Au, u) \leq \|Au\| \|u\|.$$

Now divide by $\|u\|$ to obtain $\|Au\| \geq \beta \|u\|$. Suppose $Au_1 = Au_2$. Then $A(u_1 - u_2) = 0$. Thus,

$$0 = \|A(u_1 - u_2)\| \geq \beta \|u_1 - u_2\|.$$

Hence, $u_1 - u_2 = 0$. This proves that A is one-to-one.

Next we show that A is onto H . The key is to show that the range $R(A)$ of A is *closed*: it contains the limits of all Cauchy sequences in $R(A)$.

Let $\{u_n\}$ be a Cauchy sequence in $R(A)$. Since H is complete, the sequence converges to some $u \in H$. Now $u_n = Aw_n$ for some $w_n \in H$, for each n . We need to

show that $\{w_n\}$ is a Cauchy sequence, since then it converges to an element w , and we use boundedness of A to show that $Aw = u$. But we have $\|u_n - u_m\| = \|A(w_n - w_m)\| \geq \|w_n - w_m\|$. Since $\{u_n\}$ is a Cauchy sequence, so is $\{w_n\}$. Let $w = \lim_{n \rightarrow \infty} w_n$. Then

$$u = \lim_{n \rightarrow \infty} u_n = \lim_{n \rightarrow \infty} Aw_n = Aw.$$

Thus, $u \in R(A)$, proving that $R(A)$ is closed.

Now we know from the proof of the Riesz Representation Theorem that if $R(A) \neq H$, then since $R(A)$ is closed, there is $u \in R(A)^\perp$ with $u \neq 0$. But then

$$0 = (u, Au) = B[u, u] \geq \beta \|u\|^2,$$

which implies $u = 0$. Thus, $R(A) = H$.

We use the construction and properties of A to prove the existence of $u \in H$ satisfying (11.11). Let $F : H \rightarrow \mathbb{R}$ be a bounded linear functional. By the Riesz Representation Theorem, there exists a unique $w \in H$ such that $F(v) = (w, v)$ for all $v \in H$. But we have just gone to a lot of trouble to prove that every element of H is also in $R(A)$. In particular, there is a unique $u \in H$ such that $Au = w$. Putting this all together, for any $v \in H$,

$$B[u, v] = (Au, v) = (w, v) = F(v),$$

as required.

Uniqueness of u satisfying (11.11) follows naturally. Let u_1, u_2 be two values of u satisfying (11.11). Then

$$B[u_1 - u_2, v] = B[u_1, v] - B[u_2, v] = F(v) - F(v) = 0$$

for all $v \in H$. In particular, letting $v = u_1 - u_2$, we obtain $0 = B[v, v] \geq \beta \|v\|^2$. Thus, $v = u_1 - u_2 = 0$. This completes the proof of the Lax-Milgram Theorem. ■

Now, to turn the Lax-Milgram Theorem into an existence and uniqueness theorem for elliptic equations, we have to verify the hypotheses of the theorem when B is the bilinear functional associated with the elliptic partial differential operator. This is only interesting in the nonsymmetric case, since the Riesz Representation Theorem covers the symmetric case. But in the nonsymmetric case, we have to work a bit harder to prove property 2 of the Lax-Milgram Theorem. Specifically, we wish to prove the two estimates 1 and 2 of Lemma 11.6, but this time for B given by (11.9) with b^i not identically zero. Estimate 1 is straightforward; we leave it as an exercise. Estimate 2, however, requires a bit more ingenuity. Let's proceed much as we did in Lemma 11.6, using ellipticity to establish

$$\begin{aligned}
\frac{\theta}{K} \|u\|_{H_0^1(U)}^2 &\leq \theta \|Du\|_{L^2(U)}^2 \leq \left| \int_U \sum_{i,j=1}^n a^{ij} u_{x_i} u_{x_j} dx \right| \\
&= \left| B[u, u] - \int_U \sum_{i=1}^n b^i(x) u_{x_i} u dx - \int_U c(x) u^2 dx \right| \quad (11.12) \\
&\leq B[u, u] + \sum_{i=1}^n \|b^i\|_{L^\infty(U)} \int_U |u_{x_i}| |u| dx + \|c\|_{L^\infty(U)} \|u\|_{L^2(U)}^2.
\end{aligned}$$

The difference is that now we need to estimate the middle term. This is achieved with Young's inequality:

$$\int_U |u_{x_i}| |u| dx \leq \epsilon \|Du\|_{L^2(U)}^2 + \frac{1}{4\epsilon^2} \|u\|_{L^2(U)}^2. \quad (11.13)$$

Now the first term is incorporated into the left-hand side of (11.12); this will change $\theta > 0$, but keep θ positive provided we choose $\epsilon > 0$ small enough. Similarly, the second term in (11.13) is incorporated into the final term in (11.12). After some manipulation of the constants, estimate 2 of Lemma 11.6 is proved. These properties are the key to proving Theorem 11.5 for the general case, which we now state.

Theorem 11.8. *Let L be the PDE operator given by (11.6). There exists $\gamma \in \mathbb{R}$ such that for all $\mu > \gamma$ and any $f \in L^2(U)$, there is a unique weak solution $u \in H_0^1(U)$ of the problem*

$$\begin{aligned}
Lu + \mu u &= f, \quad \text{in } U, \\
u &= 0, \quad \text{on } \partial U.
\end{aligned}$$

PROBLEMS

1. Let $U \subset \mathbb{R}^n$ be a bounded open set, and let $u(x) = 1$, $x \in U$. Prove that $u \in H^1(U)$, but $u \notin H_0^1(U)$. (Hint: Use proof by contradiction and Poincaré's inequality.)
2. Let $A(x) = (a^{ij}(x))$ be the matrix of coefficients of the principal part of a linear second-order elliptic partial differential operator L . Prove that if L is uniformly elliptic on U , with parameter θ given in (11.10), then for each $x \in U$, the eigenvalues λ of $A(x)$ are bounded below by θ : $\lambda \geq \theta$.
3. Consider the ordinary differential operator $Lu(x) = u''(x) + cu(x)$. Then, with $U = (0, 1)$, we should be able to solve

$$\begin{aligned}
Lu + \mu u &= f, \quad 0 < x < 1, \\
u(0) &= 0 = u(1).
\end{aligned}$$

for large enough μ . Find $\gamma > 0$ for which Theorem 11.8 holds true by finding the

eigenvalues of $-\frac{d^2}{dx^2}$.

4. Let $u = u(x, y)$, $Lu = -xu_{xx} + (2 + y)u_{xy} - 2u_{yy}$. Characterize the region in \mathbb{R}^2 in which L is uniformly elliptic.

5. Find the smallest $c \in \mathbb{R}$ for which L given by $Lu = -(xu_{xx} + u_{xy} + u_{yy})$ is uniformly elliptic on the set $\{(x, y) \in \mathbb{R}^2 : x > c + \epsilon\}$ for every $\epsilon > 0$.

6. Expand the identity $\|u + v\|^2 = (u + v, u + v)$. Then use the triangle inequality to prove the Cauchy-Schwarz inequality $(u, v) \leq \|u\| \|v\|$.

Traveling Wave Solutions of PDE

We have seen in earlier chapters how the method of separation of variables can reduce PDE to ODE. This technique works most effectively on linear PDE. In this chapter we describe the analysis of traveling wave solutions of nonlinear PDE, which involves ODE.

There is an overall pattern to the technique of this chapter. For each PDE with an unknown function $u(x, t)$, $-\infty < x < \infty$, we consider traveling wave solutions $u = \tilde{u}(x - st)$, in which the parameter s is the wave speed, to be determined in the course of the analysis. Substituting $u = \tilde{u}$ into the PDE yields an autonomous ODE for $\tilde{u}(\xi)$, $\xi = x - st$. The ODE will have equilibria, and traveling waves correspond to solutions that connect those equilibria, either to one another or to themselves, because the solutions $\tilde{u}(\xi)$ that we seek approach an equilibrium as $\xi \rightarrow \pm \infty$.

Each section of the chapter is devoted to the analysis of traveling waves for a different equation. We begin in [Section 12.1](#) with Burgers' equation, for which the nonlinear analysis is simplest. Burgers' equation is central to the study of nonlinear convection-diffusion equations. In [Section 12.2](#) we consider the KdV equation, a third-order equation famous for having solitary wave solutions, which are traveling waves that we calculate explicitly. [Section 12.3](#) is devoted to Fisher's equation, a model for population growth and dispersal, and in [Section 12.4](#) we consider special traveling waves for the bistable equation, which has connections to binary mixtures in material science and complex fluids.

12.1. Burgers' Equation

Burgers' equation

$$u_t + uu_x = \epsilon u_{xx}, \quad (12.1)$$

where $\epsilon > 0$ is a constant, is a prototypical equation that includes a nonlinear transport term, and small dissipation. Later we solve the initial value problem for Burgers' equation using a special change of variable known as the Cole-Hopf transformation, but here we consider only traveling wave solutions $u(x, t) = \tilde{u}((x - st)/\epsilon)$ with speed s (to be determined) that connect constants u_+ and u_- . Dropping the tilde, the function $u(\xi)$, $\xi = (x - st)/\epsilon$ should satisfy boundary conditions at infinity:

$$u(\pm\infty) = u_{\pm}, \quad u'(\pm\infty) = 0. \quad (12.2)$$

Substituting $u = u(\xi)$, $\xi = (x - st)/\epsilon$, into (12.1), we inevitably reduce the PDE to a second-order ODE, but also the parameter ϵ cancels, which is why we scaled x and t by ϵ . Integrating the ODE from $\xi = -\infty$ (note that $uu_x = \frac{1}{2}(u^2)_x$), we obtain the first-order autonomous ODE

$$u' = \frac{1}{2}(u^2 - u_-^2) - s(u - u_-). \quad (12.3)$$

From (12.2), (12.3), we see that u_{\pm} are equilibria of (12.3). Thus, $\frac{1}{2}(u_+^2 - u_-^2) - s(u_+ - u_-) = 0$, from which we deduce that either $u_+ = u_-$ or the parameters s , u_{\pm} are related by

$$s = \frac{1}{2}(u_+ + u_-). \quad (12.4)$$

Of course, $u \equiv u_-$ solves (12.3) for all s but satisfies the boundary conditions only if $u_+ = u_-$. This would be a very uninteresting traveling wave! However, the constant solution $u \equiv u_-$ is the only solution satisfying the ODE and boundary conditions if $u_- = u_+$. (See [problem 1](#).) For the KdV equation of the next section, the corresponding statement would be incorrect.

[Equation \(12.3\)](#) and its solutions can be represented on the u -axis (a one-dimensional phase portrait) or using direction fields in the (ξ, u) plane. As $\epsilon \rightarrow 0^+$, the traveling wave solutions converge to a discontinuous function that is in fact a shock wave solution of the inviscid Burgers equation. Moreover, as is immediately evident from the one-dimensional phase portrait, solutions exist if and only if

$$u_+ < s = \frac{1}{2}(u_+ + u_-) < u_-,$$

which relates the wave speed s to the characteristic speed u_+ and u_- ahead of and behind the shock wave, respectively. We leave the derivation of this condition as a part of [Problem 1](#).

12.2. The Korteweg-deVries Equation

The KdV equation

$$u_t + uu_x + \gamma u_{xxx} = 0 \quad (12.5)$$

is famous because of the existence of solitary waves, which are special traveling wave solutions with a remarkable property. As a faster wave catches up to a slower one, the waves merge, and then the faster wave emerges ahead of the slower wave, unchanged except that it is shifted forward in space from where it might have been if the interaction had been through linear superposition. The

slower wave is shifted backward. This property is remarkable because the equation is nonlinear, so you might expect an even more complicated interaction between colliding waves.

The KdV equation also has the special property of possessing an infinite number of invariants. These are spatial integrals that depend on the solution and are constant in time. The first two invariants for the KdV equation are associated with momentum and kinetic energy, in which u is interpreted as a velocity:

$$\int_{-\infty}^{\infty} u \, dx, \quad \int_{-\infty}^{\infty} u^2 \, dx. \quad (12.6)$$

We leave it to [problem 2](#) to verify that these quantities are invariants in the sense that they are constant in time if $u(x, t)$ is a solution that decays sufficiently rapidly as $x \rightarrow \pm \infty$. This property of the KdV equation is related to the inverse scattering transform in which the solution $u(x, t)$ serves to scatter waves through a linear equation with coefficients depending on $u(x, t)$. An accessible introduction to this topic can be found in the classic text by Whitham [46].

In this section we find the solitary waves and other periodic traveling waves, but first let's briefly discuss the dispersive nature of the equation. If we linearize (12.5) about a constant, say, $u = 1$, we get the linearized KdV equation

$$v_t + v_x + \gamma v_{xxx} = 0. \quad (12.7)$$

This is achieved by setting $u(x, t) = 1 + \epsilon v(x, t)$ and retaining only terms that are linear in ϵ . Solutions of (12.7) can be found by separation of variables. We seek solutions with a single spatial Fourier mode $e^{i\zeta x}$ and time-dependent coefficient $\varphi(t)$: $v(x, t) = \varphi(t)e^{i\zeta x}$. The parameter ζ is the wave number and is related to the period L by $\zeta = 2\pi/L$, since $e^{i\theta}$ is 2π periodic in θ . Substituting into (12.7), we get the ODE $\varphi' + i\zeta\varphi - \gamma i\zeta^3\varphi = 0$. Consequently, $\varphi(t) = e^{-i(\zeta - \gamma\zeta^3)t}$. Thus, we can write $v(x, t)$ in the form

$$v(x, t) = e^{\lambda t} e^{i\zeta x},$$

where $\lambda = \lambda(\zeta)$ measures the time-dependent response at the wave number ζ ; $\lambda(\zeta)$ is given by the *dispersion relation*

$$\lambda = -i(\zeta - \gamma\zeta^3).$$

The first term ($-i\zeta$) corresponds to a traveling wave solution of the linear transport equation (with speed $c = 1$) of [Chapter 1](#), in which $\gamma = 0$. The second term is *dispersive* in the sense that the solution $v(x, t) = e^{i\zeta(x - (1 - \gamma\zeta^2)t)}$ is a traveling wave, but it has speed $1 - \gamma\zeta^2$ that depends on the wave number. Thus, waves with different spatial frequency travel with different speeds.

To characterize *solitary waves*, we consider traveling wave solutions of (12.5) of the form $u(x, t) = v(x - st)$, where s is the wave speed, and we suppose that $v(\xi)$, $\xi = x - st$ approaches zero at $\xi = \pm \infty$:

$$v(\pm\infty) = 0.$$

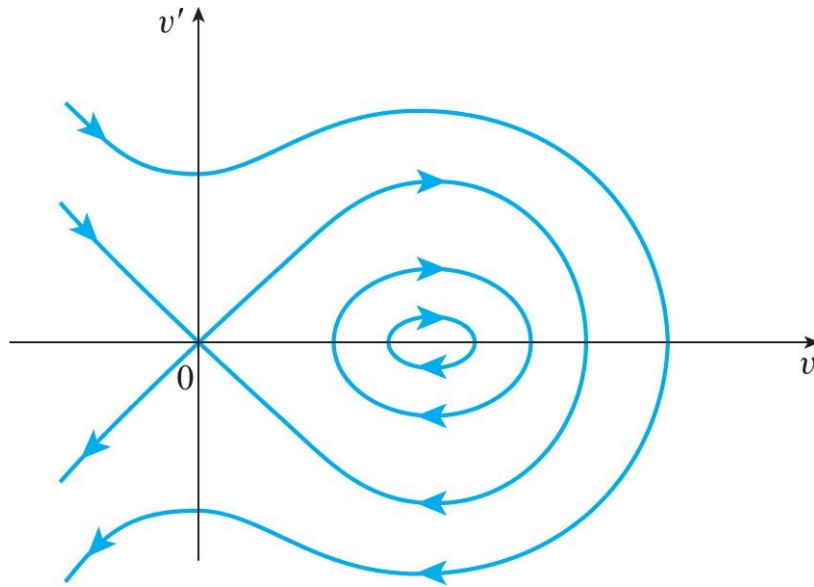

Figure 12.1. The phase plane for (12.8).

Substituting into the PDE and integrating once (assuming that derivatives of v also approach zero as $z \rightarrow \pm \infty$), we obtain the second-order ODE

$$-sv + \frac{1}{2}v^2 + \gamma v'' = 0. \quad (12.8)$$

If we multiply this equation by v' and integrate, we find that the quantity

$$\frac{1}{2}v'^2 + \frac{1}{6\gamma}v^3 - \frac{s}{2\gamma}v^2$$

is constant on solutions $v(\xi)$. Moreover, if we define this quantity to be the *Hamiltonian*:

$$H(v', v) = \frac{1}{2}v'^2 + \frac{1}{6\gamma}v^3 - \frac{s}{2\gamma}v^2, \quad (12.9)$$

then, writing $H = H(p, q)$, $p = v'$, $q = v$, we have $p' = -H_q$, $q' = H_p$, which is the Hamiltonian structure of (12.8). As observed above, the Hamiltonian is conserved along trajectories:

$$\frac{d}{d\xi} H(v'(\xi), v(\xi)) = 0.$$

The reader should verify these statements using (12.8) and (12.9). It follows that trajectories in the phase plane are level curves of $H(v', v)$, shown in Figure 12.1 for $s > 0$. In this figure, the closed curves in the right half-plane correspond to

periodic solutions, called *cnoidal waves*. These are periodic traveling waves that are important in the study of dispersive equations like the KdV equation. They are named after the cnoidal function, a special elliptic function that gives the shape of the solutions as functions of $\xi = x - st$.

The trajectory in [Figure 12.1](#) joining the origin to itself and enclosing the periodic trajectories is called a *homoclinic orbit*. The corresponding traveling wave is the *solitary wave*. We can derive the formula for this solution by integrating the equation, but since the solution is known, let's simply write it down:

$$v(x - st) = a \operatorname{sech}^2 \left(\sqrt{\frac{a}{12\gamma}} (x - st) \right), \quad s = \frac{a}{3}.$$

Because the speed s is proportional to the amplitude a , solitary waves with larger amplitude move faster. Thus, if a large solitary wave is behind a smaller one, the large one will catch up. This leads to the nonlinear interaction of two solitary waves mentioned earlier in this section. Solitary waves and the connection to integral invariants and inverse scattering are discussed in papers by Gardner et al. [17] and by Miura [36].

12.3. Fisher's Equation

Fisher's equation [14] is a version of the logistic equation that includes diffusion (see [Section 1.3](#)). While population growth can be modeled by the logistic equation (either the ODE or a difference equation), populations in many contexts tend to spread out or even invade nearby territory. This spatial dependence of population is modeled simply in Fisher's equation by diffusion. In this context, diffusion arises because of the tendency of a population $u = u(x, y, t)$, to migrate. According to Fick's law, the population flux is proportional to $-\nabla u$. (Note that Fick's law is similar to Fourier's law of heat flow.) Combining diffusion with the logistic population model, we obtain the PDE

$$u_t = d\Delta u + \alpha u(u_{\max} - u), \quad (12.10)$$

in which the constants d , α , u_{\max} are all positive. Here, the Laplacian $\Delta = \partial_x^2 + \partial_y^2$, and the population $u = u(x, y, t)$ is nonnegative.

We seek traveling wave solutions $u = u(x - st)$. These are *plane waves* in the sense that u depends spatially only on x and is independent of the transverse variable y . Thus, level curves of u at each time t are lines parallel to the y -axis, propagating (in the direction of the x -axis) with speed s . Since u is typically a population or concentration, we want $u \geq 0$, but we pursue the analysis initially without this restriction.

Let $d = \alpha = u_{\max} = 1$ in Fisher's equation. (This covers the general case as shown in [problem 3](#) as an exercise in rescaling the variables.) Then taking $u = u(x, t)$ to be independent of y , we have the semilinear parabolic equation in one space variable x and time t :

$$u_t = u_{xx} + u(1 - u). \quad (12.11)$$

For traveling wave solutions, we substitute $u = u(x - st)$, resulting in the ODE

$$-su' = u'' + u(1 - u). \quad (12.12)$$

This time, we cannot integrate the equation to reduce the order. However, just as for traveling wave solutions of the KdV equation, this second-order ODE can be studied as a first-order system

$$\begin{aligned} u' &= v, \\ v' &= -sv - u(1 - u). \end{aligned}$$

If we set $s = 0$, the traveling wave does not travel at all, and $\xi = x$. These stationary solutions are oscillations in a potential well $F(u) = \frac{1}{2}u^2 - \frac{1}{3}u^3$ (the integral of $u(1 - u)$) with a minimum at $u = 0$. The corresponding spatially periodic solutions of (12.11) are cnoidal waves, just as for the KdV equation. Notice how similar the Hamiltonian $H(u', u) = \frac{1}{2}u'^2 + F(u)$ is to the Hamiltonian for the KdV traveling waves. The phase portrait for $s = 0$ is likewise a mirror image of [Figure 12.1](#). The saddle point is at $(u, u') = (1, 0)$, and the limit of the periodic solutions around the center at the origin is a wave that approaches $u = 1$ as $x \rightarrow \pm \infty$, with a single negative minimum. Of course, none of these solutions is physical if u represents a population, since they all have $u < 0$ in an interval.

To find traveling waves with $u > 0$, we are led to investigate nonzero values of s . Equilibria (for which $u' = v' = 0$) are $(u, v) = (0, 0)$ and $(u, v) = (1, 0)$, and are thus independent of s . Their nature is determined from the linearization, in which we take the Jacobian of the vector field $G(u, v) = (v, -sv - u(1 - u))$ and calculate eigenvalues. For $s > 0$, this calculation shows that $(u, v) = (1, 0)$ is a saddle point (i.e., having real eigenvalues of opposite sign). The origin $(u, v) = (0, 0)$ is a stable spiral for $0 < s < 2$ (complex conjugate eigenvalues $\lambda_{\pm} = \frac{1}{2}(-s \pm \sqrt{s^2 - 4})$ with negative real part), and a stable node for $s > 2$ (both eigenvalues negative).

The speed s , when positive, acts as a damping parameter. From (12.12) we see that $d/d\xi H(u', u) \leq 0$, so that the energy H decreases along trajectories. By analogy with damped simple harmonic motion, for small $s > 0$, we expect oscillations to be underdamped. Correspondingly, traveling waves oscillate around $u = 0$ and are therefore unphysical, but they decay to $u = 0$. Values of s

> 0 sufficiently large give overdamping. In fact, for $s \geq 2$ the eigenvalues of the equilibrium at $u = u' = 0$ are real and negative. Traveling wave solutions that are monotonic from $u = 0$ to $u = 1$ exist for all $s \geq 2$. These are the physically relevant traveling wave solutions of Fisher's equation. For $s > 2$, this was proved by Aronson and Weinberger [5]. The proof is quite technical in order to show that the solution curve leaving the saddle point at $(1, 0)$ does not cross the vertical axis $u = 0$ when $s > 2$. Stability of the traveling wave as a solution of the PDE (12.11) was analyzed by Fife and McLeod [13].

12.4. The Bistable Equation

The bistable equation

$$u_t = u_{xx} + f(u), \quad (12.13)$$

in which f has the graph shown in Figure 12.2, is a simple model for transitions between two stable states. This kind of model has become common in studies of phase transitions in solids, with applications in materials science.

The space-independent equation $u'(t) = f(u)$ has stable equilibria at $u = 0$ and $u = 1$; the equilibrium $u = a$ is unstable. Traveling waves between $u = 0$ and $u = 1$ are somewhat easier to analyze than for Fisher's equation, since the equilibria correspond to saddle points and the issue of keeping the solution positive does not arise. However, the traveling waves occur only at isolated speeds s . Traveling wave solutions $u(x, t) = v(x - st)$ of (12.13) satisfy the second-order equation

$$-sv' = v'' + f(v). \quad (12.14)$$

As in the previous sections, we analyze this second-order equation by writing it as a first-order system:

$$\begin{aligned} v' &= w \\ w' &= -sw - f(v). \end{aligned} \quad (12.15)$$

The three zeroes $0 < a < 1$ of f are equilibria of the ODE; the outside equilibria at $u = 0, u = 1$ are saddle points, and the middle equilibrium at $u = a$ is a node for $s \neq 0$, as is seen from the eigenvalues of the linearization, calculated below. For $s = 0$, the middle zero is a center, as shown in Figure 12.3a.

Let $G(v, w) = (w, -sw - f(v))$. The vector field G has Jacobian (see Appendix C for the definition)

$$dG(v, w) = \begin{bmatrix} 0 & 1 \\ -f'(v) & -s \end{bmatrix}.$$

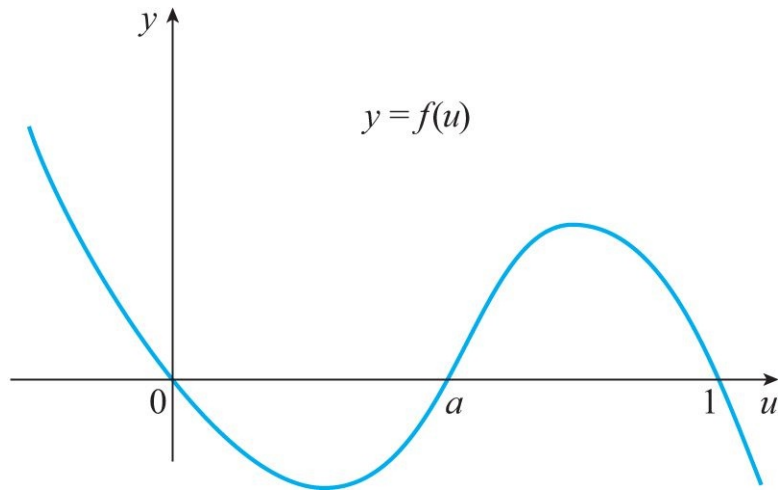

Figure 12.2. The bistable function (12.13).

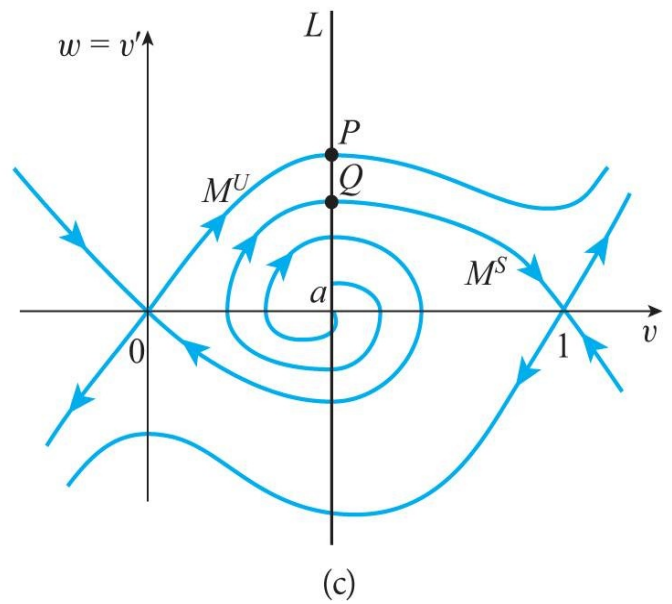
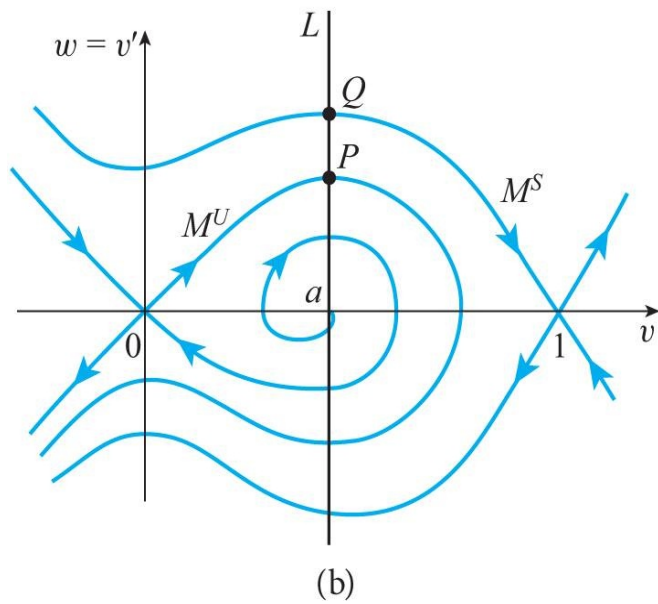
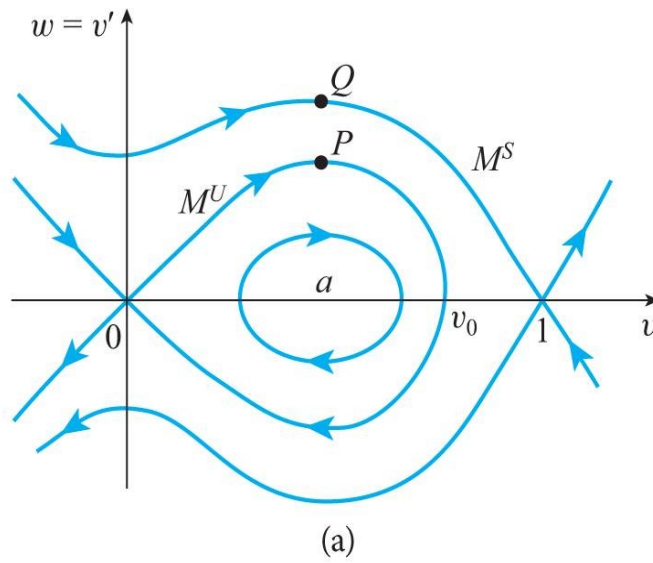

Figure 12.3. The phase plane for traveling wave solutions of the bistable equation, assuming (12.16). (a) $s = 0$; (b) $s < 0$ near 0; (c) smaller $s < 0$.

At the outside equilibria, $f'(v) < 0$, and the eigenvalues of dG are real, given by

$$\lambda_{\pm}(s) = \frac{1}{2} \left\{ -s \pm \sqrt{s^2 - 4f'(v)} \right\}.$$

The corresponding eigenvectors are

$$\mathbf{r}_{\pm} = \begin{pmatrix} v \\ w \end{pmatrix} = \begin{pmatrix} 1 \\ \lambda_{\pm} \end{pmatrix}.$$

The *unstable manifold* M^u is the solution curve leaving the saddle point, and the *stable manifold* M^s is the solution curve entering the saddle point. The portions of these curves that we consider are labeled in [Figure 12.3](#). Note that in [Figure 12.3a](#), just as for the KdV equation traveling waves, the saddle point at the origin has coincident stable and unstable manifolds, giving the homoclinic orbit shown. In [Figures 12.3b,c](#) there are orbits from the middle equilibrium at $v = a$ to the origin and to the equilibrium at $v = 1$. These orbits correspond to traveling waves approximating Lax shocks, for which the Lax entropy condition is satisfied; see [Chapter 13, Section 13.1.4](#).

The tangents to the invariant manifolds at the equilibria are the eigenvectors \mathbf{r}_{\pm} of the linearization of (12.15). (See [Appendix C](#).) The solutions represented by the invariant manifolds are asymptotic to $e^{\lambda_{\pm}\xi} \mathbf{r}_{\pm} a_s$ as $\xi \rightarrow \mp\infty$, so that the eigenvectors are tangent to the invariant manifolds at the equilibria. Therefore, each invariant manifold has the same slope as its associated eigenvector, specifically, λ_{\pm} .

Our objective is to find a value of the speed s for which a trajectory joins the two saddle points. Such a trajectory will correspond to a traveling wave from $u = 0$ to $u = 1$ and is called a *heteroclinic orbit* (as opposed to the homoclinic orbits we found for solitary wave solutions of the KdV equation). Since we are joining saddle points in the phase portrait, we can expect heteroclinic orbits to occur only for isolated values of s . We prove an existence result for heteroclinic orbits, showing that there is a value of s for which there is a heteroclinic orbit. When $f(u)$ is given by a cubic function $f(u) = u(1 - u)(u - a)$, the value of s and the heteroclinic orbit can be calculated explicitly.

Multiplying (12.14) by v' , we obtain the identity

$$\frac{d}{d\xi} E(v, v') = -s(v')^2,$$

where $E(v, v') = \frac{1}{2}v'^2 + F(v)$, and $F(v) = \int_0^v f(y) dy$. Thus, $E(v, v')$ increases along trajectories if $s < 0$, decreases if $s > 0$, and is constant for stationary waves ($s = 0$). The phase portrait for $s = 0$ is the starting point for our analysis; trajectories are level curves of $E(v, v')$, shown in [Figure 12.3](#). In this figure we assume

$$\int_0^1 f(y) dy < 0, \quad (12.16)$$

to ensure that the curve $E(v, v') = 0$ crosses the v -axis at a point $(v_0, 0)$ with $a < v_0 < 1$, as shown in the figure. Consequently, there is a homoclinic orbit connecting the origin to itself, as shown in [Figure 12.3a](#).

The heteroclinic orbits we seek join the saddle point at the origin to the saddle point at $(1, 0)$. We prove the existence of such an orbit for some $s < 0$ using a shooting argument on the stable and unstable manifolds shown in [Figure 12.3](#).

Theorem 12.1. *Suppose f satisfies (12.16). Then there is a speed $s < 0$ for which the bistable equation (12.13) has a traveling wave solution $u = u(x - st)$ satisfying $u(-\infty) = 0$, $u(\infty) = 1$.*

Proof. As we vary $s \leq 0$ in the ODE system (12.15), the stable and unstable manifolds move, and we wish to show that for some $s < 0$, the unstable manifold from the origin coincides with the stable manifold entering $(1, 0)$. To do so, we employ a kind of shooting argument, in which the stable and unstable manifolds shoot inward toward the line $L : v = a$, and we measure the height w of the intersections. As shown in [Figure 12.3bc](#), let point $P : (v, w) = (a, p(s))$ denote the intersection of M^u with L , and let point $Q : (v, w) = (a, q(s))$ denote the intersection of M^s with L . It is straightforward to argue that the intersections with L are defined for all $s < 0$, for example, by considering the curve $w = -f(v)/s$, on which $w' = 0$ (see (12.15)), so that the trajectories have a maximum or minimum where they intersect this curve.

For $s = 0$ (see [Fig. 12.3a](#)), P is below $Q : p(0) < q(0)$, due to (12.16). Therefore, by continuity, for $s < 0$ near $s = 0$, P is still below $Q : p(s) < q(s)$ (see [Fig. 12.3b](#)), and we seek a smaller value of $s < 0$ for which P lies above Q :

$$p(s) > q(s), \quad (12.17)$$

as shown in [Figure 12.3c](#). Then by continuity, an intermediate value of $s < 0$ exists for which the two points coincide, and there is a heteroclinic orbit along the coinciding manifolds. This will complete the proof.

We show (12.17) for small enough $s < 0$ in three steps: (1) We establish that $q(s) < q(0)$ for all $s < 0$. (2) We choose $\beta > 0$ so that $\beta a > q(0)$. (3) Finally we show that for this value of β , we can choose $s < 0$ small enough so that $p(s) > \beta a$. These inequalities together prove (12.17) for some small enough $s < 0$.

Let's show that M^s for $s < 0$ lies below the curve M^s for $s = 0$. This will imply

$$q(s) < q(0), \quad s < 0. \quad (12.18)$$

To prove (12.18), we consider the portion of the curve M^s with its graph denoted $w = w_s(v)$, $a \leq v \leq 1$, for each $s \leq 0$. Then $q(s) = w_s(a)$, and from the earlier discussion,

$$\frac{dw_s}{dv}(1) = \lambda_-(s) = \frac{1}{2} \left\{ -s - \sqrt{s^2 - 4f'(1)} \right\}.$$

Consequently, since $\lambda'_-(s) < 0$, the slopes of the tangent to M^s at the equilibrium satisfy

$$\frac{dw_0}{dv}(1) < \frac{dw_s}{dv}(1) < 0, \quad s < 0.$$

Thus, $w_s(v) < w_0(v)$, for $v < 1$ near $v = 1$. Next we show that this inequality holds all the way to the vertical line $L : v = a$.

From the chain rule and (12.15), we have

$$w_s \frac{dw_s}{dv} = -s w_s - f(v). \quad (12.19)$$

Suppose as v decreases from $v = 1$, there is a first value of $v = v^* < 1$ at which the stable manifold M^s with $s < 0$ crosses the stable manifold M^s with $s = 0$. Then

$$w_s(v^*) = w_0(v^*), \quad \frac{dw_s}{dv}(v^*) \leq \frac{dw_0}{dv}(v^*),$$

the latter inequality following from $w_s(v) < w_0(v)$, $v^* < v < 1$.

Subtracting (12.19) with $s = 0$ from (12.19) with $s < 0$, we then have at $v = v^*$,

$$w_s \left(\frac{dw_s}{dv} - \frac{dw_0}{dv} \right) = -s w_s.$$

However, the two sides of this equality have opposite signs, providing a contradiction. Thus, M^s with $s < 0$ lies below M^s with $s = 0$, at least down to $v = a$.

Now we consider the unstable manifold M^U emanating from the origin. We use the notation $\bar{w}_s(v)$, $0 \leq v \leq a$ for the values of w along M^U . Then $p(s) = \bar{w}_s(a)$. Let $\beta > 0$ be chosen so that

$$\beta a > q(0).$$

Then, from (12.18), we have

$$\beta a > q(s)$$

for all $s < 0$.

The vector field defined by (12.15) has slope w'/v' at each point in v - w plane. Specifically, at each point on the line $w = \beta v$, the slope of the vector field is

$$\frac{w'}{v'} = -s - \frac{f(v)}{\beta v}.$$

Thus, since $f(v)/v$ is bounded for $0 \leq v \leq a$, we can choose $s < 0$ small enough that this slope is greater than β . Then the trajectories cross the line $w = \beta v$ from below to above. In particular, the unstable manifold M^U must lie above this line, at least until it crosses the vertical line L , where $v = a$, $w = p(s)$. Consequently, $p(s) > \beta a > q(s)$. This verifies (12.17) for sufficiently negative s and establishes the existence of a heteroclinic orbit, as claimed. A similar argument can be used to show there is a trajectory for some $s > 0$ that joins $u = 1$ to $u = 0$. ■

Example 1. (Traveling waves) Consider traveling waves for (12.13) with a cubic function $f(u) = u(1 - u)(u - a)$, with $0 < a < 1$. For this special case we can seek $s \in \mathbb{R}$ for which there is an invariant parabola $w = kv(1 - v)$ for the ODE system (12.15) that passes through the two saddle points at $v = 0, 1$. Then the traveling wave solution will have speed s and corresponds to a trajectory lying on the parabola.

To obtain the invariant parabola, let $w = kv(1 - v)$. Then from (12.15),

$$w \frac{dw}{dv} = -sw - f(v)$$

implies

$$k^2 v(1 - v)(1 - 2v) = -skv(1 - v) + v(1 - v)(a - v).$$

Therefore,

$$k^2(1 - 2v) = -sk + a - v.$$

Thus, $-2k^2 = -1$, which leads to $k = \frac{1}{\sqrt{2}}$, since we want the parabola to lie in the upper half-plane when $0 < v < 1$. Equating the constant terms leads to

$$s = \frac{\sqrt{2}}{2}(2a - 1).$$

Consequently, $s < 0$ for $a < \frac{1}{2}$, and $s > 0$ for $a > \frac{1}{2}$. The traveling wave is stationary when $a = \frac{1}{2}$ and $s = 0$. In this case, the ODE system is Hamiltonian (see (12.14) with $s = 0$, which kills the damping term), with heteroclinic orbits from $(0, 0)$ to $(1, 0)$ in the upper half-plane and from $(1, 0)$ to $(0, 0)$ in the lower half-plane, corresponding to the parabola $k = -\frac{1}{\sqrt{2}}$.

In this chapter we have seen how to use phase plane techniques of systems of ODE to study smooth traveling wave solutions of several important PDE. In the next chapter we study shock wave solutions of scalar conservation laws. Shock waves are discontinuous traveling waves, requiring new tools for their analysis.

PROBLEMS

1. (a) Sketch the one-dimensional phase portrait for (12.2)–(12.4). This should be the u -axis, with equilibria u_{\pm} marked, and arrows indicating the sign of u' .

(b) Show that there is a nonconstant solution of (12.3) satisfying (12.2) if and only if $u_+ < u_-$.

(c) In fact, the solution in part (b) can be found explicitly, since the right-hand side of (12.3) is quadratic, so that separating variables u , ξ and using partial fractions yields the solution. Find the solution in the form

$$u(\xi) = a + b \tanh(c\xi)$$

by finding constants a , b , c as functions of u_{\pm} .

(d) Plot or sketch the solution as a graph $u = u(\xi)$ when $u_- = 2$ and $u_+ = -1$. What is the wave speed?

2. Prove that the two integrals of (12.6) are invariants of the KdV equation (12.5), and find η (depending on γ) so that the integral

$$\int_{-\infty}^{\infty} \frac{1}{2}(u_x^2 - \eta u^3) dx$$

is also an invariant.

3. Scale x , t , u in (12.10) so that the three constants d , u_{\max} , α can be set to unity.

4. Use a computer program to sketch phase portraits for the ODE for traveling wave solutions of Fisher's equation, for speeds $s = 0, 1, 3$. The phase portraits can also be drawn by hand with the aid of the *nullcline curves*, where $u' = 0$ (i.e., the u -axis, where the vector field is vertical, and hence trajectories crossing it are too), or $v' = 0$ (where the vector field is horizontal).

5. In the example of the bistable equation (12.13) with cubic $f(u)$, determine a formula for the traveling wave $u = v(x - st)$, using the invariant parabolic manifold $w = kv(v - 1)$ found in Example 1. (Note that $w = v'$.)

6. Consider the KdV-Burgers equation

$$u_t + \left(\frac{u^2}{2}\right)_x = \alpha u_{xx} + \beta u_{xxx},$$

where α, β are positive constants.

(a) Formulate an ODE for traveling wave solutions $u(x, t) = v(\eta)$, $\eta = x - st$, with boundary conditions

$$v(\pm\infty) = v_{\pm}, \quad v' = v'' = 0, \quad \eta = \pm\infty.$$

(b) Prove that there is such a solution if and only if

$$v_- > v_+ \quad \text{and} \quad s = \frac{1}{2}(v_+ + v_-).$$

(c) Find all values of the parameters α, β for which the traveling wave is monotonic (i.e., find a necessary and sufficient condition for $v(\eta)$ to be a decreasing function of η).

7. Let $f: \mathbb{R} \rightarrow \mathbb{R}$ be a given C^1 function. Show that traveling wave solutions $u = u(x - st)$ of the PDE

$$u_t + f(u)_x - u_{xx} = 0$$

are given implicitly by the equation

$$\int_a^{u(\xi)} \frac{dw}{b - sw + f(w)} = \xi,$$

where a, b are real constants.

Scalar Conservation Laws

The theory of scalar conservation laws was developed in the 1950s by many people, including Kruzkov [31], Lax [32], and Oleinik [37]. The starting point is the method of characteristics, treated in detail in [Chapter 3](#). Recall that for a scalar equation

$$u_t + f(u)_x = 0,$$

the characteristic speed is $f'(u)$, and characteristics are curves in the x - t plane defined by the ODE

$$\frac{dx}{dt} = f'(u(x, t)),$$

if u is a solution of the PDE. However, as we saw in [Chapter 3](#), smooth solutions of nonlinear equations typically develop singularities after a finite time. This is the motivation for considering weak solutions.

We begin this chapter with a detailed analysis of the inviscid Burgers equation, which has a quadratic flux function—the simplest convex flux. We then sketch how the theory is generalized to scalar equations in one space dimension with general convex flux functions. Finally, we analyze examples of equations with nonconvex fluxes and equations with two space variables.

13.1. The Inviscid Burgers Equation

In this section we discuss the inviscid Burgers equation in some detail, motivating the theory of scalar conservation laws, including the definition of weak solutions of initial value problems and the analysis of shocks and rarefactions.

13.1.1. Scale Invariance and Rarefaction Waves

In the following initial value problem for the inviscid Burgers equation, the initial condition has a jump discontinuity separating two constant values:

$$\begin{aligned} u_t + \left(\frac{1}{2}u^2\right)_x &= 0, \\ u(x, 0) &= \begin{cases} u_L, & \text{if } x < 0, \\ u_R, & \text{if } x > 0. \end{cases} \end{aligned} \tag{13.1}$$

This kind of initial value problem, with a step function initial condition, is called a *Riemann problem*. Riemann problems play a central role in the theory of weak

solutions, partly because they have the property of *scale invariance* in the following sense. If we scale x and t by a constant $a > 0$ and define new variables

$$\bar{x} = ax, \quad \bar{t} = at, \quad a > 0,$$

then

$$\frac{\partial}{\partial x} = a \frac{\partial}{\partial \bar{x}}, \quad \frac{\partial}{\partial t} = a \frac{\partial}{\partial \bar{t}},$$

so the PDE is unchanged by the change of variables. The initial condition depends only on the sign of x , so it does not change either. Thus, problem (13.1) is said to be *scale invariant*.

An immediate consequence of scale invariance is the risk of multiple solutions of problem (13.1). Let $u(x, t)$ be a solution of (13.1). Then $v(x, t; a) = u(ax, at)$ is also a solution of (13.1) for any $a > 0$. Since we want uniqueness of solutions of (13.1) (part of the well-posedness condition for initial value problems), we need $v(x, t; a) = u(x, t)$. It follows (see Problem 1) that $u(x, t) = \bar{u}(x/t)$ for some function $\bar{u}: \mathbb{R} \rightarrow \mathbb{R}$. Then $u(x, t)$ is constant on rays $x = ct$ through the origin in the x - t plane. When \bar{u} is continuous, this type of solution is called a centered rarefaction wave. Later we also consider shock wave solutions of (13.1), which correspond to discontinuous functions \bar{u} .

13.1.2. Centered Rarefaction Waves

Continuous, piecewise smooth (nonconstant) scale-invariant solutions $u(x, t) = \bar{u}(x/t)$ of the PDE in (13.1) are *centered rarefaction waves*. Then

$$u_t + uu_x = -\bar{u}' \cdot \frac{x}{t^2} + \bar{u} \bar{u}' \cdot \frac{1}{t} = 0$$

implies $\bar{u}' \cdot (x/t - \bar{u}) = 0$. One possibility for this equation would be $\bar{u}' = 0$, but this leads only to the constant solution. The other alternative gives the solution we seek:

$$\bar{u} \left(\frac{x}{t} \right) = \frac{x}{t}.$$

Since the PDE is *translation invariant* (i.e., it does not change if x or t is translated by a constant), rarefaction waves can be translated so that they are centered on points (x_0, t_0) other than the origin:

$$u(x, t) = \frac{x - x_0}{t - t_0}, \quad t > t_0.$$

In Figure 13.1 we show the solution of the Riemann problem (13.1) with $u_L = -1$, $u_R = 1$, in which the solution is constant to the left and right of the

rarefaction wave. Continuity of the solution implies that the derivative u_x is discontinuous at the leading and trailing edges of the rarefaction, but this is consistent with the PDE, since these points travel with characteristic speed u . A general result concerning the propagation of discontinuities in derivatives of solutions is provided in the next chapter (see [Section 14.2.5](#)).

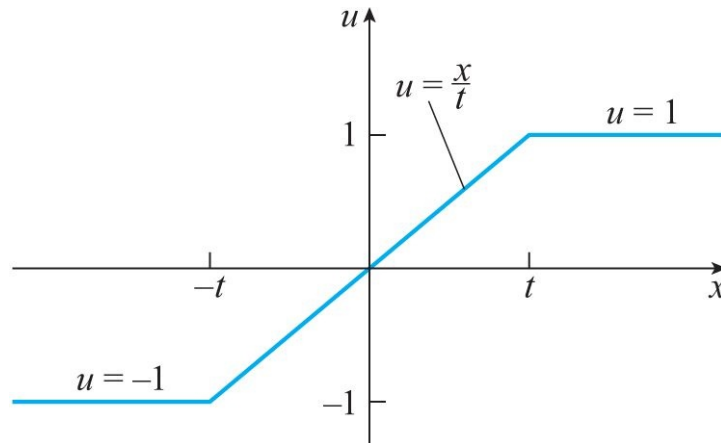

Figure 13.1. A rarefaction wave solution of the inviscid Burgers equation.

13.1.3. Shock Waves

In [Section 9.2.2, Example 7](#), we discussed discontinuous solutions of a scalar conservation law as an application of distributions, including a derivation of the Rankine-Hugoniot condition for constant-speed shock waves. Here we give a more general derivation of the Rankine-Hugoniot condition. However, if all shock waves were allowed in weak solutions, then some Riemann problems would have multiple weak solutions for the same constants u_L, u_R . To rectify this lack of well-posedness, we introduce the notion of the admissibility of shocks.

Consider a solution $u(x, t)$ of Burgers' [equation \(13.1\)](#) with a jump discontinuity on a curve $x = \gamma(t)$ with γ a C^1 function. We assume that u is C^1 and satisfies the PDE [\(13.1\)](#), except on $x = \gamma(t)$. Since u has a jump discontinuity, it has one-sided limits $u_{\pm}(t) = \lim_{x \rightarrow \gamma(t)_{\pm}} u(x, t) = u(\gamma(t)_{\pm}, t)$.

In [Chapter 9, Example 7](#), we showed how to treat a discontinuous function with a jump discontinuity as a distributional solution of a conservation law. We take this up again in the next chapter on systems of conservation laws. Here we give a more direct treatment going back to the balance law formulation to see what it takes for u to satisfy the integral form of the equation.

Consider points $x = a, x = b$ with $a < \gamma(t) < b$, for t in an interval, as shown in [Figure 13.2](#). The balance law expresses the PDE in the form

$$\frac{d}{dt} \int_a^b u(x, t) dx = \frac{u^2}{2}(a, t) - \frac{u^2}{2}(b, t).$$

This equation can be derived much as was done for the traffic flow [equation \(2.16\)](#) of [Chapter 2](#). To evaluate the left-hand side, we break up the integral:

$$\begin{aligned} \frac{d}{dt} \int_a^b u(x, t) dx &= \frac{d}{dt} \int_a^{\gamma(t)} u(x, t) dx + \frac{d}{dt} \int_{\gamma(t)}^b u(x, t) dx \\ &= \frac{u^2}{2}(a, t) - \frac{u^2}{2}(b, t). \end{aligned}$$

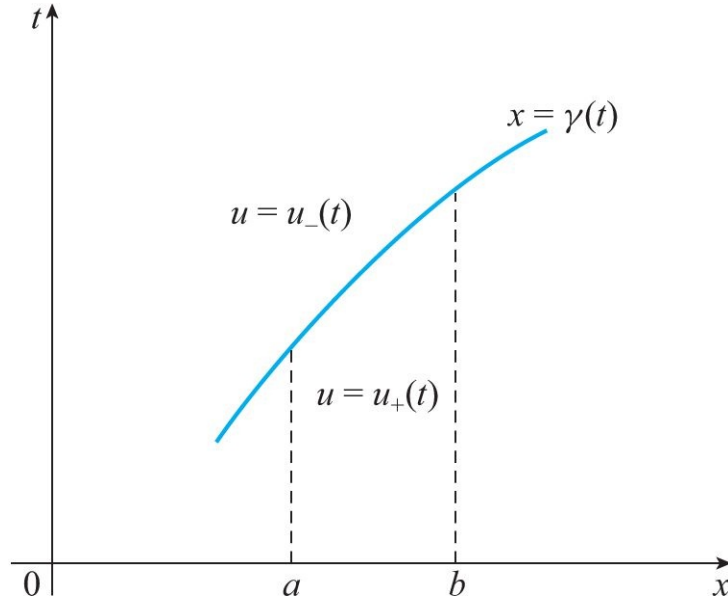

Figure 13.2. A shock wave $x = \gamma(t)$.

Now we can carry out the differentiation to get

$$\begin{aligned} u(\gamma(t)_-, t) \frac{d\gamma(t)}{dt} + \int_a^{\gamma(t)} \frac{\partial u}{\partial t}(x, t) dx - u(\gamma(t)_+, t) \frac{d\gamma}{dt} \\ + \int_{\gamma(t)}^b \frac{\partial u}{\partial t}(x, t) dx = \frac{u^2}{2}(a, t) - \frac{u^2}{2}(b, t). \end{aligned}$$

Next we use the PDE in the integrals:

$$\int u_t dx = - \int \left(\frac{u^2}{2} \right)_x dx = - \frac{u^2}{2}.$$

The calculation now reduces to

$$\frac{d\gamma(t)}{dt} (u_+(t) - u_-(t)) = \frac{u_+(t)^2}{2} - \frac{u_-(t)^2}{2}.$$

Since $x = \gamma(t)$ is a discontinuity for u , we have $u_+(t) \neq u_-(t)$, so

$$\frac{d\gamma(t)}{dt} = \frac{u_+(t) + u_-(t)}{2}, \tag{13.2}$$

which is the Rankine-Hugoniot jump condition. The left-hand side is the speed of

the discontinuity, or *shock wave*; the condition states that the shock speed $\gamma'(t)$ is the average of u across the shock (i.e., $\gamma'(t)$ is the average of the characteristic speeds on each side of the shock).

Since the class of possible solutions now includes piecewise smooth functions, we lose uniqueness of solutions for some initial value problems. This issue is familiar from simpler contexts. For example, if we consider only real solutions of $x^3 = 1$, then there is a unique solution $x = 1$. However, when we widen the admissible class of numbers to include complex numbers, then there are three solutions.

In the next example we show a one-parameter family of weak solutions for the same initial value problem. The example is suggestive of how uniqueness can be recovered.

Example 1. (Nonunique weak solutions) Consider the Riemann problem (13.1) with $u_L = -1$, $u_R = 1$:

$$\begin{aligned}
 u_t + \left(\frac{1}{2} u^2 \right)_x &= 0, \\
 u(x, 0) &= \begin{cases} -1, & \text{if } x < 0, \\ 1, & \text{if } x > 0. \end{cases}
 \end{aligned}
 \tag{13.3}$$

The rarefaction wave solution is shown in Figure 13.1. However, there is also a one-parameter family of weak solutions. In Figure 13.3 we represent one member of this family, with a particular value of the parameter $\alpha \in (0, 1]$. The formula for the solution is

$$u(x, t) = \begin{cases} -1, & x < -t, \\ x/t, & -t \leq x \leq -\alpha t, \\ -\alpha, & -\alpha t < x < 0, \\ \alpha, & 0 < x < \alpha t, \\ x/t, & \alpha t \leq x \leq t, \\ 1, & x > t. \end{cases}$$

In these solutions notice that for $\alpha > 0$, there is a stationary shock on the t -axis, and characteristics leave the shock on both sides. Since u is constant on characteristics, the solution adjacent to the shock is not determined from the initial data. We say that *causality fails to hold*. To avoid this lack of causality, we select the solution with $\alpha = 0$, for which the solution is continuous, consisting of the centered rarefaction wave whose graph appears in Figure 13.1, but no shock forms.

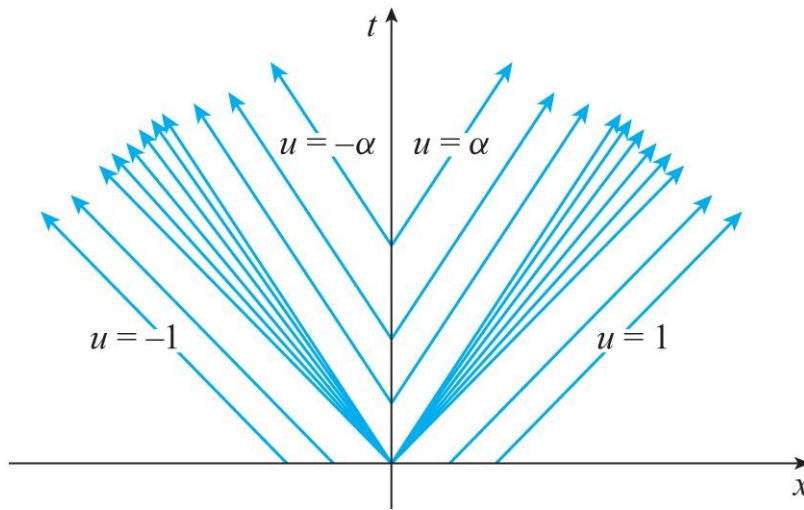

Figure 13.3. One-parameter family of solutions of problem (13.3).

13.1.4. The Lax Entropy Condition

Example 1 shows that to have unique solutions of initial value problems, we cannot allow all solutions with shocks that only satisfy the Rankine-Hugoniot condition (13.2). In many circumstances a unique solution is selected if we impose the additional condition that characteristics must impinge on a discontinuity from both sides. This is consistent with causality, as the characteristics carry information about the solution forward in time from initial and boundary conditions. The condition on characteristics is known as *the Lax entropy condition*. Formulated in this way, it applies to discontinuous solutions of any scalar conservation law $u_t + f(u)_x = 0$, and it also generalizes to discontinuities in higher dimensions.

We can write the Lax condition as a pair of inequalities. Consider a shock $x = \gamma(t)$, represented in **Figure 13.3**, with left and right limits $u_-(t)$ and $u_+(t)$, respectively. Then the Lax entropy condition states that

$$u_+(t) < \gamma'(t) < u_-(t).$$

In particular, the solution must *jump down* from u_- to u_+ .

By contrast, in **Example 1** the solutions u with $\alpha > 0$ *jump up* at the discontinuity. Thus, the only acceptable solution is the continuous one, for which $\alpha = 0$; the others have shocks that satisfy the Rankine-Hugoniot condition but not the Lax entropy condition.

Example 2. (Solution of the Riemann problem (13.1)) We can now solve the Riemann problem (13.1) for Burgers' equation for all choices of u_L, u_R . The solution consists of a single wave with the constants $u = u_L$ to the left of the wave and $u = u_R$ to the right. If $u_L < u_R$, the single wave is a centered rarefaction wave, whereas if $u_L > u_R$, then the single wave is a shock $x = st$, $s = \frac{1}{2}(u_L + u_R)$.

In the next example, we compute a shock wave as a free boundary, showing how information from the left and right determines the location of the shock. This property of locating the shock based on information from both sides is another reason for the Lax condition—information flows into the shock from the left and the right. Since the information (carried by characteristics) varies continuously with the initial data, the Lax condition ensures that solutions vary continuously with the data. In this sense, shocks satisfying the Lax entropy condition are said to be *stable*.

Example 3. (Piecewise-constant initial data) We can use rarefactions and shocks to solve initial value problems with piecewise-constant initial data by solving the Riemann problem and then solving interaction problems when individual waves collide. As an example, we consider the initial value problem

$$u_t + \left(\frac{u^2}{2}\right)_x = 0, \tag{13.4}$$

$$u(x, 0) = \begin{cases} 0, & x < 0, \\ 1, & 0 < x < 1, \\ 0, & x > 1. \end{cases}$$

The solution structure is shown in [Figure 13.4](#). To construct the solution step by step, first consider $t > 0$ small. There will be a rarefaction centered at $x = t = 0$ joining regions $x < 0$ where $u = 0$ and $x > t$ where $u = 1$. The constants $u = 1$ to the left of $u = 0$ are joined by a shock wave originating at $x = 1, t = 0$ and having constant speed $\frac{1}{2}$. The shock wave therefore lies on the curve $x = \frac{1}{2}t + 1$.

Now the leading edge of the rarefaction wave, specifically, the characteristic $x = t$, collides with the shock wave $x = \frac{1}{2}t + 1$ at $t = 2$, for which $x = 2$. The solution is continued with a curved shock $x = \gamma(t)$, since the limit from the left comes from the rarefaction wave and is not constant, whereas the limit from the right continues to be $u = 0$. The speed is related to the left and right limits by the Rankine-Hugoniot condition, which takes the form

$$\gamma'(t) = \frac{1}{2} \frac{\gamma(t)}{t}.$$

The shock wave is attached to the collision point, so we have the initial condition

$$\gamma(2) = 2.$$

The solution of the initial value problem for $\gamma(t)$ is $\gamma(t) = \sqrt{2t}$. This is the curved portion of the shock shown in [Figure 13.4](#). Notice that $\gamma(t)$ has speed $\gamma'(t) = 1/\sqrt{2t}$, which approaches zero as $t \rightarrow \infty$. Consequently, the shock strength

decreases, but the shock persists for all time.

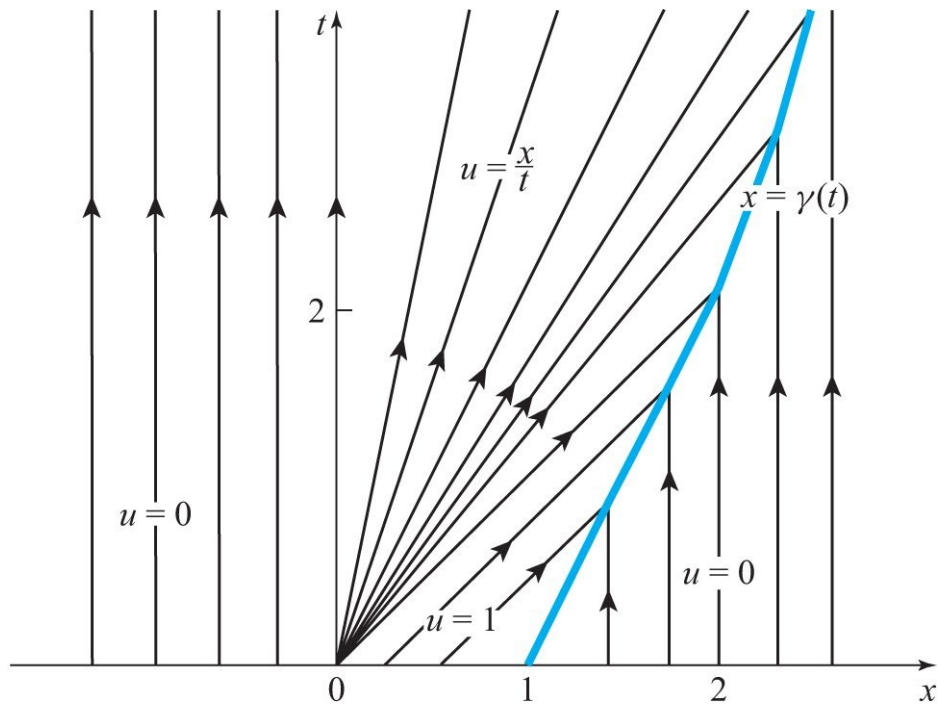

Figure 13.4. Solution of the Riemann problem (13.4).

13.2. Scalar Conservation Laws

Much of what we have analyzed for the inviscid Burgers equation applies to the general scalar equation in one space variable and time

$$u_t + f(u)_x = 0, \quad (13.5)$$

in which the flux $f : \mathbb{R} \rightarrow \mathbb{R}$ is C^2 . We consider the Cauchy problem, with initial data

$$u(x, 0) = u_0(x). \quad (13.6)$$

For some properties, it is convenient to write the equation as a nonlinear transport equation

$$u_t + c(u)u_x = 0,$$

where $c(u) = f'(u)$ is the characteristic speed. We show how the construction of rarefaction waves and shocks generalizes to (13.5).

First observe that u is constant on characteristics $\frac{dx}{dt} = c(u)$, since $\frac{d}{dt}u(x(t), t) = 0$, and that therefore characteristics $x = x(t)$ are straight lines. Consequently, the solution of the Cauchy problem is expressed implicitly by the equation

$$u = u_0(x - c(u)t). \quad (13.7)$$

Using the balance-law version of (13.5), the Rankine-Hugoniot jump condition for a discontinuous solution, such as that shown in Figure 13.2, is

$$s = \frac{f(u_+) - f(u_-)}{u_+ - u_-},$$

where $s = \frac{dy}{dt}$ is the shock speed. Notice that the shock speed is the slope of the chord in the graph of f joining the points $(u_+, f(u_+))$, as in [Figure 13.5](#). The figure provides a useful interpretation when considering the Lax entropy condition, because this slope is easily compared to the characteristic speeds $c(u_+) = f'(u_+)$, which are slopes of the tangents to the graph of f at these same points. The Lax entropy condition states that characteristics should enter the shock from each side. (See $\gamma(t)$ in [Fig. 13.4](#) for an example.) This means

$$f'(u_+) < s < f'(u_-). \tag{13.8}$$

Shocks that satisfy this condition are said to be *admissible*.

Centered rarefaction waves $u = \bar{u}(x/t)$ are constant on characteristics and thus are specified by the implicit equation

$$f'(\bar{u}) = \frac{x}{t}.$$

Since x/t is increasing from left to right in the $x-t$ plane, this formula makes sense only in intervals of \bar{u} in which $f'(\bar{u}(x/t))$ is increasing as a function of x/t . Therefore, $f''(\bar{u}) \neq 0$ in an interval, which is the range of \bar{u} .

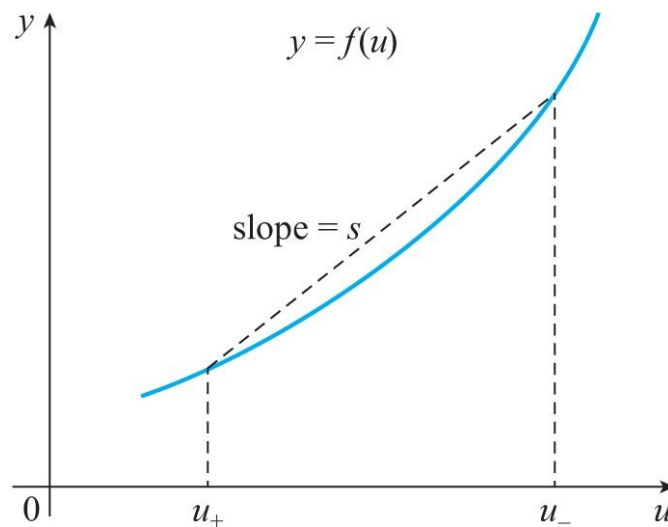

Figure 13.5. Shock speed s as the slope of a chord for a convex flux f .

13.2.1. Traffic Flow Model

The model for traffic flow introduced in [Chapter 2](#) has the form

$$\rho_t + (\rho v(\rho))_x = 0. \tag{13.9}$$

In this equation, $\rho(x, t) \geq 0$ represents the traffic density at a location x on a highway at time t , and the traffic flux is given by a function $f(\rho) = \rho v(\rho)$ in which $v = v(\rho)$ models how velocity v changes with traffic density ρ . The

simplest $v(\rho)$ is linear: $v(\rho) = v_m(1 - \rho/\rho_m)$, where v_m, ρ_m denote the maximum speed and maximum traffic density, respectively. Then (13.9) has a quadratic flux

$$\rho_t + (v_m\rho(1 - \rho/\rho_m))_x = 0,$$

and can be converted into the inviscid Burgers equation with a simple change of variables.

More generally, forms for $v(\rho)$ can be based on real traffic data, and the result need not be linear. However, $v'(\rho) \leq 0$ is a reasonable assumption, and $f(\rho) = \rho v(\rho)$ is typically a concave function: $f''(\rho) < 0$, implying that the characteristic speed is a decreasing function of density ρ .

Note that the characteristic speed $f'(\rho) = \rho v'(\rho) + v(\rho)$ is positive for ρ near zero, but it is negative near maximum density, where $v(\rho) = 0$. Thus, according to the model (13.9), information about the traffic may flow forward, in the direction of the traffic motion at low density, or backward at high density. We can illustrate both cases with a classic example, in which vehicles approach a traffic light.

Example 4. (Traffic light problem in the traffic flow model) A line of traffic with uniform density $\bar{\rho}$ approaches a traffic light located at $x = 0$. Suppose you are a traffic engineer, and your job is to design the traffic light sequence to make the light work efficiently.

Let's suppose the light needs to stay red for a time $t_1 > 0$, to release traffic on the other roads at the intersection. Then you need to find the length of time $T > 0$ for the green light. As we shall see, the traffic builds up behind the red light, and then gradually releases when the light turns green. The challenge is to find an expression for shortest time T at which the traffic density returns to $\rho = \bar{\rho}$. We find T as a function of the parameters in the model: $\bar{\rho}, \rho_m, v_m, t_1$.

First note that when the light turns red, the density immediately to the right of $x = 0$ is $\rho = 0$, and behind, $\rho = \bar{\rho}$. Subsequently, since cars are stopped at the red light, the density immediately to the left of $x = 0$ is maximal, $\rho = \rho_m$. Correspondingly, there is a stationary shock at the light, that is, one with speed zero. Note that this makes sense, since the light presumably does not move, and but also because it is consistent with the Rankine-Hugoniot condition.

Since there is nothing in the model that allows cars to slow as they approach the line of stationary cars, a shock forms between the moving cars (which have density $\rho = \bar{\rho}$) and the stationary cars (with density $\rho = \rho_m$). Consequently, the shock forms and propagates backward as more cars join the queue waiting at the light. The speed is given by the Rankine-Hugoniot condition

$$s = \frac{f(\rho_m) - f(\bar{\rho})}{\rho_m - \bar{\rho}} < 0,$$

since $f(\rho_m) = 0$.

Now suppose the light turns green at time t_1 . This releases cars at the head of the queue to start moving. Since there are no cars ahead of the lead car, the model dictates that it immediately travels with maximum speed v_m , corresponding to $\rho = 0$. In fact, at $t = t_1$, the solution near $x = 0$ constitutes a Riemann initial value problem, with $\rho = \rho_m$, $x < 0$, and $\rho = 0$, $x > 0$. This jump down gives rise to a centered rarefaction wave, as shown in [Figure 13.6](#). The rarefaction interacts with the backwards-propagating shock at some time $t_2 > t_1$, increasing its speed. Finally at time $t_3 > t_2$, the shock, labeled γ in the figure, crosses $x = 0$, after which the traffic density is back to $\bar{\rho}$ crossing the traffic light at $x = 0$. The interval $T = t_3 - t_1$ is the minimum time that should be set for the green light to release all the vehicles that were held up by the red light. Notice that, as in [Example 3](#), the shock persists for all time, but the strength decays as t gets larger.

13.2.2. Nonconvex Flux

The classic scalar conservation law with a nonconvex flux is the Buckley-Leverett equation, formulated in the 1940s as a simple model for the flow of oil and water in an oil reservoir. It is based on Darcy's law relating pressure gradients in the fluids to their velocities. After some simplification, the equation takes the form

$$u_t + f(u)_x = 0, \quad f(u) = \frac{\lambda_o(u)}{\lambda_o(u) + \lambda_w(1 - u)} v_T. \quad (13.10)$$

In this equation, $u = u(x, t)$ is the saturation of oil at a location x in the reservoir, meaning the fraction of volume of pore space occupied by oil. Then, assuming all the pore space is occupied by either water or oil, the saturation of water is $1 - u$. The functions λ_o , λ_w are relative permeabilities of oil and water, respectively, depending on their saturations; they are both typically taken to be positive, increasing, and convex functions. The positive constant v_T is the total velocity (i.e., the sum) of the two fluids. We leave it as an exercise (see [Problem 3](#)) to show that $f(u)$ in (13.10) is positive, increasing, but nonconvex with a single inflection point, when $\lambda_o(u) = k_o u^2$ and $\lambda_w(1 - u) = k_w(1 - u)^2$, for positive constants k_o , k_w .

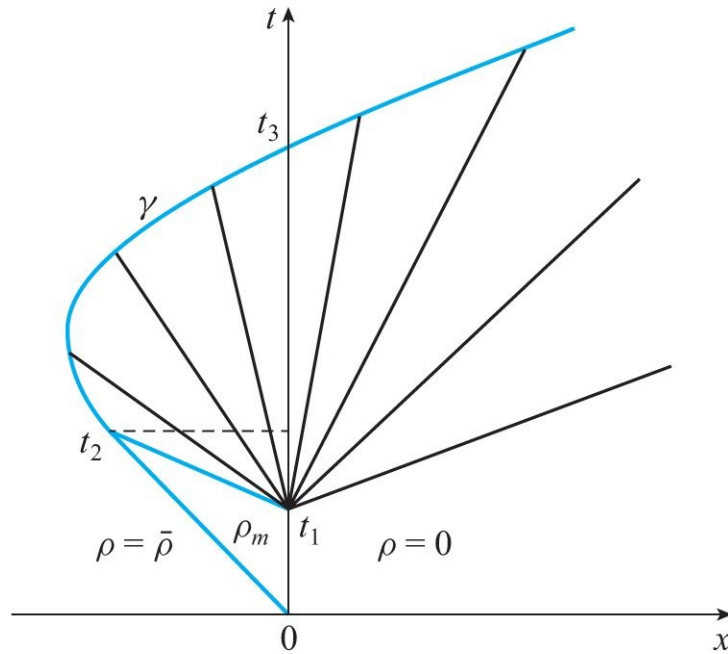

Figure 13.6. Solution of the traffic light problem.

Rarefaction wave solutions $u = \bar{u}(x/t)$ of (13.5) with a nonconvex flux $f(u)$ are a little tricky, because the characteristic speed $c(\bar{u}) = f'(\bar{u})$ has to increase with x/t . Moreover, because \bar{u} is obtained from the equation $x/t = f'(u)$, f' must be invertible. Consequently, $f'' \neq 0$ throughout the rarefaction wave.

To show the role of nonconvex flux functions, we choose the simpler nonconvex function $f(u) = u^3$, for which we can make explicit calculations. Thus, we consider shocks and rarefaction waves for the equation

$$u_t + (u^3)_x = 0.$$

In the specific case $f(u) = u^3$, the characteristic speed is $f'(u) = 3u^2$, so that rarefaction waves $u(x, t) = \bar{u}(x/t)$ centered at $x = t = 0$ are given by $\bar{u}(r) = \pm\sqrt{r/3}, r > 0$. Thus, rarefaction waves have positive speed and join constant values $u = u_{\pm}$, provided $u_+ < u_- \leq 0$ or $0 \leq u_- < u_+$ (where as usual u_- is to the left of the wave and u_+ is to the right).

For constant $u_- > 0$, the values of $u_+ < u_-$ for which the piecewise-constant function

$$u(x, t) = \begin{cases} u_-, & \text{if } x < st, \\ u_+, & \text{if } x > st \end{cases}$$

is an admissible shock for some speed s require the chord from u_- to u_+ to lie above the graph of f . The chord has slope $s = u_+^2 + u_+u_- + u_-^2$ and becomes tangent to f in two ways, corresponding to two different values of u_+ . When $u_+ = -u_-/2$, the chord is tangent at u_+ ; when $u_+ = -2u_-$, the chord is tangent at u_- . By comparing the slopes $3u_{\pm}^2$ of the tangents at u_{\pm} to the shock speed, we

observe that the Lax entropy condition (13.8) becomes $-u_-/2 < u_+ < u_-$ when $u_- > 0$.

Having described rarefaction waves and admissible shock waves, we can solve the Riemann problem

$$u_t + (u^3)_x = 0, \quad (13.11)$$

$$u(x, 0) = \begin{cases} u_L, & \text{if } x < 0, \\ u_R, & \text{if } x > 0. \end{cases}$$

Since the PDE is unchanged by changing the sign of u , we can take $u_L > 0$ and solve (13.11) for different values of u_R . From the discussion of shocks and rarefactions in Example 2, we see that the solution will be a single shock wave if $-u_L/2 < u_R < u_L$ and a rarefaction wave if $u_R > u_L$. However, for $u_R < -u_L/2$, a single wave cannot solve the problem, and we need a new construction, a *shock-rarefaction*. This solution includes a shock wave from u_L to $-u_L/2$, with speed $3u_L^2/4$, the characteristic speed at $u = -u_L/2$. But then we can join $-u_L/2$ to u_R by a rarefaction wave, since $u_R < -u_L/2$. The solution then is a shock connected to the rarefaction wave, hence the name *shock-rarefaction*. We illustrate the solutions in Figure 13.7.

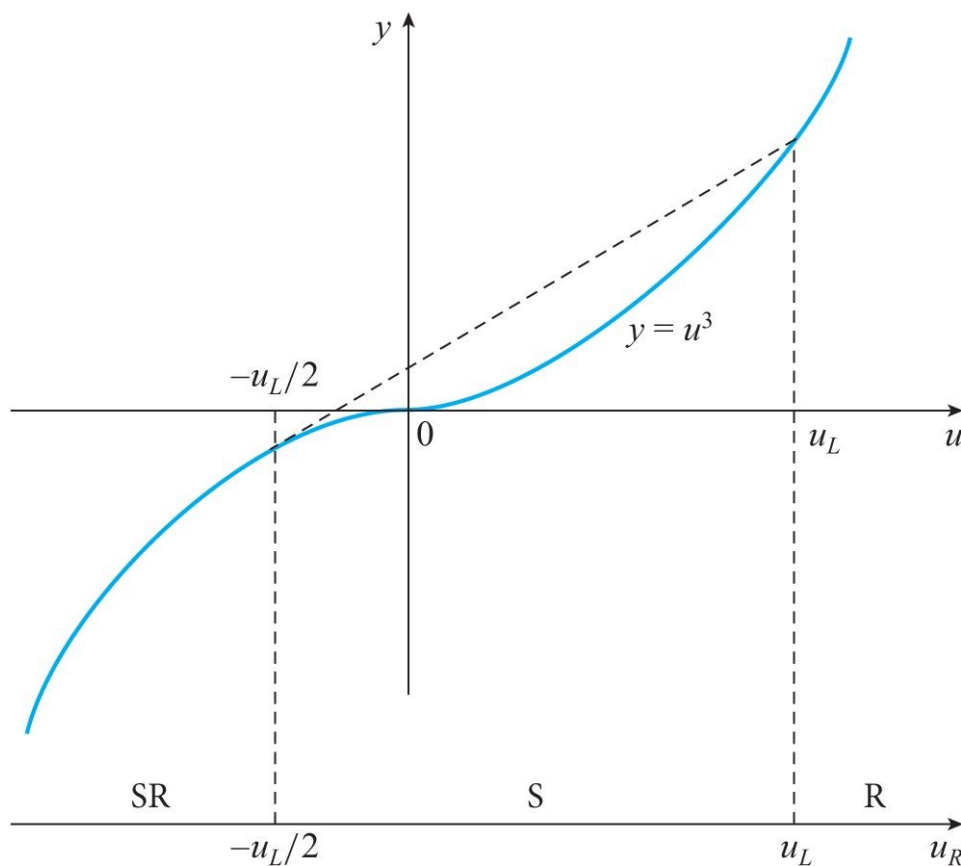

Figure 13.7. Solution of the Riemann problem (13.11). S: shock; R: rarefaction; SR: shock-rarefaction.

13.3. The Lax Entropy Condition Revisited

The Lax entropy condition can be motivated by considering changes in entropy across shock waves in gas dynamics. But we can also treat entropy as an abstract quantity, a significant notion in the modern theory of conservation laws, including the existence and properties of solutions of systems of equations. In this section we relate the Lax entropy condition to this mathematical notion of entropy.

Consider the conservation law

$$u_t + f(u)_x = 0, \quad (13.12)$$

in which $f: \mathbb{R} \rightarrow \mathbb{R}$ is a C^2 strictly convex function: $f''(u) > 0$ for all $u \in \mathbb{R}$. Let $\eta: \mathbb{R} \rightarrow \mathbb{R}$ be a C^2 strictly convex function: $\eta''(u) > 0$ for all $u \in \mathbb{R}$, called a *convex entropy function*. We define an *entropy flux* $q: \mathbb{R} \rightarrow \mathbb{R}$ by

$$q' = f'\eta'. \quad (13.13)$$

These pairs of functions are associated with an additional conservation law that is satisfied by smooth solutions. We verify that $\eta_t + q_x = 0$, using (13.12) and (13.13):

$$\eta(u)_t + q(u)_x = \eta'(u)u_t + q'(u)u_x = \eta'(u)(u_t + f'(u)u_x) = 0.$$

Note that (13.13) also makes sense when η is only piecewise smooth, that is, continuous and piecewise C^1 (for example, piecewise linear). In that case, we say η is a convex entropy function if it is a convex function in the weaker sense:

$$\eta(\theta x + (1 - \theta)y) \leq \theta\eta(x) + (1 - \theta)\eta(y)$$

for all $x < y$, $0 \leq \theta \leq 1$.

The objective of this section is to relate the Lax entropy condition (13.8) for shock waves to the inequality

$$\eta(u)_t + q(u)_x \leq 0. \quad (13.14)$$

To simplify the calculation of the inequality (13.14), we consider a piecewise-constant shock wave solution of (13.12):

$$u(x, t) = \begin{cases} u_-, & \text{if } x < st, \\ u_+, & \text{if } x > st. \end{cases} \quad (13.15)$$

Here the speed

$$s = \frac{f(u_+) - f(u_-)}{u_+ - u_-}$$

and the solution on each side of the shock are constant.

Recall that for a convex flux $f(u)$, the Lax entropy condition

$$f'(u_+) < s < f'(u_-) \quad (13.16)$$

is equivalent to requiring that the shock jump down:

$$u_- > u_+.$$

Inequality (13.14) is to be interpreted in the sense of distributions:

$$(\eta(u)_t + q(u)_x, \phi(x, t)) \leq 0 \quad (13.17)$$

for all test functions $\phi \in C^\infty(\mathbb{R} \times \mathbb{R})$ with compact support, satisfying $\phi(x, t) \geq 0$. For the shock wave (13.15), let $\eta_\pm = \eta(u_\pm)$, $q_\pm = q(u_\pm)$. We find

$$-s(\eta_+ - \eta_-) + q_+ - q_- \leq 0. \quad (13.18)$$

To verify this inequality from (13.17), write $\eta(u)$ and $q(u)$ in terms of the Heaviside function $H(x)$, and use the fact that the distributional derivative $H' = \delta$, the Dirac delta function, a nonnegative distribution. Then

$$\eta(u)_t + q(u)_x = (-s(\eta_+ - \eta_-) + q_+ - q_-)\delta(x - st) \leq 0,$$

if and only if (13.18) holds.

We say the shock *satisfies the entropy inequality* if we get strict inequality in (13.18):

$$-s(\eta_+ - \eta_-) + q_+ - q_- < 0. \quad (13.19)$$

The point of the next theorem is to show that if the shock (13.15) satisfies the Lax entropy condition, then not only is the inequality (13.18) satisfied for any convex entropy η , but in fact the sharper strict inequality (13.19) holds.

Theorem 13.1. *Let f be a C^2 strictly convex flux, and let η be a C^2 strictly convex entropy with entropy flux q . If the shock wave (13.15) satisfies the Lax entropy condition, then it satisfies the entropy inequality (13.19).*

Proof. Suppose the shock wave (13.15) satisfies the Lax entropy condition. Then $u_- > u_+$. Let $\eta : \mathbb{R} \rightarrow \mathbb{R}$ be C^2 , with $\eta'' > 0$. We define functions

$$s(u) = \frac{f(u) - f(u_-)}{u - u_-}, \quad E(u) = -s(u)(\eta(u) - \eta(u_-)) + q(u) - q(u_-).$$

Then $E(u_-) = 0$. The proof will be complete when we show that $E(u_+) < 0$. To do so, we differentiate the Rankine-Hugoniot condition

$$-s(u)(u - u_-) + f(u) - f(u_-) = 0 \quad (13.20)$$

as well as $E(u)$. Differentiating (13.20), we have

$$-s'(u)(u - u_-) - s(u) + f'(u) = 0.$$

Hence, for $u < u_-$, and using (13.13),

$$\begin{aligned} E'(u) &= -s'(u)(\eta(u) - \eta(u_-)) - s(u)\eta'(u) + q'(u) \\ &= s'(u)\{\eta'(u)(u - u_-) - (\eta(u) - \eta(u_-))\} > 0, \end{aligned}$$

since $s'(u) = \frac{f'(u) - s(u)}{u - u_-} > 0$ and $\eta'(u) < \frac{\eta(u) - \eta(u_-)}{u - u_-}$ (by convexity of η) for $u < u_-$. Moreover, $E'(u_-) = 0$. Consequently, $E(u_+) < 0$ for $u_- > u_+$. ■

We state the converse to [Theorem 13.1](#) slightly differently, as we use piecewise linear convex entropies in the proof, whereas in the previous theorem the entropy was assumed to be C^2 .

Theorem 13.2. *Let $f : \mathbb{R} \rightarrow \mathbb{R}$ be a C^2 strictly convex flux. If the shock wave (13.15) satisfies the entropy inequality for all convex entropies η , then it satisfies the Lax entropy condition (13.16).*

Proof. Since the shock is assumed to satisfy the entropy inequality for all convex entropies, we can choose an entropy to give us the result. Suppose for a contradiction that $u_- < u_+$. Let $k \in (u_-, u_+)$, and define

$$\eta(u) = \begin{cases} k - u, & u < k, \\ 0, & u \geq k. \end{cases} \quad (13.21)$$

Then from (13.13), we have

$$q(u) = \begin{cases} -f(u), & u < k, \\ -f(k), & u \geq k. \end{cases}$$

Therefore, since $u_- < k < u_+$,

$$\eta(u_-) = k - u_-, \quad \eta(u_+) = 0, \quad q(u_-) = -f(u_-), \quad q(u_+) = -f(k).$$

Substituting into the entropy inequality (13.19) gives

$$-s(0 - (k - u_-)) - f(k) + f(u_-) < 0,$$

$$\text{so } s = \frac{f(u_+) - f(u_-)}{u_+ - u_-} < \frac{f(k) - f(u_-)}{k - u_-}.$$

This is an inequality between chords connected to $(u_-, f(u_-))$ in the graph of f . But since $u_- < k < u_+$, the inequality contradicts the assumption that f is strictly convex. Therefore, $u_- > u_+$, since in the case $u_- = u_+$, the entropy inequality (13.19) fails also. ■

It is helpful to sketch the graph of the convex function f and the various

chords referred to in the proofs above, to understand how the proofs work. Incidentally, a similar calculation (essentially exchanging u_+ and u_-) shows that if $u_- > u_+$, then

$$s = \frac{f(u_+) - f(u_-)}{u_+ - u_-} > \frac{f(k) - f(u_+)}{k - u_+}$$

for $u_+ < k < u_-$, which is consistent with the convexity of f .

It is worth noting that the specific entropies (13.21) are a crucial construct in the existence theory of Kruzkov [31] for the Cauchy problem for scalar conservation laws. Rather than going more deeply into the existence theory, we return in the next section to some other issues relating to nonconvex flux functions.

13.4. Undercompressive Shocks

In this section we return to the example

$$u_t + (u^3)_x = 0 \tag{13.22}$$

of a scalar conservation law with concave-convex flux $f(u) = u^3$. Shock waves (13.15) satisfy the Lax entropy condition only for $-\frac{1}{2}u_- < u_+ < u_-$, if $u_- > 0$. For a convex flux function, all other shock waves are expansive in the sense that characteristics leave the shock on both sides. In contrast, for a nonconvex flux, there are shock waves for which the characteristics enter the shock on one side and leave on the other side. For (13.22), we found earlier (by comparing the shock speed to characteristic speeds) that these shocks have $-2u_- < u_+ < -\frac{1}{2}u_-$ when $u_- > 0$.

In the mid-1990s [24] it was realized that such shock waves can be limits of traveling wave solutions of equations that include higher-order derivatives. This was after a decade of research on such *undercompressive shocks* in systems of equations, occurring as dynamic phase transitions [1, 25, 40, 42] in elastic solids and gases, as transition waves in oil recovery models [41, 23] and in magnetohydrodynamics [47].

To justify the shocks that fail the Lax entropy condition, we seek traveling wave solutions of the modified KdV-Burgers equation,

$$u_t + (u^3)_x = \epsilon \gamma u_{xx} + \epsilon^2 u_{xxx}. \tag{13.23}$$

The term *modified* is used because the u^2 nonlinearity of Burgers' equation, and of the KdV equation, is modified to u^3 . The names Burgers and Korteweg-deVries (KdV) are associated with the dissipative and dispersive terms on the right-hand

side, respectively. The parameters ϵ and γ are positive constants. We choose a positive coefficient for the dispersive (third-order) term; the consequences of reversing the sign of the dispersive term are left as [problem 12](#).

The traveling waves we seek have the same form as in the previous chapter: $u = \bar{u}(\xi)$, $\xi = (x - st)/\epsilon$, satisfying far-field boundary conditions $\bar{u}(\pm\infty) = u_{\pm}$. Since the equation is unchanged by the transformation $u \rightarrow -u$, we can restrict attention to traveling waves with $u_- > 0$.

As in [Chapter 12](#), we convert the PDE into an ODE and integrate once, with the result (in which we have dropped the bars on u)

$$u'' = -\gamma u' + (u^3 - u_-^3) - s(u - u_-).$$

Recall that we analyzed a similar equation when seeking traveling waves for the bistable [equation \(12.13\)](#). As in the analysis of that equation, we write the second-order ODE as a first-order system:

$$\begin{aligned} u' &= v, \\ v' &= -\gamma v + (u^3 - u_-^3) - s(u - u_-). \end{aligned} \tag{13.24}$$

Let $F(u, v) = (v, -\gamma v + (u^3 - u_-^3) - s(u - u_-))$. The vector field F has Jacobian

$$dF(u, v) = \begin{bmatrix} 0 & 1 \\ 3u^2 - s & -\gamma \end{bmatrix}.$$

For $u_- > 0$, and $-2u_- < u_+ < -u_-/2$, let $s = u_+^2 + u_+u_- + u_-^2$. Then there are three equilibria $(u, v) = (u, 0)$, with $u = u_{\pm}$ and $u = u_0$ satisfying $u_+ < u_0 < u_-$, and

$$u_+ + u_0 + u_- = 0. \tag{13.25}$$

At the outside equilibria, $u = u_{\pm}$, we observe that $s < 3u^2$; the eigenvalues of dF are real and of opposite signs, given by

$$\lambda_{\pm}(u) = \frac{1}{2}\{-\gamma \pm \sqrt{\gamma^2 + 4(3u^2 - s)}\}.$$

That is, the equilibria are saddle points. The middle equilibrium at $u = u_0$ has $s > 3u_0^2$, so that it is a stable spiral (if the eigenvalues are complex) or a stable node.

Much as we did for the bistable equation, we seek heteroclinic orbits $(u(\xi), v(\xi))$ that are saddle-saddle connections from $(u_-, 0)$ to $(u_+, 0)$ by finding parameter values for which there is an invariant parabolic manifold

$$v = k(u - u_-)(u - u_+)$$

through these two equilibria. Since $u_+ < u_-$, we must have $k > 0$ to get a traveling wave that follows the parabola from u_- to u_+ and hence is decreasing: $v = u' < 0$.

Writing $u^3 - u_-^3 - s(u - u_-) = (u - u_-)(u - u_0)(u - u_+)$ and rewriting the system (13.24) using $v = v(u)$,

$$v \frac{dv}{du} = -\gamma v + (u - u_-)(u - u_0)(u - u_+),$$

we see that (after canceling factors $(u - u_-)(u - u_+)$)

$$k^2(2u - u_+ - u_-) = -\gamma k + u - u_0.$$

Equating coefficients gives

$$k = 1/\sqrt{2}, \quad u_- + u_+ = \sqrt{2}\gamma + 2u_0.$$

Using (13.25), we get

$$u_0 = -\sqrt{2}\gamma/3, \quad u_+ = -u_- + \sqrt{2}\gamma/3.$$

In particular, the middle equilibrium depends only on γ , so that the chord with slope s pivots on this point as u_- is varied. But then for u_0 to be the middle equilibrium, we must have $u_- > -2u_0 = 2\sqrt{2}\gamma/3$. At the threshold, $u_+ = u_0$. In summary, we have the following theorem.

Theorem 13.3. [24] *For each $\gamma > 0$, $\epsilon > 0$ and for each $u_- > 2\sqrt{2}\gamma/3$ there is a traveling wave $u(x, t) = \bar{u}((x - st)/\epsilon)$ of (13.23) satisfying $\bar{u}(-\infty) = u_-$ and $\bar{u}(\infty) = u_+ = -u_- + \sqrt{2}\gamma/3$, with speed $s = u_-^2 - \sqrt{2}\gamma u_-/3 + 2\gamma^2/9$.*

As $\epsilon \rightarrow 0^+$, the traveling wave $u(x, t)$ of the theorem approaches the shock wave solution (13.15) of (13.22). This solution is *undercompressive* in the sense that characteristics pass through the shock from left to right, meaning that the shock is subsonic on both sides. As $u_- \rightarrow 2\sqrt{2}\gamma/3$, we have $s \rightarrow 3u_-^2/4$, and the chord becomes tangent at $u_+ = u_0 = -u_-/2$.

Undercompressive shocks have considerable influence on the structure of solutions of the scalar equation (13.22). The Riemann initial value problem

$$\begin{aligned} u_t + (u^3)_x &= 0, \\ u(x, 0) &= \begin{cases} u_L, & \text{if } x < 0, \\ u_R, & \text{if } x > 0 \end{cases} \end{aligned} \quad (13.26)$$

has weak solutions that are monotonic for all choices of u_L, u_R if only Lax shocks are used, but it can be nonmonotonic if undercompressive shocks are considered. For example, consider $\gamma > 0$ to be set, let $u_L = 1$, and $-1 + \sqrt{2}\gamma/3 < u_R < -\sqrt{2}\gamma/3$.

Then the solution of the Riemann problem (13.26) consists of two shocks, each of which has a traveling wave solution of (13.23):

$$u(x, t) = \begin{cases} 1, & \text{if } x < s_1 t, \\ u_M, & \text{if } s_1 t < x < s_2 t, \\ u_R, & \text{if } x > s_2 t. \end{cases} \quad (13.27)$$

Here $u_M = -1 + \sqrt{2\gamma/3}$, $s_1 = 1 + u_M + u_M^2$, $s_2 = u_R^2 + u_R u_M + u_M^2$. The slower shock is undercompressive, and the faster one is a Lax shock. Because of the structure of characteristics in this solution, we observe that small disturbances ahead of the faster wave are overtaken and absorbed by that wave, whereas small disturbances behind the slower wave pass through the wave and are absorbed by the faster wave. Details of this two-shock solution and others can be found in the article by Jacobs et al. [24] and in the book by LeFloch [34].

13.5. The (Viscous) Burgers Equation

In this section we consider the viscous Burgers equation

$$u_t + uu_x = \epsilon u_{xx} \quad -\infty < x < \infty, \quad t > 0, \quad (13.28)$$

in which the viscosity $\epsilon > 0$ is a constant. The equation couples nonlinear transport to linear diffusion. To solve the Cauchy problem (13.28) with initial data $u_0 \in L^1(\mathbb{R})$,

$$u(x, 0) = u_0(x), \quad -\infty < x < \infty, \quad (13.29)$$

we convert the PDE into the heat equation with a clever change of dependent variable known as the *Cole-Hopf transformation* [9, 21]. To motivate the transformation, let

$$u = w_x,$$

and integrate the resulting equation

$$w_{xt} + w_x w_{xx} = \epsilon w_{xxx}$$

with respect to x , taking the constant of integration to be zero:

$$w_t + \frac{1}{2} w_x^2 = \epsilon w_{xx}. \quad (13.30)$$

Now $u = w_x$, so the terms with spatial derivatives can be combined and written as

$$\epsilon \left(u_x - \frac{u}{2\epsilon} u \right),$$

suggesting an integrating factor

$$z = \exp \left\{ - \int \frac{u}{2\epsilon} dx \right\} = e^{-\frac{w}{2\epsilon}}.$$

Now multiply (13.30) by $z = e^{-\frac{w}{2\epsilon}}$ to get

$$-2\epsilon \frac{\partial}{\partial t} \left(e^{-\frac{w}{2\epsilon}} \right) = \epsilon \frac{\partial}{\partial x} \left(e^{-\frac{w}{2\epsilon}} w_x \right).$$

Thus, since $e^{-\frac{w}{2\epsilon}} w_x = -2\epsilon z_x$, we have the heat equation for z :

$$z_t = \epsilon z_{xx}, \quad (13.31)$$

and the initial condition (13.29) becomes an initial condition for z :

$$z(x, 0) = e^{-\frac{1}{2\epsilon} \int_{-\infty}^x u_0(\xi) d\xi}. \quad (13.32)$$

We can solve this initial value problem for $z(x, t)$, using the fundamental solution for the heat equation (see Section 5.1). To exploit the exponential in the initial condition (13.32), let $h(x) = \int_{-\infty}^x u_0(\xi) d\xi$. Then

$$z(x, t) = \frac{1}{\sqrt{4\pi\epsilon t}} \int_{-\infty}^{\infty} \exp \left\{ -\frac{1}{2\epsilon} \left(h(y) + \frac{(x-y)^2}{2t} \right) \right\} dy$$

solves (13.31), (13.32).

To recover the corresponding solution of Burgers' equation, we have

$$u = w_x = -2\epsilon \frac{z_x}{z}, \quad (13.33)$$

which is *the Cole-Hopf transformation*.

Of course, we could have started with the transformation (13.33) and substituted into Burgers' equation (13.28), leading to the heat equation (13.31) after some tedious calculation, but it would not have been so much fun.

Finally, we have the solution of the initial value problem (13.28), (13.29):

$$u(x, t) = \frac{\int_{-\infty}^{\infty} \frac{x-y}{t} \exp \left(-\frac{1}{2\epsilon} \left(h(y) + \frac{(x-y)^2}{2t} \right) \right) dy}{\int_{-\infty}^{\infty} \exp \left(-\frac{1}{2\epsilon} \left(h(y) + \frac{(x-y)^2}{2t} \right) \right) dy}, \quad -\infty < x < \infty, \quad t > 0. \quad (13.34)$$

This explicit formula for the solution of the Cauchy problem is explored in various ways in Whitham's classic book on waves [46]. In particular, with some careful asymptotic analysis it is possible to take the singular limit $\epsilon \rightarrow 0^+$, to recover Lax's solution of the Cauchy problem for the inviscid Burgers equation [12].

13.6. Multidimensional Conservation Laws

In this short section we consider scalar conservation laws in two dimensions:

$$u_t + f(u)_x + g(u)_y = 0. \quad (13.35)$$

The method of characteristics gives lines

$$\frac{dx}{dt} = f'(u); \quad \frac{dy}{dt} = g'(u);$$

thus, $x = f'(u)t + x_0$, $y = g'(u)t + y_0$, on which $u(x, y, t)$ is constant. Thus, the Cauchy problem, with initial condition

$$u(x, y, 0) = u_0(x, y)$$

has the solution $u(x, y, t)$ given implicitly by

$$u = u_0(x - f'(u)t, y - g'(u)t).$$

A calculation due to Conway [10] and reported by Majda [35] shows that shock formation is easily described as a criterion on the initial data. If we differentiate (13.35) with respect to x and y , we get equations for the evolution of $\nabla u = (u_x, u_y)$. Let $(v, w) \equiv \nabla u$. Then along a characteristic,

$$\frac{dv}{dt} = -f''(u)v^2 - g''(u)vw, \quad \frac{dw}{dt} = -f''(u)vw - g''(u)w^2, \quad (13.36)$$

where $\frac{dh}{dt} = h_t + f'(u)h_x + g'(u)h_y$ is differentiation along the characteristic.

Now let $q(t) = f''(u)v(t) + g''(u)w(t)$. Note that $q(t) = \nabla \cdot (f'(u), g'(u))$. Since u is constant along the characteristic, we have $\frac{dq}{dt} = f''(u)\frac{dv}{dt} + g''(u)\frac{dw}{dt}$. But using (13.36), we find

$$\frac{dq}{dt} = -q^2.$$

The initial condition for this ODE is

$$q(0) = q_0 = f''(u_0(x, y))\partial_x u_0(x, y) + g''(u_0(x, y))\partial_y u_0(x, y).$$

The solution is

$$q(t) = \frac{q_0}{1 + tq_0}.$$

Consequently, $q(t)$ blows up in finite time $t^* = -1/q_0$ if $q_0 < 0$. That is, shock formation takes place in finite time from smooth initial data if

$$\nabla \cdot (f'(u_0(x, y)), g'(u_0(x, y))) < 0$$

at some point (x, y) .

Example 5. (Shock formation in the avalanche model) The avalanche

example (3.17) gives an interesting twist on this calculation. The PDE (having set $S = 1$ for simplicity) is of the form (13.35), except that $f = yu$ depends explicitly on y :

$$u_t + yu_x + (u(u - 1))_y = 0.$$

Differentiating with respect to x, y leads to the system

$$\frac{dv}{dt} = -2vw, \quad \frac{dw}{dt} = -v - 2w^2 \quad (13.37)$$

for the gradient $(v, w) = \nabla u$. Notice that this system resembles (13.36), but the linear term makes the dynamics work rather differently. Trajectories for system (13.37) are represented by curves in the v - w plane that we find by writing system (13.37) as

$$w \frac{dw}{dv} = -\frac{1}{2} + \frac{w^2}{v}.$$

This is an equation for w^2 as a function of v , which can be solved with the result that the trajectories are all conic sections

$$cv^2 + v + w^2 = 0, \quad (13.38)$$

where $c \in \mathbb{R}$ is a parameter, the constant of integration. Equation (13.38) represents ellipses if $c > 0$, hyperbolas if $c < 0$, and a parabola if $c = 0$. The trajectories are shown in Figure 13.8. A remarkable property of system (13.37) is that the solutions can be written explicitly:

$$v(t) = \frac{v_0}{q(t)}, \quad w(t) = \frac{w_0 - v_0 t}{q(t)}, \quad q(t) = 1 + 2w_0 t - v_0 t^2. \quad (13.39)$$

Consequently, $\nabla u = (v, w)$ becomes unbounded in finite time if $q(t)$ has a positive zero. This is a condition on the initial gradient (v_0, w_0) . The result is that all the unbounded trajectories shown in the figure correspond to initial conditions that result in finite-time shock formation.

The solution (13.39) is obtained using ODE tricks. Let $v = zw$. Then $v' = z'w + zw'$. Using (13.37) to eliminate v' and w' , we find $z' - z^2 = 0$. Thus, $z = v/w = (c - t)^{-1}$, where $c = w_0/v_0$ from the initial condition $t = 0$. Therefore, $w = (c - t)v$, and the first equation in (13.37) becomes $v' = 2v^2(t - c)$, which can be solved by separating variables, leading to the expression for $v(t)$ in (13.39). The expression for $w(t)$ is then given by $w(t) = (c - t)v(t)$.

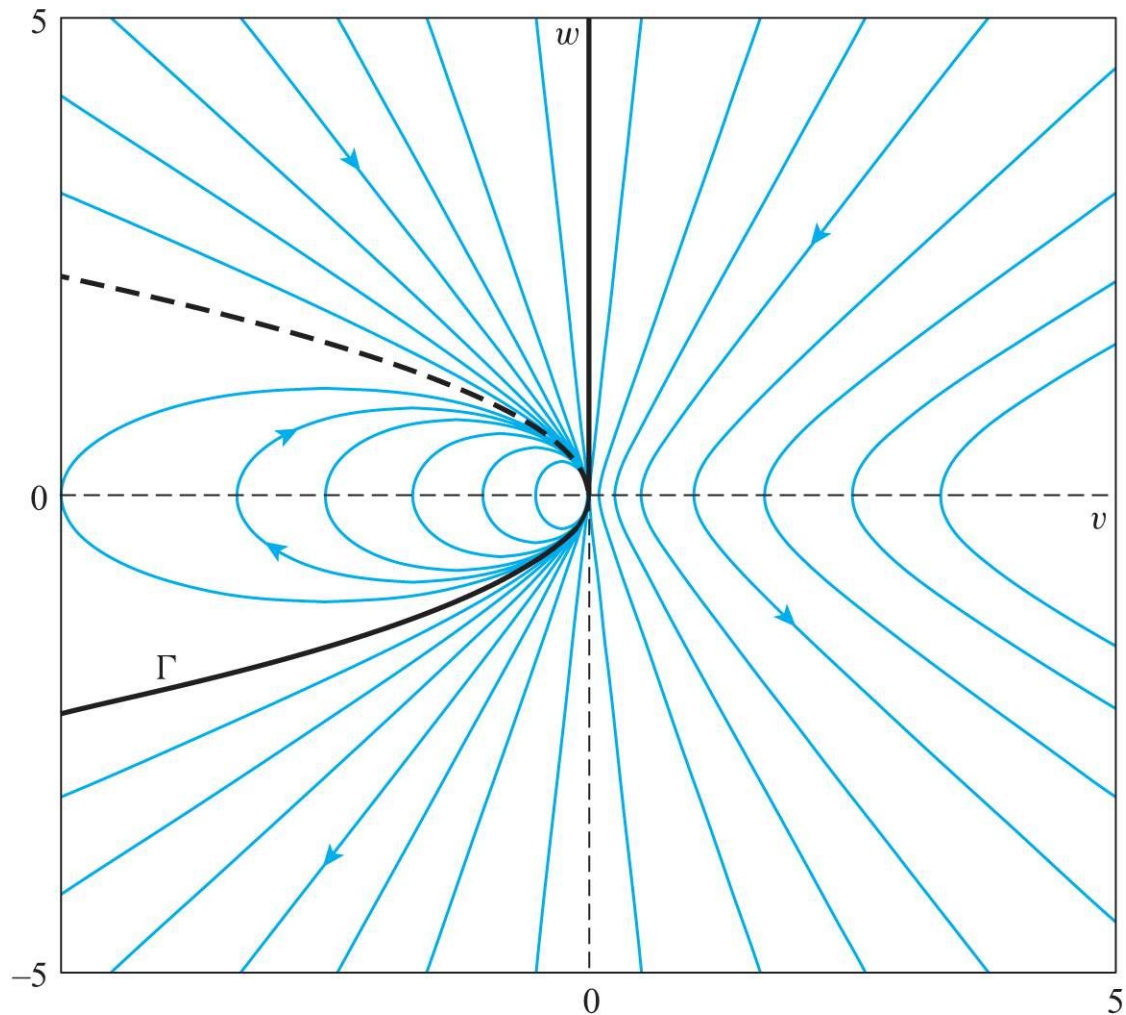

Figure 13.8. Phase portrait and trajectories for system (13.37).

13.6.1. Shocks in Two Dimensions

The Rankine-Hugoniot jump condition in multiple dimensions is derived using the Divergence Theorem. In one space dimension a shock curve is a point at each time, across which the solution jumps, but we used a direct calculation to derive the jump condition. In two space dimensions a shock is a space-time surface, a curve at each time, across which the solution jumps, and which evolves in time.

Equation (13.35) is in conservation form, so that we can apply the Divergence Theorem in x - y - t space. Suppose a weak solution is piecewise C^1 , with a jump discontinuity across a surface $\phi(x, y, t) = 0$. The normal to the surface is $\nabla\phi = (\phi_x \ \phi_y \ \phi_t)$. Since we want the surface to intersect each constant-time plane in a curve, we assume that the surface can be parameterized in terms of t and a combination of the spatial variables. Rotating if necessary, we can assume $x = \hat{x}(y, t)$, so that $\phi(x, y, t) = x - \hat{x}(y, t)$, and the normal is $\mathbf{n}(y, t) = (1, -\hat{x}_y, -\hat{x}_t)$. Now consider that (13.35) can be written as

$$(\partial_t, \partial_x, \partial_y) \cdot (u, f(u), g(u)) = 0.$$

Then the jump condition states that the normal component of the vector field $(u,$

$f(u), g(u)$ is continuous across the surface, and hence has no jump:

$$\mathbf{n}(y, t) \cdot ([u], [f(u)], [g(u)]) = 0,$$

where $[u] = \lim_{x \rightarrow \hat{x}^+} u(x, y, t) - \lim_{x \rightarrow \hat{x}^-} u(x, y, t)$. Specifically, this becomes

$$-\hat{x}_t[u] + [f(u)] - \hat{x}_y[g(u)] = 0. \quad (13.40)$$

Correspondingly, the Lax entropy condition is formulated just as for the one-dimensional case, where the single space variable is normal to the shock curve at each time. The details of the following calculation are covered in some generality in Serre's monograph [39]. Let u^\pm be the limits from the right and left in x : $u^\pm(y, t) = u(\hat{x}(y, t)^\pm, y, t)$. The characteristic speeds in the normal direction at the shock are given by

$$\lambda^\pm = f'(u^\pm) - g'(u^\pm)\hat{x}_y.$$

The Lax entropy condition compares the characteristic speeds with the shock speed in (13.40):

$$\lambda^+ < \hat{x}_t < \lambda^-.$$

This condition can be used to show stability of Lax shocks, meaning that for nearby initial conditions, the Cauchy problem is well posed [39]. Stability of shock waves for scalar equations and systems is a topic of ongoing research. In the next chapter we discuss shocks, rarefactions, and the Riemann problem for systems of equations in one space dimension and time.

PROBLEMS

1. Differentiate $u(ax, at) = C$ with respect to a . Solve the resulting linear first-order PDE by the method of characteristics to prove that u is a function of x/t .
2. Show that if $u(x, t)$ is continuous; is C^1 on either side of a curve \mathbf{C} ; satisfies the PDE at each point not on \mathbf{C} ; and u_x, u_t are continuous up to \mathbf{C} but have a jump discontinuity across \mathbf{C} then the curve \mathbf{C} is a characteristic.
3. Suppose $\lambda_o(u) = k_o u^2$ and $\lambda_w(1 - u) = k_w(1 - u)^2$, with positive constants k_o, k_w in (13.10). Show that $f(u)$ in (13.10) is positive, increasing but nonconvex, with a single inflection point.
4. Show that if

$$\frac{f(u) - f(v)}{u - v} = \frac{1}{2}(f'(u) + f'(v))$$

for all u, v , then $f(u)$ is a quadratic polynomial. (Hint: Take v to be fixed, and solve the ODE for $f(u)$.) Explain the significance of this result.

5. For the solution of [Example 3](#), [Figure 13.4](#), do the following.

(a) Sketch graphs of the solution $u(x, t)$ as a function of x for various times, such as $t = 0$, $t = 1$, $t = 3$.

(b) Write the solution out as a formula, and describe how $u(x, t)$ approaches zero as $t \rightarrow \infty$.

(c) Is the convergence to zero as $t \rightarrow \infty$ uniform? Explain with a proof.

6. Find all values of the positive constants a, b, c, d for which the function

$$u(x, t) = \begin{cases} -a(t + \sqrt{bx + ct^2}), & \text{if } x > -dt^2, \\ 0, & \text{if } x < -dt^2 \end{cases}$$

is a weak solution of the inviscid Burgers equation for $-\infty < x < \infty$, $t \geq 0$, and satisfies the Lax entropy condition at the shock. (Hint: The PDE and the Rankine-Hugoniot condition give three equations for a, b, c, d .)

7. Consider the PDE

$$u_t + \frac{1}{3}(u^3)_x = 0.$$

(a) Write the Rankine-Hugoniot condition for a shock wave

$$u(x, t) = \begin{cases} u_-, & x < st, \\ u_+, & x > st. \end{cases} \quad (13.41)$$

(b) Find all the shocks (13.41) with $u_- = 1$ that satisfy the Lax entropy condition.

(c) Let $u_- = 1$. Find all values of u_+ for which there is a rarefaction wave

$$u(x, t) = \begin{cases} u_-, & x < u_-^2 t, \\ \hat{u}\left(\frac{x}{t}\right), & u_-^2 t < x < u_+^2 t, \\ u_+, & x > u_+^2 t, \end{cases}$$

and write a formula for the function \hat{u} .

8. Use the implicit [equation \(13.7\)](#) or differentiate (13.5) to derive an ODE for the evolution of $v = u_x$ along characteristics. By solving the ODE, find conditions under which the following are true.

(a) The solution remains smooth for all $t > 0$.

(b) The solution develops a singularity in finite time, due to $|v| \rightarrow \infty$. Characterize the time at which this singularity forms.

9. Complete the solution of the traffic light problem (Example 4), shown in Figure 13.6, by doing the following.

(a) Find a formula for the shock curve γ .

(b) Determine the time t_3 as a function of the other parameters.

10. Traffic of uniform density is proceeding along a straight single-lane highway at speed v_0 . At time $t = 0$, the car at location $x = 0$ slows suddenly to half speed $v_0/2$. Determine what happens subsequently, writing formulas and sketching the x - t plane to show the structure of the solution.

11. Consider the modified KdV-Burgers equation (13.23) with $\epsilon = 1$ but with the sign of the dispersive term reversed:

$$u_t + (u^3)_x = \gamma u_{xx} - u_{xxx}.$$

(a) Explain why this equation cannot be reduced to (13.23) with a change of variables, whereas for the quadratic nonlinearity of the KdV-Burgers equation, the sign of the dispersive term can be changed (without changing $\gamma > 0$).

(b) Write the ODE for traveling wave solutions $u = u(x - st)$ as a first-order system. Consider values of u_{\pm} for which there are three equilibria $u_+ < u_0 < u_-$. Show that the only heteroclinic orbits join equilibria u_{\pm} to u_0 , and the corresponding shock waves (13.15) satisfy the Lax entropy condition.

(c) Summarize what is different about this example from the modified KdV-Burgers equation in Section 13.4.

12. Let $\gamma > 0$. Solve the Riemann problem (13.26) with $u_L = 1$, in the following two cases.

(a) When $u_R < -1 + \sqrt{2\gamma}/3$. Your solution should have a rarefaction wave and an undercompressive shock.

(b) When $-\sqrt{2\gamma}/3 < u_R < 1$. In this case, the solution is a single shock. Show that it is a Lax shock and has a corresponding traveling wave solution of (13.23). Show that for $-1 + \sqrt{2\gamma}/3 < u_R < -\sqrt{2\gamma}/3$, the solution consists of two shocks traveling at different speeds, an undercompressive shock and a faster Lax shock.

13. Find the curve Γ shown as the heavy solid curve in Figure 13.8. Show that, together with the positive half of the w -axis, Γ separates initial conditions v_0, w_0 , for which a shock forms, from initial conditions that do not lead to shock formation. (Hint: You can solve this problem by examining when the quadratic equation $q(t) = 0$ has a positive solution.)

Systems of First-Order Hyperbolic PDE

Systems of hyperbolic conservation laws are fundamental to the study of continuum mechanics: the dynamics of fluids and solids. Nonlinear systems possess a richer structure than scalar equations or linear systems, because they have more than one characteristic speed, and waves with different speeds interact nonlinearly.

We begin the chapter with linear equations, for which the method of characteristics can be generalized from the scalar equations of [Chapters 3](#) and [13](#), leading to a short-time existence theorem for classical solutions. Then we show how weak solutions of nonlinear systems of conservation laws can be constructed from shocks and rarefaction waves. Along the way we show applications to the p -system, to the elastic string, and to shallow water waves.

14.1. Linear Systems of First-Order PDE

We consider linear systems of equations in one space variable $x \in \mathbb{R}$ and time $t > 0$ of the form

$$\mathbf{U}_t + A\mathbf{U}_x = 0, \tag{14.1}$$

where $\mathbf{U} = \mathbf{U}(x, t) \in \mathbb{R}^n$ is the dependent variable, and $A = A(x, t)$ is an $n \times n$ matrix depending smoothly on its arguments. We shall consider the Cauchy problem, for which we pose initial conditions

$$\mathbf{U}(x, 0) = \mathbf{U}_0(x). \tag{14.2}$$

System (14.1) is *hyperbolic* if A has n real eigenvalues λ_k , with n linearly independent (right) eigenvectors \mathbf{r}_k , $k = 1, 2, \dots, n$. The system is *strictly hyperbolic* if the n eigenvalues λ_k , $k = 1, 2 \dots n$ are all distinct. The eigenvalues of A are called *characteristic speeds*, as in the scalar case. We will also need the left eigenvectors \mathbf{l}_k , which are row vectors. We can assume the eigenvectors have been chosen to satisfy

$$\mathbf{l}_j \cdot \mathbf{r}_k = \delta_{jk} = \begin{cases} 1, & \text{if } j = k, \\ 0, & \text{if } j \neq k. \end{cases} \tag{14.3}$$

14.1.1. Linear Constant-Coefficient Systems

We begin by considering linear constant-coefficient systems, in which A is a constant matrix. In this case, the system admits solutions in traveling wave form (much like the linear transport equation):

$$\mathbf{U}(x, t) = \varphi(x - \lambda t)\mathbf{v}.$$

Substituting \mathbf{U} into system (14.1), we have

$$\varphi'(-\lambda I + A)\mathbf{v} = 0,$$

so that $\lambda = \lambda_k$ is an eigenvalue of A , and $\mathbf{v} = \mathbf{r}_k$ is a right eigenvector. Such a solution is a traveling wave with speed λ_k .

To solve the system (14.1) when A is a constant matrix, we simply diagonalize the matrix, or equivalently, decompose \mathbf{U} using the eigenvectors:

$$\mathbf{U}(x, t) = \sum_{k=1}^n u^k(x, t)\mathbf{r}_k, \quad (14.4)$$

where $u^k : \mathbb{R} \times \mathbb{R}^+ \rightarrow \mathbb{R}$. Substituting into (14.1) and using $A\mathbf{r}_k = \lambda_k\mathbf{r}_k$, we get decoupled equations for the unknown coefficients u^k :

$$\frac{\partial u^k}{\partial t} + \lambda_k \frac{\partial u^k}{\partial x} = 0, \quad k = 1, \dots, n.$$

Thus, $u^k(x, t) = \varphi^k(x - \lambda_k t)$ for scalar functions φ^k , $k = 1, \dots, n$, and we have the general solution of the system

$$\mathbf{U}(x, t) = \sum_{k=1}^n \varphi^k(x - \lambda_k t)\mathbf{r}_k.$$

The initial condition (14.2) is satisfied by setting $t = 0$ and using the left eigenvectors:

$$\varphi^k(x) = \mathbf{l}_k \cdot \mathbf{U}_0(x).$$

Example 1. (The wave equation as a system) A simple example of a constant-coefficient first-order system is provided by the wave equation in one space dimension and time

$$w_{tt} - c^2 w_{xx} = 0.$$

We write the PDE as a system by letting

$$v = w_t, \quad u = w_x.$$

Then we have

$$\begin{aligned} u_t - v_x &= 0, \\ v_t - c^2 u_x &= 0, \end{aligned}$$

and the initial conditions $w(x, 0) = f(x)$, $w_t(x, 0) = g(x)$ become

$$u(x, 0) = f'(x), \quad v(x, 0) = g(x).$$

Thus, in terms of system (14.1), we have

$$\mathbf{U} = \begin{pmatrix} u \\ v \end{pmatrix}, \quad A = \begin{pmatrix} 0 & -1 \\ -c^2 & 0 \end{pmatrix}, \quad \mathbf{U}_0(x) = \begin{pmatrix} f'(x) \\ g(x) \end{pmatrix}.$$

The characteristic speeds are $\pm c$, with eigenvectors

$$\mathbf{r}_{\pm} = \begin{pmatrix} 1 \\ \mp c \end{pmatrix}.$$

The solution of the initial value problem is thus

$$\begin{pmatrix} u \\ v \end{pmatrix}(x, t) = \varphi^+(x - ct) \begin{pmatrix} 1 \\ -c \end{pmatrix} + \varphi^-(x + ct) \begin{pmatrix} 1 \\ c \end{pmatrix},$$

in which φ^{\pm} are related to f, g by $\varphi^+ + \varphi^- = f'$; $\varphi^+ - \varphi^- = g/c$.

14.1.2. Method of Characteristics for Variable Coefficients

Now let's consider how the method of characteristics, which we used so successfully for scalar equations, can be applied to linear systems when $A = A(x, t)$ is not a constant matrix. For this purpose, we again diagonalize the matrix A using the eigenvectors. That is, we substitute (14.4) into system (14.1), but now the eigenvectors \mathbf{r}_i depend on x, t as well as on the coefficients u^i :

$$\mathbf{U}_t + A\mathbf{U}_x = \sum_{i=1}^n \left((\partial_t u^i) \mathbf{r}_i + u^i \partial_t \mathbf{r}_i \right) + \sum_{i=1}^n \left((\partial_x u^i) \lambda_i \mathbf{r}_i + u^i A \partial_x \mathbf{r}_i \right) = 0.$$

Taking the scalar product of this equation with the left eigenvectors \mathbf{l}_j (see (14.3)), we obtain a system of the form

$$\partial_t u^i + \lambda_i \partial_x u^i = \sum_{j=1}^n d_{ij}(x, t) u^j, \quad (14.5)$$

in which the coefficients d_{ij} are continuous functions of x, t . Similarly, decomposing the initial conditions (14.2) into eigenvectors of $A(x, 0)$, we obtain initial conditions for the coefficients u^i :

$$u^i(x, 0) = u_0^i(x).$$

Characteristics are defined, as for scalar equations, by

$$\frac{dx}{dt} = \lambda_i(x, t).$$

In particular, through each point (x, t) , with $t > 0$, there are n characteristics $x = x_i(\tau)$, $i = 1, 2, \dots, n$, passing through (x, t) , each with a different speed. Each intersects the x -axis at a different point $\bar{x}_i = x_i(0)$. We recognize the left-hand side

of the i th equation in (14.5) as $du^i/d\tau$ (i.e., differentiation along the i th characteristic). This enables us to convert equations (14.5) into integral equations, by integrating along the i th characteristic from $(\bar{x}, 0)$ to (x, t) :

$$u^i(x, t) = u_0^i(\bar{x}_i) + \int_0^t \sum_{j=1}^n d_{ij}(x_i(\tau), \tau) u^j(x_i(\tau), \tau) d\tau. \quad (14.6)$$

Next we write this system in vector form:

$$\mathbf{u}(x, t) = \boldsymbol{\varphi}(x, t) + \mathbf{K}(\mathbf{u})(x, t),$$

where $\varphi^i(x, t) = u_0^i(\bar{x}_i)$, and $\mathbf{K}(\mathbf{u})(x, t)$ denotes the vector of integrals on the right-hand side of (14.6).

Solving the Cauchy problem is equivalent to finding a fixed point of the mapping $\mathbf{B} : \mathbf{u} \rightarrow \boldsymbol{\varphi} + \mathbf{K}(\mathbf{u})$ in a suitable space of functions. The appropriate setting is the *contraction mapping principle* (see [Appendix A](#)) in the Banach space $X = C_B(\mathbb{R} \times [0, T], \mathbb{R}^n)$ of continuous bounded functions from $\mathbb{R} \times [0, T]$ to \mathbb{R}^n , with $T > 0$ to be chosen. This principle is used to prove existence of solutions of initial value problems for systems of ODE. The context here is not much different, as we have reduced the Cauchy problem to a system of integral equations. The norm in X is the supremum norm on bounded continuous functions:

$$\|\mathbf{u}\| = \sum_{i=1}^n \sup_{x,t} |u_i(x, t)|.$$

We assume that the entries in the matrix $A(x, t)$ are in X , and so are their derivatives. Then the coefficients d_{ij} are all in X , since they depend on derivatives of the eigenvectors $r_i(x, t)$, which by standard matrix analysis have derivatives in X [28]. Since for linear equations the characteristic speeds do not depend on the solution \mathbf{u} , the function $\boldsymbol{\varphi}$ is also independent of \mathbf{u} . (For nonlinear equations, the dependence on \mathbf{u} would be through the points \bar{x}_i .)

For $\mathbf{u}, \mathbf{v} \in X$, we have that for $0 \leq t \leq T$,

$$\begin{aligned} \|\mathbf{B}(\mathbf{u}) - \mathbf{B}(\mathbf{v})\| &= \|\mathbf{K}(\mathbf{u}) - \mathbf{K}(\mathbf{v})\| \\ &= \left| \int_0^t \sum_{j=1}^n d_{ij}(x_i(\tau), \tau) \left(u^j(x_i(\tau), \tau) - v^j(x_i(\tau), \tau) \right) d\tau \right| \\ &\leq T \left(\sum_{i,j=1}^n \sup_{|x|<\infty, 0 \leq \tau \leq T} |d_{ij}(x, \tau)| \right) \|\mathbf{u} - \mathbf{v}\|. \end{aligned}$$

Therefore, for $T > 0$ sufficiently small, \mathbf{K} is a contraction; hence the mapping \mathbf{B} is

also. By the Banach fixed-point theorem (see [Appendix A](#)), \mathbf{B} has a unique fixed point in X . Thus, we have proved the following theorem for the initial value problem

$$\mathbf{U}_t + A\mathbf{U}_x = 0, \quad \mathbf{U}(x, 0) = \mathbf{U}_0(x). \quad (14.7)$$

Theorem 14.1. *Let $\mathbf{U}_0 \in C_B(\mathbb{R})$, and suppose the matrix $A = A(x, t)$ in (14.7) has entries in $C_B(\mathbb{R})$, together with their derivatives. Then there is $T > 0$ such that the initial value problem (14.7) has a unique solution $u \in C_B(\mathbb{R} \times [0, T], \mathbb{R}^n)$.*

14.2. Systems of Hyperbolic Conservation Laws

In this section we consider nonlinear systems of conservation laws

$$\mathbf{U}_t + \mathbf{F}(\mathbf{U})_x = 0, \quad (14.8)$$

in which $\mathbf{F} : \mathbb{R}^n \rightarrow \mathbb{R}^n$ is a C^2 function. For nonlinear systems we can obtain a short-time existence and uniqueness theorem similar to [Theorem 14.1](#) under suitable assumptions. However, in this section we focus on issues arising because of nonlinearity—notably, shock waves and rarefaction waves—and show how these waves appear in applications.

We refer to (14.8) as an $n \times n$ system. We shall assume *strict hyperbolicity*, meaning that the Jacobian $d\mathbf{F}(\mathbf{U})$, an $n \times n$ matrix for each $\mathbf{U} \in \mathbb{R}^n$, has distinct real eigenvalues, namely, the *characteristic speeds*

$$\lambda_1(\mathbf{U}) < \lambda_2(\mathbf{U}) < \cdots < \lambda_n(\mathbf{U}),$$

with corresponding left and right eigenvectors $\mathbf{l}_j(\mathbf{U})$, $\mathbf{r}_j(\mathbf{U})$, $j = 1, \dots, n$ satisfying (14.3) at each \mathbf{U} :

$$\mathbf{l}_j \cdot \mathbf{r}_k = \delta_{jk}.$$

Strict hyperbolicity allows us to discuss unambiguously the k th characteristic field by referring to the characteristic speed λ_k .

The notion of genuine nonlinearity for scalar equations has a counterpart for systems by considering the characteristic fields separately. The k th characteristic field is *genuinely nonlinear* in a set $\Omega \subset \mathbb{R}^n$ if

$$\mathbf{r}_k(\mathbf{U}) \cdot \nabla \lambda_k(\mathbf{U}) \neq 0, \quad \mathbf{U} \in \Omega.$$

The field is *linearly degenerate* in Ω if

$$\mathbf{r}_k(\mathbf{U}) \cdot \nabla \lambda_k(\mathbf{U}) \equiv 0, \quad \mathbf{U} \in \Omega.$$

A function $\psi : \mathbb{R}^n \rightarrow \mathbb{R}$ is a *k-Riemann invariant* if

$$\mathbf{r}_k(\mathbf{U}) \cdot \nabla \psi(\mathbf{U}) \equiv 0. \quad (14.9)$$

Then for each k , there are, locally in \mathbf{U} , $n - 1$ Riemann invariants whose gradients are linearly independent at each \mathbf{U} . This follows because (14.9) is a scalar equation for $\psi(\mathbf{U})$. The equation says that w is constant on characteristics, which are parallel to $\mathbf{r}_k(\mathbf{U})$. Consequently, each Riemann invariant is constant on rarefaction curves, which are integral curves of the vector field $\mathbf{r}_k(\mathbf{U})$: $\mathbf{U}' = \mathbf{r}_k(\mathbf{U})$. As for scalar equations, the construction of rarefaction waves is closely related to the property of genuine nonlinearity.

A Riemann invariant ψ can be specified locally near a given point $\mathbf{U}_0 \in \mathbb{R}^n$ by defining its values on an $n - 1$ dimensional manifold \mathcal{M} orthogonal to $\mathbf{r}_k(\mathbf{U}_0)$, say, $\psi = \tilde{\psi}$ on \mathcal{M} . Then $\nabla_{\mathcal{M}}\tilde{\psi}$ is tangent to \mathcal{M} at \mathbf{U}_0 , where $\nabla_{\mathcal{M}}$ is the gradient operator along the linear space tangent to \mathcal{M} at \mathbf{U}_0 . We define ψ near \mathbf{U}_0 by solving $r_k \cdot \nabla\psi = 0$ by the method of characteristics. A set of $n - 1$ independent Riemann invariants is given by choosing $n - 1$ functions $\tilde{\psi}$ on \mathcal{M} with the property that the $n - 1$ gradients $\nabla_{\mathcal{M}}\tilde{\psi}$ are linearly independent at \mathbf{U}_0 . Then the gradients $\nabla\psi(\mathbf{U})$ are linearly independent for all \mathbf{U} near \mathbf{U}_0 and are orthogonal to $\mathbf{r}_k(\mathbf{U})$.

For a 2×2 system (of $n = 2$ equations in 2 unknowns u, v), the Riemann invariants can be used as an alternative pair of variables, with the advantage that they partially diagonalize the system. To be specific, let $\lambda_{\pm}(\psi_-, \psi_+)$ denote the two characteristic speeds, written as functions of the Riemann invariants ψ_{\pm} . Then the following holds:

$$(\partial_t + \lambda_{\mp}\partial_x)\psi_{\pm} = 0. \quad (14.10)$$

We leave verification of this property to [Problem 7](#). This property means that each Riemann invariant ψ_{\pm} is constant on characteristics $x' = \lambda_{\mp}$ of the opposite family!

It is worth comparing the notation and constructions for systems of hyperbolic conservation laws with the corresponding development in [Sections 13.1](#) and [13.2](#) on scalar conservation laws from the previous chapter. We shall use three examples of systems of conservation laws to illustrate the ideas in this chapter, beginning with the issue of hyperbolicity.

14.2.1. The p -System

This 2×2 system is derived from the quasilinear wave equation:

$$w_{tt} - \sigma(w_x)_x = 0, \quad (14.11)$$

in which $\sigma : \mathbb{R} \rightarrow \mathbb{R}$ is a given smooth function. The equation, derived in [Section](#)

4.1.1, is a model of nonlinear one-dimensional elasticity, in which $w = w(x, t)$ is the displacement, and w_x is the strain (or displacement gradient), and $\sigma = \sigma(w_x)$ is the stress (a given function of the strain).

A typical stress-strain curve is shown in Figure 14.1. The vertical asymptote at $w_x = 0$ corresponds to the infinite force needed to compress the material to a point, and $\sigma(1) = 0$ corresponds to a uniform unstressed material with displacement $w(x, t) = x$.

To write (14.11) as a system, we set (as for the linear wave equation) $u = w_x$ and $v = w_t$, namely the strain and velocity, respectively:

$$\begin{aligned} u_t &= v_x, \\ v_t &= \sigma(u)_x. \end{aligned} \tag{14.12}$$

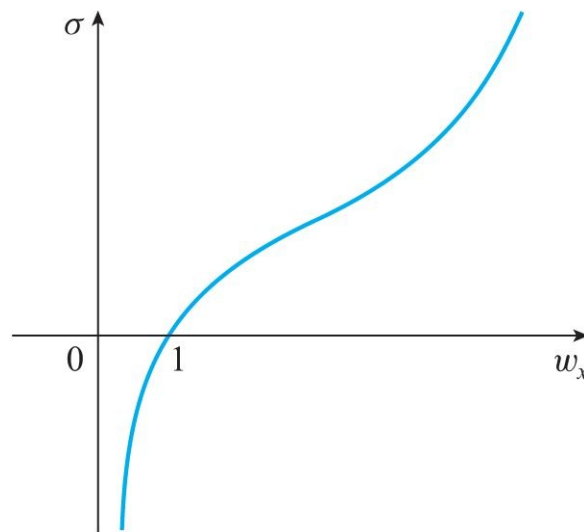

Figure 14.1. A typical nonlinear stress-strain law.

This is an example of system (14.8) in which

$$\mathbf{U} = \begin{pmatrix} u \\ v \end{pmatrix}, \quad \mathbf{F}(\mathbf{U}) = \begin{pmatrix} -v \\ -\sigma(u) \end{pmatrix}.$$

To check hyperbolicity, we calculate

$$d\mathbf{F}(\mathbf{U}) = \begin{pmatrix} 0 & -1 \\ -\sigma'(u) & 0 \end{pmatrix},$$

which has eigenvalues and eigenvectors

$$\lambda_{\pm}(u) = \pm\sqrt{\sigma'(u)}, \quad \mathbf{r}_{\pm}(u) = \begin{pmatrix} 1 \\ \mp\sqrt{\sigma'(u)} \end{pmatrix}.$$

Thus, the system is strictly hyperbolic if and only if $\sigma'(u) > 0$; in words, stress is a strictly increasing function of strain. In most circumstances it is appropriate to consider such monotonic stress-strain laws, although strain-softening materials,

which have some range of strains over which the stress decreases, are important in materials science. Examples include certain plastics (try stretching a thin strip of soft plastic to feel its strain softening) and some metal alloys used to make smart materials that change their stress-strain properties in controlled ways.

The system is genuinely nonlinear in both characteristic fields provided $\sigma''(u) \neq 0$. It is linearly degenerate in both fields if $\sigma''(u) \equiv 0$, in which case $\sigma(u)$ is an affine function of u , corresponding to Hooke's law. The Riemann invariants are $\psi_{\pm}(u, v) = v \pm \int \sqrt{\sigma'(u)} du$ satisfying $\nabla \psi_{\pm} \cdot \mathbf{r}_{\pm} = 0$ and corresponding to $\lambda_{\pm}(u) = \mp \sqrt{\sigma'(u)}$, respectively. Recall that the Riemann invariants allow us to diagonalize the system of equations. (See (14.10).)

System (14.12) also describes one-dimensional isentropic gas dynamics in Lagrangian variables, in which u represents the specific volume (the reciprocal of density), v is once again velocity, and $-\sigma = p$ is the pressure. The name p -system derives from this context of gas dynamics. Further properties of the p -system are discussed later in this chapter and in the book by Smoller [43].

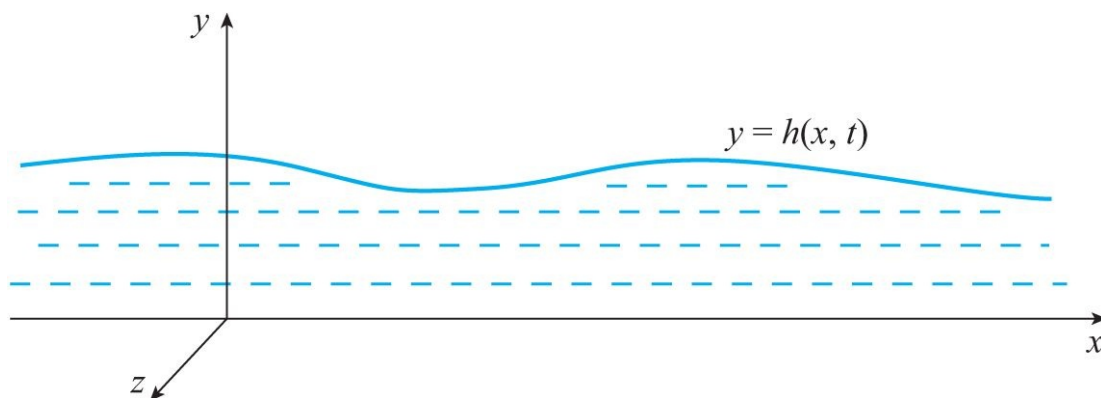

Figure 14.2. Shallow water flow.

14.2.2. The Shallow Water Equations

For a body of water on a flat horizontal surface, we wish to describe the motion of the free surface as the water flows. The full equations of flow for a viscous incompressible fluid (such as water) are the *Navier-Stokes equations*, discussed in the next chapter. The shallow water equations can be derived by a scaling and approximation argument from the full equations, but here we give an abbreviated and more direct route.

Let's restrict to fluid motion in a vertical plane (for example, we assume the fluid is moving parallel to side walls, like a river flowing parallel to its banks), so that the velocity and height of the fluid depend only on one horizontal variable x and a vertical variable y , as in Figure 14.2.

As shown in the figure, let $y = h(x, t)$ be the height of the fluid surface at

time t , and let $u(x, t)$ denote the horizontal velocity of the layer of fluid, which we take to be independent of depth. More precisely, $u(x, t)$ represents the depth-averaged horizontal velocity. Note that we are using Eulerian coordinates to describe the flow, since (x, y) is a fixed physical location. In a Lagrangian formulation, using a reference configuration, individual fluid particles are labeled, and velocity is determined from the particle trajectories.

Conservation of mass is expressed by the equation:

$$h_t + (hu)_x = 0. \quad (14.13)$$

The pressure p in the fluid layer depends on depth, and we assume it is *hydrostatic*, meaning that pressure increases linearly with depth and is atmospheric pressure p_a at the free surface:

$$p(x, y, t) = \rho g(h(x, t) - y) + p_a.$$

Neglecting viscous forces, we can write the conservation of horizontal momentum (an expression of Newton's second law $F = ma$) as

$$\rho(u_t + uu_x) + p_x = 0.$$

Substituting for p , we obtain

$$u_t + uu_x + gh_x = 0. \quad (14.14)$$

Equations (14.13), (14.14) constitute a 2×2 system of the form (14.8), with

$$\mathbf{U} = \begin{pmatrix} h \\ u \end{pmatrix}, \quad \mathbf{F}(\mathbf{U}) = \begin{pmatrix} hu \\ \frac{1}{2}u^2 + gh \end{pmatrix}.$$

To check hyperbolicity, we calculate

$$d\mathbf{F}(\mathbf{U}) = \begin{pmatrix} u & h \\ g & u \end{pmatrix},$$

which has eigenvalues and eigenvectors

$$\lambda_{\pm}(h, u) = u \pm \sqrt{gh}, \quad \mathbf{r}_{\pm}(h, u) = \begin{pmatrix} h \\ \pm\sqrt{gh} \end{pmatrix},$$

respectively. Thus, the system is strictly hyperbolic for $h > 0$, and one family of characteristics travels faster than the fluid velocity, while the other family moves more slowly. The Riemann invariants $\psi_{\pm}(h, u) = u \mp \frac{1}{2}\sqrt{gh}$ satisfy $\nabla\psi_{\pm} \cdot \mathbf{r}_{\pm} = 0$. These Riemann invariants for the shallow water equations will be useful when we solve the classic dam-break problem, which we treat later in [Section 14.3](#).

There is an extensive literature on shallow water waves and the related equations of shallow flow [2, 15, 22, 46] used to model tsunamis and avalanches.

The hyperbolic structure of the equations is important when finding solutions in these applications.

14.2.3. The Elastic String Equations

The equations for motion of an elastic string in two dimensions form a system of two quasilinear wave equations, which we rewrite as a 4×4 system of first-order conservation laws.

As with one-dimensional elasticity, leading to the p -system, the reference configuration is one dimensional, but now we allow deformations in two dimensions. The displacement or position vector, which we write here as $\mathbf{r} = (r_1, r_2) \in \mathbb{R}^2$, is a function of x, t , with x in an interval I representing material points in the string (see Fig. 14.3). Forces in the string are represented by the tension T , a function of x, t that measures the magnitude of the internal force of the string. We assume the direction of this force is tangential to the string, based on the simplifying assumption that the string exerts no resistance to bending. Modeling the force by elasticity means that T is a function of the strain, here given by the scalar $|\mathbf{r}_x|$.

The equations of motion are then

$$\mathbf{r}_{tt} = \left(T(|\mathbf{r}_x|) \frac{\mathbf{r}_x}{|\mathbf{r}_x|} \right)_x. \quad (14.15)$$

The density and cross-sectional area of the string, both taken to be constant functions of x and t , are incorporated into the tension T . On the left of this equation is the acceleration, and on the right, the tension T is the magnitude of a force whose direction is that of the unit tangent. The equation expresses conservation of linear momentum, Newton's second law $F = ma$.

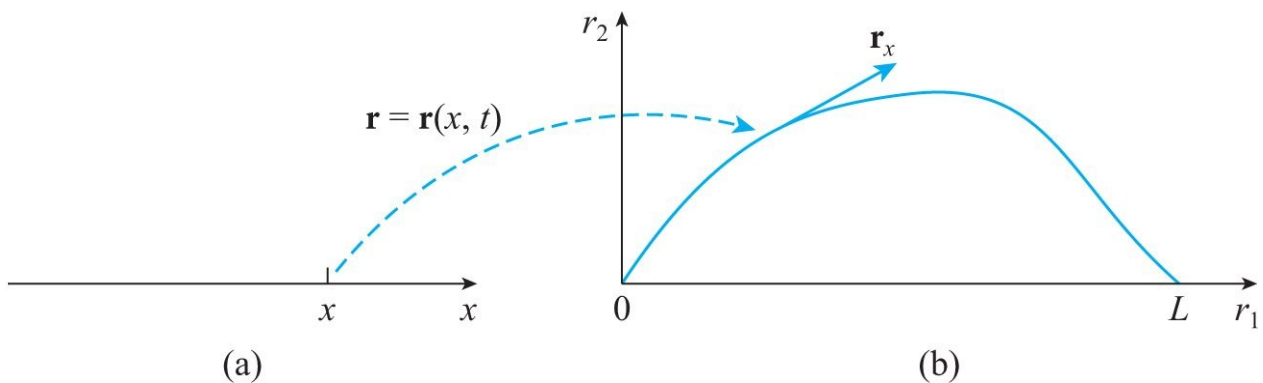

Figure 14.3. The elastic string. (a) Reference configuration, interval I ; (b) physical string.

The function T is typically increasing and takes the form of the stress-strain law shown in Figure 14.1. This makes sense, because for purely longitudinal

motion (along the length of a straight string), the string equations (14.15) reduce to the single wave equation (14.11), with $T = \sigma$. However, even if we assume linear elasticity given by Hooke's law,

$$T(|\mathbf{r}_x|) = E(|\mathbf{r}_x| - 1), \quad (14.16)$$

with elastic constant $E > 1$, the equations are still nonlinear, unless the motion is purely longitudinal.

To write (14.15) as a system of first-order equations, we define variables p , q , u , v by

$$\begin{pmatrix} p \\ q \end{pmatrix} = \mathbf{r}_x, \quad \begin{pmatrix} u \\ v \end{pmatrix} = \mathbf{r}_t, \quad \xi = |\mathbf{r}_x| = \sqrt{p^2 + q^2}.$$

Then (14.15) is equivalent to

$$\begin{aligned} p_t &= u_x, \\ q_t &= v_x, \\ u_t &= \left(\frac{T(\xi)}{\xi} p \right)_x, \\ v_t &= \left(\frac{T(\xi)}{\xi} q \right)_x, \end{aligned} \quad (14.17)$$

which has the form (14.8) when we write

$$\mathbf{U} = \begin{pmatrix} p \\ q \\ u \\ v \end{pmatrix}, \quad \mathbf{F}(\mathbf{U}) = - \begin{pmatrix} u \\ v \\ \frac{T(\xi)}{\xi} p \\ \frac{T(\xi)}{\xi} q \end{pmatrix}.$$

To check hyperbolicity, we compute $d\mathbf{F}(\mathbf{U})$:

$$d\mathbf{F}(\mathbf{U}) = - \begin{pmatrix} 0 & 0 & 1 & 0 \\ 0 & 0 & 0 & 1 \\ b_{11} & b_{12} & 0 & 0 \\ b_{21} & b_{22} & 0 & 0 \end{pmatrix},$$

in which

$$\begin{aligned}
b_{11} &= \frac{\partial}{\partial p} \left(\frac{T(\xi)}{\xi} p \right) = \frac{T(\xi)}{\xi} - \frac{T(\xi)}{\xi} \frac{p^2}{\xi^2} + T'(\xi) \frac{p^2}{\xi^2}, \\
b_{12} &= \frac{\partial}{\partial q} \left(\frac{T(\xi)}{\xi} p \right) = -\frac{T(\xi)}{\xi} \frac{pq}{\xi^2} + T'(\xi) \frac{pq}{\xi^2} = b_{21}, \\
b_{22} &= \frac{\partial}{\partial q} \left(\frac{T(\xi)}{\xi} q \right) = \frac{T(\xi)}{\xi} - \frac{T(\xi)}{\xi} \frac{q^2}{\xi^2} + T'(\xi) \frac{q^2}{\xi^2}.
\end{aligned}$$

The block structure of the matrix

$$d\mathbf{F}(\mathbf{U}) = - \begin{pmatrix} \mathbf{0} & \mathbf{I} \\ \mathbf{B} & \mathbf{0} \end{pmatrix}, \quad \mathbf{B} = (b_{ij}),$$

implies that the eigenvalues of $d\mathbf{F}(\mathbf{U})$ are square roots of the two eigenvalues of \mathbf{B} . Calculating the latter eigenvalues, we find that the characteristic speeds are

$$\lambda_{\pm}^T(\xi) = \pm \sqrt{\frac{T(\xi)}{\xi}}, \quad \lambda_{\pm}^L(\xi) = \pm \sqrt{T'(\xi)}.$$

Consequently, the elastic string equations are strictly hyperbolic if and only if

$$T(\xi) > 0, \quad T'(\xi) > 0, \quad \text{and} \quad \frac{T(\xi)}{\xi} \neq T'(\xi). \quad (14.18)$$

In particular, if we assume the stress-free equilibrium state corresponds to the normalization $T(1) = 0$, then $T(\xi) < 0$ for $\xi < 1$, so that (14.18) does not hold for $\xi < 1$. This is related to the fact that since the string has no resistance to bending, its motion under compression is not well behaved (the equations are linearly ill posed). Consequently, we consider the elastic string equations only for strings under tension (i.e., with $\xi > 1$).

Hooke's law (14.16) leads to a strictly hyperbolic system for $\xi > 1$. More generally, we see that if

$$T(1) = 0, \quad T'(\xi) > 0, \quad \xi \geq 1,$$

then (14.18) is satisfied for $\xi \in (1, \xi_{\max})$, where either $\xi_{\max} = \infty$ or $\xi_{\max} < \infty$ is the first value of $\xi > 1$ for which

$$\frac{T(\xi)}{\xi} = T'(\xi).$$

Then we have

$$|\lambda_{\pm}^T(\xi)| < |\lambda_{\pm}^L(\xi)|, \quad 1 < \xi < \xi_{\max}.$$

As we saw in Section 14.1.2, the characteristic speeds λ_{\pm}^T are associated with *transverse* waves, whereas λ_{\pm}^L are associated with *longitudinal* waves

(corresponding to solutions of the p -system, a connection with longitudinal motion suggested above). Thus, longitudinal waves travel faster than transverse waves for $1 < \xi < \xi_{\max}$.

The notions of longitudinal and transverse waves have counterparts in three-dimensional elasticity, for example, in modeling subterranean earthquake waves. Longitudinal waves are pressure waves, whereas transverse waves correspond to shear waves, in which material is sliding over itself transverse to the direction of propagation of the wave.

We include Problems 2 and 6 at the end of the chapter to explore further properties of the elastic string equations, and there is a nice paper on the equations by Antman [4]. Having established three representative examples, we return to a general strictly hyperbolic system to discuss rarefaction waves and then shocks.

14.2.4. Rarefaction Waves

We return to the general system

$$\mathbf{U}_t + \mathbf{F}(\mathbf{U})_x = 0, \quad (14.19)$$

in which $\mathbf{F} : \mathbb{R}^n \rightarrow \mathbb{R}^n$ is a C^2 function. Our standing assumption is that the system is strictly hyperbolic, meaning that there are n distinct real characteristic speeds, the eigenvalues $\lambda_k(\mathbf{U})$, $k = 1, \dots, n$ of $d\mathbf{F}(\mathbf{U})$, with associated right/left eigenvectors $\mathbf{r}_k/\mathbf{l}_k$ satisfying

$$\langle \mathbf{l}_j, \mathbf{r}_k \rangle = \delta_{jk}.$$

For rarefaction waves, we consider characteristic fields that are *genuinely nonlinear*, meaning values of k and ranges for \mathbf{U} for which

$$d\lambda_k(\mathbf{U}) \cdot \mathbf{r}_k(\mathbf{U}) \neq 0.$$

Genuine nonlinearity is essential for the existence of *centered rarefaction waves*, continuous scale-invariant solutions $\mathbf{U}(x, t) = \mathbf{V}(\frac{x}{t})$, where $\mathbf{V} : \mathbb{R} \rightarrow \mathbb{R}^n$. Substituting this form into (14.19), we find

$$\left(-\frac{x}{t^2}\right) \mathbf{V}' + \left(\frac{1}{t}\right) d\mathbf{F}(\mathbf{V})\mathbf{V}' = 0.$$

Multiplying by t and letting $\xi = \frac{x}{t}$, we then have

$$-\xi \mathbf{V}'(\xi) + d\mathbf{F}(\mathbf{V})\mathbf{V}'(\xi) = 0. \quad (14.20)$$

Hence, ξ is an eigenvalue of $d\mathbf{F}(\mathbf{V})$, and \mathbf{V}' is an eigenvector:

$$\xi = \lambda_k(\mathbf{V}(\xi)), \quad \mathbf{V}'(\xi) = \mathbf{r}_k(\mathbf{V}(\xi)) \quad (14.21)$$

for some $k = 1, \dots, n$. Thus, $\mathbf{V}(\xi)$ lies on an integral curve of $\mathbf{r}_k(\mathbf{U})$. (See [Appendix C](#).) Moreover, ξ and λ_k increase together, so the integral curve is oriented so that $\lambda_k(\mathbf{U})$ increases as \mathbf{U} moves along the curve.

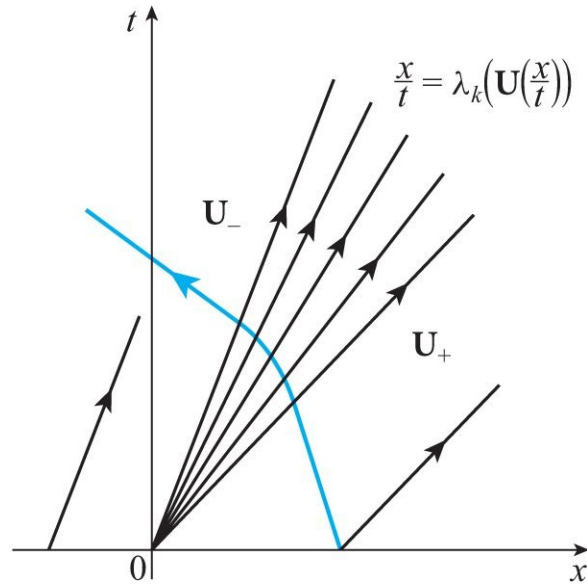

Figure 14.4. Centered rarefaction wave for the k th characteristic field.

The corresponding rays $\frac{x}{t} = \xi$ in the x - t plane are k -characteristics: $\frac{x}{t} = \lambda_k(\mathbf{V}(\frac{x}{t}))$. If we differentiate the first equation in (14.21) with respect to ξ and use the second equation, we find a directional derivative:

$$d\lambda_k(\mathbf{V}) \cdot \mathbf{r}_k(\mathbf{V}) = 1. \quad (14.22)$$

We can interpret (14.22) as determining the magnitude of the eigenvector \mathbf{r}_k ; it also includes the choice of sign so that \mathbf{r}_k points in the direction of increasing characteristic speed.

We next relate the oriented integral curve to the rarefaction wave that continuously connects a constant \mathbf{U}_- to a constant \mathbf{U}_+ , as shown in [Figure 14.4](#). In the figure, the straight lines are k -characteristics, and the curved line is a characteristic of a different field. The solution is continuous even at the edges of the fan, since the trailing edge of the wave is constructed to have speed $\lambda_k(\mathbf{U}_-)$, and the leading edge has speed $\lambda_k(\mathbf{U}_+)$. The characteristic speed has to increase through the rarefaction wave. (In the figure, the slopes of the characteristics decrease). We define the *rarefaction curve* $R_k(\mathbf{U}_-)$ through \mathbf{U}_- to be the half of the integral curve through \mathbf{U}_- on which the characteristic speed increases from $\lambda_k(\mathbf{U}_-)$. Then \mathbf{U}_- can be connected to any $\mathbf{U}_+ \in R_k(\mathbf{U}_-)$ with a rarefaction wave. In particular, we have

$$\lambda_k(\mathbf{U}_-) \leq \xi = \lambda_k(\mathbf{V}(\xi)) \leq \lambda_k(\mathbf{U}_+). \quad (14.23)$$

Note that characteristics of the other eigenvalues are not straight as they pass through the rarefaction wave, as illustrated in the figure with a characteristic

moving left, accelerating as it passes through the wave.

Example 2. (Rarefaction waves for the p -system) Let's work out the details for the p -system. Here we have

$$\lambda_{\pm}(u) = \pm\sqrt{\sigma'(u)}, \quad \mathbf{r}_{\pm}(u) = a \begin{pmatrix} 1 \\ \mp\sqrt{\sigma'(u)} \end{pmatrix}, \quad d\lambda_{\pm}(u) = \begin{pmatrix} \pm\frac{\sigma''(u)}{\sqrt{\sigma'(u)}} \\ 0 \end{pmatrix}.$$

Thus, the p -system is genuinely nonlinear (in both characteristic fields) if and only if $\sigma''(u) \neq 0$. In this case, we normalize $\mathbf{r}_{\pm}(u)$ by choosing $a = \pm\sqrt{\sigma'(u)}/\sigma''(u)$, so that (14.22) is satisfied. For a rarefaction wave, we have from (14.21),

$$\begin{pmatrix} u' \\ v' \end{pmatrix} = \mathbf{r}_{\pm}(u),$$

which is more conveniently written as

$$\frac{dv}{du} = \mp\sqrt{\sigma'(u)}.$$

Thus,

$$v = v_{-} \mp \int_{u_{-}}^u \sqrt{\sigma'(w)} dw. \quad (14.24)$$

In particular, for a rarefaction from (u_{-}, v_{-}) to (u_{+}, v_{+}) , we must have

$$v_{+} = v_{-} \mp \int_{u_{-}}^{u_{+}} \sqrt{\sigma'(w)} dw.$$

For the characteristic speed to increase through the rarefaction wave (see Fig. 14.4), we must satisfy (14.23), which for the p -system becomes

$$\pm\sqrt{\sigma'(u_{-})} \leq \pm\sqrt{\sigma'(u)} \leq \pm\sqrt{\sigma'(u_{+})}$$

for u between u_{-}, u_{+} .

We get more information about the slope and curvature of the rarefaction curves by differentiating (14.24): $v'(u) = \mp\sqrt{\sigma'(u)}$, $v''(u) = \mp\frac{1}{2}\sigma''(u)/\sqrt{\sigma'(u)}$. For example, if $\sigma''(u) > 0$, then for a forward rarefaction wave (i.e., with positive speed), we must have $u_{+} > u_{-}$, whereas for a backward wave (with negative speed), we have $u_{-} > u_{+}$. The corresponding values of u_{+}, v_{+} lie on the rarefaction curves $R_{\pm}(u_{-}, v_{-})$, shown in the u - v plane in Figure 14.5a. If $\sigma''(u) < 0$, for example, as shown in Figure 14.1 near $u = 1$, then the configuration changes to that in Figure 14.5b. We shall use the rarefaction curves shown in Figure 14.5 to solve the Riemann problem after we have discussed shock waves and shock curves in Section 14.2.7.

14.2.5. Propagation of Singularities

The edges of a rarefaction wave have discontinuities in the derivative of the solution, even though the function itself is continuous. By construction, these singularities propagate along characteristics. Here we prove the more general result for continuous solutions of (14.19) that jumps in the derivative lie on characteristics.

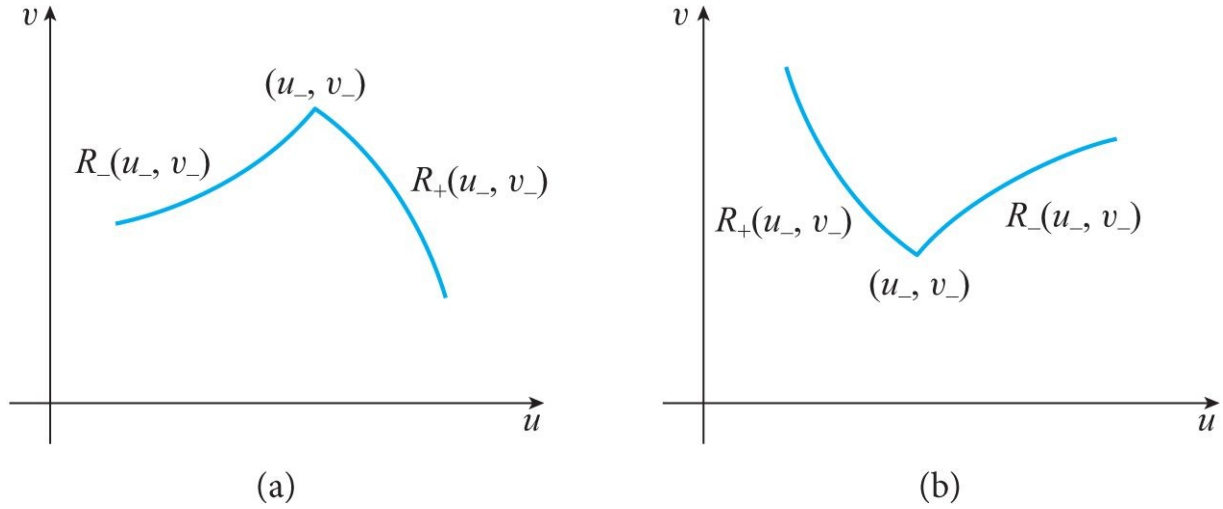

Figure 14.5. Rarefaction curves for the p -system. (a) $\sigma''(u) > 0$; (b) $\sigma''(u) < 0$.

Theorem 14.2. Consider a function $\mathbf{U} : \mathbb{R} \times (0, \infty) \rightarrow \mathbb{R}^n$ that is continuous and is C^1 except on a C^1 curve $\Gamma : x = \gamma(t)$. Suppose that derivatives $\partial_x \mathbf{U}, \partial_t \mathbf{U}$ have left and right limits $\partial_x \mathbf{U}(\gamma(t)^\pm, t), \partial_t \mathbf{U}(\gamma(t)^\pm, t)$ that vary continuously on Γ , and that $\mathbf{U}(x, t)$ satisfies the PDE (14.19) for (x, t) not on Γ . Then

1. the curve Γ is a characteristic: $\frac{d\gamma}{dt} = \lambda_k(\mathbf{U}(\gamma(t), t))$ for some $k = 1, \dots, n$, and
2. the jump $[\partial_x \mathbf{U}](t) = \partial_x \mathbf{U}(\gamma(t)^+, t) - \partial_x \mathbf{U}(\gamma(t)^-, t)$ is parallel to the corresponding right eigenvector: $[\partial_x \mathbf{U}](t) = \eta(t) \mathbf{r}_k(\mathbf{U}(\gamma(t), t))$ for some $\eta(t) \in \mathbb{R}$.

Proof. From (14.19) we have

$$\mathbf{U}_t + d\mathbf{F}(\mathbf{U})\mathbf{U}_x = 0, \tag{14.25}$$

and by continuity, (14.25) holds with $\mathbf{U}_t = \mathbf{U}_t(\gamma(t)^\pm, t), \mathbf{U}_x = \mathbf{U}_x(\gamma(t)^\pm, t)$. Thus,

$$[\partial_t \mathbf{U}](t) + d\mathbf{F}(\mathbf{U}(\gamma(t), t))[\partial_x \mathbf{U}](t) = 0. \tag{14.26}$$

Moreover, differentiating the identity

$$\mathbf{U}(\gamma(t)^+, t) = \mathbf{U}(\gamma(t)^-, t),$$

we have

$$\mathbf{U}_x^+ \dot{\gamma} + \mathbf{U}_t^+ = \mathbf{U}_x^- \dot{\gamma} + \mathbf{U}_t^-,$$

where $\mathbf{U}_x^\pm = \mathbf{U}_x(\gamma(t)^\pm, t), \mathbf{U}_t^\pm = \mathbf{U}_t(\gamma(t)^\pm, t)$, and $\dot{\gamma} = \frac{d\gamma}{dt}$. It follows that

$$[\partial_x \mathbf{U}](t)\dot{\gamma} + [\partial_t \mathbf{U}](t) = 0.$$

Substituting for $[\partial_t \mathbf{U}](t)$ from (14.26), we find

$$[\partial_x \mathbf{U}](t)\dot{\gamma} - d\mathbf{F}(\mathbf{U}(\gamma(t), t))[\partial_x \mathbf{U}](t) = 0.$$

Thus, $\dot{\gamma}$ is an eigenvalue of $d\mathbf{F}(\mathbf{U})$, and $[\partial_x \mathbf{U}]$ is a corresponding eigenvector. The theorem now follows. ■

We now discuss shock waves for hyperbolic systems, beginning with the formation of shocks for 2×2 systems.

14.2.6. Shock Formation

For scalar conservation laws, it is a simple calculation to identify the mechanism for formation of shocks, in which a spatial derivative blows up in finite time. There are many derivatives for systems, and the analysis is not so simple as it was for scalar equations. Here we show the calculation by Lax [33] for systems of two conservation laws with smooth initial data that are constant outside an interval. Lax's calculation was generalized to systems of $n \geq 3$ equations by John [27] under similar conditions on the initial data. Lax's calculation relies on uniquely defined Riemann invariants, but for $n \geq 3$, each characteristic field has $n - 1$ independent Riemann invariants. John's analysis instead relies on a decomposition of \mathbf{U}_x into characteristic fields, thereby defining generalized Riemann invariants, whose propagation and interaction can be tracked much as Lax does with the calculation in this section.

For $n = 2$, we let $\mathbf{U} = (u, v)$, and write system (14.19) as

$$\begin{pmatrix} u \\ v \end{pmatrix}_t + \begin{pmatrix} f(u, v) \\ g(u, v) \end{pmatrix}_x = 0. \quad (14.27)$$

Let $\lambda(r, s), \mu(r, s)$ be the characteristic speeds, in terms of the Riemann invariants r, s . Then system (14.27) is partially diagonalized:

$$\begin{aligned} r_t + \lambda(r, s)r_x &= 0, \\ s_t + \mu(r, s)s_x &= 0. \end{aligned} \quad (14.28)$$

Here we have $\nabla r(u, v) \cdot \mathbf{r}_\mu = 0$ and $\nabla s(u, v) \cdot \mathbf{r}_\lambda = 0$. Mimicking the scalar case, we differentiate (14.28) with respect to x and define $p = r_x, q = s_x$:

$$\begin{aligned} p_t + \lambda(r, s)p_x &= -\lambda_r p^2 - \lambda_s pq, \\ q_t + \mu(r, s)q_x &= -\mu_r pq - \mu_s q^2. \end{aligned} \quad (14.29)$$

The difficulty lies in the pq term in each equation, representing the interaction of waves. Let's focus on the equation for p .

Define differentiation along the λ characteristic by $\dot{u} = u_t + \lambda u_x$. Then $\dot{r} = 0$ and $\dot{s} = (\lambda - \mu)s_x$. This last equation yields

$$q = \frac{\dot{s}}{\lambda - \mu}.$$

Then we can rewrite the first equation in (14.29) as

$$\dot{p} + \frac{\lambda_s}{\lambda - \mu} \dot{s} p = -\lambda_r p^2. \quad (14.30)$$

Now we use an integrating factor to collapse the left-hand side. Define a function $h(r, s)$ so that $h_s = \frac{\lambda_s}{\lambda - \mu}$. Then $\dot{h} = h_r \dot{r} + h_s \dot{s} = h_s \dot{s}$, since $\dot{r} = 0$. Consequently, if we let $z(t) = e^h p$, (14.30) becomes

$$\dot{z} = -\lambda_r e^{-h} z^2. \quad (14.31)$$

If the coefficient $\lambda_r e^{-h}$ were constant, we could write the solution of the Riccati equation (14.31) explicitly. However, in general we have little information about the dependence of this coefficient on the solution. Nonetheless, we can use a comparison argument to show that solutions of (14.31) blow up in finite time, provided the coefficient is bounded and we assume genuine nonlinearity.

Consider bounded smooth C^1 initial conditions for (14.27). Then the Riemann invariants remain bounded, and as long as their derivatives stay bounded, the solution of the initial value problem is defined and smooth, and $h(r, s)$ is bounded.

We assume that the λ characteristic field is genuinely nonlinear, so that $\lambda_r \neq 0$. Then the coefficient $\lambda_r e^{-h}$ is bounded above and below on the same side of zero. Let's take $\lambda_r > 0$. Then there are constants A, B such that $0 < A < \lambda_r e^{-h} < B$. Consider a specific λ -characteristic originating from $x = x_0$ at $t = 0$. Then $z(0) = z_0$ is a specific number given by the initial data at x_0 . We can compare the solution $z(t)$ of (14.31) with solutions of the initial value problems

$$X' = -AX^2, X(0) = z_0; \quad Y' = -BY^2, Y(0) = z_0.$$

Since A, B are constants, we have solutions

$$X(t) = \frac{z_0}{1 + Az_0 t}, \quad Y(t) = \frac{z_0}{1 + Bz_0 t}.$$

Now suppose $z_0 < 0$. Then $Y'(t) < z'(t) < X'(t)$ for $t \geq 0$. To see this, first observe that it is true at $t = 0$, so by continuity it remains true for a short time. But then $Y(t) < z(t) < X(t) < 0$, so the inequality on derivatives persists, and so does the comparison of the solutions. Since $X(t) \rightarrow -\infty$ as $t \rightarrow -1/(Az_0)$, we

conclude that $z(t) \rightarrow -\infty$ also, as $t \rightarrow t^*$, for some $t^* \leq -1/(Az_0)$. Let $z_m = \min z_0 < 0$, where the minimum is taken over the initial points x_0 . Then the solution of the system (14.27) has derivatives that blow up in finite time $t_m \leq -1/(Az_m)$. In contrast, we also have conditions under which the derivatives of the solution stay bounded. If $\lambda_r z_0 > 0$, then $z(t)$ stays bounded and decays to zero as $t \rightarrow \infty$.

Just as for scalar conservation laws, we presume that as a derivative of the solution becomes infinite, the weak solution continues with a shock wave. Next we analyze shock waves explicitly.

14.2.7. Weak Solutions and Shock Waves

Here we formalize the definition of weak solution of the system of conservation laws. The definition resembles that of weak solutions of linear elliptic equations in that it is based on integration by parts, or equivalently, by distribution solutions that are integrable.

It is convenient to define weak solutions of the Cauchy problem, consisting of (14.19) with initial condition

$$\mathbf{U}(x, 0) = \mathbf{U}_0(x). \quad (14.32)$$

To derive the appropriate weak formulation of the Cauchy problem, consider a smooth solution $\mathbf{U}(x, t)$, with smooth initial data \mathbf{U}_0 . To incorporate the initial condition into the weak formulation, we define test functions $\varphi \in C_c^1(\mathbb{R} \times [0, \infty) \rightarrow \mathbb{R})$ to have compact support in the upper half-plane, including the x -axis. That is, φ can be nonzero in a bounded subset of the x -axis. Note that here we only require the test functions to be C^1 , but we could just as well consider C^∞ test functions.

Multiply (14.19) by φ and integrate by parts, observing that $\mathbf{U}_t + \mathbf{F}_x = \text{div}(\mathbf{F}, \mathbf{U})$, and the operation applies to each component of the vector-valued functions. This calculation leads to the relation

$$\begin{aligned} \int_0^\infty \int_{\mathbb{R}} (\varphi_t(x, t)\mathbf{U}(x, t) + \varphi_x(x, t)\mathbf{F}(\mathbf{U}(x, t))) \, dx \, dt \\ + \int_{\mathbb{R}} \varphi(x, 0)\mathbf{U}_0(x) \, dx = 0, \end{aligned} \quad (14.33)$$

in which the final integral is zero unless the support of $\varphi(x, 0)$ includes part of the x -axis.

Motivated by this calculation, we define a function $\mathbf{U} \in L^\infty(\mathbb{R} \times [0, \infty) \rightarrow \mathbb{R}^n)$ to be a *weak solution* of the Cauchy problem (14.19), (14.32) if (14.33) holds for all $\varphi \in C_c^1(\mathbb{R} \times [0, \infty) \rightarrow \mathbb{R})$

Note that the idea of integrating by parts to obtain an integral identity for weak solutions, using test functions, was previously used for elliptic equations. (See (11.8) in Chapter 11.) However, for second-order equations we assumed that the weak solution had a derivative in L^2 , whereas here we want to allow jump discontinuities, whose derivatives are distributions but not in L^2 . Consequently, we consider functions in L^∞ . This definition of weak solution of systems of conservation laws applies to scalar equations, but we did not use the generality of the definition in the previous chapter.

Next we use the definition to characterize weak solutions of (14.19) that have jump discontinuities across a curve Γ .

Theorem 14.3. *Suppose that $\mathbf{U} : \mathbb{R} \times (0, \infty) \rightarrow \mathbb{R}^n$ is a weak solution that is C^1 except on a C^1 curve $\Gamma : x = \gamma(t)$. Suppose the left and right limits $\mathbf{U}^\pm(t) = \mathbf{U}(\gamma(t) \pm, t)$ vary continuously on Γ . Then these limits satisfy the Rankine-Hugoniot conditions*

$$\dot{\gamma}(t) (\mathbf{U}^+(t) - \mathbf{U}^-(t)) = \mathbf{F}(\mathbf{U}^+(t)) - \mathbf{F}(\mathbf{U}^-(t)). \quad (14.34)$$

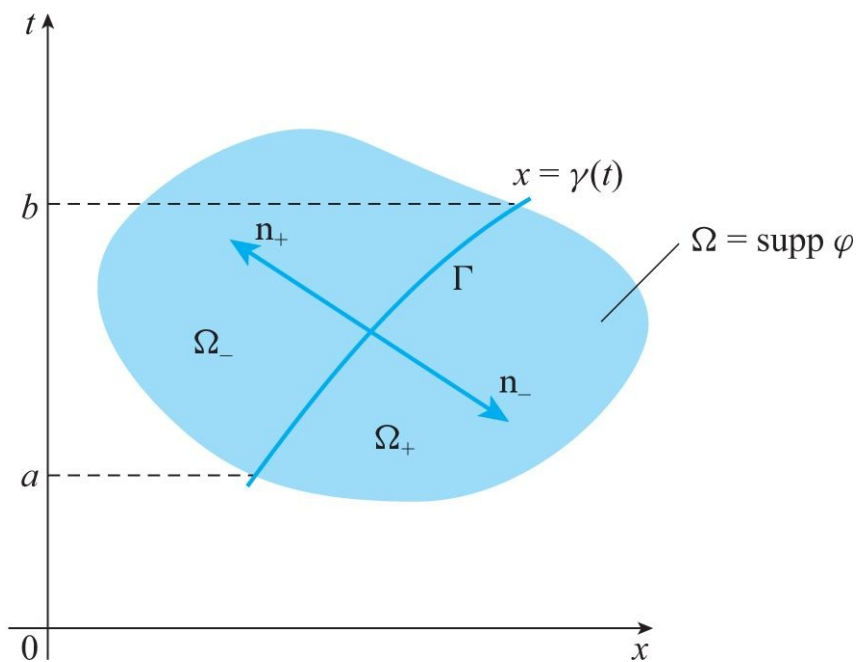

Figure 14.6. Domain of integration for a shock.

Proof. Let φ be a test function with support Ω in $t > 0$ that is divided into two disjoint sets Ω^\pm by the curve Γ , as indicated in Figure 14.6. Since \mathbf{U} is a weak solution, it satisfies (14.33), which we rewrite as

$$\int_{\Omega^-} (\varphi_t \mathbf{U} + \varphi_x \mathbf{F}(\mathbf{U})) \, dx \, dt + \int_{\Omega^+} (\varphi_t \mathbf{U} + \varphi_x \mathbf{F}(\mathbf{U})) \, dx \, dt = 0. \quad (14.35)$$

Now integrate by parts in Ω^\pm separately, to put the derivatives back on \mathbf{U} and $\mathbf{F}(\mathbf{U})$. In this process, we are left with only boundary terms, since $\mathbf{U}_t + \mathbf{F}(\mathbf{U})_x = 0$

in each of Ω^\pm . Since φ vanishes on the boundary of Ω^\pm except on Γ , the only contribution remaining comes from the integrals on $\Gamma \cap \Omega$. We need the unit outward normals on $x = \gamma(t)$, which are given by

$$\mathbf{n}_\pm = \pm \eta(1, -\dot{\gamma})$$

on $\partial\Omega^\pm$, respectively, where $\eta = (1 + \dot{\gamma}^2)^{-\frac{1}{2}}$. As a result, we obtain n equations, one equation from each component of (14.35):

$$\begin{aligned} & \int_{\Gamma \cap \Omega} \varphi(\gamma(t), t) \left(-\dot{\gamma}(t) \mathbf{U}^+(t) + \mathbf{F}(\mathbf{U}^+(t)) \right) ds \\ & + \int_{\Gamma \cap \Omega} \varphi(\gamma(t), t) \left(\dot{\gamma}(t) \mathbf{U}^-(t) - \mathbf{F}(\mathbf{U}^-(t)) \right) ds = 0. \end{aligned}$$

That is, if $\Gamma \cap \Omega = \{x = \gamma(t) : a < t < b\}$, then we have

$$\int_a^b \varphi(\gamma(t), t) \left(-\dot{\gamma}(t) [\mathbf{U}](t) + [\mathbf{F}(\mathbf{U})](t) \right) dt = 0.$$

Consequently, since φ is arbitrary and the integrand is continuous, we obtain the Rankine-Hugoniot conditions (14.34). ■

14.2.8. Analysis of the Rankine-Hugoniot Conditions Using Bifurcation Theory

To understand the jump conditions more thoroughly, it is useful to consider piecewise-constant solutions, or shock waves

$$\mathbf{U}(x, t) = \begin{cases} \mathbf{U}_-, & \text{if } x < st, \\ \mathbf{U}_+, & \text{if } x > st, \end{cases} \quad (14.36)$$

in which s is the shock speed. We say \mathbf{U} given by (14.36) is a shock from \mathbf{U}_- to \mathbf{U}_+ if s , \mathbf{U}_\pm are related by the Rankine-Hugoniot conditions (14.34):

$$-s(\mathbf{U}_+ - \mathbf{U}_-) + \mathbf{F}(\mathbf{U}_+) - \mathbf{F}(\mathbf{U}_-) = 0. \quad (14.37)$$

This system of n equations in $2n + 1$ unknowns has one easy family of solutions, the *trivial solution*: $\mathbf{U}_+ = \mathbf{U}_-$, s arbitrary. But this corresponds to constant solutions of the PDE. We seek nontrivial solutions, for which there really is a discontinuity.

Our approach to this problem derives from *bifurcation theory*, the analysis of the branching of curves of solutions of nonlinear equations [8, 19]. To set this approach up, we fix \mathbf{U}_- and let $\mathbf{G}(\mathbf{U}_+, s)$ denote the left-hand side of (14.37). That is, $\mathbf{G} : \mathbb{R}^n \times \mathbb{R} \rightarrow \mathbb{R}^n$ is defined by

$$\mathbf{G}(\mathbf{U}, s) = -s(\mathbf{U} - \mathbf{U}_-) + \mathbf{F}(\mathbf{U}) - \mathbf{F}(\mathbf{U}_-).$$

Then we have

$$\mathbf{G}(\mathbf{U}_-, s) = 0 \quad \text{for all } s \in \mathbb{R}, \quad \text{and} \quad d_{\mathbf{U}}G(\mathbf{U}_-, s) = -s\mathbf{I} - d\mathbf{F}(\mathbf{U}_-).$$

Here are two basic results of the theory, stated informally:

1. *Bifurcation points are eigenvalues of the linearized problem.* Nontrivial solutions can only branch off the curve $\{(\mathbf{U}_-, s) : s \in \mathbb{R}\}$ of trivial solutions at eigenvalues $s = \lambda_k(\mathbf{U}_-)$ of the linearization $d\mathbf{F}(\mathbf{U}_-)$.
2. *Bifurcation from a simple eigenvalue gives a curve of solutions.* If the eigenvalue $s = \lambda_k(\mathbf{U}_-)$ is simple, then there is a curve of nontrivial solutions passing through $(\mathbf{U}, s) = (\mathbf{U}_-, \lambda_k(\mathbf{U}_-))$.

The first result is a simple consequence of the Implicit Function Theorem. Suppose s_0 is not an eigenvalue. Then $d_{\mathbf{U}}G(\mathbf{U}_-, s_0) = -s_0\mathbf{I} - d\mathbf{F}(\mathbf{U}_-)$ is invertible. By the Implicit Function Theorem, there is a curve of solutions $\mathbf{U} = \mathbf{U}(s)$ for s near s_0 . Moreover, no other solutions exist in a neighborhood of (\mathbf{U}_-, s_0) . But $\mathbf{U} = \mathbf{U}_-$ is a solution for all s , so we must have $\mathbf{U}(s) \equiv \mathbf{U}_-$.

The second result is also a consequence of the Implicit Function Theorem, but it requires much more careful analysis. It appeared in various forms in the late 1960s and early 1970s, culminating in the 1971 paper of Crandall and Rabinowitz [11]. The basic idea of the proof is to solve for $n - 1$ components of \mathbf{U} as a function of s and a small variable ϵ representing the remaining component $\epsilon \mathbf{r}_k(\mathbf{U}_-)$. This construction uses the Implicit Function Theorem in a straightforward way on a system of $n - 1$ equations obtained by projecting the original system onto the range of $d_{\mathbf{U}}G(\mathbf{U}_-, \lambda_k(\mathbf{U}_-))$. The problem is thereby reduced to a single equation $f(s, \epsilon) = 0$, called the *bifurcation equation*. This reduction process to arrive at the bifurcation equation is known as the *Lyapunov-Schmidt reduction*. Locally, there are two curves of solutions of the bifurcation equation. Zeroes of f are $\{(s, \epsilon) = (s, 0)\}$, forming the curve of trivial solutions, and a function $s = \hat{s}(\epsilon)$, giving the curve of nontrivial solutions corresponding to shock wave solutions.

Here is the precise result, which we state without proof.

Theorem 14.4. *Suppose \mathbf{F} is C^m , $m \geq 2$, and the PDE (14.19) is strictly hyperbolic in a neighborhood of \mathbf{U}_- . Then for each $k = 1, \dots, n$, there exist $\delta > 0$ and C^{m-1} functions $\tilde{\mathbf{U}}_+ : (-\delta, \delta) \rightarrow \mathbb{R}^n$, $\tilde{s} : (-\delta, \delta) \rightarrow \mathbb{R}$ that are C^m away from zero and are such that*

1. *the property $\tilde{\mathbf{U}}_+(0) = \mathbf{U}_-$, $\tilde{s}(0) = \lambda_k(\mathbf{U}_-)$ holds;*
2. *the identity $-\tilde{s}(\xi)(\tilde{\mathbf{U}}_+(\xi) - \mathbf{U}_-) + \mathbf{F}(\tilde{\mathbf{U}}_+(\xi)) - \mathbf{F}(\mathbf{U}_-) = 0$ $|\xi| < \delta$ holds; and*

3. *there is a neighborhood $\mathbf{N} \subset \mathbb{R}^n \times \mathbb{R}$ of $(\mathbf{U}_-, \lambda_k(\mathbf{U}_-))$ such that if $(\mathbf{U}, s) \in \mathbf{N}$ satisfies (14.37), then either $\mathbf{U} = \mathbf{U}_-$, or $\mathbf{U} = \tilde{\mathbf{U}}_+(\xi)$ and $s = \tilde{s}(\xi)$ for some $\xi \in (-\delta, \delta)$.*

We use the theorem to establish some properties of weak shock waves, in which the jump in \mathbf{U} is small. Following the calculation of Lax [32], we differentiate identity 2 twice and set $\xi = 0$. Differentiating once, we have

$$-\tilde{s}'(\tilde{\mathbf{U}}_+ - \mathbf{U}_-) - \tilde{s}\tilde{\mathbf{U}}'_+ + d\mathbf{F}(\tilde{\mathbf{U}}_+)\tilde{\mathbf{U}}'_+ = 0, \quad (14.38)$$

so that, setting $\xi = 0$ and using property 1, we get

$$-\lambda_k(\mathbf{U}_-)\tilde{\mathbf{U}}'_+(0) + d\mathbf{F}(\mathbf{U}_-)\tilde{\mathbf{U}}'_+(0) = 0.$$

We deduce that $\tilde{\mathbf{U}}'_+(0) = \mathbf{r}_k(\mathbf{U}_-)$, where we have rescaled the parameter ξ so that the scalar multiple of $\mathbf{r}_k(\mathbf{U}_-)$ is unity. (Recall that $\mathbf{r}_k(\mathbf{U}_-)$ is normalized by (14.22).)

Differentiating (14.38) again, and setting $\xi = 0$, we get

$$-2\tilde{s}'\mathbf{r}_k(\mathbf{U}_-) - \lambda_k(\mathbf{U}_-)\tilde{\mathbf{U}}''_+ + d^2\mathbf{F}(\mathbf{U}_-)(\mathbf{r}_k(\mathbf{U}_-), \mathbf{r}_k(\mathbf{U}_-)) + d\mathbf{F}(\tilde{\mathbf{U}}_+)\tilde{\mathbf{U}}''_+ = 0,$$

where $d^2\mathbf{F}(\mathbf{U}_-) : \mathbb{R}^n \times \mathbb{R}^n \rightarrow \mathbb{R}^n$ is the bilinear operator involving second derivatives of \mathbf{F} that appears in the Taylor series expansion of $\mathbf{F}(\mathbf{U})$ about $\mathbf{U} = \mathbf{U}_-$. (See Appendix A for the Taylor series of a scalar function of several variables; the bilinear operator puts these terms into a vector-valued function.)

Now we can eliminate the second derivatives of by projecting onto the $\tilde{\mathbf{U}}_+$ complement of the range of $-\lambda_k(\mathbf{U}_-)\mathbf{I} + d\mathbf{F}(\tilde{\mathbf{U}}_+)$. This is most easily accomplished by taking the inner product (scalar product) of the equation with the left eigenvector $\ell_k(\mathbf{U}_-)$:

$$-(\ell_k(\mathbf{U}_-), 2\tilde{s}'\mathbf{r}_k(\mathbf{U}_-)) + \left(\ell_k(\mathbf{U}_-), d^2\mathbf{F}(\mathbf{U}_-)(\mathbf{r}_k(\mathbf{U}_-), \mathbf{r}_k(\mathbf{U}_-)) \right) = 0.$$

Thus, we have

$$\tilde{s}'(0) = \frac{1}{2} \left(\ell_k(\mathbf{U}_-), d^2\mathbf{F}(\mathbf{U}_-)(\mathbf{r}_k(\mathbf{U}_-), \mathbf{r}_k(\mathbf{U}_-)) \right) = \frac{1}{2} d\lambda_k(\mathbf{U}_-) \cdot \mathbf{r}_k(\mathbf{U}_-). \quad (14.39)$$

To verify the final equality, we differentiate the identity

$$d\mathbf{F}(\tilde{\mathbf{U}}_+)\mathbf{r}_k(\tilde{\mathbf{U}}_+) = \lambda_k(\tilde{\mathbf{U}}_+)\mathbf{r}_k(\tilde{\mathbf{U}}_+)$$

with respect to ξ and let $\xi = 0$.

From (14.39), we deduce that

$$\tilde{s}'(0) = \frac{1}{2} \frac{d}{d\xi} \lambda_k(\tilde{\mathbf{U}}_+(\xi)) \Big|_{\xi=0}. \quad (14.40)$$

Now suppose the k th characteristic field is genuinely nonlinear at \mathbf{U}_- , and normalize $\mathbf{r}_k(\mathbf{U}_-)$ as for rarefaction waves (see (14.22)). Then, $\tilde{s}'(0) = 1/2$ and for ξ near zero, we have

$$\lambda_k(\tilde{\mathbf{U}}_+(\xi)) < \tilde{s}(\xi) < \lambda_k(\mathbf{U}_-), \quad (14.41)$$

if and only if $\xi < 0$. This inequality is highly significant in terms of the Lax entropy condition that we arrive at in the next section, where we state the condition for systems of conservation laws. The consequence is that for weak shocks (in which $|\mathbf{U}_+ - \mathbf{U}_-|$ is small) only half of the branch of solutions, the half with $s < \lambda_k(\mathbf{U}_-)$, corresponds to shocks that are admissible according to the Lax entropy condition.

14.2.9. Admissibility of Shock Waves and the Riemann Problem

Much of the theory of weak solutions of hyperbolic conservation laws, for both scalar equations and systems, is centered on understanding solutions of the *Riemann problem*. This is the initial value problem

$$\begin{aligned} \mathbf{U}_t + \mathbf{F}(\mathbf{U})_x &= 0, \\ \mathbf{U}(x, 0) &= \begin{cases} \mathbf{U}_L, & \text{if } x < 0, \\ \mathbf{U}_R, & \text{if } x > 0, \end{cases} \end{aligned} \quad (14.42)$$

where $\mathbf{U}_L, \mathbf{U}_R$ are given constants (in \mathbb{R}^n). We will build scale-invariant solutions $\mathbf{U} = \mathbf{U}(\frac{x}{t})$ of the Riemann problem from centered rarefaction waves and shock waves, separated by regions where $\mathbf{U}(x, t)$ is constant. For now, let's focus on a single shock wave, joining constants \mathbf{U}_- on the left and \mathbf{U}_+ on the right.

Just as for the inviscid Burgers equation, if we allow all shock waves (satisfying the Rankine-Hugoniot conditions (14.34)), then solutions are not unique. We correct this lack of uniqueness by imposing an additional condition on shock waves, just as was done for scalar equations. The most fundamental such admissibility condition is the Lax entropy condition.

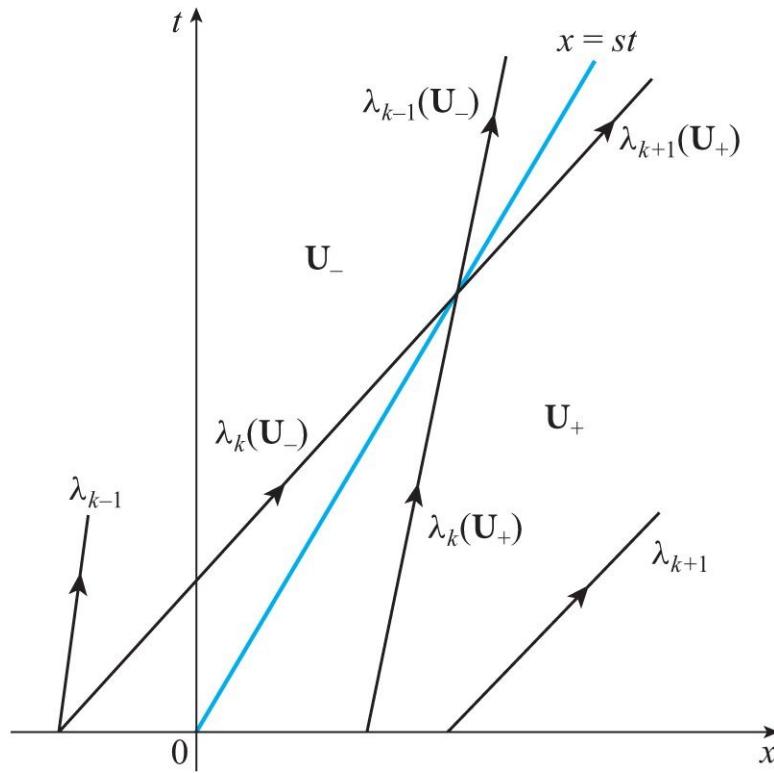

Figure 14.7. A k -shock with representative characteristics satisfying the Lax entropy condition.

We say the shock wave from \mathbf{U}_- to \mathbf{U}_+ with speed s (see (14.36)) is *admissible according to the Lax entropy condition* if the following inequalities hold for some $k = 1, \dots, n$:

$$\lambda_k(\mathbf{U}_+) < s < \lambda_k(\mathbf{U}_-), \quad (14.43a)$$

$$\lambda_{k-1}(\mathbf{U}_-) < s < \lambda_{k+1}(\mathbf{U}_+). \quad (14.43b)$$

Here we define $\lambda_0 = -\infty$ and $\lambda_{n+1} = \infty$, so that these inequalities make sense for $k = 1$ and $k = n$. The Lax entropy inequalities require that the k th characteristics enter the shock from both sides, while all other characteristics pass through, either from left to right (the faster characteristics), or from left to right (the slower characteristics). This behavior is illustrated in Figure 14.7. We say that a shock satisfying (14.43) is a *k-shock*. Note that by continuity of the characteristic speeds, condition (14.43b) is redundant for weak shocks. Moreover, from (14.41), half of the shock curve of Theorem 14.4 consists of k -shocks, and the other half violates the Lax entropy condition.

Example 3. (Shock waves for the p -system) The Rankine-Hugoniot conditions for the p -system (see Section 14.2.1), are

$$\begin{aligned} -s(u_+ - u_-) - (v_+ - v_-) &= 0, \\ -s(v_+ - v_-) - (\sigma(u_+) - \sigma(u_-)) &= 0. \end{aligned}$$

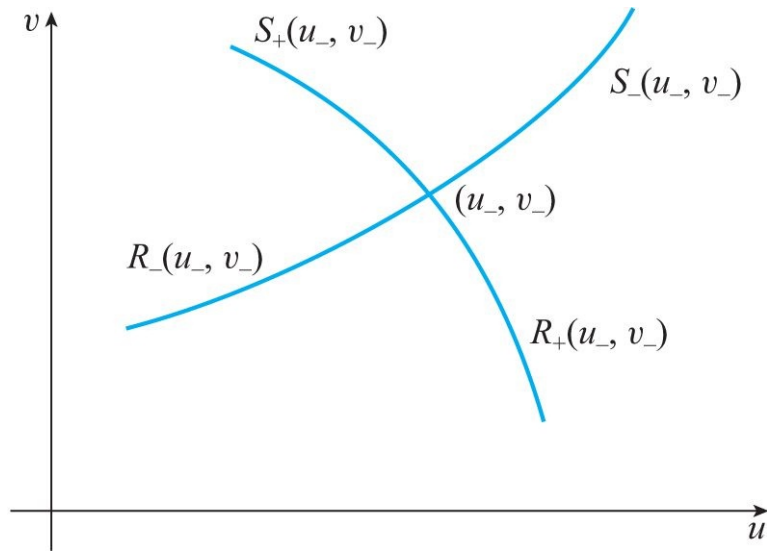

Figure 14.8. Wave curves $W_{\pm}(u_-, v_-)$ for the p -system.

Thus, we have

$$v_+ = v_- - s(u_+ - u_-), \quad s^2 = \frac{\sigma(u_+) - \sigma(u_-)}{u_+ - u_-}. \quad (14.44)$$

Note that the latter formula states that s^2 is the slope of the chord joining the points $(u_{\pm}, \sigma(u_{\pm}))$ in the graph of σ . Now let's interpret the Lax entropy inequalities (14.43). As for rarefaction waves, the sign of σ'' will make a difference. We first assume $\sigma'' > 0$. Then for forward shock waves, with $s > 0$, and $k = 2$ in (14.43a):

$$\sqrt{\sigma'(u_+)} < s < \sqrt{\sigma'(u_-)},$$

which implies $u_+ < u_-$ for $s > 0$. Note that the other condition (14.43b), $-\sqrt{\sigma'(u_-)} < s$, is automatically satisfied, since $s > 0$. For $s < 0$, we similarly conclude $u_+ > u_-$.

Now let's look at the *shock curves*, which are curves of values of (u_+, v_+) for which there is an admissible shock for some speed. We again take the case $\sigma'' > 0$. For $s > 0$, eliminating s from (14.44), we obtain a curve $S_+(u_-, v_-)$:

$$v_+ = v_- + \sqrt{(u_- - u_+)(\sigma(u_-) - \sigma(u_+))} > v_-, \quad u_+ < u_-.$$

For $s < 0$, we get the same formula, but now we have $u_+ > u_-$. This defines the shock curve $S_-(u_-, v_-)$ of backward (left-moving) shock waves. The shock curves meet the rarefaction curves of Figure 14.5 at (u_-, v_-) , forming a wave curve $W_{\pm}(u_-, v_-)$ for each characteristic family, defined by

$$W_{\pm}(u_-, v_-) = S_{\pm}(u_-, v_-) \cup R_{\pm}(u_-, v_-). \quad (14.45)$$

Finally, we can solve the Riemann problem (14.42) for the p -system using the wave curves shown in Figure 14.8. The solution of the Riemann problem is

represented in Figure 14.9. In this figure (u_L, v_L) is fixed, and we show the specific combination of waves for (u_R, v_R) in each of the quadrants separated by the wave curves $W_{\pm}(u_L, v_L)$. For example, as shown in the figure, the combination S_-R_+ indicates a backward shock (with negative speed) from (u_L, v_L) to a point $(u_M, v_M) \in S_-(u_L, v_L)$, and a forward rarefaction from (u_M, v_M) to $(u_R, v_R) \in R_+(u_M, v_M)$. The corresponding graphs of u and v are shown in Figure 14.10.

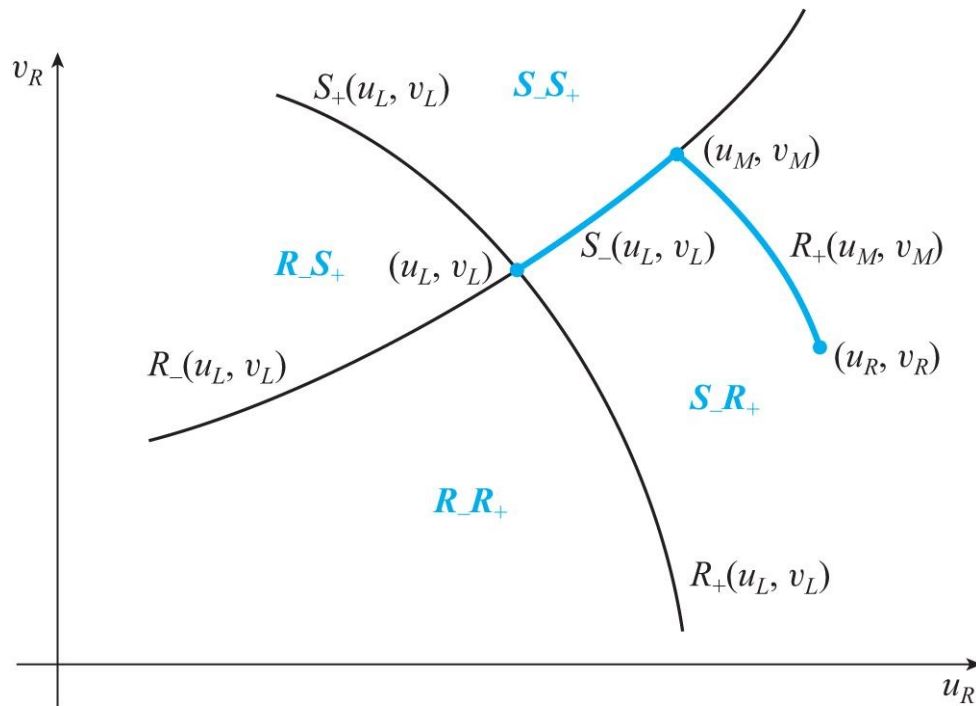

Figure 14.9. Riemann problem solution for the p -system. Four regions corresponding to different wave combinations are labeled in blue.

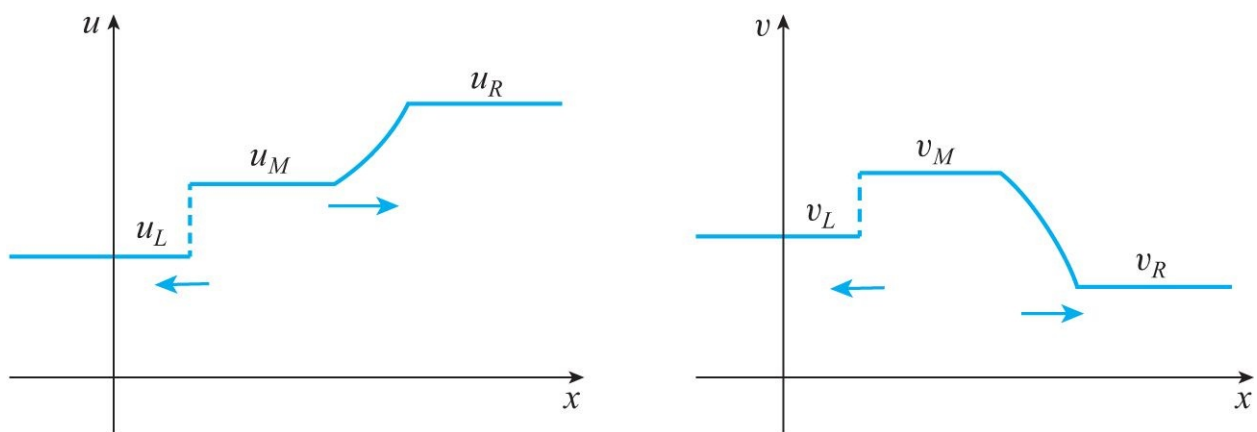

Figure 14.10. Graphs of u, v , the solution of the Riemann problem for (u_R, v_R) in the region S_-R_+ of Figure 14.9.

14.3. The Dam-Break Problem Using Shallow Water Equations

In this short section we solve an initial value problem for the shallow water equations. Consider a body of water of constant depth above a horizontal valley floor and to one side of a dam. We are concerned with what happens when the dam collapses instantaneously. We idealize the problem in a couple of ways.

First, the body of water has infinite extent, and we assume that the behavior after the dam breaks depends primarily on a single spatial variable x , along the horizontal direction perpendicular to the dam. This scenario is shown in [Figure 14.11](#). This is an example of a Riemann problem (14.42), but the system has coincident characteristic speeds when $h = 0$, to the right of the dam. When the dam breaks, water rushes to the right, drawing water from the reservoir. Hence, even though the water moves only to the right, the disturbance is felt at a point labeled $x = x_1(t)$ that travels backward into the reservoir ([Fig. 14.11c](#)). Of primary interest in this problem is the location of the leading edge $x = x_0(t)$ of the water flood, where h goes to zero.

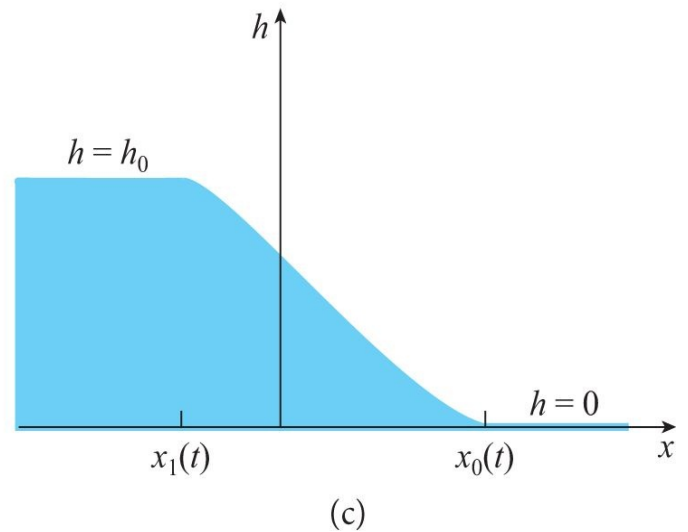
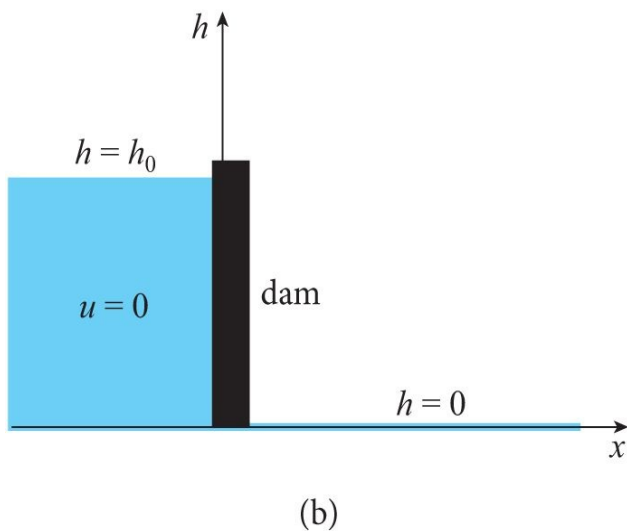
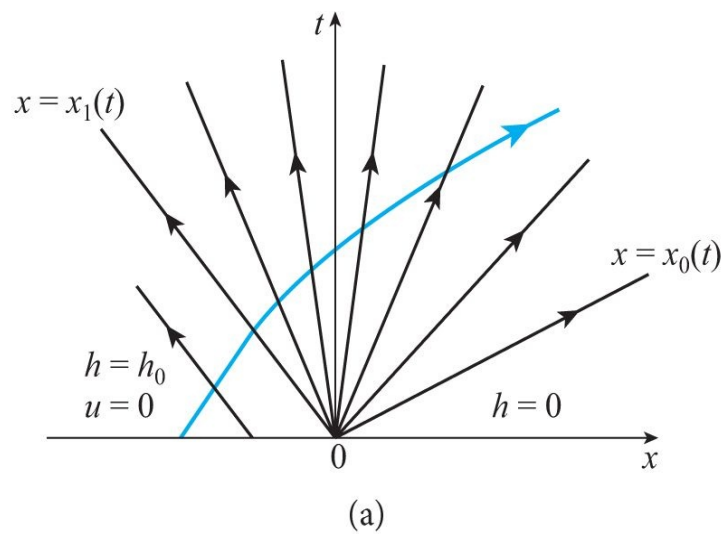

Figure 14.11. The dam-break problem. (a) The rarefaction wave; (b) the reservoir before the dam break ($t = 0$); (c) the water after the dam breaks ($t > 0$).

In [Figure 14.11](#) we show the rarefaction wave solution in the $x-t$ plane, the graph of $h(x, t)$ before the dam breaks (at $t = 0$), and the graph of $h(x, t)$ after the dam breaks (for $t > 0$). To analyze the problem fully, we start with the

equations and initial condition:

$$\begin{aligned} h_t + uh_x + hu_x &= 0, \\ u_t + uu_x + gh_x &= 0, \\ h(x, 0) &= \begin{cases} h_0 & x < 0, \\ 0 & x > 0, \end{cases} \quad u(x, 0) \equiv 0. \end{aligned}$$

It is convenient to introduce the relative speed $c = \sqrt{gh}$ (see [Section 14.2.2](#)), so that the characteristics $\lambda_{\pm} = u \pm c$ have speed c relative to the fluid velocity u . As predicted by (14.10), the Riemann invariants $w_{\pm} = u \mp 2c$ diagonalize the system

$$(\partial_t + (u \pm c)\partial_x)(u \pm 2c) = 0. \quad (14.46)$$

The curved characteristic shown in [Figure 14.11a](#) is associated with the faster speed λ_+ . The Riemann invariant $u + 2c$ is constant on this characteristic.

The rarefaction wave is associated with the slower speed λ_- , so that $u - 2c$ is constant on each characteristic, but $w_- = u + 2c$ is constant throughout the wave. To the left of the wave, $h = h_0$ and $u = 0$. Thus, the slowest characteristic is $x = x_1(t) = -c_0 t$, $c_0 = \sqrt{gh_0}$. Since $u + 2c$ is constant, we have $u + 2c = 2c_0$. Therefore, at the leading edge of the rarefaction wave, where $h = 0$ (so that $c = 0$), we have $u + 2c = u = 2c_0$. But the leading edge travels with characteristic speed $\lambda_- = u - c = 2c_0$. We conclude that the leading edge of the flood waters is located at $x = x_0(t) = 2c_0 t = 2\sqrt{gh_0} t$.

14.4. Discussion

The theory of systems of hyperbolic conservation laws is now quite extensive. In this chapter we have focused on the construction of shocks and rarefactions, and we have shown how these can be combined to solve Riemann problems. This suggests an effective approximation to solutions of the Cauchy problem, in which an initial condition

$$\mathbf{U}(x, 0) = \mathbf{U}_0(x), \quad -\infty < x < \infty,$$

is posed, with \mathbf{U}_0 an integrable and bounded function. If \mathbf{U}_0 is approximated by a piecewise-constant function, then wherever there is a jump between constants, a Riemann problem can be solved to get the exact solution for some short time interval, until adjacent waves meet. If these waves are shocks, then the interaction can be resolved by solving another Riemann problem. However, if one or both waves is a rarefaction, then these can be approximated by a small jump, or a staircase of small jumps, in which each jump satisfies the Rankine-Hugoniot condition but not the Lax entropy condition. These jumps travel with

approximately characteristic speed (as in the rarefaction they replace), and on meeting other jumps, they generate further Riemann problems. Continuing in this way, an approximate piecewise-constant solution of the Cauchy problem can be generated. Justifying the continuation and proving that this method—known as *wave front tracking*—converges requires detailed estimates of the interaction of waves and the use of suitable spaces (such as BV , the space of functions of bounded variation). Details of this approach are given in the book by Bressan [6].

A related method, involving approximations in a lattice of grid points and using randomness to capture wave speeds approximately, is known as Glimm’s random choice method. It is outlined in Glimm’s classic 1965 paper [18], in which he proves the existence of solutions of the Cauchy problem using a series of profound insights into wave interactions and convergence of approximate solutions.

In the next chapter, after a discussion of the equations of fluid mechanics, we examine the structure of the one-dimensional Euler equations. The Euler equations of inviscid compressible fluid motion form a system of hyperbolic conservation laws possessing shocks and rarefactions.

PROBLEMS

1. Check whether the shallow water equations are genuinely nonlinear.
2. Prove that system (14.17) is strictly hyperbolic for all $\xi > 1$ if $T(1) = 0$, $T'(1) > 0$, and $T(\xi)$ is a convex function: $T''(\xi) \geq 0$ for $\xi \geq 1$. Discuss the possibilities if $T(1) = 0$, $T'(1) > 0$, and T is concave: $T''(\xi) \leq 0$ for $\xi \geq 1$.
3. Let $\sigma(u) = u^2$, $u > 0$ in the p -system. Find explicit formulas for the rarefaction curves. Hence derive formulas $u = u(\frac{x}{t})$, $v = v(\frac{x}{t})$ for rarefaction waves joining $(u_-, v_-) = (1, 0)$ to (u_+, v_+) . Graph the functions u , v against x for $t = 1$.
4. Consider the system of PDE

$$\begin{aligned} u_t + (u^2 + \alpha v^2)_x &= \epsilon u_{xx}, \\ v_t - (2uv)_x &= \epsilon v_{xx}. \end{aligned} \tag{14.47}$$

- (a) Show that the system (14.47) with $\epsilon = 0$ is strictly hyperbolic for $u \neq 0$, $v \neq 0$ if $\alpha = -1$, but it fails to be hyperbolic everywhere in u, v if $\alpha = 1$.
- (b) Assume that $\alpha = -1$. For $\epsilon = 0$, write the Rankine-Hugoniot jump conditions for a shock wave solution

$$(u, v)(x, t) = \begin{cases} (u_-, v_-), & \text{if } x < st, \\ (u_+, v_+), & \text{if } x > st. \end{cases} \tag{14.48}$$

(c) Assume that $\alpha = -1$. For $\epsilon = 0$, let $(u_-, v_-) = (1, 0)$. Find all possible values of (u_+, v_+) for which (14.48) satisfies the jump conditions for some speed s . (Hint: The answer should be the union of a line and a hyperbola.)

(d) Assume that $\alpha = -1$. For $\epsilon > 0$, show that there is a traveling wave solution $(u, v) = (U, V)((x - st)/\epsilon)$ of system (14.47) satisfying

$$(U, V)(-\infty) = (+1, 0), \quad (U, V)(+\infty) = (-2, 0),$$

for some value of s (which you need to calculate), but that the corresponding shock ($\epsilon \rightarrow 0^+$) fails to satisfy the Lax entropy condition because only one characteristic enters the shock from each side in the $x-t$ plane, and one characteristic leaves on each side.

5. Write the equation

$$z_t + (f(|z|)z)_x = 0,$$

in which $z = u + iv$ is a complex variable, as a system of two conservation laws for real variables u, v .

(a) Find conditions on the function $f : \mathbb{R} \rightarrow \mathbb{R}$ under which the system is strictly hyperbolic. Calculate the characteristic speeds and the corresponding right eigenvectors.

(b) Show that one characteristic field is linearly degenerate and the other is genuinely nonlinear provided $f''(r) > 0, r \in \mathbb{R}$.

(c) Observe that the complex form of the equation is rotationally invariant, by changing variables: $\zeta = e^{i\theta}z$, where θ is constant, and writing the PDE for $\zeta(x, t)$. How does this property relate to parts a, b?

(d) Let $f(r) = r^2$. For $(u_-, v_-) = (1, 0)$, find all values of $(u_+, v_+) \in \mathbb{R}^2$ for which there is a shock satisfying the Lax entropy condition, a contact discontinuity, or centered rarefaction wave connecting (u_-, v_-) to (u_+, v_+) . This pair of equations is known as the *Keyfitz-Kranzer system* [29].

6. For the elastic string equations (14.17), show the following.

(a) Transverse waves are linearly degenerate.

(b) Longitudinal waves are genuinely nonlinear provided $T'' \neq 0$.

7. (a) Prove the property (14.10) that for 2×2 systems, the Riemann invariants diagonalize the system (for smooth solutions).

(b) Verify this property for the p -system. (Hint: Begin by deducing from (14.24) formulas for the Riemann invariants.)

8. Write out the details of the argument that gets you from (14.40) to (14.41) and thence to the statement about the admissibility of weak shocks following (14.41).

The Equations of Fluid Mechanics

An abundance of interesting and important PDE exists, many of which are systems of equations, because physical systems often relate different quantities as dependent variables. Examples of physical systems are given in Serre's text [39], including the equations of electromagnetism (Maxwell's equations), equations of three-dimensional elasticity, and those of magnetohydrodynamics. In this chapter we focus on the equations of fluid mechanics, specifically, the Navier-Stokes, Stokes, and Euler equations. We discuss how these equations are related, the contexts in which they are used, and some elementary properties.

15.1. The Navier-Stokes and Stokes Equations

The motion of a fluid is described by the evolution of physical quantities, such as density ρ , velocity $\mathbf{u} \in \mathbb{R}^3$, pressure p , and temperature θ . We shall assume constant temperature, even though variable temperature can be very significant, for example, in understanding patterns that are visible when heating water in a pot. Assuming constant temperature simplifies the equations quite a bit. The equations of motion can be derived from conservation laws of mass, momentum, and energy, coupled to constitutive laws. Details can be found in fluid mechanics texts, such as the one by Acheson [2].

Let's start with dimensional independent variables $\tilde{t}, \tilde{\mathbf{x}}$ and dimensional dependent variables $\tilde{\mathbf{u}}, \tilde{p}$. For an incompressible fluid such as water, the density ρ is taken to be constant, although for stratified incompressible fluids, variations in density can be important. The Navier-Stokes equations of incompressible flow are a balance between inertial terms and forces:

$$\begin{aligned} \rho \frac{\partial \tilde{\mathbf{u}}}{\partial \tilde{t}} + (\tilde{\mathbf{u}} \cdot \nabla) \tilde{\mathbf{u}} &= -\nabla \tilde{p} + \mu \Delta \tilde{\mathbf{u}} + \rho \mathbf{g}, \\ \nabla \cdot \tilde{\mathbf{u}} &= 0, \end{aligned} \tag{15.1}$$

where $\mathbf{g} = -g\hat{k}$ is the acceleration due to gravity expressed as a vector in the vertical direction. Thus, the term $\rho \mathbf{g}$ is mass per unit volume times acceleration. In fact, the first equation in (15.1) expresses Newton's law, force = mass \times acceleration in each small volume of fluid, so that mass is replaced by density (i.e., mass per unit volume). The second equation, known as the incompressibility condition, expresses conservation of mass for an incompressible fluid in which the density does not change. From this equation, the Divergence Theorem implies that volumes of fluid are preserved by the flow: if a fluid volume expands in one

direction then it contracts in other directions to compensate.

We now introduce a typical length scale L and time scale T , together with velocity scale U and pressure scale P . These scales allow us to nondimensionalize the variables and express the equations in nondimensional form. The nondimensional variables do not have the tildes:

$$\tilde{\mathbf{x}} = \mathbf{x}L, \quad \tilde{t} = tT, \quad \tilde{\mathbf{u}} = \mathbf{u}U, \quad \tilde{p} = pP.$$

Substituting into (15.1), we arrive at

$$\frac{\rho U}{T} \frac{\partial \mathbf{u}}{\partial t} + \frac{\rho U^2}{L} (\mathbf{u} \cdot \nabla) \mathbf{u} = -\frac{P}{L} \nabla p + \frac{\mu U}{L^2} \Delta \mathbf{u} + \rho \mathbf{g},$$

$$\frac{U}{L} \nabla \cdot \mathbf{u} = 0.$$

Next, divide the first vector equation by $\rho U^2/L$ and choose scales for T and P :

$$T = \frac{L}{U}, \quad P = \rho U^2.$$

Then T is a typical time for a fluid particle traveling at the typical velocity U to travel a typical length L , and the pressure scale P is chosen to simplify the equation as follows. We define the Reynolds number Re by

$$Re = \frac{\rho U L}{\mu},$$

and arrive at the nondimensional system

$$\frac{\partial \mathbf{u}}{\partial t} + (\mathbf{u} \cdot \nabla) \mathbf{u} = -\nabla p + \frac{1}{Re} \Delta \mathbf{u} + \mathbf{G}, \tag{15.2}$$

$$\nabla \cdot \mathbf{u} = 0,$$

where $\mathbf{G} = \frac{L}{U^2} \mathbf{g}$. The Reynolds number measures the relative importance of inertial terms, with dimension $\rho U^2/L$, and viscous forces, with dimension $\mu U/L^2$.

Since the velocity \mathbf{u} has three components, the first equation of (15.2) is really three scalar equations. They express conservation of linear momentum. The terms on the left-hand side are the inertial or acceleration terms, and the right-hand side represents the divergence of the forces, due to pressure, internal friction (i.e., viscous forces) and the body force due to gravity. The incompressibility condition $\nabla \cdot \mathbf{u} = 0$ is unchanged by the scaling.

The nondimensional form of the equations is a powerful tool. If an experiment is done on a fluid, such as water, in a laboratory, the results can apply in a much larger context, such as a river or an ocean, by calculating the appropriate Reynolds number from typical length and velocity scales. The results with water

would also apply to a much more viscous fluid, such as honey, again by using the Reynolds number to relate the two scenarios. Moreover, the Reynolds number controls the relative importance of the various terms in the equations, so it is important to understand two limits, $Re \rightarrow 0$, and $Re \rightarrow \infty$.

In the limit $Re \rightarrow 0$, corresponding to very slow flow (U small) or very viscous flow (μ large), is somewhat tricky. If we were to simply multiply by Re and set $Re = 0$, we would recover Laplace's equation. However, this is misleading, as the flow should be driven by pressure gradients. If we rescale the pressure by the Reynolds number and define a new appropriate time scale (in effect, we are using a different nondimensionalization), we recover the *Stokes equations* in the limit $Re \rightarrow 0$:

$$\begin{aligned}\frac{\partial \mathbf{u}}{\partial t} &= -\nabla p + \Delta \mathbf{u}, \\ \nabla \cdot \mathbf{u} &= 0,\end{aligned}\tag{15.3}$$

which have the virtue of being linear. In this derivation, we have assumed that the gravitational terms are significantly smaller than the terms retained. In some contexts, the effect of gravity can be significant, even for slow flow. Stokes equations are an important tool for studying the motion of small organisms in viscous fluids, and for very slow flows, such as lava and glacier flows.

15.2. The Euler Equations

At the other extreme, letting $Re \rightarrow \infty$, we immediately get the incompressible version of the *Euler equations*:

$$\begin{aligned}\frac{\partial \mathbf{u}}{\partial t} + (\mathbf{u} \cdot \nabla) \mathbf{u} &= -\nabla p + \mathbf{G}, \\ \nabla \cdot \mathbf{u} &= 0,\end{aligned}$$

in which viscosity is negligible. These equations model the flow of slightly viscous fluids, such as air, provided that the pressure gradients are not so large as to make compressibility significant.

The compressible Euler equations take the form

$$\begin{aligned}\frac{\partial \rho}{\partial t} + \nabla \cdot (\rho \mathbf{u}) &= 0, \\ \frac{\partial (\rho \mathbf{u})}{\partial t} + \nabla \cdot (\rho \mathbf{u} \otimes \mathbf{u}) &= -\nabla p, \\ \frac{\partial E}{\partial t} + \nabla \cdot ((E + p) \mathbf{u}) &= 0.\end{aligned}\tag{15.4}$$

In these equations, the density ρ is variable (as it is in a gas, for example). The variable $E = \frac{1}{2}\rho|\mathbf{u}|^2 + \rho e$ is the total energy (per unit volume) in terms of the kinetic energy $\frac{1}{2}\rho|\mathbf{u}|^2$ and the potential (or stored or internal) energy e . The variables are generally considered to be ρ , \mathbf{u} , and e , with $p = p(\rho, e)$ being given by an *equation of state*, another term for a constitutive law. Both ρ and e must be nonnegative, and the case $\rho = 0$ is known as the *vacuum state*. The tensor product $\mathbf{u} \otimes \mathbf{u}$ gives a matrix with the (i, j) entry being $u_i u_j$. The corresponding quadratic term in the Navier-Stokes equations (where ρ is constant) looks different, because \mathbf{u} is divergence free.

Let's consider the one-dimensional equations

$$\begin{aligned} \rho_t + (\rho u)_x &= 0, \\ (\rho u)_t + (\rho u^2 + p)_x &= 0, \\ E_t + ((E + p)u)_x &= 0, \end{aligned} \tag{15.5}$$

in which u is now a scalar velocity (the component of \mathbf{u} parallel to the x -axis). Notice that these equations (and in fact system (15.4)) are in the form of a system of conservation laws in which the conserved quantities are mass ρ , momentum $\rho\mathbf{u}$, and energy E . There is a natural symmetry in this system between left and right. Specifically, the equations are unchanged by the transformations $x \rightarrow -x$, $u \rightarrow -u$. A similar symmetry holds for the wave equation, both linear and quasilinear.

If we carry out the differentiations (assuming for the moment that the variables are smooth functions of x, t), we can write the system in the form of nonlinear transport equations, with the abbreviation $d_t = \partial_t + u\partial_x$ for the convective derivative:

$$\begin{aligned} d_t \rho + \rho u_x &= 0, \\ d_t u + \rho^{-1} p_x &= 0, \\ d_t e + \rho^{-1} p u_x &= 0. \end{aligned} \tag{15.6}$$

As in the previous chapter, hyperbolicity of this system depends on the eigenvalues of the coefficient matrix, which in this case is

$$A(\rho, u, e) = \begin{pmatrix} u & \rho & 0 \\ \rho^{-1} p_\rho & u & \rho^{-1} p_e \\ 0 & \rho^{-1} p & u \end{pmatrix}.$$

Note that in calculating this coefficient matrix, we use $p_x = p_\rho \rho_x + p_e e_x$, and the spatial part $u\partial_x$ of the convective derivative.

To calculate the characteristic speeds, we find eigenvalues of $A(\rho, u, e)$ from the characteristic equation:

$$(\lambda - u)^3 - (\lambda - u)(p_\rho + \rho^{-2}pp_e) = 0.$$

Thus, $\lambda = u$, or $\lambda = u \pm (p_\rho + \rho^{-2}pp_e)^{1/2}$, provided $p_\rho + \rho^{-2}pp_e \geq 0$. The vacuum state $\rho = 0$ is therefore singular since $\rho^{-2} \rightarrow \infty$, and hyperbolicity for $\rho > 0$ requires $p_\rho + \rho^{-2}pp_e > 0$.

If we write the three characteristic speeds as

$$\lambda_- = u - c, \quad \lambda_0 = u, \quad \lambda_+ = u + c,$$

where $c = (p_\rho + \rho^{-2}pp_e)^{1/2}$, we observe that c is the sound speed, meaning the speed of small disturbances, relative to the fluid speed u . The characteristic speed λ_0 is the same as the fluid speed and does not propagate small disturbances. Not surprisingly, the λ_0 characteristic field is linearly degenerate, as we show below. Since $\lambda_- < \lambda_0 < \lambda_+$, 1,2,3-characteristics are associated with λ_- , λ_0 , λ_+ respectively. The corresponding eigenvectors are

$$\mathbf{r}_\pm = \begin{pmatrix} \pm\rho \\ c \\ \pm\rho^{-1}p \end{pmatrix}, \quad \mathbf{r}_0 = \begin{pmatrix} p_e \\ 0 \\ -p_\rho \end{pmatrix},$$

respectively, and we can check genuine nonlinearity by calculating $\nabla\lambda \cdot \mathbf{r}$. For the λ_\pm waves, we have

$$\nabla\lambda_\pm \cdot \mathbf{r}_\pm = (\partial_\rho + \rho^{-2}p\partial_e)(\rho c).$$

Thus, genuine nonlinearity of these characteristic fields depends on the equation of state $p = p(\rho, e)$. In the isentropic case, $p = p(\rho)$ is independent of e , and genuine nonlinearity reduces to the condition $p''(\rho) \neq 0$. The λ_0 characteristic field is indeed linearly degenerate, since $\nabla\lambda_0 \cdot \mathbf{r}_0 \equiv 0$.

The characterization of shock waves and rarefaction waves for system (15.5) is complicated and is explained carefully and in detail in Serre's text [39], vol. 1, Section 4.8. Here we sketch the steps involved in processing the Rankine-Hugoniot jump conditions for shock waves. We consider a shock with speed s and left and right limits given by subscripts: v_\pm, ρ_\pm, e_\pm . With the bracket notation $[v] = v_+ - v_-$ for jumps, the Rankine-Hugoniot conditions for (15.5) are

$$[\rho v] = s[\rho], \tag{15.7a}$$

$$[\rho v^2 + p] = s[\rho v], \tag{15.7b}$$

$$[(\frac{1}{2}\rho v^2 + \rho e + p)v] = s[\frac{1}{2}\rho v^2 + \rho e]. \tag{15.7c}$$

If we let $z = v - s$, then $[\rho z] = 0$ from (15.7a), and we can let $m = \rho_{\pm} z_{\pm}$ be the common value on each side of the shock. Then we are left with the two conditions:

$$m[z] + [p] = 0, \quad (15.8a)$$

$$m\left[\frac{1}{2}z^2 + e\right] + [pz] = 0. \quad (15.8b)$$

With some algebra, these conditions can be combined into the equation

$$m[e] = -\frac{1}{2}(p_+ + p_-)[z],$$

so that

$$m[e] = -\frac{1}{2}m(p_+ + p_-)[\rho^{-1}]. \quad (15.9)$$

Thus, either $m = 0$, or $[e] = -\frac{1}{2}(p_+ + p_-)[\rho^{-1}]$.

If $m = 0$, and assuming that $\rho_{\pm} > 0$, we have $z_{\pm} = 0$, so that $v_{\pm} = s$. Then (15.8a) implies $p_+ = p_-$, and the Rankine-Hugoniot conditions are satisfied. These shocks, moving with characteristic speed, that is, the fluid particle speed v , are *contact discontinuities*. Across such a wave, density jumps, but velocity and pressure are continuous.

If $m \neq 0$, then we have

$$[e] + \frac{1}{2}(p_+ + p_-)[\rho^{-1}] = 0. \quad (15.10)$$

From (15.9) and $z_{\pm} = m\rho_{\pm}^{-1}$, it follows that

$$m^2[\rho^{-1}] + [p] = 0. \quad (15.11)$$

Thus, if $\rho_{\pm}, e_{\pm}, p_{\pm} = p(\rho_{\pm}, e_{\pm})$ satisfy (15.10), then there are two real solutions of (15.11) provided $[p]/[\rho^{-1}] < 0$. If we label these two solutions m_1 and m_3 , they correspond to 1-shocks ($m_1 > 0$ associated with 1-characteristics) and 3-shocks ($m_3 < 0$ associated with 3-characteristics). Then the velocities are given by $v_{\pm} = z_{\pm} + s$, with the speed s being chosen.

It is then possible (but intricate) to give a parameterization of 1-shocks and 3-shocks satisfying the Lax entropy condition. The entropy condition is related to the thermodynamic entropy $S = S(\rho, e)$, which satisfies the PDE $\rho^2 S_{\rho} + p S_e = 0$. This entropy has to satisfy $m[S] > 0$ across the shock, with the result that fluid particles gain entropy (S increases) as they pass through the shock.

In this chapter we have summarized some basic mathematical properties of the key equations of fluid mechanics. The mathematical theory of these equations is vast and is a very lively topic of current research. Moreover, the equations are used to explain all sorts of phenomena involving fluid flow, from the swimming

of small organisms to the prediction of weather patterns and the aerodynamics of airplanes. The interested reader will find the books of Chorin and Marsden [7] and of Serre [39] useful introductions to some more of the mathematical properties of these equations, whereas the text of Acheson [2] is an intuitive treatment of the equations, including informal discussions of many applications and the calculation of physically meaningful solutions.

PROBLEMS

1. Show that if ρ is constant in the Euler equations, then the equation for conservation of momentum collapses to the corresponding equation in the incompressible Euler equations. For smooth solutions of the incompressible Euler equations, derive an energy equality and relate it to the energy equation for the compressible case.
2. Let $\mathbf{u} = (u, v, w)$, $\mathbf{x} = (x, y, z)$. Write the Navier-Stokes system (15.2) in components (so that there are four scalar equations, and ∇ is replaced by partial derivatives with respect to x, y, z).
3. Consider flow between two parallel horizontal plates held a distance $h > 0$ apart. Suppose the bottom plate is stationary and the top plate is moving horizontally at speed U . Use the Navier-Stokes system, neglecting gravity, to find a simple steady flow (independent of time t) in which fluid particles move parallel to the plates. Assume the plates are at $z = 0, h$, there is no dependence on y , and the top plate is moving to the right, parallel to the x -axis. Begin by sketching the plates and how you think the flow might look. Then consider which components of the velocity $\mathbf{u} = (u, v, w)$ can be set to zero. You can then solve the reduced set of equations for the velocity and pressure.

APPENDIX A Multivariable Calculus

When the distinction between scalars (real or complex) and vectors (n -tuples) is needed, we use boldface for vectors. Thus, $\mathbf{x} = (x_1, \dots, x_n) \in \mathbb{R}^n$.

We generally use the notation U to denote an open subset of \mathbb{R}^n . Then ∂U is the boundary of U , and $\bar{U} = U \cup \partial U$ is the *closure* of U . If U is bounded, then \bar{U} is closed and bounded, hence it is compact. For example, if $f: \mathbb{R}^n \rightarrow \mathbb{R}$ is a function, then f has *support* defined as $\text{supp } f = \overline{\{\mathbf{x} \in \mathbb{R}^n : f(\mathbf{x}) \neq 0\}}$; thus, f has compact support if the function is zero outside a bounded set.

If U has a C^1 boundary ∂U , then the *unit normal* $\nu = \nu(\mathbf{x})$ varies continuously with $\mathbf{x} \in \partial U$. For example, the unit ball $U = \{\mathbf{x} \in \mathbb{R}^n : |\mathbf{x}| < 1\}$ has as its boundary the unit sphere $\partial U = \{\mathbf{x} \in \mathbb{R}^n : |\mathbf{x}| = 1\}$, and *unit outward normal* $\nu(\mathbf{x}) = \mathbf{x}$.

The *open ball* with center at \mathbf{x} and radius $r > 0$ is $B(\mathbf{x}, r) = \{\mathbf{y} \in \mathbb{R}^n : |\mathbf{y} - \mathbf{x}| < r\}$. To calculate ω_n , the *surface area of the unit sphere* $\partial B(0, 1)$ in \mathbb{R}^n , we begin by integrating $e^{-\pi|\mathbf{x}|^2}$ over \mathbb{R}^n :

$$\begin{aligned} \int_{\mathbb{R}^n} e^{-\pi|\mathbf{x}|^2} d\mathbf{x} &= \int_{-\infty}^{\infty} \cdots \int_{-\infty}^{\infty} \int_{-\infty}^{\infty} e^{-\pi(x_1^2 + x_2^2 + \cdots + x_n^2)} dx_1 dx_2 \cdots dx_n \\ &= \left(\int_{-\infty}^{\infty} e^{-\pi x^2} dx \right)^n = 1. \end{aligned}$$

Using the fact that the surface area of $\partial B(0, r)$ is $r^{n-1}\omega_n$, we have

$$\begin{aligned} 1 &= \int_{\mathbb{R}^n} e^{-\pi|\mathbf{x}|^2} d\mathbf{x} = \int_0^{\infty} \int_{\partial B(0,r)} e^{-\pi|\mathbf{x}|^2} dS dr = \int_{\partial B(0,1)} \int_0^{\infty} e^{-\pi r^2} r^{n-1} dr dS \\ &= \omega_n \int_0^{\infty} e^{-\pi r^2} r^{n-1} dr = (\omega_n/2\pi^{\frac{n}{2}}) \int_0^{\infty} e^{-t} t^{\frac{n}{2}-1} dt \quad (\text{in which } t = \pi r^2) \\ &= (\omega_n/2\pi^{\frac{n}{2}}) \Gamma\left(\frac{n}{2}\right). \end{aligned}$$

(The gamma function Γ is defined below.) Thus $\omega_n = 2\pi^{\frac{n}{2}}/\Gamma(n/2)$. This expression leads to the familiar circumference of the unit circle: $\omega_2 = 2\pi$, and area of the unit sphere in \mathbb{R}^3 : $\omega_3 = 4\pi$.

Let α_n denote the *volume of the unit ball* $B(0, 1)$ in \mathbb{R}^n . It follows that

$$\alpha_n = \int_{B(0,1)} d\mathbf{x} = \int_0^1 \int_{\partial B(0,r)} dS dr = \int_0^1 \omega_n r^{n-1} dr = \frac{\omega_n}{n}.$$

In particular, $\alpha_2 = \pi$ is the area of the unit disk, and $\alpha_3 = 4\pi/3$ is the volume of the unit ball in \mathbb{R}^3 .

The *integral averages* of a function f over $B(x, r)$ and $\partial B(x, r)$ are defined by

$$\begin{aligned} \int_{B(x,r)} f(y) dy &= \frac{1}{\alpha_n r^n} \int_{B(x,r)} f(y) dy, \\ \int_{\partial B(x,r)} f(y) dS &= \frac{1}{\omega_n r^{n-1}} \int_{\partial B(x,r)} f(y) dS. \end{aligned}$$

The *chain rule* gives formulas for differentiating the composition of two functions. It takes various useful forms, depending on the number of variables involved. Consider $\mathbf{x} \in \mathbb{R}^n$ and two functions $f: \mathbb{R}^n \rightarrow \mathbb{R}$ and $\mathbf{y}: \mathbb{R}^n \rightarrow \mathbb{R}^n$, so that $f = f(\mathbf{y})$ and $\mathbf{y} = \mathbf{y}(\mathbf{x})$. Then we have

$$\frac{\partial}{\partial x_i} f(\mathbf{y}(\mathbf{x})) = \sum_{j=1}^n \frac{\partial f}{\partial y_j} \frac{\partial y_j}{\partial x_i} = \nabla f(\mathbf{y}) \cdot \frac{\partial \mathbf{y}}{\partial x_i}.$$

Now consider a function with an extra variable $t \in \mathbb{R}: F = F(t, \mathbf{y})$, and suppose $\mathbf{y} = \mathbf{y}(t)$. Then it follows that

$$\frac{d}{dt} F(t, \mathbf{y}(t)) = \frac{\partial F}{\partial t} + \sum_{j=1}^n \frac{\partial F}{\partial y_j} \frac{\partial y_j}{\partial t} = F_t + \nabla_{\mathbf{y}} F \cdot \frac{d\mathbf{y}}{dt}.$$

If $g: \mathbb{R} \rightarrow \mathbb{R}$ and $\xi: \mathbb{R}^n \rightarrow \mathbb{R}$ with $g = g(\xi)$ and $\xi = \xi(\mathbf{x})$, then the following holds:

$$\frac{\partial}{\partial x_i} g(\xi(\mathbf{x})) = g'(\xi) \frac{\partial}{\partial x_i} \xi(\mathbf{x}).$$

For example, for a traveling wave $u(x, t) = f(x - ct)$ with wave speed c , we have

$$\frac{\partial u}{\partial t}(x, t) = -cf'(\xi), \quad \frac{\partial u}{\partial x}(x, t) = f'(\xi), \quad \xi = x - ct.$$

Let $F: \mathbb{R}^n \rightarrow \mathbb{R}$ be C^1 . Then (away from points where $\nabla F(\mathbf{x}) = \mathbf{0}$) the equation $F(\mathbf{x}) = \text{const}$ defines a manifold M of dimension $n - 1$, sometimes called a *hypersurface* or a *level surface* of F . For example, if $n = 3$, then the manifold is a two-dimensional surface. Let $\mathbf{x}_0 \in M$. If $\nabla F(\mathbf{x}_0) \neq \mathbf{0}$ then the *unit normal* $\nu(\mathbf{x}_0)$ is given by

$$\nu(\mathbf{x}_0) = \frac{\nabla F(\mathbf{x}_0)}{|\nabla F(\mathbf{x}_0)|}.$$

Let $\mathbf{f} : \mathbb{R}^n \rightarrow \mathbb{R}$ be C^∞ . The *Taylor series* of f about $\mathbf{x}_0 \in \mathbb{R}^n$ is given by

$$\sum_{|\alpha|=0}^{\infty} a_\alpha (\mathbf{x} - \mathbf{x}_0)^\alpha,$$

where $a_\alpha = \frac{1}{\alpha!} d^\alpha f(\mathbf{x}_0)$. This expression uses multi-index notation, which is explained in [Section 10.2](#).

The *gamma function* is the function $\Gamma(s) = \int_0^\infty e^{-t} t^{s-1} dt$. Then $\Gamma(1) = 1$, $\Gamma(\frac{1}{2}) = \sqrt{\pi}$, and the recurrence $\Gamma(s + 1) = s\Gamma(s)$ implies that for integers $n \geq 0$, $\Gamma(n + 1) = n!$, which uses $0! = 1$, a convention also implicit in the Taylor series.

The Inverse Function Theorem states that if a differentiable function f from \mathbb{R}^n to \mathbb{R}^n has an invertible Jacobian matrix $df(\mathbf{x}_0)$ at a point \mathbf{x}_0 , then the function itself is invertible in a neighborhood of that point, and the inverse is as differentiable as f .

Theorem A.1. (Inverse Function Theorem) *Let $U \subset \mathbb{R}^n$ be open, and suppose $f : U \rightarrow \mathbb{R}^n$ is C^k for some $k \geq 1$. Let $\mathbf{x}_0 \in U$, and $\mathbf{y}_0 = f(\mathbf{x}_0)$. Suppose the Jacobian $J = \det(df(\mathbf{x}_0))$ is nonzero. Then there are open sets $V \subset U$ and $W \subset \mathbb{R}^n$, with $\mathbf{x}_0 \in V$, $\mathbf{y}_0 \in W$, such that:*

1. $f : V \rightarrow W$ is one-to-one and onto, and
2. the inverse $f^{-1} : W \rightarrow V$ is C^k .

The *Implicit Function Theorem* relates to solving simultaneous nonlinear equations

$$F(\mathbf{x}, \mathbf{y}) = 0,$$

near a known solution $(\mathbf{x}_0, \mathbf{y}_0)$, where $F : \mathbb{R}^n \times \mathbb{R}^m \rightarrow \mathbb{R}^n$ is differentiable. Similarly to the Inverse Function Theorem, the function is assumed to be linearly nondegenerate at this solution in the sense that the Jacobian with respect to \mathbf{x} is nonzero. The conclusion is that the equations can be solved uniquely locally for \mathbf{x} as a function of \mathbf{y} for \mathbf{y} close to \mathbf{y}_0 , with $\mathbf{x}(\mathbf{y}_0) = \mathbf{x}_0$, and with $\mathbf{x}(\mathbf{y})$ as differentiable as F .

Theorem A.2. (Implicit Function Theorem) *Let $U \subset \mathbb{R}^n \times \mathbb{R}^m$ be open, and suppose $f : U \rightarrow \mathbb{R}^n$ is C^k for some $k \geq 1$. Suppose that*

$$F(\mathbf{x}_0, \mathbf{y}_0) = 0, \quad \text{and} \quad J = \det(d_{\mathbf{x}}F(\mathbf{x}_0, \mathbf{y}_0)) \neq 0.$$

Then there are open sets $V \subset U$ and $W \subset \mathbb{R}^m$, with $(\mathbf{x}_0, \mathbf{y}_0) \in V$, $\mathbf{y}_0 \in W$, and a C^k function $\hat{\mathbf{x}} : W \rightarrow \mathbb{R}^n$ such that:

1. $\hat{x}(y_0) = x_0$;
2. $F(\hat{x}(y), y) = 0$ for all $y \in W$; and
3. if $(x, y) \in V$ and $F(x, y) = 0$, then $x = \hat{x}(y)$.

The contraction mapping principle can be used to prove the Inverse Function Theorem. The principle is stated here in the broader setting of a complete metric space X with metric d . A mapping $T : X \rightarrow X$ is a *contraction* if there exists a constant $L \in (0, 1)$ such that

$$d(T(x), T(y)) \leq L d(x, y) \quad \text{for all } x, y \text{ in } X.$$

The *contraction mapping principle*, also known as the Banach Fixed-Point Theorem, states that if (X, d) is a nonempty complete metric space with metric d , and $T : X \rightarrow X$ is a contraction mapping, then T has a unique fixed point $x^* \in X$. That is, $T(x^*) = x^*$. Furthermore, $x^* = \lim_{n \rightarrow \infty} x_n$, where $x_0 \in X$ is arbitrary, and $x_{n+1} = T(x_n)$, $n \geq 0$.

Green's Theorem in the plane relates a double integral over a bounded open set $U \subset \mathbb{R}^2$ to a line integral along the curve ∂U .

Theorem A.3. (*Green's Theorem in the plane*) Suppose $\mathbf{F} = (P, Q) : \bar{U} \rightarrow \mathbb{R}^2$ is continuous and is C^1 in U , and the boundary curve is piecewise C^1 . Then

$$\int_{\partial U} \mathbf{F} \cdot \boldsymbol{\tau} ds = \int \int_U \left(\frac{\partial Q}{\partial x} - \frac{\partial P}{\partial y} \right) dA,$$

where $\boldsymbol{\tau}$ is the unit tangent in the counterclockwise direction, s denotes arc length, and $dA = dx dy$ in Cartesian coordinates is the area metric in the plane.

Stokes' Theorem is similar to Green's Theorem in the plane, but it relates the line integral over the closed boundary curve ∂S of a two-dimensional surface $S \subset \mathbb{R}^3$ to the surface integral over S :

$$\int_{\partial S} \mathbf{F} \cdot \boldsymbol{\tau} ds = \int \int_S (\nabla \times \mathbf{F}) \cdot \boldsymbol{\nu} dS,$$

where $\mathbf{F} : \mathbb{R}^3 \rightarrow \mathbb{R}^3$. Here, $\boldsymbol{\nu}$ is the normal to S consistent with $\boldsymbol{\tau}$ and the right-hand rule.

Green's Theorem in the plane is the two-dimensional version of the *Divergence Theorem* for a vector field $\mathbf{F} \in C^1(U) \cap C(\bar{U})$, where $U \subset \mathbb{R}^n$. The theorem relates the net flux of \mathbf{F} through the boundary ∂U to the total divergence of \mathbf{F} over the entire region U :

$$\int_{\partial U} \mathbf{F} \cdot \boldsymbol{\nu} dS = \int_U \nabla \cdot \mathbf{F} d\mathbf{x}.$$

Here, ν is the unit outward normal.

A more fundamental integration is the component version of the Divergence Theorem. Let $f: \bar{U} \rightarrow \mathbb{R}$ be a function in $C^1(U) \cap C(\bar{U})$. Then for each $j = 1, \dots, n$,

$$\int_U \frac{\partial f}{\partial x_j}(\mathbf{x}) d\mathbf{x} = \int_{\partial U} f(\mathbf{x}) \nu_j(\mathbf{x}) dS.$$

Note that the Divergence Theorem and this result are equivalent. However, the latter result is a direct consequence of the Fundamental Theorem of Calculus.

The *Leibniz integral rule* describes how to bring a partial derivative with respect to one variable into the integral of a multivariable function when the integral is taken with respect to the other variable:

$$\begin{aligned} \frac{\partial}{\partial x} \int_{a(x)}^{b(x)} f(x, t) dt \\ = f(x, b(x))b'(x) - f(x, a(x))a'(x) + \int_{a(x)}^{b(x)} \frac{\partial f}{\partial x}(x, t) dt. \end{aligned}$$

To reverse the order of integration in a double integral, we use *Fubini's Theorem*.

Theorem A.4. (*Fubini's Theorem*) $f = f(x, y)$ be continuous over the rectangle $R = \{(x, y) : a \leq x \leq b, c \leq y \leq d\}$. Then

$$\int \int_R f(x, y) dA = \int_a^b \int_c^d f(x, y) dy dx = \int_c^d \int_a^b f(x, y) dx dy.$$

Two elements \mathbf{x} and \mathbf{y} of a vector space X with an inner product (\cdot, \cdot) are *orthogonal* if $(\mathbf{x}, \mathbf{y}) = 0$. A set $S \subset X$ is called *orthonormal* if all $\mathbf{x} \neq \mathbf{y}$ in S are orthogonal and $(\mathbf{x}, \mathbf{x}) = 1$.

A function $f: \mathbb{R}^n \rightarrow \mathbb{R}$ is *convex* on \mathbb{R}^n if for all \mathbf{x}, \mathbf{y} in \mathbb{R}^n $t \in (0, 1)$,

$$f(t\mathbf{x} + (1-t)\mathbf{y}) \geq tf(\mathbf{x}) + (1-t)f(\mathbf{y}).$$

f is *strictly convex* if the inequality is strict.

APPENDIX B Analysis

The *Lebesgue measure* $|\cdot| : \mathcal{M} \rightarrow [0, \infty]$ is a function defined on the family \mathcal{M} of *Lebesgue measurable* subsets of \mathbb{R}^n , which includes all open subsets. The family \mathcal{M} is a σ -*algebra*, meaning that $\mathbf{0}$ and \mathbb{R}^n are in \mathcal{M} ; complements, countable unions, and intersections of members of \mathcal{M} are also in \mathcal{M} . The Lebesgue measure has properties consistent with being a generalization of the idea of volume. The measure of any ball is the volume of the ball; the measure of disjoint unions of countable families of measurable sets is the sum of their measures; measurable subsets of sets of measure zero also have measure zero. A property is said to hold *almost everywhere*, abbreviated as a.e., if the property holds except on a set of measure zero.

A function $f : \mathbb{R}^n \rightarrow \mathbb{R}$ is *measurable* if for every open $S \subset \mathbb{R}$, the inverse image $f^{-1}(S) \in \mathcal{M}$. Thus, continuous functions are measurable. Nonnegative measurable functions are integrable, the integral being defined using approximation by simple functions. More generally, if f is measurable, then f is *integrable* as long as the positive f^+ and negative f^- parts of f can comprise the integral:

$$\int_{\mathbb{R}^n} f \, dx = \int_{\mathbb{R}^n} f^+ \, dx - \int_{\mathbb{R}^n} f^- \, dx,$$

where one of the integrals on the right-hand side is finite.

The *essential supremum* of a measurable function f is defined by

$$\text{ess sup } f = \inf \{m \in \mathbb{R} : |\{\mathbf{x} : f(\mathbf{x}) > m\}| = 0\}.$$

Among many properties of measurable functions, the following two theorems are especially important for PDE.

Theorem B.1. (*Monotone Convergence Theorem*) If a sequence $\{f_k\}_{k=1}^{\infty}$ of integrable functions is monotonically increasing:

$$f_1 \leq f_2 \leq \dots,$$

then

$$\int_{\mathbb{R}^n} \lim_{k \rightarrow \infty} f_k \, dx = \lim_{k \rightarrow \infty} \int_{\mathbb{R}^n} f_k \, dx.$$

Theorem B.2. (*Dominated Convergence Theorem*) For a sequence $\{f_k\}_{k=1}^{\infty}$ of integrable functions with $f_k \rightarrow f$ a.e., as $k \rightarrow \infty$, and $|f_k| \leq g$ a.e., and for a positive measurable function g with $\int_{\mathbb{R}^n} g \, dx < \infty$, the following limit holds:

$$\int_{\mathbb{R}^n} f_k dx \rightarrow \int_{\mathbb{R}^n} f dx \quad \text{as } k \rightarrow \infty.$$

Further details on Lebesgue measure and integrable functions can be found in summary in the Appendix in Evans [12], and in many books on measure and integration, for example, Ambrosia et al. [3]. A major advantage of using Lebesgue measure to generalize the notion of integral is that spaces L^p , $p \geq 1$ of measurable functions are complete.

Consider a real or complex vector space X over the scalar field \mathbb{R} or \mathbb{C} (respectively). A *norm* $\|\cdot\| : X \rightarrow [0, \infty)$ is a function that is required to have these properties:

1. $\|x\| = 0$ if and only if $x = 0$;
2. $\|\alpha x\| = |\alpha| \|x\|$, for all $x \in X$, and scalar α ; and
3. $\|x + y\| \leq \|x\| + \|y\|$ for all x, y in X (the triangle inequality).

A norm defines a metric ρ , expressing the distance between elements $x, y \in X$: $\rho(x, y) = \|x - y\|$.

Let X be a vector space with norm $\|\cdot\|$. A sequence $\{x_k\}_{k=1}^{\infty} \subset X$ is a *Cauchy sequence* if for every $\epsilon > 0$, there is $N = N_{\epsilon} > 0$ such that

$$\|x_j - x_k\| < \epsilon \quad \text{for all } j, k \geq N.$$

That is, $\|x_j - x_k\| \rightarrow 0$ as $j, k \rightarrow \infty$.

X is *complete* if every Cauchy sequence in X converges to a limit in X : $\|x_k - x\| \rightarrow 0$ for some $x \in X$. A *Banach space* is a complete normed vector space. Thus, \mathbb{R}^n and \mathbb{C}^n are Banach spaces, and so is $C([a, b])$ with the norm $\|f\| = \max_{a \leq x \leq b} |f(x)|$.

An *inner product* $(\cdot, \cdot) : X \times X \rightarrow \mathbb{R}$ is a function satisfying

1. $(x, y) = \overline{(y, x)}$ for all $x, y \in X$;
2. $(x, x) \geq 0$ for all $x \in X$;
3. $(x, x) = 0$ if and only if $x = 0$; and
4. $(\alpha x, y) = \alpha(x, y)$, for all $x, y \in X$, and scalar α .

An inner product defines a norm by $\|x\| = \sqrt{(x, x)}$. A Banach space X that has an inner product defining its norm is a *Hilbert space*. Thus, a Hilbert space is a complete inner product space.

Spaces of infinite sequences of numbers are convenient examples of infinite-

dimensional vector spaces. The space ℓ^p ("little ell p"), with $p \geq 1$, consists of all sequences $\mathbf{x} = \{x_k\}_{k=1}^{\infty}$ satisfying $\sum_{k=1}^{\infty} |x_k|^p < \infty$ with norm $\|\mathbf{x}\|_p = (\sum_{k=1}^{\infty} |x_k|^p)^{1/p}$. The space ℓ^p is a Banach space. The space ℓ^2 is a Hilbert space with inner product $(\mathbf{x}, \mathbf{y}) = \sum_{k=1}^{\infty} x_k y_k$, the infinite-dimensional version of the Euclidean inner product.

When $p = \infty$, ℓ^∞ is the Banach space of all bounded sequences with norm $\|\mathbf{x}\|_\infty = \sup_k |x_k|$.

The space c of convergent sequences \mathbf{x} of real or complex numbers with the ℓ^∞ norm $\|\mathbf{x}\|_\infty = \sup_k |x_k|$ is a closed subspace of ℓ^∞ and is thus a Banach space. The subspace c_0 consisting of sequences $\{x_k\}_{k=1}^{\infty}$ with $\lim_{k \rightarrow \infty} x_k = 0$ is also a Banach space.

The *Weierstrass M-test* states that if $\{f_k\}$ is a sequence of real- or complex-valued functions defined on a set $U \subset \mathbb{R}^n$, and there is a sequence of positive numbers M_k such that for all $k \geq 1$ and all $\mathbf{x} \in U$,

$$|f_k(\mathbf{x})| \leq M_k \quad \text{and} \quad \sum_{k=1}^{\infty} M_k < \infty,$$

then the series $\sum_{k=1}^{\infty} f_k(\mathbf{x})$ converges uniformly on U .

APPENDIX C Systems of Ordinary Differential Equations

Let $\mathbf{F} : \mathbb{R}^n \rightarrow \mathbb{R}^n$ be continuous. We say that a C^1 curve $\mathcal{C} = \{\mathbf{x} = \mathbf{x}(t), t \in I\}$ (where I is an interval and $\mathbf{x} : I \rightarrow \mathbb{R}^n$ is C^1) is an **integral curve** of the vector field \mathbf{F} if

$$\frac{d\mathbf{x}(t)}{dt} = \mathbf{F}(\mathbf{x}(t)).$$

Integral curves are sometimes called *trajectories*. Since the ODE system is autonomous, integral curves are translation invariant: for any $t_0 \in \mathbb{R}$, $\mathbf{x}(t + t_0)$ traces the same curve \mathcal{C} in \mathbb{R}^n as t varies.

Consider the nonlinear autonomous system of two ODE:

$$\begin{pmatrix} u' \\ v' \end{pmatrix} = \begin{pmatrix} f(u, v) \\ g(u, v) \end{pmatrix} = \mathbf{F}(u, v). \quad (\text{C.1})$$

Equilibria are points $(u_0, v_0) \in \mathbb{R}^2$ satisfying $\mathbf{F}(u_0, v_0) = \mathbf{0}$. Behavior of the system (C.1) near an equilibrium (u_0, v_0) is related to the linearized system

$$\begin{pmatrix} u' \\ v' \end{pmatrix} = d\mathbf{F}(u_0, v_0) \begin{pmatrix} u \\ v \end{pmatrix}, \quad (\text{C.2})$$

where

$$d\mathbf{F}(u_0, v_0) = \begin{bmatrix} \frac{\partial f}{\partial u} & \frac{\partial f}{\partial v} \\ \frac{\partial g}{\partial u} & \frac{\partial g}{\partial v} \end{bmatrix} (u_0, v_0)$$

is the Jacobian. Let's assume the eigenvalues λ_1, λ_2 of $d\mathbf{F}(u_0, v_0)$ are distinct ($\lambda_1 \neq \lambda_2$) and have eigenvectors $\mathbf{v}_1, \mathbf{v}_2$, respectively. The eigenvalues and eigenvectors may be complex. The general real solution of the linear system (C.2) is

$$\begin{pmatrix} u \\ v \end{pmatrix} (t) = C_1 \mathbf{v}_1 e^{\lambda_1 t} + C_2 \mathbf{v}_2 e^{\lambda_2 t},$$

where C_1, C_2 are arbitrary constants. If the eigenvalues are complex, then these constants are complex, and it is understood that solutions are the real part of this formula. The equilibrium is classified as *stable* if $\text{Re } \lambda_j < 0, j = 1, 2$, *unstable* if $\text{Re } \lambda_j > 0, j = 1, 2$. Stable and unstable *spirals* correspond to complex conjugate eigenvalues; the integral curves of $\mathbf{F}(u, v)$ spiral into or out of (u_0, v_0) . If the eigenvalues are real and of the same sign, then the equilibrium is a stable or unstable *node*. If λ_1, λ_2 are real and have opposite signs, then the equilibrium is a

saddle, and there are integral curves that are tangent to the eigenvectors $\mathbf{v}_1, \mathbf{v}_2$ at (u_0, v_0) . These curves are the stable and unstable manifolds M^S, M^U of (u_0, v_0) .

References

- [1] R. Abeyaratne and J. K. Knowles. Implications of viscosity and strain gradient effects for the kinetics of propagating phase boundaries in solids. *SIAM J. Appl. Math.* 51:1205–1221, 1991.
- [2] D. J. Acheson. *Elementary Fluid Dynamics*. Oxford University Press, New York, 1990.
- [3] L. Ambrosio, G. DaPrato, and A. Mennucci. *Introduction to Measure Theory and Integration*, volume 10 of *Edizioni della Normale*. Springer, New York, 2011.
- [4] S. S. Antman. The equations for large vibrations of strings. *Am. Math. Monthly* 87(5):359–370, 1980.
- [5] D. G. Aronson and H. F. Weinberger. Multidimensional nonlinear diffusion arising in population genetics. *Adv. Math.* 30:33–76, 1978.
- [6] A. Bressan. *Hyperbolic Systems of Conservation Laws: The One-Dimensional Cauchy Problem*, volume 20 of *Mathematics and Its Applications*. Oxford University Press, Oxford, 2000.
- [7] A. Chorin and J. L. Marsden. *A Mathematical Introduction to Fluid Mechanics*, volume 3 of *Pure and Applied Mathematics*. Springer, New York, 1990.
- [8] S.-N. Chow and J. K. Hale. *Methods of Bifurcation Theory*, volume 251 of *Comprehensive Studies in Mathematics*. Springer, New York, 1982.
- [9] J. D. Cole. On a quasi-linear parabolic equation occurring in aerodynamics. *Quart. Appl. Math.* 9(3):225–236, 1951.
- [10] J. D. Conway. *Functions of One Complex Variable*, 2nd edition, volume 11 of *Graduate Texts in Mathematics*. Springer, New York, 1978.
- [11] M. G. Crandall and P. H. Rabinowitz. Bifurcation from simple eigenvalues. *J. Funct. Anal.* 8(2):321–340, 1971.
- [12] L. C. Evans. *Partial Differential Equations*, volume 19 of *Graduate Series in Mathematics*. American Mathematical Society, Providence, 2010.
- [13] P. C. Fife and J. B. McLeod. The approach of solutions of nonlinear diffusion equations to travelling front solutions. *Arch. Rational Mech. Anal.* 65(4):335–361, 1977.
- [14] R. A. Fisher. The wave of advance of an advantageous gene. *Ann. Eugen.* 7:355–369, 1936.
- [15] Y. Forterre and O. Pouliquen. Flows of dense granular materials. *Annu. Rev. Fluid Mech.* 40:1–24, 2008.
- [16] P. R. Garabedian. *Partial Differential Equations*. American Mathematical Society, Chelsea, 1998.
- [17] C. S. Gardner, J. M. Greene, M. D. Kruskal, and R. M. Miura. Korteweg-deVries equation and generalizations. VI. Methods for exact solution. *Comm. Pure Appl. Math.* 27(1):97–133, 1974.
- [18] J. Glimm. Solutions in the large for nonlinear hyperbolic systems of equations. *Comm. Pure Appl. Math.* 18(4):697–715, 1965.
- [19] M. G. Golubitsky and D. G. Schaeffer. *Singularities and groups in bifurcation theory*, volume 1. Springer, New York, 1984.

- [20] J. M. N. T. Gray and A. R. Thornton. A theory for particle size segregation in shallow granular free-surface flows. *Proc. R. Soc. Lond. A*, 461(2057):1447–1473, 2005.
- [21] E. Hopf. The partial differential equation $u_t + uu_x = \mu u_{xx}$. *Comm. Pure Appl. Math.* 3(3):201–230, 1950.
- [22] K. Hutter and K. R. Rajagopal. On flows of granular materials. *Continuum Mech. Thermodyn.* 6:81–139, 1994.
- [23] E. Isaacson, D. Marchesin, and B. Plohr. Transitional waves for conservation laws. *SIAM J. Math. Anal.* 21:837–866, 1990.
- [24] D. Jacobs, B. McKinney, and M. Shearer. Travelling wave solutions of the modified Korteweg-deVries-Burgers equation. *J. Diff. Equ.* 116(2):448–467, 1995.
- [25] R. D. James. The propagation of phase boundaries in elastic bars. *Arch. Rational Mech. Anal.* 73(2):125–158, 1980.
- [26] A. Jeffrey. *Applied Partial Differential Equations, An Introduction*. Academic Press, New York, 2003.
- [27] F. John. Formation of singularities in one-dimensional nonlinear wave propagation. *Comm. Pure Appl. Math.* 27:377–405, 1974.
- [28] T. Kato. *Perturbation Theory for Linear Operators*, volume 132 of Die Grundlehren der mathematischen Wissenschaften. Springer, New York, 1966.
- [29] B. L. Keyfitz and H. C. Kranzer. A system of non-strictly hyperbolic conservation laws arising in elasticity theory. *Arch. Rational Mech. Anal.* 72:219–241, 1980.
- [30] E. Kreyszig. *Introductory Functional Analysis with Applications*. Wiley, New York, 2007.
- [31] S. N. Kruzkov. First order quasilinear equations in several independent variables. *Math. USSR SB*, 10(2):217–243, 1970.
- [32] P. D. Lax. Hyperbolic systems of conservation laws II. *Comm. Pure Appl. Math.* 10:537–566, 1957.
- [33] P. D. Lax. Development of singularities of solutions of nonlinear hyperbolic partial differential equations. *J. Math. Phys.* 5:611–613, 1964.
- [34] P. LeFloch. *Hyperbolic Systems of Conservation Laws: The Theory of Classical and Nonclassical Shock Waves*. Birkhauser, Zurich, 2002.
- [35] A. Majda. *Compressible Flow and Systems of Conservation Laws in Several Space Variables*, volume 53 of *Applied Mathematical Sciences*. Springer, New York, 1983.
- [36] R. M. Miura. The Korteweg–deVries equation: A survey of results. *SIAM Rev.* 18:412–459, 1976.
- [37] O. A. Oleinik. Uniqueness and stability of the generalized solution of the Cauchy problem for a quasilinear equation. *Uspekhi Mat. Nauk* 14(2):165–170, 1959.
- [38] W. Rudin. *Principles of Mathematical Analysis*. McGraw-Hill, New York, 1976.
- [39] D. Serre. *Systems of Conservation Laws, I, II*. Cambridge University Press, Cambridge, 2000.

- [40] M. Shearer. Nonuniqueness of admissible solutions of Riemann initial value problems for a system of conservation laws of mixed type. *Arch. Rational Mech. Anal.* 93(1):45–59, 1986.
- [41] M. Shearer, D. G. Schaeffer, D. Marchesin, and P. Paes-Leme. Solution of the Riemann problem for a prototype 2×2 system of non-strictly hyperbolic conservation laws. *Arch. Rational Mech. Anal.* 97(4):299–320, 1987.
- [42] M. Slemrod. Admissibility criteria for propagating phase boundaries in a van der Waals fluid. *Arch. Rational Mech. Anal.* 81(4):301–315, 1983.
- [43] J. Smoller. *Shock Waves and Reaction-Diffusion Equations*. Springer, New York, 1994.
- [44] E. Stade. *Fourier Analysis*, volume 69 of *Pure and Applied Mathematics*. Wiley, New York, 2005.
- [45] W. Strauss. *Partial Differential Equations: An Introduction*, second edition. Wiley, New York, 2008.
- [46] G. B. Whitham. *Linear and Nonlinear Waves*. Wiley, New York, 1974.
- [47] C. C. Wu. New theory of MHD shock waves. In M. Shearer, ed., *Viscous Profiles and Numerical Methods for Shock Waves*. SIAM, Philadelphia, 1991.

Index

- absorbing boundary condition, 88–90
- amplitude, 43, 77, 114–115, 179
- avalanche model, 36–38, 209–210, 223
- backward characteristics, 51
- balance law (*see also* conservation law), 11, 22–26, 45, 191, 196
- Banach Fixed-Point Theorem, 256
- Banach space, 102, 218, 260–261
- beam equation, 17, 94–96
- bending modulus, 94
- Benjamin-Bona-Mahoney (BBM) equation, 17
- Bessel functions, 127
- Bessel's inequality, 109–111, 156
- bifurcation, 234–235
- bilinear functional, 168, 170, 172
- bilinear operator, 235
- bistable equation, 181–186
- boundary conditions, 3–4, 7
 - absorbing, 88–90
 - clamped-beam, 95
 - Dirichlet, 3, 75, 82–85, 89, 101, 124, 125, 127, 129, 134, 146, 149, 158
 - homogeneous, 4, 86, 100, 126, 134–136
 - inhomogeneous, 4, 90–91
 - Neumann, 4, 72, 75, 85–87, 89, 101, 102, 125
 - radiating, 88–89
 - Robin, 88, 101, 102
 - stress-free, 53, 225
- Brownian motion, 65
- Burgers equation, 5–6, 175–176, 206–208
 - Cole-Hopf transformation, 5, 175, 207
 - inviscid, 4–5, 7–8, 25–26, 38–40, 189–195

cantilevered beam, 95

Cauchy, Augustine-Louis, 17

Cauchy inequality, 153

Cauchy-Kovalevskaya Theorem, 11, 17, 20–21, 81

Cauchy problem, 32–40, 204, 207–211, 215, 218, 232

- approximate solutions, 241–242
- energy method and uniqueness, 56–59, 73–74
- Fourier transform, 116
- fundamental solution, 66–72
- heat equation, 68–74
- method of characteristics, 32–38
- scalar conservation laws, 196
- semi-infinite domain, 53
- wave equation, 49–51

Cauchy-Schwartz inequality, 155, 162–164, 169,

Cauchy sequence, 102, 111, 156, 158, 166, 171, 260

centered rarefaction waves, 190–191, 193, 194, 196, 198, 226, 227, 236

chain rule, 14, 18, 30, 184, 254

change of variables, 15, 30, 66, 71, 116, 190, 197

characteristics, 65, 78, 85, 108, 189, 237, 241, 249

- initial value problems, 29–40
- d’Alembert’s solution, 48–56
- Lax entropy condition, 194–195
- systems of conservation laws, 219–222
- undercompressive shocks, 204–211
- variable coefficients, 217–219

clamped-beam boundary conditions, 95

classification, 12–16

closure, 51, 253

codimension one, 165

Cole-Hopf transformation, 5, 175, 207

combustion, [38](#), [65](#)

compact support, [51](#), [71](#), [78](#), [120–121](#), [137](#), [144](#), [158](#), [202](#), [232–233](#), [253](#)

completeness, [102–106](#), [110–112](#), [156](#), [159](#), [162](#), [166](#), [171](#), [255–256](#), [260](#)

conservation law (*see also* [balance law](#)), [4](#), [11](#), [21](#), [24](#), [38](#), [43](#), [143](#), [245](#), [248](#)

- scalar conservation laws, [189–211](#)
- systems of first-order hyperbolic PDE, [215–242](#)

constitutive law, [22–25](#), [45](#), [245](#), [248](#)

contact discontinuity, [250](#)

continuous dependence on data, [11](#), [12](#), [21](#), [50](#)

continuous functions, [50](#), [81](#), [102–104](#), [135](#), [217–218](#), [259](#)

continuum mechanics, [21](#), [215](#)

contraction mapping principle, [218](#), [256](#)

convection-diffusion, [175](#)

convergence, [66](#), [69](#), [71](#), [81](#), [82](#), [166](#), [171](#), [176](#)

- convergence in the norm, [102](#)
- distributions, [140](#)
- Fourier sine series, [84–85](#)
- Gibbs phenomenon, [113–114](#)
- ℓ^2 , [156–157](#)
- L^2 , [110–112](#)
- Laplace's equation, [127–130](#)
- pointwise, [103–108](#)
- Poisson's equation, [120–122](#)
- power series, [19–20](#)
- test functions, [137–140](#)
- theorems, [259–261](#)
- uniform, [87](#), [108–110](#)

convex function, [199](#), [201](#), [203](#), [257](#)

convolution product, [71](#), [120](#), [121](#), [129](#), [138](#)

d'Alembert solution, [43](#), [48–56](#), [58–61](#), [78](#), [91](#)

dam-break problem, [239–241](#)

Darcy's law, [198](#)

density, [5](#), [6](#), [21–26](#), [94](#), [116](#), [119](#), [221](#), [223](#)

- fluid mechanics, [245–247](#)
- traffic flow, [197–198](#)

dependent variable, [2](#)

differential operator, [13](#), [14](#), [48](#), [100–101](#), [112](#), [135](#), [157](#), [167](#), [172](#)

- Green's functions, [144–145](#)
- symmetric operator, [167](#), [168](#)

diffusion, [1–3](#), [23](#), [65](#), [179](#), [207](#)

diffusion equation, [23](#)

Dirac delta function, [71](#), [106](#), [136](#), [202](#)

Dirichlet boundary conditions, [3](#)

- boundary value problem, [125](#)
- energy principle, [75](#)
- Green's functions, [134](#)
- heat equation, [82–86](#)
- Laplace's equation, [127](#)
- maximum/minimum principle, [124](#)
- method of images, [149](#)
- Poisson's equation, [146](#)
- Poisson's formula, [129](#)
- symmetry, [101](#)

Dirichlet kernel, [106](#), [129](#)

dispersion relation, [16–17](#), [95](#), [177](#)

displacement, [1–3](#), [24](#), [44](#), [48](#), [49](#), [51](#), [55](#), [133](#), [220](#), [223](#)

distributional derivative, [141](#)

distributions, [71](#), [87](#), [136–144](#), [202](#), [232](#)

- convergence, [140](#)
- regular, [139](#), [142](#), [144](#)
- singular, [120](#), [139](#)

divergence form, [167](#)

divergence theorem, 22–24, 146, 210, 246, 256

domain of dependence, 51–52, 58

dominated convergence theorem, 138, 260

dual space, 138

Duhamel’s principle, 57–59, 77–78

eigenfunction, 66, 84–86, 99–101, 112, 128

eigenvalue problem, 15, 84, 112, 168, 205, 230, 248, 263

- absorbing boundary conditions, 89
- bifurcation, 234
- characteristic speeds, 219
- eigenfunctions for ODE, 99–102
- elastic string equations, 223, 225–227
- Fisher’s equation, 180–182
- heat equation, 84–91
- linear systems, 215–216
- p -system, 221
- wave equation, 92–93

elastic modulus, 46, 94

elastic rod, 43–46

elastic string equations, 43, 46–48, 57, 223–226

elasticity, 11, 17, 24, 38, 43, 133, 204, 220, 245

elliptic PDE, 13–17, 45, 103, 119, 158, 161, 232

energy function, 23, 56, 75, 87, 247

energy method, 43, 56–57, 65–66, 67, 73–75, 125, 177, 180

entropy flux, 201, 202

entropy inequality, 202–203

equation of state, 5, 248, 249

equivalence class, 104, 154

essential supremum, 154, 158, 259

essentially bounded, 154

Euclidean norm, 102, 157

Euler equations, 6, 247–250

Euler formulas, 82, 84, 91, 105

Eulerian variables, 30, 44

evolution equation, 2, 6

- existence, 11–12, 18–20, 50, 57, 66, 73, 103, 165, 218, 226
- bistable equation, 183–185
- elliptic theory, 168–176
- method of characteristics, 33–38
- Poisson’s equation, 161–162

extension, 55, 60, 72–73, 82, 87, 92, 113

Fick’s law, 23, 179

Fisher’s equation, 4–5, 179–180

flux, 22–26, 73, 88, 125, 179, 196, 256

- entropy flux, 201
- convex flux function, 189, 196, 197, 201–204
- non-convex flux function, 198–199

Fourier coefficients, 82–94, 109–113, 114, 126, 129

Fourier mode, 16–17, 177

Fourier series, 81–114, 129, 155

- convergence, 84, 90, 102–114
- convergence in L^2 , 110–112
- Gibbs phenomenon, 113–114
- pointwise convergence, 105–108
- uniform convergence, 108–110

Fourier transform, 13, 95, 114–117

Fourier’s law of heat conduction (transfer, flow), 23, 72, 179

frequency, 16, 17, 21, 91, 95, 114–115, 177

Fubini’s theorem, 257

fundamental solution, 65, 72, 116, 207

- Duhamel’s principle, 77–78
- Green’s functions, 133–147

heat equation, [66–68](#)

Poisson’s equation, [119–122](#)

fundamental theorem of calculus, [24–25](#), [256](#)

gamma function, [253](#), [255](#)

genuine nonlinearity, [219](#), [226](#), [231](#), [249](#)

Gibbs, Josiah, [113](#)

Gibbs Phenomenon, [113–114](#)

Green, George, [133](#)

Green’s function, [65](#), [127](#), [130](#), [133–138](#), [144–149](#), [161](#)

- fundamental solution, [133–147](#)
- method of images, [147–149](#)

Green’s identity, [121](#), [125](#)

Green’s theorem in the plane, [256](#)

group velocity, [17](#)

Hadamard, Jacques S., [11](#), [21](#)

Hamiltonian, [178](#), [180](#), [186](#)

Hamilton-Jacobi equations, [29](#)

harmonic function, [120–125](#), [129](#), [146–148](#)

- maximum principle, [123](#)
- mean value property, [122](#)

heat equation, [2–3](#), [5](#), [13](#), [15](#), [17](#), [23](#), [65–78](#), [81–91](#)

- Cauchy problem, [68–72](#)
- Duhamel’s principle, [77](#)
- energy method, [65](#), [73–74](#)
- fundamental solution, [65](#), [66–68](#), [72](#), [77–78](#), [116](#), [207](#)
- maximum principle, [65](#), [75–77](#)
- separation of variables, [66](#), [82–90](#)

heteroclinic orbit, [183–186](#), [205](#)

Hilbert space, [103](#), [104](#), [156](#), [159](#), [164–170](#), [260](#)

Hölder’s inequality, [154–155](#)

Holmgren, Erik, [20–21](#)

homoclinic orbit, [178](#), [182–183](#)

homogeneity, [4](#), [94](#)

homogeneous boundary condition, [4](#), [72](#), [86](#), [125](#), [126](#)

- eigenfunctions, [100–101](#)
- Green's functions, [134–136](#)

Hooke's law, [45–46](#), [221](#), [224–225](#)

Huygens' principle, [43](#), [59](#), [61](#)

hyperbolic PDE, [13–15](#), [43](#), [65](#), [78](#), [215](#), [248](#)

ill-posedness, [11](#), [17](#), [21](#)

implicit function theorem, [38](#), [234–235](#), [255](#)

incompressibility, [6](#), [119](#), [246](#)

independent variable, [2](#)

inhomogeneity, [4](#)

inhomogeneous boundary condition, [90](#)

initial condition, [2–3](#), [7](#), [9](#), [11](#), [21](#), [50](#), [53](#), [58](#), [69](#), [78](#), [102](#), [142](#), [189](#), [190](#), [195](#)

- Cole-Hopf transformation, [207–211](#)
- dam break problem, [240–241](#)
- dispersion relation, [16–18](#)
- linear systems, [215–217](#)
- method of characteristics, [29–39](#)
- separation of variables for heat equation, [83–86](#)
- separation of variables for wave equation, [91–95](#)
- systems of hyperbolic conservation laws, [231–232](#)

integral average, [122–124](#), [254](#)

integral kernel, [129](#), [133](#), [135](#)

inverse function theorem, [33–36](#), [255](#)

inviscid Burgers equation, [4](#), [7–8](#), [25–26](#), [38–40](#), [189–195](#), [197](#)

Jacobian matrix, [34](#), [180](#), [181](#), [205](#), [219](#), [255](#), [263](#)

kinetic energy, [43](#), [56](#), [177](#), [247](#)

Korteweg-deVries (KdV) equation, [5](#), [17](#), [176–186](#), [204](#)

Kovalevskaya, Sofia Vasilyevna, [17](#), [20](#), [21](#), [81](#)

L^∞ space, [154](#)

ℓ^2 space, [155–156](#)

L^2 space, [100](#), [104](#), [164](#)

L^p space, [154–155](#)

Lagrangian variables, [30](#), [44](#), [221–222](#)

Laplace's equation, [3](#), [13](#), [17](#), [21](#), [66](#), [119–130](#)

- cylindrical domains, [127–130](#)
- fundamental solution, [119–122](#)
- Hadamard ill-posedness, [21](#)
- polar coordinates, [127](#)
- rectangular domain, [125–127](#)
- separation of variables, [125–130](#)
- spherical domains, [127–130](#)

Laplace, Pierre-Simon, [119](#)

Laplacian, [2](#), [119](#), [121](#), [127](#), [146–149](#), [179](#)

Lax entropy condition, [183](#), [194–195](#), [196](#), [201–206](#), [211](#), [236–238](#), [241](#), [250](#)

Lax-Milgram theorem, [170–172](#)

Lebesgue-integrable functions, [104](#), [157](#)

Lebesgue measure, [104](#), [259](#), [260](#)

Leibniz integral rule, [257](#)

Lighthill-Whitham-Richards model, [25](#)

linear PDE, [2](#), [4](#)

linear transport equation, [2](#), [4–7](#), [16](#), [48](#), [177](#), [216](#)

linearly degenerate, [219](#), [221](#), [249](#)

locally integrable function, [138–139](#), [141](#), [144](#)

logistic equation, [5](#), [179](#)

Lyapunov-Schmidt reduction, [235](#)

maximum principle, [12](#), [65](#), [75–77](#), [122–125](#)

mean-value property, [122–124](#), [129](#)

measurable function, [104](#), [154](#), [259–260](#)

measure zero, [104](#), [259](#)

method of characteristics, [4](#), [65](#), [78](#), [85](#), [108](#), [189](#), [237](#), [241](#), [249](#)

- [d'Alembert's solution](#), [48–56](#)
- [initial value problems](#), [29–40](#)
- [Lax entropy condition](#), [194–195](#)
- [systems of conservation laws](#), [219–222](#)
- [undercompressive shocks](#), [204–211](#)
- [variable coefficients](#), [217–219](#)

[method of images](#), [147–149](#)

[method of spherical means](#), [59–61](#)

[minimum principle](#), [77](#), [124](#)

[mollifier](#), [137–138](#)

[momentum](#), [6](#), [21–24](#), [44–46](#), [177](#), [222–248](#)

[monotone convergence theorem](#), [157](#), [259](#)

[multi-index notation](#), [157–158](#)

[Navier-Stokes equations](#), [ix](#), [6](#), [222](#), [245–247](#)

[Neumann boundary condition](#), [4](#), [72](#), [75](#), [85–87](#), [88–89](#), [101](#), [102](#), [125](#)

[noncharacteristic curve](#), [34–36](#)

[nondimensionalization](#), [94](#), [246–247](#)

[nonlinear heat equation](#) [93–94](#)

[nonlinear PDE](#), [16](#)

[nonlinear small disturbance equation](#), [16](#)

[nonlinear transport equation](#) [196](#), [248](#)

[open ball](#), [121](#), [253](#)

[order of a PDE](#), [2](#)

[orthogonal](#), [6](#), [14](#), [15](#), [81](#), [86](#), [88](#), [100](#), [101](#), [111–112](#), [165](#), [220](#), [257](#)

[orthonormal](#), [14](#), [108](#), [110–112](#), [156](#), [257](#)

[oscillations](#), [17](#), [93](#), [113](#), [180](#)

[parabolic boundary](#), [76–77](#)

[parabolic manifold](#), [205](#)

[parabolic PDE](#), [13–16](#), [65](#), [71](#), [75](#), [78](#), [103](#), [159](#), [179](#)

[Parseval's identity](#), [111–113](#), [156](#)

partial differential equation, 1–2

periodic extension, 82, 87, 92, 113

phase speed (phase velocity), 17

physical configuration, 43–44

plane waves, 179

Poincaré inequality, 162–164, 169

pointwise convergence, 102–117, 129

Poisson kernel, 129–130

Poisson’s equation, 119–121, 161–166

- maximum principle, 122–125
- uniqueness, 124

Poisson’s formula, 129–130

population models, 5, 65, 179–180

porous medium equation, 5, 78, 93

- separation of variables, 93–94

potential energy, 43, 56

power series, 17–18, 19, 21, 81

principal part, 13–14, 16

principal symbol, 13–14, 16, 173

p -system, 215, 220–222, 223, 226

- propagation of singularities, 229–230
- rarefaction waves, 228
- Riemann problem, 236–239
- shock formation, 230–232
- weak solutions and shock waves, 232–234

quarter-plane solution, 53–54, 72

quasilinear first-order equation, 32, 35

quasilinear PDE, 28, 157

quasilinear wave equation, 16, 220, 223, 248

radiating boundary condition, 88–89

random choice method, 242

random walk, [65](#)

Rankine-Hugoniot condition, [143](#), [202](#), [210](#), [241](#)

- Euler equations, [249–250](#)
- inviscid Burgers equation, [191–198](#)
- Riemann problem, [236–237](#)
- systems, [233–234](#)

rarefaction wave, [190–200](#), [219](#), [226–228](#), [236–242](#), [249](#)

real analytic, [19–21](#)

reference configuration, [43](#), [44](#), [222–224](#)

region of influence, [51–52](#), [71](#)

regularity, [12](#), [50](#), [57](#), [66](#), [78](#), [103](#), [110](#), [153](#), [162](#)

Reynolds number, [246–247](#)

Riemann invariant, [219–223](#), [230–231](#), [241](#)

Riemann-Lebesgue Lemma, [106–109](#)

Riemann problem, [190–195](#), [200](#), [206](#), [236–241](#)

Riesz representation theorem, [164–166](#), [168–172](#)

Robin boundary conditions, [88](#), [101](#), [102](#)

scale invariance, [66](#), [189–190](#)

semilinear wave equation, [16](#)

separation of variables, [21](#), [66](#), [81–96](#), [100](#), [125–130](#), [177](#), [210](#)

- beam equation, [94–95](#)
- Fourier series, [81](#)
- heat equation, [82–90](#)
- nonlinear heat equation, [93](#)
- wave equation, [91–92](#)

series, [47](#), [66](#), [155](#), [157](#)

- convergence, [99–117](#)
- Fourier series, [81–88](#), [90–93](#)
- Laplace's equation, [126–130](#)
- power series, [18–21](#)
- Taylor series, [254–255](#)

shallow water equations, [6](#), [222–223](#), [239–242](#)

shock wave, [4](#), [8](#), [38](#), [143](#), [176](#), [186](#), [219](#), [249](#)

- admissibility, [236–237](#)
- bifurcation theory, [234–236](#)
- formation, [230–232](#)
- inviscid Burgers equation, [191–195](#)
- Lax entropy condition, [201–211](#)
- p -system, [238–239](#)
- weak solutions, [232–234](#)

shooting argument, [183](#)

singularity, [4](#), [35](#), [78](#), [119–121](#), [130](#), [146–147](#), [156](#), [158](#)

smoothness, [12](#), [50](#), [57](#), [66](#), [78](#), [103](#), [110](#), [153](#), [162](#)

Sobolev space, [158–159](#), [161–172](#)

solitary wave, [5](#), [175–179](#), [183](#)

solution of a PDE, [3](#)

stability, [11](#), [211](#)

stable manifold, [182–184](#)

Stokes equations, [247](#)

Stokes' theorem, [256](#)

strain, [45–47](#), [156](#), [220–224](#)

strain softening, [45](#), [221](#)

stress, [21](#), [44–46](#), [53](#), [220–221](#), [224–225](#)

stress-free boundary condition, [53](#), [225](#)

strict hyperbolicity, [215](#), [221](#), [223](#), [225–226](#), [235](#)

strictly convex flux, [202–203](#)

strong maximum principle, [77](#), [123–124](#)

Sturm-Liouville problem, [99–101](#), [112–113](#)

sup norm (uniform norm), [102–103](#), [218](#)

superposition, [176](#)

support of a function, [51–52](#), [54](#), [71](#), [78](#), [120–121](#), [137](#), [144](#), [158](#), [202](#), [232–233](#), [253](#)

symmetric differential operator, [101](#), [167](#), [168](#)

systems of PDE, [204](#), [215–241](#)

- characteristics, [215–219](#)
- conservation laws, [219–220](#)
- elastic string equations, [223–226](#)
- genuine nonlinearity, [219](#), [226](#), [231](#), [249](#)
- hyperbolicity, [219–221](#), [223](#), [225](#), [248–249](#)
- linear systems, [215](#)
- p -system, [215](#), [220–222](#), [223](#), [226](#), [228–232](#), [237–239](#)
- Rankine-Hugoniot condition, [233–236](#)
- rarefaction wave, [219](#), [226–230](#), [236–242](#), [249](#)
- Riemann invariant, [219–223](#), [230–231](#), [241](#)
- shallow water equations, [222–223](#), [239](#)
- shock formation, [230–234](#), [236–237](#)
- strict hyperbolicity, [219](#)

Taylor Series (Taylor’s theorem), [19](#), [254](#)

test functions, [136–144](#), [157](#), [167](#), [202](#), [232–233](#)

trace theorems, [159](#)

traffic flow model, [24–26](#), [191](#), [197–199](#)

translation invariance, [60](#), [68](#)

traveling wave, [2](#), [5–8](#), [16–17](#), [91](#), [175–186](#), [204–206](#), [216](#)

triangle inequality, [50](#), [70](#), [107](#), [112](#), [154–155](#), [260](#)

Tricomi equation, [16](#)

ultrahyperbolicity, [15](#)

undercompressive shock, [204–206](#)

uniform convergence, [50](#), [69](#), [85](#), [102–117](#), [137](#), [261](#)

uniform norm (sup norm), [102–103](#)

uniqueness, [3](#), [6–7](#), [11–12](#), [18](#), [30](#), [65](#), [124](#), [142](#), [230](#)

- Cauchy problem, [49–50](#)
- elliptic theory, symmetric case, [168–172](#)
- energy method, [56–57](#), [73–74](#)
- fixed point, [218–219](#)

Holmgren theorem, 20

implicit function theorem, 255–256

ODE theory, 33–35

Poisson’s equation, 161–166

rarefaction waves, 190–193

shock waves, 236–237

unit normal, 121, 253, 254

unstable manifold, 182–185

vibrating string, 46–52, 91

viscosity, 5, 6, 207, 247

wave equation, 2–3, 13, 43–61, 71, 72, 108, 158, 224, 248

- balance laws, 23–24
- characteristics, 48–49
- d’Alembert’s solution, 48–19
- domain of dependence, 51–52, 58
- Duhamel’s principle, 57–59, 77–78
- energy, 56–57
- method of spherical means, 59–61
- nonlinear, 17
- quasilinear, 16
- region of influence, 51–52, 71
- semilinear, 16
- separation of variables, 91–93
- system, 216–217
- uniqueness, 56–57
- vibrating string, 46–52, 91

wave front tracking, 241

wave number, 13, 16–17, 21, 95, 177

wave speed, 2, 4, 6, 7, 17, 29, 43, 48, 52, 71, 242, 254

- Burgers equation, 175–177

weak convergence, 87

weak derivative, [144](#), [157](#), [158](#), [162](#)

weak formulation, [164](#), [232](#)

weak maximum principle, [77](#), [124–125](#)

weak solution, [3](#), [40](#), [50](#), [103](#), [172](#), [206](#), [210](#)

- [inviscid Burgers equation](#), [189–193](#)
- [Poisson's equation](#), [161–162](#)
- [second-order linear elliptic equations](#), [167–168](#)
- [systems](#), [231–237](#)

Weierstrass M-test, [87](#), [261](#)

well-posedness, [ix](#), [11–12](#), [21](#), [49](#), [50](#), [153](#), [191](#)

Whitham, G. B., [17](#), [25](#), [177](#), [208](#)

Young's inequality, [153–154](#), [172](#)