

Staatliche Uhrmacherschule

10/10/16





# THE JEWELERS' CIRCULAR

AND HOROLOGICAL REVIEW.

Copyright, by THE JEWELERS' CIRCULAR PUB. CO.

189 Broadway, New York.

Entered at the Post Office in N. Y. as second-class matter.

VOL. XXVII.

NEW YORK, WEDNESDAY, AUGUST 2, 1893.

NO. 1.

## A GLIMPSE OF THE GORHAM MFG. CO.'S EXHIBIT.

### PART VIII.

ALTHOUGH the rules and regulations laid down by the magnates of the World's Fair, state that additions to exhibits are to be made only on condition that a special permit be granted exhibitors, the Elmwood works of the Gorham Mfg. Co. have continued to produce articles which were originally designed as part of the exhibit. A special dispensation was obtained in the case of the statue of Columbus. Among the pieces lately completed is a dainty design from the pencil of Mr. Codman in the form of a jardiniere or center bowl. It is intended as a yachting prize and is full of action and life. The general outline is that of a boat resting upon the waves, the prow assuming the graceful form of a swan's neck and head. About the sides of the boat are several nymphs suspending graceful festoons, and a tiny nymph at the stern represents the rudder. Seated in the raised stem of the boat is the winged figure of Victory with uplifted hand holding the victor's palm. A shield on the stern and one on either side are designed to bear inscriptions. The piece is about 14 inches long, stands about 8 inches high and is intended as a silver trophy.

A magnificent centerpiece or epergne for a dinner set has just received the finishing touches. It consists of a plateau with mirrored surface, which supports a central piece and four compotiers. The central piece is in the form of a plant or group of branching spear like leaves spreading outward and bearing twenty-four tiny incandescent elec-

tric lamps. The entire piece is of silver gilt (gold plated sterling silver) except the glass

four compotiers. A fine wire connects from the bottom through the table and passes through the central piece to the little lamps on the leaves. The general effect of the golden piece is rich and beautiful, but when the current is turned on and the lights blaze out upon the vibrating leaves, the appearance is dazzling in brilliancy. The novelty of conception and wonderful workmanship in the frail design make this indeed among the features of the exhibit. A bayonet lock allows the removal of the upper part of the central piece and the substitution of a candelabra bearing nine candles. Thus, if electricity is not obtainable or is undesirable, the piece becomes equally valuable, though hardly as brilliant, as a table ornament of similar purport. The full height of the piece is two inches short of three feet, and its approximate value is \$2,000.

A handsome illustration of the fine colored enameling is seen in a dainty tankard or pitcher in silver gilt and colors. The design is an allegorical "creation." At the base is represented the waters surrounding the world with the forms of antediluvian animals emerging therefrom and a volcano in eruption. The central band shows the sun rising in splendor and above is the cerulean vault with stars of gold, with the star of Bethlehem prominent among its fellows. The band above the sun bears the signs of the zodiac. The handle represents a heathen god and the top or cover is of gold stars. The outlines of the figures

(Continued on page 22.)

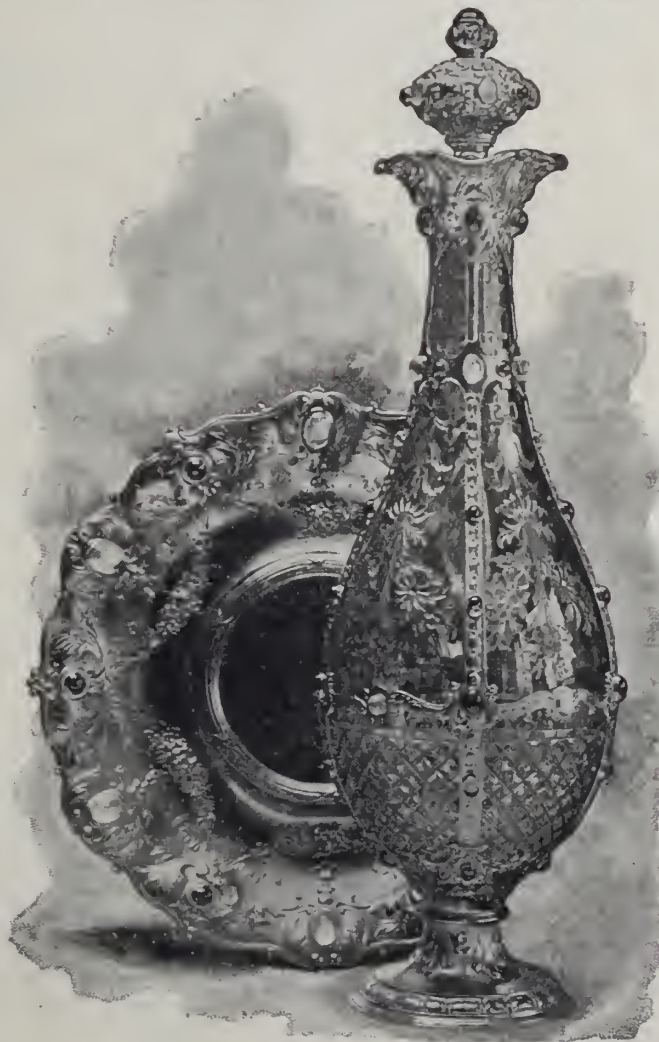

DECORATED GLASS, SILVER MOUNTED TOILET SET.

mirror of the plateau and the colored glass dishes, designed for fruit or flowers, of the

with blue



have in 45 years earned the reputation of being the standard in quality, style, finish and durability. They are made of solid gold, in great variety, for men, women and children.

**ASK YOUR JEWELER FOR THEM.**

If he don't keep them and won't send for them, send us your money and we will deliver them through the nearest reliable jeweler.

**Our Initial and Railroad Brotherhood Rings**

With or without diamonds, are the handsomest made.



**M. B. BRYANT & CO.,** No. 10 Maiden Lane, New York.  
OLDEST RING MAKERS IN AMERICA.

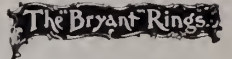

Are extensively advertised in the leading magazines, Family, Religious and Fashion papers for the benefit of the Retail Jeweler.

The adjoining advertisement will appear for a year in the great

**R. R. BROTHERHOOD** Journals.

PRICES of our INTERCHANGEABLE Rings either with emblems with six diamonds, or without diamonds will be sent to Jewelers only on application.



**MUELLER'S ARTIFICIAL EYES.**

\$75 per hundred; smaller lots, \$15 per dozen; \$2 each. A large assortment of eyes will be sent to any dealer to enable him to make selection, upon receipt of satisfactory references. We carry the largest stock in America.

ONLY MANUFACTURERS OF THE "DIAMANTA" SPECTACLES AND EYE-GLASSES.

Oculists' prescriptions promptly and accurately filled. Catalogue, price lists, test cards, etc., on application.

**M. ZINEMAN & BRO.,** American Agents, 130 South Ninth St., Philadelphia.

**J. H. DEDERICK, JR.,**

—DEALER IN—

**Roll Plate Jewelry and Chains,**

Optical Goods and Jewelers' Supplies,

**16 MAIDEN LANE, NEW YORK.**

JET GOODS A SPECIALTY.

**VICTOR.**

SIMPLEST FEED. ALWAYS THE SAME. GUARANTEED FOR ONE YEAR.

**THE VICTOR FOUNTAIN PEN.**

(Pat. Feb. 4, 1890.)

**THE BOSTON PEN CO.,**

N. C. Whitaker & Co., Proprietors.

363 Washington Street, - Boston, Mass.,

Manufacturers of finest quality

TORTOISE : SHELL : AND : HORN : GOODS

in every variety Also Aluminum Hair Pins.

Send for Illustrated Pen Price List No. 1.



**THE BONNER COMBINATION**

RING, SCARF PIN AND STUD.

The Best Combination ever made.

MANUFACTURED BY

**BONNER, RICH & Co.,**

Makers of DIAMOND MOUNTINGS

RINGS A SPECIALTY.

To the Jobbing Trade Only.

41 MAIDEN LANE, NEW YORK.  
Factory, 44, 46 and 48 Hill St., Newark, N. J.

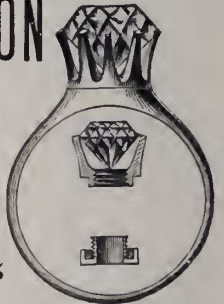

**Aikin Lambert Jewelry Co.**  
Importers of  
**Diamonds**  
Jobbers in **WATCHES,**  
Jewelry Chains etc.  
19 Maiden Lane.  
*New York*

JAMES C. AIKIN, Pres.  
JOHN B. SHEA V.-Pres.

SAM'L B. MANN, Treas.  
FRED. D. ILGEN, Sec'y

ESTABLISHED 1876  
**J. B. Humphrey**  
**DIAMOND GUTTER**  
IMPORTER OF  
**DIAMONDS & OTHER GEMS**  
383 WASHINGTON ST  
BOSTON MASS.  
ATTENTION TO CUTTING AND BEARING

**IRONS & RUSSELL,**  
(SUCCESSORS TO CHARLES F. IRONS.)  
MANUFACTURERS OF  
**SOLID GOLD EMBLEMS ROLL PLATE**  
PINS, CHARMS AND SOLID GOLD RINGS.

102 Friendship Street, - - Providence, R. I.

**OPTICIANS' SUPPLIES**  
Jobbing and Prescription Work.  
The "Graduate" Trial Cases, 180 lens set, \$30.00; 220 lens set, \$37.50. The "Standard" Trial Case, 220 lens set, \$65.00. All with lenses. Loring Ophthalmoscope, \$9.00. Artificial Eyes, for selection, \$1.00 each; \$30.00 per hundred. Ophthalmometers, \$50.00 to \$70.00. Queen's Standard Perimeter, \$18.50. Queen's Lens Grinding Outfit, \$3.00. Steel Frames, 15 to 30 cents each. Spherical Lenses, 25 cents per pair. Cylinders, 3 to 5 cents per pair. Lenticular Bifocals, 80 cents per pair, all by mail. Nose Pieces, for Shell German Silver, \$1.00 per pair. Total, \$2.00 per dozen pairs.

**QUEEN & CO.** Opticians and  
Catalogue free. 1010 Chestnut St., Phila., Pa.

THE BEST QUALITY  
ELECTRO SILVER PLATE

IS STAMPED

★ ROGERS & BRO., A. I.

The Original, Genuine and Celebrated  
STAR BRAND

WHICH HAS STOOD THE TEST FOR 50 YEARS.

MADE ONLY BY

ROGERS & BROTHER,

WATERBURY, CONN.

16 CORTLANDT ST., NEW YORK.

---

Exclusive makers of the

“COLUMBIA,”

“SAVOY,”

AND “TUXEDO”

patterns.

# “DO YOU KNOW?”

**THAT** GOODS **FREE** FROM SOLDER ARE THE **BEST** ?

**THAT** GOODS MADE FROM **SEAMLESS WIRE** ARE **SUPERIOR** IN **FINISH** ON THIS ACCOUNT?

**THAT** **SEAMLESS WIRE** MAKES THE **BEST** FILLED CHAINS?

**THAT** WE ARE THE MAKERS OF THE **ORIGINAL** AND CELEBRATED

## Seamless Gold Filled Chains?

Do not fail to visit our beautiful and artistic display at the World's Fair. The finest of its kind at the Exposition.



Northeast Corner of Manufactures Building, Department O. Right on the corner. See Official Catalogue.

# KENT & STANLEY CO.,

### *Branch Offices :*

NEW YORK, 17 Maiden Lane.

BOSTON, 58 Winter Street.

SAN FRANCISCO,  
Phelan Building.

MONTREAL, Temple Building.

Main Office and Works

PROVIDENCE, R. I.



# THE FAIRPOINT MFG. COMPANY.

NEW BEDFORD, MASS.

GOLD  
AND  
SILVER  
PLATE.



NO. 114.—TETE-A-TETE SET, BURNISHED TOP.

SALESROOMS:

NEW YORK,  
20 Maiden Lane.

CHICAGO,  
224 Wabash Ave.

SAN FRANCISCO,  
220 Sutter Street.

Our Exhibit at the World's Columbian Exposition may be found in Section N, Manufactures and Liberal Arts Building.

## CHAS. L. UHRY & Co.

N. Y. OFFICE,  
189 BROADWAY.

- SCARF PINS,
- BROOCHES,
- CHARMS,
- FOBS.
- HAT PINS,
- HAIR PINS,
- CHATELAINES.

336 Mulberry St., Newark, N. J.

## CHAS. L. UHRY & Co.

### Bruner Plating and Jewelry Rep. Co.

Jewelry Matched and Repaired, Engraving, Chasing and Enameling, Setting, Polishing and Lapping, Battery Gilding and Roman Coloring, Watch Cases Repaired, Polished and Gilded.  
32 Maiden Lane, New York.

We sell to the legitimate Jewelry and Stationery trade only.



CHOICE PAPERS

MAKERS OF

## FINE STATIONERY

For Correspondence, Wedding and Business Use, handsomely boxed, specially suited to the Jewelry Trade.

18 MURRAY STREET, NEW YORK.

# WORLD'S FAIR SOUVENIRS.

\* STERLING SILVER. \*



THE COLUMBUS.



REVERSE SIDE OF HANDLE.



REVERSE SIDE OF HANDLE.



THE DISCOVERER.



REVERSE SIDE OF HANDLE.



THE AMERICAN.

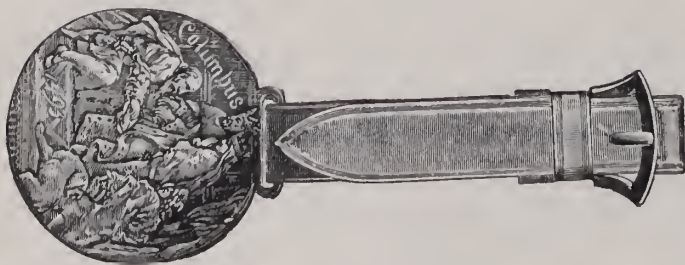

No. 2. BAGGAGE CHECK.

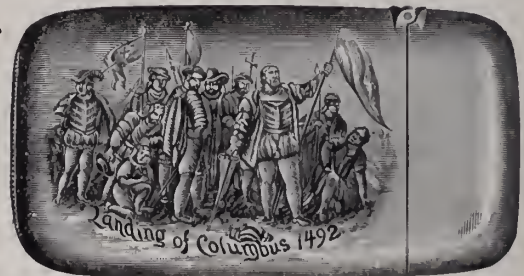

MATCH BOX.

## R. WALLACE & SONS MFG. CO.,

SILVERSMITHS,

WALLINGFORD, CONN.

NEW YORK:  
3 PARK PLACE.

CHICAGO:  
86 WABASH AVENUE.

**The Rockford Silver Plate Co. Obtain a Judgment Against Leo Hollander.**

SALT LAKE CITY, Utah, July 25.—The Rockford Silver Plate Co., Rockford, Ill., some days ago submitted in the Third District Court, on an agreed statement of facts, a claim against Leo Hollander and others for certain goods valued at \$2,666.90, which the plaintiffs allege were consigned to the defendants for sale on commission.

The court has found that the plaintiffs are entitled to the goods, and judgment has been entered accordingly.

**Jeweler H. M. Betz Acquitted of a Charge of Fraud.**

EASTON, Pa., July 26.—Alderman Young, of this city, last week discharged H. M. Betz, the instalment jewelers, of Philadelphia, charged with obtaining money under false pretense, on complaint of S. J. Treat, of Easton, and W. W. Hulmes, of Phillipsburg. The defendant at one time had a branch store on Northampton St., near 5th St., this city, conducted by E. Wright, as agent.

It was shown that Betz had nothing to do with the contracts complained of by the prosecutors. The agreements were made with Wright and his agents and must have been perfectly understood by the prosecutors or else they would not have signed them. It was proven that no deception had been practised.

**Diamonds and Gold Reported Found in Demerara.**

WASHINGTON, D. C., July 27.—A despatch from Panama relates that a wonderful gold discovery in the colony of Demerara has been made and that the governor of the colony claims that the gold fields of British Guinea will equal, if not surpass, those of California and Australia. Diamonds are also being found, so it is reported.

Hundreds of prospectors are flocking into the country and the stories told of the immense amounts of gold picked up almost on the surface are beyond belief. The climate is very unhealthy, however, and many prospectors have already succumbed. The greater number of people arriving are Englishmen.

**The Watch That Told the Time of Day to Bobby Burns.**

DETROIT, Mich., July 28.—Fred H. Hitchcock, of 113 Jefferson Ave., has in his possession a watch which belonged to the Scottish poet Robert Burns, having been presented to him by his friend and patron, James, Earl of Glencairn. The watch is open faced, with small hands, and made of gold; the back of the case is protected by a crystal. In the inside of the case is the inscription, "To Robert Burns, from his friend, James, Earl of Glencairn." The watch is numbered 14616 and was made by Mitchell & Russell, of Glasgow. John Kay, of Wright, Kay & Co., says that when he

**THE BOWDEN SEAMLESS RING**

MADE ONLY BY

**J. B. BOWDEN & Co.,**

Makers of Finger Rings of every Description.

**COR. BROADWAY & JOHN STREET, NEW YORK.**

**J. B. & S. M. KNOWLES CO.,**

MAKERS OF

**Sterling**



**Silverware.**

FACTORY,  
Providence, R. I.

SALESROOM,  
860 Broadway, N. Y.

**CAMPBELL-METCALF SILVER CO.**



176 Broadway, N. Y., Room 14. 66 Stewart St., Prov., R. I. Mills Bldg., San Francisco, 8th Floor, Room 1.

**WOOD & HUGHES, STERLING SILVERWARE MANUFACTURERS.**

New York Agents for the Derby Silver Co.'s FINE QUADRUPLE PLATED WARE, NO. 16 JOHN STREET, NEW YORK. 206 Kearney St., San Francisco, Cal. HASKELL & MUEGGE, Agents.



**ARTISTIC  
METAL  
GOODS.**

NEW DESIGNS,  
NEW FINISHES.

Our line of Pitchers, Vases, Tables, Candlesticks, Five O'Clock Teas, Etc., cannot be equaled.

**THE  
CELEBRATED  
"B & H" LAMP.**



BEAUTIFUL DESIGNS,  
particularly adapted to the Jewelry Trade.

SEE OUR LINE OF

**TABLE, BANQUET AND PIANO LAMPS**

before placing your orders. Send for our Little Book.

**BRADLEY & HUBBARD MFG. CO.**  
NEW YORK, BOSTON, CHICAGO,  
21 BARCLAY ST., 160 CONGRESS ST. 88 WABASH AVE.  
26 PARK PLACE Factories, MERIDEN, CT.

**"THE BEST BUTTON MADE."**

THE KREMENTZ

IN GOLD

FROM

**KREMENTZ & CO.**

And all Jobbers.



ONE PIECE

IN ROLLED PLATE

FROM

ALL JOBBERS.

**COLLAR BUTTON.**

IS THE ORIGINAL ONE PIECE BUTTON.

IS STILL THE BEST AND STILL UNSURPASSED.

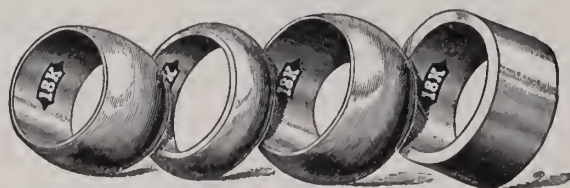

**PLAIN SOLID GOLD RINGS.**

**HILDRETH MFG. CO.,**

53 MAIDEN LANE,

NEW YORK.

learned the jewelry business in Glasgow the firm referred to was then the oldest in that line.

Mr. Hitchcock has possessed the watch, which still keeps excellent time, for a few weeks only. He got it from a Scotchman, now residing in Canada, and who about twenty years ago purchased it from a niece or grand-niece of the poet whom he found residing near the home of her uncle. The poverty which chilled the life of the bard fell to the lot of his niece and compelled her to sell the watch. Everything else had been disposed of.

Experts have told Mr. Hitchcock that the Robert Burns Club, of New York, would gladly give \$1,000 for the relic.

**F. M. Sproehle & Co.'s St. Paul Agent in a Tight Box.**

St. PAUL, Minn., July 27.—Jacob W. Loewenberg was this week placed in the Ramsey county jail on a charge of embezzlement. He has been the agent in this city for F. M. Sproehle & Co., Chicago, with an office in the Endicott Building. He was arrested on a warrant at the instance of his employers, charging him with the embezzlement of \$5,000. He has been in receipt of a salary of \$200 per month, but if the allegations against him can be proven, he has evidently been living beyond his means. It has come to light that he has also recently furnished a suite of rooms in most luxurious taste in the Moore block at Seven Corners.

The young man has hitherto had the full confidence of his employers. The firm have been in the habit of billing goods to him in their own name, each bill being accompanied by an invoice. Each article was properly tagged with the price mark, and Loewenberg was under a contract not to dispose of any goods under a certain per cent. advance on the cost price. It is alleged that he has violated this rule and sold goods at much less than the profit percentage, keeping back all the tags. He made semi-annual reports to the firm. He made one on Feb. 1, 1893 and another on July 1st, 1893. In his statement of Feb. 1st, he reported \$20,000 in stock on hand, and on July 1st, \$12,000 in stock. Between the two dates the firm shipped him, it is said, \$27,000 in stock.

For several days past the head of the firm has been in St. Paul, checking up the statements. So far, it is claimed, the firm have discovered a shortage of \$6,500. Loewenberg, it is further stated, has confessed to having made away with about \$5,000 of the firm's property. A statement was made by him to Herchmer Johnson, the firm's attorney, which covers some fourteen pages of type-written matter. About a year and a half ago the father of the accused occupied the position held by the young man. Loewenberg, Sr., and wife were asphyxiated by gas, and young Loewenberg succeeded his father in the business as the representative of the firm.

The young man has been in \$10,500 bail. The case has been continued till Aug. 8th.

**Inventory of the Estate of W. C. Leber.**

MINNEAPOLIS, Minn., July 26.—The inventory of the insolvent estate of W. C. Leber, as given by the assignee, L. C. Lann, is as follows:

Stock of mdse .....	\$2,587.51
Fistures .....	323.75
Book accounts, good.....	51.25
“ “ doubtful.....	287.60
“ “ worthless .....	1,364.43
Cash in State bank. Bank has assigned.....	356.47
Equity in a farm.....	1,000.00
Lease of store bld'g, including building .....	1,500.00
Total.....	\$7,471.01

The liabilities are not yet ascertained.

**Pfeil & Bredt's Machinery and Tools Sold Out.**

CHICAGO, Ill., July 28.—The machinery and tools of Pfeil & Bredt were bought by several parties at an auction held Friday week. But \$195 was realized, Mr. Pfeil being the largest purchaser. Three men were waiting to attach the goods: Nathan Herman for \$24.10, which Mr. Pfeil paid; Charles Glatz for \$73.94, a private account of Mr. Bredt, but the goods were levied on and could not be sold, so Pfeil paid it; Lawyer Allen had a judgment against the firm in favor of Glorieux & Woolsey, Newark, N. J., refiners, for \$126, which was paid from the

income from the tools; \$100 was paid before from the collection of outstanding accounts.

The amount owed by the firm is less than the outstanding good accounts, but collections are slow and all want their money at once. Mr. Pfeil has rented a place at 182 State St., and will continue in business as soon as old partnership affairs are settled.

**A. Much Wanted Pair in the Police Toils.**

BOSTON, Mass., July 28.—Two young men who have been giving the Boston jewelers considerable trouble lately brought up in the municipal court to-day. They gave the names of George B. McLellan and Frederick Morton, and the pawn tickets found on their persons led to the recovery of some of the goods stolen by the pair.

Their mode of operating was the old one of substituting imitations for genuine diamonds. They dressed in the height of fashion and their clothes were of the most expensive materials. A lady clerk from Parker Bros. identified Morton as the one upon whom she waited and whose advent in the store was followed by the discovery a little later in the day that a cheap pin had been substituted for a diamond scarf pin in a lot shown to him. Thomas Pike told a similar story about McLellan's visit to his place of business.

The police have a number of valuable sleeve buttons and scarf pins, apparently new, which await claimants. It is supposed that they all were obtained from jewelry

stores. The judge held both prisoners in \$500 each for the Grand Jury.

**The American Watch Factory to Start Up with a Reduced Force.**

WALTHAM, Mass., July 27.—The American Waltham Watch Co. announced to-day that the vacation at their big factory in this city will be extended to Aug. 7th, and furthermore that when the wheels begin to go round again only about half the regular complement of employees will be needed.

Mr. Fitch, the superintendent, is reported as stating that the Waltham Watch Co. are not following the lead of the Elgin National Watch Co., but had decided upon their course independently.

Those who are to be given work on the 7th will be notified by the foreman. The reduction is not expected to be a permanent one, and the superintendent says that the unemployed will be taken back collectively or singly according to the condition of business later.

Treasurer Robbins when interviewed on the subject said that the directors could not tell when they should be able to go ahead with the full force. "The whole cause," he added, "is dulness of business which, it is hoped, will be but temporary. There is depression of business everywhere. We have never before had to shut down in this way since the first few months of the Civil War. I am as anxious as any of the employees to start up with a full force. It is

**A NEW AND SUPERB LINE OF TRANSPARENT ENAMEL GOODS.**

**THE FINEST EVER SHOWN IN THIS COUNTRY.**

We are now showing a complete line of Transparent enamel goods in **HAIR PINS**, and **COFFEE, TEA, ORANGE** and **ICE CREAM SPOONS**, with Silver and Mother-of-Pearl bowls of the most delicate and intricate patterns. These goods are superior in finish

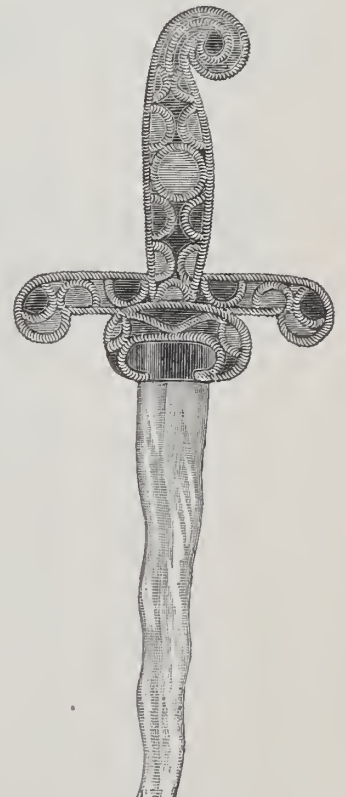
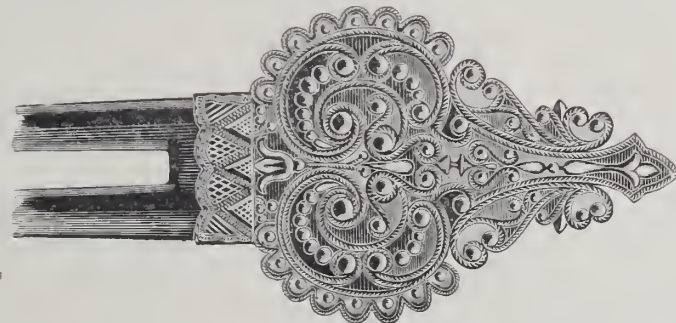

and general workmanship to the finest imported stock, and are sold at half the price. They are fashionable, consequently in great demand, and at our prices will yield large profits.

**PRICES.**

TEA SPOONS, \$24.00 per doz. and up. ORANGE SPOONS, } \$27.00 per doz. and up.  
 COFFEE " 18.00 " " ICE CREAM " }

HAIR PINS, \$1.50 each and up.

Our line of **STERLING SILVER MOUNTED SUSPENDERS** is very complete and comprises many tasty, original and unique designs.

**GARTER BUCKLES.** Twelve different patterns, \$3.50 per pair, with Elastics, 50 cts. extra. Cheapest in the market of the kind.

**J. N. PROVENZANO,**

—→ GOLD AND SILVERSMITH, ←—

39 UNION SQUARE,

NEW YORK.

HAIR PINS, C'ASED KEY RINGS, HAND BLOTTERS, BRAIDED BELTS, BELT BUCKLES, DESK BLOTTERS, BRAIDED NAPKIN RINGS, AND MOUNTINGS FOR LEATHER GOODS OF ALL DESCRIPTIONS.

purely accidental that the Elgin works should close at the same time. There is no connection in that matter at all.

"If earlier notice had been possible it would have been given. The decision was not reached until this week and it was announced at once after it had been made."

#### Elgin National Watch Co. Cut Down Their Force 50 Per Cent.

CHICAGO, Ill., July 29.—The following notice was posted in the Elgin National Watch Co.'s factories at Elgin, July 26:

Taking effect Aug. 1st, there will be a reduction of the working force of this factory equal to at least 50 per cent. Individual notice will be given by the several foremen of departments as early as possible, but this is a general notice to all employees to better their condition in the meantime if possible, and save us the disagreeable duty of discharge.

"Nobody regrets the necessity more than the company itself," said General Manager Cutter. "We have deferred the action as long as possible hoping for a change. We passed the last dividend, and while we owe nothing and have several hundreds of thou-

sands dollars surplus on hand, we may need this to continue even under the restricted production.

"The reduction in the number of employes is caused by the universal depression of trade. As to the continuance of this reduction of force no one can tell; it depends entirely upon the country. As soon as business improves it will follow naturally that the force will be added to as trade requirements demand."

#### The Hartford Silver Plate Co. Absorbed by the Barbour Silver Co.

HARTFORD, Conn., July 30.—The Hartford Silver Plate Co. have finally passed into the hands of the Barbour Silver Co. Arrangements for the consolidation have been going on for some time, but the deal was not consummated until last week.

John L. Dagleish, secretary of the Barbour Silver Co., said that the owners had plans in view for enlarging the business of the combined concerns, but they have not yet been matured. For the present, both shops will be run according to the demands of the business, but it is intended later to consolidate the two plants.

#### A New President for the Bristol Brass and Clock Co.

NEW HAVEN, Conn., July 28.—The annual election of directors and officers of the Bristol Brass & Clock Co. was held at the company's office, Wednesday. The principal business of the meeting was the election of a president of the company, to succeed the late Andrew Fuller Atkins, whose death occurred May 9th. J. Hart Welch, of Forestville, was elected president and J. R. Holley, secretary and treasurer. Henry F. English, of New Haven, who was elected several months ago as director to fill the vacancy caused by the death of A. F. Atkins, was re-elected. J. R. Holley was elected a director to fill the vacancy caused by the death of Hiram Camp, of this city.

The board of directors is now composed of J. R. Mitchell, J. H. Welch, Pierce N. Welch, G. H. Mitchell, George S. Brown, H. F. English, J. R. Holley. The new president of the company has been a direc-

tor of the company for many years and is president of the E. N. Welch Mfg. Co.

#### Jeweler Sullivan Catches the Burglar in Flagrante Delicto.

DEVIL'S LAKE, N. D., July 26.—D. D. Sullivan's jewelry store was burglarized at 2 o'clock yesterday morning. Mr. Sullivan lives above the store and has a burglar alarm in the store which woke him up. Coming down stairs, accompanied by his wife, he saw a man helping himself to watches and silverware, throwing the goods through a rear window by which he had entered.

The burglar followed, gathering up goods and running away. Mr. Sullivan recognized him as a man who resided here some years ago and returned recently. The robber secured forty watches left for repairs and a lot of silverware, estimated at \$800. He has not been captured.

#### J. Niles Kimball's Store Closed Under a Chattel Mortgage.

KANSAS CITY, Mo., July 27.—The wholesale jewelry house of J. Niles Kimball, 121 W. 6th St., was closed this week under a chattel mortgage given to attorney J. W. Garner to secure indebtedness of \$8,200. The indebtedness is in the form of two notes, one for \$7,500 and the other for \$700, dated July 24th, due one day after date and secured by the stock.

Mr. Garner represents creditors in the east and in Kansas City and says that the secured creditors will be paid in full.

The commercial agencies rated Mr. Kimball's assets at about \$21,000. Mr. Kimball had formerly been associated in business with M. T. Quimby, Boston, Mass., whose failure some time since and the tightness of the money market are said to be responsible for his embarrassment. Mr. Kimball has been in business in Kansas City since 1881. For several years he has been prominent in city politics and is now a member of the upper house.

The Waterbury Watch Co. shut down Saturday night until Aug. 28th, thus giving the employes their annual vacation.



AMERICAN RAILWAY SUPPLY CO.  
24 Park Place, NEW YORK.



## No File Equals the "GLARDON" File

is the universal verdict  
of the trade.



LARGEST ASSORTMENT IN  
THE UNITED STATES.

F. W. GESSWEIN, 39 John Street, New York.

SOLE AGENT FOR UNITED STATES AND CANADA.

**The Demise of Edwin N. Denison.**

WESTERLY, R. I., July 30.—Edwin N. Denison passed away at his house on High St. early this morning. He was born in Groton, Conn., November 23, 1832, and during the first fourteen years of his life attended the common schools and spent a considerable time aboard a fishing smack. He then apprenticed himself to a Mr. Mason, on Meeting St., to learn the jeweler's trade. Before his time was out he purchased the remaining months of his employer and went to Worcester, Mass.

He soon returned to Providence and entered the employ of John Murran. In 1857 he learned the watchmaker's trade. He came to this town in 1872 purchasing an interest in the old stand of Thomas Perry, and commenced business under the firm name of Denison & Fifield. In a few months he purchased his partner's interest, and up to the time of his death conducted the business under the firm name of E. N. Denison & Co.

Deceased was one of Westerly's best known and successful business men. In November, 1856, he married Harriet M. Kenyon, a daughter of Dr. J. D. and Lydia R. Kenyon, of Hopkinton, who survives him. The funeral will be held at his late residence Tuesday, Aug. 1st, at 2 P. M.

**Nemitz Wants \$25,000 from the Swiss Consul and M. Perrenoud.**

CHICAGO, Ill., July 31.—Henry B. Nemitz, who was arrested in Canada, as dispatched to THE CIRCULAR under an earlier date, intends to bring an action against Arnold Holinger, the Swiss Consul, and M. Perrenoud, Commissioner General at the World's Fair, for defamation of character. Nemitz claims that he has suffered damages to the amount of \$25,000 because Holinger and Perrenoud circulated reports that he had embezzled certain sums of money from the Swiss exhibitors.

Consul Holinger procured the arrest of Nemitz in Toronto on the charge of larceny, and the warrant issued will form the basis of the allegations in the action of the Swiss agent. When Nemitz left Chicago July 22nd, M. Perrenoud declared that an arrangement had been made for an examination of Nemitz's accounts on the following day. When it was learned that he had gone away M. Perrenoud discovered that a large consignment of goods, principally watches, had been sold without his permission. M. Perrenoud claimed that he should have been consulted about the sale, as he was held responsible. Nemitz had gone to Canada, and Consul Holinger immediately swore out a warrant for the agent's arrest on the charge of larceny.

The jewelry store of George A. Schilling, Oswego, N. Y., was closed by Sheriff Ollport last week on judgments confessed to E. D. Vosbury & Co., wholesale jewelers, Binghamton, N. Y., and to Oswego parties.

**F. E. Morse & Son, and Morse, Mitchell & Williams Assign.**

CHICAGO, Ill., July 31.—Francis E. Morse and George H. Mitchell, real estate dealers, doing business under the name of Morse, Mitchell & Williams, and Francis E. Morse, doing business as F. E. Morse & Son, each made a voluntary assignment to E. H. Gary in the county court to-day.

In addition to being extensively engaged in the real estate business the firm of Morse, Mitchell & Williams are agents for the E. N. Welch Mfg. Co., Geo. H. Mitchell being treasurer of that company. Fred. C. Williams died some time ago. F. E. Morse & Son are engaged in the precious stone business and make a specialty of mounting diamonds.

**Eastern Manufacturers Interested in the Failure of Adolph Goldsmith & Son.**

PROVIDENCE, R. I., July 29.—The news in this city of the assignment of Adolph Goldsmith & Son, 38 Maiden Lane, New York, came like a thunderbolt from a clear sky. Although there has been a great depression in business and a painful stringency in collections for several months, still the manufacturers had to some extent regained their confidence that the avalanche of disasters was over for the present season at least. Therefore when the information was received it came with unusual severity.

It is thought that a number of the local

concerns are interested in the failure, for it was reported Jan. 1, 1893, that the firm owed about \$125,000, a large amount of which was to eastern creditors.

Dr. H. A. Heath, of the Spencer Optical Institute, 15 Maiden Lane, New York, accompanied by his wife, spent a delightful week in the Berkshire Hills as a guest of C. A. Whitman, of Adams, Mass., and has returned, profuse in his praises of the latter both as a royal host and a skilled optician. Having been one of Mr. Whitman's instructors in optics, Dr. Heath was extremely gratified to see the liberal patronage Mr. Adams is getting from the people of that section. Saturday being regular, "eye day" there were forty-six persons to be fitted between 9 A. M. and 9 P. M., and Dr. Heath had an excellent opportunity to judge of Mr. Whitman's progress as an oculist. Fourteen cases were re-examined by request, and it was found that but one could be improved—a case of progressive myopia. One of the secrets of Mr. Whitman's success is that his diploma did not act as a bar to his subsequent studies. Mr. Whitman's success is an excellent example to show jewelers the benefit of a course in optics and also to impress upon graduates of the Spencer Optical Institute the necessity and advantages of continuing their studies.

OURS IS THE FABRIQUE FONDEE EN 1797.  
**CH. FIELD HAVILAND** **E. GERARD, DUFRAISSEIX & CIE.,**  
LIMOGES CHINA. SUCCESSEURS:

WHITE WARE.  
**CFH**  
**GDM**  
**FRANCE**  
TRADE MARK.

DECORATED.  
  
TRADE MARK.



Something absolutely  
**NEW in CERAMICS,**  
**FURNACE FIRE COLORS.**

This illustrates the superb banquet service to be seen in our pavilion at the World's Fair—Ceramic Court, French Section in Manufactures building. The service comprises 210 pieces, decorated throughout in Furnace Fire Colors. Value, \$3,000.

**HAVILAND & ABBOT,**  
AGENTS FOR THE UNITED STATES,  
29 Barclay Street, **NEW YORK.**

### A Desperate Thief Takes Advantage of a Saleslady.

PHILADELPHIA, Pa., July 28.—John Braun, a tramp-like character, walked into the store of John Mitchell, 56 N. 8th St., on the 24th ult., and requested to be shown some watches. Miss White, the attendant, displayed two valued at \$20 and \$30. Then he designated another behind the counter, and when the young woman turned to get it, Braun dashed out of the door with the other two watches in his pocket.

Miss White ran to the door and raised the cry "Stop thief," which attracted the attention of Policeman Blackburn who gave chase. At the postoffice the policeman overhauled the thief and took him to the Central Station. Magistrate Pole gave Braun a hearing forthwith and committed him in default of \$1,000 bail for court.

### This Boy Systematically Robbed Jeweler Speer's Show Case.

WASHINGTON, D. C., July 29.—For some time past George W. Speer, jeweler, 310 9th St., N. W., has been missing small articles of jewelry and trinkets from the upright show case in front of his establishment. On Saturday evening last he set a trap for the pilferer and caught a small and well-dressed boy in the act of stealing from the case by prying the back door open with a piece of iron.

The youngster was taken inside the store and confessed to the stealing from day to

day, which amounted in the aggregate, to quite a sum. Owing to the boy's tender age and respectable connections he was not prosecuted.

### George A. Schilling Makes an Assignment.

OSWEGO, N. Y., July 29.—Sheriff Allport this week closed the jewelry store of George A. Schilling, at E. 1st and Bridge Streets. Frank W. Parker is Mr. Schilling's assignee.

The failure is in the sum of \$2,411.95. This represents a judgment in favor of Mr. Parker. Judgments have also been filed in favor of Susan Benzing, \$446.87; Charles P. Jones, \$222.03; F. E. Hamilton, as executor, etc., \$527.21, and Julius Boasberg, \$209.90.

### Sam Steinau at length Succumbs to his Ailment.

CINCINNATI, O., July 31.—Samuel J. Steinau, youngest brother of Abe Steinau, died Tuesday evening, at the Jewish Hospital, of cancer of the throat. The deceased was a resident of this city, and for years had been traveling salesman for H. Ludwig & Co., Providence, R. I. His affliction first became noticeable about a year ago, while east, and gradually developed itself, until it was necessary to perform an operation to save his life.

While in this city he was treated by Dr. Stark, who performed two more operations,

neither of which was, however, successful, and he continued to sink until 9 p. m. Tuesday night, when he passed peacefully away. The funeral took place from his late residence, 80 Fairfax Ave. Services were held at Mortuary Chapel, Jewish Cemetery, at 3 o'clock Thursday.

### A Failure in the Keystone State.

MEADVILLE, Pa., July 31.—Mrs. Anna R. Jenks has made an assignment of the jewelry business, corner Water and Chestnut Sts., this city, to Harry M. Jenks, her son. Executions amounting to \$4,000 in favor of Mrs. Colt had been issued and were in the sheriff's hands at the time.

The assignment was caused by the inability to meet bills due. The stock is advertised to be sold by the sheriff.

### Attleboro Jewelers Petition for a General Shut-down.

ATTLEBORO, Mass., July 27.—Owing to the extreme dullness in the jewelry trade here, due to the lack of orders from jobbing houses in the west, many manufacturers in Plainville, North Attleboro, Attleboro Falls, and this town have been compelled to close their shops. There being no signs of any business during August, a petition is being circulated for a general shut-down until Sept. 1st.

The petition has received many signatures, and the present indications are that all the factories will close.

# WALTHAM REPEATERS

## Striking Hours and Minutes.

TO THE TRADE:—

Having purchased the entire remaining stock of WALTHAM REPEATING MOVEMENTS from the American Waltham Watch Co., and cased them in 20 year 14k. Cases, I am prepared to sell them at prices 30 per cent. less than they have ever been offered before.

ARTISTIC SPECIAL CATALOGUE FREE.

SEND FOR PRICES AND TERMS.

# JOHN B. YATES,

21-23 Maiden Lane, New York.



# The Jewelers' Circular

AND  
HOROLOGICAL REVIEW.

PUBLISHED EVERY WEDNESDAY BY

**THE JEWELERS' CIRCULAR PUB'G CO.,**  
189 BROADWAY, NEW YORK CITY.

A JOURNAL DEVOTED TO THE INTERESTS OF JEWELERS, WATCHMAKERS, SILVERSMITHS, ELECTRO-PLATE MANUFACTURERS, AND ALL ENGAGED IN KINDRED BRANCHES OF INDUSTRY

Our Editorial columns will contain our own opinions only, and we shall present in other columns only what we consider of interest or value to our readers. Advertising matter will not be printed as news.

Advertising rates in THE CIRCULAR are lower, considering the number of tradesmen reached by its large circulation, than in any other jewelry journal.

Notices of changes in standing advertisements must be received one week in advance; new matter can be received up to Monday.

### INFORMATION FOR SUBSCRIBERS.

#### Terms of Subscription, Postage Prepaid.

United States and Canada, - - -	PER ANNUM	\$2.00
Foreign Countries in Postal Union, - - -		4.00
Single Copies, - - - - -		.10

New subscribers can commence at any time. Payments for THE CIRCULAR, when sent by mail, should be made in a Post-Office Money Order, Bank Check or Draft, or an Express Money Order or Registered Letter. All postmasters are required to register letters whenever requested to do so.

Pay money only to authorized collectors having proper credentials.

Returning your paper will not enable us to discontinue it, as we cannot find your name on our books unless your address is given.

In changing address always give the old as well as new one. Your name cannot be found on our books unless this is done.

The Courts have decided that all subscribers to journals are responsible until arrearages are paid in full and an order to discontinue has been received by the publisher.

#### Member of the American Trade Press Association.

Vol. XXVII. Aug. 2, 1893. No. 1.

At length the lithographing company to whom the printing of the *Official Patent Gazette* was recently awarded have issued the first number of the publication since the work was placed in their hands, and a reproduction of the patents in the jewelry and cognate lines appears in this issue of THE CIRCULAR. Though a month old, they are the Latest Patents.

THE reasons assigned for the reduction of the forces of the American Waltham Watch Co. and the Elgin National Watch Co., by the managements of these companies, and set forth in this issue of THE CIRCULAR, should be accepted without argument by all persons interested in the matter. It should be appreciable to all minds that as these companies have been adding constantly to their forces from week to week during the past years, they would retain their complements if commercial circumstances permitted.

**The Extra Session Likely to be Short.** AN existing question in which no small share of interest is manifested is whether the extra session of Congress will be a short or a long one. The solution of this question is viewed

in some quarters as not depending alone upon the probability of there being a strong fight made by the silver men in Congress against the repeal of the Sherman law. It is thought, for example, that the session may be prolonged by some action in relation to the tariff question. This view, however, is not shared by some of the men best qualified to judge as to the outlook. Speaker Crisp was reported recently as having intimated that the session need not last any longer than sixty days and that during that time the Sherman law can be disposed of, and the more important committees, as the Ways and Means, may be appointed and an adjournment taken until December. The close relations between Mr. Crisp and the administration give special significance to his views as to the outlook. It seems likely enough that it will be the policy of the administration to confine the work of Congress to the consideration of the silver question alone.

#### Proceedings That Should be Stopped.

THE sale of goods at retail within the World's Fair grounds and buildings by those who are merely exhibitors and not concessionaires should be strictly prohibited. As matters now stand a large number of foreigners have withdrawn goods from bond and are openly defying a law of the World's Columbian Exposition which American exhibitors are forced to respect. Several of the foreign governments sanction such unlawful proceedings, otherwise the unsightly tables with goods offered for sale would be instantly removed. France, with her magnificent rooms, resembles a fakir's den; Austria is fringed with tables and cases filled with gewgaws to catch the stranger; in the Japanese section originals will be sold, but they will not be delivered in less than ten days, the pretext being that it requires that much time to pay the duty. But in this section, and in all sections where originals are sold and not delivered for several days, the presumption is that a duplicate is substituted for the original. In the British, Swiss and German sections there was a characteristic regard expressed for the law and a wholesome dread of its penalties. The exhibitors all said that, while they would like to sell, they were not anxious enough to run the risk of arrest and prosecution. In the Austrian and Russian pavilions original exhibits were not sold, and, though duplicates were sold, they could not be delivered for several weeks. The Russian exhibitors will sell duplicates and deliver them in two weeks. The Austrian exhibitors will sell duplicates and deliver them in six weeks, as they have to be ordered from Vienna. In almost all of the remaining foreign sections anything will be sold that visitors will take away with them. The exhibitors of the French section sell as freely as any store in Chicago and in the Belgian section all of the exhibits are

for sale and will be delivered at once. In the Denmark section the exhibitors say openly that they sell the originals and replace them with duplicates. The officials of the Fair, it seems, dare not move a hand in support of American exhibitors. We rise to inquire, Is the Associated Exhibitors' organization without influence? Such things should not be.

#### The Week in Brief.

A DOLPHI GOLDSMITH & SON, New York, made an assignment—The Rockford Silver Plate Co., of Rockford, Ill., got a judgment against Leo Hollander, Salt Lake City, Utah—H. M. Betz, Philadelphia, Pa., was acquitted of the charge of receiving money under false pretenses—Diamonds were reported found in Demerara—Jacob W. Loewenberg, agent in St. Paul, Minn., for F. M. Sproehle & Co., Chicago, was arrested, charged with embezzlement—The stock of T. R. and A. T. Threadgill, Fort Worth, Tex., was attached—The store of George A. Crandall, of Holland, N. Y., was burglarized—The store of D. E. Rice, Denver, Col., was damaged by fire—F. M. Pollen & Co., Manitou, Col., assigned—A. C. Billou, Davenport, Ia., was robbed—The store of H. D. W. English, Arcade, N. Y., was robbed—The store of J. L. Schweizer, Selma, Ala., was destroyed by fire—D. Ramsey, Denver, Col., sold out to a creditor—The assignee of W. C. Leber, Minneapolis, Minn., prepared his inventory of the insolvent estate—The machinery and tools of Pfeil & Bredt, Chicago, were sold at auction—George B. McLellan and Frederick Morton, charged with several thefts by Boston, Mass., jewelers were captured—The American Waltham Watch Co. have reduced their force—The store of J. Niles Kimball, Kansas City, Mo., was taken possession of under a chattel mortgage—The death of Samuel J. Steinau, with H. Ludwig & Co., Providence, R. I., occurred—James Paul was arrested in Philadelphia, Pa., for robbing the store of Charles Loeffler—The store of D. D. Sullivan, Devil's Lake, N. Dak., was burglarized under peculiar circumstances—A new president for the Bristol Brass & Clock Co., Bristol, Conn., was elected to take the place of A. F. Atkins, deceased—The Hartford Silver Plate Co., Hartford, Conn., was absorbed by the Barbour Silver Co., of the same city—The Elgin National Watch Co. will reduce their force—A box of gold clippings addressed from L. F. Hannas, Utica, N. Y., to H. F. Carpenter, Providence, R. I., was stolen in transit, but was recovered—The stock, tools, etc., of Robert S. Cutting, Providence, R. I., will be sold under foreclosure of mortgages—The death occurred of Mrs. Harriet Howard, wife of Joseph P. Howard, of Howard Co., New York—Edmund Heinecke, New York, confessed judgment—The plate-glass window of C. E. Snyder, Pittsburgh, Pa., was broken.

### New York Notes.

J. R. Keim has entered a judgment for \$226.21 against Charles Seale.

Max Freund & Co. have obtained a judgment for \$1,747.18 against Jacob Sheer.

Tiffany & Co. have obtained a judgment for \$122.22 against Herbert E. Dickson.

Dattelbaum & Friedman have obtained a judgment for \$64.44 against Henry Hart.

Howard & Co. have obtained a judgment for \$341.58 against Duncan E. Cameron.

Henry J. Durlach, of Durlach Bros., returned from Europe July 24th, on the *Ems*.

The Richard Mfg. Co. have entered a judgment for \$147.40 against Caroline Moller.

Max Freund, of Max Freund & Co., spent a few days at the Thousand Islands last week.

Ludwig Nissen, of Ludwig Nissen & Co., spent a few days at Lake George last week.

Among the departures for Europe last week were M. Prager, on the *Paris* and A. Frankfield on the *Etruria*.

The judgment for \$103.23 entered June 19, 1890, by William Barthman against Nath'l B. Abbott has been satisfied.

Mr. and Mrs. William H. Ball have returned from a four weeks' trip through the Thousand Islands and the Adirondacks.

A short sketch of the business career of Ludwig Nissen, of Ludwig Nissen & Co., appeared in the *New York Commercial Advertiser* July 24th.

The sheriff of this city has received an attachment for \$3,096 against Dr. Wm. F. Carver, in favor of John Friedlander, a jeweler of Berlin, Germany.

Edmund Heinecke, 23 E. Houston St., has confessed judgment for \$746.75 for rent due, in favor of R. Boyd, the executor of the estate of James B. Warden.

Harriet Howard, the wife of Joseph Platt Howard, died at Bernardsville, N. J., Tuesday, July 25th. The funeral services were held Friday morning at her late residence, 46 W. 52nd St. this city.

The *New York Mail and Express* on July 29th published a long list of prominent jewelers of Maiden Lane and vicinity, together with the places at which they will spend the Summer vacations.

The employes of the factory of the New York Standard Watch Co., at Jersey City, who were laid off six weeks ago, returned to work on Monday. They work only three days a week, however, until further notice.

Leon Jeanne, son of Paul Jeanne, has returned from a bicycle tour through New York, New Jersey and Pennsylvania. His bronzed and healthy appearance is a great argument in favor of the fine exercise of bicycling.

George Keller, whose occupation is given as a barber and diamond speculator, was sentenced by Recorder Smyth, Friday, to two years and six months imprisonment.

He had been convicted of swindling a woman out of \$37.

Louis E. Smith started Friday on a trip through the west and southwest for M. B. Bryant & Co., New York. The firm's other travelers start out this week.

Ernest Kretzmar, Philadelphia, Pa., writes to THE CIRCULAR that the suits mentioned in the last issue, which were brought against him by C. Cottier & Son and the Chatham National Bank, of this city, have since been settled.

James Hutchison, father of Geo. W. Hutchison, of Hutchison & Huestis, died last Wednesday at his residence in Newark, N. J., of heart failure. The deceased was in his seventy-second year. The funeral took place Saturday.

Nathan Bachrach, the Grand St. jeweler, who failed in December, 1890, is being examined in supplementary proceedings, before Referee Paul Jones, on a judgment for \$61.34 obtained by the Spencer Optical Mfg. Co. Feb. 20, 1891.

Thieves entered the house of Noé Trahan, at West Brooklyn, on the afternoon of July 23rd, stole a quantity of jewelry and destroyed a lot of bric-à-brac. Mr. Trahan is an instalment jeweler at 176 Broadway. He estimates his loss at about \$400.

The Wessell Silver Co., of this city, incorporated last week with a capital of \$25,000. The company will produce and manufacture "Wessell Silver" into a variety of articles. The directors are Chas. A. Wessell, Roger A. Mead and Arthur Christaforo, all of New York city.

Samuel Greenbaum, assignee of C. Cottier & Son, states that the settlement accepted by the creditors of that firm has been practically effected. It is 60 per cent. in all: 25 per cent. Jan. 1, 1894; 15 per cent. May 1, 1894; 10 per cent. Sept. 1, 1894, and 10 per cent. Jan. 1, 1895.

Peter Speranza, a jewelry repairer at 59½ Hamilton Ave., Brooklyn, notified the police of that city last week that he had been swindled by a man who called at his store July 23rd and bought a watch and chain, giving in payment a \$50 bill. The following Monday Speranza discovered that the bill was a Confederate note and worthless.

A meeting of the creditors of M. Fox & Co. is to be held shortly after THE CIRCULAR goes to press. It is called by the investigating committee appointed at the last meeting, who will report and submit the proposition of settlement which they think can be effected. The committee consists of W. B. Durand Benno Loewy, R. H. Breidenbach, Henry Fera and Mr. Doty, of Andrews & Doty.

Creditors representing about 90 per cent. of the merchandise indebtedness of J. P. Trau, Philadelphia, Pa., have accepted the settlement proposed by that firm of 25 per cent. in notes of J. P. Trau endorsed by Dr. J. Adam Trau, one for 10 per cent. due Jan. 1, 1894, and one for 7½ per cent. due Jan. 1, 1895. Ludwig Nissen, chairman of the

committee of creditors, is circulating the agreement.

The championship base ball game played at the Manhattan Field Saturday afternoon between the "Sunnysides" and "Shady-sides" of Maiden Lane, resulted in a victory for the latter by a score of 21 to 19. A double play was made by both teams, one in the sixth inning by the "Sunnysides" and one in the ninth inning by the "Shady-sides." Captain Engelsman's team have now confirmed their title of the "stiffs" and earned that of the "champions."

Owing to the continued stringency in the money market, the offer of settlement accepted by the creditors of Kuhn, Doerflinger & Co., has been slightly modified by that firm. The original offer was 40 per cent., 10 per cent. in 30 days, 10 per cent. in 60 days, 10 per cent. in 90 days, 5 per cent. in 15 months and 5 per cent. in 18 months. The time of the first payments has been changed to one, two and three months. No objections have been made to the change.

Michael Reiner, known as the east-side miser, who died July 24th, was at one time a well-known peddler of jewelry. It is said that he was one of the pioneers in the instalment jewelry business in this city. Among his effects found by the Public Administrator was \$10,000 in cash, \$4,000 in promissory notes and a trunk containing fifteen diamond rings, eight loose diamonds, five pairs of diamond earrings, six diamond studs, ten gold watches, three silver watches, and a lot of miscellaneous coins and trinkets.

Franklin Bien has entered the following judgments in favor of William R. Alling: one for \$1,003.42 against E. F. Sanford, Wm. T. Coombs and E. E. Kipling on a note given by E. F. Sanford & Co. and endorsed by E. E. Kipling; one for \$1,534.85 against Charles and J. G. Cottier and E. E. Kipling, on notes given by C. Cottier & Son and endorsed by E. E. Kipling; one for \$1,052.05 against E. E. Kipling and Chas. and J. G. Cottier on a note given by E. E. Kipling and endorsed by C. Cottier & Son; and one for \$2,033.95 and one for \$1,714.05 against Chas. Seale and E. E. Kipling on notes given by Chas. Seale and endorsed by E. E. Kipling.

### The United States Watch Co. Start up with Full Force.

Boston, Mass., July 31.—The United States Watch Co. resumed work at their factory at Waltham this morning with a full force, after two weeks' vacation. This was an agreeable surprise to the operatives and the community, as it was feared that, owing to the general business depression the company would extend their vacation another week or make considerable discharge of help, as did the Waltham Company.

The operatives, both piece and day hands, were notified of a reduction of 15 per cent. in pay during the present stagnation only, with the promise that when times improve the old wages would be restored. The reduction applies to foremen as well as others.

**The Assignment of Adolph Goldsmith & Son.**

Adolph Goldsmith & Son, composed of Adolph and Sigmund A. Goldsmith, 38 Maiden Lane, New York, made an assignment Friday to Jonas H. Monsheimer, giving eighteen preferences amounting to \$38,043.38 as follows:

Mrs. J. E. Noe, of Sheepshead Bay, \$1,532.99 for money loaned; Rachael D. Harris, Albany, N. Y., \$850.53 for money loaned; A. Grabowski, \$500 for money loaned; Moses Lauthem, \$368.37 for money loaned; Leopold Lauthem, \$896.37 for money loaned; Stern Bros. & Co., \$6,500 for money loaned; L. & M. Kahn & Co., \$3,500 for money loaned; Jno. M. Link & Co., \$393.14 for a note due July 30, 1893; Henry Rickel, of Chaux de fords, Switzerland, \$2,000 for money advanced; David McClure receiver for the National Bank of Deposit, \$3,500 liability on bills and notes discounted by said bank; National Park Bank, \$6,000 for bills and notes discounted, and Chemical National Bank, \$3,000 for bills and notes discounted.

Mr. Monsheimer, the assignee, stated that the failure was due to the financial stringency, inability to obtain further accommodations, dull trade and losses by recent failures. His statement, he said, would be ready this week and he will then call a meeting of the creditors and lay the facts before them.

Adolph Goldsmith, the senior member of the firm, has been connected with the jewelry business for about thirty years. He was formerly of the firm of Freund, Goldsmith & Co., which dissolved in 1878. He then formed a partnership with James Schliesser under the firm name of Goldsmith & Schliesser. After the partnership dissolved in February, 1880, Mr. Goldsmith continued alone. On Jan. 6, 1885, he assigned, with preferences amounting to \$38,000, but effected a compromise with his creditors at 30 per cent. Sigmund A. Goldsmith, his son, was admitted as a partner Jan. 1, 1893.

The liabilities of the embarrassed firm have been estimated at about \$220,000, while the nominal assets are placed at about the same amount.

A meeting of the creditors has been called for 3 o'clock this afternoon at the rooms of the New York Jewelers' Board of Trade, 41 & 43 Maiden Lane, New York.

Emma L. Marcellus, wife of Charles E. Marcellus, formerly of the firm of McBride & Marcellus, Cleveland, O., has filed a bill for alimony and the custody of her six-year old son, Charles E. Marcellus, Jr. She alleges numerous shortcomings on the part of her husband.

**Last Week's Arrivals.**

*THE CIRCULAR has perfected arrangements for obtaining the names and hotel addresses of all the latest buyers visiting New York, and each day posts in its office, 189 Broadway, a bulletin which every member of the trade is cordially invited to copy.*

The following out-of-town dealers were registered in New York during the past week: H. N. Eliassof, Albany, N. Y., Astor II.; A. Harris, Albany, Ga., Broadway Central II.; C. C. Foster, buyer for Foster & Port, Pittsburgh, Pa., Metropolitan II.; M. Rosenbloom, Rochester, N. Y., Metropolitan II.; S. Eisenstadt, St. Louis, Mo., St. James II.; M. A. Tappan, Washington, D. C., Continental II.; H. E. Hall, buyer for Forbes & Wallace, Springfield, Mass., 120 Franklin St.; J. C. Biggert, Pittsburgh, Pa., Plaza II.; M. Eliassof, Albany, N. Y., Astor II.; J. W. Grandy, buyer for Grandy & Taylor, Norfolk, Va., Metropolitan II.;

G. Gay, buyer for Brown, Thompson & Co., Hartford, Conn., Park Avenue II.; E. D. Manheimer, Chicago, Ill., Astor II.; J. Serex, San Francisco, Cal., Astor II.; J. O. Morris, Chicago, Ill., Astor II.; H. Myers, Philadelphia, Pa., Astor II.; F. Rosendale, Philadelphia, Astor II.; W. P. Page, Boston, Mass., Astor II.; L. E. Kirstein, Rochester, N. Y., Imperial II.; S. G. Hoggson, New Haven, Conn., Murray Hill II.; S. F. McFarland, Binghamton, N. Y., Astor II.; M. F. Wilson, Chicago, Ill., Astor II.; W. H. Moore, Philadelphia, Pa., Union Square II.; J. Wanamaker, Philadelphia, Pa., Gilsey II.; A. M. Street, Chicago, Ill., New Amsterdam II.; A. Anderson, Boston, Mass., Sweeny's II.; J. Goldstein, Mobile, Ala., Astor II.; C. E. Foster, Erie, Pa., Astor II.; J. Karr, Washington, D. C., Grand II.; D. E. Hubbard, Cleveland, O.

Geo. W. Livsey has withdrawn from the firm of Ellis, Livsey & Brown, Attleboro, Mass. The firm will continue under the same title.

IF YOU WANT ANY STONES CUT OR REPAIRED SEND THEM TO



D. DE SOLA MENDES & CO.

**PIVOT DRILLS THAT WILL DRILL.**

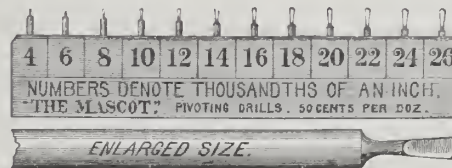

The Mascot is the best made Pivot Drill in the world. This is a strong assertion, but it is justified by the quality of the drills.

The following unsolicited testimonial would also seem to warrant our assertion:

MESSRS. EZRA F. BOWMAN & CO., LANCASTER, PA.:

Gentlemen—I am in receipt of your Mascot Pivot Drills that I ordered on the strength of your statement in the May issue of the "Keystone." Having tried every so-called Pivot Drill that my attention was directed to, and meeting with dismal failure, I was naturally inquisitive to learn what your Mascot was capable of doing. I took a Seth Thomas Clock mainspring, and subjected six drills out of each dozen to the test of drilling twenty holes through without drawing the temper. Every drill stood the test and your claim in the "Keystone" is warranted by the facts. Yours truly, L. F. GIERING.

Send by mail, postage paid, on receipt of 50 cents.

**EZRA F. BOWMAN & CO., Lancaster, Pa.**

**LUDEKE & POWER, IMPORTERS OF DIAMONDS**

AND OTHER PRECIOUS STONES,

ADOLPH LUDEKE,  
CHAS. L. POWER.

23 JOHN STREET, N. Y.

**Our Traveling**

**Representatives**



Traveling representatives may consider these columns open for the publication of any news or items of interest regarding themselves or their conferees.

**T**HE following notes in regard to Detroit traveling men will be of interest: H. E. Tudor, M. M. Silliard, Arthur Hill, Will Brady and A. S. Bleyer, for the United States Optical Co., will start out about Aug.

5th; Eugene Deimel is without a traveling salesman at present, but will start a couple on the road shortly; M. L. Barnard, with Adolph Enggass, has returned from a north Michigan trip and reports business very quiet; the Johnston Optical Co. expects to send out their men on the first of this month; Burt & Hurlbut Co.'s men are off on a vacation. The following salesmen passed through Detroit last week: J. W. Pickering, Shoemaker, Pickering & Co.; Luther Hyde, Reed & Burton; W. F. Briggs, W. F. Briggs & Co.; E. A. Dennis, Rochester, N. Y.; F. W. Trewin, Keystone Watch Case Co.

William E. Bliss has returned to Meriden from a five weeks' business trip in the interests of the E. A. Bliss Co.

Charles Meister, the popular representative of Heckel, Bieler & Co., Pittsburgh, Pa., was married lately to Miss Carrie Troy, daughter of the late Rev. McVeigh Troy, of Sandy Lake.

For the past week traveling men in Indianapolis have been few and far between. They were: David Schuraz, Nicholas Muller's Art Bronze Co.; F. W. Trewin, Keystone Watch Case Co.; Mr. Phillips, A. & J. Plaut, and a representative of D. F. Briggs Co.

Traveling men in Pittsburgh last week were: Geo. D. Munson, Wm. Rogers Mfg. Co.; Frank F. Gibson, Wm. Kinscherf; Luther Hyde, Reed & Barton; G. W. Mindell, Dubois Watch Case Co.; W. L. Mirrieles, S. Steinau & Co.; Leon Sichel, Ameri-

can Watch Case Co.; E. H. Smith, Holmes & Edwards Silver Co.

The following traveling men favored Syracuse, N. Y., with a call the past week: E. Jacobson, Jacobson Bros.; F. C. Somes, Marsh & Bigney; C. E. Halsted, Barbour Silver Co.; L. D. Good, T. A. Bradley & Co.; W. F. Cannon, Averbeck & Averbeck; C. S. Griswold, Middletown Plate Co.; Max Traub, Herzog, Goldsmith & Frank; E. L. Mumford, Waite, Thresher Co.; L. E. Van Horn, Philipp Zellenka & Sou; Charles Isabel, Louis Strasburger's Son & Co.; Wm. Tappan, Tappan, Berry & Co.

**Syracuse, N. Y.**

C. S. Ball left Saturday last for his cottage at Round Island, on the St. Lawrence River.

C. E. Eager and wife leave Wednesday for their cottage, "Glen Oaks," on Skaneateles Lake, to be absent during the month of August.

Among the out-of-town buyers in Syracuse last week were: Charles Morton, Jordan; Jules Rude, Weedsport; C. B. Smith, Central Square; D. C. Draper, Fulton, and Charles Frank, Newark Valley.

The Green Novelty Co., with Wm. B. Green as manager, will begin business on Aug. 1st, as manufacturers and jobbers of gold, silver and plated jewelry, silver novelties, flat and hollow ware, clocks, etc., at 216-218 E. Washington St. They will be represented by E. J. Hermans who leaves this week on his initial trip.

**Springfield, Mass.**

O. W. Bullock is spending his vacation in Wilmington, Vt.

Charles D. Rood has opened an office in the Chicopee Bank block.

Edwin W. Merrill has returned from a vacation spent in Vermont and Canada.

David Mayer has entered suit in this city against Francis A. Kennedy, of Holyoke.

Jeweler C. A. Tripp and wife, of Brattleboro, Vt., are spending the Summer at Block Island.

L. S. Stowe expects to move into his new house on Federal St. in about two weeks. The house is of colonial design and one of the handsomest in the city.

H. J. Cain, superintendent of the Hamilton Watch Co., Lancaster, Pa., was in town last week, and arranged to move his wife and daughter to Lancaster to live.

Assistant superintendent Fred D. Van Norman, of the Waltham Watch Tool Co., who has been resting at Block Island during the shut down of the factory, has returned home.

**Providence.**

John Nelson has removed from 303 to 286 N. Main St.

Wm. G. Hopkins has gone on an extended tour for rest in the country.

Jacob Abisch has started in the retail business at 187 Mathewson St.

Walter E. White and family are at their cottage at Conimicut Point for the Summer.

E. B. Lockwood has gone to New York, where, it is understood, he contemplates engaging in the jewelry business.

Miss Adeline B. McLane, for several years in the office of J. H. Fanning & Co., was recently married to Frederick Ladd.

Gardiner & Kunze, 227 Eddy St., have gone out of business. Mr. Kunze has accepted a position with E. L. Spence & Co.

Mr. and Mrs. C. F. Vennebeck have the sympathy of a large circle of friends and acquaintances in their recent bereavement by the death of their daughter Ethel.

Levi L. Burdou has been elected secretary and treasurer of the Fifth Regiment Heavy Artillery Veteran Association, and Col. Isaac M. Potter was elected as a member of the executive committee.

The stock, tools and machinery belonging to Robert S. Cutting, 409 Pine St., are advertised at auction sale at 12 o'clock Wednesday, Aug. 16, 1893, under foreclosure of two mortgage deeds, one bearing date of Jan. 22, 1890, and the other Jan. 7, 1892.

The co-partnership which has existed for several years between William A. Beatty and Joshua Lothrop, under the firm name of W. A. Beatty & Co., has been dissolved by mutual consent, Mr. Beatty retiring. Mr. Lothrop is authorized to settle the affairs of the firm, which will be succeeded by J. Lothrop & Co.

A box was found on Sabin St. early Thursday morning by Officer Sherman and taken to police headquarters. Upon the box was the address, "H. F. Carpenter, gold and silver refinery, 58 and 60 Page street, Providence, R. I., from L. F. Hannas, Utica, N. Y." The police made an investigation of the case and found that the box containing gold clippings had been sent by Mr. Hannas to Mr. Carpenter by the American Express Co., and after its arrival in this city had been stolen from one of the company's teams by sneak thieves. The box, which contained gold scraps valued at upwards of \$1,000, has been delivered to H. F. Carpenter.

**Enterprising Jewelers Catch On!**



OBVERSE



REVERSE



BACK

**Jewish Shekel, Masonic Mark or Pocket Piece.**

THE LATEST AND BEST SELLING NOVELTY.

The mark is struck in coin silver; by using either the obverse or reverse of the coin, the back being the same in either case, and permitting of the purchaser's name, blue lodge, chapter and individual mark, with date of same being engraved thereon, as shown in cut above.

Price, without engraving, ONE DOLLAR. Engraved Mark, Dates, etc., 75c. EXTRA.

Liberal Discount to the Trade.

**CHAS. C. WILLSON, MANUFACTURING JEWELER, READING PA.**



A DAINY FALL NOVELTY.

**SOUVENIR : PLAQUES**

IN SILVER PLATE,

With Artistic Photographs or Views, in Colors, on Pearl Backgrounds.

Can be Used as a Tray or Hung up by Loop on Back.

Make a Very Handsome Appearance.

List of Views and Photos on Application.

Price, \$12 per Dozen. Finest Work.

Special designs to order. Send photo. Photographing on Spoons, Watches, Window Transparencies, Celluloid Photographs, &c.

**G. A. SCHLECHTER, MFG. JEWELER**  
READING, PA. Agents Wanted.



ONE-QUARTER SIZE.

**OUR CUSTOMERS**

in the Jewelry and kindred trades will now find us comfortably installed at 112 Fulton St., where we are showing as fine an assortment of canes and umbrellas as can be found in the market.

REPAIRING AND COVERING AT SHORT NOTICE.

**WICKSTEAD UMBRELLA CO.,**

112 Fulton Street, Cor. Dutch,

NEW YORK.

ESTABLISHED 1870.

**J. L. CLARK,**

**SWEEP SMELTER AND REFINER OF GOLD AND SILVER.**

Buys every kind of Gold and Silverware, Jewelry, Watches and Platium. Full market value paid.

**No. 724 Filbert Street, Philadelphia, Pa.**

SEND BY EXPRESS or Registered Mail. If my price is not satisfactory, I will return all articles.

Sold by all wholesale dealers at manufacturer's price.

**A. N. CLARK,**  
PLAINVILLE,  
CONN.

Manufacturer of the Celebrated

**LOOP WATCH KEY.**

The Best for the Price in the World.  
CROSBY'S JEWELING TOOLS IMPROVED.

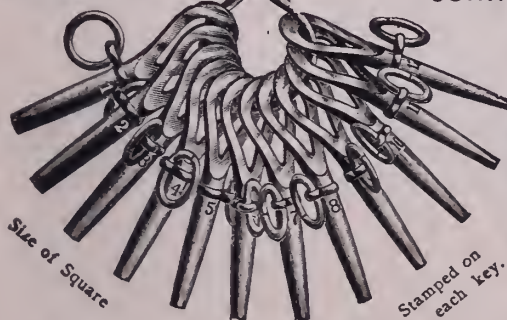

Size of Square

Stamped on each key.



Will quote royalty or price for the manufacturing of articles of real worth.

**AIKIN, LAMBERT & CO.**

19 Maiden Lane, NEW YORK.

Branch, 42 & 44 East Madison St., CHICAGO, ILL.

Manufacturers and Exporters of

Gold Pens, Holders, Picks, Pencils,

Fountain Pens, etc.



11 x 5 1/2 inches.

**PLUSH TRAY WITH EASEL BACK.**

1 Doz. 16 K. Pens and Assorted Holders, List, \$30

1 Doz. 10 K. Pens and Assorted Holders, List, \$24

Send for Trade Discount.

ESTABLISHED 1837

**GEO. O. STREET & SONS,**

MAKERS OF

Fine Rings, Locketts, Seals,

Sleeve Buttons and Links,

15 John Street. NEW YORK.

**Jules Jürgensen**

OF COPENHAGEN.

The reputation these watches have maintained for Fifty Years has never been equalled, being made on strictly scientific principles and no expense spared to give the Best results in mechanism and timekeeping qualities.

SOLE AGENTS.

**John C. Hyde's Sons,**  
NO. 22 MAIDEN LANE.

**WM. BIRMINGHAM & CO.,**

MANUFACTURERS OF

All Kinds of Leather Spectacle and Eye Glass

**CASES,**

728 Arch Street, PHILADELPHIA, PA

**ALUMINUM SOLDER \$2.00 PER POUND.**

Instructions for using given gratis.

Practical Processes for Soldering, Dipping, Enameling, Etching, &c., of Aluminum.

**C. DE REDON, 43 WEST 21ST ST., NEW YORK.**

FACTORY AND SALESROOM  
PHILADELPHIA,  
616 & 618 CHESTNUT STREET,  
611 & 613 SANSOM STREET.



NO. 20.

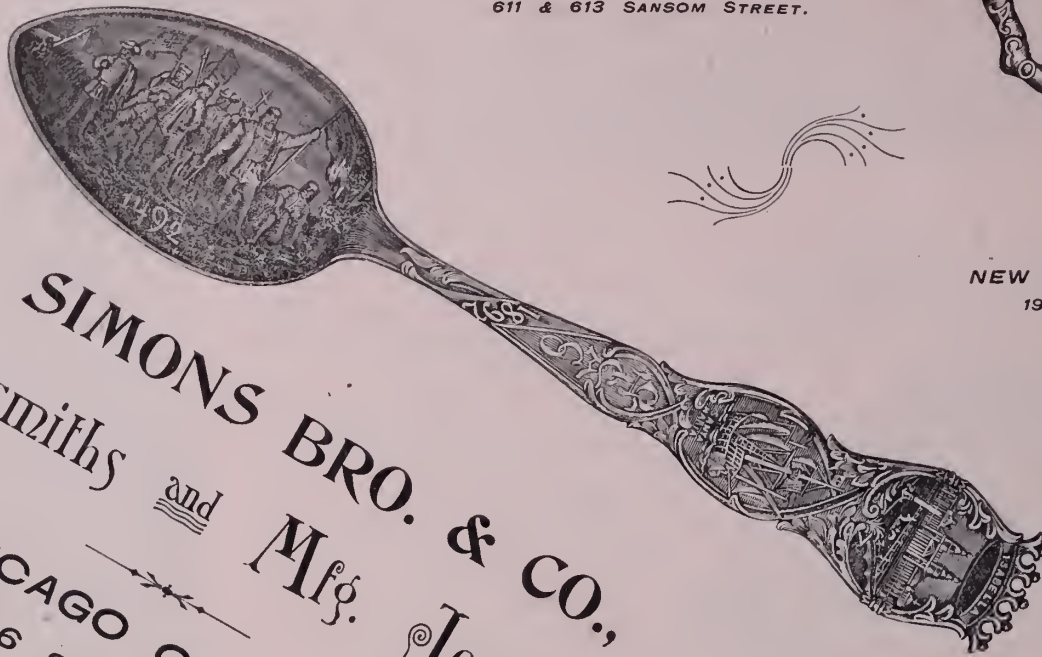

NEW YORK OFFICE:  
19 MAIDEN LANE.

SIMONS BRO. & CO.,  
Silversmiths and Mfg. Jewelers.  
CHICAGO OFFICE:  
96 STATE ST.

As Regards

SILVER PLATE

WE BELIEVE

THAT an Honest article at an Honest price goes further toward making sales than all the advertising in Christendom,

AND WE WORK ACCORDINGLY.

MAKING and SELLING a BETTER Article for the SAME Money, or an EQUAL Article for LESS Money than any other concern, is the principal cause of our fast increasing business.



2028.—BUTTER DISH.

HOMAN & COMPANY,  
CINCINNATI.

Visitors to the Columbian Exposition, Remember our Complete Line is displayed at  
155 STATE STREET, CHICAGO.



CHICAGO OFFICE: ROOM 308, INTER-OCEAN BUILDING.

VOL. XXVII.

CHICAGO, WEDNESDAY, AUGUST 2, 1893.

NO. 1.

OSTBY & BARTON'S NOTABLE EXHIBIT OF RINGS.

BEING one of the largest manufacturing concerns in the city of Providence, R. I., and the largest producers of finger rings in the world, it was to be expected that the rich and enterprising corporation of Ostby & Barton would present to the visitors at the World's Fair an exhibit that would successfully rival anything introduced by their competitors. Nor have these expectations been disappointed, for in Section N, of the Manufactures building, in close proximity to the collective exhibit of the New England Manufacturing Jewelers' Association, the handsome pavilion of this house has been placed. This pavilion is of itself a beautiful example of art and is the product of the firm of Potter & Co., Providence, who built so many of the cases that were filled with jewelry at the Centennial Exposition of 1876. The pavilion is eight feet long, five feet wide and eleven feet high. The wood which has been used in the construction is figured birch highly polished and finished in its natural color. It is pleasingly relieved and delicately ornamented with fine gold lines. The floor of the booth is carpeted with rich Axminster of terra cotta color, while the walls and ceilings are hung with pale green silk draperies. At one end the drapery is gracefully drawn back revealing the interior wherein is the case proper. This is displayed in a unique and excellent manner

which produces a very novel and pleasing effect.

from the outside, is a row of small incandescent lights which flood the booth with their brilliant rays and illuminate the exhibit with striking effect, rendering it more attractive and interesting. The name of the corporation is represented in handsome engraved letters illuminated with gold, which appears upon two sides of the base of the case on polished panels and also upon the frieze of the pavilion.

As one stands and gazes into the tasty pavilion he sees reflected back from the mirrors the graceful proportions of an irregularly shaped case, harmonizing in form, color and material with the outer pavilion. It also is of birch with gold ornamentations similar to those of the exterior. In this case is a huge pyramid covered with delicate heliotrope velvet which is slightly puffed and full so as to form small receptacles in which repose the various styles of rings to the number of several hundreds, made by this concern. The mirrors here again lend their assistance in producing a novel effect, their reflection causing the handsome exhibit to appear as though it were in duplicate.



THE PAVILION OF OSTBY & BARTON.

A neat reception room has been railed in at the rear of the Manhattan Silver Plate Co.'s exhibit in the Manufactures building. A raised platform has an open pilaster rail

by the aid of plate glass mirrors at the back,

Around the cornice on the interior of the pavilion and entirely hidden from sight

of curly birch with carved posts each side of entrance.

## HOROLOGY AT THE WORLD'S FAIR.

PART VIII.—BAUME &amp; CO'S FINE EXHIBIT—GENEVA EXHIBITS.—AMERICAN WALTHAM WATCH CO. PAVILION.

THE World's Fair exhibit of watches of Baume & Co., 21 Hatton Garden, London, Eng., though small in number, yet in quality is beyond compare, the firm claim, by anything in the whole Exposition. The exhibit consists of the following:

Gold crystal tourbillon chronometer, which has been awarded the Class A certificate of Royal Observatory, Kew, with 91.9 marks and the endorsement "especially good," this being the highest award ever yet granted. In the report of the Kew Committee for the year ending Dec. 31, 1892, under the heading of Rating of Watches it is gleaned that of the twenty-two watches that gained the highest number of marks during the year, "The first place was taken by Messrs. Baume & Co., London, with a keyless, going-barrel, chronometer-watch, No. 103,018, with the tourbillon escapement, which obtained the high total of 91.9 marks out of a maximum of 100; this is the highest value yet awarded." According to the table showing the results of the watch trials, the performances of this watch were as follows: mean daily rate, pendant up,—0.8 seconds; pendant right,—0.6 seconds; pendant left,—0.7 seconds; dial up,—0.4 seconds; dial down,—0.2 seconds; mean variation of daily rate, 0.26 seconds; mean change of rate for 1° F., 0.03 seconds; difference between extreme gaining and losing rates, 2.5 seconds; marks awarded for daily variation of rate, 34.8; for change of rate with change of position, 39.3; for temperature compensation, 17.8; total, 91.9.

A hunting watch similar to above with

Class A certificate of the Royal Observatory, Kew, 87.5 marks and endorsed "especially good."

A gold crystal minute repeater and split seconds minute recording chronograph, Class A certificate of the Royal Observatory, Kew, 70.2 marks, very finest nickel movement.

Split seconds minute recording chronographs in Louis XV. style.

Gold crystal minute repeaters (17 lines) in Louis XV. style.

High class keyless nickel movement, with Class A certificate of the Royal Observatory, Kew, 81.— marks.

Other keyless nickel movements, some with Class A certificates.

Baume & Co. have held the record for complicated watches at Kew since 1887 with a split seconds minute recording chronograph which was awarded 85.1 marks and the endorsement "especially good." Up to the present time this has not been beaten.

The factory of Baume & Co. was established in Switzerland in 1834 and the London house was opened about the same time. The firm adopted a policy to produce the better class of Swiss watches. They obtained a medal at Berne in 1857, and at the great International Exhibition held in London, 1862, they obtained the only medal awarded for Swiss watches, as also the only individual award for Swiss watches at the Melbourne Exhibition, 1880-1881. At the Inventions Exhibition held in London in 1867, they were awarded the gold medal for "excellence of manufacture," and have obtained

an award at every exposition in which they have exhibited.

For some years the firm devoted their attention to the improvement of chronographs and their endeavors culminated in their patent split seconds minute recording chronographs. Geo. E. Wilkins, Syracuse, N. Y., has supervision over the exhibit.

## EXHIBITS FROM GENEVA.

The pavilion south of that of Patek, Philippe & Co. contains the displays of the other Geneva firms exhibiting. The place of honor in the front case is given A. Golay-Leresche & Fils. Since 1837 the firm have been manufacturers of high class watches, as repeaters, split seconds, and other complicated movements, for which they have obtained prize medals at Berne, 1857; London, 1851 and 1862; Melbourne, 1880, and Paris, 1855, 1878 and 1889.

Every grade of complicated watch is shown. In novelties a gem is shown in a chatelaine—an enameled cherry inclosing a watch, suspended from a cherry leaf pin incrusting with diamonds. Another is solidly incrusting with diamonds with a 2-karat stone in the center, and a horseshoe diamond pin with three large stones in the center of the horseshoe. There is a slipper in light blue enamel with diamond buckle, and inside a 6-line watch on a bed of heliotrope with the bezel of diamonds, by which it is wound. The pin is a circle of diamonds. Others are shown decorated with emeralds, diamonds, pearls, turquoises, rubies and sapphires in artistic and beautiful designs.

At the back of the case stand two caskets

# JUERGENS & ANDERSEN COMPANY,

## DIAMONDS AND MOUNTINGS,

Order Work a Specialty.

125-127 State St., Chicago.

### ALBERT H. BONNET,

ONLY EXCLUSIVE WHOLESALE JEWELRY HOUSE IN OHIO.

COLUMBUS, WALTHAM, ELGIN, HOWARD AND STANDARD WATCHES,  
GOLD AND FILLED CASES, JEWELRY, CHAINS, CLOCKS.

FULL LINE OF TOOLS AND MATERIALS.

No. 24 E. SPRING STREET,

COLUMBUS, OHIO.



with watch decorations on the front. The larger is a jewel casket in old silver and enamel valued at \$1,300. The feet are chimeras vomiting forth flames and on the sides are five scenes depicting courtship, engagement and marriage, which are believed to be some of the finest enamel pictures ever produced. The smaller is a decorated gold musical casket of marvelous workmanship. By inserting a key the lid flies back and out springs a wee bird of gorgeous plumage which trills a delightful song. The motions of the bird are extremely natural, the movements of the body, the twittering of the beak and the fluttering of the wings being true to life. At the conclusion of the song the bird disappears and the lid closes automatically. The pretty bauble is valued at \$1,700.

E. Wirth, successor to J. E. Dufour & Co., received highest awards at the Universal Exhibition at Vienna in 1873, Paris, 1878, and Melbourne, 1880-81 and was *hors concours* and vice-president of the jury at Paris in 1889. He shows a magnificent line of decorated enameled cases in small sizes; chronometers with the certificate of the Geneva Observatory; complicated watches of every description, repeaters, chronographs, fly backs, independent seconds, and

a great variety of fancy watches and *bijou-montres*. He also exhibits the third prize at the Concours de Reglage, 1892.

L. Bachmann, late Fritz Piquet & Bachmann, makes complicated and precise time-keepers his specialty. He exhibits watches guaranteed by first-class certificate from the Geneva State Astronomical Observatory, repeaters, fly backs, quarter and split seconds, race-timers' recorders, calendar and astronomical watches, bijou watches decorated with diverse jewels.

In chronometers are specially noted first-class lever chronometers, minute repeaters, fly back, with certificate; 42-jeweled lever, fly back, split second and minute recorder; full chronometer with certificate; 31-jeweled lever, one-quarter repeater and calendar; same without calendar; 36-jeweled lever, minute repeater, fly back, split seconds; the first prize at the chronometrical competition at Geneva in 1890; stop watch, split seconds, 26 jewels.

There are many profusely decorated chatelaines and flower pins containing watches and flower sprays and insects encrusted with precious stones. Ninety-two watches comprise the exhibit. The firm has obtained distinction at Paris, 1876; Melbourne, 1880; honorific diploma Zurich,

1883; Antwerp, 1885, and first prize Geneva Observatory at the chronometric competition in 1876, 1887 and 1890.

Jacobs & Co. show first-class lever movements with Breguet spring in large numbers; lever watches with bracelet movements, and chronometers and one-quarter and minute repeaters with first-class certificate from the official observatory. A number of chronographs also are shown.

H. Redard & Fils have a fine line of repeaters and chronographs, double chronographs, split seconds and double chronographs, repeaters of all kinds, complete calendars, visible chronographs and a large assortment of bracelet and small size decorated watches.

High grade watches constitute the exhibit of Marius Lecoultre. Fine chased cases and four gems in enameled and decorated chatelaines complete his case.

*(Series to be continued.)*

The death of A. D. Rowell, St. Johnsbury, Vt., occurred recently. Deceased was born on Feb. 9, 1839, and had been in business in St. Johnsbury since 1865, in the employ of T. M. Howard till 1870, then as partner in the firm of Howard & Rowell till 1887, and subsequently alone.

# “WORKSHOP NOTES.”

For Jewelers and Watchmakers.”

BEING A COLLECTION OF THE LATEST PRACTICAL RECEIPTS ON THE MANUFACTURE AND REPAIRING OF WATCHES AND CLOCKS, AND ON THE VARIOUS PROCESSES ENTERING INTO THE MANUFACTURE AND REPAIRING OF JEWELRY, AS COLORING, POLISHING, ENAMELING, ANNEALING, OXIDIZING, ETC. IN; SHORT A THOROUGH COMPENDIUM OF THE NUMEROUS MECHANICAL DEPARTMENTS OF THE JEWELERS' AND WATCHMAKERS' SHOP.

**200 PAGES, BOUND IN CLOTH, STIFF COVERS.**

**PRICE \$2.50, BY MAIL, POSTPAID,**

**Including a Year's Subscription to the “Jewelers' Circular.”**

**THE JEWELERS' CIRCULAR PUBLISHING CO.,  
189 BROADWAY, NEW YORK.**

## A GLIMPSE OF THE GORHAM MFG. CO.'S EXHIBIT.

PART VIII. (Continued from page 1.)

are all of gold inlaid with brilliant enamel of blue, green, maroon and modified shading in harmonious effect, and the handle is set with carbuncles. This strikingly original piece is a product of Mr. Codman's. It is

and the tray of repoussé sterling silver, which form the frontispiece of this number. The list of decorated glassware of both the mounted and blown glass is large and valuable, including loving cups valued at from



STERLING SILVER TEA KETTLE AND STAND.

ten and a half inches high and is valued at \$400.

Among very attractive pieces are the decorated glass silver-mounted toilet bottle,

\$250 to \$500 each, tankards, claret and champagne pitchers, jardinières, punch bowls, vases, fruit dishes, ice bowls, etc. One of the principal sets is a

champagne set consisting of a pitcher standing twelve inches high, of rich design, a ladle and twelve engraved glasses. The tea kettle illustrated is of a tea service designed by George Wilkinson and is a marvel of artistic excellence. The set includes a waiter, kettle, coffee and after dinner coffee, cream pitcher, sugar and slop bowls. It is known as a Cupid set from its design of Cupids and natural flowers, in repoussé work of the highest order. The elegance and refinement of the shapes are wonderful. It is, on the whole, one of the most unique and delicately executed exhibits in the whole collection. The waiter is of an irregular shape, its border winding in artistic curves. The handles of the pieces are of ivory, delicately carved.

(To be continued.)

Delicate work in gold and silver is displayed by J. S. Kaufmann, Frankfort-a-Main, just southeast of the Royal Dresden porcelain exhibit. The silver and gold work is mounted on porcelain and glass and is delicately wrought in graceful patterns. The line of articles represented is large and varied, and includes wares both useful and ornamental. Trays, jardinières, vases, cane and umbrella heads and toilet and writing materials are shown, with silver and gold wrought about hand painted panels. Photo frames are shown with engraved floral designs, and many of the porcelain frames have beautifully colored hand painted panels. Cupids are a leading feature in panel ornamentation and the features and pose are excellent. The line meets with a full measure of admiration from the visiting public.

Silver topped scent bottles, with a lock and key attachment, are now made ostensibly for the purpose of preventing evaporation, but really to prevent pilfering on the part of sisters and brothers.—*Philadelphia Record*.

### JEWELERS.

We guarantee to sell you **Sterling Silver Flat Ware** at a less price than any other manufacturer, and give you newer designs.

We will increase your profits if you will let us. Is it not worth trying?

**OVAITT & WARNER, Silversmiths,  
PORTLAND, OREGON.**

**M**OSELEY & COMPANY, ELGIN, ILL., would call your attention to the fact that they had planned to have an exhibit at the World's Columbian Exposition, and after many delays had space assigned, not where they expected it, but in Machinery Hall. During this time orders came in thick and fast, and our stock was so near exhausted that we could not make (to us) a satisfactory exhibit. Though working fifty men and making overtime we are still struggling to catch up with our orders. And still they come. We intend to have a fair exhibit with all the jobbers in Genuine Tools and Materials in Chicago for your inspection, and those wishing to learn the HOW to do any particular thing on the Moseley Lathe or any of its attachments, can do so by calling at the Chicago Watchmakers' Institute, No. 701 Masonic Temple, where the management will be pleased to give you a practical showing of the operation—which may be worth dollars to you, and other schools you may visit will be pleased to do the same.

Present your card, make known your desires, and you will be cordially received.

Yours truly,

**MOSELEY & CO,**

Send for this slip and  
new Catalogue.



## Regulations Governing Awards.

**RULE I.** Awards shall be granted upon specific points of excellence or advancement formulated in words by a board of judges or examiners, who shall be competent experts.

**RULE II.** This board of judges, which shall be composed, so far as practicable, of competent experts, shall be divided into thirteen committees, one of which shall be assigned to each of the thirteen great departments of the Exposition, as recognized by the classification adopted by the World's Columbian Commission. There shall be one or more women judges upon all committees authorized to award prizes for exhibits which may be produced in whole or in part by female labor.

### INDIVIDUAL JUDGES.

**RULE III.** The individual members of the said thirteen committees shall be, so far as possible, competent experts, and shall perform such duties and examine such exhibits as shall be assigned them by the Executive Committee on Awards; provided, however, that it shall be the right and duty of the departmental committee of each department, in every case where the character of the exhibit or the general interests involved be such as, in the judgment of a majority, to warrant and justify it, to notify the Executive Committee on Awards that there ought to be a special committee appointed to assist the individual judge in conducting the preliminary examination of a particular exhibit. There shall be a foreign representation upon each one of these thirteen committees.

### DUTIES OF JUDGES.

**RULE V.** It shall be the duty of each individual judge to make a report in writing, over his signature, of the result of the examination of each exhibit primarily examined by him, as each examination shall have been completed; and as to every exhibit so examined which he shall deem worthy of an award, he shall formulate in words the specific points of excellence or advancement disclosed thereby, and which, in his opinion, render it worthy of an award. Every report shall be submitted as soon as possible to the committee of which such judge is a member, for a finding in the premises; and in every case where, by the vote of the majority of such committee, it is determined that an exhibit is worthy of receiving an award, said committee shall forthwith formulate in written words the specific points of excellence or advancement which, in its opinion, warrant the award, and transmit the same, certified by its president, or vice-president, and secretary, to the Executive Committee on Awards. And in case the finding of the committee shall differ from the conclusion of the individual judge making the preliminary examination, either as to its being worthy of an award or as to the character of the points of excellence or advancement it possesses, it shall be so distinctly stated in

the report of said committee. In every case where the finding of the departmental committee coincides with the conclusion of the individual judge, the said committee shall transmit, with such finding, the report of such individual judge to the Executive Committee on Awards; and in those cases where the finding of the departmental committee does not coincide with the conclusion of the individual judge, then the finding in each such case shall be accompanied by the written report of one of its members who shall have examined the exhibit, formulating therein in words the specific points of excellence or advancement possessed by such exhibit.

**RULE VI.** In every case where the finding of the committee is not in accord with the conclusion of the individual judge, or of such assistant special committee, it shall be within the power of the Executive Committee on Awards, if in its judgment justice demands it, to refer the report back to the committee of that department whence it emanated, with the direction to review and further consider the case and report its finding under such review, without delay, to said Executive Committee on Awards; and such finding shall be conclusive. There will be but one class or kind of medals, which will be made of bronze and be works of art, and be accompanied by parchment diplomas, on which shall be formulated the specific points of excellence presented by the exhibit receiving the award. Notice shall be given to all exhibitors, whether domestic or foreign, that the medals and diplomas to be awarded are by authority of the Congress of the United States, and are prepared by the Secretary of the United States Treasury.

**RULE VIII.** Should any exhibitor, domestic or foreign, become a judge under these rules, his or her exhibit shall be excluded from examination for award, but the Executive Committee on Awards may cause such exhibit to be examined, and a report thereon made to complete the history of the Exposition.

**RULE IX.** Any exhibitor may have his exhibit exempt from examination for award by notifying the Executive Committee on Awards; otherwise the Executive Committee on Awards shall have the right, through its regularly appointed judges, to examine every exhibit, domestic or foreign, whether presented by an individual, association of individuals, institution, government, or department thereof.

**RULE XI.** Upon the completion of the work of the judges, the results thereof shall be presented by the Executive Committee to the full Committee on Awards, which committee shall in turn report to the World's Columbian Commission, or in its absence to the Board of Reference and Control, by whom the formal promulgation of the awards and the distribution of medals and diplomas shall be made with appropriate ceremonies.

In a recent article on the exhibit of Louis Kuppenheim, of Pforzheim, a number of novel articles were mentioned as made of oxidized silver. This should have read oxidized steel. This firm has succeeded to a marked degree in producing an article from steel that is beautiful in appearance and durable in color. The goods are not simply oxidized but are treated in a manner that insures them against tarnishing.

# REED & BARTON,

## Silversmiths,

MANUFACTURERS OF

STERLING *and* SILVER PLATED  
SILVER WARE.

Salesrooms:

37 Union Square, New York.

32-36 WASHINGTON ST.,

Venetian Building, Chicago.

FACTORIES, TAUNTON, MASS.

## Chicago.

The following jewelers were noted in the city and at the Fair last week:

Jas. E. Scanlan, F. Hlodgson, Boston; Chas. E. Axt, Odell, Ill.; James A. Mickett, Greencastle, Ind.; W. E. Sams, Clinton, Mo.; D. A. Hauk, Logansport, Ind.; I. W. Helfrich, Carrollton, O.; F. E. Brodie, Batesburg, S. C.; Samuel Levin, Marengo, Ill.; A. Stankiewicz, Hallettsville, Tex.; Eugene Mayer, Appleton, Wis.; C. W. Hoen, Findlay, O.; Alex. Milne, Newark, N. J.; Frank Childs, Osage Mission, Kan.; W. L. Pedersen, Clarinda, Ia.; Jos. Sauer, Newport, Ky.; Mr. Barger, Kansas City, Mo.; Dave Steinberger, S. A. Rider Jewelry Co., St. Louis, Mo.; H. A. Bedel, Jackson, O.; R. Harris, Washington, D. C.; Edwin D. Moore, Newcastle, Pa.; D. S. Whitaker, Lebanon, Ind.; Geo. S. Katz, Philadelphia, Pa.; G. Kortenhaus, Philadelphia, Pa.; J. C. Hanna & Son, Newcastle, Pa.; Walter Uppington, C. M. Frazier, Newark, O.; H. Best & Son, Dayton, O.; Leopold Jansen, New Orleans; M. Lissner, Oakland, Cal.; E. W. Mickolls, Eldora, Ia.; Thomas Harvey, Wheeling, W. Va.; Theo. W. Fink, O. C. Genter, Wheeling, W. Va.; Edwin D. Moore, Newcastle, Pa.; W. R. McHenry, Hornellsville, N. Y.; Geo. E. Lees, Bowler & Burdick Co., Cleveland, O.; Lott Reznor, Arkport, N. Y.; John Henrickson, Omaha, Neb.; H. Slochem, John N. Disselkoe, New York; William J. Nolan, Simons, Bro. & Co., Philadelphia, Pa.; M. F. Kratt, Toledo, O.; J. R. Hamer, Philadelphia, Pa.; G. S. Melville, Boston; Frank Kline, Spring City, Pa.; H. L. Josephs, San Francisco, Cal.; A. L. Delkin, Atlanta, Ga.; Simon Hesse, Cincinnati, O.; John Lamb, New York; R. E. Wood, Arro Gordo, Ill.; M. L. Levy, San Francisco, Cal.; Geo. B. Bennett, Brodhead, Wis.; A. P. William, Waltham, Mass.; Frank A. Kunz, Eugene Deimel, Detroit, Mich.; E. B. Brumm, Shenandoah, Pa.; E. S. Blake, Baltimore, Md.; M. F. Kohler, Parsons, Kan.; E. T. Wilton, M. D. Houston, Tex.; Chas. P. Henn, Buffalo, N. Y.; Chas. Price, Jacksonville, Ill.; R. G. Rutherford, F. H. Ingalls, St. Louis, Mo.; C. C. Adams, Brooklyn, N. Y.; John H. Klein, Stratford, Ont.; Theo. A. Weber, Pittsburgh, Pa.; Du Bois Conklin, Grand Rapids, Mich.; Fred Maynard, Gibsonburg, O.; Van Antwerp & Stocum, Tipton, Ind.; C. E. Hart, Albert Bros., Cincinnati, O.; Chas. F. Herdle, Rochester, N. Y.; Frank W. Baier, St. Louis, Mo.; J. F. Schmitt, St. Louis, Mo.; Wm. F. Engelhart, Philadelphia, Pa.; A. O. Dickinson, Hiawatha, Kan.; John T. Moye, Oxford, Ala.; Max H. Elbe, Niagara Falls, N. Y.; Thomas Gaff, Aurora, Ind.; D. A. Hibbard, J. B. Storer & Co., Akron, O.; Carl A. Bostedo, Thos. H. Lees & Sons, Toronto, Ont.; J. G. Laupus, Seymour, Ind.; B. Curtis, Stepey Depot, Conn.; Henry W. Schumacher, New York; Sam B. Goldberg, Amberg & Co., Cin., O.; Jos. H. Solm, Quincy, Ill.; J. B. Allen, Maysville, Mo.; C. H. Tullar, Shelby, Mich.; C. R. Meschke, Pittsburgh, Pa.; J. C. Schaefer, Pittsburgh, Pa.; Geo. M. Rigdon, Streator, Ill.; W. S. Ziller, Toronto, Can.;

B. S. Ginder, Vicksburg, Miss.; P. E. Godfrey, Mobile, Ala.; M. W. Seebers, Bainbridge, Ga.; E. L. Marsh, Ft. Dodge, Ia.; E. C. Brower, Fife Lake, Mich.; Henry Yost, Vicksburg, Miss.; C. A. Stone, Sherwood, Mich.; T. Ernst, Ft. Mastison, Ia.; Andrew Dunn, Ft. Plain, N. Y.; C. Hyman, San Francisco, Cal.; Fred D. Steck, N. H. White & Co., New York; John R. Hamer, Philadelphia, Pa.; Herman F. Wolff, Philadelphia, Pa.; Frank Anstrutz, Shenandoah, Pa.; C. H. Dew, Summerfield, O.; J. D. Smith, Union City, Ind.; F. G. Mitchell, Marshall, Mo.; W. J. Flack, Detroit City, Minn.; C. E. E. Hartwith, Cincinnati, O.; Otto E. Heineinan, Allegheny, Pa.; J. B. S. Daffer, Merrill, Wis.; F. C. Hoagland, Albany, N. Y.; Louis H. Norman, Reed City, Mich.; J. W. Worstell, West Liberty, Ia.; C. E. Range, Trenton, Mo.; Chas. F. Renner and wife, Shelby, Mich.; Black & Connelly, Detroit, Mich.; S. C. Levy, Philadelphia, Pa.; Wm. Gowland, New Orleans, La.; Theo. A. Weber, Pittsburgh, Pa.; Geo. A. Bowen, Bridgeton, N. J.; R. H. Kline, Spring City, Pa.; J. P. Whiting, Tyler, Tex.

Visitors at the Chicago Jewelers' Association's rooms last week were:

John D. Smith, Union City, Ind.; G. Lauterschlaeger, Cincinnati, O.; Asa Collier, Plainfield, N. J.; Geo. S. Katz, Philadelphia, Pa.; H. W. W. Starcke, Junction City, Kan.; R. Segelman, Homestead, Pa.; J. P. Stevens, Atlanta, Ga.; A. Stankiewicz, Hallettsville, Tex.; H. W. Wildt, Alexandria, Va.; Frank Kline, Spring City, Pa.; E. J. Peck, Braidwood, Ill.; W. M. Baker, Fayette, Ia.; Agnes F. Spicer, Willmar, Minn.; Petra Gjums, Minneapolis, Minn.; W. H. Long, Philadelphia, Pa.; H. A. Tunehorst, Jerseyville, Ill.; Claude E. Range, Trenton, Mo.; A. McLeod, New York; Mrs. Weachtin, Sheboygan, Wis.; A. C. Parsons and wife, Vinton, Ia.; G. W. Pittman, Gatesville, Tex.; O. C. Lane, Boston, Mass.; J. K. Ritter, Muncie, Ind.; Lewis Hohneck, Cincinnati, O.; Louis Rohar, Wilkesbarre, Pa.; C. W. Norton, Waterloo, Ia.; T. Benninger, Louisville, Ky.; R. Pinkstone, Philadelphia, Pa.; E. E. Marek, Illinois Watch Co., Springfield, Ill.; S. H. Bauman, St. Louis, Mo.; J. A. Kimpel, Clarington, O.; Geo. A. Bowen, Bridgeton, N. J.; Isaac Herzberg, Philadelphia, Pa.; Frank E. Kaulsen, New York; Geo. A. Poetz, Mobile, Ala.; J. H. Rubin, Philadelphia, Pa.; John W. Prior, Fayetteville, N. C.; N. E. Godfrey, Mobile, Ala.; P. B. Crosby, Duluth, Minn.; Arthur S. Goodman, Philadelphia, Pa.; Howard R. Mason, Newton, Mass.; Wm. Black, Birmingham, Ala.; E. J. Schmitt, Rodney, Ont.; J. I. Seebers, Bainbridge, Ga.; Fred Lord, New York; A. Cager, Cleveland, O.; John M. Sinclair, Minneapolis, Minn.; Mr. Bayley, Duluth, Minn.; W. E. Macdonald, Minneapolis, Minn.; Geo. M. Geor, Providence, R. I.; Geo. C. Edwards, Bridgeport, Conn.; Ralph E. Moore, Bridgeport, Conn.; Henry Austin, Belton, Tex.; J. G. Rawls, Wilson, N. C.; A. A. Gillett and wife, Buffalo, N. Y.; Dan. Hyman, San Francisco, Cal.; F. T. Petre, Columbus, Ga.; A. Thoma, Piqua, O.; John S.;

Murphy, Pontiac, Ill.; I. Lesem, Kansas City, Me.; Geo. E. Morrill, Boston, Mass.; H. A. McLoskey, Omaha, Neb.; G. F. Duncan, Eau Claire, Wis.; D. Mt Small, Lincoln, Neb.; John T. Moye, Oxford, Ala.; Lof; Beznor, Arkport, N. Y.; A. C. Anderson, Toronto, Can.; G. Roderberg, Providence, R. I.; W. R. Waugh, London, Ont.; H. G. Thomson, London, Conn.; H. W. Getts, Clay Center, Kan.; O. E. Amundson, Menominee, Mich.; F. L. Carpenter, New York; Henry Tilden, Providence, R. I.; Goodman King, St. Louis; Miss Mary Owen, Cincinnati, O.; J. W. Coatsworth, Galena, Ill.; W. S. Pederson, Clarinda, Ia.; C. B. Woorley, St. Joseph, Mo.; A. J. Smith, Applehill, Ont.; Joe A. Young, Bellevue, Ia.; A. E. Colburn and wife, Argenta, Ark.; M. Wittelshofer, Gd. Forks, N. D.; John McKinney, East Liverpool, O.; Louis H. Jerger, Thomasville, Ga.; Walter C. Kern, Pawnee City, Neb.; Miss M. Bertha Kern, Pawnee City, Neb.

Mr. Le Cato, manager of the Gorham Mfg. Co., retail department, in New York city, will remain in charge of the World's Fair exhibit till September.

Adolph Pentz & Co., lapidaries, 85 Washington St., last week made an assignment to J. H. Moore. The assets and liabilities are each placed at \$3,000.

Thursday Chung Wung Kee, of China, sold a \$10 piece of carved ivory from the Chinese exhibit. Friday the Chinese exhibit was closed by the custom house officials.

Louis H. Jerger, Thomasville, Ga., says the south is awaiting lower railway rates. Such reduction as was made was so hemmed about with limitations as to be of little benefit to the Fair.

All the clocks in the Government building stopped Wednesday because the contract for winding them had expired. The man who had been doing the work had made a new bid, but it was not accepted by the Washington authorities, and as a consequence the timepieces were allowed to run down.

The wives of Will Burton, Gorham Manufacturing Co., and John L. Shepherd, New York agent of the Keystone Watch Case Co., amused themselves during the travelers' parade in giving away souvenir case openers at the Keystone stand. Result? A complete demoralization of the line of march and three cheers and a tiger for the ladies.

**DIAMONDS** **WATCHES** **BHA** **JEWELRY** **MANUFACTURING**

**LAPP AND FLERSHEM** Chicago, Ill.  
92, 94, 96 & 98 STATE ST. COR WASHINGTON

**THE LARGEST SUPPLY DEPOT**

*For Everything Needed by Jewelers*

**ILLUSTRATED CATALOGUES FURNISHED JEWELERS.**  
**SPECIAL FACILITIES FOR FILLING ORDERS NO RETAILING!**

**STERLING & SILVER PLATE** **BHA** **OPTICAL** **GOODS**

J. V. Ridgway is back from a fishing excursion to Cedar Beach, Ind.

E. C. Pike, representing Wm. M. Fisher & Co., has returned from New York.

Mr. Thoma, of Thoma Bros., Piqua, O., left Chicago for a week's visit in Wisconsin.

I. Adler, of the Seth Thomas Clock Co.'s New York office, is among the Fair visitors.

Mr. Frick, of Ford & Frick, Freeport, Ill., is quoted as an authority on Midway and Old Vienna.

John A. Hudson, for the Roy Watch Case Co., left July 17th for a business trip to western cities.

W. B. Smith, of B. & W. B. Smith, New York, returned home Thursday after a short visit of three days.

Geo. E. Edwards, of the Holmes & Edwards Silver Co., spent several days the past week in Chicago.

C. S. Clinton, North Platte, Neb., has returned with his wife from Grand Rapids, Mich., and is spending a few days at the Fair.

Professor Wiese, of Hanau, and G. A. Scheid, of Vienna, will be the judges for awards in the German jewelry section at the Fair.

O. C. Lane, the New England representative of Reed & Barton, left Tuesday last for the east, having enjoyed the Midway and the Fair.

A. E. Bentley, local manager for the United States Watch Co., Waltham, Mass., will return about Aug. 8th, after three weeks

at the factory. The company are getting out a full line of 17 jeweled goods in 6 and 18 sizes.

D. Gruen, president of the Columbus Watch Co., is attending the Columbian event. He reports the factory running on full time.

Geo. B. Ludy, of Ludy & Taylor, Cedar Rapids, Ia., was noticed as an interested visitor to the Congress of Nations boulevard at the Fair.

J. T. Wells, traveler for the Holmes & Edwards Silver Co. and the Manhattan Silver Plate Co., left Saturday last for Milwaukee and the northwest.

R. Wallace Sons' Mfg. Co. are making for B. F. Norris, Alister & Co., an official souvenir stamp box with a reproduction of the Woman's building on the cover.

Henry Tilden, of Tilden & Thurber Co., Providence, has completed his examination of the collection exhibit of the New England Manufacturing Jewelers' Association.

H. S. Noyes, western representative of Bates & Bacon, left July 16th for a few days with St. Louis jobbers. E. R. Cribben, the general manager, accompanied him. Mr. Cribben returned to New York.

Nicolo Parodi is a filagree silver worker of Genoa, Italy, and has a fine exhibit in the west gallery of the Manufactures building. Mr. Parodi entered five cases of goods and later had two cases released. Previous to their release, however, the customs officials in checking up discovered a shortage and placed an inspector in charge of the exhibit.

It was then discovered that the goods had been entered at an undervaluation of 40 to 60 per cent., or at manufacturers' cost. There will be a re-appraisal and Parodi will pay the duty on all the goods brought over.

The State meeting of the Retail Watch-makers' and Jewelers' Association of Illinois will convene at the association headquarters, 511 Masonic Temple, Aug. 3d, for the election of State officers. It is proposed to pass a resolution that each member of the association, after being examined by a board of examiners and found to be thoroughly competent in the art of watch-making, shall receive a diploma and be recommended to the confidence of the public. Various other matters of an interesting nature will be brought before the meeting, action on which will be had in the State association before being presented to the next National meeting for the approval of that body.

**THE PLANCHAMP & BECKER CO.**  
Makers and Repairers of  
**WATCH CASES,**  
Gold and Silver Plating —  
— of Watch Cases a Specialty.  
UNEXCELLED FACILITIES.  
63 and 65 East Washington St., Chicago.



**HENRY J. ROHRBACH,** 94-96 State Street, (Room 524.) CHICAGO.  
SILVERSMITH AND MANUFACTURING JEWELER,  
GOLD, SILVER AND NICKEL PLATER.  
Silver and Silver-Plated Ware of all kinds Repaired, Refinished and Polished at Low Prices.  
SEND FOR PRICE LIST.

ALL KINDS OF BRONZES REPAIRED AND REBRONZED.  
Full facilities for manufacturing and repairing all classes of Jewelry for the Trade.  
Remember—Room 524.

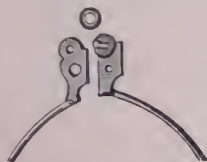

Racine Jewelry Mfg. Co.,  
**SPECTACLE TEMPLE WASHERS.**  
Gross in a Bottle, 25c.  
For Sale by Dealers in Jobbing Materials

ESTABLISHED 1879.

**G. W. HOOK,**  
MANUFACTURING JEWELER,  
149 and 151 State Street, Chicago, Ill.  
INSPECTION BY THE VISITING TRADE INVITED.

**THE FINEST OILS EXTANT:**



**\$1,000 CHALLENGE FOR THEIR EQUAL.**

The following telegram, recently received, is self-explanatory:

To Thos. H. Purple, Mngr., No. 65 Washington St.—The Manhattan Silver Plate Company is certainly very proud to have their Mr. T. H. Purple, Sec'y of so worthy an Association as the Associated Exhibitors and, as New Yorkers, the sympathies of our company are with the World's Fair, and anything you can do to assist the exhibitors in getting low railroad rates, and increase the attendance to the Fair, as we believe that those who don't come are the losers. We shall certainly be very proud to know that you are working in the right direction.

O. F. THOMAS, *President*,  
Manhattan Silver Plate Co.

**Kansas City.**

J. Russ Mercer is spending a vacation fishing on the Current River.

Burglars broke into E. C. Davault's store at Furber, Mo., but did not get much booty.

T. J. Turner has re-opened his store at 11 W. 9th Street, with the P. D. French Drug Co.

Martin Hoeker has returned from Chicago and will probably begin business here as manufacturing jeweler.

L. S. Cady, of Cady & Olmstead, has gone to Wagon Wheel Gap, Col., where he will stay until cold weather sets in.

Harry B. Carswell will leave Aug. 5th for a trip to the World's Fair and to New York. He will be accompanied by Mrs. Carswell.

The Jaccard Watch & Jewelry Co. are getting out an illustrated catalogue of Masonic emblems and an illustrated catalogue of general stock for their Fall trade.

A copyrighted design for an emblematic pin and button for the Home Palladium, a secret benefit order, designed by the Jaccard Watch & Jewelry Co., has been accepted by the supreme lodge of that body.

**Indianapolis.**

H. E. Bergh, a watchmaker from Madison, Minn., has located in this city with J. C. Sipe.

C. M. Hunnicutt, Rockville, Ind., has returned from the World's Fair.

Emmet Pee, of Nichols, Pee & Co., made a flying business trip into Illinois last week.

F. M. Herron's street clock has been replaced in the new cement pavement in front of his store.

Wm. Linder, member of the firm of Baldwin, Miller & Co., is confined to his home by illness.

J. S. Scott has moved his work bench into a part of Gribben & Grey's jewelry store at 92 N. Illinois St.

O. W. Danielson, Greenfield; Geo. A. Fletcher, Carthage; W. A. Pilkensons, McCordsville, and L. C. Phillips, Carbon, were some of the Indiana jewelers who came to this city last week to buy goods.

Special despatches from Waterloo, Ind., under date of the 19th inst., stated that Frederick J. Yesbera, Auburn, Ind., had failed for \$20,000 and had made an assignment. It has since been proven that the report was entirely without foundation. Mr. Yesbera made no assignment and his business relations continue undisturbed. The report seems to have been prompted by pure malice. The First National Bank of Auburn states that Mr. Yesbera's credit is unimpaired.

**Has H. Bernard Nemitz Robbed the Swiss Watch Exhibitors?**

CHICAGO, Ill., July 31.—H. Bernard Nemitz has fled to Canada. Mr. Nemitz was in charge of the Geneva section of the Swiss watch exhibit at the Fair. He had been as a professional exhibitor, engaged to erect the Swiss pavilions. For this he received 110,000 francs. He sublet the work to contractors for 57,000 francs and pocketed a profit of 53,000 fcs. Commissioner Perrenoud said a man couldn't make such a profit and be honest, and on this ground discharged him.

Saturday night, Nemitz, his two sons and

their governess were missing. Heavy embezzlement is the charge against Nemitz, and an examination of the salesbook shows \$2,979 missing. In checking up the exhibits in the Geneva section by customs inspectors there was found to be a shortage amounting in value to 8,000 francs, six watches and some forty pieces of jewelry.

Thursday the following telegram was received from Toronto: "H. B. Nemitz, George Nemitz, Albert Nemitz and Josephine Wagner arrested; \$24,000 in United States money, and French, Turkish and Belgian bank shares, also twenty-three watches found on them. Send complaint on at once to lay charge here. Answer.

P. J. GRASSETT, *Chief Constable.*"

Commissioner Perrenoud says the bank shares and nearly if not quite all the money and watches captured with Nemitz were his (Nemitz's) private property. He estimates the \$2,979 short in the sales accounts and six of the watches to be the property of the Swiss exhibitors. It is possible, however, that Nemitz has not wronged the Swiss people. The money received may have been forwarded to Geneva. But the Government wants Nemitz and steps will be at once taken to have him extradited.

John C. Adams succeeds Nemitz in the Geneva section.

In a cabinet to the left of the main entrance to the Michigan State building is a beautiful collection of Lake Superior copper and quartz specimens of which a large number have been mounted as scarf and bonnet pins. The exhibit is chiefly remarkable as a collection of cabinet ores. On the opposite side of the entrance are chorastolite and Thompsonite ready for setting, copper and iron match safes, pins of native silver, quartz scarf pins, copper souvenir spoons, memaitite studs and scarf pins, calcite and agates. G. Deimel, formerly a jeweler at Hancock, Mich., makes the exhibit.

**The Wadsworth Watch Case Co.**



Filled



Cases.



General Offices,  
**NEWPORT, KY.**

Chicago Office,  
**COLUMBUS BUILDING.**

**Minneapolis and St. Paul.**

G. Hallauer, Minneapolis, has gone on a two weeks' trip to Chicago.

A. Pearlman, Bayfield, Wis., was in Minneapolis on business last week.

Mr. Thorp, of E. B. Woodward & Co., Morris, Minn., visited the Twin Cities last week.

Ed. Fessler, St. Paul, has gone to his home at Fort Dodge, Ia., on a two weeks' visit.

B. B. Marshall & Son, Minneapolis, have discontinued their auction sale, and intend to resume again in the Fall.

T. R. Wall, representing the Geneva Optical Co., Chicago, and Ed. E. Spaulding, representing Lapp & Flershem, of Chicago, called on the Twin Cities jobbers, the past week.

W. B. Woolsey has opened a repair shop at 1007 Nicollet Ave., Minneapolis. Mr. Woolsey was formerly engaged in the jewelry business here, but sold out and went to California, where he resided for the past three years.

The schedule filed in the matter of the affairs of Harry F. Legg, Minneapolis, shows liabilities amounting to \$100,026.57. Dora V. Legg appears for \$34,334.35 of the amount and Goodman Bros. for \$12,836.64. These are the heaviest creditors.

Frederick Stevens, an engraver in the employ of J. R. Elliott, Minneapolis, last week took an overdose of morphine and narrowly escaped death. He became unconscious, and at one time it was thought that he was dead. He is subject to violent pains from an organic disorder and has been in the habit of taking morphine to relieve him.

F. M. Sproehle & Co., of Chicago, since their proceedings against their agent, J. W. Loewenberg, have decided to close their St. Paul branch, and have shipped the entire stock and fixtures to Chicago. F. Wilman, traveling salesman for the firm, will hereafter look after the Twin Cities trade, making frequent trips here, to remain a week or so at a time.

**Omaha.**

C. S. Raymond has been on a hunting trip in Wyoming with a party of friends.

At the National Tournament of the Turners, at Milwaukee, Wm. Bloedel, manufacturing jeweler for Max Meyer & Bro. Co., won the fifth prize.

Mr. Ryan, manager in charge for A. B. Huberman, reports an invoice of diamonds just received from Mr. Huberman, who resides in Hamburg, Germany.

L. E. Hoiten, jeweler and diamond setter for J. Lindsay, is quite famous among the bicycling fraternity of the State; he recently

**PARSONS : SCHOOL**  
— FOR —  
**WATCHMAKERS,**  
**PEORIA, ILL.**

Send for Circular and Terms.

**PARSONS & CO.**

carried off the prize medal as State champion, and at the tournament given in this city, won the gold medal offered by himself as a first prize, valued at \$75.

Mr. Patterson, of the defunct firm of Shook, Patterson & Co., has taken a position as traveling salesman for Max Meyer & Bro. Co., pending the settlement of the affairs of his firm, the trial of which is set for August.

The Max Meyer & Bro. Co. are removing from their present stand at the corner of 16th and Farnam Sts., to their own business building on the corner of 13th and Farnam Sts. This is done with the intention of giving up their retail jewelry trade entirely, for which the old stand was the finest in the city. They find that their retail trade interferes with their wholesale. The building owned by them on the corner of 13th and Farnam Sts. is in the wholesale part of the city, and quite as available for their wholesale trade.

**Detroit.**

David Kay, of Wright, Kay & Co., has returned from Chicago where he has been on business.

Frank Smith, Jr. has returned from his European buying trip well pleased with his four months' work.

Robert Vanstone, a Michigan A'c. jeweler, has removed his stock, fixtures and family to Ridgeway, Ont.

F. F. Commerford, manager of the United States Optical Co., is in Chicago on business and to attend the World's Fair.

A fire at Midland, Mich., cleared out the center of the place. John S. Reams lost his stock of jewelry; damage not yet known.

H. W. Baxter, formerly with William Walthers, Wyandotte, Mich., has opened up a jewelry store at Birmingham, Mich. He was in this city last week.

A disastrous fire at Ewen, Mich., some days ago burned out the business portion of the town. W. Triglett lost his stock of jewelry valued at \$5,000.

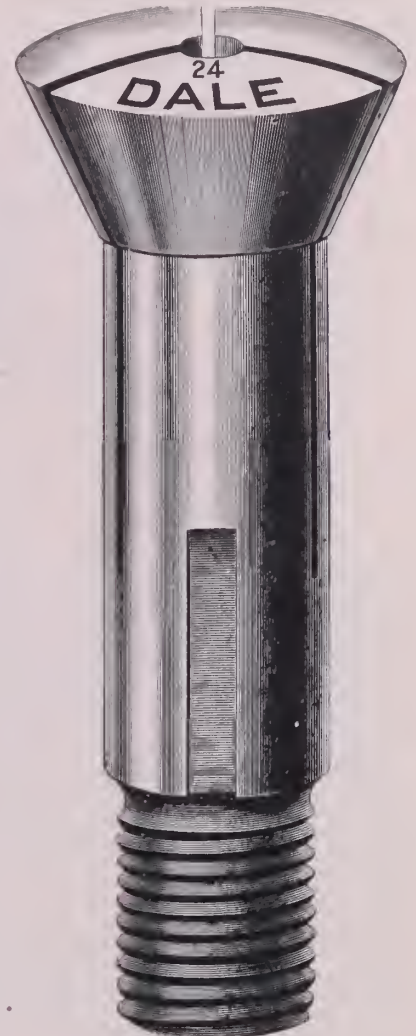

THE CELEBRATED  
**DALE CHUCKS,**  
For Watchmakers' Lathes.  
**Horological Tool Co.,**  
MANUFACTURERS,  
Office, 86 N. Clark Street, }  
Factory, 1036 Lincoln Ave., } **CHICAGO.**  
FOR SALE BY JOBBERS.

**ENGEL'S IMPROVED PATENT RING GAUGE.** Ask your Jobber for Them.

ENGEL'S RING GAUGE PAT. SEPT. 23. 90 PAT. SEPT. 1. 91 1 2 3 4 5 6 7 8 9 10 11 12 13 A.W. ENGEL M'FG. CHICAGO U.S.A.

USED BY ALL BY MAIL SAMPLE 15 CENTS. PRICE PER DOZEN \$1.25

25 DIFFERENT SIZES ALL IN ONE. SIZES CORRESPOND TO ANY STANDARD RING GAUGE. THE DEVICE BEING MADE OF DURABLE FLEXIBLE MATERIAL IN A STRAIGHT TAPE, IS ADAPTED TO BE SENT THROUGH THE MAIL.

**A. W. ENGEL,** { Manufacturer, Jobber and Watchmaker for the Trade } 115 Dearborn Street, CHICAGO, ILL.

SPACE FOR NAME AND ADDRESS WHICH WE PLACE ON LARGE QUANTITIES FREE OF CHARGE. WRITE FOR QUANTITY PRICE EXCELLENT ADVERTISING MEDIUM.



**GIBSON HOUSE,**  
CINCINNATI, OHIO.  
ABSOLUTELY FIRST-CLASS AMERICAN PLAN HOTEL. \$3.00 PER DAY.  
Extra Charge for Parlors and Rooms with Bath attached. The unequalled advantages in central location, liberal management, modern appointments, experienced service and perfect cuisine, have permanently established the Gibson House as **The Most Popular First-Class Hotel in Cincinnati.**  
AMPLE VAULTS FOR THE PROTECTION OF VALUABLES.  
**THE GIBSON HOUSE CO.,**  
H. B. DUNBAR. President and Manager.

# FLY BACK AND SPLIT SECONDS,

**ACCURATE  
AND  
RELIABLE.**



**PRICES  
MODERATE.**

**IN SILVER, FILLED AND GOLD CASES.**

**A. WITTNAUER, Manufacturer and Importer,  
19 MAIDEN LANE, NEW YORK.**

## BLANCARD & CO.,

LATEST ROCOCO DESIGN IN GALLERY.



DIAMOND SETTINGS. GALLERIES. HOLLOW BALLS, ETC.

SEND FOR OUR CATALOGUE.

**45 & 47 John St., New York.**

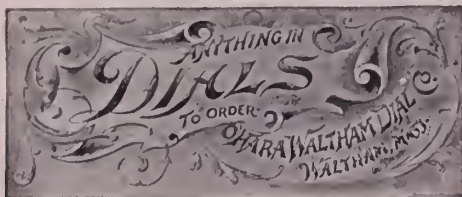

All the illustrations in this issue were made by  
**W. H. BARTHOLOMEW,  
PHOTO-ENGRAVER,  
88 SPRUCE ST., NEW YORK.**

## HENRY GOLL & CO.,

17 JOHN ST., NEW YORK.

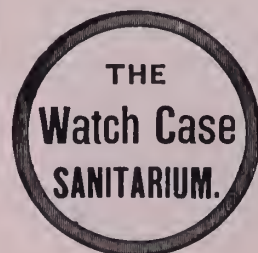

SPECIAL CASES  
MADE TO  
ORDER  
AND  
REPAIRING IN  
ALL ITS  
BRANCHES.

Henry Koester, of Kennedy & Koster, and Eugene Deimel, spent last week at St. Clair Flats. They were accompanied by their families.

The council committee on claims and accounts met last week and decided to allow the much contested claim of F. G. Smith, Sons & Co., for market clerk badges.

Ralph Dewey has entered the firm of Sturgeon & Co. He was formerly associated with F. G. Smith, Sons & Co., but has lately been connected with the Paris house of Spaulding & Co., Chicago. He recently returned from Europe and is now in the city.

The following jewelry firms have donated costly prizes for winners in the Tenth Annual Road Race to be held here by the L. A. W.: Wright, Kay & Co., Sturgeon & Co., F. G. Smith, Sons & Co., R. J. F. Roehm & Co., Black & Connelly and L. Black & Co. They are on exhibition in the windows of Mahley & Co.

Business among the jobbers and manufacturing jewelers remains quiet, although mail orders are steady. The following Michigan country buyers were in Detroit last week: P. W. Danger, Port Huron; F. S. Hall, Plymouth; J. S. McLaughlin, Wyandotte; Fred Grimm, Mt. Clemens; Mr. Bauer, Siebel & Bauer, Saginaw; A. W. Masher, Holly; I. D. Lane, Sand Beach; A. E. Rockwell, Northville; John Meher, Wyandotte, and William Ambler, Northville.

### Cincinnati.

Oscar Keck has returned from Europe.

Louis Rauch, of Strauss & Stern, buried his little boy last week.

David Gutman and George Peter, with L. Gutman, are on the road.

Ed. Pfaffle last week started for a two months' trip through Texas.

Strauss & Stern's offer of 25 per cent. to their creditors will probably be accepted.

B. F. Newman, of Frohman, Wise & Newman, has recovered from a spell of illness and will be on the road again soon.

O. E. Bell & Co. say they are receiving encouraging letters from their customers and look for good business this Fall.

The H. Keck Mfg. Co. will occupy the remodeled building two doors west of their present quarters as soon as it is completed.

While there is a lull in trade and the town is full of tourists, Duhme & Co. are pushing their new Cincinnati souvenir spoons with an etching of the five bridges in the bowl. They are selling well.

What a gay and festive old world this would be if we were only as independent of gold in the form of cash as in the form of jewelry!—Puck.

As silver is malleable always the proposed hammering of the Sherman law is strictly in accord with the best philosophy.—Philadelphia Times.



**L. Straus & Sons at the World's Fair.**

(Continued from page 46, July 26th.)

HAVING inspected and appreciated the beauties of the exterior of the World's Fair pavilion of L. Straus & Sons, 42-48



ELECTROLABRA OF CUT GLASS.

Warren St., New York, in which they make their exhibit of cut glass, the writer and the reader will in imagination enter the booth and pass judgment upon its decorative effects and contents. The interior has the same general color effects as the exterior, namely white and gold, with the exception that the tables are laid and the walls wainscoted with mirrors. The shelves are of plate glass upheld by gilt brackets. From these details it may be inferred, when the nature of the articles displayed is borne in mind, that the ensemble in its brilliancy and beauty reminds one of the jeweled palace of Aladdin.

Entering at either door the visitor is entirely surrounded by cut glass. Salient in

the center of the pavilion rises from a platform a cut glass electrolabra 12 feet in height. The stand is 2½ feet high, and thus this marvelous example of handiwork ascends approximately 15 feet from the floor into the dome above. This piece is the *chef d'œuvre* of L. Straus & Sons' cut glass exhibit, and we venture to say that there is nothing in its line in the great Manufactures building that excels it from any standpoint. No individual piece in the building attracts more attention from visitors, who marvel at the magnitude of the undertaking in producing a work of such size, elaborateness and artistic beauty.

The reader will appreciate the foregoing assertion when he considers that the electrolabra consists of from 1,300 to 1,400 individual pieces of glass of various shapes and all richly cut and highly polished. The pieces are held together by a thin frame of metal silver coated, so that the entire work appears to be of glass, the surface of the frame coinciding with the color of the glass. The cutting is in Straus' Americus pattern, a brilliant and tasteful design which admirably lends its beauty to such a work as the electrolabra.

The candelabra portion of the piece consists of thirty arms each holding a sixteen candle power lamp; in addition there are twelve arms for ornamental purposes. These arms are hung with richly cut bells, chains, pendants, rosettes, and other devices or attachments, all of novel shapes and exquisitely executed. The base of the piece is a wonderful piece of work in itself. It is three feet in diameter, the decorative effects in the cutting being deep grooves, thus bringing the details of the various designs in high relief. While the layman may consider that this portion of the piece shows less elaborateness of workmanship than the upper portions, the connoisseur will comprehend the great amount of study and labor expended in its production and pass the highest encomiums upon it. The candelabra is lighted up.

This electrolabra, it is admitted, is the largest article in cut glass ever produced, and is one of the *pièces de résistance* of the Manufactures building. Yet the surrounding articles are equal in artistic effect. Especially striking to the mind of the visitor is the great originality both as to shapes and to designs in cutting disclosed by the exhibit. Though cut glass, it may be safely asserted, admits of versatility of idea as to the cuttings, it does not as to the shapes; and we are used to see the same shapes produced by different manufacturers, at least they appear to be the same at the first glance. It is the policy of L. Straus & Sons to conceive entirely new shapes which they protect by design patents.

Entering by the door at the left hand side, the visitor obtains a view of the magnificent epergne or centerpiece illustrated

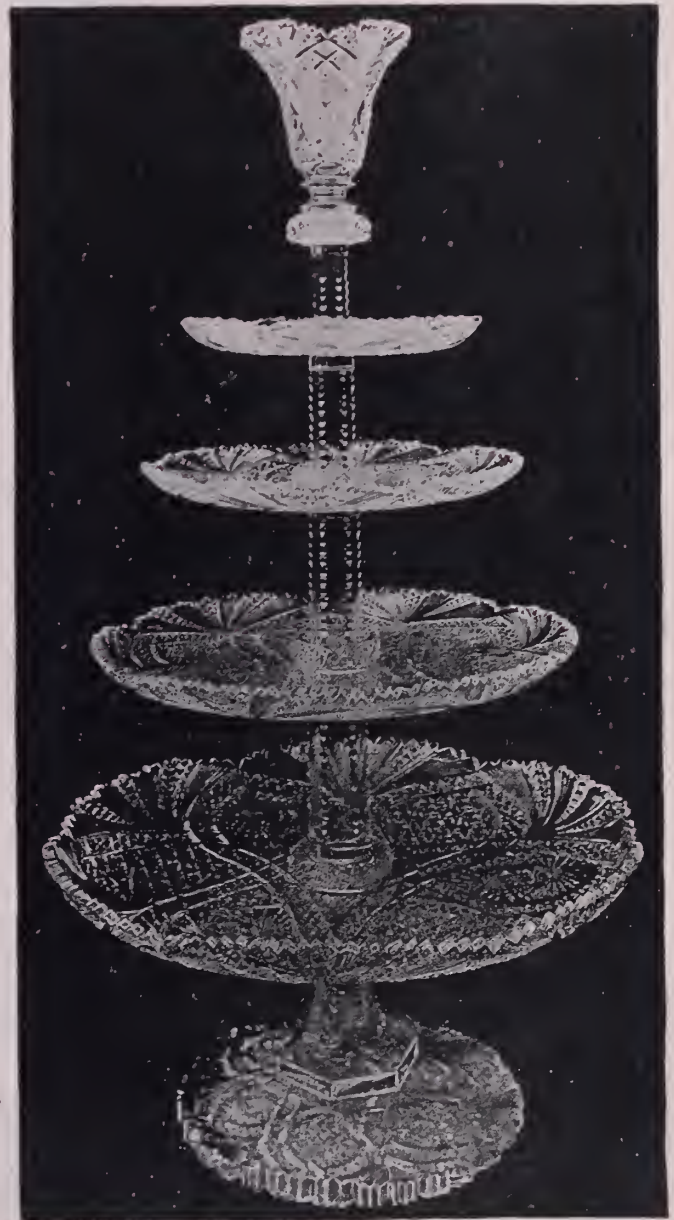

EPERGNE OF CUT GLASS.

herewith. It is 39 inches high and consists of a foot, shaft, four dishes for fruit and one holder for flowers; the lower dish is 20

# ROGERS, SMITH & CO.

UNION SQUARE,  
NEW YORK.

MERIDEN,  
CONN.

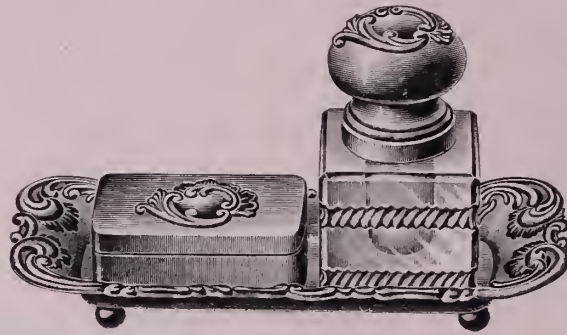

BEST QUALITY

## GOLD AND SILVER PLATE.

# MATHEY BROS., MATHEZ & Co.

MANUFACTURERS AND IMPORTERS OF

## Exclusively Fine Watches

FACTORY, **Brassus, Switzerland.** OFFICE, **21 & 23 Maiden Lane, N. Y.**



10 SIZE SPLIT.



10 SIZE MOVEMENT.

Having increased our facilities for manufacturing, we are enabled to furnish the trade an extensive line of our various grades. Our new models in plain and complicated watches are now ready. In variety, merit, and advantageous prices, we are in a position to satisfy any demand from our customers, who are cordially invited to inspect our stock.

Complicated Watches  
IN  
ALL SIZES  
AND QUALITY

# SPLITS

Plain Movements  
IN  
10, 14 & 16 Sizes.  
Very Small 6, 7, 8, 9 and  
10 Line Watches and  
Movements. Plain  
and Ornamented.

inches in diameter. This piece is cut in the Isabella pattern, a new pattern, patent applied for, conceived expressly for Exposition purposes, and one unexcelled by any in richness and effectiveness. A novel feature contained in this pattern resides in the treatment of the fan device, which in this case is a combination of diamonds and thin ribs, elaborate yet distinct in its beauty. The Isabella pattern, rich, gorgeous and mathematically correct in the details of its designs, reminds one of a mosaic of glittering diamonds.

**Connecticut.**

Porter & Dyson, New Britain, are making improvements at their premises.

Reports from Saybrook are that the prospects of having a silver plate factory there are very promising.

The Derby Silver Co. are improving their premises by building a large retaining wall on the riverside.

W. J. Miller, president of the Derby Silver Co., was last week elected president of the Shelton Savings Bank.

The Meriden Silver Plate Co. built a new stock room during the recent shut down, in front of the polishing room.

The Holmes & Edward Co., Bridgeport, have recently increased their force of employes to supply the demand for their goods.

A. S. Ferris, Norwalk, removed his goods from his store last week, and posted a notice on the door to the effect that "all debts contracted by me will be settled by Uncle John."

Wilbur F. Rogers, of C. Rogers & Bros., Meriden, department commander of the Connecticut Grand Army, was one of the prominent guests at the recent reunion of 35th New Jersey regiment, which was held at Asbury Park, and was elected one of the vice-presidents of the regimental organization.

C. D. Warner, general manager of the Standard Electric Time Co., Ansonia, has gone to Hastings, Mich., where he is to put in an electric tower clock and a regular time plant of the Standard system. He will stop at the World's Fair for a few days, where he expects to put in some valuable time among the electrical exhibits.

C. Rogers & Bros., Meriden, are to start a new branch of the flatware business this

Fall, one that will employ between forty and fifty hands. They have recently erected a 50x30 foot brick building on their boundary line and will make their own steel knives, instead of buying as before. The purpose of the firm is to keep the German silver and the steel goods separate. The new building is four stories high, well lighted and ventilated and has all modern factory equipments for the comfort and safety of employes.

**RECEIVER'S SALE.**



ENTIRE Stock of **Giles, Bro. & Co.** Fourth Floor Masonic Temple, consisting of Diamonds, American and Swiss Watches, Jewelry, Silver and Plated Ware, Tools, Materials, etc. will be sold in lots to suit the purchasers, at large reduction from original cost price.

An unusual chance for live Jewelers to obtain bargains.

W. H. GLEASON, Receiver.

July 14th, 1893.



**THE QUESTION ?**  
 WILL IT TARNISH ? Need  
not be asked if your Tissue Paper bears  
 this label.

MANUFACTURED BY

**C. H. Dexter & Sons,**

WINDSOR LOCKS, CONN.

**BE SURE YOU GET THIS BRAND.**

It has been adopted and is now used by the leading manufacturers of this country.



# WOMAN'S IDEAL SOUVENIR SPOON.

A combination of  
The Portrait of  
Mrs. Potter Pal-  
mer, and the  
Nail, Hammer  
And Casket  
Used at the  
Dedication of the  
WOMAN'S  
BUILDING,  
CHICAGO.  
It appeals not  
Only to the  
Women of the  
West,  
But to the  
Patriotic Women  
Of this  
Whole country.

IT IS A BEAUTY.

Teas, Gilt, \$3.00 | Teas, Oxidized, \$2.00  
Coffees, " 2.00 | Coffees, " 1.50

DISCOUNT TO THE TRADE.

**CHAS. OTERO,**  
Grand Opera House, PUEBLO, COLO.

PEARLS.  
**RUD. C. HAHN,**  
194 BROADWAY, NEW YORK.  
GARNETS.

JACOT & SON  
IMPORTERS AND  
MANUFACTURERS  
OF  
MUSICAL BOXES  
298  
BROADWAY  
NEW YORK

## A Very Curious Thing About Two Curious Coins.

(From the New York Sun.)

THE return to the *Recorder* of the plates and drawings of its cartwheel dollar cartoon, and the denial of Assistant Secretary Hamlin that there was any "seizure" except in a Pickwickian sense, show that the officers of the Treasury are not anxious to put themselves into an excessively ridiculous position before the country.

Nevertheless, the law of 1890 stands, and under that law it is a punishable offense for a newspaper, or a magazine, or a book publisher to produce, or have in possession with intent to sell, give away, or in any other manner use the same, "any print or impression, or any other thing whatsoever, whether of metal or its compound, or of any other substance whatsoever, in likeness or similitude as to design, color, or the inscription thereon, of any of the coins of the United States, or of any foreign Government, that have been, or hereafter may be issued as money, either under the authority of the United States, or under the authority of any foreign Government."

We print in the margin a picture of an ancient Bactrian or Scythian coin, probably issued from the mint of King Kadphises II. in the middle of the first century of the Christian era. The piece is about eighteen hundred and forty-three years old, and is not now in general circulation, as far as we are informed. It commends itself to the numismatist with a sense of humor, on account of the humanly hilarious aspect of the figure thereon depicted. It cannot be Kadphises II.; his Majesty's mint would hardly have dared to represent the potentate in his cups. Can it be Diogenes with his lantern looking for a sober Scyth? Or is it the typical rounder and all-night citizen of Bactria or Zariaspa, on his way home after celebrating Christopher Columbus? At all events, the gentleman's gait is a letter of introduction to the nineteenth century; and he would be warmly welcomed and chalked by the Hon. Carter Harrison if he should pirouette into Chicago to-morrow.

Here is another curious coin of which the *Sun* recently published a description. It is the so-called Franklin or Fugio cent, issued from the United States Mint in July, 1787, under authority of an ordinance passed by the Continental Congress in 1786. On the reverse is the legend, "We are One," surrounded by an inner circle and an outer chain of thirteen links. This is said by persons more expert than ourselves in the science of numismatics, to be the first cent



issued by the United States Government. We particularly call attention to the short inscription under the sun-dial.

We print pictures of these two coins because they are so curious and interesting; but curious as they are, the most astonishing thing about them is that in depicting them here the *Sun* renders itself liable to prosecution and punishment under the Act of 1890, "further to prevent counterfeiting." In other words, we produce to sell a print or impression in likeness or similitude to a coin which has been issued under the authority of a foreign Government, and also one in likeness or similitude to a coin of the United States issued under the authority of the United States Government. The language of the statute unquestionably covers our case.

Our esteemed contemporary, the *Herald*, is right in demanding that this fool statute shall be repealed. It is a roaring farce as it stands. We should like to hear from the Hon. James Buchanan of New Jersey in regard to its genesis.

The only possible pretext for enacting such an absurdity of legislation is the principle that it facilitates the prevention of the counterfeiting to arm the detectives of the Treasury with powers broad enough to cover everything, leaving it to their good judgment and common sense to discriminate between innocent acts that technically come under the law and criminal enterprises. The same argument would justify a law to prevent forgery by making it an offence to write upon paper, or any other substance whatsoever, with a pen or pencil, a stylograph or any other implement whatsoever; and trusting to the officers of the law to refrain from prosecuting cases where the technical offence of chirography was manifestly committed without fraudulent intent.

## Old Clocks and New.

THE name of Hiram Camp has its sharp hint of that change in the indigenous and original industry of clock-making which has come upon Connecticut within the limits of a quick half century. Who doesn't remember the old fashioned "tall" clock, which stood ghostlike and sepulchral in the home of almost every farmer? How they got them is a mystery, for they cost a good deal of money in days when dollars had roots and the roots were clinched.

Not much more than a generation back it used to be pretty uncommon to see in Connecticut a clock with brass works, the wooden wheels and weights taking a case of abnormal size. Then came in what might be called the "condensed" Connecticut clock, with striking and time parts, and then the alarm, all gathered in a compass which itself was steadily reduced until hardly greater than two fists. This now is the clock of the common people.

All over the world the clocks go, and circle it with Connecticut chimes, like England's rhetorical drum beat.

**Pittsburgh.**

Henry Barrett and family are stationed at Atlantic City for an indefinite period.

G. L. West and F. D. Hartman, with G. B. Barrett & Co., have returned from Chicago.

Emil Bieler, of Heckel, Bieler & Co., has returned from a business trip to Steubenville, O.

S. F. Roberts will make his regular Summer trip to Long Branch this week, remaining there for two weeks.

The large plate glass window of C. E. Snyder's jewelry store, 3711 Butler St., was broken about 4 o'clock last Tuesday morning. The glass was worth about \$40. Fourteen plated watch chains were in the window and were taken by the person breaking the window.

**Canada and the Provinces.**

W. G. Gordon, Toronto, is offering to compromise at 15 cents on the dollar.

James McLeod, Kentville, N. S., has registered consent for his wife, Almira McLeod, to do business in her own name.

T. Todhunter, Portage, Man., has disposed of his store to J. Pyefinch, who is moving his stock into the quarters, and will continue in the jewelry business.

John Godwin, who keeps a small jewelry store on Queen St. W., Toronto, was found dead in his bed in the rear of his shop on Friday last. The coroner was notified and upon investigation it was thought he

had been dead for several hours. The deceased was last seen alive about 12 o'clock the previous night.

The famous Jaek Clark, known in Montreal, Toronto, the United States and Great Britain, as a successful impersonator of Roman Catholic clergymen, is once more within the walls of St. Vincent de Paul penitentiary, having been sent there from Sherbrooke, where he was found guilty of burglary. Among his victims in past years were many jewelry firms.

**W. F. Doll's Case Against the American Watch Case Co. Dismissed.**

TORONTO, Ont., July 27.—W. K. McNaught, manager and secretary of the American Watch Case Co., appeared before Police Magistrate Denison on Friday last, as defendant in two actions brought by W. F. Doll, formerly of Winnipeg, Man., alleging fraudulent and unlawful dealings on the part of Mr. McNaught. After hearing the plaintiff's side, Magistrate Denison dismissed the case at once without requiring a particle of evidence in rebuttal, and expressed the opinion that the complainant had been actuated by animus.

The facts in the case given by Mr. McNaught to a reporter are as follows:

"Mr. Doll charged that I sold him six 14 karat ladies' gold watch cases and that we sold these cases with the springs in and charged for the steel at the same price as the gold. While this is true, Mr. Doll and every wholesale dealer in the trade knows that it is the invariable custom to sell in this

way. It is called selling by gross instead of net. Our price list especially provides for this.

"Mr. Doll claims that these ladies' watch cases weighed 16 dwts. with 3 dwts. of steel springs, which he was charged for at the same rate as if they were gold, or an extra amount of \$2. Now our price list shows that if the same cases were purchased without the springs \$2 extra would be charged for 'making,' so that the price would be exactly the same. It does not make a cent's worth of difference, no matter how the cases are bought, with or without the springs, and our price list distinctly states this. The next charge was that we sold Doll a gentlemen's screw-back and bezel case known as the Victoria for solid gold, which turned out to be not solid gold. The facts are, as our price list shows, that this case, while it is a gold back and bezel and bow, has a double stock centre, and therefore cannot be termed as a solid gold case, nor was it ever represented by us as a solid gold case.

"It was certainly a strong vindication for us when Mr. Doll's own evidence proved that our goods were as represented. It showed that the 14 karat gold cases sold him were absolutely 14 karat gold. In regard to the Victoria case complained of, Mr. Doll also admitted that the gold was 14 karat."

Winslow & Penney, 608 Masonic Temple, Chicago, report all the business the factory can handle in watch repairing. The demagnetizing department has constantly increased and forms a prominent part of new work.

**A WORD ABOUT OPTICS.**

**D**ID you say you would like to make more money out of your Optical business? How are we to know it if you go on in the old-fashioned "Guess you have fitted them" plan? If you wish to know just how to fit them and do it in a correct and scientific manner, come to us. There is big money in it, and you can increase your business from six to ten times the amount by knowing how to do your work properly. There are more people who need glasses and do not know it than those that are already wearing them. Will you sit idly by and allow this trade to go elsewhere, or will you put yourself in a position to reap the reward? If the former, write to the SPENCER OPTICAL MFG. Co., 15 Maiden Lane, N. Y. City, for their circular, showing you what has been done and what can be done.

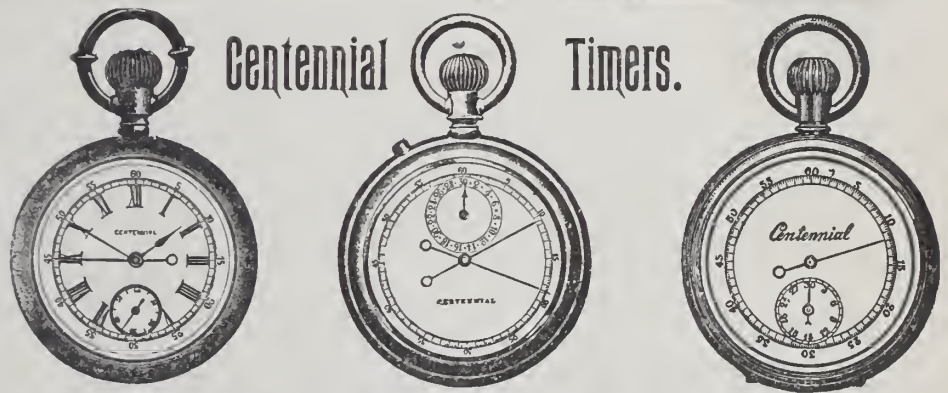

These Watches are one-third larger than above cuts.

**CROSS & BEGUELIN,**  
Manufacturers, Importers and Jobbers of  
Watches, Diamonds, Jewelry, Watch Materials, etc.,  
17 MAIDEN LANE, NEW YORK.

**WATERMAN & LEHMANN,**

MANUFACTURERS OF

**DIAMOND JEWELRY**

AND DEALERS IN

**DIAMONDS,**

No. 37 MAIDEN LANE,

NEW YORK.

### News Gleanings.

O. B. Crook & Co., Edgar, Neb., have sold out.

C. H. Monroe, Searsport, Me., has opened his new store.

J. L. Boyd, Dana, Ill., has given up his jewelry business.

Richard Krumpf, Portland, Ore., has been attached for \$1,000.

D. Ramsey, Denver, Col., has sold his business to a creditor.

A. B. Spencer, Webster City, Ia., has been attached for \$180.

Frank W. Clark, Mohawk, N. J., has given a bill of sale for \$600.

Haberl Bros., Denver, Col., have given a chattel mortgage for \$1,200.

C. C. Gere, Urbana, Ill., has given a real estate mortgage for \$2,000.

F. L. Pond, Keene, N. H., has renewed a chattel mortgage for \$2,948.

Charles L. Miller, Bloomington, Ill., is closing out his business at auction.

Henry Harris & Bro., Buffalo, N. Y., have given a chattel mortgage for \$140.

J. W. Helfrich, Carrollton, O., has given a borrowed money mortgage for \$400.

H. N. Swift, has closed his jewelry store in St. Charles, Ill., and returned to Elgin, Ill.

A judgment for \$2,400 has been entered against George A. Schilling, Oswego, N. Y.

W. B. Wolever, Grand Rapids, Mich., has given three chattel mortgages for \$1,166.

C. E. Hendrickson, Chattanooga, Tenn., has given a deed of trust on real estate for \$563.

The jewelry store of J. P. Slaughter, St. Joseph, Tex., was burglarized some nights ago.

Frank H. Cross, Grand Rapids, Mich., has discharged a chattel mortgage for \$1,800.

A fire at Townsend, Utah, recently destroyed the jewelry store of William Woods.

Richdale & Kncale, repairers for the trade, 206 McCarthy Block, Pueblo, Col., have made an assignment.

W. H. Appel, Allentown, Pa., some days ago moved into the building vacated by Wanamaker & Brown.

The store of J. L. Schweizer, Selma, Ala., was burned out a few days ago. The loss is partially covered by insurance.

H. D. W. English's jewelry store at Arcade, N. Y., was robbed of silverware, a chronometer and tools last Tuesday night.

L. C. Brehm, West Newton, Pa., has recently been appointed watch inspector by the Pittsburgh and Lake Erie Railroad Co.

It is reported that Thomas & Brand, Findlay, O., have started in business again, the receiver's affairs having been closed up.

F. M. Pollen & Co., curio and jewelry dealers, Manitou, Col., have assigned to M. A. Leddy. The assets and liabilities are not given.

Harry Gross, Reading, Pa., has removed from 1314 Spruce St. to N. 9th St., and will move his jewelry store to the latter place from 850 Penn St.

On July 13th, the stock and fixtures of L. A. Hayes, Bolivar, Mo., were assigned to the mortgagees, the Polk County Bank and the Bank of Bolivar.

C. A. Sherman, jeweler, Montevideo, Minn., and Miss Cora B. French, were married some days ago. The bride and groom left for the World's Fair.

The millinery and jewelry store of Mrs. M. E. Sinclair, Ashland, Va., was damaged by fire a few days ago to the extent of \$500; fully covered by insurance.

Burglars broke into George A. Crandall's jewelry store, Holland, N. Y., the other night and carried off most of his silverware, some watches and many of his tools.

John F. Knowlton, brother of Frank A. Knowlton, the well-known jeweler of Worcester, Mass., died at his home in Danielsonville, Conn., a few days ago, aged 42 years.

William Mitchell, Amsterdam, N. Y., has sold his stock of jewelry to a New York house. Mr. Mitchell has been in the jewelry business in Amsterdam twenty-five years.

D. E. Rice's store, 2254 Larimer St., Denver, Col., was burned out a few evenings ago. The fire was caused by the explosion

of a lamp. The damage was \$600, covered by insurance.

A. J. Hughes, who was senior member of Hughes & Farr, Canton, Ill., has sold his interest in the business to his partner and will go to Chicago, where he will study the engraver's art.

The Manhattan Silver Plate Co., Lyons, N. Y., have started up their factory with an increased force and orders sufficient for two months' steady work. The Towar plate factory is also at work again.

The Centralia Jewelry and Music Co., of Centralia, Wis., have incorporated with a capital stock of \$1,500, in single shares of \$60, to deal in jewelry and music. The incorporators are F. Pfeifer, F. P. Daly and L. Daly.

The jewelry stock of T. R. and A. T. Threadgill, Fort Worth, Tex., was attached some days ago to satisfy a claim of John Threadgill for \$819.60. It is thought that the stock will invoice more than enough to pay the claim.

George A. Oppel, Utica, N. Y., has purchased twenty feet front on Main St., and will erect a building four stories high. He will occupy the first floor with his jewelry business and rent the other floors for business offices. The price paid was \$5,590.

G. A. Schlechter, jeweler, Reading, Pa., has issued a souvenir book of Reading which surpasses anything of the kind heretofore published in that city. It contains thirty-nine views of Reading and its surroundings, and is a handsome and valuable little work and sells at twenty-five cents a copy.

Some time ago W. F. Newhall, Lynn, Mass., jeweler, stored some silverware with his brother. The ware was installed in a barrel, and by accident it was placed on the sidewalk with some ash barrels. Mr. Newhall espied a ragpicker fishing the silverware out of the barrel just in time to save it.

A bold daylight robbery was committed in Davenport, Ia., last week. Two young men entered the jewelry store of A. C. Billou and asked to see some watches. One of them after a time picked up a \$30 watch and made a break for the front door. The other ran to the rear door and both made their escape.

**TO WATCHMAKERS.**—We have on hand a number of Chronometers, by various good makers, not new, which have been in service for purposes of navigation, and are excellent instruments. They have been put in perfect repair, and will give satisfactory results as to performance. We will sell these chronometers at low prices, either for cash, or on accommodating terms to suit special cases, or will hire them at moderate rates, and will allow the hire to apply on purchase. Send for Circular giving prices and terms.

Our Watchmakers' Transits are readily set in position. Printed instructions, easily understood, accompany each instrument, and no preliminary calculations are required. With them correct time can be obtained within one second.

**JOHN BLISS & CO.**

Manufacturers of Marine Chronometers,  
128 Front Street, New York.

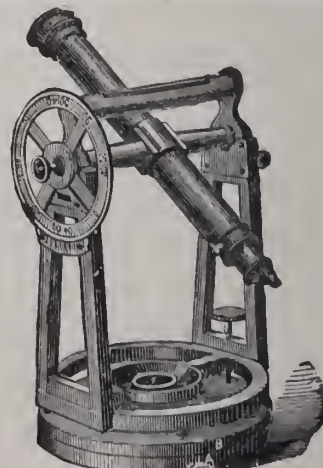
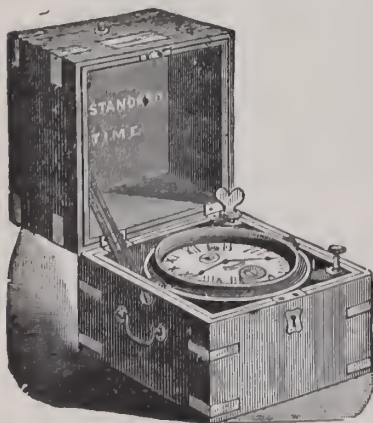

# THE "SANDRINGHAM"

PATENTED JANUARY 24TH, 1893.



ILLUSTRATING the Tea, Dessert and Table Spoons, Dessert and (reverse of) Table Forks.

A complete line of all Fancy Pieces is made in this pattern.



Geo. W. Shiebler Co., Of the Silversmiths' Company, 179 Broadway, N. Y.

# CLASSIFIED INDEX TO ADVERTISEMENTS.

All Advertisements are entitled to one insertion under proper heading. Extra insertions, \$6.00 per annum. Extra Headings, \$12.00 per annum.

Page.		Page.		Page.	
	<b>Aluminum Solder.</b>		<b>Gold and Silver Plating.</b>		<b>Sample Trunks.</b>
	De Redon, C., 79, 81 Leonard St., N. Y..... 17		Brunor Plating and Jewelry Repairing Co., 32 Maiden Lane, N. Y..... 5		Crouch & Fitzgerald, 161 Broadway, N. Y.... 42
	<b>Art Pottery, Bric-a-brac, Etc.</b>		<b>Gold Jewelry.</b>		<b>Settings and Galleries.</b>
	Bing, Ferdinand & Co., 106 Grand St., N. Y.. 44		Bippart & Co., Newark, N. J..... 7		Blancard & Co., 36 John St., N. Y..... 28
	Borgfeldt, Geo. & Co., 18, 20 & 22 Washington Place, New York..... 46		Carter, Sloan & Co., 15 Maiden Lane, N. Y... 41		<b>Silver Plated Ware.</b>
	Bradley & Hubbard Mfg. Co., Meriden, Conn 8		Hook, G. W., Chicago, Ill..... 25		Homan & Co., Cincinnati, O ..... 18
	Gleanzer Leon, J. & Co., 80 & 82 Chambers St., N.Y. .... 47		Krementz & Co., 182 Broadway, N. Y..... 8		Pairpoint Mfg. Co., New Bedford, Mass..... 5
	Haviland & Abbott, 26 Barclay St., N. Y..... 11		Odenheimer, Zimmern & Co., 52 Maiden Lane, N. Y..... 48		Rogers & Bro., 16 Courtlandt St., N. Y..... 3
	Hirrichs & Co., 29 & 31 Park Place, N. Y.... 47		Provenzano, J. N., 39 Union Square, N. Y.... 9		Rogers, Smith & Co., Meriden, Conn..... 30
	<b>Auctioneers.</b>		Racine Jewelry Mfg. Co., Racine, Wis. .... 25		<b>Silversmith.</b>
	Comrie, A. J., P. O. Box 2403, New York..... 39		Smith, C. Sydney, 191 Broadway, N. Y..... 40		Rohrbach, Henry J., 94-96 State St., Chicago, 25
	Firuski, S. & Son, 85 Bowery, N. Y..... 37		Street, Geo. O. & Sons, 15 John St., N. Y..... 17		<b>Sterling Silverware.</b>
	<b>Assayers &amp; Refiners.</b>		Uhry, Chas. L. & Co., Newark, N. J ..... 5		Campbell-Metcalf Silver Co., Providence, R. I. 7
	Clark, J. L., Philadelphia, Pa..... 17		<b>Horological Schools.</b>		Knowles, J. B. & S. M., Co., Silversmiths' Hall, Union Square, N. Y..... 7
	Howard, S. P., 8 John St., N. Y..... 48		Parson's School for Watchmakers, Peoria, Ill. 27		Ovatt & Warner, Portland, Oregon..... 22
	<b>Badges, Medals, Etc.</b>		<b>Hotels.</b>		Reed & Barton, 37 Union Sq., N. Y..... 23
	Irons & Russell, Providence, R. I..... 2		Gibson House, Cincinnati, O..... 27		Shiebler, Geo. W., Co., 179 Broadway, N. Y..17-35
	Schlechter, G. A., Reading, Pa..... 17		<b>Imported Clocks, Bronzes, Etc.</b>		Simons Bros. & Co., Chicago, Ill..... 18
	Stockwell, E. R., 19 John St., N. Y..... 44		Jacques, Chas., Clock Co., 22 Cortlandt St., N. Y. 48		Towle Mfg. Co., Newburyport, Mass. .... 47
	Wilson, Chas. G., Reading, Pa. .... 16		<b>Jewelry Mailing Boxes.</b>		Wallace, R. & Sons Mfg. Co., 3 Park Place, N. Y. .... 6
	<b>Chronometers.</b>		Am. Railway Supply Co., 24 Park Place, N. Y. 10		Wood & Hughes, 10 John St., N. Y..... 7
	Bliss, John & Co., 128 Front St., N. Y..... 34		<b>Jewelry, Silverware and Optical Cases.</b>		<b>Show Cases.</b>
	<b>Chains, Seamless.</b>		Birmingham, Wm. & Co., 728 Arch St., Phila. 17		Smith, B. & W. B., 220 W. 29th St., N. Y..... 48
	Kent & Stanley Co., Providence, R. I..... 4		Jackson, S. C., 180 Broadway..... 44		<b>Souvenir Spoons.</b>
	<b>Clocks.</b>		Troesch, A. & Co., 69 Nassau St., N. Y..... 37		Otero, Chas., Pueblo, Col..... 32
	Evans, W. F. & Sons, Birmingham, Eng. .... 47		Wiggers & Froelick, 60 Nassau St., N. Y..... 40		<b>Tool Manufacturers and Dealers.</b>
	Standard Electric Time Co., New Haven, Conn. 42		<b>Jobbers, Watches, Diamonds, Etc.</b>		Bullock, O. W., Springfield, Mass..... 40
	<b>Diamond Cutters.</b>		Aikin-Lambert Jewelry Co., 19 Maiden Lane.. 2		Chicago Watch Tool Co., Chicago, Ill..... 25
	Humphrey, J. B., Boston, Mass ..... 2		Bowman, Ezra F. & Co., Lancaster, Pa..... 15		Gesswein, F. W., 39 John St., N. Y..... 10
	Mendes, D. De Sola & Co., 51-53 Maiden Lane, N. Y..... 15		Bonnet, Albert H., Columbus, O..... 20		Horological Tool Co., Chicago, Ill..... 27
	<b>Diamond &amp; Precious Stone Importers.</b>		Cross & Beguelin, 17 Maiden Lane, N. Y..... 33		Mosely & Co., Elgin, Ill..... 22
	Bruhl Bros. & Co., 21 Maiden Lane, N. Y..... 48		Giles Bros. & Co., W. H. Gleason, receiver, Chicago, Ill. .... 31		<b>Trunks and Traveling Bags.</b>
	Disselkoe, John N., 19 E. 16th St., N. Y..... 41		Lapp & Flershem, Chicago, Ill..... 24		Crouch & Fitzgerald, 161 Broadway, N. Y.... 42
	Falkenau, Oppenheimer & Co., 40 Maiden Lane, N. Y..... 48		Myers, S. F. & Co., 48 Maiden Lane, N. Y.... 48		<b>Tissue Paper.</b>
	Hedges, Wm. S. & Co., 170 Broadway, N. Y. .... 40		Oppenheimer Bros. & Veith, 35 Maiden Lane. 48		Dexter, C. H., Sons, Windsor Locks, Conn.. 31
	Hahn, Rud. C., 194 Broadway, N. Y..... 32		Yates, John B., Hays Building, Maiden Lane, N. Y..... 12		<b>Umbrellas.</b>
	Juergens & Andersen Co., 125, 127 State St., Chicago..... 20		<b>Musical Boxes.</b>		Wickstead Umbrella Co., 112 Fulton St., N. Y. 17
	Kling, H. M. & Co., 11 John St., N. Y..... 48		Jacot & Son, 298 Broadway, N. Y..... 32		<b>Watch Case Manufacturers.</b>
	Kahn, L. & M. & Co., 10 Maiden Lane, N. Y. 48		Wolff, A., 194 Broadway, N. Y..... 47		Goll, Henry, 17 John St., N. Y..... 28
	Kipling, R. A., 11 Hays Bldg., N. Y..... 40		<b>Optical Goods.</b>		The Wadsworth Watch Case Co., Newport, Ky..... 26
	Ludeke & Power, 23 John St., N. Y. .... 15		Laurent, Jules, 49 Maiden Lane, N. Y. .... 44		The Planchamp & Becker Co., Chicago, Ill... 25
	Nissen, Ludwig & Co., 18 John St., N. Y..... 40		Queen & Co., Philadelphia, Pa..... 2		<b>Watch and Clock Dials.</b>
	Randel, Baremore & Billings, 29 Maiden Lane, N. Y..... 41		Sanborn, J. W. & Co., Boston, Mass..... 40		Waltham Dial Co., Waltham, Mass..... 28
	Smith, Alfred H. & Co., 182 Broadway, N. Y. 40		Spencer Optical Co., 15 Maiden Lane, N. Y... 33		<b>Watchman's Clocks.</b>
	Wolf & Guzburger, 87 Nassau St. N. Y..... 48		The Nous Verrons Co., Boston, Mass..... 47		Hausburg, O. E., 41 Maiden Lane, N. Y..... 37
	<b>Diamond Jewelry.</b>		Zineman, M. & Bro., Philadelphia, Pa..... 2		<b>Watch Importers.</b>
	Bonner, Rich & Co., 41 Maiden Lane, N. Y... 2		<b>Pens, Pencil Cases, Etc.</b>		Abry, Chas. Leo, 41 & 43 Maiden Lane, N. Y. 43
	Waterman & Lehman, 37 Maiden Lane, N. Y. 33		Aikin, Lambert & Co., 19 Maiden Lane, N. Y. 17		Hyde s, J. E., Sons., 22 Maiden Lane, N. Y. .... 17
	<b>Engravers &amp; Designers.</b>		<b>Patents.</b>		Mathey Bros. & Mathez Co., 21 & 23 Maiden Lane, N. Y..... 30
	Bartholomew, W. H., 18 Spruce St., N. Y.... 28		Cox & Sons, 11 Park Row, N. Y. .... 10		Wittnauer, A., 19 Maiden Lane, N. V..... 28
	<b>Eye Glass Holders and Chains.</b>		<b>Rolled Plate Jewelry.</b>		<b>Watch Keys.</b>
	Merritt, S. F., Springfield, Mass..... 44		Dederick, J. H., 16 Maiden Lane, N. Y..... 2		Clark, A. N., Plainville, Conn ..... 17
	<b>Fine Stationery.</b>		<b>Ring Makers.</b>		<b>Watch Repairers.</b>
	Parsons, Green & Co., 18 Murray St., N. Y.... 5		Bowden, J. B. & Co., 192 Broadway, N. Y.... 7		Henry, Peter, Cincinnati, O..... 32
	<b>Fountain Pens.</b>		Bryant, M. B. & Co., 10 Maiden Lane, N. Y.. 2		<b>Watch and Clock Oils.</b>
	The Boston Pen Co., Boston, Mass..... 2		<b>Ring Gauges.</b>		Nye, Wm. F., New Bedford, Mass..... 25



## Special Notices.

Rates 75c. per insertion for notices not exceeding 3 lines (25 words), additional words 2 cents each. If answers are to be forwarded, postage stamps must be enclosed. Two insertions, 15 per cent. off; three insertions, 20 per cent. off; four insertions or more, 25 per cent. off. Payable strictly in advance. Display cards on this page will be charged at \$2.00 per inch for first insertion, subject to same discount as above for subsequent insertions.

Under the heading of **Situations Wanted** on this page advertisements will be inserted for **One Cent a Word**. This offer refers to **Situations Wanted only**. Payable strictly in advance. If answers are to be forwarded, postage must be enclosed.

## Situations Wanted.

*Notices under this heading ONLY are charged at one cent a word, payable strictly in advance. If answer are to be forwarded, postage must be enclosed.*

**POSITION** as salesman, Retail jewelry or silver-ware. Experienced. References. Address, "F," care, JEWELERS' CIRCULAR.

**SITUATION WANTED.**—By a watchmaker and jeweler, single man twenty-seven years of age. Good references. Address, Ed. S., Watchmaker, Dresden, Ohio.

**SITUATION WANTED.**—By a good watch and clock jobber, twenty-two years of age. All French and chiming clocks, hard soldering and plain script engraving. Seven years' experience. Canada or Eastern States preferred. Address, Jewels, Box 90, Bluffton, Ind.

**WANTED**—Permanent position desired as stenographer and typewriter; \$10 per week. Apply to present employers, Sinnock & Sherrill, 21 Maiden Lane.

**SITUATIONS WANTED.**—Position, by reliable young man, as improver. Three years' experience, at watch, clock and jewelry repairing and as salesman. Set of tools, first-class reference. Address, Box 249 Castleton, New York.

**WANTED**—A watchmaker, engraver and salesman, sober, industrious and A1 workman, would like a position with a first-class jewelry firm by Sept. 1st. Address, stating salary, "Business," B care JEWELERS' CIRCULAR.

**YOUNG MAN** would like a position at once in New York or some adjoining State, as watch and fine clock repairer. Address F. C. N., Yonkers, N. Y.

**SITUATION WANTED.**—An experienced traveler wishes a position in a first-class house. Many years on the road and well acquainted in all sections east of Omaha. Diamond house preferred. Address E. D., JEWELERS' CIRCULAR.

**POSITION** Sept. 1st.—By watchmaker, four years' experience at bench. Owns tools, A1 Reference. Address, Box 377, Homer, N. Y.

**BY WATCHMAKER** with seven years' experience. Fair engraver. Wages \$15 per week. Will furnish my own tools, and good reference. None but good houses which can furnish steady position need apply. Address "Staff," care JEWELERS' CIRCULAR.

**ENGRAVER AND SALESMAN.**—First-class man with A1 references desires a situation in a large jewelry store. Good all round workman. New York or Brooklyn, Middle or Eastern States preferred. Address Mizpah, care JEWELERS' CIRCULAR.

**WANTED**—By a young man 22 years of age, a position to represent a manufacturing jeweler or precious stone house in the city or on the road, or position in office. Reference unquestioned. Long experience in the business. H., care of JEWELERS' CIRCULAR.

## Help Wanted.

**WANTED**—Experienced traveling salesman to carry a leading and well-known line of spectacles and eye-glasses; samples easily carried; liberal commission. Address Optics, care JEWELERS' CIRCULAR.

**WANTED**—A Salesman for Jewelers' and Machinists' Tools and Supplies. Must have a good trade following. No attention will be paid to applicants not having above qualifications. Address Salesman, JEWELERS' CIRCULAR, N. Y.

**WANTED**—A practical jeweler and designer to take charge of a factory in an old established business. To a man with some capital an interest in the business will be given. Address, A. J., care JEWELERS' CIRCULAR.

**WANTED.**—Line of A1 goods on commission in this and neighboring territory. Can do good for somebody. L. 927 Western Ave., Topeka, Kan.

**WANTED,** for an old established business in New York city, an optician to take charge of optical department. Must be of good appearance. One speaking German and English preferred. Or would dispose of same to responsible party on easy terms. Address "Optician," care JEWELERS' CIRCULAR.

**WANTED**—An A1 watchmaker and engraver, at once. One that can take charge of a bench. Steady work and good wages to the right man. We don't want any graduate from Watchmakers' Institute. Address A. H. Furstnow & Co., Fond du Lac, Wis.

## For Sale.

**FOR SALE**—Charles Frodsham's Treatise on the Isochronism of the Balance Spring. Sent post paid for fifty cents by D. Stevens, 1313 Columbus Building, Chicago, Ill.

**FOR SALE, PATENT OF COLUMBIAN SOUVENIR MEDAL.** Most appropriate in Design and Inscription. Address, J. A. Yount, LaClede, Mo.

**A GENTLEMAN** advanced in years owning a jewelry, fancy goods and stationery store situated in a city near Boston, is desirous of disposing of the same, which, since its establishment by him in 1847 has done a successful business. An exceptional opportunity for a bright, energetic man, as he would start at once on a paying basis; best location in city; competition light. Address Cyrus N. Gibbs, South Framingham, Mass.

**FOR SALE**—Four horse power steam engine, 32 ft. of shafting, 6 hangers, a lot of pulleys, power or hand rolls for flat or plain rings, draw bench, ring bender, melting furnace with pressure blower and a lot of jewelers' tools. Wm. G. Foehl, No. 6 N. Prince St., Lancaster, Pa.

**FOR SALE**—A first-class jewelry store, established fourteen years, where stock and fixtures costing \$4,500 can be secured for \$2,500, or, if desired, can give lease of store with fixtures and sell stock for \$1,500, one thousand dollars cash and balance on easy terms. Bench work alone amounts to over \$1,800 yearly. The location of the store and profits of the business will stand thorough investigation. Address Frank C. Kibby, No. 366 Broadway, N. Y.

**LAKEWOOD, N. J.**—Farm for sale or exchange for first-class jewelry store or diamonds; a home and productive farm, in splendid order. Principals only address P. O. Box 29, Delhi, Delaware Co., N. Y.

**THE fixtures, safe, benches and all complete for a jewelry store.** A fine opportunity for some one desiring to start in business here. At a bargain, if sold at once. Fixtures still intact in store. Address F. H. Rabe, South Bend, Ind.

## Miscellaneous.

**I BUY JEWELRY STOCKS**—Manufacturers, jobbers and retailers desiring to dispose of surplus or entire stocks of diamonds, watches and jewelry can find quick cash buyer by addressing Stephen S. Harmon, 134 East 96th St., New York city.

## DEMAGNETIZING.

**PERFECT WORK**—Watch repairing in all its branches; all work warranted. Winslow & Penney, 608 Masonic Temple, Chicago.

**FOR FIRST-CLASS INSTRUCTION** in watch work go to W. F. A. Woodcock, Winona, Minn.

**\$1500 WILL** buy stock, safes, fixtures and good will of a well-established jewelry business in a growing town, county seat, of West Texas. No competition. Address E. G. Shorsh, Sweetwater, Texas.

## To Let.

**TO LEASE**—A Game Preserve in the Adirondacks. Plenty of Deer and Trout. Address Chas. Heaton, Jeweler, Potsdam, N. Y.

**Headquarters**  
for  
**ELECTRIC & PORTABLE**  
**Watchman's Clocks**

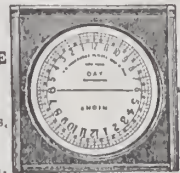

Price,  
Complete  
\$10.00

Lowest Prices.  
Latest Improvements,  
Patents 1886-1893.  
Send for Circular.  
**E. O. HAUSBURG,**  
41 Maiden Lane, New York. **THE "ALERT."**

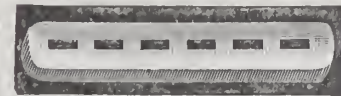

Patent  
applied for

Victoria Novelties, many fancy shapes.  
Celluloid Top, Sides, Bottom and Cushions  
**A. TROESCHER & CO., 69 Nassau St., N. Y.**

## PAWNBROKERS' SALES

BY

**S. FIRUSKI & SON,**

AUCTIONEERS,

85 Bowery, New York,

AT 11 A. M.

**AUG. 3.** Extra choice Diamonds, Watches and Jewelry. By order of D. Abrahams & Sons, 87 Park Row.  
See N. Y. Herald for fuller particulars of sales.

The Trade is Respectfully Solicited to Attend.



**YOU WANT A POSITION  
YOU NEED A SALESMAN  
YOU NEED A WORKMAN  
YOU DESIRE TO EXCHANGE  
YOU WANT A PARTNER  
YOU WISH TO SELL OUT  
YOU HAVE TOOLS TO SELL  
YOU HAVE A PLACE TO LET  
YOU WANT ANYTHING**

USE THE

**SPECIAL NOTICE PAGE**

OF THE

**JEWELERS' CIRCULAR,**

Published Every Wednesday.

To insure Publication of Advertisement in current week, copy should be received not later than Monday Night.

**OLDEST PUBLICATION**

Of all the Jewelry Journals.

**Jewelers' Circular Publishing Co.,**

189 BROADWAY, NEW YORK.

ESTABLISHED 23 YEARS.

John Ohmer has opened a jewelry store in Mishawaka, Ind.

I. M. Enncy has entered a judgment for \$70 against Frank D. Enncy, Syracuse, N. Y.

Sharrick Bros., West Salem and Ashland, O., have bought out A. Mack's jewelry store, Chicago, O.

Louis Bally, Elmira, N. Y., will soon wed Miss Mara A. Stephens, a popular young lady of Towanda, Pa.

Judgments have been entered and executions for \$390 issued against E. Mouilleseaux (agent), Towanda, Pa.

A. D. Vanderberg, an itinerant jewelry man, was arrested last week in Ashland, Wis., for selling goods without a city license. He had a State license but the city officials would not recognize it.

The plate glass window of Eveleigh &

Inman's store, Bloomfield, Ind., was smashed by thieves last week, and a few watches were stolen.

Charles G. Willson, Reading, Pa., has just completed nine handsome badges for the Rainbow Fire Company, which they will present to firemen who showed them many courtesies during their recent southern trip.

Matthew Hollenbeck, whose term of imprisonment has just expired, was taken to Batavia, N. Y., last week, to answer to the charge of breaking into Austin & Prescott's jewelry store. His trial will take place in November.

The almost incredible fact that repeating watches, striking hours and minutes are now within the reach of all, is quickly demonstrated by a glance at the advertising columns of THE CIRCULAR this week. John B. Yates, 21 & 23 Maiden Lane, New York,

having purchased the entire stock of Waltham repeating movements from the American Waltham Watch Co., and cased them in twenty year 14 karat cases, now offers them to the trade at 30 per cent. less than the lowest price at which they have ever been sold to the retailer. It is unnecessary to call attention to the advantages of this rare opportunity, as the jeweler well knows that no such bargain in these movements was ever offered to the trade before, and will no doubt "take the opportunity when it serves," to add to his trade and profit.

A glass case full of clocks and watches in front of G. German's jewelry store, 647 Ocean Ave., Jersey City, N. J., was blown down by a gust of wind Wednesday afternoon. Fifty dollars damage was done to the stock.

## Good Words for "Workshop Notes."

TORONTO, CANADA, JAN. 27, 1893.  
GENTLEMEN: have received copy of "WORKSHOP NOTES" and am well pleased with it.  
Yours truly,  
THEO. W. CAPP.

FARMINGTON, WASH., FEB. 27, 1893.  
GENTS: In looking over the book "WORKSHOP NOTES," when I saw a good thing I would turn down a leaf, and now they are pretty nearly all turned down.  
E. E. PADDOCK.

YARBORO, N. C., FEB. 24, 1893.  
DEAR SIR: "WORKSHOP NOTES" contains valuable helps and ought to be in the hands of every workman of our trade.  
JAS. H. BELL.

BUTTERFIELD, ARK., APR. 10, 1893.

DEAR SIR: I have examined "WORKSHOP NOTES" and find it one of the best works on horology I have ever seen. It should have a place on the bench of every repairer. It is worth three times its cost.  
E. G. STINSEN.

HACKETTSTOWN, N. J., JAN. 11, 1893.  
GENTLEMEN: The book "WORKSHOP NOTES" is well worth reading and preserving. I should say it will be invaluable for reference.  
CHAS. WEBER.

ROSWELL, ALA., AUG. 17, 1892.  
GENTS: I found the "WORKSHOP NOTES" all you claim for it. It is a book every Watchmaker, Repairer and Jeweler should have.  
Yours respectfully,  
HENRY GRAY.

SOUTH BEND, IND., SEPT. 22, 1892.  
GENTLEMEN: We received the "WORKSHOP NOTES" all O. K., and we are much pleased with it. Enclosed find draft for \$2.50. Please credit us with the same and oblige,  
Yours respectfully,  
BUYSSE BROS.

MISSOULA, MONT., JULY 25, 1892.  
GENTS: Your book "WORKSHOP NOTES" has just come to hand; and although I have not as yet examined it to any extent, it seems to be a very valuable work. I find enclosed our check for \$2.50 for the book and the renewal of our subscription to THE CIRCULAR for another year.  
Yours truly,  
A. J. THOMAS.

CHARLOTTETOWN, P. E. ISLAND, SEPT. 23, 1893.  
GENTS: I am very much pleased with "Workshop Notes." It appears to have been compiled not in the spirit of exclusiveness, but in that of trade brotherhood.  
Yours very truly,  
E. W. TAYLOR.

PITTSBURGH, PA., AUG. 3, 1892.  
DEAR SIR: Enclosed find check for \$2.50 for one year's subscription. I am highly pleased with your paper and cannot really see how any jeweler or watchmaker could get along without it. The "WORKSHOP NOTES" has been of much benefit to my workmen.  
Respectfully yours,  
B. E. ARONS.

NORTH ATTLEBORO, MASS., JUNE 25, 1892.  
GENTLEMEN: I received the "WORKSHOP NOTES" and am greatly pleased with it. Accept my hearty thanks for the same.  
Respectfully,  
WM. RITTENMYER.

WARREN, R. I., AUG. 30, 1892.  
GENTLEMEN: received a copy of "WORKSHOP NOTES" all right. Have had time to read it but little, but from what I have seen of it think it an invaluable book to any workman, and well worth twice what you ask for it.  
Yours respectfully,  
A. J. MAHER.

PROVIDENCE, R. I., MAY 31, 1892.  
GENTLEMEN: We received the "WORKSHOP NOTES." Although as yet we have not had the time to read through carefully we are sure, judging from the articles we have read, that it is destined to be of the greatest assistance to Watch Repairers and Jewelers.  
Yours very truly,  
GEORGE H. TAYLOR & CO.

ELMWOOD, NEB., JUNE 23, 1892.  
GENTLEMEN: The book "WORKSHOP NOTES" just received. Have looked it over, and find it contains a very large amount of good reading matter, and it is a book that all workmen ought to have for reference. We are well pleased with the investment. With success to you, we remain,  
Yours very truly,  
A. W. NEIHART & CO.

CHAMBERSBURG, PA., NOV. 7, 1892.  
GENTS AND DEAR SIR: The "WORKSHOP NOTES" received and it has far surpassed my expectations. I have scanned each and every page, and I think it an excellent work. It should be in the hands of every jeweler. It will be found almost as beneficial to the experienced watchmaker as to the beginner.  
Yours respectfully,  
J. L. WEAVER.

YOUNGSTOWN, O., OCT. 31, 1892.  
GENTS: "WORKSHOP NOTES" received and I have carefully examined same, and although I have a great many works pertaining to the trade I find none of them as complete for the trade as your "Workshop Notes," so kindly thanking you for same as premium, I remain, respectfully,  
I. D. HUGGINS.

KINGSTON, ONT., OCT. 30, 1892.  
GENTS: Have received "WORKSHOP NOTES." Am much pleased with it.  
Yours,  
B. POWLEY.

HAZARDVILLE, CONN., NOV. 3, 1892.  
GENTLEMEN: The "WORKSHOP NOTES" received; thanks for same.  
Yours truly,  
C. R. LLOYD.

"WORKSHOP NOTES" is the title of a valuable reference work which has been received with the compliments of the publishers, The Jewelers' Circular Publishing Company, New York. It is a compilation from the columns of the CIRCULAR of the best short articles, practical receipts and hints which appeared in that excellent journal during the last twelve years. It is a book that no progressive watchmaker or jeweler can afford to be without. Neatly printed on first-class paper and bound in the highest style of the art, it reflects great credit on the publishers. Cloth binding, price \$2.50.—*American Jeweler*.

"WORKSHOP NOTES FOR JEWELERS AND WATCHMAKERS" is the apt, though somewhat modest title of a very valuable recipe book just published by the Jewelers' Circular Publishing Co., New York. The volume is systematically compiled, neatly printed and handsomely bound, and is pregnant with information of much practical value to every member of the craft.—*Keystone*.

"WORKSHOP NOTES FOR JEWELERS AND WATCHMAKERS," New York: Jewelers' Circular Publishing Co., 189 Broadway. This book is something out of the ordinary run of things. It is a collection of the latest practical receipts connected with almost every branch of the Watchmaking, Jewelry and kindred trades which have appeared in that excellent publication, the JEWELERS' CIRCULAR. The greater part are original contributions, and many are valuable. The work is roughly divided into two parts, one dealing with horology and the other with the treatment of gold and silver. \* \* \* We have no hesitation in recommending this book to our readers as one of the most useful of its kind that has been brought out.—*Watchmaker, Jeweler and Silversmith, London, Eng., Sept. 1892*.

The Jewelers' Circular Publishing Co. have kindly presented us a copy of their premium book. It is entitled "WORKSHOP NOTES," being a collection of valuable receipts appertaining to the various departments of practical uses for the watchmaker and jeweler. The book itself is elegantly bound, printed on good paper, indexed, and contains about two hundred pages of invaluable information—an accumulation of the many good things published in the CIRCULAR for the past twelve years.—*National Retail Jeweler*.

Before us is a book bearing the title "WORKSHOP NOTES," and which according to its title-page announcement is a collection of practical receipts treating of the manufacture and repairing of watches, clocks and jewelry; including coloring, polishing, annealing, enameling, oxidizing, etc. This is a work which should be in the hands of every jeweler and journeyman in the country. That it is invaluable goes without saying, and we have no hesitancy in recommending its purchase to every one who works at a jeweler's bench. It is issued by the Jewelers' Circular Publishing Company at 189 Broadway, New York City. The price, \$2.50, is merely nominal compared with the fund of valuable information which it contains.—*The Waterbury*.

Price, \$2.50 including a year's subscription to The Jewelers' Circular,  
SENT BY MAIL POSTAGE PREPAID.

The Latest Patents.

ISSUE OF JULY 4, 1893.

**500,659 GEOGRAPHICAL CLOCK.** ARMAND G.

JOURDAN, Paris, France, assignor to himself and Saloman Sylvain Levy, same place.—Filed Jan. 28, 1891. Serial No. 379,395. (No model.) Patented in France May 14, 1890, No. 205,680.

In an astronomical clock the combination of a celestial globe, an ecliptic ring connected to said celestial

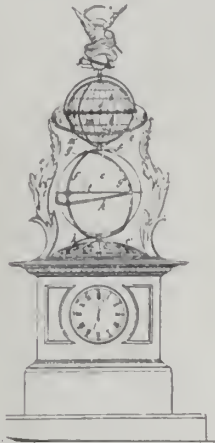

globe, a terrestrial globe, and independent universal dial ring surrounding said terrestrial globe, and an independent movable meridian *m* adapted to be moved around said terrestrial globe.

**500,683. WINDING MECHANISM FOR**

**CLOCKS.** DAVID VOTHIER, Waterbury, Conn.—Filed Mar. 21, 1892. Serial No. 425,818. (No model.)

The combination with the winding arbor of a clock, and a motor for rotating the same, of a ratchet wheel mounted on said arbor and adapted to rotate there,

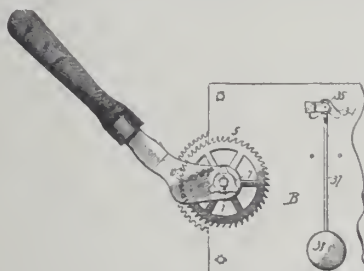

with a lever mounted on the arbor and embracing the ratchet wheel, said lever being adapted to have a lateral movement relatively to the arbor, and a series of pins carried by the lever and engaged to the ratchet wheel.

**500,701. CLOCK STRIKING MECHANISM.**

EPIMACO O. CACCIALUPI, San Severino, Italy, as-

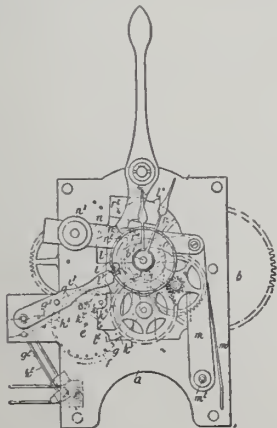

signor of one-half to ALFREDO ANGELI, London, England.—Filed Jan. 4, 1883. Serial No. 457,278. (No model.)

In combination with the clock mechanism an arbor driven thereby, carrying a ratchet wheel, a striking wheel mounted on the arbor carrying a pawl engaging the ratchet wheel, a weighted lever for causing the disengagement of the pawl and ratchet, and means operated by the clock mechanism for causing said pawl to engage the ratchet to strike the hour.

**500 817. WATCH-BOW FASTENER.** LOUIS

PLATNAUER, Clifton, England, assignor, by mesne assignments to the Keystone Watch Case Company of Pennsylvania.—Filed Sept. 13, 1892. Serial No. 445,738. (No model.) Patented in England Nov. 16, 1888, No. 16,626, and in Switzerland Jan. 28, 1889, No. 166.

The combination with the pendant proper of a watch case, of an outer shell adapted to cover the upper portion of the pendant proper, provided with apertures



upon opposite sides, and a bow having its extremities of smaller diameter than the apertures of the outer shell passed through said apertures and fastened upon the interior of the outer shell and exterior to the pendant proper.

**500,835. OPERA, FIELD, MARINE. OR**

**OTHER GLASS.** JAMES AITCHISON and THOMAS BRADLEY, London, England.—Filed Nov. 25, 1891. Serial No. 413,094. (No model.) Patented in England Jan. 20, 1891, No. 1,016.

In opera and other glasses, the combination with extensible barrels carrying object glasses, and eye glasses of a plate adjacent to the object glasses, a plate adja-

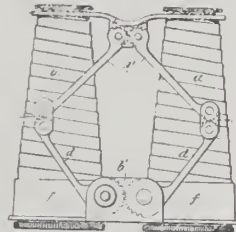

cent to the eye glasses, links, or rods pivoted in said plates, said links or rods provided with gears meshing with each other, and means for locking said bars against movement.

**500,954. JEWEL-SETTING MACHINE.** WIL-

LIAM RUNDQUIST, Elgin, Ill.—Filed Aug. 27, 1892. Serial No. 444,253. (No model.)

In a jewel setting machine, the combination of a jewel feeder, a revoluble carrier provided with a longitudinally slotted tube, and with a series of longitudinally movable spindles carrying a series of implements, a coiled spring arranged in the longitudinally slotted

tube, and fingers attached to said spindles and extend into the longitudinally slotted tube beyond the end of the coiled spring therein.

**500,996. ENVELOPE.** JOHN M. CUTTER, Chi-

cago, Ill., assignor to the Elgin National Watch Company, same place.—Filed Jan. 3, 1893. Serial No. 437,119. (No model.)

As a new article of manufacture, an envelope provided with a supplemental pocket formed and contained



entirely within it, and having its entrance at the entrance to the envelope proper, and adapted to be closed by the closing of the envelope proper.

**DESIGN 22,580. CUP.** WILLIAM A. BROWN, New York, N. Y., assignor to himself, Thomas G.



Brown, and Thomas B. Brown, same place.—Filed Nov. 11, 1892. Serial No. 451,718. Term of patent, 3½ years.

**DESIGN 22,581. GLASS VESSEL.** JAMES J.

O'CONNOR, White Mills, Pa., assignor to C. Dor-

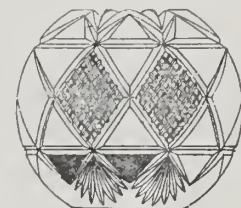

finger & Sons, same place.—Filed Feb. 16, 1893. Serial No. 462,637. Term of patent, 14 years.

The first tear of love that one causes to be shed is a diamond, the second a pearl, the third—a tear.—A. Poincelot.

SPECIAL SALESMAN OF

WATCHES, DIAMONDS,

Bric-a-Brac

and Art Goods

FOR

Established Jewelers.

WRITE FOR PARTICULARS.

Communications Strictly Confidential.

References given in all parts of the United States from Retailers and Jobbers.



**DIAMONDS.**

**Wm. S. Hedges & Co.,**  
**Importers of Diamonds,**

And Manufacturers of DIAMOND JEWELRY.

No. 170 BROADWAY,  
 S. E. Cor. Maiden Lane, } New York.  
 27 Holborn Viaduct, London.



**Alfred H. Smith & Co.,**

IMPORTERS

**DIAMONDS**

AND

PRECIOUS STONES,

182 BROADWAY, COR. JOHN STREET,

NEW YORK.

33 Holborn Viaduct, London, E. C.

**OPTICIANS.**

ONLY house in New England devoted exclusively to Optical Goods for the trade. We carry everything needed by Oculists or Opticians.



PRESCRIPTION  
 ♦ ♦ WORK  
 A Specialty.

**J. W. SANBORN & CO.,**  
 414 WASHINGTON ST., BOSTON.

**R. A. Kipling**  
 Importer of Precious Stones

Nos. 21 & 23 MAIDEN LANE

NEW YORK

19, Rue Drouot  
 Paris

**C. SYDNEY SMITH,**

HAS REMOVED TO 191 BROADWAY,  
 New York.

FACTORY:  
 PROVIDENCE, R. I.

Manufacturer of { **GOLD CHAINS,**  
**LOCKETS AND CHARMS.**

**O.W. BULLOCK & CO.,**  
 SPRINGFIELD, MASS.

Makers of Watch and Jewelry Tools,  
 NEW CATALOGUE NOW READY.

Sent on Application. Please Mention this Paper.

**WIGGERS & FROELICK,**  
 60 NASSAU ST., NEW YORK.

Sample Cases and Trays  
 For Watches, Jewelry, Optical Goods, Etc.

WE STRIVE TO MAKE THE BEST.

**Philadelphia.**

Harry Schimpf, of H. Muhr's Sons, will leave for Chicago this week.

J. B. Harter, of Frankford Ave., has recovered from a prolonged illness.

A jewelry department has been added to Gerson's N. 8th St. establishment.

Charles H. O'Bryon, of Louis A. Scherr & Co., accompanied by his wife has been holidaying at Atlantic City.

Daniel Riggs, Philadelphia's official time-keeper, is with his family at Congress Hall, Cape May, for the Summer.

The body of Henry Staib, 610 Race St., who died very suddenly last Sunday in Hiltown, will be cremated, as was his wish.

Extensive alterations are being made in H. Muhr's Sons' factory at Broad and Race Sts. New elevators are a feature of the improvements.

During the Summer months the Jewelers' Club headquarters are being renovated and refurnished. It is intended that "smokers" will be a feature of the club entertainment during the Fall and Winter.

Several of the property owners on the south side of Chestnut St., between 7th and 8th Sts., "Jewelers' Row," have filed appeals against the small awards of the jury in relation to the widening of the street.

Isaac Garfinkel, 421 S. 5th St., had W. Eugenstein and A. Gross arrested on Thursday for obtaining two gold watches, valued at \$72, from him by false pretenses. Gros visited the store on June 26th and obtained the watches, saying that Eugenstein had purchasers for them. Both parties failed to make good either watches or money. Magistrate McCarty committed them in \$500 bail each for court.

Wm. J. Adams was arrested in Camden on Saturday and committed for a further hearing on suspicion of having stolen jewelry in his possession. He had a large number of valuable rings, which he was endeavoring to sell at ridiculously low prices. The police think the rings are the proceeds of some of the recent store robberies in the city.

On Saturday last a colored man named James Paul went into Charles Loeffler's store, 814 Columbia Ave., and asked to be shown some watches. Mr. Loeffler recognized him as the man who had called at the store on the previous day and having been shown a watch had gone out without buying. He therefore became suspicious and turned round to get his revolver. Immediately the man picked up a watch and dashed from the store. Mr. Loeffler followed and sent a couple of shots after the flying darkey. Neither hit him, but Policeman Hoster captured the thief. He was locked up, the watch was recovered, and the culprit was subsequently committed for trial at court.

The E. Ingraham Company have closed their works for August. The company employ over 500 men and their monthly payroll amounts to \$20,000.

**Fashions in Silver Novelties and Silver-Ware.**

A LADY'S RAMBLES AMONG THE JEWELERS.

Small silver handkerchief holders have reappeared. They have chatelaine pins and pendant clasps for the handkerchief.

Long silver slides have floral ornament applied only on one side; others have the ornament at the ends and slightly extending on opposite sides.

A most convenient article is a spool holder. It looks like a silver tube which it is. The spools are enclosed according to their sizes and the thread emerges through an opening numbered 40, 50, 60, 70, 80, as the case may be.

Small magazine cutters have ivory handles resembling a razor. On these are applied designs in silver, usually floral. Concealed between the two pieces of ivory is the small knife sharp enough to trim a pencil handsomely.

Tennis sets is a term by no means confined to rackets, nets and balls. A tennis set in jewelers' language means a tray, a pitcher, decanters, ice bowl and glasses. This is set on a round table with spiked feet. The table has a second and lower shelf near the base.

Short swords, but long as those carried by the Columbian guards, are used as paper cutters. They have a silver blade over a foot long and not too sharp. They have hilts and guards of perforated silver as large if not as formidable as if they were meant to be weapons of offence.

Baby rattles are shaped like dumb bells. They are covered with raised work. The balls are hollow and inside is the desirable sound to entice the infant ear. Another variety is an oblong shell with a handle. A variation of the bell rattle is a long silver loop with ladder-like crossings from which bells are suspended. Another is a trumpet of silver from which bells are hung.

The smoking table rivals the library table in the beauty and number of its equipments. Just now a number of cigar cutters have made their appearance. They are at least five inches long and handsomely wrought. At each end are the openings for the cigars and the exposed levers are easily worked with the palm so as to clip the ends. Another variety is shaped like a horseshoe with knives meeting in the centre where they form the circular openings of different sizes.

We have not yet exceeded our forefathers in making the girdle a burden bearer. It is recalled that in an old play a merchant hung on his girdle a pouch, a spectacle case, a "puniard," a pen and ink horn, a "handkercher" and many trinkets besides. In another play a lady says to her maid: "Give me my girdle and see that all the furniture be at it; look that scissors, pincers, the penknife, the knife to close letters with, the bodkin, the ear picker and scale be in the case."  
ELSIE BEE.

ESTABLISHED 50 YEARS.

**RANDEL, BAREMORE & BILLINGS,**

IMPORTERS OF

**DIAMONDS,**

AND OTHER PRECIOUS STONES.

**FINE PEARLS A SPECIALTY.**

MANUFACTURERS OF

**DIAMOND JEWELRY,**

IN THE LATEST DESIGNS.

Diamonds Recut in Modern Styles or Repaired on Premises.

58 Nassau Street,  
29 Maiden Lane  
NEW YORK.

1 Tulp Straat,  
AMSTERDAM.

1 St. Andrews St.,  
Holborn Circus,  
LONDON, E. C.



TRADE MARK.

ESTABLISHED 1841.

**CARTER, SLOAN & CO.,**

**MANUFACTURERS OF GOLD JEWELRY,**

No 15 MAIDEN LANE,

NEW YORK.

A. CARTER, JR.  
A. K. SLOAN.  
C. E. HASTINGS.

GEO. R. HOWE.  
WM. T. CARTER.  
WM. T. GOUGH.

FACTORY, NEWARK, N. J.



**JOHN N. DISSELKOEN,**  
Cutter and Importer of  
**DIAMONDS**

FACTORY.  
76 LANGEBLEEKERSPAD,  
AMSTERDAM.

19 East 16th St.,  
NEW YORK.

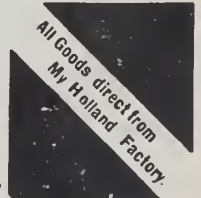

**Chronograph with Hour and Minute Counter.**

GENERALLY speaking, it will happen but rarely that an observation for which a chronograph is used lasts longer than a few minutes; for this reason, the dial division of minute counters hardly ever exceeds 30 minutes. For specially long observations, however, Meylan & Rochat, of St. Imier, Switzerland, have constructed a chronograph, the three hands of which register observations up to twelve hours in length.

Fig. 1 shows the dial; fig. 2 the mechanism underneath the dial, and fig. 3 represents an enlarged cross section of this mechanism. A, fig. 1, is the split second hand, indicating one-fifth seconds, and which makes one revolution per minute; B is the minute counter, which after each revolution of the hand A, springs forward one dividing line to the left; C is the hour hand, which, after every revolution of the hand B, that is, therefore, after each 30 minutes, advances one-half hour. According to this way of counting, the hands in fig. 1 show 1½ hours, 22 minutes, and 0 seconds, that is, length of observation of 1 hour, 52 minutes. The hand A sits upon the seconds hand arbor *a*, fig. 3, which with gentle friction is inserted into the fourth wheel A<sup>1</sup>. This stands in the customary manner in connection with the movement, and makes one revolution per minute. The wheel A<sup>1</sup> is not visible in fig. 2.

Upon the arbor *a* is a heart D, fig. 3, and a finger E, figs. 2 and 3. The latter depths into the teeth of the minute counting wheel F, fig. 2, which, corresponding to the division of the small minute dial, has 30 teeth, and carries the wheel F, one tooth further after every revolution of the hand A. The star spring *f* serves for keeping the minute counting wheel F in place. A heart H and a finger J, figs. 2 and 3, are firmly connected with the minute counting wheel F.

The hour hand C is fastened upon the pipe of a wheel G, which rotates freely around the arbor *a*, fig. 3. This wheel has 24 teeth, and is by a spring *g*, fig. 2, retained in its every incidental position. The heart R connected with G serves for retaining the hand C to zero. The finger J seizes at each revolution of the minute counting wheel F a tooth of the hour wheel G, and thereby per-

mits the hour hand C to spring forward one-half hour.

For stopping and starting the chronograph, as well as for returning the three hands to zero, serve the large drop lever L, fig. 2, which rotates around a shoulder screw *l*, and constantly stands under the pressure of a strong spring L<sup>1</sup>. This drop

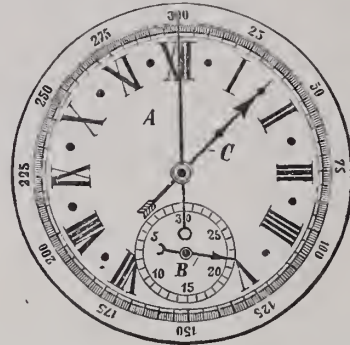

FIG. 1.

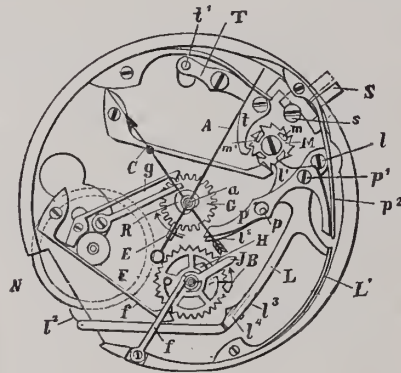

FIG. 2.

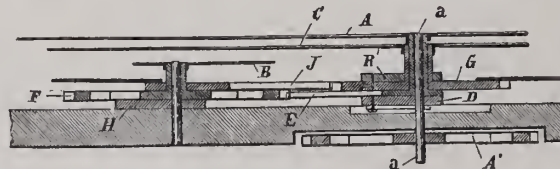

FIG. 3.

lever is furnished at first at its extreme end with a small piece of spiral spring *l*<sup>2</sup>, which is bent over in such a manner that in a position of rest of the drop lever L, it reaches almost to the circumference of the balance. N, without touching this, however. At *l*<sup>3</sup>, the drop lever has a bevel face, which in a given

case seizes under the wheel F and pushes it up, so that both the finger J is out of reach of the wheel G, and the wheel F out of reach of the finger E. When the drop lever L occupies the position shown in fig. 2, the wheel F is by the small spring *f*<sup>1</sup> pressed against the plate, and the fingers J and E can depth into the wheels G or F.

The projection *l*<sup>4</sup> of the drop lever L serves for dropping upon the heart H, when placing at zero; in the same manner the arm *l*<sup>5</sup> serves for dropping upon the heart D, under the wheel G, visible in fig. 3. Upon the drop lever L, revolving around a shoulder screw *p*<sup>1</sup>, is a hammer P, which under the pressure of it, spring *p*<sup>2</sup> strikes upon the heart R, in the snapping down of the drop lever L, and places the hour hand C at zero.

The drop lever L is in the usual manner actuated by a pillar tooth wheel M, which stands under the influence of a pawl *t*. A pipe pushed upon the winding arbor of the watch sits upon the shoulder *t*<sup>1</sup> of the double lever T, and imparts to the latter at each pressure upon the winding button a small turn, at which the pawl *t* advances the pillar tooth wheel M by one of its 12 ratchet teeth. The pillar teeth *m* of this wheel are at *m*<sup>1</sup> furnished with a bevel, upon which the projection *l*<sup>1</sup> of the drop lever L glides down before it drops into a space between two pillar teeth.

In fig. 2 the drop lever L is in a state of locking, because its projection *l*<sup>1</sup> is upon the highest place of a pillar tooth. The arm *l*<sup>5</sup>, the projection *l*<sup>4</sup>, the bevel *l*<sup>3</sup>, and the small spiral spring *l*<sup>2</sup> are out of contact with those parts upon which they have to act, and the three chronograph hands are in motion.

If by a pressure upon the winding button the pillar tooth wheel M is advanced one tooth, the drop lever L drops with the projection *l*<sup>1</sup> upon the bevel *m*<sup>1</sup> of a pillar tooth, whereby the spiral spring *l*<sup>2</sup> applies itself to the circumference of the balance and stops the motion of the watch.

If the wheel M is again turned forward one tooth, the projection *l*<sup>1</sup> of drop lever drops into a space between two pillar teeth. Hereby the small spring *l*<sup>2</sup> lying on the circumference of the balance, is stretched a little more, as it moves in an almost tangential direction to the periphery of the balance. The bevel *l*<sup>3</sup> slides under the count wheel F, and raises it, whereby the two fingers J and E come out of contact with the wheel teeth

**CROUCH & FITZGERALD,**

Jewelry Trunks and Cases.  
161 Broadway  
Bet. Cortlandt and Liberty Sts.,  
688 B'way,  
701 6th Ave.,  
NEW YORK



**JEWELERS, WAKE UP!**

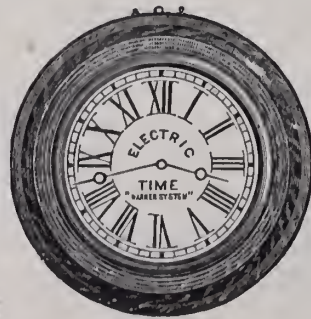

Don't you know there is going to be a *New Tower Clock* in your city, and some one is going to *Make some Money* on it?

Apply to us at once for figures and commissions on our *Electric Tower Clock*, which is the best. *No Winding or Regulating.* Fully warranted.

**THE STANDARD ELECTRIC TIME CO.,**  
739 Chapel St., New Haven, Conn.

of G and F. At the same moment the projection *I*<sup>1</sup> drops upon the heart H, the arm *I*<sup>2</sup> upon the heart D, and the hammer P carried along by *I*<sup>3</sup> upon the heart R, so that the three chronograph hands all return to zero at the same time.

At the next pressure upon the winding button, the pillar tooth wheel M advances again into the position of fig. 2, that is, the projection *I*<sup>1</sup> of the drop lever is raised to the full height of a pillar tooth wheel, the small spring *I*<sup>2</sup> liberates the balance, and the split seconds hand A resumes motion. Since also the bevel *I*<sup>3</sup> has liberated the count wheel F, this is pressed by the spring *I*<sup>4</sup> against the plate, and thereby comes to stand again at the same height with the finger E, and also the finger J stands again within reach of the wheel teeth of G; the two counting hands are hereby also set into motion again.

As it is impossible to keep the watch in the hand during an observation lasting for hours, it might happen easily that by an accidental pressure upon the winding button the hands might be stopped at an untimely period. To prevent this, a small bolt S is located on the movement plates, which is kept firmly by a shoulder screw s, and which can be operated from the outside. If this bolt S is slid in the dotted direction, it applies itself before the pawl *t*, or the interior arm of the double lever F, and thereby prevents any motion of these parts. If the watch is afterward drawn out of the pocket, to ascertain the end of the observation, the bolt S must first be drawn back before the hands are stopped.

If the three chronograph hands are set to the time of day, when the watch is not wanted for an observation, it may be used as a common watch. The only objection might be that the hour hand only advances by jumps from half-hour to half-hour, it would stand at a false angle to the minute hand in the meantime, especially immediately before a jump.

**Gold Solder.**—Proportions for 100 parts: Silver, 54.74; gold, 11.94; copper, 28.17; zinc, 5.81. Melt the first three metals together in a covered crucible; when the cover is slightly cooled add the zinc a little in excess of the proportion given, and stir up the alloy continually. This solder runs easily and is much esteemed by manufacturers.

HOW JEWELERS ADVERTISE.

THE engraving herewith depicts the float of the Derby Silver Co. in the large Fourth of July demonstration in Birmingham, Conn., in which 3,000 people participated. The float served as the 20th anniversary of the company, as may be inferred from the dates on the side. An account of the demonstration and a description of the float were published in THE CIRCULAR of July 12th.

cage bore this legend: "This pretty bird was imported from Switzerland, requires no cleaning, sings day and night."

In the window of S. Silverthau & Sons,

Simons, Bro. & Co., Philadelphia, Pa., are issuing a neat advertising device at their exhibit at the World's Fair, suggesting a tablet and consisting of four leaves the shape of a thimble (one of their principal products) tied together with a silken cord. Two of the leaves forming the covers are tinted in



FLOAT OF THE DERBY SILVER CO. IN A RECENT PARADE.

New Haven, Conn., recently were some live watch chain charms that excited considerable interest. They were chameleons from Florida. The queer pets will stand quite still for more than an hour on a lady's dress or gentleman's vest. They live on flies. In Florida they are frequently worn as charms.

blue and disclose a view of the Manufactures building.

Otto Baehr, jeweler, St. Louis, Mo., seems determined to keep the public attention at all events. Some days ago he had a very peculiar bird caged right in his front door. Every one who passed stopped to admire the bird. A placard on the golden

J. E. Fusleman, Martinsville, Ind., has displayed in his window a watch that has attracted great attention. During a heavy storm in that town April 26th, a man named Rushell was struck by lightning. The lightning struck him on the shoulder, passed down in front to his watch chain, melting it instantly, breaking the crystal of his watch and burning a good sized hole through the heavy silver case. The watch, a Waltham movement, did not even stop running.

VACHERON & CONSTANTIN,  
GENEVA, SWITZERLAND.

FINEST QUALITY OF WATCH MOVEMENTS, FITTING  
ALL SIZES OF AMERICAN CASES.

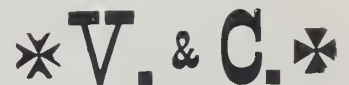

CHAS. LEO ABRY,

Agent for the United States and Canada.

41 and 43 Maiden Lane, - - - NEW YORK.

# FERDINAND BING & Co.,

106 GRAND ST., N. Y.

SPECIALTIES IN IMPORTED CLOCKS,

MARBLE STATUARY AND BRIC-A-BRAC

FOR THE JEWELRY TRADE.

ENAMELED AND TRANSPARENT SPOONS FROM ALL PARTS OF THE WORLD

## OPPENHEIMER BROS. & VEITH, WATCHES AND

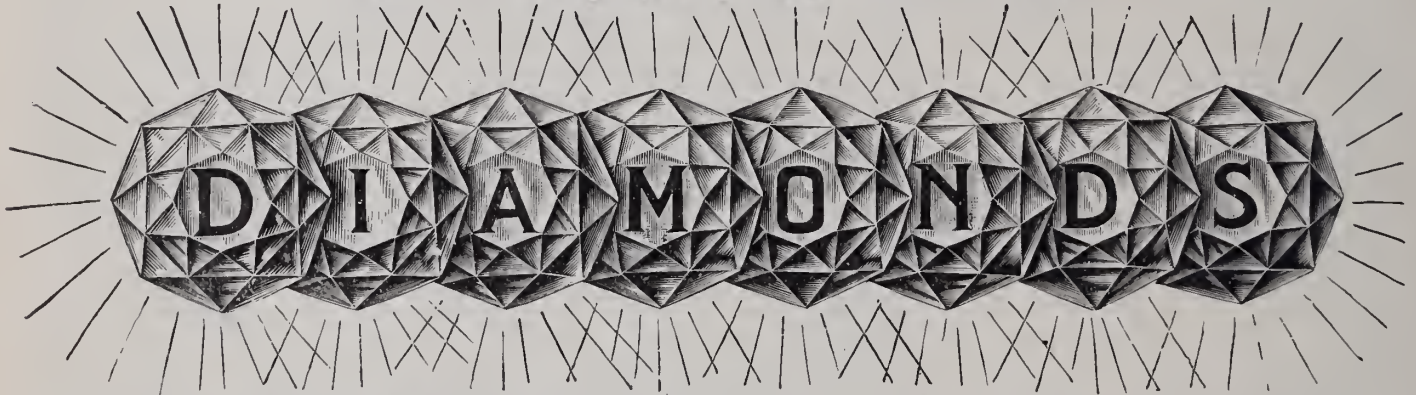

A Large Line of DUEBER Solid Gold Cases. Filled Cases. Silver Cases.  
Our Specialty: HAMPDEN MOVEMENTS, 6, 16 and 18 Sizes.

AMSTERDAM, HOLLAND, 2 TULPSTRAAT. LONDON, ENG., 28 HOLBORN VIADUCT. NEW YORK, 35 MAIDEN LANE.

For BADGES AND MEDALS,

Flag Pins, Class Pins, Class Rings  
and Special Work of all Descriptions.

SEND TO E. R. STOCKWELL, MANUF'R,  
19 John Street, New York



Patented Feb. 9, 1892.

THE W. B. & E.

Marvel Tilting Spring Eyeglass in Gold,  
Steel, and Frameless.

JULES LAURENCOT & CO.,  
49 MAIDEN LANE, NEW YORK.

Sole Agents in the United States and Canada.

## Hair Pin and Eye Glass Chain COMBINED.



This illustrates the Hair Pin and Eye Glass Chain Combined. It is one of the most dressy as well as the most comfortable ways of securing the Eye Glass ever put on the market, and it is justly becoming very popular.

S. F. MERRITT, Manufacturer,

N. Y. Office, 194 Broadway.

SPRINGFIELD, MASS.

S. C. JACKSON, 180 BROADWAY, NEW YORK.  
MANUFACTURER OF

Fine \* Cases \* for \* Jewelry, \* Silverware, \* Etc.

ALSO SHOW CASE TRAYS AND FANCY HARD WOOD WORK.

Samples sent on application. Estimates furnished.





### Ch. Field Haviland Ware at the World's Fair.

WITH the exception, perhaps, of the magnificent table centerpiece illustrated in this department some time ago, the beautiful soup tureen depicted in the illustration herewith, ranks as the main piece of the wonderful "Exhibition" dinner service of the Ch. Field Haviland china, displayed in the pavilion of Haviland & Abbot, at the World's Columbian Exposition in the exhibit of E. Gérard, Dufraissex & Cie., Limoges, France, the makers of this famous china.

The grace and beauty of the outlines of this tureen are well brought out in the engraving. The figure on the top of the cover is that of a woman holding a sheaf of grain. The border shows the panel treatment with shaded colors. Conventionalized flowers form the chief ornamentation.

The decorative effects are an excellent example of the beauty of the furnace heat colors for which the Ch. Field Haviland china is now famous, and marks a long stride in the advancement of ceramic art. A peculiarity of the colors produced by furnace heat is the brilliancy they show under artificial light.

The following quotation from a recent issue of the Chicago *Inter-Ocean* is a just tribute to the artistic and sterling qualities of the Ch. Field Haviland porcelain:

"One of the handsomest table services ever produced in porcelain is to be seen at the World's Fair in a pavilion in the French section of the Manufactures building. It forms part of the exhibit of Messrs. E. Gérard, Dufraissex & Co., of Limoges, France, and is noticeable not only from the beauty of the design and artistic combination of the colors, but even more than this, from the fact that it is decorated throughout with colors produced by furnace heat (au feu de four) at a temperature of 3,000 degrees

Fahrenheit, and in the same kilns as the white ware is baked. The discovery of these new colors by this firm, and the means of practical application, are of greatest importance, and no part of the ceramic exhibit at Jackson Park shows more merit and greater originality than these new underglaze colors. The banquet service referred to contains 210 pieces in all, including a large exquisitely modeled centerpiece, and is valued at \$3,000. The colors are soft and delicate, and by artificial light are richer and more effective even than in daylight. Messrs. E. Gérard, Dufraissex & Co., the manufacturers of this superb service, are

### Royal Wedding Gifts.

ONE of the noblest specimens of the ceramic art ever manufactured is being presented by the Royal Warrant-holders to the royal pair, says the *Pottery Gazette*, and it is safe to assume that none of the multitude of offerings that have been given on the auspicious occasion will in after years assume such a peculiarly intrinsic value as this one. It consists of the noble dessert service of Worcester porcelain made for the Duke of Clarence, afterwards William IV. The service was made at Worcester, but its decoration was undertaken in London

by Messrs. Mortlock, a circumstance which frequently happened in those days. The service is well worthy of the occasion, not only in itself, but also of the eminently historical interest attaching to it. In the year 1812 or thereabouts, the command for its production was given by the Duke to Mortlock; the service having passed through the Fitzclarence family, has again reverted to the descendant of the original decorator, from whom it has been purchased. It has been exhibited lately in London.

The value is now given at 500 guineas, but it would be a matter of difficulty to duplicate it for a much greater sum, and even then



"EXHIBITION" TUREEN, CH. FIELD HAVILAND PORCELAIN.

the successors to Mr. Charles Field Haviland, one of the several manufacturers of that name, and justly famous for the quality and artistic designs of the wares that have borne his name for twenty-five years. The factory was founded in 1797 and is one of the oldest in Europe. Mr. Emile Gérard, senior partner and directing spirit of the factory, is now in Chicago examining the attractions of the White City. He is full of enthusiastic praise for the wonderful buildings and the articles they contain."

An illustration of the pavilion of Haviland & Abbot will be given in a forthcoming number of THE CIRCULAR.

the peculiar method of which the old London painters were masters would be wanting. The service consists of 130 pieces, the edges of each piece being of a "gadron" shape, and the rims of the plates are entirely covered with the most lovely tint of that superb color, "Blue de Roi," on which is the garter motto in letters of gold. The center of each piece has the lion of England over the royal crown, below which are the rose, shamrock and thistle. So that the service may be as complete as possible, the donors of the gift have added to it a set of dessert dishes with a centerpiece in silver gilt.

## The Connoisseur.

(Continued from page 45.)

### The Rambler's Notes.

WHAT THE RAMBLER SAW AND HEARD AMONG THE DEALERS IN ART POTTERY, CUT GLASS, BRONZES, ETC.

**T**O the connoisseur of beautiful china, the ware-rooms of P. H. Leonard, 76 and 78 Reade St., New York, afford an opportunity such as but few places in the country can offer to delight the eye, by the magnificent assortment of artistically decorated Limoges china there displayed. Many hours could be spent in the inspection of the decorated plates alone, whose rococco shapes, soft matted tint, and beautiful floral Cupid and arabesque decorations require the skill of the painter rather than the writer, to vividly portray. The comports and pin trays in *fin de siècle* shapes, the chief feature of which is their wavy effect, cannot fail to arouse the admiration of the most indifferent observer. A most beautiful line to be introduced this September will contain chocolate, tea and coffee pots, tête-à-tête, trinket, after dinner, coffee and sugar and cream sets, together with other specialties handled by jewelers. The soft shades of blue and gold and the exquisite Louis XVI. panels which ornament them will make these goods among the most attractive of the season.

\*

Long necked cologne bottles of Wedg-

wood jasper are among the latest novelties added by Maddock & Co., 21 Barclay St., New York, to their open stock of this ware; together with some small and inexpensive jugs of a new shape. The Etruscan still continues to be the most popular shape in jugs, particularly in the small cream jugs. John J. Miller, of the firm, who has been in England ordering goods for the Fall season, will arrive this week on the *Germanic*. He writes that the new additions to their Wedgwood specialties will be very extensive.

\*

An entirely new English ware is now shown in a line of vases, ewers, jardinières, pitchers, etc., just imported by Lazarus, Rosenfeld & Lehman, 60-62 Murray St., New York. It is called the Empire, and has a cream yellow body trimmed with gold and bronze. The decorations consist of small bright flowers, and in addition most of the pieces are ornamented with open work handles and bands. It is a very attractive though inexpensive ware.

THE RAMBLER.

### "Full," Says the Indicator.

**T**HE optical indicator for lamps, referred to in the following skit from the New York *Sun*, manufactured by Craighead & Kintz Co. and applied to their "Daylight" lamps, can be seen in the office of Craighead & Wilcox, 38 Barclay St., New York:

The newest Yankee notion displayed in the wholesale stores just now is an optical indicator kerosene lamp which displays a disc with the word "full" printed upon it as soon as a servant maid, who attempts to fill it, has poured in enough oil.

This ingenious patent should be adapted to the human body, if possible, and the sooner the better. Bartenders who wish to keep within the law forbidding the sale of liquor to intoxicated persons would then see

the disc rise above a person's collar button, or dangle between his eyes at the precise moment when the man had drunk enough. Guards on the elevated railroads, who are forbidden to furnish transportation to jagg-burdened passengers, would learn to look for the optical indicator, and policemen in making arrests of what they call "d. and d.'s" would no longer stand in fear of contradiction in court next morning if they were able to call the sergeant's attention to the tell-tale disc when the entry of the arrest was made on the blotter. The delegates to the coming silver convention might well be provided with these indicators for the guidance of the platform orators, though the gauge would have to be set at a high level to indicate what a typical pro-silver audience would consider a surfeit of oratory upon its favorite topic.

Indeed, the indicator would need to measure vast amounts in order to become generally useful. At the seaside, for instance, if it can be adapted to semi-solids and even airy substances, there would be a demand for high scaled machines for those young women who cared to determine their capacities for ice cream and the soft speeches of favored young men.

### Cleaning French Clocks.

**I**N cleaning French clocks, a cyanide dip, made by dissolving one-half ounce of cyanide of potash in one quart of water, is very useful. It is obvious, of course, that all repairs must have been made before the dipping is done. After dipping 15 or 20 seconds, the parts so dipped should be well rinsed with warm water, or at any rate, clean water; then dried and brushed with a hard brush and chalk, being careful not to stain in subsequent handling. Vienna lime gives an exquisite polish to French clock plates, but it is next to impossible to get it out of the pivot holes, where it does a power of mischief.

ART NOVELTIES AND BRIG-A-BRAC,  
EXQUISITE  
CLOCKS  
and  
Clock Frames.



SPECIALTIES  
FOR THE JEWELRY TRADE,  
and  
OPERA GLASSES  
and  
Chamois Skins.

# GEO. BORGFELDT & CO.,

18-20-22 WASHINGTON PLACE, COR. GREENE ST., NEW YORK.

# LEON J. GLAENZER & Co.,

80 & 82 CHAMBERS ST., N. Y.

PARIS HOUSE,

35 BOULEVARD DE STRASBOURG



# RICH NOVELTIES

EXCLUSIVELY FOR THE JEWELRY TRADE.

Original and Exclusive Designs in

## CLOCKS,

Onyx, Porcelain, Gilt and Enameled Clock Sets, Gilt Regulators, Traveling Clocks and English Hall Clocks.

GILT AND FILIGREE SILVER-PLATED NOVELTIES AND PHOTOGRAPH FRAMES.



ESTABLISHED 1801.



# HINRICHS & CO.,

29 & 31 PARK PLACE,

Cor. Church Street,

NEW YORK.

## Art Pottery and Bric-a-Brac,

CUT GLASS, FANCY GLASS, CHINA, LAMPS.

THE LARGEST ASSORTMENT OF SPECIALTIES FOR THE JEWELRY TRADE, AT LOWEST PRICES.

# W. F. Evans & Sons

SOHO CLOCK FACTORY,

HANDSWORTH, BIRMINGHAM, ENGLAND.



GRANDFATHER CLOCK

Manufacturers of CHURCH, CHIME & QUARTER CLOCKS,

SCHOOL AND HOUSE CLOCKS

With arch brass dials to chime upon Bells, Gongs, and Harrington's Patent Tubes.

ESTABLISHED 1805.

# J. R. WOOD & SONS,

14 JOHN STREET, NEW YORK.



MANUFACTURER OF



PLAIN SOLID GOLD RINGS. SEAMLESS PLAIN SOLID GOLD RINGS. ENGRAVED AND CHILD'S RINGS.

No Ring Stamped Different from Quality. Send for Catalogue and Price List.

Old Gold and Silver received and estimated on: If amount allowed does not give satisfaction, notify at once and will return at our expense, in same condition as received.

## "Old English"

Coffee Spoon.



Towle Mfg. Co.,

MANUFACTURERS OF

STERLING SILVERWARE.

NEWBURYPORT: No. 214 Merrimack St. CHICAGO: Nos. 149 & 151 State St.



# The Warren Eye Protector

(Patented Jan. 12, 1892, Feb. 21, 1893.)

Saves the Eyes From

Dust, Wind, or Glaring Light.

Folds in a Compact Case, is

Comfortable, Durable, Water and Dust Proof.

Its large field does not obstruct the sight. No brittle substance to endanger face under sudden blows.

Oculists and Physicians Recommend it.

Travelers, Cyclists, Railroadmen, Horsemen, Motormen, Quarrymen, Pronounce it Indispensable for Man or Woman.

Ask your Dealer for it.

Colors, Clear, Smoke, Blue or Green. Black frames, 50c. Silver, 75c. Sent by mail on receipt of price. Manufactured solely by

## The Nours Verrons Company

P. O. Box 3273, Boston, Mass.

FALKENAU, OPPENHEIMER & Co.

DIAMONDS  
40 MAIDEN LANE NEW YORK

WOLFF & GUNZBURGER, Importers of DIAMONDS, (Fulton Building), NEW YORK.

L. & M. KAHN & CO., Importers of DIAMONDS, 172 Broadway, cor. Maiden Lane, N. Y.



AND

W. B. SMITH,

220 WEST TWENTY-NINTH ST., NEW YORK CITY,

— AT THE —

WORLD'S FAIR

CHICAGO,

OUR EXHIBIT IS IN THE

MANUFACTURES AND LIBERAL ARTS BUILDING

SECTION Q, BLOCK ONE.

WHY

S. F. MYERS & CO.  
sell more goods than any  
other Wholesale Jewelry  
House.

BECAUSE

various publications and illustrated

MYERS BUILDINGS, 48 & 50 Maiden Lane, NEW YORK.

They are the only firm in the Metropolis who carry  
in stock a full line of everything a jeweler requires.  
They give the utmost values and endeavor to  
please their trade in every respect. Refer to their  
catalogues.

ESTABLISHED 1848.  
DIAMONDS  
BRUHL BROS. & CO.  
21 Maiden Lane, N. Y., 57 Rue de Chateaudun, Paris.  
PEARLS  
and other Precious Stones.

S. P. HOWARD,  
Gold and Silver Assayer.  
Refiner and Sweep Smelter,  
33 MAIDEN LANE, NEW YORK.  
Smelting and Refining Works,  
28 & 30 Cumberland Street, Brooklyn, N. Y.  
Specialties: Sweepings, Gold, Silver and Platinum.



Chas. Jacques Clock Co.,

22 CORTLANDT STREET, NEW YORK.

Importers and Manufacturers

SWISS REGULATORS, ELLIOTT'S CHIMING  
CLOCKS, FRENCH AND ENGLISH MOVE-  
MENTS, HALL CLOCKS, TRAVELING  
CLOCKS, GILT REGULATORS,  
FAIENCE & GILT CLOCKS & SETS, ETC.

Complete line of English and French  
Clock Materials.

Pinions and Wheels Cut on Premises.



M. H. KLING, \* IMPORTER OF \*  
DIAMONDS,

11 JOHN STREET. NEW YORK.



Gold &  
Diamond  
Jewelry.

ODENHEIMER, ZIMMERN & Co.,

52  
Maiden Lane,  
NEW YORK.



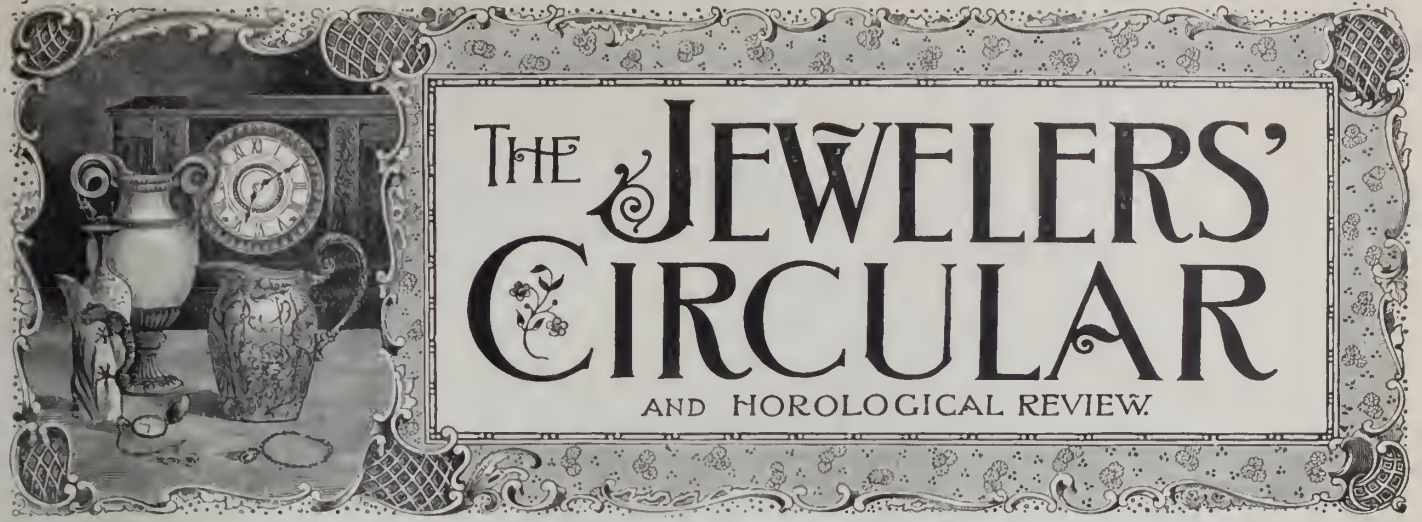

# THE JEWELERS' CIRCULAR

AND HOROLOGICAL REVIEW

Copyright, by THE JEWELERS' CIRCULAR PUB. CO.

189 Broadway, New York.

Entered at the Post Office in N. Y. as second-class matter.

VOL. XXVII.

NEW YORK, WEDNESDAY, AUGUST 9, 1893.

NO. 2

## HISTORY OF JEWELRY IN HAIRDRESSING.

### PART I.

**D**ID the art of decorating the hair with jewels exist in Biblical times? Everything leads us to suppose that it did. It is known that, while Judith was preparing to go to immolate Holopherne for the safety of Israel, she revealed her splendid hairdressing with a gold pin; therefore the women already knew at this epoch the art of head-dressing with grace; and the gold pin which is mentioned in Scripture we find later on at Roma and in Greece. It is with a pin of this nature that she takes from her hair that Flavie, insulting the corpse of Cicero, pierces the tongue of the illustrious orator so as to be avenged for the sarcasms which he had launched against her. It is also a gold pin which the grand dame forces in the side of the unskillful slave charged with the care of her coiffure.

Thus, at all epochs, women have taken

the two sexes—and above all the woman—to encumber the head with diverse objects, and especially with precious articles, the brilliancy of which so agreeably mixes with

that the women of Athens carried in their hair gold pieces, which they suspended to the rings which lay on their foreheads. Nevertheless, the hairdressing of the Grecian ladies of high antiquity, and of the Roman ladies during the first centuries of Roma, was of an extreme simplicity. It consisted in separating the hair by a middle line on the top of the head and letting it fall freely on the shoulders, or it would be made up in detached curls, and permitted to wave and lay about the neck. This manner of hairdressing, charming and primitive, had to give way, however, in the course of time, to coquettish and often absurd hair-dressing styles.

The hair once separated, was ornamented



ANTIQUE COIFFURE.



COIFFURE STYLE OF HENRI III.



ANTIQUE GREEK COIFFURE.

the growth of hair. Savages themselves ornament their heads with feathers, trophies of the chase; with the Esquimo as with the Indian, with the cannibal as with the stupid Zeelander—all their women love to dispose their hair in a manner that will charm, to add a grace relative to their physiognomy. The Araucanian has long hair, flat and greasy, retained by a red ribbon which appears on the forehead as a diadem, and it is to the hair that the chief of the tribe owes the mark of his authority. An eagle feather of the Andes planted on the left side of the head, in the red ribbon which retains his hair, that is the sign of his power.

The young girls of Greece grouped their hair on the forehead, and at the back of the head and enveloped them in a veil, and in this genre of hairdressing they introduced some jewels and diadems. Athénée reports

with bandelettes and some other special needles named *crinales*, destined generally to retain the buckles. These pins, of gold, silver and ivory, often of exquisite workmanship, were in all forms, straight, curved, etc., their length varied according to the

(Continued on page 39.)

care of their hair; and when one treats of the natural dress which nature has given to certain animals, particularly to birds, one simply finds that the desire to please and to distinguish has induced the individuals of

**VICTOR.** ⊗ ⊗  
 SIMPLEST FEED. ALWAYS THE SAME.  
 GUARANTEED FOR ONE YEAR.  
**THE VICTOR**  
**FOUNTAIN PEN**  
 (Pat. Feb. 4, 1890.)  
**THE BOSTON PEN CO.,**  
 N. C. Whitaker & Co., Proprietors.  
 363 Washington Street, - Boston, Mass.,  
 Manufacturers of finest quality  
 TORTOISE : SHELL : AND : HORN : GOODS  
 in every variety Also Aluminum Hair Pins.  
 Send for Illustrated Pen Price List No. 1.

**THE BONNER COMBINATION**  
**RING, SCARF PIN AND STUD.**  
 The Best Combination ever made.  
 MANUFACTURED BY  
**BONNER, RICH & Co.,**  
 Makers of **DIAMOND MOUNTINGS**  
**RINGS A SPECIALTY.**  
 To the Jobbing Trade Only. **41 MAIDEN LANE, NEW YORK.**  
 Factory, 44, 46 and 48 Hill St., Newark, N. J.



**Aikin Lambert Jewelry Co.**  
 Importers of  
**Diamonds**  
 Jobbers in **WATCHES**  
 Jewelry, Chains etc.  
 19 Maiden Lane.  
*New York.*  
 JAMES C. AIKIN, Pres.  
 JOHN B. SHEA, V.-Pres.  
 SAM'L B. MANN, Treas.  
 FRED. D. ILGEN, Sec'y

**A WORD ABOUT OPTICS.**

**D** ID you say you would like to make more money out of your Optical business? How are we to know it if you go on in the old-fashioned "Guess you have fitted them" plan? If you wish to know just how to fit them and do it in a correct and scientific manner, come to us. There is big money in it, and you can increase your business from six to ten times the amount by knowing how to do your work properly. There are more people who need glasses and do not know it than those that are already wearing them. Will you sit idly by and allow this trade to go elsewhere, or will you put yourself in a position to reap the reward? If the former, write to the SPENCER OPTICAL MFG. Co., 15 Maiden Lane, N. Y. City, for their circular, showing you what has been done and what can be done.

**Centennial Timers.**



These Watches are one-third larger than above cuts.  
**CROSS & BEGUELIN,**  
 Manufacturers, Importers and Jobbers of  
 Watches, Diamonds, Jewelry, Watch Materials, etc.,  
 17 MAIDEN LANE, NEW YORK.

For **BADGES AND MEDALS,**  
 Flag Pins, Class Pins, Class Rings  
 and Special Work of all Descriptions,  
 SEND TO **E. R. STOCKWELL,** MANUF'R.  
 19 John Street, New York.

**No File Equals the "GLARDON" File**

is the universal verdict  
 of the trade.



**LARGEST ASSORTMENT IN  
 THE UNITED STATES.**

**F. W. GESSWEIN, 39 John Street, New York.**

SOLE AGENT FOR UNITED STATES AND CANADA.

# Craighead & Wilcox,

NO. 33 BARCLAY STREET, }  
NO. 38 PARK PLACE, }

NEW YORK CITY.



## REPRESENTING

CRAIGHEAD & KINTZ CO., Makers of Lamps and Metal Fancy Goods.

WALTER S. BERG, Maker of Silk Lamp Shades.

HARTFORD SILVER PLATE CO., Makers of Silver Plated Goods.

HACHE, JULLIEN & CO., Vierzon, France, Makers of French China.

---

THE COMPLETE NEW LINES ARE NOW ON EXHIBITION AT OUR SALESROOM.

# “DO YOU KNOW?”

**THAT** GOODS **FREE** FROM **SOLDER** ARE THE **BEST** ?

**THAT** GOODS MADE FROM **SEAMLESS WIRE** ARE **SUPERIOR** IN **FINISH** ON THIS ACCOUNT ?

**THAT** **SEAMLESS WIRE** MAKES THE **BEST** FILLED CHAINS ?

**THAT** WE ARE THE MAKERS OF THE **ORIGINAL** AND CELEBRATED

## Seamless Gold Filled Chains?

Do not fail to visit our beautiful and artistic display at the World's Fair.

The finest of its kind at the Exposition.



Northeast Corner of Manufactures Building, Department O. Right on the corner. See Official Catalogue.

# KENT & STANLEY CO.,

### *Branch Offices:*

NEW YORK, 17 Maiden Lane.

BOSTON, 58 Winter Street.

SAN FRANCISCO,  
Phelan Building.

MONTREAL, Temple Building.

Main Office and Works

PROVIDENCE, R. I.



# THE FAIRPOINT MFG. COMPANY.

NEW BEDFORD, MASS.

GOLD

AND

SILVER

PLATE.



NO. 114.—TETE-A-TETE SET, BURNISHED TOP.

**SALESROOMS :**

NEW YORK,  
20 Maiden Lane.

—o—

CHICAGO,  
224 Wabash Ave.

—o—

SAN FRANCISCO,  
220 Sutter Street.

Our Exhibit at the World's Columbian Exposition may be found in Section N, Manufactures and Liberal Arts Building.



SPECIALTY: SALES OF  
**JEWELRY, BRIC-À-BRAC**  
AND  
ARTICLES OF VERTU

We sell to the legitimate Jewelry and Stationery trade only.



CHOICE PAPERS

MAKERS OF

**FINE STATIONERY**

For Correspondence, Wedding and Business Use, handsomely boxed, specially suited to the Jewelry Trade.

18 MURRAY STREET, NEW YORK.

## Bruner Plating and Jewelry Rep. Co.

Jewelry Matched and Repaired, Engraving, Chasing and Enameling, Setting, Polishing and Lapping, Battery Gilding and Roman Coloring, Watch Cases Repaired, Polished and Gilded.

32 Maiden Lane, New York.

# WORLD'S FAIR SOUVENIRS.

\* STERLING SILVER. \*



THE COLUMBUS.



REVERSE SIDE OF HANDLE.



REVERSE SIDE OF HANDLE.



THE DISCOVERER.



REVERSE SIDE OF HANDLE.



THE AMERICAN.

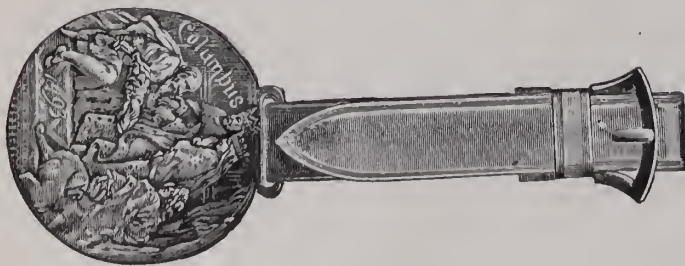

No. 2. BAGGAGE CHECK.



MATCH BOX.

## R. WALLACE & SONS MFG. CO.,

SILVERSMITHS,

WALLINGFORD, CONN.

NEW YORK:  
3 PARK PLACE.

CHICAGO:  
86 WABASH AVENUE.

**George Gardner's Peculiar Business Gets Him into Trouble.**

WORCESTER, Mass., July 30.—George Gardner was arrested last week for selling false diamonds. Gardner is a dealer in diamonds and makes a business of pawning them to brokers for what he can obtain on them. He then goes out on the street and sells the tickets to anybody who will buy. He entered the telegraph office on Pleasant St. this week and wrote a short message, as follows: "Mr. Seley: Please let me have \$12 on this diamond," and signed his name H. Kane, 200 Main St.

He folded the message about a diamond pin, enclosed it in an envelope and sent it to Mr. Seley. Seley, who keeps a pawnbroker's establishment on Front St., examined the stone and pronounced it spurious. Gardner claims that his business is legitimate and as the officers had no case he was released.

**A Toronto Jeweler Found Dead.**

TORONTO, Ont., Aug. 4.—John Godwin, a one armed jeweler of this place, who has been for the past two years conducting a jewelry store at 63½ Queen St., W., was found dead in his bed on Friday last by a neighboring shop keeper, E. B. Guest. Godwin when found had been dead some time and rats with which his place abounded had eaten out his eyes and part of his left hand.

Mr. Godwin was generally known as "one armed George." He is respectably connected, but for years has been addicted to drink. He formerly conducted a jewelry store in Yonge St. His wife secured a bill of separation owing to his dissolute habits.

Since Godwin started business in Queen St. he has been on sprees the greater part of the time. Mr. Guest whose family reside above, has looked after him and endeavored in every way possible to reform him, but without success. Three weeks ago he received a legacy amounting to over \$633.33 from an aunt in England. He deposited \$500 of the money in the bank, but drew it out again in a day or two. Of this sum he expended \$116 in clothing, etc., for his family, and after settling up his rent and some other accounts went on a spree of two days. Later he reported that he had been robbed of \$350 by some companions. What remained speedily dissolved, and a few days ago he pawned by piecemeal his clothing and everything of value in the store. He was last seen alive on the evening of his death about 6 P.M. near his own store.

Coroner Aikins empanelled a jury and at the inquest Dr. Winnett, who made a post-mortem examination of the remains, testified that Godwin's death was due to perforation of the stomach. This was caused by the inordinate quantities of pickles of which deceased had partaken.

Eugene Robitaille, of Robitaille & Lavelle, Lowell, Mass., died on Tuesday last after a short illness.

**BIPPART & CO.**  
 MANUFACTURERS OF  
**DIAMOND JEWELRY**  
 NEWARK, N. J.

BROOCHES, SCARF PINS, HAT PINS, HAIR PINS, EARRINGS, LINK BUTTONS, CUFF PINS, BRACELETS, NECKLACES, RINGS.

NEW YORK OFFICE 19 MAIDEN LANE.

**THE BOWDEN SEAMLESS RING**

IS MADE ONLY BY

**J. B. BOWDEN & Co.,**  
 Makers of Finger Rings of every Description.  
 COR. BROADWAY & JOHN STREET,  
 NEW YORK.

**J. B. & S. M. KNOWLES CO.,**

MAKERS OF

**Sterling**



**Silverware.**

FACTORY,  
 Providence, R. I.

SALESROOM,  
 860 Broadway, N. Y.

**CAMPBELL-METCALF SILVER CO.**



176 Broadway, N. Y., Room 14. 66 Stewart St., Prov., R. I.  
 Mills Bldg., San Francisco, 8th Floor, Room 1.

**WOOD & HUGHES, STERLING SILVERWARE MANUFACTURERS.**

New York Agents for the Derby Silver Co.'s FINE QUADRUPLE PLATED WARE,  
 NO. 16 JOHN STREET, - NEW YORK,  
 206 Kearney St., San Francisco, Cal.  
 HASKELL & MUEGGE, Agents.



**ARTISTIC METAL GOODS.**  
NEW DESIGNS, NEW FINISHES.

Our line of Pitchers, Vases, Tables, Candlesticks, Five O'Clock Teas, Etc., cannot be equaled.

**THE CELEBRATED "B & H" LAMP.**

BEAUTIFUL DESIGNS, particularly adapted to the Jewelry Trade.

SEE OUR LINE OF TABLE, BANQUET AND PIANO LAMPS before placing your orders. Send for our Little Book.



**BRADLEY & HUBBARD MFG. CO.**  
NEW YORK, BOSTON, CHICAGO,  
21 BARCLAY ST., 160 CONGRESS ST. 88 WABASH AVE.  
26 PARK PLACE Factories, MERIDEN, CT.

**"THE BEST BUTTON MADE."**

THE KREMENTZ

IN GOLD

IN ROLLED PLATE

FROM

**KREMENTZ & CO.**

ONE PIECE

FROM

And all Jobbers.



ALL JOBBERS.

**COLLAR BUTTON.**

IS THE ORIGINAL ONE PIECE BUTTON. IS STILL THE BEST AND STILL UNSURPASSED.



**PLAIN SOLID GOLD RINGS.**  
**HILDRETH MFG. CO.,**

53 MAIDEN LANE, NEW YORK.

**The Barbour Silver Co.'s Purchase.**

HARTFORD, Ct., Aug. 7.—In the matter of the sale of the Hartford Silver Plate Co. to the Barbour Silver Co. of this city, it appears that the latter concern has purchased only the stock on hand and the machinery of the Hartford Silver Plate Co. The stock alone will represent an inventory value of about \$225,000 and work on the inventory will hardly be completed for another week.

Secretary Barbour to a CIRCULAR representative said he contemplated no changes at the present time in the methods followed by the Hartford Silver Plate Co. in marketing its wares.

**Idaho's Opal Fields.**

SALT LAKE CITY, Utah, July 31.—There passed through this city last week one of the owners of the Owyhee opal field in Idaho. H. C. Anchor, the gentleman in question, is now on his way to Chicago where he proposes to make an exhibit of some of the finest opals ever found. With him he has about twenty-five beautifully polished stones ranging in weight from one-half to four karats, in addition to about two thousand karats of uncut opals among which are several specimens of the opal in its native formation. It is thought Mr. Anchor's exhibit will surprise eastern jewelers.

The Owyhee mine was discovered only about a year ago, the present owners being H. C. Anchor, T. Shirley, F. Bachman and P. B. Holst. It has been constantly worked and the vein has already been cut in about forty feet. The main vein is about twenty-five feet, cropping out in several places on the forty-acre claim. In one place it runs along the surface for four hundred and fifty feet. This vein is of silicious rock in the crevices and filaments of which we find the opals in clusters.

Mr. Anchor says his stones are better than those of Mexico, Brazil and Australia, and fully equal to those of Hungary in hardness and brilliancy. Their hardness, too, he says, is something unusual, and augurs well for their popularity when they are thrown on the market.

**Connecticut's Silver Mine Shut Down.**

BRISTOL, Conn., Aug. 4.—Perhaps few people outside of New England are aware that we have here a mine yielding copper and silver. It was shut down indefinitely a few days ago and the impression of those who should know is that operations will not be resumed for some time to come. Cashier Edward S. French, of the Pittsfield National Bank, who committed suicide recently by shooting himself through the head, was treasurer of the company.

Manager E. G. Hubbell stated that the mine would begin operations in a short time, and in the meantime the pumps would be kept at work. Why the mine was closed he would not say, although other officials intimate that the present financial stringency is the cause.

**The Derby Silver Co. Will Pay Full Wages.**

DERBY, Ct., Aug. 7.—The office force of the Derby Silver Co. has for the past few weeks been classifying and recording the orders and otherwise preparing for the Fall season. Somewhat to the surprise and most emphatically to the satisfaction of all concerned it appears that the orders on hand at the present time exceed in value those of a year ago by fully twenty per cent. When business was resumed on Aug. 1st, the employees found the following notice posted in the factory.

The business of the country is in a very unsettled condition, but fortunately we have a good supply of orders on hand. Some have had to be taken very close in order to keep our mill running full time. We are about to try the experiment of paying full wages, and not do as many others are, cutting down the wages. We must be encouraged in this and feel that every man in the mill is trying to give us a little extra work, more than usual, to encourage us to keep up the price of wages, so that we may set an example for other manufacturers to maintain a high scale of wages. We believe that our employes will try, if possible, to do more work than they have in the past to encourage the same. If we had any employes who do not join us in trying to carry out this plan by extra faithful services they will be subject to immediate discharge.

To a reporter Watson J. Miller expressed himself as follows:

"We believe the present condition of affairs to be only temporary and wish to be enabled to tide it over without making any reduction of wages, and we think if our employes work with us we can do so. It is a bad thing to reduce wages—bad for

the mill and bad for the place—and if our men will only make our interests theirs we hope to be able to meet the competition caused by the reducing of wages elsewhere and at least hold our own. If our men were put at work by the piece you know they would turn out a little more work to each man, and if they will give us this little more now we will come out all right."

The company's action has been highly commended by both the operatives and townspeople.

**Part of W. D. Simpson's Stolen Goods Recovered.**

ROCK ISLAND, Ill., Aug. 6.—Some good detective work resulted in the arrest in this city on Tuesday last of George Eastman, who robbed W. D. Simpson's jewelry store in Victor, Ia., July 28th. The stolen goods were hidden under a depot platform and were located by officers of the law. The goods were left in their hiding place until yesterday, when they were removed by a stranger and expressed to Eastman at Rock Island. The sender of the package was at once arrested, and Deputy Sheriff Murphy came on here and arrested Eastman when he called for the bundle at the express office.

The death is reported at Nashville, Tenn., of Fred. P. Heathcote, of that city. Mr. Heathcote had been with the B. H. Stief Jewelry Co. for many years.

**More Resolutions From the Business Men's Association.**

GLENS FALLS, N. Y., Aug. 2.—At a meeting of the Business Men's Association of the State of New York held here to-day the following resolutions were passed:

*Whereas:* The Business Men's Association of the State of New York in convention assembled at Glens Falls, this second day of August, 1893, has heard the report of our Secretary, Mr. Newton Dexter, regarding the Association and the Elgin National Watch Co., and

*Whereas:* This correspondence was, notwithstanding the doubts and insinuations made by certain interested persons, carried on by our Secretary, Newton Dexter, and who still retains that position; and Mr. John M. Cutter General Manager of the Elgin National Watch Co., and

*Whereas:* The aforesaid correspondence related to a trade abuse, the nature of which affected the jeweler members of our Association, that forms no inconsiderable part of our organization, and dealt with an evil that was daily increasing in strength; and

*Whereas:* The retail merchant to-day finds the conditions for doing business becoming more and more onerous by reason of these various trade abuses, and especially the illegitimate methods of so many manufacturers who in order to get rid of their over-production seek to open all the channels of trade to the great detriment of the one line merchant. Therefore be it

*Resolved:* That the Business Men's Association of the State of New York desires it to be distinctly understood that Newton Dexter during the aforesaid correspondence was the secretary of this organization, and in view of the invaluable work he has already performed has been unanimously re-elected to the same position.

*Resolved:* That we condemn the action of the Elgin National Watch Co.'s appeal to the Supreme Court of the State in getting an injunction *by default*, against our secretary, refraining him from publishing the correspondence



**★ ROGERS & BRO. A.I.**

**ORIGINAL STAR BRAND GENUINE**

**ELECTRO SILVER PLATE,**

**MADE BY ROGERS & BROTHER WATERBURY, CONN.**

**16 CORTLANDT ST. NEW YORK**

that was of great interest to the jewelry trade of the entire country.

*Resolved:* That it is the unanimous sentiment of this convention, that until the Elgin National Watch Co. release our secretary from that injunction, in order that he may give the aforesaid correspondence to the trade, that no alternative is left us, but to believe as true the charges made, and that the Watch Co. had committed itself in the aforesaid correspondence, else they would not have incorporated in their affidavit to the Court "that the publication of said letters would greatly injure the business of the plaintiff," and further strengthened by the fact that this Watch Co. declined to meet in public debate in the city of Chicago, our secretary.

*Resolved:* That it is the sentiment of this convention that merchants of every branch of business encourage those manufacturers who make the effort to protect the legitimate retail trade.

*Resolved:* That we ask all kindred associations in the United States to give us their assistance, pledging them our earnest and hearty support in assisting them to correct their trade abuses.

*Resolved:* That we are surprised and denounce in unmeasured terms the action of the National Jewelers' Convention, if they were properly represented at Chicago, that lent themselves, perhaps unwillingly so, as a shield to the Elgin Company, and we cannot believe that the sentiment of the 20,000 jewelers of this country was properly voiced by such action.

*Resolved:* That we believe poverty to be no crime, and the gratuitous flings of the Chicago Jewelers' Journal at Mr. Dexter, and the cause he represents, deserves our severest reprobation.

*Resolved:* That while we appreciate the feeling that promoted the members of the Philadelphia Association in moving a donation be given our Secretary, in view of later events, and the action of the President of the National Association, we commend the wisdom of our Secretary in refusing the same.

*Resolved:* That the Treasurer be and is hereby authorized to pay to Mr. Dexter all monies expended by him in carrying on this crusade.

*Resolved:* That the thanks of this convention be and are hereby tendered to the Missouri and Ohio State Jewelers' Association for the courteous, generous and hospitable treatment given our Secretary upon his visit to their conventions.

*Resolved:* We assure Mr. Dexter of our hearty sympathy in his recent crusade against the evils which beset the trade, and will give him every support, morally, financially and otherwise, and we commend him and his energy as well as his untiring efforts against trade



Please take notice that the co-partnership heretofore existing between the undersigned and carried on under the firm name of L. Sauter & Co., has been dissolved by mutual consent.

Mr. Robert Stahl will sign in liquidation.

Dated, New York, Aug. 1st, 1893.

ROBERT STAHL,  
CHARLES R. JUNG.

abuse to the entire jewelry trade and to all State Associations of jewelers throughout the United States.

*Resolved:* That a copy of these resolutions be sent the trade press and all other interested persons.

JOHN P. CASEY, PRES'T,  
Batavia, N. Y.  
NEWTON DEXTER, Sect'y,  
Albany, N. Y.

#### These Thieves were Unsuccessful.

DAVENPORT, Ia., Aug. 5.—The police force of this city has been kept busy for several days by thieves and burglars. Two young men called on A. C. Billon, a Brady Street jeweler, a few days ago, and while being shown some watches one of them slipped a handsome gold timepiece into his pocket. Mr. Billon noticed the movement and at once ran around the counter, but the men rushed out of the door and made good their escape. They were captured later and the watch was recovered. The thieves are Swedes, and gave their names as Ernst Madsen and Oscar Carlson.

A couple of nights after the above event I. M. Ickes' jewelry store was entered and a sackful of jewelry taken. The haul of the burglars included sixteen watches, a diamond stud, rings and pins. One of the burglars, a man giving his name as Elmer Johnson, was subsequently captured, and three gold watches and a diamond ring were found in his possession. His companion, who is supposed to have the rest of the plunder, is still at liberty.

#### The New York Standard Watch Co. Stops Work Indefinitely.

JERSEY CITY, N. J., Aug. 3.—The New York Standard Watch Co., which resumed work on Monday last with 125 hands working on 18 size movements, yesterday posted a notice announcing that work would again cease at six o'clock that evening, and that it was not known when operations would be resumed. The notice ended as follows:

"There is no safe way to conduct this factory as times are now. Hence we must do as others do, and close down to-night until such time as it is possible to guarantee safety and fairness to employes and employers." The works employed 250 men.

None of them were actually discharged, the company announcing that it would resume work "when possible."

At the New York office of the company, 11 John St., a representative of the company stated to a CIRCULAR reporter that he could not tell when the factory would be re-opened. It all depended upon trade condition in the future. While the company had many orders ahead on 16 and 0 size movements, to fill them he said would necessitate running the factory, which would result in the company losing money.

#### Death Removes Edward L. White.

WATERBURY, Conn., Aug. 7.—Edward L. White, secretary of the Waterbury Watch Co., died here on Saturday after an illness of several months. His death was due to endocarditis complicated by inflammatory gout. The funeral will take place to-morrow at 2 P. M., from his late residence on Cliff St. Edward L. White was born December 12, 1853, in Waterbury, being the son of J. Watson White. He spent his boyhood life here, and attended the high school. Then he pursued more advanced studies in Williston seminary, Easthampton, Mass. (class of '69), where he fitted himself for Yale S. S., graduating from the last named institution in 1875. He at once entered the employ of White & Wells of this city as salesman, continuing his connection with this house until he went to Bridgeport, and organized and started the Bridgeport Paper Box Co., about fifteen years ago, this being a branch of the business of White & Wells. On January 1, 1892, Mr. White returned to Waterbury, succeeding E. A. Lecke as the secretary of the Waterbury Watch Co. He proved a valuable man for the company, its affairs having prospered greatly under him.

Five or six years ago he received the nomination for mayor by the republican party in Bridgeport, and in that Democratic city made a most successful canvas, coming within about thirty votes of election.

When Mr. White returned to Waterbury he bought the handsome residence on Cliff street where he died. Here he made his home with his wife, formerly Miss L. V. Ogden, daughter of Judge James L. Ogden, of Jersey City, and three sons. Besides these and his mother he leaves a brother, C. H. White, of White & Wells.

The deceased was a Knight Templar and a member of a Bridgeport lodge of Odd Fellows.

#### The Holmes & Edwards Silver Co. Brings Suit Against the Gorham Manufacturing Co., Alleging Infringement.

BRIDGEPORT, Ct., Aug. 7.—The Holmes & Edwards Silver Co., of this city, has brought suit for heavy damages against the Gorham Manufacturing Co., of New York. The suit is for many thousands of dollars for damages for alleged infringement of the celebrated sterling silver inlaid patents owned by the local company. The patents

are said to be very valuable and cost the Holmes & Edwards Co. a large sum of money.

The right to manufacture spoons and forks under them was purchased of the inventor, William A. Warner, of Syracuse, N. Y., a few years ago. The patents cover the invention of inlaying pieces of solid silver in the back of the bowl and handle of silver plated spoons and forks, thus rendering the points exposed to wear solid silver, which is claimed to give solid silver service to plated ware. The Holmes & Edwards Silver Co. claim they are the only manufacturers of these goods in the United States and own exclusive rights in the matter. Seymour & Knapp, patent lawyers of this city, represent the Holmes & Edwards Co., and are pushing the case in the United States District Court.

**Peter J. Walter Accidentally Kills Himself with a Shot Gun.**

SPRINGFIELD, Mass., Aug. 6.—Peter J. Walter, who has for several years conducted a growing jewelry business on State St., accidentally shot and killed himself in this city today. Mr. Walter was handling the shot gun, a seven shot Winchester, which he supposed was unloaded when the gun exploded, the double B shot striking him in the leg and tearing off the calf so that the bone was exposed. It seems that Mr. Walter went out to the barn to clean the gun, which he had used last week, and in which he had left one shell. He picked up the case but was unable to extract the gun.

In order to get a leverage he held the case between his knees and pulled. There was a report and he fell to the floor, bleeding from a horrible wound. Two of his children who had left the barn a few minutes before returned and called some neighbors, who hastened to the wounded man's assistance. One of them improvised a tourniquet, which partially stopped the flow of blood. An ambulance was called, and after the doctor had bound up the wound Mr. Walter was removed to the hospital, where he died five

hours later without regaining consciousness.

He leaves a widow and three children, the oldest being but six years of age. The deceased was well known and liked in business circles, and was a prominent sportsman, at one time being a member of the Rod and Gun Club.

**The Affairs of Adolph Goldsmith & Son.**

About fifty of the creditors of Adolph Goldsmith & Son met at the rooms of the N. Y. Jewelers' Board of Trade, 41 Maiden Lane, last Wednesday afternoon in response to a call issued by the assignee of the embarrassed firm. David Untermeyer, of the Keller & Untermeyer Mfg. Co., acted as chairman. Mr. Hudson, attorney for Adolph Goldsmith & Son, submitted a statement from that firm and asked the creditors to appoint a committee to thoroughly investigate the books and stock of the insolvents and report upon what offer of settlement could in their opinion be successfully carried out. His clients, he said, had no other plan to suggest. The statement submitted showed the nominal assets to be \$214,087.18, and the liabilities \$184,919.36, leaving a nominal surplus of \$29,167.82. The assets are: Merchandise, \$130,138.74; outstanding accounts, \$50,015.06; bills receivable on collateral, \$7,083.34; bills receivable unsecured, \$20,087.52; cash in banks, \$2,173.95; stock in Jewelers' Building and Loan Association amounting to \$1,911.20; bond of Real Estate Association of Newark, \$1,000; notes held by the National Park Bank for collection, \$477.37 and fixtures worth \$1,200. The liabilities are: Open accounts amounting to \$75,499.39; bills payable, \$103,908.41; accommodation notes, \$2,355.80 and \$1,930.-86, and goods on memorandum, \$1,225.40

Mr. Goldsmith was carefully questioned in regard to what was included in each item of the liabilities and assets. On motion of E. J. Scofield an investigating committee were appointed consisting of F. L. Camm, of the Brooklyn Watch Case Co.; Leopold Stern, of Stern Bros. & Co.; H. S. Dorchester, of Brown & Dorchester, who repre-

sented the Providence Jewelers' Board of Trade, and Samuel Wallach, of Wallach & Schiele.

About thirty creditors were present on Monday afternoon when the committee reported. Secretary Codit, read the minutes of the previous meeting which were unanimously adopted. Leopold Stern reported that the committee started work Thursday morning and that every facility in investigating had been afforded by Mr. Goldsmith and the assignees. The books tallied exactly with the statement read at the last meeting, but the committee's value of the assets differed, as much of the merchandise was old and out of date. All details, Mr. Stern said, had been satisfactorily explained to the committee by Mr. Goldsmith. He concluded by saying that the committee had succeeded in getting Mr. Goldsmith to offer 50 per cent. in settlement, payable in 4, 8, 12 and 16 months from September 16th, but had insisted that the last two payments be secured, and Mr. Goldsmith was now attempting to get that security. The report was accepted with thanks to the committee. After much discussion it was finally decided on motion of Mr. Stern, who said that under existing circumstances he believed that the offer was all that could be expected or asked, that the offer be accepted and the committee empowered to employ counsel to draw up the agreement, but it must be distinctly provide that the endorsement on the last two payments be satisfactory to the creditors and that in case any part of the settlement was not fulfilled the agreement was to be void.

The meeting adjourned subject to the call of the chair.

**American Waltham Watch Co.'s Factory Resumes Work.**

WALTHAM, Mass., Aug. 7.—The American Waltham Watch Co.'s factory started up this morning, and about 1,200 of the 3,000 operatives who were on the pay roll before vacation resumed work. Foreman Hill has set ten more at work than were

**DIRKSEN SILVER FILIGREE CO.,**

MANUFACTURERS OF

**STERLING SILVER SOUVENIR SPOONS.**

**Napkin Rings, Trays, Vases, Card Cases.**



SPECIAL DESIGNS  
AND  
PRESENTATION PIECES  
MADE TO ORDER.

See our Exhibit, Section N, Manufactures and Liberal Arts Building, World's Fair, Near Tiffany's.

Send for our New Catalogue and Price List.

**FREEPORT, ILL.**

originally provided for and two of the other heads of departments are to have additions to their force by the end of the week. Most of the laid-off hands, however, are likely to be out of employment until September.

### Last Week's Arrivals.

*THE CIRCULAR has perfected arrangements for obtaining the names and hotel addresses of all the latest buyers visiting New York, and each day posts in its office, 189 Broadway, a bulletin which every member of the trade is cordially invited to copy.*

The following out-of-town dealers were registered in New York during the past week: B. E. Brown, Rochester, N. Y., Broadway Central H.; H. Cross, Reading, Pa., St. Denis H.; D. F. Maltby, Waterbury, Conn., Broadway Central H.; J. B. Miller, Chicago, Ill., St. Denis H.; E. D. Houghton, Washington, D. C., Astor H.; G. A. Reidpath, Boston, Mass., Imperial H.; M. Davis, San Francisco, Cal., Marlborough H.; J. P. Eisenbach, San Francisco, Cal., Marlborough H.; A. Jones, San Francisco, Cal., Marlborough H.; G. S. Hoyt, Stamford, Conn., New Netherland H.; J. J. Coyne, buyer for Mandel Bros., Chicago, Ill., 55 Franklin St.; C. E. Wigington, buyer of bric-à-brac, etc., for Woodward & Lathrop, Washington, D. C., St.

Denis H.; C. McDonald, Baltimore, Md., Astor H.; J. Parter, Boston, Mass., Astor H.; E. A. Manheimer, Chicago, Ill., Astor H.; J. E. Young, Chicago, Ill., Astor H.; H. Myers, Philadelphia, Pa., Astor H.; J. E. Ladd, Bristol, Conn., Astor H.; James Clancy, buyer for the Pettis Dry Goods Co., Indianapolis, Ind., Metropolitan H.; G. W. Knowlton, Boston, Mass., Astor H.; O. C. Pelton, St. Louis, Mo., Sweeny's H.; W. F. Burrows, Chicago, Ill., Imperial H.; J. S. Davis, Boston, Mass., Astor H.; L. Mendel, Chicago, Ill., Plaza H.; A. H. Homan, Chicago, Ill., Astor H.; E. W. Mitchell, Louisville, Ky., Imperial H.; W. E. Allan, Montreal, Que., Hoffman H.; M. L. Cohn, San Francisco, Cal., Imperial H.; H. L. Coe, Springfield, Mass., Astor H.; E. B. Boggs, Allegheny, Pa., Windsor H.

### Providence.

R. C. Schutz is spending the summer at Riverside, on Narragansett Bay.

Wm. Loeb, of Wm. Loeb & Co., is making a trip through Canada and the west.

Manufacturers in this vicinity are expecting an early visit from William Everetts, of Montreal.

E. J. Ettinger, of Ettinger & Esser, is enjoying a vacation among the mountains of New Hampshire.

Hoffman S. Dorchester, E. L. Spencer, Edwin H. Royce and G. M. Luther made business trips to New York the past week.

John W. Case has returned from an extended trip through the western States and Canada, in the interests of Horace Carpenter.

Ostby & Barton are succeeded by The Ostby & Barton Co., organized under charter granted at the last session of the general assembly with a capital stock of \$750,000. Engelhard C. Ostby is president, Nathan B. Barton, treasurer.

### The Attleboros.

A new firm just started at Attleboro Falls is C. L. Barrows & Co. Their well wishers are many.

A patent on floral jewelry and the method of manufacturing it was issued a few days ago to Regnell, Bigney & Co.

There appears to be but little foundation for the rumors of a general shut down. While several shops have been running on short time and others have been shut down, all are ready to resume operations with full forces as soon as business warrants.

The Campbell-Metcalf Silver Co. have purchased the entire plant and good will of the Narragansett foundry and removed all the tools and appliances used in that business to their factory on Stewart St. The high character of the sterling silver goods made by this house is well known. Mr. Machon, formerly of the Narragansett foundry, is now with the Campbell-Metcalf Silver Co.

# WALTHAM REPEATERS

## Striking Hours and Minutes.

TO THE TRADE:—

Having purchased the entire remaining stock of WALTHAM REPEATING MOVEMENTS from the American Waltham Watch Co., and cased them in 20 year 14k. Cases, I am prepared to sell them at prices 30 per cent. less than they have ever been offered before.

ARTISTIC SPECIAL CATALOGUE FREE.

SEND FOR PRICES AND TERMS.

# JOHN B. YATES,

21-23 Maiden Lane, New York.



# The Jewelers' Circular

AND  
HOROLOGICAL REVIEW.

PUBLISHED EVERY WEDNESDAY BY

THE JEWELERS' CIRCULAR PUB'G CO.,  
189 BROADWAY, NEW YORK CITY.

A JOURNAL DEVOTED TO THE INTERESTS OF JEWELERS, WATCHMAKERS, SILVERSMITHS, ELECTRO-PLATE MANUFACTURERS, AND ALL ENGAGED IN KINDRED BRANCHES OF INDUSTRY

Our Editorial columns will contain our own opinions only, and we shall present in other columns only what we consider of interest or value to our readers. Advertising matter will not be printed as news.

Advertising rates in THE CIRCULAR are lower, considering the number of tradesmen reached by its large circulation, than in any other jewelry journal.

Notices of changes in standing advertisements must be received one week in advance; new matter can be received up to Monday.

### INFORMATION FOR SUBSCRIBERS.

#### Terms of Subscription, Postage Prepaid.

	PER ANNUM
United States and Canada, - - -	\$2.00
Foreign Countries in Postal Union, - - -	4.00
Single Copies, - - - - -	.10

New subscribers can commence at any time. Payments for THE CIRCULAR, when sent by mail, should be made in a Post-Office Money Order, Bank Check or Draft, or an Express Money Order or Registered Letter. All post masters are required to register letters whenever requested to do so.

Pay money only to authorized collectors having proper credentials.

Returning your paper will not enable us to discontinue it, as we cannot find your name on our books unless your address is given.

In changing address always give the old as well as new one. Your name cannot be found on our books unless this is done.

The Courts have decided that all subscribers to journals are responsible until arrearages are paid in full and an order to discontinue has been received by the publisher.

#### Member of the American Trade Press Association.

Vol. XXVII. Aug. 9, 1893. No. 2.

A CANADIAN jeweler was found dead in his shop and the autopsy reveals the fact that death was due to an inordinate fondness on the part of the deceased for green pickles, sharp and sour. The popularity of cold poison as a means of entering into the great unknown is now in serious jeopardy.

WE must beg the indulgence of our readers for the non-appearance in this issue of our regular patent department. The officials in charge of the affairs of the patent office had their own ideas of economy, with the result that since they placed the *Official Patent Gazette* in the hands of its new printers but one number has been issued and that bearing date a month old.

PERHAPS no congress in recent years has had the attention of the business world in a greater degree than the extraordinary session which convened at Washington on Monday last. Both silver and anti-silver men appear to be totally at sea as to the outcome of the coming deliberations, but in the opinion of those in a position to judge correctly of such matters, the struggle between the opposing factions will be bitter and lengthy.

THE experiment of the Derby Silver Company in paying its employees full wages during the present business depression and looking to them for a partial equivalent in the conscientious employment of their time, is one which will be watched with interest by not only the plated ware shops, but every other factory in its section.

**What's in a Name?** IT was Avon's bard who pounded the query and it is not in our province to enter into any lengthy discussion with reference thereto. Suffice it to say that the fair name of Skowhegan, situated in the State made famous by Neal Dow, has been wantonly assailed. The poet of the *Toledo Blade*, speeding headlong to destruction, has rushed into print with a poem in which he holds up to public ridicule that person whom he designates as the "Loo Loo" from Skowhegan. No other town would serve his fell purpose. What mattered it to him that there existed a Snohomish, an Oshkosh, or a Sheboygan, the latter even yet to some people only a creation of the humorists, or the comic journals. No! he singles out Skowhegan and lets fly his envenomed shaft. On his own head be the consequences. The CIRCULAR's correspondent at Chicago, whose comprehensive weekly pen pictures of the great Exposition have endeared him to our readers, has already taken up the cudgel in defense of his outraged birthplace. Let none assail the sullied name of Maine's fairest town.

THE traveling salesmen few men have a better knowledge of business conditions throughout the country at large. The finger of the traveler is constantly on the pulse of trade. He knows of his own knowledge and the report of his brethren which sections are buying, what the trade demands and what is selling. His suggestions often yield the employer a rich harvest in some specialty which his traveler's acumen suggested. While the fraternity have been written about time and again and a drummer's yarn is even to-day synonymous with a "fish story" to many people, yet, take them as a whole, there is no more generous hearted, kindly or liberal body of men than those who travel about the country seeking ever to supply their patrons with what is latest in the mart of trade and incidentally to make new converts for their "houses." Years ago the popular idea of the traveling salesman, when through his day's labors, was a poker playing, harum-scarum disturber of the peace, but those who know him better, and in that category may be placed the reading public, see him now enjoying a quiet game of billiards, an interesting book or a social hand at whist. These recreations, however, always preceded by his daily letter and a glance over the field for the following day.

**The Men Who Place the Goods.** THAN the traveling salesmen few men have a better knowledge of business conditions throughout the country at large. The finger of the traveler is constantly on the pulse of trade. He knows of his own knowledge and the report of his brethren which sections are buying, what the trade demands and what is selling. His suggestions often yield the employer a rich harvest in some specialty which his traveler's acumen suggested. While the fraternity have been written about time and again and a drummer's yarn is even to-day synonymous with a "fish story" to many people, yet, take them as a whole, there is no more generous hearted, kindly or liberal body of men than those who travel about the country seeking ever to supply their patrons with what is latest in the mart of trade and incidentally to make new converts for their "houses." Years ago the popular idea of the traveling salesman, when through his day's labors, was a poker playing, harum-scarum disturber of the peace, but those who know him better, and in that category may be placed the reading public, see him now enjoying a quiet game of billiards, an interesting book or a social hand at whist. These recreations, however, always preceded by his daily letter and a glance over the field for the following day.

THE traveling salesmen few men have a better knowledge of business conditions throughout the country at large. The finger of the traveler is constantly on the pulse of trade. He knows of his own knowledge and the report of his brethren which sections are buying, what the trade demands and what is selling. His suggestions often yield the employer a rich harvest in some specialty which his traveler's acumen suggested. While the fraternity have been written about time and again and a drummer's yarn is even to-day synonymous with a "fish story" to many people, yet, take them as a whole, there is no more generous hearted, kindly or liberal body of men than those who travel about the country seeking ever to supply their patrons with what is latest in the mart of trade and incidentally to make new converts for their "houses." Years ago the popular idea of the traveling salesman, when through his day's labors, was a poker playing, harum-scarum disturber of the peace, but those who know him better, and in that category may be placed the reading public, see him now enjoying a quiet game of billiards, an interesting book or a social hand at whist. These recreations, however, always preceded by his daily letter and a glance over the field for the following day.

### The Week in Brief.

Peter J. Walter, Springfield, Mass., accidentally kills himself while cleaning a loaded shotgun—The death is reported of Edward L. White, Secretary of the Waterbury Watch Co.—Burglars rob L. Manasse in Chicago of goods valued at about \$1,500—Frank P. Blair is appointed receiver for the Dulaney Clock Co. at Chicago—George Gardner's peculiar business gets him into the hands of the police—A Toronto jeweler is found dead and from the autopsy it would appear that his decease was due to an inordinate fondness for pickles—Some further particulars about the sale of the Hartford Silver Plate Co., to the Barbour Silver Co.—News from Idaho's Opal fields—Connecticut's only silver mine shut down—Adolph Goldsmith & Son, present a statement to their creditors—H. B. Nemitz comes back to Chicago and threatens to sue his accusers for \$25,000—The Derby Silver Co. will continue to pay its employes full wages despite the depression—The New York Standard Watch Co. stops work indefinitely—The affairs of Morse, Mitchell & Williams, Chicago, Ill.—The Business Men's Association passes more resolutions—Silversmiths issue a circular reducing prices because of the decline in silver—The Holmes and Edwards Silver Co. brings suit against the Gorham Mfg. Co., alleging infringement of their inlaid patents—Part of the goods stolen from W. D. Simpson, Victor, Ia., are recovered—The American Waltham Watch Co.'s factory resumes operation.

#### The Silversmiths' Co. reduce prices on Flat Ware.

Another reduction in the price of solid silver flat ware was announced Monday, when the members of the Silversmiths' Co. in this city, namely, The Gorham Mfg. Co., The Whiting Mfg. Co., The Geo. W. Shiebler Co. and Dominick & Haff sent out notices to that effect.

Many of the prominent silver manufacturers visited by a CIRCULAR reporter had only just received the notice, and to some the action was unexpected. All, however, stated that they would also follow in reducing the price of the same lines of goods.

The Whiting Mfg. Co. vouchsafed no further information than was obtained in the circular of the Silversmiths Co.

Mr. Holbrook, of the Gorham Mfg. Co., said that the action was taken solely to meet the fall in the price of bullion. No other representative of any of the firms in the Silversmiths Co. could be induced to talk.

C. E. Mather is showing in his window at 21 Maiden Lane, N. Y. the blue diamonds which for two years past he has been selecting, cutting and setting in ornaments for James B. Brady, or "Diamond Jim," as he is better known on account of his craze for these jewels, which always adorn him.

### New York Notes.

Justin Wertheimer returns from Europe to-day on the *Spree*.

J. S. Charig has entered a judgment for \$175.42 against B. C. Ryder.

S. E. Fisher & Co. have obtained a judgment for \$102.51 against Moritz Moos.

W. R. Alling has entered a judgment for \$524.10 against E. E. Kipling and Charles Seale.

The Manhattan Jewelry Company has entered a judgment against Joseph Kopald for \$128.17.

P. H. Leonard, 76 Reade St., has applied for membership to the New York Jewelers' Board of Trade.

Alois Kohn & Co. have obtained a judgment for \$149.51 against Harris Boskey, as endorser on a note.

O. G. Fessenden, of Hayden W. Wheeler & Co., is spending a vacation in the Catskills, at Patenville, N. Y.

J. A. Brown has obtained a judgment for \$1,018.17 against Edw. F. Sandford and William T. Coombs.

E. Levy, with Sam. Stern & Co., left Tuesday on a two weeks' trip through New York State and vicinity.

Martin D. Levi, of M. D. Levi & Co., accompanied by his family, has been spending several weeks at the World's Fair.

Among the departures for Europe last week were Morris Block on the *Friesland*, Joseph Metcalf and Alex. Jensen on the *Teutonic*.

The business of Isidor Elbe, 41-43 Maiden Lane, will be sold at auction by Ullmann & Co. on August 10th. The sale will include the entire stock, fixtures and office lease.

C. H. Jacot, of Jacot & Son, the musical box importers, has been spending a few weeks at his factory in St. Croix, Switzerland. He will return about August 20th.

M. D. Rothschild returned Monday from a week's fishing trip in the Thousand Islands and brought with him some handsome trophies of his skill.

Samuel Avery, who has been connected with the New York office of the American Waltham Watch Co. for over twenty-two years, severed his connection with that company August 1st.

Elias Rees, 51 Maiden Lane, has formed a copartnership with Theodore Yankauer, formerly a salesman for Henry Tissot. Rees & Yankauer will continue the business at the same address.

The following judgments have been obtained against Michael, Charles J. and G. Louis Fox. One for \$2,716.65 in favor of P. Bessinger, and one for \$2,334.38 in favor of the German-American Bank.

The customs authorities were last week notified that a large amount of diamonds had been smuggled in the country by two passengers on the *H. H. Meyer* from Germany. The officials do not place much credence in the story.

Mrs. Waite T. Fellows died in New Haven Monday, aged 101. Her husband was for many years a member of the jewelry firm of Fellows, Read & Co.

Judge Bookstaver, of the Court of Common Pleas, has signed an order in the matter of the assignment of Henry Abbott & Co., extending the time for the assignors to file their schedules until August 14th.

The following judgments were entered Saturday against Fredrick J. Kaldenberg: By the Western National Bank for \$1,340.74 and \$1,181.51; by the Nassau Bank for \$3,744.62, and by Martin's Bank, (lim.), for \$2,558.87.

James William Todd, New Rochelle, N. Y., who died August 1st, at Monticello, Sullivan County, where he had gone for his health, was at one time a well known member of the jewelry trade in this city.

H. H. Heinrich, at 14 John St., recently received an order for a \$300 chronometer from a firm styling itself H. F. Jansons & Co., of Amsterdam, Holland. Mr. Heinrich found that the firm had a peculiar reputation and did not fill the order for the chronometer.

W. C. Garrison, the assignee of Henry Abbott & Co., has been ill for the past week and was therefore unable to conduct his work on this statement and schedules. Mr. Abbott stated to a CIRCULAR reporter that his creditors had been seen individually and negotiations for a settlement were now pending.

The store of Wolf Glass at 57 Canal St. was closed last week on executions amounting to about \$800 in favor of Abraham Gussow and Stern Bros. & Co. In an attachment issued against him Wednesday it is alleged that he had removed property from the State and secreted it with intent to defraud creditors.

A fire broke out early Wednesday morning on the ground floor of the building, 411 Broadway. Martin D. Levi & Co., manufacturers of jewelry and importers of fancy goods, who occupy the second floor, suffered slight damage by smoke and water. The loss, which is estimated at \$200, is fully covered by insurance.

The New York Jewelers' Board of Trade is circulating the subscription list for the annual contribution of the jewelry trade, toward the "Floating Hospital and Seaside Hospital Fund" of St. Johns Guild, for the prompt relief of the sick babies and mothers of New York city. Subscriptions may be left at the rooms of the board, 41 Maiden Lane, where the list is on file. A large number of firms in the lane and vicinity have already contributed toward this philanthropic work.

Theodore H. Shultz, assignee of M. Fox & Co., has obtained an order from Judge Bookstaver, of the Court of Common Pleas, granting him an extension of twenty days from August 4th in which to file his inventory and schedules. In his application he asked for sixty days, and says he believes that long before the expiration of said extension,

the inventory and schedules will be filed, a settlement effected with the creditors, and an application made to discharge him as assignee.

At the regular monthly meeting of the Executive Committee of the Jewelers' League, held on Friday, August 4, 1893, there were twelve requests for change of beneficiary granted and the following applicants for membership were accepted: Joseph Cowan, Boston, Mass., recommended by Henry Cowan and Wm. Bradford; George S. Hemingway, New York city, recommended by Frank E. Knight and L. H. Wilcox; Clinton A. Lindsey, Johnstown, Pa., recommended by Jacob H. Young; Robert M. Sheain, Philadelphia, Pa., recommended by Frank H. Hewitt and G. W. Shuler; Haverly B. Swart, New York city, recommended by W. B. Durand and LeRoy C. Fairchild; James S. Beatty, New York city, recommended by E. F. Skinner.

Berthold Zelleman, a passenger on the *Elbe*, which arrived here August 1st, was arrested last week by Customs Inspector Sherman on the charge of smuggling jewelry. His trunk and basket were taken to the seizure room and the inspector found five gold watches, three ladies' watches and ninety-seven finger rings on the person of Mr. Zelleman. In the trunk there were nine gold watches, forty silver watches, two nickel watches, twenty-seven plated chains, twelve steel chains, seven silver chains, five bracelets, forty-three scarfpins, forty-two watch-case rings, thirty-four finger rings, four breast-pins, fourteen studs, forty-three pairs earrings, six clocks, three bottles wine, one hundred cigars and five bracelets. In the basket were one lot of jewelry tools, six diamond drills, five crosses, eleven breast-pins, nine pairs earrings, three chains, two studs and a number of chain rings.

A sad accident occurred near the Hundred Island House at Lake George Thursday, in which were lost the lives of nine people, among whom was Miss Bertha Benedict, nineteen years old, of Montclair, N. J., daughter of E. P. Benedict, of Benedict Bros., the well-known jewelers of this city. She was a passenger on the steam yacht *Rachael*, with a number of others, bound for the Hundred Island House. When within a few rods of her destination the boat ran into a sunken pier and sank at once. Among the passengers were: Mr. and Mrs. E. P. Benedict, their son, Harding Benedict, and their daughter, Miss Bertha Benedict. When the crash came Mr. Benedict, with much difficulty, succeeded in saving his wife, while Harding Benedict, who is an expert swimmer, started to save his sister. He succeeded in bringing her to the surface and would have undoubtedly brought her to the shore, but for an accident which rendered him helpless. It was only through the efforts of others that he himself was saved. Miss Benedict's body was among the first recovered, and was brought to Montclair on Saturday last. The funeral services were held Tuesday morning at the Benedict residence, 33 N. Fullerton Ave.

HAVE REMOVED  
TO  
BROADWAY & 18TH STREET.

TWO BLOCKS ABOVE FORMER  
LOCATION.

# Solid Silver

Exclusively.



# WHITING M'F'G CO.

SILVERSMITHS,

Broadway & 18th Street,

NEW YORK.

WORKS--AT FOURTH ST. AND LAFAYETTE PLACE.



## Our Traveling Representatives

Traveling representatives may consider these columns open for the publication of any news or items of interest regarding themselves or their conferees.

**I**N Minneapolis many of the salesmen started on their first Fall trips last week. Among those already out are: Charles Prout, of S. H. Clausin & Co.; Joseph Aicher, of Spaulding & Aicher; Wm. H. Creveling, of the Reed & de Mars Jewelry Manufacturing Co. The rest will follow shortly.

C. A. Deane has severed his connection with the house of Robbins & Appleton.

J. F. Burgess, representing John Scheidig & Co., called on Cincinnati dealers last week.

J. E. Reagan, of Baldwin, Miller & Co., Indianapolis, Ind., made a business trip into Illinois last week.

H. J. Rolfe has started on an extended business trip for the Wilcox Silver Plate Company, Meriden, Ct.

Jno. Gardner, salesman for Nichols, Pee & Co., Indianapolis, Ind., is enjoying himself at the World's Fair.

Jas. Haslem, Cincinnati, O., started on the road last week with an outfit of new designs in fountain pens.

North Walcott, formerly with Wright, Kay & Co., Detroit, Mich., is now in the employ of F. G. Smith Sons & Co., of that city.

F. B. Mathauer, the representative of Kennedy & Koester, Detroit, Mich., left here last week on a trip through Ohio and Southern Michigan.

Traveling men in St. Louis last week were: W. T. Gough, of Carter, Sloan & Co., Mr. Burgess, of Scheidig & Co., and John Nathan, of Rothschild & Co.

Chas. Powers, of New York, and Ralph Booth, manager of the New Jersey Lamp & Bronze Co. made the rounds of the Philadelphia trade last week.

S. E. Coggins, representative in Connecticut, Pennsylvania, New Jersey and Maryland for the Towle Mfg. Co., visited the Chicago office the past week.

## HENRY GOLL & CO.,

17 JOHN ST., NEW YORK.

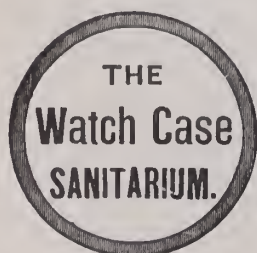

SPECIAL CASES  
MADE TO  
ORDER  
AND  
REPAIRING IN  
ALL ITS  
BRANCHES.

Indianapolis jewelers were visited last week by Gustav Otto, of Boroo & Otto Carlsbad, Austria, and Mr. Hamilton, of Hamilton & Hamilton, Jr., Providence, R. I.

Charles H. Hoff, for ten years a traveling salesman for C. Rogers & Bros. in New York, New Jersey and Canada, has resigned, and will in future travel for the Westfield Plate Co., of Thompsonville.

Among the traveling men in Springfield, Mass., last week were: Mr. Dunnel of Ripley, Howland & Co.; Mr. Torbit, of Rogers & Bros. and Mr. Coddling, of Coddling Bros. & Heilborn.

Nat. Wolf and Norbert Gunzburger have started on a trip through the west and southwest. Messrs. Wolf and Ganzberger compose the new firm of diamond importers in the Fulton Building at Fulton and Nassau Sts., New York city.

Traveling men in Boston during the week included: W. Metcalf, Plainville Stock Co.; E. A. Woodmancy, Potter & Buffinton; Mr. Mowry, Kirby, Mowry & Co.; W. R. Cattle, Henry E. Oppenheimer & Co.; H. B. Beach, Wilcox Plate Co.; Charles A. Gallagher, Sinnock & Sherrill.

C. A. Barnum, who has traveled for the Meriden Britannia Co. for fifteen years, is taking in Wisconsin cities on a preliminary trip. Jas. A. McHenry leaves on the 15th for the west, Ed. T. Powers on the same date for the central west, and Mr. Wood starts for the northwest the present week.

Among the buyers in Boston during the past week were: E. F. Staples, Stockton Springs, Me.; W. H. Graham, who is about to open a new store in Marlboro, Mass.; A. R. Vaughan, Pawtucket; William A. England, Worcester; Wallace Kimball, of L. Kimball & Son, Haverhill; J. B. Williamson, Camden, Me.; T. R. Cushing, Rockland, Mass.; G. H. Whittemore, Milford, Mass.

Eastern jobbers and manufacturers represented in the Twin Cities during the past week were: Osborn & Co., of Lancaster, Pa., by H. Osborn; Mr. Stevenson, Lapp & Flerhem, of Chicago, Ill., by Edward E. Spaulding; F. M. Sprochnie & Co., Chicago, by F. Wilman; S. & B. Lederer, of New York, by G. Roedenberg, and Goldsmith Brothers, Chicago, by I. Speyer.

The following traveling salesmen passed through Detroit last week. All reported

business quiet. S. C. Potter, Acme Silver Plate Co.; H. A. Bliss, Krementz & Co.; Mr. Gregory, Seth Thomas Clock Co.; C. F. Ketchum, Riker Bros.; Robert Wilcox, Rogers, Smith & Co.; Mark Franklin, Kauffman & Co.; F. J. Foster, Unger Bros.; Mr. Kaiser, Enos, Richardson & Co.; A. Kiersky, Kraus, Kragel & Kiersky; Henry Freund, Max Freund & Co., and H. A. Tibbals, C. E. Luther & Co.

The marriage is announced of Edward Gardner Lewis, Bridgeport, Conn., a traveling salesman for the Waterbury Watch Co., and Mabel G. Wellington, of London. There is a tinge of romance connected with the marriage. The young couple met for the first time four years ago, while Mr. Lewis was traveling in the south. It was a case of love at first sight, but the lady's aunt, who was her guardian, would not consent to the proposed marriage. A few months ago Mrs. Wellington and her ward decided upon a trip through the south. Mr. Gardner found that his business also demanded a trip south, and when the aunt died leaving the young lady without a protector, the marriage followed at once.

### Detroit.

M. S. Smith and family last week went to Petusky, Mich., for several weeks' outing.

• Buttonley Bros., of Capae, Mich., will shortly start a bazar and jewelry store at that place.

Hermann John, with Eugene Darniel, is in Chicago on business and to attend the World's Fair.

E. J. Hyde, a former Detroit jeweler, but now of Spokane Falls, Wash., spent last week with friends in this city.

Lipsett & Harrison, Ewe, Mich., recently lost \$8,000 in a fire that burned out the center of the town.

Eugene Darniel, Albert Schaub and Henry Koester returned last week from a fishing trip to St. Clair Flats. Mr. Darniel caught the monster black bass of the season.

The handsome model of the side-wheel steamer *Portland*, of the New York and Fall River line, recently raffled off by Kennedy & Koester, was won by Robert Wilcox, of Rogers, Smith & Co.

Fred. A. Butters, the popular foreman in the manufacturing department of R. J. F. Roehm & Son, last week married Miss Hartwig, of Bridgetown, Ont. The honeymoon was spent in Chicago and the west.

F. G. Smiths' Sons & Co. have been given the contract for manufacturing thirty-eight diamond badges for the winners in the regatta to be held here Aug. 9th and 10th by the National Association of Amateur Oarsmen.

Trade with the jobbers continues quiet. The following Michigan buyers were here last week: S. H. Hammond, Nani; C. W. Masher, Hally; Sam Friedman, Osseo; A. W. Kludt, Lennox; William Walthers, Wyandotte; J. S. McGlaucklen, Jr., Wyandotte and William Amber, Northville.

ESTABLISHED 1837.

## TAYLOR & BROTHER,

OLD HOUSE READ, TAYLOR & CO.

IMPORTERS OF

✱ DIAMONDS ✱

AND OTHER PRECIOUS STONES.

MANUFACTURERS OF

## DIAMOND JEWELRY.

860 BROADWAY,

Cor. 17th Street,

NEW YORK.

# WATERMAN & LEHMANN,

MANUFACTURERS OF

## DIAMOND JEWELRY

AND DEALERS IN

## DIAMONDS,

No. 37 MAIDEN LANE,

NEW YORK

A DAINTY FALL NOVELTY.

### SOUVENIR : PLAQUES

IN SILVER PLATE,

With Artistic Photographs or Views, in Colors, on Pearl Backgrounds.

Can be Used as a Tray or Hung up by Loop on Back.

Make a Very Handsome Appearance.

List of Views and Photos on Application.

Price, \$12 per Dozen. Finest Work.

Special designs to order. Send photo. Photographing on Spoons, Watches, Window Transparencies, Celluloid Photographs, &c.

G. A. SCHLECHTER, MFG. JEWELER  
READING, PA. Agents Wanted.

ONE-QUARTER SIZE.



# AIKIN, LAMBERT & CO.

19 Maiden Lane, NEW YORK.

Branch, 42 & 44 East Madison St, CHICAGO, ILL.

Manufacturers and Exporters of

Gold Pens, Holders, Picks, Pencils, Fountain Pens, etc.

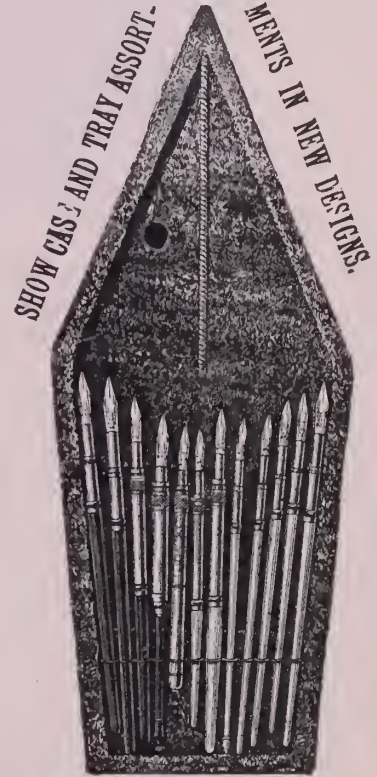

11 x 5 1/2 inches.

PLUSH TRAY WITH EASEL BACK.

1 Doz. 16 K. Pens and Assorted Holders, List, \$30

1 Doz. 10 K. Pens and Assorted Holders, List, \$24

Send for Trade Discount.

## OUR CUSTOMERS

in the Jewelry and kindred trades will now find us comfortably installed at 112 Fulton St., where we are showing as fine an assortment of canes and umbrellas as can be found in the market.

REPAIRING AND COVERING AT SHORT NOTICE.

### WICKSTEAD UMBRELLA CO.,

112 Fulton Street, Cor. Dutch,

NEW YORK.

LARGE AND VARIED ASSORTMENT OF HIGH CLASS

### SILVER • NOVELTIES.

Transparent, Inlaid, and Painted Enamel Fancy Spoons.

### BACHRACH & FREEDMAN,

3 CHARTERHOUSE ST., LONDON, ENG.

SILVERSMITHS, 1 & 3 UNION SQUARE, NEW YORK.

Sold by all wholesale dealers at manufacturer's price.

A. N. CLARK,  
PLAINVILLE,  
CONN.

Manufacturer of the Celebrated

### LOOP WATCH KEY.

The Best for the Price in the World.  
CROSBY'S JEWELING TOOLS IMPROVED.

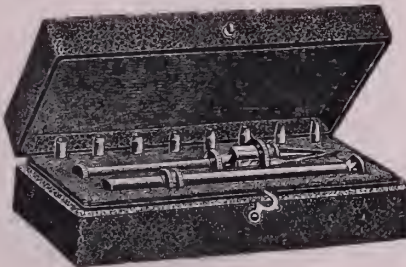
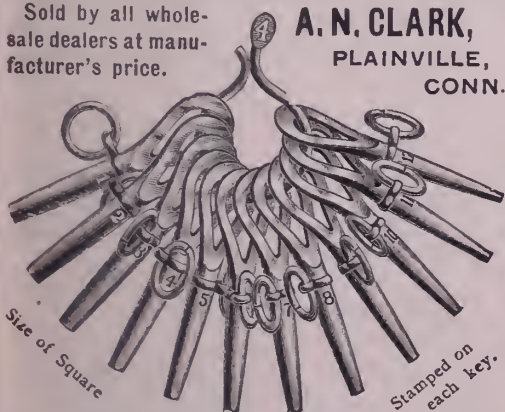

Will quote royalty or price for the manufacturing of articles of real worth.

No jeweler or watch repairer should be without a copy of "WORKSHOP NOTES," a new and very useful book for the workshop. Send for circular containing a complete index of the book, and judge of its merits for yourself.

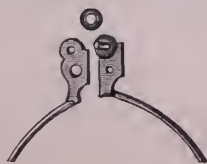

Racine Jewelry Mfg. CO.,

### SPECTACLE TEMPLE WASHERS,

Gross in a Bottle, 25c.  
For Sale by Dealers in Jobbing Materials

**OPTICIANS' SUPPLIES**  
Jobbing and Prescription Work.

The "Graduate" Trial Cases, 180 lens set, \$30.00; 220 lens set, \$37.50. The "Standard" Trial Cases, 220 lens set, \$65.00. All with lenses. Loring Ophthalmoscopes, \$9.00. Artificial Eyes, for selection, \$1.00 each, \$50.00 per hundred. Ophthalmometers, \$30.00 to \$70.00. Queen's Standard Perimeter, \$18.50. Queen's Lens Grinding Outfit, \$3.00. Steel Frames, 15 to 30 cents each. Spherical Lenses, 25 cents per pair. Cylinders, 34 cents per pair. Lenticular Bifocals, 8 cents per pair, (all best) nose pieces for Shell German Silver, \$1.00 per dozen pairs. Gold, \$2.00 per dozen pairs.

**QUEEN & CO.** Opticians and Catalogue free. 1010 Chestnut St., Phila., Pa.

## Jules Jürgensen

OF COPENHAGEN.

The reputation these watches have maintained for Fifty Years has never been equalled, being made on strictly scientific principles and no expense spared to give the Best results in mechanism and timekeeping qualities.

SOLE AGENTS,

John C. Hyde's Sons,

NO. 22 MAIDEN LANE.

## J. H. DEDERICK, JR.,

— DEALER IN —

### Roll Plate Jewelry and Chains,

Optical Goods and Jewelers' Supplies,

16 MAIDEN LANE, NEW YORK.

JET GOODS A SPECIALTY.

FACTORY AND SALESROOM  
 PHILADELPHIA,  
 616 & 618 CHESTNUT STREET,  
 611 & 613 SANSOM STREET.



NO. 20.

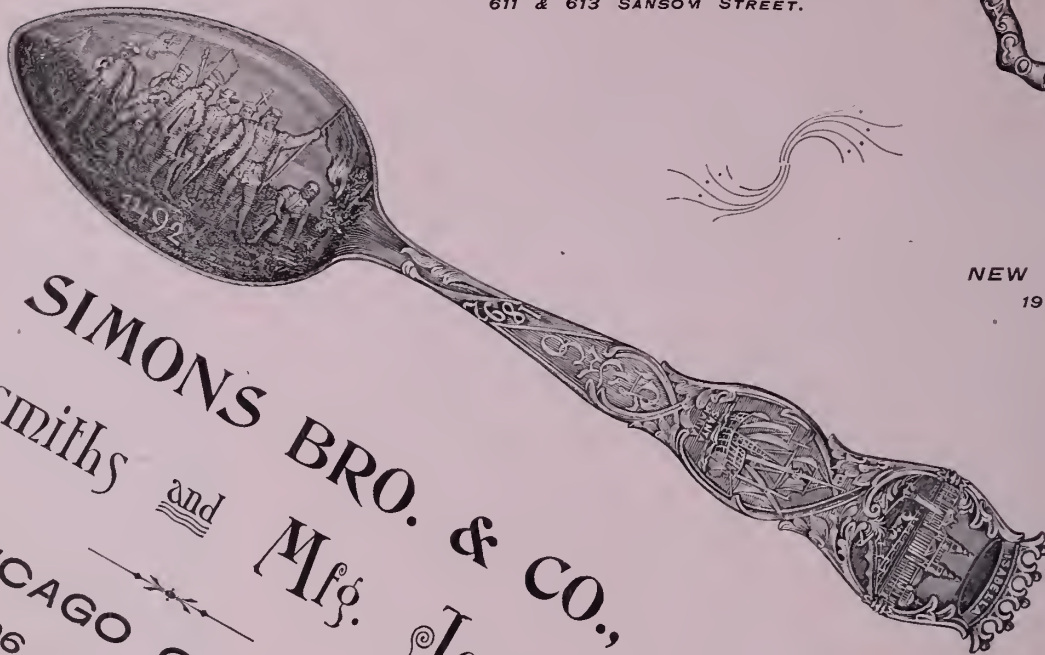

NEW YORK OFFICE:  
 19 MAIDEN LANE.

**SIMONS BRO. & CO.,**  
 Silversmiths and **Mfg. Jewelers.**  
 CHICAGO OFFICE:  
 96 STATE ST.



# GERMANY

SEEKS

**AMERICAN TRADE,**

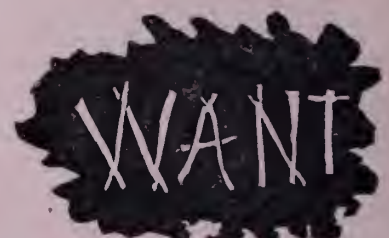

And for the purpose of securing it has for several years **STUDIED AMERICAN WANTS.** The German exhibit at the World's Fair contains a full line of jewelry, special'y **SUITED TO YOUR NEEDS** and expressly made with a view to furthering the jewelry and silverware trade between the two countries. Mr. Richard Horstmann, under whose supervision and through whose efforts the consolidated German exhibits were secured to the Fair, represents the following lines :

- WATCHES. { The celebrated patent watches of **DURRSTEIN & CO'S UNION WORKS AT GLASHUTTE.** Among them movements held by bolts, and not by springs, insuring thinnest cases, split seconds, Chronometers, etc.
- JEWELRY. { Representative manufacturers of Pforzheim, Hanau and Gmeund. These cities are known worldwide for taste in designs and beauty of gold colorings and enamel work in all branches of the jewelry trade.
- SILVERWARE. { Reproductions of the best old German, Dutch and Rococo designs.

We can serve your best interests if you will but let us know your wants. Correspondence invited.

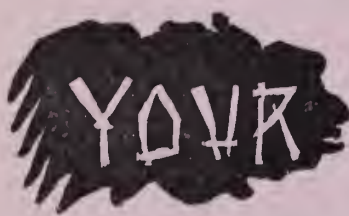

**RICHARD HORSTMANN,**

VIENNA.

Seigmundgasse 15. Tel.-Adr.: PARATUS WIEN.

BERLIN, S. W.

Oranienstrasse 101 102. Tel.-Adr.: PARATUS BERLIN.

LONDON, E. C.

13 Charterhouse Street. Tel.-Adr.: WELLROOM LONDON



CHICAGO, — German Jewelry Exhibit, Manufactures Building, World's Fair.

GERMAN COURT OF HONOR.

# WORLD'S FAIR and WESTERN SUPPLEMENT of THE JEWELERS' CIRCULAR

CHICAGO OFFICE: ROOM 308, INTER-OCEAN BUILDING.

VOL. XXVII.

CHICAGO, WEDNESDAY, AUGUST 9, '1893.

No. 2.

## THE WM. ROGERS MANUFACTURING CO'S EXHIBIT.

The large ebony black World's Fair building of the Wm. Rogers Mfg. Co., in form rectangular, 15x25 feet and 35 feet high, with anchor, the trade mark of the company, borne aloft is one of the conspicuous features of the American silverware section in Manufacture building. The rich black of the structure is brightened by tasteful lines of gold and is particularly noticeable by reason of its sharp contrast in color to the surrounding pavilions. Three arched entrances draped with silk curtains admit to the interior which is carpeted with soft velvets and furnished with all conveniences for the comfort of the visiting trade. The arrangement of the building gives all possible facility for the proper handling and examination of the lines presented and the location, just east of the Tiffany Glass Co., is a most desirable one. The wares are displayed on the two longer sides of the building in sections separated from the reception room in the center by glass partitions. The attractiveness of the display is further enhanced by an artistic arrangement of wares on raised velvet cushions, rising from a flat base covered with silk and greater opportunity is offered for display by having heavy plates of glass suspended midway in the case from nickel fixtures. The northwest section is devoted to flatware.

The base of case is covered with yellow China silk, on which is displayed every conceivable pattern, some twenty-five in all, including all the new patterns of the factory.

Here may be seen pleasing designs in ladles, fish knives and forks, crumb scrapers, berry spoons, sugar and nut spoons, pickle and oyster forks, cheese scoops, toddy strainers, nutcracks and fruit knives in profusion. Ten circular cushions of wine-colored and blue velvet are made brilliant with flatware radiating from the center outward.

scoops and ice cream spoons alternate with the tongs. Nut picks and fruit knives in bright silver, half-satin, satin and all gold make an attractive exhibit on another cushion. Still another has orange and after dinner coffees alternating in their various finishes. Dessert and tea spoons and hollow handled, silver-soldered medium knives

and forks lie resplendent on red velvet, and butter knives, individual butters, butter spreaders and after dinner coffees with gold blades and bowls are attractive on their blue background.

A line of a beautiful pattern called the Columbia is entirely new. A novelty in decoration is shown in having the back of the bowls of spoons, next the shank, finely engraved, giving a pretty effect as it lies on the table. The Shell pattern is shown all through a nice line of goods, from the knife down, making it possible to have knives correspond in pattern to the forks and spoons. Gold and silver julep strainers form on one cushion a center from which radiate nut cracks and picks and preserve spoons. On a blue satin panel surrounded by an ivory frame, is exhibited a line of their celebrated Rogers Columbus souvenir spoons, "the only Rogers souvenir spoon made." These are in three designs, representing Columbus from the time of his

departure from Palos to his return and presentation to the Spanish court.

The southwest section is given over to flat ware in boxes of plush, chamois and leather,

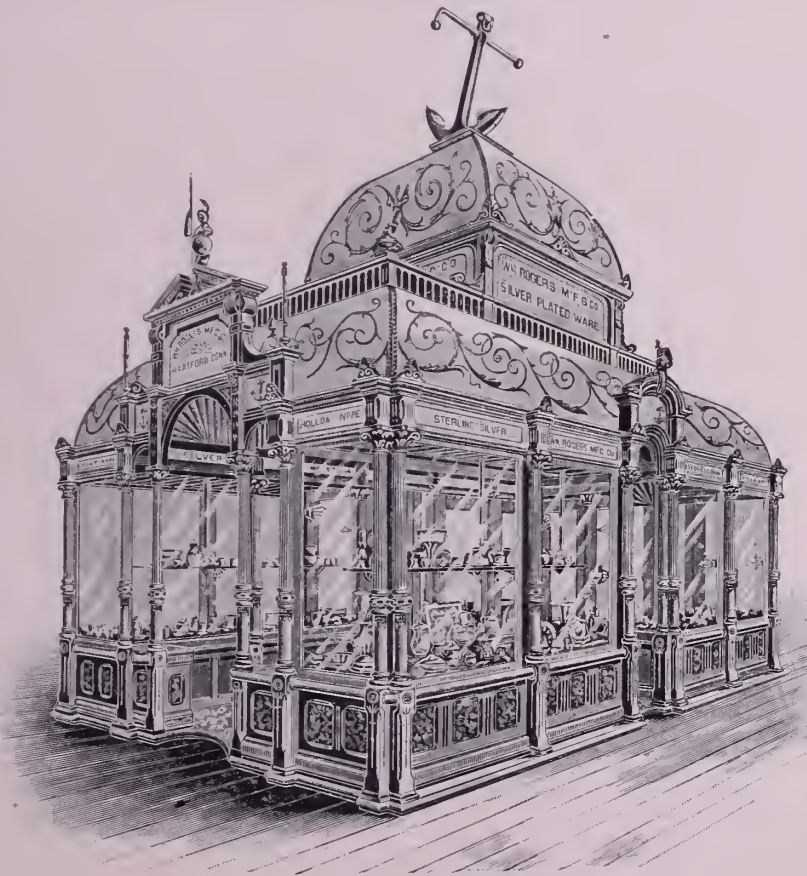

THE WM. ROGERS MFG. CO'S PAVILION.

One has a center formed of salt shovels, and radiating from these are sugar and bonbon tongs with after dinner coffees between the prongs; orange spoons, bonbon

lined with silks, satins and velvets. The line includes the wares above described, and an elegant assortment of presentation pieces. These include a carving set with etched silver handles, ivory handled fruit knives, hollow handled, silver soldered carving sets—a full line, in short, of all that good taste or wealth may desire. Of late patterns beside the Columbia are noted the Opal, Armenian, Rose, Pequot, Kings, Shell and Cromwell.

Special attention in flatware is called to the company's Sectional XII. plate. After goods receive the regular plate they are again triple plated at all wearing points by the company's new and improved Sectional process, by which their extra plate is more than equal to regular 12 ounce or triple plate; double plate is more than equal to regular 16 ounce or quadruple plate; triple plate is more than equal to 24 ounce or sextuple plate; extra Sectional XII. plate is more than equal to regular 16 ounce or quadruple plate.

Hollow ware made exclusively by nickel silver and silver soldered, and a few pieces of sterling occupy the southwest section of the building. These, says Mr. Hall, are the finest goods made, sterling excepted, and by many are preferred to sterling for the reason that they combine with reasonable price the virtue of indestructibility and in patterns more closely approach the sterling than any other ware made. There are 6-piece tea sets, 4-piece tête-à-tête sets, chafing dishes, mugs and cups, soda glass holders and castors in large variety of designs and finishes. A most attractive line of novelties and useful articles of the smaller class are scattered throughout the section, among which are fish sets, children's sets, bread and milk sets, tilting teas, individual

butter plates in ½ dozens, salts and peppers in sterling, individual salt, pepper and butter sets in nickel silver, bonbon bowls and scoops and smaller wares in endless variety.

The northeast section is filled with a brilliant array of larger pieces interspersed with novelties. The line of hollow ware here presented is marked throughout by the distinctiveness shown in the engravings. It is also remarkable as being a line of regular goods, every piece of it, not a piece for display having been made. It will be news to some to learn that the company manufacture nickel silver hollow ware, as the demand has always kept pace with the facilities of the factory and no special effort was made to acquaint them with the fact. By reason of increased facilities the firm is now in a position to fill all orders.

At the west end of the building are shown on four cards the processes of manufacture of steel knives, German silver forks, German silver spoons, and hand made solid silver spoons. In steel knives the process is shown as follows: (1) The steel bar cut to length, (2) handle and bolster swaged, (3) blade rolled, (4) blade hammered, shaped and tempered, (5) handle ground, (6) blade ground, (7) finished ready for plating. In forks the process starts with the blank; then come the first rolling, second rolling, the cutting out; tining, striking up, and finished ready for plating. The same method obtains with German silver spoons except that bowling takes the place of tining. In the hand made silver spoon the bowl is spread by hammering instead of rolling.

In conclusion, it is evident that the continuous manufacture of a certain or special line of goods for forty successive years with ample capital to secure the latest improve-

ments in machinery and the best skill obtainable, should produce marvelous results. These results are shown in their entirety in the World's Fair exhibit of the Wm. Rogers Mfg. Co.

### Quaint Japanese Exhibits.

A Japanese silver tea set has bird and flower designs. Cigar cases have wonderful roosters in lacquer and bright engraved plumage, yellow gold feet and red gold comb; and a six foot counter case is filled with Japanese gold and carved pearl jewelry in quaint designs and most wonderful colored golds.

An artistic and expensive exhibit is that of Shinzo Yoshida, of Osaka, a famous Japanese gold and silversmith. Five caskets and four pairs of vases, bronze finished, are truly remarkable and range in value from \$32 for a mite of a casket to \$1,272 for a pair of vases but ten inches high. Cuff buttons, studs, scarf pins and scarf rings range from \$15 for an unpretentious scarf pin to \$95 for a gem of carving in yellow gold cuff buttons. Three pairs of large bronze vases range from \$17 to \$67.50 a pair, the latter fifteen inches high with cover and upper third of vases of bright scroll work on dull finished ground, the lower two-thirds of bronze finish ornamented with clusters of large silver chrysanthemums. Five large bonbon boxes in different finishes of silver and bronze with covers decorated in Japanese designs range from \$27 to \$145 according to designs. A pair of cuff buttons is formed of a spider's web of bright gold overlaying a brown gold base. In one web is a gold spider; in the other is entangled a gold fly which requires a magnifying glass to bring out the details of fine workmanship.

# JUERGENS & ANDERSEN COMPANY,

## DIAMONDS AND MOUNTINGS,

Order Work a Specialty.

125-127 State St., Chicago.

## ALBERT H. BONNET,

ONLY EXCLUSIVE WHOLESALE JEWELRY HOUSE IN OHIO.

COLUMBUS, WALTHAM, ELGIN, HOWARD AND STANDARD WATCHES,  
GOLD AND FILLED CASES, JEWELRY, CHAINS, CLOCKS.

FULL LINE OF TOOLS AND MATERIALS.

No. 24 E. SPRING STREET,

COLUMBUS, OHIO.



## HOROLOGY AT THE WORLD'S FAIR.

PART IX.—THE ANSONIA CLOCK CO.'S HANDSOME DISPLAY.—AMERICAN WALTHAM WATCH CO. PAVILION.—OTHER HOROLOGICAL EXHIBITS.

THE exhibit of the Ansonia Clock Co. presents a fairyland of fancies in clock architecture. Rising tier above tier is a world of clocks in metal, stone and wood.

The pavilion, or, rather, open court is 25x40 feet, with handsome carved entrance at the corner. Bordering this open court, on each side the entrance are huge display cases six feet wide and rising ten feet from

the entrance, consists of a gold clock of fanciful scroll design, accompanied by two side statues of Oriental beauties. The gold of the clock and statues is brightened by delicate tracery of gilt. Just inside the entrance is a magnificent open work gilt clock in scroll design; at each side are gilt fluted columns on which sit gold figures of a youth and maid playing on musical instruments. These two sets are pure in artistic detail

rewarded gold medals. Merits were, one at National Academy, Paris, 1884, and Diploma of Honor, 1890; participated in Grand Diploma of Honor at Paris in 1878 and 1889; Melbourne, 1881, and Zurich, 1883; also two second prizes and a second prize for average running competition at Geneva Observatory, 1892 and 1893.

The gem of the exhibit is a ten line lever movement. On front of the case is a macaw



EXHIBIT OF THE ANSONIA CLOCK CO.

the floor, with box pyramid running through center for the display of the clocks, which gives the best possible effect to each individual piece. Viewed from the avenue outside are beautiful examples of bronze work in French, Barbedienne and japanned; silver in plain, oxidized and bright; gilt clocks; and combinations of each with iron and marble. A majority are figure clocks with ornamented and illuminated dials. Many represent historic scenes and mythological subjects.

An exquisite set at the south end, next

and are a credit to the clock industry of the country.

## ZENTLER FRERES.

Judging by their number of medals, Zentler Frères must have had many happy hours. The firm make chronometers certified by the Geneva Observatory and all kinds of complicated watches. Their exhibit is decorated with medals of merit won at Vienna, 1873; Paris, 1878; Paris, 1889; twenty-three medals in the competition at Geneva Observatory, five of which are first prizes. In 1890 the firm was the only one

set with diamonds with gold beak and feet and ruby eyes. The dial is partly encircled by a crescent of rubies and a crescent of diamonds with large stones beneath the dial. The pin is a beautiful scroll of diamonds and rubies and the chain suspending the watch has alternate links of diamonds and rubies. The pin is detachable and can be worn separately. A hairpin is shown in which a watch movement causes a large diamond star to revolve.

J. Ferrero has a beautiful assortment of ornamented cases in colored enamels, por-

traits and landscapes, including a fine portrait of President Cleveland. One shows a family of nine persons in small portraits on one case. One seven line watch is backed by a single diamond covering the entire case, valued at \$1,300. All the diamonds

tion of Evan Roberts, of Manchester, England, were published in THE CIRCULAR of May 17th and June 17th.

C. DEGALLIER'S CHRONOMETERS AND REPEATERS. Watches of superior quality in chronometers with first-class certificates, repeaters,

**B. Grieshaber's Gold Pen Display.**

THE gold pen industry as exemplified in the exhibit by B. Grieshaber in the northeast gallery of the Manufactures build-



THE AMERICAN WALTHAM WATCH CO.'S PAVILION.

are set in perforated cases and the line of these goods is particularly fine.

AMERICAN WALTHAM WATCH CO.

Full descriptions of the pavilion here illustrated of the American Waltham Watch Co., and the exhibit contained therein, together with antique historical collec-

bracelet and ball designs in many elegant patterns are exhibited by C. Degallier. A specialty with the house is a very small lever gold watch for ladies, of which a fine line of highly finished goods is shown.

A few other exhibits in this section are yet to arrive.

ing, section F, column 90, leaves nothing to be desired, and shows that the manufacture of pens has reached its highest attainable degree of perfection. Facing a broad central street of the gallery, with avenues on side and rear, the location is such as the beauty of the ensemble demands. Across the front

**M**OSELEY & COMPANY, ELGIN, ILL., would call your attention to the fact that they had planned to have an exhibit at the World's Columbian Exposition, and after many delays had space assigned, not where they expected it, but in Machinery Hall. During this time orders came in thick and fast, and our stock was so near exhausted that we could not make (to us) a satisfactory exhibit. Though working fifty men and making overtime we are still struggling to catch up with our orders. And still they come. We intend to have a fair exhibit with all the jobbers in Genuine Tools and Materials in Chicago for your inspection, and those wishing to learn the HOW to do any particular thing on the Moseley Lathe or any of its attachments, can do so by calling at the Chicago Watchmakers' Institute, No. 701 Masonic Temple, where the management will be pleased to give you a practical showing of the operation—which may be worth dollars to you, and other schools you may visit will be pleased to do the same.

Present your card, make known your desires, and you will be cordially received.

Yours truly,

**MOSELEY & CO**



Send for this slip and new Catalogue.

and end three rosewood framed plate glass counter cases rest on mahogany tables, and the L thus formed is used for office purposes, the office being separated from the avenue at the rear by a polished brass rail.

At the four corners slender, square, beaded columns support a roof rich in its immaculate whiteness. Similarity is shown in the general arrangement of the three cases, but all differ in the lines of goods shown. Each case has a raised platform of mahogany with beveled sides bearing the firm name. On this are mahogany trays with light blue velvet pen supports crossing each tray leaving exposed a part of the highly polished wood. In the center of each case is a large diamond of black velvet on which are displayed pens of all varieties without holders, excepting that at the points of the diamond are diminutive pearl holders containing the smallest pens ever made, wee specks that require a microscope to convince one that they are indeed perfect pens.

The other specially attractive tray is of large plain pearl holders, with both barrel and regular engraved pens in No. 10 size. All the varieties of material in holders known to the trade are here displayed. Pens from Nos. 1 to 10 are shown on the third cushion, encircled by a host of rubber and engraved aluminum holders, and box sets of special designs. Suspended in the center case is the huge barrel pen heretofore noticed in THE CIRCULAR, containing 345 pennyweight gold, with engraved bands and fan decoration set with diamonds, turquoise and rubies.

The holder with this rare piece of work is of seamless drawn aluminum over two feet long—the largest piece ever drawn—richly enameled, the engraving on holder cutting through the enamel in bright designs, showing the words "World's Columbian Exposition, Chicago, 1893," and "Seamless, B. G.," and floral designs about handle spirally from end to end. Taken all in all the exhibit is a remarkable one, and one in which the firm take great pride.

"Some of the larger houses are not represented at the Fair," said Mr. Grieshaber, "and for that I am heartily sorry. I would have been pleased to place my products in competition with the world at large and abide by the decision of competent judges."

On the diamond in the south case are fancy patterns in gold pens, including right and left oblique, falcon, long nib and stub, straight nibbed oblique, Lafayette, double spring, music and stub pens in fine, medium, coarse, shorthand, etc.—everything in fact in fancy pens. Surrounding the diamond are four triangular cases lined with blue silk velvet forming with the diamond, a rectangle, and containing pencils in silver, gold, onyx, rubber and aluminum, the holders in various styles of engraving and pattern. In side trays are shown gold and silver holders in chased and engraved and pearl in a variety of forms, a pearl quill holder being an attractive feature. Presentation pieces in single pens with holders and also in sets of pens and

pencils are shown in handsome boxes.

The next case to the north contains the wonders in pen and holder making which have so added to the firm's high reputation. In the center diamond are engraved pens from Nos. 1 to 10 surrounded by pencils in gold, silver, niello, pearl and aluminum and fancy and odd designs. To the right and left are pens in infinite variety, three trays of which are entitled to more than general mention. Two have twenty-four holders of seamless silver richly chased in beautiful designs, two of the holders being worked out in filigree design which in nowise lessens the strength of the material but adds greatly to the beauty of the article. The acme of richness in metal holders is here shown, a round chased design being particularly effective.

### Consolidated Oforzheim Hanau and Gmund Exhibits.

August Hoffmann, of Hanau, in the north part of the German section, shows a line of jewel cases in ivory, mother-of-pearl, tortoise shell and plush. Ivory forms the larger part of the exhibit and includes watch, ring, brooch and chain boxes, sewing sets, writing sets and desks, work boxes, jewel cases, writing tablets and numerous smaller cases for various uses. Nearly all are perfectly plain, the form of the boxes constituting the novelty. The mother-of-pearl boxes include the same lines, the pearl being laid on in diamond shapes. The tortoise shell, malachite, plush, silk and velvet cases are of the smaller description. All the interiors are elaborately finished with silks, satins and velvets of different shades. The ex-

hibit is under the superintendence of Richard Horstmann, the German exporter who has supervision of the German consolidated jewelry interests.

In the display from S. Gmünd is shown a fine assortment of the wares of Soergell Stollmeyer, the celebrated thimble manufacturer. The line is arranged on shelves on a diamond shaped cushion and makes an attractive exhibit. The different patterns knurling are unique and the bands are highly chased and ornamented with colored gold and enamels. Nearly one-half have tops of glass in various colors with ground knurls. At the corners of the space on white velvet, fan shaped cushions, are sewing sets of six pieces in gold and silver.

The only coral exhibit in the German jewelry section is that of Ed. Woehler. The display, though small, is fine and comprises mounted hair pins, brooches, bar and lace pins, bracelets and coral branches. A large branch is of an unusual color, a pearly white shaded with light pink. Another showy branch is a deep red. On the center cushion of Woehler's exhibit is Roman gold jewelry ornamented with diamonds, pearls, rubies, sapphires and amethysts. A bracelet of Roman gold in filigree design has a center band of filigree eight-leaved flowers with pearl centers, and across the front in  $\frac{3}{8}$ -inch letters the word Chicago set closely in diamonds. The centerpiece is an amethyst brooch with a stone  $1\frac{1}{4}$  inch in diameter surrounded by a filigree design of Roman gold set with pearls. This piece has earrings to match. At the sides and below the central cushion is a pretty line of stone set jewelry.

Oxidized silver chatelaines, bracelets, laces, fobs, belt buckles, chains and purses

# REED & BARTON, Silversmiths,

MANUFACTURERS OF

STERLING <sup>and</sup> SILVER PLATED  
SILVER WARE.

Salesrooms:

37 Union Square, New York.

32-36 WASHINGTON ST.,

Venetian Building, Chicago.

FACTORIES, TAUNTON, MASS.

are exhibited by Gustav Hauber, of Gmünd. The designs partake largely of the order of reproductions of antique jewelry and are distinctively German in character. A fine piece is a double strand chain necklace with medallions of oxidized silver having centers of lapis lazuli in a beaded gold border. The medallions are at an interval of 1½ inches and connect the two chains. A handsome pendant of lapis lazuli, oxidized silver, gold and niello work is suspended from the necklace.

Some very artistic designs in gold jewelry are shown by Ottmar Zieher, each individual piece having special merit. Bracelets, charms, brooches, bar pins and earrings take precedence in the order named. The decorations are tasteful and the arrangement well calculated to set off the goods, which are principally jeweled to the best advantage.

Steinheuer & Co. exhibits woven silver, oxidized silver and gold card cigar, cigarette, tobacco and match boxes, variously decorated in gold and silver. Across the fronts of several are the words, Chicago, 1893, in silver script, and on several others is the American eagle and shield. Novelty in jewelry are shown in fob chains, bar pins, bracelets, brooches, cuff buttons and scarf-pins, made of real horseshoe nails, each nail having a sheet of gold hammered over the head. The nails are of finely finished wrought steel and are bent into the desired forms. The fob chains consist of the usual gold swivel and four gold links. To these are attached a horseshoe nail with a link soldered to the head and in the bent point is the curved point of one hanging head down. From this head depends a nail curved in a circle, to be used as a charm. It is a unique arrangement of a good luck emblem.

Another novelty in this display is a line of pins and brooches in which a novel feature is the employment of diminutive gold telegraph poles with wires strung on a number of minute porcelain insulators. Hair and bonnet pins and penholders are

also shown with the insulator ornamentation. The center piece of the exhibit, or rather one of several center pieces, is a memorandum book with illuminated ivory leaves, gold bound, covers of turquoise shell heavily decorated and bound in gold, and a back binding of woven chain pattern. On the front in raised gold letters, diamond studded, are the words, Leaves of Remembrance.

Two other books, presumably a prayer book and hymnal, are in ivory covers similarly decorated in gold. Two ash trays in red and yellow gold are very pretty. In one a maiden in bathing costume leans over a shell shaped tray holding in her right hand a golden rod over which jumps an oxidized silver poodle. The other shows a snail extended from its shell on one side of a gold basket of wicker pattern; a boy on the other side toots at it with a trumpet. In the upper part of the case are shown two lovely diamond rose sprays 10 inches in length, with stems of bright and Roman gold and leaves and petals outlined in the same metals, the whole thickly incrusting with diamonds and the centers of the full blown flowers bearing large single stones. The ladies are profuse in their praises of these two gems of the jeweler's art.

On a cushion between the sprays are jeweled pins, diamonds, pearls, sapphires, rubies and turquoises being used in different combinations. A particularly rich pin for the hair is in tortoise shell 6 inches long and one-half inch wide at one end, tapering to a point at the other. On the wide end is inlaid a bird in yellow gold hovering over a bouquet of red, green and yellow gold flowers. Jeweled bracelets in handsome combination of stone settings complete the interesting display.

Fr. Schütz displays profusely jeweled goods in all lines. All the jewelry is delicate in design and has evidently been made with a view of catering to American tastes. The line consists of brooches, scarf pins, bracelets, diamond stars, flower sprays, diamond set ribbon-pins with large pear

shaped pearl pendants, jeweled butterfly and dragon fly hairpins, ladies' chatelaines, clover-leaf pins of pearls and emeralds and pearls and rubies, and jeweled daggers. All are jeweled. The most noticeable piece in this collection is a turquoise brooch formed of three stones in the shape of birds' eggs set in a trefoil design of gold decorated with diamonds and pearls. Pendant is a large pearl. The brooch has earrings to match, of egg shaped turquoises encircled with diamonds.

In taking leave of the consolidated jewelry exhibits of Pforzheim, Hanau and Gmünd manufacturers, credit should be given Richard Horstmann, the German exporter, as without his efforts the exhibit of the German jewelers would not have been made. The lines are selected with good taste, the designs show originality, and the management for examination of the goods is superior to that shown by any other nation, America not excepted. Visiting jewelers should note that the arrangement of the cases is applicable to the window dressing of stores. The silver manufacturers of Hanau and firms outside the consolidated exhibit will be treated in subsequent articles.

#### American vs. Foreign Exhibitors.

IN answer to your question as regarding the American exhibitors retailing goods at the World's Fair, said Theodore H. Purple, Secretary of the Associated American Exhibitors of the World's Columbian Exposition, "I would be very glad to answer you personally, and with the feeling as to how the silver plated ware men and the kindred trades regard this matter; speaking as manager of the Holmes & Edwards Silver Co. and the Manhattan Silver Plate Co., I would not under any circumstances allow any of my men to retail to anybody a single article from the exhibit at the World's Fair; we have too much respect as manufacturers to sell goods in this way, and we have a greater respect for the trade whom we at all

**DIAMONDS** **WATCHES** **BHA** **JEWELRY** **MANUFACTURING**

**LAPP AND FLERSHEM** Chicago, Ill.  
92, 94, 96 & 98 STATE ST. COR WASHINGTON

**THE LARGEST SUPPLY DEPOT**

*For Everything Needed by Jewelers*

ILLUSTRATED CATALOGUES FURNISHED JEWELERS.  
SPECIAL FACILITIES FOR FILLING ORDERS NO RETAILING!

**STERLING & SILVER PLATE** **BHA** **OPTICAL** **GOODS**

**CLOCK** **CANE** **STOOLS & SEWING MACHINES**

times try to protect. My instructions in taking orders are, that if any of the out-of-town people see goods that they want of our manufacture, we gladly take their names, and always refer them to our agent in their town, as we have an agent in almost every town, and then we give our agent the benefit of the sale. We quote prices that will be retail, so that our customer can get a profit. We are doing this work for the benefit of all our customers. I know, when I state this, that these sentiments are indorsed by all first-class manufacturers in our line, and I do not know of any that have been kindly acquainted with me for the last twenty-five years, who would not sustain this statement.

With reference to the question of the selling of goods by foreigners, from the standpoint of Associated American Exhibitors, the only answer that I could give you would be, that it would have to be voiced by a vote at a regular meeting.

"Is it injurious to have foreigners sell goods?" It is, of course, to a certain extent, but I understand that most of the goods in our line that are sold for foreign goods are manufactured in this country as cheap goods, and are said to be often sold as sterling. I speak now of spoons, my attention being called to the matter by an associated exhibitor in our line who purchased a brass spoon with very little silver deposit. It was sold him for sterling silver by a foreign exhibitor. I personally object to these fakirs who have, to a certain extent, clouded other elegant exhibits at the World's Fair.

The American exhibitors are there to educate people and show what almost incomprehensible strides manufacturers have taken in producing not only practical but artistic results.

Of course all American exhibitors have put their best foot forward to entertain the people with something that is beneficial, elegant and thoroughly educational, but we cannot do away with the peculiar characteristics of Midway Plaisance.

I know that the American exhibitors are taking a more dignified position in their wonderful exhibits than the foreigners, and believe that the rewards will be justly given to those deserving of them.

Radam, the New York microbe specialist, bought the largest Ross microscope on exhibition at the Fair through the Geneva Optical Co., the American agents for Ross & Co., London. The gentleman required the best of instruments for investigating microbes in blood corpuscles and found it in the Ross exhibit.

**Gossip of the Exposition.**

**T**HE World's Fair correspondent of THE CIRCULAR, in his rambles among the different government buildings, found many interesting features that should be read particularly by manufacturing jewelers and silversmiths. Decorative art, like history, repeats itself; and in the vivid pen pictures of the writer referred to, "opportunities may serve" to the receptive mind.

The exhibit of Columbia is of interest to every jeweler. It is contained in a small but cosy structure in charge of Charles Martinez Silva and consists of a remarkable collection of prehistoric gold ornaments and utensils recovered from the graves of a lost race that once inhabited the land. The collection in its entirety is one of the most valuable and interesting ever made. There are crowns and scepters, helmets and breastplates, beaten out of solid gold; images of gods twelve to eighteen inches in height, made from the same precious metal, in addition to personal ornaments, nose-rings, earrings, hairpins without number. One gold necklace is made to represent the skeleton of a snake.

Owing, no doubt, to the continuing of dry weather, articles of a refreshing appearance especially attract purchasers. Bonbon boxes and scent bottles in rock crystal, with a very light gold mounting sell well. A pretty scent bottle in pink colored rock crystal is circled at the top with two rows of brilliants; the base of the stopper is surrounded with dancing Cupids in chased gold closely framing the crystal.

Articles in translucent enamel are also very taking. Lovely pin and stamp boxes, or bonbon boxes to rest on a boudoir table are made in this style. The decoration chiefly consisting of natural flowers or conventional foliage with here and there an insect or a bird, very delicately treated. The colors are beautifully shaded and all details are finely drawn. Cups and saucers, jewel caskets and small jardinières are also made in this fashion, but on these pieces, the floral decoration is in slight irregular relief.

François Borgel shows the latest novelty in economical and waterproof watch cases. These are made in a single piece to screw without a hinge and are patented in all countries. The line is shown largely in oxidized steel with inlaid gold ornaments. One has the face of the Pope, another that of President Carnot. A line of oxidized steel and gold watch bracelets is also shown.

The Associated American visitors at the Exposition have organized a band of instrumental music of 25 pieces, including some fine soloists, for the purpose of attracting

visitors to the Fair into the galleries of the various buildings. The intention is to furnish popular music and the band will be stationed in different buildings from day to day. The gallery attendance has been comparatively small and it is hoped by this means to increase it.

C. S. Perry, formerly with the Du Lany Clock Co., and a well known man in watch circles, will assist J. C. Adams, often called father of American watch making, in the Geneva pavilion of the Swiss section. The Swiss have selected strong men to care for their interests.

The first gift presented to Mrs. George Thacher, manager of the Children's building, was 500 souvenir spoons by the Holmes & Edwards Silver Co., to be distributed among the children.

**AT THE FAIR.**

There's the Gaekwar of Baroda;  
And the Nawab of Rampur;  
There's his Kapurthala joblots,  
And Doakhovsky from Amoor.  
There's Hakkey Bey from Turkey,  
With a windmill from Waukegan;  
But there's never been a word said  
Of the Loo Loo from Skowhegan.  
— Toledo Blade.

The Loo Loo from Skowhegan  
Is a man of modest mien,  
Like others bent on World's Fair work  
More often read than seen;  
He's writing for THE CIRCULAR,  
Cares naught about his name,  
But keeps his readers posted  
Though a Loo Loo just the same.

**EST. 1870.**

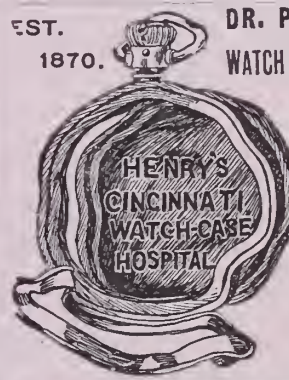

**DR. PETER HENRY,**  
SPECIALIST IN  
**WATCH • CASE • DISEASES**

Key Winders changed to Stem Winders.

Hunting Case changed to O. F.

English Cases changed to fit American movements

Can be cured at  
**53**  
Longworth St.,  
Cincinnati, Ohio

**CHICAGO WATCH TOOL CO.**

SPECIAL MACHINERY

MANUFACTURERS OF  
JEWELERS' MACHINERY  
WATCH MAKERS  
and  
JEWELERS' TOOLS  
Etc.

TOOLS MADE TO ORDER

52 MADISON STREET  
CHICAGO



Patent applied for.

Victoria Novelties, many fancy shapes.  
Celluloid Top, Sides, Bottom and Cushions  
**A. TROESCHER & CO., 69 Nassau St., N. Y.**

ESTABLISHED 1879.

**G. W. HOOK,**  
MANUFACTURING JEWELER,  
149 and 151 State Street, Chicago, Ill.  
INSPECTION BY THE VISITING TRADE INVITED.

### Chicago.

The following jewelers were noted in the city and at the Fair last week:

Jos. Houghton, Manchester, N. H.; Wm. V. Foster, Tipton, Ind.; J. B. Storer & Co., Akron, O.; J. C. Peers, Rockford, Ill.; H. D. W. English, Arcade, N. Y.; Lee Danser, Camden, O.; R. Baude, Louisville, Ky.; Theo. Ernst, Fort Madison, Ia.; B. J. Dunning, Kansas City, Kan.; F. H. Pitkin, Andover, O.; Edw. L. Jones, Harrington & Co., Columbus, O.; E. C. Brower, Fife Lake, Mich.; F. S. Carr, Springfield, Mass.; Ed. W. Kelly, Sullivan, Ind.; Lott Reznor, Arkport, N. Y.; B. S. Pratt & Son, Grand Ledge, Mich.; Pfaelzer Bros & Co., Philadelphia, Pa.; J. P. O'Brien, T. R. J. Ayres & Sons, Keokuk, Ia.; M. P. Davis, Mt. Sterling, O.; F. J. Morrison, Silver Creek, N. Y.; C. S. Sands & Co., Albia, Ia.; Chas. Price, Jacksonville, Ill.; Emil Bachmann, Milwaukee, Wis.; G. H. Beattie, Baxter & Beattie, Cleveland, O.; Walter Williams, E. P. Roberts & Sons, Pittsburgh, Pa.; J. G. McAlpine, Bakersfield, Cal.; M. Golding, Waco, Tex.; Irion & Girardet, Louisville, Ky.; Maurus Kaehlin, Jr., Nelsonville, O.; H. W. Getts & Co., Clay Center, Kan.; Fred Maynard, Gibsonburg, O. L. Goldsmith, Koch, Dreyfus & Co., New York; Geo. A. Montgomery, Los Angeles, Cal.; W. B. Russell, S. A. Rider Jewelry Co., St. Louis, Mo.; S. B. Emmons, Mindon, Mich.; Ross Larrabee, Macon, Mo.; H. Hart, Rochester, N. Y.; John Armbruster, Cedarburg, Wis., Aug. Kurtzeborn, Prest. L. Bauman Jewelry Co., St. Louis; George B. Bement, Brodhead, Wis.; Max Gruner, Shelbyville, Ky.; M. C. Prints, Herkimer, N. Y.; F. W. Graves, East St. Louis, Ill.; Wm. J. Drumtra, Altenburg, Mo.; George M. Rigdon, Streator, Ill.; Chas. A. Mauch, Marshall, Mo.; Richard Wilson, Peoria, Ill.; P. E. Hannah, Edmond, O. T.; T. J. Harper, Atlanta, Ga.; C. E. Hart, Albert Bros., Cincinnati, O.; P. E. Godefroy, E. A. Zadek Jewelry Co., Mobile, Ala.; F. C. Hoagland, Jas. Mix, Albany, N. Y.; Theo. A. Weber, Pittsburgh, Pa.; G. B. Shaffer, Merrill, Mo.; Otto E. Heineman, Allegheny, Pa.; Geo. R. Stumpf, St. Louis, Mo.; J. F. Schmitt, St. Louis, Mo.; J. H. Eggleston, Angelica, N. Y.; H. G. Boesser, Fort Smith, Ark.;

Wm. B. Vail, Rock Rapids, Ia.; Frank Anshutz, Shenandoah, Ia.; M. A. Selbert, Frankport, Ky.; Aug. A. Gerlach, Columbus, O.; Mrs. F. G. Sundberg, Brainerd, Minn.; C. E. Range, Trenton, Mo.; H. T. Wolff, Philadelphia, Pa.; C. H. Dew, J. T. Dew and Son, Summerfield, O.; J. P. Whitney, Tyler, Tex.; Charles C. Rohne, St. Louis, Mo.; A. W. Runeman, McKeesport, Pa.; James E. Scanlan, Boston, Mass.; Walter Upington, Norwalk, O.; Geo. R. Young, Bellevue, Ia.; A. Stankiewicz, Hallettsville; Charles H. Carpenter, Minneapolis, Minn.; R. G. Rutherford, F. H. Ingalls, St. Louis, Mo.; Jacob Sayler, Hillsboro, O.; E. J. Schmid, Rodney, Ont.; Morse & Co., Grand Rapids, Mich.; O. C. Genthner, Wheeling, W. Va.; A. W. Dorchester, Providence, R. I.; L. Haensson, Cincinnati, O.; J. Walker, Greenfield, Ind.; Will H. Irwin, Pittsburgh, Pa.; R. A. Houghton, Corunna, Mich.; A. S. Miller, St. Paul, Minn.; B. Golberg, Milwaukee, Wis.; Charles Cunningham, Youngstown, Pa.; S. L. Hart, Flemington, N. J.; H. Hendelman, Towanda, Pa.; B. C. Wilkinson, York, Pa.; G. W. Townley, Fairfield, Ia.; W. Lentz, Philadelphia, Pa.; Edward Clank, Jr., Poultney, Vt.; Loewenstein Bros., St. Louis, Mo.; T. H. Cooke, Chattanooga, Tenn.; H. C. Kachlein, Lafayette, Ind.; J. H. Reel, Paris, Ill.; J. W. Paulen, Fredonia, Kan.; John A. Henser, Pulaski, Va.; John H. Beelman, Grand Rapids, Mich.; A. Armbruster & Son, Springfield, Ill.; G. Judd Williams, Urbana, O.; Chas. E. Jones, Buena Vista, Cal.; F. M. Herron, Indianapolis, Ind.; Louis S. Gnzmer, Hartford, Wis.; W. O. Sanders, Manly, Ia.; A. B. Barker, & Son, Frankfort, Ill.; Edward Bruder, Philadelphia, Pa.; Wm. Walcott, Toledo, O.; D. Seifert, Phillipsburg, N. J.; A. Franklin, Lonoke, Ark.; Louis C. Lowes, Indianapolis, Ind.; A. Jonas & Sons, Youngstown, O.; L. A. Hoard, Waupun, Wis.; Arthur Vaughn, Burlington, Ia.; T. R. Cushing, Rockland, Mass.; J. M. Bigwood, Terre Haute, Ind.; A. O. Benedict & Co., New York; R. H. Dilley, Cambridge, O.; W. L. McCracken, Huntington, Tenn.; C. L. Crawford, Peoria, Ill.; G. E. Marshall & Co., Middleburg, Vt.; J. A. Newton & Son, Kansas City, Mo.; A. W. Adams, Adams, Mass.; H. S. Johnston, Apollo, Pa.; J. E. McHenry, Wabash, Ind.; F. A. Feidler, Milton, Pa.; T.

B. Zeller, Brookville, Pa.; Joseph Ling & Co., Dallas, Tex.; Tony Birrer, Pueblo, Col.; Wm. Bradshaw & Son, Delphi, Ind.; H. L. Jacot, So. Bethlehem, Pa.; Geo. M. D. Lewis, Philadelphia, Pa.; F. M. Shirley, Cleveland, O.; Geo. Fetherston, What Cheer, Ia.; John H. Shulier, Philadelphia, Pa.; Jas. G. Maree, Philadelphia, Pa.; J. A. Flownfith, New York; Frank French, Mendon, Ill.; D. H. Gardner, Ravenna, O.; Leopold Guth, Clarion, Pa.; Edwin W. Drury, Lancaster, Pa.; M. M. Iluck, Schuyler, Neb.; Julius Baum, Kansas City, Mo.; Louis L. Dureh, Nollsville, Ind.; F. W. Slaughter, Galesburg, Ill.; Byron L. Strasburger, New York; J. C. Adler, New York; E. R. Zell, Reading, Pa.; T. J. Woltz, Monticello, Ind.; J. L. Youts, Greenville, Ky.; J. M. Shaffer, Ephrata, Pa.; Weis & Oppenheim, New York; John Taylor, Manchester, N. H.; W. J. Henry, Ironton, O.; H. Garman, Coatsville, Pa.; Herman Goepel, Port Gibson, N. Y.; J. H. Bee, New Kensington, Pa.; Henry Wolf, Newark, N. J.; C. A. Sherdahl, Montevideo, Minn.; Isaac Adler, D. Adler & Son, Lexington, Ky.; J. H. Steideman, J. W. Cary & Co., St. Louis; P. T. Ives, Meriden, Conn.; H. M. Berry, Alma, Kan.; H. Stuert, Philadelphia, Pa.; O. C. Retsloff, Winnebago City, Minn.; Wash. McGinnis, Marion, Ind.; D. B. Paul, Norfolk, Va. Robert Leusth, Philadelphia, Pa.; Beckett Bros., Lucerne, Mo.; C. W. Clifford, Bath, Me.; A. Parsons, Finton, Ia.; J. E. Frantz, Marion, Ia.; Jas. A. Danley, Denver, Col.; C. H. Bauer, Concordia, Mo.; J. M. Embry, North Lewisburg, O.; E. Hamam, Monmouth, Ill.; Joseph Embry, Richmond, O.; S. Heidler, Philadelphia, Pa.; C. A. Kortenhaus, Philadelphia, Pa.; W. S. Weaver, Knightstown, Ind.; Ed. Sithens, Philadelphia, Pa.; V. H. Creveling, Minneapolis, Minn.; Geo. Strickland, Merrill, Wis.; C. G. Conyne, Britton, S. D.; J. J. Mitchell, Viola, Ill.; J. P. Smith, McHenry, Ill.; Charles J. Giering, Middletown, N. Y.; J. A. Elliott, Mansfield, Pa.; Ludy & Taylor, Cedar Rapids, Ia.; J. H. Stevenson, Johnstown, Pa.; George Dieterich, Washington, D. C.; B. Hiltberth, Daniel T. Smith, Salem, Mass.; D. R. Sloan & Co., Lonaconing, Ind.; W. C. Klein, Connesville, Ind.; C. M. Gamble, So. Amboy, N. J.; Louis Freund, N. Y.; Mr. Morrell, Boston, Mass.; F. L. Murray, Guthrie, O. T.; Geo. E. Morrill, Boston, Mass.; J. C. Wieting, Peoria, Ill.; M. Lorch, Louisville, Ky.; Emil Bachmann, Milwaukee, Wis.; A. F. Hostetter, Lancaster, Pa.; A. H. Witman, Minonk, Ill.; C. S. Sands, Albia, Ia.; M. SchAAF, Richmond, Va.; J. H. Peoples, Cincinnati, O.; C. M. Kinsel, Columbus, Ga.; R. S. Krull, Ft. Wayne, Ind.; Leopold Jansen, Trevitz & Opitz, New Orleans, La.; S. W. McDonald, Wm. Mair, New York; W. H. Jamouneau, Prest. Alvin Mfg. Co., New York; B. F. Gorton, Arctic Center, R. I.; Placide Reynes, New Orleans, La.; B. Yehley, Delawan, O.; B. J. Dunning, Kansas City, Kan.; R. S. Phillips, M. Golding, Waco, Tex.; I. Schlegel, Philadelphia, Pa.; Henry J. Lefort, Newark, N. J.; Mr. Upmeyer, Bunde & Upmeyer, Milwaukee, Wis.; L. H. Walter, Olston & Maxwell, Tuscaloosa, Ala.; Chas. A. Mauch, Marshall, Mo.; Richeson, Ullery & Co., Covington, Ky.; J. M. Jerome, Embro, Ont.; A. J. Schifelin, Peoria, Ill.; Paul Rudolph, Milwaukee, Wis.; H. J. Smith, Racine, G. A. Pfeiffer, Parkersburg, Ia.; Harry Minkley, Ionia, Mich.; Max Stein, New York; Carl McClure, Watersmeet, Mich.; E. W. Nuckolls, Eldora, Ia.; L. Burger, Birmingham, Ala.; B. Sandfelder, St. Louis, Mo.; F. E. Blackburn, Des Moines, Ia.; J. B. Watson, Caspersville, Mich.; I. R. Bunker, St. Paul, Minn.; W. B. Foster, Tipton, Ind.; T. G. Will, Albany, Ore.; T. G. Yates, Hopkinsville, Ky.; B. Mair, Atlanta, Ga.

Among the buyers were: A. M. Wright, Augusta, Me.; H. G. Keiser & F. F. Alger, Racine, Wis.; F. H. Nettleton, Collingswood, Kan.; D. A. Hauk, Logansport, Ind.; Walter Starcke, Junction City, Kan.; Geo. H. Gooler, Walnut Grove, Minn.; Chris. Hauch, Pittsburgh, Pa.; Mr. Cotton, Tiffany Co., N. Y.; J. G. Taylor, W. W. Wattler, Pittsburgh, Pa.; I. C. Cram, Indianapolis, Ind.; Geo. H. Waterhouse, Geo. H. Taylor & Co., Providence, R. I.; Fred. A. Clough & Co., Mt. Vernon, O.; A. G. Feller, Jamestown, N. D.; H. J. Scott, North-

## RECEIVER'S SALE.



ENTIRE Stock of **Giles, Bro. & Co.** Fourth Floor Masonic Temple, consisting of Diamonds, American and Swiss Watches, Jewelry, Silver and Plated Ware, Tools, Materials, etc. will be sold in lots to suit the purchasers, at large reduction from original cost price.

An unusual chance for live Jewelers to obtain bargains.

W. H. GLEASON, Receiver.

July 14th, 1893.

boro, Ia.; John T. Gardner, Nicholas Pee & Co., Indianapolis, Ind.; J. M. Coc, Pensacola, Fla.; William F. Englehart, Philadelphia, Pa.; R. E. Schubart, Wheeling, W. Va.; Chas. H. Carpenter, Boston, Mass.; Peter Mahler, Milwaukee, Wis.

The following self-explanatory circular was sent to the members of the Chicago Jewelers' on last Association Monday :

**BUREAU OF INFORMATION**  
OF THE CHICAGO JEWELERS' ASSOCIATION,  
COLUMBUS MEMORIAL BUILDING.

GENTLEMEN :—There will be a musical recital in the reception rooms of the Jewelers' Association Tuesday afternoon from 2 to 3 o'clock.

This is given under the direction of the Bureau of Information and Entertainment, and it is to be hoped that every member of the association with friends and visitors will be present.

A first-class programme has been arranged.

LEM W. FLEKSIEM,  
Chairman.

Chicago, July 31, 1893.

The entertainment was a rare treat to the many members and those ladies who attended. The rooms put on their gayest attire; bright with the glow and redolent with the perfume of many flowers, with soft rugs covering the floor and costly paintings adorning the walls, they resembled more the handsome reception rooms of a well appointed home than the meeting place of a mercantile association. There had been engaged for the occasion the following musical talent: Mme. Clara Murray, harpist; Miss Ella Stannard, soprano; Mrs. Ward, contralto; Mr. Vinal, tenor; Mr. Sturtevant, tenor; Miss Wheat, accompanist. The first number was a harp solo by Mme. Murray with piano accompaniment. Then followed a vocal solo by Miss Stannard; a tenor solo by Mr. Sturtevant; contralto solo by Mrs. Ward; tenor solo by Mr. Vinal; harp solo, "The Last Rose of Summer," by Mme. Murray. The latter was so warmly encored that the lady responded with another pleasing melody. Miss Stannard then rendered a solo in a most acceptable manner, and Mr. Vinal concluded the musical treat with a tenor solo. All the numbers were of a high order. The soloists tendered their services without remuneration, and felt amply repaid by the warm appreciation of the auditors. Mr. G. J. Corey, manager of the Pairpoint Mfg. Co., directed the entertainment and introduced the soloists.

At the regular monthly meeting of the Chicago Jewelers' Association August 1st, a communication from the New York Board of Trade and Transportation was read.

**PARSONS : SCHOOL**  
—FOR—  
**WATCHMAKERS,**  
**PEORIA, ILL.**

Send for Circular and Terms.

**PARSONS & CO.**

together with a copy of resolutions regarding the Sherman Silver law, requesting action by the Association upon the same. On motion of F. A. Hardy, seconded by Benj. Allen, the following resolution was adopted and copies of the same ordered sent to the New York Board of Trade and Transportation, and to the Illinois representatives in Congress :

*Resolved,* That the present lack of confidence in financial and mercantile circles is due in part to the inflation of credits and to our present monetary system.

*Resolved,* That the experiment of compelling the government to purchase 4,500,000 ounces of silver monthly has had a fair trial and has proven to be a detriment to all commercial interests and has created distrust at home and abroad.

*Resolved,* That the Chicago Jewelers' Association requests Congress to repeal, at the coming session, the compulsory silver purchasing sections of the Sherman law.

*Resolved,* That frequent changes of the financial policy and of the monetary system of the country when conceived and enacted for political purposes be condemned as a sin against the nation.

It was decided not to send delegates to Washington to attend the convention of commercial bodies to meet in that city about Sept. 1st.

H. M. Lanc, manager for Reed & Barton; has been confined to his home for a week by illness.

Wm. Arnold, of Ann Arbor, Mich., always cordially greeted by Chicago jobbers, is in the city.

C. M. Bryant has been engaged to take charge of books in the office of G. A. Webster and E. G. Webster & Son.

Jacob Muhr is again with us, but between shaking hands and business the Fair was relegated to the position of a side issue.

E. V. Goodman, from the escapement works of the Waltham factory, left the 29th ult., after fourteen days of enjoyment at the park.

"I cannot say there is a general betterment, but collections are a trifle easier and there is a brighter outlook."—Mr. Spencer, B. F. Norris, Aliston & Co.

"It requires six full months to see it," said J. F. Schmitt, of St. Louis. "The Fair is great in every respect." Mr. Schmitt regards the Plaisance as an attractive adjunct.

Horatio Bonestell, of the California Jewelry Co., San Francisco, one of the most active of the young business men of that city, finds time for World's Fair pleasures.

The meeting of the Retail Watchmakers and Jewelers' Association of Illinois, to have

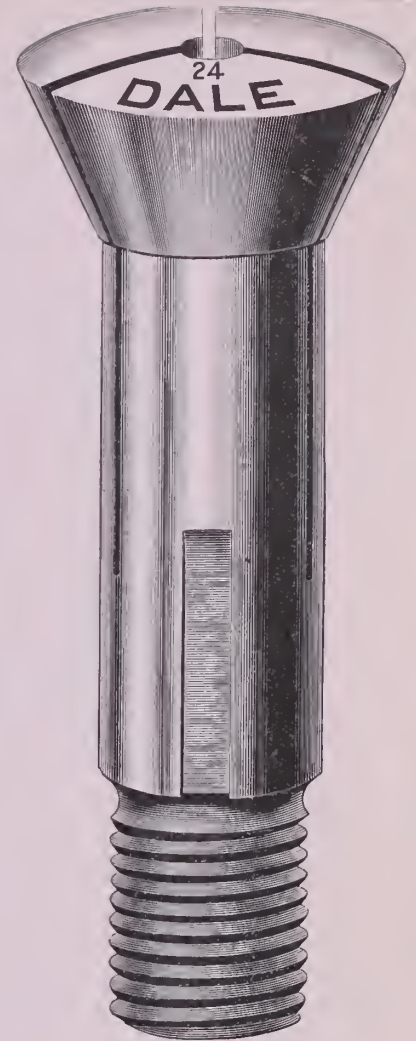

THE CELEBRATED  
**DALE CHUCKS**  
For Watchmakers' Lathes.

**Horological Tool Co.,**

MANUFACTURERS,

Office, 86 N. Clark Street, }  
Factory, 1036 Lincoln Ave., } **CHICAGO.**

FOR SALE BY JOBBERS.

**THE PLANCHAMP & BECKER CO.**

Makers and Repairers of

**WATCH CASES,**  
Gold and Silver Plating —

— of Watch Cases a Specialty.

UNEXCELLED FACILITIES.

63 and 65 East Washington St.. Chicago.

**GIBSON HOUSE,**

CINCINNATI, OHIO.

**ABSOLUTELY FIRST-CLASS AMERICAN PLAN HOTEL. \$3.00 PER DAY**

Extra Charge for Parlors and Rooms with Bath attached. The unequaled advantages in central location, liberal management, modern appointments, experienced service and perfect cuisine, have permanently established the Gibson House as **The Most Popular First-Class Hotel in Cincinnati.**

AMPLE VAULTS FOR THE PROTECTION OF VALUABLES

**THE GIBSON HOUSE CO.,**

H. B. DUNBAR,

President and Manager.



# FLY BACK AND SPLIT SECONDS,

**ACCURATE  
AND  
RELIABLE.**



**PRICES  
MODERATE.**

**IN SILVER, FILLED AND GOLD CASES.**

**A. WITTNAUER, Manufacturer and Importer,  
19 MAIDEN LANE, NEW YORK.**

## BLANCARD & CO.,

LATEST ROCOCO DESIGN IN GALLERY.

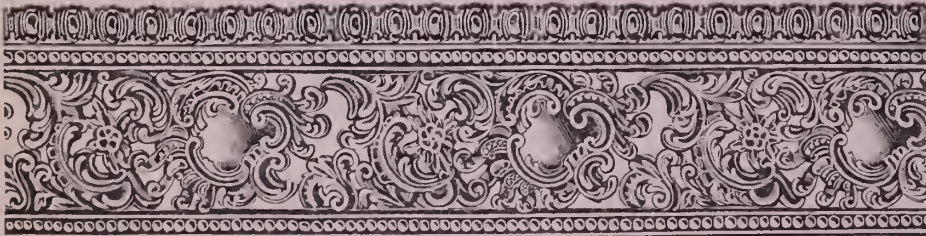

DIAMOND SETTINGS. GALLERIES. HOLLOW BALLS, ETC.

SEND FOR OUR CATALOGUE.

**45 & 47 John St., New York.**

**Enterprising Jewelers Catch On!**



OBVERSE



REVERSE



BACK

**Jewish Sheckel, Masonic Mark or Pocket Piece.**

THE LATEST AND BEST SELLING NOVELTY.

The mark is struck in coin silver; by using either the obverse or reverse of the coin, the back being the same in either case, and permitting of the purchaser's name, blue lodge, chapter and individual mark, with date of same being engraved thereon, as shown in cut above.

Price, without engraving, ONE DOLLAR. Engraved Mark, Dates, etc., 75c. EXTRA.

Liberal Discount to the Trade.

**CHAS. G. WILLSON, MANUFACTURING JEWELER, READING PA.**

been held Aug. 3rd, resulted in no quorum and was adjourned to Thursday, Aug. 10th.

Col. J. F. Turner, auctioneer, has returned from Guthrie, O. T., after a sale in that city. The colonel is now taking a vacation and filling his dates for Fall and Winter sales.

The western office of the United States Watch Co., Waltham, Mass., at 311 Venetian building, reports country order trade picking up, most of the orders being for assortments.

The Algerian & Tunison Jewelry Co. has been incorporated at Chicago with a capital stock of \$2,000. A general jewelry business will be conducted. The incorporators are Eugene I. Munzer, Sidney Adler and A. Bohnen.

In a few days J. W. Forsinger, general watch inspector for the several railway lines formerly controlled by Giles Bro. & Co., will be established in permanent quarters. At present he has temporary quarters with Giles Bro. & Co.

Talks with leading jobbers indicate that travelers from eastern factories should reach Chicago from Aug. 20th to Sept. 1st. Jobbers generally will buy light owing to the uncertainties as to Fall trade, and prefer to duplicate orders if found necessary.

M. Goldsmith returned Monday week from a pleasurable fishing excursion at Irish Lake, ten miles from Warsaw, Ind. He would have stayed longer but feared he would clear out the lake, and returned to give his brother a show. Bass casting is Mr. Goldsmith's strong forte, ranking only second to his knowledge of reducing old gold and sweeps.

A. L. Sercomb, manager Meriden, Britannia Co., and family are at Hartland, Wis. for a couple of weeks on their annual Summer outing. On Manager Sercomb's return C. P. Dungan will leave with a party of friends to look for muscallonge in Northern Wisconsin lakes. J. W. Meacham, manager of credits for the firm, has returned from New York and Meriden.

G. A. Jewett, of this city, has been appointed manager of the New Haven Clock company's western business, succeeding E. F. Strickland, who has returned to his home in Benton Harbor, Mich., to engage in other business. Mr. Jewett has been with the clock company eleven years, starting as office boy.

### Nemitz Comes Back and Explains.

CHICAGO, Ill., Aug. 4.—Henri Bertrand Nemitz, whose sudden departure to Canada and subsequent return to this city after his arrest there, deeply stirred the Swiss exhibitors at the World's Fair, arrived here from Toronto on Monday last, in company with Attorney Richberg and Detective Daurice and proceeded at once to the World's Fair grounds. Attorney Richberg led the way to Captain Bonfield's office. The attorney only desired to hand his



prisoner over to the police authorities. He did not care whether Nemitz was placed under bonds to appear, as the Swiss exhibitors would be amply indemnified by the money taken from their agent in Toronto, should he feel inclined to disappear again. There was a long wait at the service building, but Assistant-Chief Gross finally appeared, and after a conversation with Mr. Riechberg and the detective, he allowed Nemitz to go.

"You are under my charge," he said to Nemitz, "but you may go home. You must appear at this office Monday morning at 9 o'clock." Mr. Nemitz went at once to the residence of a friend at 7024 Jefferson Ave., where he intends to stay until everything is settled.

"I am innocent," he said. "M. Perrenoud has annoyed me, quarreled with me and put obstacles in my way ever since he came to Chicago. I came here a year before he did, did all the work and then he wanted all the credit for it. I was willing to let him have it, but he would not leave me alone. He says that I have sold \$9,000 worth of goods and that I received \$3,000 on account. That is true, but I have sent nearly all the money to those men who employed me. I have receipts for the money. The watches found in my possession are my own, as I can prove. The Swiss exhibitors at the exposition held in London in 1891, presented them to me."

When Nemitz was asked why he left Chicago before the arranged investigation could be made with his accounts he said:

"I did not leave suddenly. I told Consul Holinger that the doctor had ordered me to take a rest, and that I was going out of town. I sent the combination of the safes to M. Rouge last Saturday, and told him I was going away. My health is completely broken down, and I intended to return to Switzerland shortly. I was afraid that Commissioner Perrenoud was going to bring that old charge against me of violating the customs laws. It is absurd to charge me with taking any jewelry from the Swiss exhibit. I had no idea that any had been missing. I went to Toronto and registered in my own name. That does not look like the action of a guilty man."

Attorney Riechberg, who accompanied Mr. Nemitz back from the Queen's dominions, previously expressed to James Perrenoud, the Swiss Fair Commissioner, \$25,000 in securities and money taken by him from Nemitz. The case will be pushed by Mr. Nemitz, who demands a full investigation by the police.

CHICAGO, Ill., Aug. 6.—Special Treasury Agent Crowley has seized about thirty watches, which were turned over to the Swiss consul by Nemitz on his return from Canada. It is believed that these have been smuggled into the country, and until further investigation is made they will remain in the custody of the government.

Commissioner Perrenoud said yesterday that he did not think the case would come

to trial, as he expected a satisfactory settlement. A re-inventory shows but five watches and six pieces of jewelry missing, valued at about \$1,400.

#### Burglars Visit a Chicago Optician.

CHICAGO, Ill., Aug. 5.—The store of Louis Manasse, 88 E. Madison St., was entered by burglars a few nights ago and optical goods valued at nearly \$1,500 were carried off.

So far the police have failed to arrest any of the thieves. The plan of the raid was evidently laid with a perfect knowledge of the ground and the actions of the night-watchman in the neighborhood. The burglars sneaked into the building and secreted themselves in a janitor's apartments until after midnight. They then attacked the grating of the small window in the rear of the store. Once the bars were severed it was an easy matter to pry the window open. Then they leisurely selected the most valuable and portable goods. A big grip was emptied of its contents, as was a kodak, and into these the burglars crammed all the valuables they fancied. Among the goods taken were two hundred gold-rimmed spectacles, a whole sackful of Columbian souvenir half-dollars and an assortment of pearl and gold-mounted opera-glasses. The cash-drawer was broken open and \$53.50 taken from it.

#### Morse, Mitchell & Williams Make an Assignment.

CHICAGO, Ill., Aug. 6.—Morse, Mitchell & Williams and F. E. Morse & Son, could not secure sufficient money from sales in business to meet indebtedness and Elbert H. Gary took possession on Monday last as assignee. An inventory and examination of accounts is now in progress, and until this is completed Mr. Morse told the creditor's representatives he would be unable to give figures of assets and liabilities. Morse, Mitchell & Williams are the Chicago representatives of the E. N. Welch Clock Co. and the latter is the heaviest merchandise creditor. The firm are interested in Chicago real estate, some time since purchasing a tract of land for \$120,000, which they called Mitchell's Park. Nearly half of this property has been sold and extensive improvements made on the property on the unsold portion, the property now representing an investment of \$160,000 on which there is an indebtedness of \$30,000. F. E. Morse & Son started in business as diamond importers in 1880 and were recognized leaders in this line. No statement of liabilities has been rendered. It is understood that Morse, Mitchell & Williams had advanced considerable money to the diamond house. Among New York creditors are L. Strasburger & Co. interested to the amount of \$11,000; E. Karelsen, \$1,000; Alfred H. Smith, \$450, and Lewis, Kaiser & Luther for an amount approaching that of Strasburger. Mr. Morse purchased his son's interest last February and was the sole owner. "Our design and purpose was to close up every-

thing every month," said Mr. Morse, "and we have not to exceed eighteen creditors in both firms. I have turned in all my personal property and realty, the latter in mortgages to secure loans at the banks."

#### A Receiver for the Du Laney Clock Co.

CHICAGO, Ill., Aug. 5.—In a bill of complaint filed by Edward R. Stettinius against the Du Laney Clock Co., the plaintiff states that the defendant company is indebted to him in the sum of \$475, for money advanced; that suit was brought by the Masonic Temple Association for \$116 for rent due, on which judgment will be obtained; that there are claims outstanding against the company in this county amounting to about \$1,500 in addition to above claims, and that the company is insolvent; that the assets in this county are \$1,000 worth of clocks and book accounts for clocks taken on trial amounting to about \$2,000, which may or may not be collectable; that July 14th a receiver was appointed for the company's plant at Valparaiso, Ind. The plaintiff therefore asks that a receiver be appointed. In answer, the Du Laney Clock Co. admits the substantial correctness of the assets and liabilities and admits its inability to pay its debts when they mature. It therefore asks for a receiver and asks that the receivership be continued until it is demonstrated whether it is best to sell out its stock or endeavor to arrange with creditors for a resumption of business. Frank P. Blair, Jr., was appointed receiver for the company's interests here. It is understood, however, that difference in the management, rather than matters of a financial nature, were the cause for the action taken.

#### Cincinnati.

O. E. Bell and family are at the Mineral Springs, in Adams County.

Cincinnati is to have the next retail jewelers' convention, and her jewelers promise a grand reception.

John Holland and family are at the World's Fair this week. J. E. Holland, eldest son of John Holland, is home from Harvard University spending his vacation.

J. T. Harrison, attorney for the fifty-five Providence and Attleboro creditors of Strauss & Stern, received a communication from them to-day accepting the last proposition, 12½ per cent. cash Sept. 1st and 12½ per cent. Jan. 1st.

Gustave Fox & Co. caused the arrest of Wm. Maas, a Central Ave., pawnbroker, charged with stealing a pair of valuable diamond eardrops valued at \$250. The broker produced the gems and begged to be released. When his trial came up this week, the firm did not appear against him and his case was dismissed.

R. Edelman, formerly of Minneapolis, has opened a jewelry establishment at 324 W. Superior St., Duluth, Minn. The firm name is the "Standard Jewelry and Loan Office."

### News Gleanings.

J. Cohen, Leadville, Col., has sold out.

John Stallings, Duncan, I. T., has sold out.

Elmer C. Woodworth, Boston, Mass., has assigned.

W. E. Garretson, The Dalles, Ore., has assigned.

Joseph W. Dupont, Minneapolis, Minn., has assigned.

A. M. Reeves, Norton, Kan., has sold out his business.

Fannie Hessel will give up her store at Mendon, Mich.

The death occurred of George Knox, Cambridge, Vt.

The assignment is reported at South Fork, Pa., of C. A. Rashow.

L. M. Wagner, Los Angeles, Cal., has been attached for \$11,500.

J. Gentner, Jr., Buffalo, N. Y., has given a realty mortgage for \$300.

A. Goldringer, Buffalo, N. Y., has given a chattel mortgage for \$17.

George A. Bittroeff has opened a store at 521 Main St., Evansville, Ind.

The stock of T. B. Grimm, Sharpsville, Pa., has been sold by the sheriff.

The store of J. M. Murray, Hopewell, N. J., was destroyed by fire last week.

W. A. Lawrence has removed from 29 Lake St. to 8 Lake St., Buffalo, N. Y.

M. P. Jenks, Meadville, Pa., made an assignment last week to Thomas Roddy.

The store of S. More, Huntington, W. Va., was closed by the sheriff last week.

Mrs. J. W. Cameron & Co., Malone, N. Y., have given a chattel mortgage for \$6,000.

The marriage is reported at Chillicothe, O., of O. J. Fuchs to Miss Minnie Barman.

W. T. Leckie, Dowagiac, Mich., has sold out to G. E. Harkman of Randolph, Wis.

The store of W. H. McDougal, Johnsonburg, Pa., has been closed under executions.

Henry Vandercoff has sold out his business at Montgomery, N. Y., and left for Minnesota.

Jas. F. Fitzmorris & Co., Marlborough, Mass., are reported to have made an assignment.

A judgment for \$256 has been entered against M. B. Swaner, Salt Lake City, Utah.

A destructive fire at Cloverdale, Ind., Aug. 1st, destroyed the jewelry store of C. E. Pickens.

The stock and fixtures of M. P. Jenk's store, Meadville, Pa., was sold at auction by the sheriff a few days ago.

John H. Meers, Hopewell, N. J., was burned out last week. His entire stock was destroyed. No insurance.

The store of W. L. Taylor, Table Rock, Ark., was entered by burglars last week and a small amount of jewelry was taken.

R. B. Green, Altoona, Pa., was robbed last week of a number of valuable rings. The thieves were caught and locked up.

Henry Warner, who robbed Sullivan Bros.' jewelry store in Devil's Lake, Minn., of valuables to the extent of \$800, has been caught.

Fred. P. Heathcote, an old and valued employe of the B. H. Stief Jewelry Co., Nashville, Tenn., died suddenly last week.

Edward Clarkson, of St. Louis, was arrested by the East Carondelet police a few days ago and fined \$25 for selling bogus jewelry.

C. Cohen, Huntington, W. Va., is under bonds of \$500 in an action for the recovery of goods bought by Henry Kohn & Co., Cincinnati, O.

A negro named John Cavendish is under arrest at Bellwood, Pa., charged with the larceny of three gold rings from the store of Green Bros.

The plant of the Anti-magnetic Shield Co., an asset of Giles Bro. & Co., has been sold by Receiver W. H. Gleason to Hiram Schneider for \$500.

Richard Krumpf, Portland, Ore., has made an assignment to B. Guggenheim. The assets are placed at \$1,000 and the liabilities at \$3,200.

The James H. Walker Co., Chicago, Ill., on Friday last confessed judgment before Judge Windes on a note for \$5,495.72, in favor of Edward Noa.

Robert Moore, Williamsport, Pa., had his foot badly crushed last week in a collision which occurred on the Illinois Central road, while visiting Chicago.

An unsuccessful attempt at shoplifting took place at the store of M. Schulze in West Mansfield a few days ago. Mr. Schulze's keen eyesight saved his property.

Burglars at Arcade, N. Y., a few nights ago broke into the store of H. W. D. English and secured a quantity of silverware, a lathe, chronometer and watchmaking tools.

August Burggraf, Johnstown, Pa., was arrested last week on the charge of larceny. It is claimed that he was given a watch to repair and failed to return it. He was held under \$500.

The police at Frenchtown, N. J., are investigating a concern which offers a year's subscription to a paper and a "magnificent diamond ring" all for the munificent sum of forty-six cents.

Barron Bacon, a lad in the employ of W. F. Banks, Bridgeton, N. J., is under arrest for disposing of his employer's goods in exchange for teams with which to go driving with his best girl. He has confessed.

Wm. Gardner, Patterson, N. J., together with his wife and four months old baby were frightfully burned at their home last week by an explosion of benzine. Gardner and his wife will recover but the baby will die.

The reported assignment of Ingersoll & Sheppard, Carbondale, Ill., is denied in toto

by the firm, who say there is not the slightest foundation for the rumor, as they have made some money even in the present hard times.

April 1st the jewelers of Shelbyville, Ind., together with the other retail merchants agreed to close at 6 p. m. during the Summer months, but found such an alarming decrease in their business that they decided to return to the old hours.

The New York Jewelry store, New Orleans, La., is being investigated by the police of that city on the complaint of Mrs. B. Brown, who claims that two watches sold her as gold, at \$4.50 and \$3.00 respectively, had proved to be not as represented.

Jos. M. Geist, Duluth, Minn., is building an addition of thirty feet at the rear of his store, his intention being to open an art and cut glass department therein. Mr. Geist has handled goods of this class for a number of years, but his trade has constantly increased.

The Suffolk Dial and Enameling Co., of Sag Harbor, N. Y., has been incorporated with a capital of \$15,000. The directors are: Wm. C. Eaton, Luans Palmer, Frank B. Glover and J. J. Harrison, of Sag Harbor, and Charles A. Pierson, of Bridgehampton.

### Connecticut.

The Waterbury Clock Co.'s factory reopened last Monday after a week's shut down.

W. A. Beach, Litchfield, has made an assignment. Mr. Beach started in business about Dec. 1st of last year.

Gilbert Rogers, of C. Rogers & Bro., Meriden, has been appointed administrator on the estate of the late Mrs. W. E. Rogers, of that city.

George Bennett, of Bridgeport, a jeweler by trade and for many years a clerk at Parker & Davis' jewelry store in that city, died July 27th.

The annual meeting of the stockholders of the Gilbert Clock Co., Wooster, was held Wednesday afternoon. The old board of directors was re-elected for the ensuing year. No dividend was declared.

Frederick J. Breckbill, of Breckbill & Marsh, Bridgeport, has received his appointment and commission to be adjutant of the First Battalion, Fourth Regiment, C.N.G., with the rank of first lieutenant.

The Holmes & Edwards Silver Co., Bridgeport, has filed a certificate of increase of capital from \$300,000 to \$400,000, \$50,000 of which increase of capital is to remain as treasury stock. The increase of \$50,000 has been paid in cash.

The store of Legrand Jackson, Norwalk, was visited by two thieves a few days ago. One, while looking at goods, secreted a valuable pair of earrings in his clothing. A friend of the jeweler standing near saw the theft, and the thief was compelled to disgorge.

# THE "SANDRINGHAM"

PATENTED JANUARY 24TH, 1893.

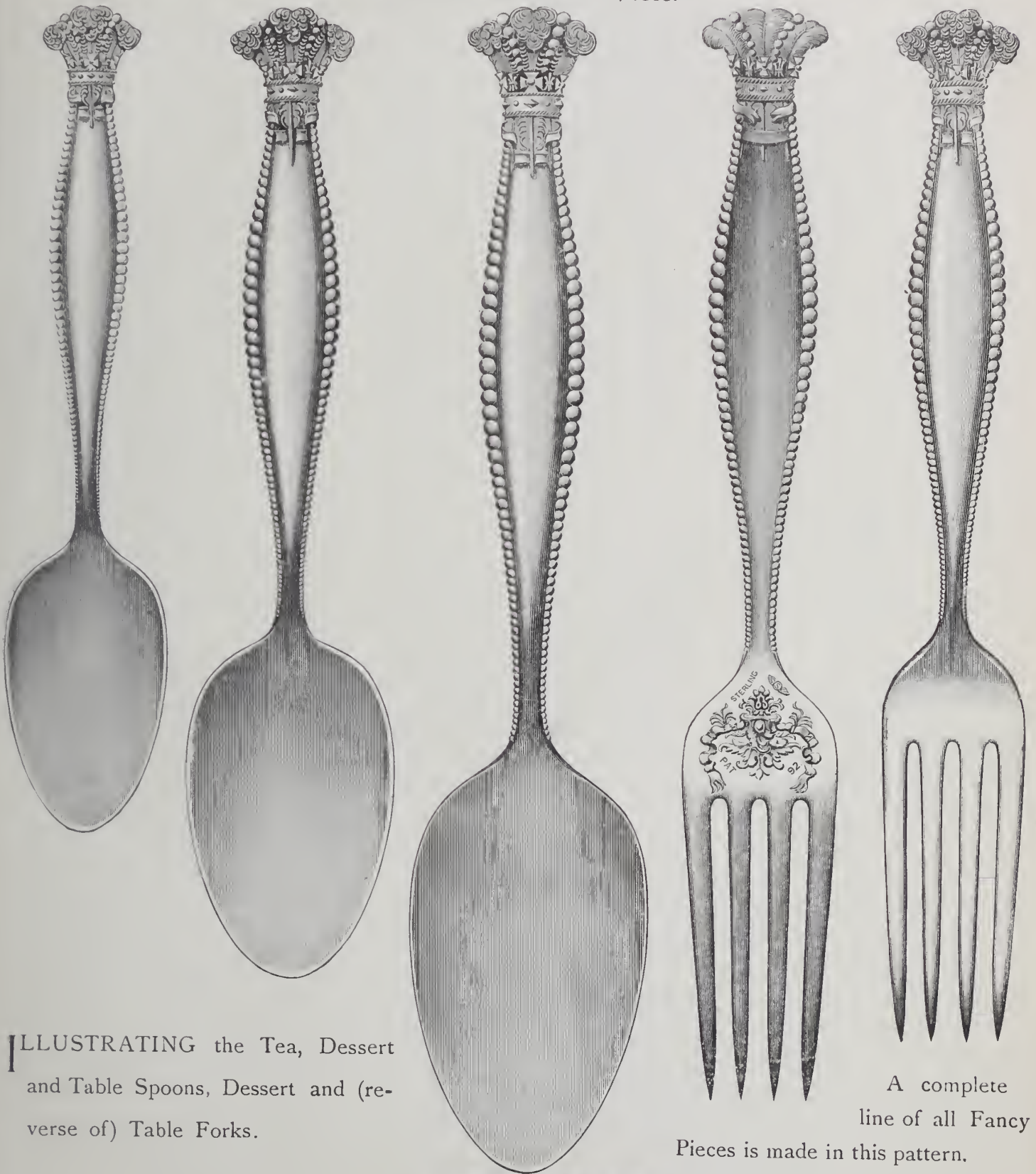

ILLUSTRATING the Tea, Dessert and Table Spoons, Dessert and (reverse of) Table Forks.

A complete line of all Fancy Pieces is made in this pattern.



Geo. W. Shiebler Co., Of the Silversmiths' Company, 179 Broadway, N. Y.

CLASSIFIED INDEX TO ADVERTISEMENTS.

All Advertisements are entitled to one insertion under proper heading. Extra insertions, \$6.00 per annum. Extra Headings, \$12.00 per annum.

Table with 3 columns: Category, Name/Address, Page. Categories include Aluminum Solder, Art Pottery, Auctioneers, Assayers & Refiners, Badges, Medals, Etc., Chains, Seamless, Chrome Steel, Clocks, Cut Glass, Diamond Cutters, Diamond & Precious Stone Importers, Engravers & Designers, Fine Stationery, Fountain Pens, Gold and Silver Plating, Gold Jewelry, Horological Schools, Hotels, Imported Clocks, Bronzes, Etc., Jewelry Mailing Boxes, Jewelry, Silverware and Optical Cases, Jobbers, Watches, Diamonds, Etc., Musical Boxes, Optical Goods, Pens, Pencil Cases, Etc., Patents, Rolled Plate Jewelry, Ring Makers, Sample Trunks, Settings and Galleries, Silver Plated Ware, Sterling Silverware, Thimbles, Tool Manufacturers and Dealers, Trunks and Traveling Bags, Umbrellas, Watch Case Manufacturers, Watch and Clock Dials, Watchman's Clocks, Watch Importers, Watch Keys, Watch Repairers.

## Special Notices.

Rates 75c. per insertion for notices not exceeding 3 lines (25 words), additional words 2 cents each. If answers are to be forwarded, postage stamps must be enclosed. Two insertions, 15 per cent. off; three insertions, 20 per cent. off; four insertions or more, 25 per cent. off. Payable strictly in advance. Display cards on this page will be charged at \$2.00 per inch for first insertion, subject to same discount as above for subsequent insertions.

Under the heading of **Situations Wanted** on this page advertisements will be inserted for **One Cent a Word**. This offer refers to **Situations Wanted only**. Payable strictly in advance. If answers are to be forwarded, postage must be enclosed.

## Situations Wanted.

Notices under this heading **ONLY** are charged at one cent a word, payable strictly in advance. If answer are to be forwarded, postage must be enclosed.

**POSITION** as salesman, Retail jewelry or silverware. Experienced. References. Address, "F," care, JEWELERS' CIRCULAR.

**WANTED**—Permanent position desired as stenographer and typewriter; \$10 per week. Apply to present employers, Sinnock & Sherrill, 21 Maiden Lane.

**SITUATIONS WANTED**.—Position, by reliable young man, as improver. Three years' experience at watch, clock and jewelry repairing and as salesman. Set of tools, first-class reference. Address, Box 249 Castleton, New York.

**WANTED**—A watchmaker, engraver and salesman, sober, industrious and A1 workman, would like a position with a first-class jewelry firm by Sept. 1st. Address, stating salary, "Business" B, care JEWELERS' CIRCULAR.

**YOUNG MAN** would like a position at once in New York or some adjoining State, as watch and fine clock repairer. Address F. C. N., Yonkers, N. Y.

**SITUATION WANTED**.—An experienced traveler wishes a position in a first-class house. Many years on the road and well acquainted in all sections east of Omaha. Diamond house preferred. Address E. D., JEWELERS' CIRCULAR.

**POSITION** Sept. 1st.—By watchmaker, four years' experience at bench. Owns tools, A1 reference. Address, Box 377, Homer, N. Y.

**BY WATCHMAKER** with seven years' experience. Fair engraver. Wages \$15 per week. Will furnish my own tools and good reference. None but good houses which can furnish steady position need apply. Address "Staff," care JEWELERS' CIRCULAR.

**ENGRAVER AND SALESMAN**.—First-class man with A1 references desires a situation in a large jewelry store. Good all round workman. New York or Brooklyn, Middle or Eastern States preferred. Address Mizpah, care JEWELERS' CIRCULAR.

**WANTED**—By a young man 22 years of age, a position to represent a manufacturing jeweler or precious stone house in the city or on the road, or position in office. Reference unquestioned. Long experience in the business. H., care of JEWELERS' CIRCULAR.

**WANTED**—Position as first-class watchmaker; experience and constant practice of over twenty years in English and American watchmaking and in all fine and complicated work; competent salesman; references and tools; age, forty-five; not jewelry repairer or engraver. E. H. Sheriff, 136 Elm St. Newark, N. J.

**POSITION** wanted by young Swede as watchmaker and clock repairer; three years' experience; speaks English; own tools; best references. Address Mechanicsville, N. Y. Lock Drawer No. 6.

**SITUATIONS WANTED**—I desire a position as watchmaker, jeweler and optician, or to travel with optical goods, jewelry or silverware. References. Address Watchmaker, Box 592, Ware, Mass.

**WATCHMAKER**—Young man (26) desires permanent situation in New York or vicinity; is first-class workman and has A No. 1 recommendation. Address O. M. X., care JEWELERS' CIRCULAR.

**A GRADUATE OPTICIAN** who is thoroughly competent desires a permanent position by Sept. 1st. Will furnish best of references. Address Optician, B 31 State St., Saratoga Springs, N. Y.

**YOUNG LADY**, four years' experience, desires position in optical store, Philadelphia, as bookkeeper and saleslady. Has done some fitting. Fully competent, understands the business. M. 18, care JEWELERS' CIRCULAR.

**FINE WATCHMAKER** and jeweler would like position by Sept. 15th. Good references, own tools, sober. Texas or adjoining States preferred. Salary \$18.00. Address "Texas," care JEWELERS' CIRCULAR.

**SITUATION**—First-class American watchmaker. Fine engraver. Married. Good address. Twenty-five years' experience. Fine bench, American lathe. Bench tools. Neat, profitable, reliable. A1 references. Address "West," care JEWELERS' CIRCULAR.

## Help Wanted.

**WANTED**—Experienced traveling salesman to carry a leading and well-known line of spectacles and eye-glasses; samples easily carried; liberal commission. Address Optics, care JEWELERS' CIRCULAR.

**WANTED**—A Salesman for Jewelers' and Machinists' Tools and Supplies. Must have a good trade following. No attention will be paid to applicants not having above qualifications. Address Salesman, JEWELERS' CIRCULAR, N. Y.

**WANTED**—A practical jeweler and designer to take charge of a factory in an old established business. To a man with some capital an interest in the business will be given. Address, A. J., care JEWELERS' CIRCULAR.

**WANTED**—Line of A1 goods on commission in this and neighboring territory. Can do good for somebody. L. 927 Western Ave., Topeka, Kan.

**WANTED**, for an old established business in New York city, an optician to take charge of optical department. Must be of good appearance. One speaking German and English preferred. Or would dispose of same to responsible party on easy terms. Address "Optician," care JEWELERS' CIRCULAR.

**WANTED**—An A1 watchmaker and engraver, at once. One that can take charge of a bench. Steady work and good wages to the right man. We don't want any graduate from Watchmakers' Institute. Address A. H. Furstnow & Co., Fond du Lac, Wis.

**WANTED**—By a wholesale Maiden Lane firm, an intelligent well educated boy living with his parents, to do general office work. One that has had some experience in the watch line preferred. Will receive advancement if satisfactory. Best references required. Address by letter. L. W. C., care JEWELERS' CIRCULAR.

## For Sale.

**A GENTLEMAN** advanced in years owning a jewelry, fancy goods and stationery store situated in a city near Boston, is desirous of disposing of the same, which, since its establishment by him in 1847 has done a successful business. An exceptional opportunity for a bright, energetic man, as he would start at once on a paying basis; best location in city; competition light. Address Cyrus N. Gibbs, South Framingham, Mass.

**FOR SALE**—An electric engraving machine; in good order, with three fonts of type; also battery. Or will exchange it for jewelers' rolls. W. T. Volger & Son, 234 Main St., Winston, N. C.

**FOR SALE**—A first-class jewelry store, established fourteen years, where stock and fixtures costing \$4,500 can be secured for \$2,500, or, if desired, can give lease of store with fixtures and sell stock for \$1,500, one thousand dollars cash and balance on easy terms. Bench work alone amounts to over \$1,800 yearly. The location of the store and profits of the business will stand thorough investigation. Address Frank C. Kibby, No. 366 Broadway, N. Y.

**LAKEWOOD, N. J.**—Farm for sale or exchange for first-class jewelry store or diamonds; a home and productive farm, in splendid order. Principals only address P. O. Box 29, Delhi, Delaware Co., N. Y.

**THE fixtures, safe, benches and all complete for a jewelry store.** A fine opportunity for some one desiring to start in business here. At a bargain, if sold at once. Fixtures still intact in store. Address F. H. Rabe, South Bend, Ind.

## Miscellaneous.

**I BUY JEWELRY STOCKS**—Manufacturers, jobbers and retailers desiring to dispose of surplus or entire stocks of diamonds, watches and jewelry can find quick cash buyer by addressing Stephen S. Harmon, 134 East 90th St., New York city.

## DEMAGNETIZING.

**PERFECT WORK**—Watch repairing in all its branches; all work warranted. Winslow & Penney, 608 Masonic Temple, Chicago.

**FOR FIRST-CLASS INSTRUCTION** in watch work go to W. F. A. Woodcock, Winona, Minn.

**AN unmarried man** to work on shares (one-half) in a village repairing establishment. Enclose stamp if reply is desired. Address Box 37, Smithville, Va.

**BUSINESS OPPORTUNITY**—Good stand for repairing watchmaker and jeweler to rent at Yonkers, N. Y., \$25 per month. Address G. P. Reeve, Yonkers, N. Y.

**\$1500 WILL** buy stock, safes, fixtures and good will of a well-established jewelry business in a growing town, county seat, of West Texas. No competition. Address E. G. Shorsh, Sweetwater, Texas.

**HARD soldering** made an easy task for anyone. Guaranteed the best and cheapest thing or money refunded. 50c. F. L. Wells, Marion Center, Pa.

## To Let.

**TO LEASE**—A Game Preserve in the Adirondacks. Plenty of Deer and Trout. Address Chas. Heaton, Jeweler, Potsdam, N. Y.

**Headquarters** FOR **ELECTRIC & PORTABLE Watchman's Clocks** Price, Complete \$10.00



Lowest Prices. Latest Improvements. Patents 1886-1893. Send for Circular. **E. O. HAUSBURG,** 41 Maiden Lane, New York. THE "ALERT."

**SOLICITORS OF AMERICAN & FOREIGN PATENTS** SEARCHES MADE & INFRINGEMENTS PROSECUTED OR DEFENDED

FOR **DESIGNS INVENTIONS & TRADE MARKS** PATENTS THE TRADE WILL SAVE TIME AND MONEY BY HAVING THEIR PATENTS TAKEN BY **COX & SONS 11 PARK ROW, N.Y.**

**PAWNBROKERS' SALES** BY **S. FIRUSKI & SON,** AUCTIONEERS, 85 Bowery, New York, AT 11 A. M.

See **N. Y. Herald** for full particulars of Sales. The Trade is Respectfully Solicited to Attend.

Queen & Co., Philadelphia, Pa., report an unusually heavy business in their special order and Rx department for July and an equally encouraging outlook for August. Their travelers are all out and have taken some unusually large Fall orders. A complete stock, low prices and prompt delivery are responsible for this favorable report.

**Philadelphia.**

Sheble & Clem, Frankford, has shut down for two weeks owing to dullness in trade.

Louis Fowler, No. 706 Chestnut St., has just completed engraving the silverware for the United States Cruiser *New York*.

The police last week raided the itinerant jewelers on Market St. A number of them were held in \$300 bail each for obstructing the highway.

Frederick H. Voigt, 118 S. Seventh St.; Robert Leusch, 2059 N. Front St., and Simon C. Levy, 1817 Ridge Ave., have returned from visits to the World's Fair.



AMERICAN RAILWAY SUPPLY CO. 24 Park Place, NEW YORK.

Clarence L. Weylmah has made an extension to his store at 1508 Columbia Ave.

C. R. Smith & Son last week threw a glaring red-lettered canvas sign across their Chestnut St. front reading as follows: "In order to raise \$25,000 to make cash payments to our creditors, we will make a 20 per cent. reduction on all sales for the next thirty days. Everything reduced."

A well dressed young man entered the jewelry store of Hugo Watson, 4344 Main St., Manayunk, on Thursday last, and asked to be shown some rings. He left without buying, and afterwards Watson missed a ring valued at \$11. The police were notified, but the thief was not arrested.

The police have under arrest a man who gives his name as William G. Adams, and says he is an agent for Shoneman & Bros. at Eighth and Arch Sts. The authorities, who took their man while he was endeavoring to sell some jewelry in Camden, believe that they have one of the thieves who have recently preyed upon the goods of jewelers in that city. To Justice Pane, Adams said he had obtained the jewelry from a stranger in a buggy.

**Boston.**

E. A. Whitney's composition offer to his creditors has been confirmed by the Court.

On the 1st of August the E. Howard Watch & Clock Co. declared a semi-annual dividend of three per cent.

Treasurer Thomas A. Tripp, of the Pair-point Mfg. Co., called on his friends in the Boston trade during the week.

The police have in custody George B. McClellan and Fred. L. Morton, charged with the larceny of a lot of diamond jewelry. The men have in their possession a lot of sleeve buttons, pins, etc., for which owners are wanted.

Eugene C. Record, clerk for Harwood Bros., and prominent in athletic circles, distinguished himself at the L. A. W. midsummer meet at College City by taking first prize in the swimming match and a silver medal in the bicycle events.

At a meeting of the creditors of E. C. Woodworth, Tremont St., near the corner of Eliot Street, who has assigned to D. C. Percival, Jr., and George L. Elliott, the statement submitted showed the assignor's liabilities to be about \$9,000 and his assets \$5,000.

In conversation with two of the leading jewelers in the Boston jobbing trade this week, your correspondent was informed that the volume of trade in each of their establishments was larger for 1893 to date than for the corresponding period in 1892. They agreed that croaking was out of the question under these circumstances.

Henry W. Patterson is in Montreal, at the Canadian branch of Smith & Patterson's establishment this week. His Summer cottage is at Hull, but within a week Mr. Patterson has purchased a handsome residence on Newbury St., in this city, which will be refitted and furnished as his Winter home by the time the outing season is over.

The Summer outing of the Boston Jewelers' Club will take place Aug. 26th. President Charles F. Morrill, of the club, has placed the flagship *Navarch* at the disposal of the members, and a trip to the Hull Yacht Club headquarters, where dinner is to be served, will be followed by a run to Marblehead Neck and a visit to the Corinthian Yacht Club's house there.

The vacation list in the Boston jobbing trade is a long one this week. Among the Chicago tourists are: O. C. Dow; Engraver Wallace, of George Richards, Jr., & Co.; F. W. Ruggles, Robbins, Appleton & Co.'s watchmaker. Of Smith & Patterson's force—Alexander Grimes is at Bradford Springs, F. H. Elliott and G. H. Stanford are in Maine, C. W. McLaughlin is out west, A. A. Abbott, Fred. Mansfield and Ed. Carlton are rusticating in Canada; H. E. Pitcher and Carl Smith are in the Granite State, and A. K. Smith has been doing Cottage City. Miss Bertha Gould, bookkeeper for Charles May, is at Lake Winnepesaukee. E. G. Pierce is at Claremont, N. H.

**PIVOT DRILLS THAT WILL DRILL.**

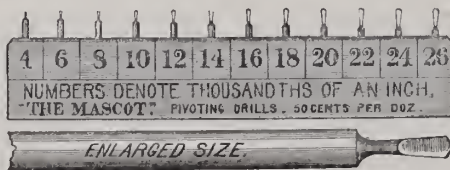

The Mascot is the best made Pivot Drill in the world. This is a strong assertion, but it is justified by the quality of the drills.

The following unsolicited testimonial would also seem to warrant our assertion:

MESSRS. EZRA F. BOWMAN & CO., LANCASTER, PA.:

Gentlemen—I am in receipt of your Mascot Pivot Drills that I ordered on the strength of your statement in the May issue of the "Keystone." Having tried every so-called Pivot Drill that my attention was directed to, and meeting with dismal failure, I was naturally inquisitive to learn what your Mascot was capable of doing. I took a Seth Thomas Clock mainspring, and subjected six drills out of each dozen to the test of drilling twenty holes through without drawing the temper. Every drill stood the test and your claim in the "Keystone" is warranted by the facts.

Yours truly,

L. F. GIERING

Send by mail, postage paid, on receipt of 50 cents.

**EZRA F. BOWMAN & CO., Lancaster, Pa.**

**HOLMES & EDWARDS.**

**TWO THINGS.**



- 1st. STERLING SILVER INLAID SPOONS and FORKS.
- 2d. FANCY PIECES XIV. PLATE IN FINE LEATHERETTE SATIN-LINED BOXES.

Our latest effects in gilt-engraved bowls and blades are exquisite.

No ENTERPRISING Jeweler is without either of these two things. Correspondence solicited.

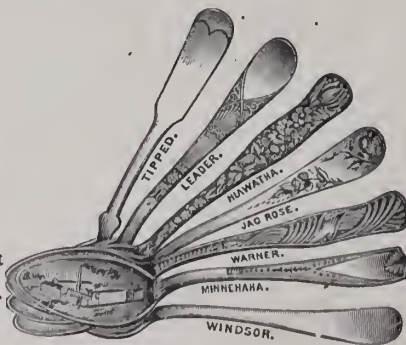

**Popular Patterns.**

Sterling Silver Inlaid Spoons and Forks are not by any manner of means the same as sectional plate. Solid pieces of pure silver inlaid in the back of the bowl and handle.

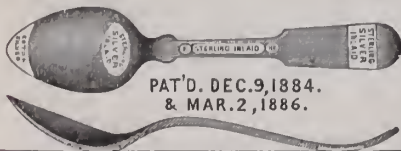

PAT'D. DEC. 9, 1884. & MAR. 2, 1886.

**HOLMES & EDWARDS SILVER CO., BRIDGEPORT, CONN.**  
New York Salesroom, 2 Maiden Lane.

**Pacific Coast Notes.**

Jarewski & Cohen, Portland, Ore., have failed.

William Robinson Crane has opened a new store in San Diego, Cal.

E. Meyborn has purchased the Empire Jewelry Store, Chico, Cal., from Hibbard & Sommers.

W. P. Stephens has sold his jewelry store in Los Angeles, Cal., to D. C. Holt, late of Alameda.

A. G. Farker, late of New York city, has decided to open a jewelry store in San Francisco.

Philip Jacobs, of Boston, Mass., is spending a few weeks in San Francisco, visiting his brother, Lewis Jacobs.

G. W. Shawler has retired from the firm of Shawler & Miller, jewelers of Pullman, Wash., and Mr. Miller now being sole proprietor.

F. Wansky gave a banquet to the firemen of Eureka, Cal., recently in recognition of their prompt services in saving his store from destruction.

An attempt was made last week to enter the store of George Ludwigs, at Walla Walla, Wash. The doors and windows were badly damaged by the burglars.

George W. Parker, a well-known jeweler of Ukiah, Cal., was shot and killed in a saloon row in that city recently. Citizens have raised a purse to prosecute the murderer.

**Minneapolis and St. Paul.**

The Keystone Jewelry Company, St. Paul, have discontinued business.

B. Pavian, St. Paul, in company with his brother, J. Pavian, with Benjamin & Co., of Minneapolis, started on the 1st inst. on a two weeks' visit to the World's Fair.

Donaldson & Co., of Minneapolis, in their jewelry department for several days last week conducted a clearing sale, and it is said sold goods below cost in order to reduce stock.

Joseph Dupont, Minneapolis, made an assignment to Robert Jamisson, on the 1st inst. Mr. Dupont states that his assets will reach about \$5,000.00, with estimated liabilities to the amount of \$3,000.00. He owes his bank \$1,500.00, Eastern creditors, \$1,800, and Mr. Dupont, senior, \$700.00. Mr. Dupont says he intends to pay one hundred cents on the dollar.

Later developments in the case of Jacob W. Loewenberg, the representative in St. Paul of the Chicago firm of F. M. Sproehle & Co., and now in jail charged by his employers with embezzlement, would show that the young man had been leading a double life. While rummaging among his effects a representative of the firm found an engraved copper plate and a package of cards which had been printed from it reading Baron Dunreath. When asked for an explanation Mr. Loewenberg is said to have replied that it was nobody's business. The investigation is still making.

**BIG RETURNS MADE FOR OLD GOLD AND SILVER.**

Check Forwarded 24 Hours After Receipt of Consignment

**RATHBONE & SMITH,**  
GOLD AND SILVER REFINERS, ASSAYERS AND SWEEPSMEITERS,  
Nos. 1 to 9 Matthewson St., Cor. Cove, Providence, R. I.

**Welded Chrome Steel and Iron**



FOR BUILDING

Jewelers' Safes, Vaults, Etc.

Positively BURGLAR PROOF, cannot be Cut, Sawed or Drilled.

WE are the only manufacturers of Chrome Steel in the United States. None genuine unless stamped with our Trade Mark.

**CHROME STEEL WORKS,**

KENT AVENUE, KEAP AND HOOPER STREETS, BROOKLYN, N. Y.



**MARTIN MAYER,**  
**Manufacturing Jeweler,**  
(MAINZ, Germany,)

FACTORIES: MAINZ, PFORZHEIM, FLORENCE, (ITALY).

Original Manufacturer of the well-known Cut Silver Articles.

*Silver Filigree, Coral Goods, Garnets, Turquoise, Pearl, and all other kinds of Jewelry. Silver Bric-a-Brac in Every Style, Silver Fancy Clocks, Souvenir Spoons.*

FIRST HAND FOR EUROPEAN NOVELTIES IN THE JEWELRY LINE.

SPECIAL EXHIBIT AT WORLD'S FAIR, CHICAGO.

Represented by Mr. S. Richard, care Isaac Vaught, & Co. 59 Wall St., New York



**KEITCHAM & McDOUGAL,**  
MANUFACTURERS  
GOLD & SILVER THIMBLES,  
GOLD COLLAR BUTTONS,  
AUTOMATIC EYE-GLASS HOLDERS,  
198 BROADWAY N. Y.

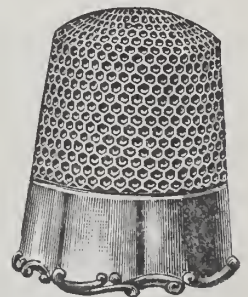

**DIAMONDS.**

**Wm. S. Hedges & Co.,**

**Importers of Diamonds,**

And Manufacturers of DIAMOND JEWELRY.

No. 170 BROADWAY,  
S. E. Cor. Maiden Lane,

New York.

27 Holborn Viaduct, London.



18 JOHN ST. NEW YORK

**R. A. Kipling**

Importer of Precious Stones

Nos. 21 & 23 MAIDEN LANE

NEW YORK

19, Rue Drouot

Paris.

**Alfred H. Smith & Co.,**

IMPORTERS

**DIAMONDS**

AND

PRECIOUS STONES,

182 BROADWAY, COR. JOHN STREET,

NEW YORK

83 Holborn Viaduct, London, E. C.

**OPTICIANS.**

ONLY house in New England devoted exclusively to Optical Goods for the trade. We carry everything needed by Oculists or Opticians.



**PRESCRIPTION**

◆ ◆ WORK

A Specialty.

**J. W. SANBORN & CO.,**  
414 WASHINGTON ST., BOSTON.

**LUDEKE & POWER,**  
**IMPORTERS OF DIAMONDS**

AND OTHER PRECIOUS STONES,

ADOLPH LUDEKE,  
CHAS. L. POWER.

23 JOHN STREET, N. Y.

**O. W. BULLOCK & CO.,**

SPRINGFIELD, MASS.

**Makers of Watch and Jewelry Tools,**

NEW CATALOGUE NOW READY.

Sent on Application.

Please Mention this Paper.

**WIGGERS & FROELICK,**

60 NASSAU ST., NEW YORK.

**Sample Cases and Trays**

For Watches, Jewelry, Optical Goods, Etc.

**WE STRIVE TO MAKE THE BEST.**

**St. Louis.**

Robert Feiker has moved into his new store on the corner of Jefferson Ave. and Pestalozzi St.

M. B. Smith has opened a new store at No. 2620 Franklin Ave., next door to D. A. Winter.

C. Reichenstein, who purchased W. Utay's store at No. 1629 Franklin Ave., has removed to 1420 Franklin Ave.

An unknown thief entered Julius A. Schmidt's store, 1500 S. Broadway, a few nights ago and helped himself to a dozen lockets, leaving no clue to his identity.

Since Mr. I. J. McMaster, assignee, was authorized by Circuit Court to sell the goods of the defunct Providence Jewelry Co., at not less than the appraised value of \$41,000, he has been disposing of portions thereof daily at the store on N. Broadway.

The officers of the Retail Jewelers' Association of Missouri announce that their fourth annual excursion, basket picnic and fish fry will be held Sunday, Aug. 20th, at the club grounds of the North St. Louis Hunting and Fishing Club, located on the Illinois side, opposite the mouth of the Missouri River.

**Newark.**

The Thomas Benfield Watch Case Co. has closed down its factory for an indefinite time.

Peter Korn, 226 Market St., has brought suit against his next door neighbor, Benjamin Blum, alleging that through the latter's neglect to securely fasten his outside show-case it was blown over on Mr. Korn's case, with the result that both were demolished.

Francis Haldemann, 135 Mulberry St., lost two silver and two gold watches last week while taking the trouble to direct a "stranger" to Clinton St. The latter seemed to have some trouble in comprehending the directions given, and the jeweler obligingly stepped outside to point the way. While he did this, some one, presumably a confederate, made off with the watches.

**Kansas City.**

Martin Haeker has become a member of the J. H. Barr Jewelry Co.

W. H. Fitzsimmons, formerly with Cady & Olmstead, in this city, and now with Henry Bohme, in Denver, was here last week on his way to Philadelphia.

Louis Kuntz, formerly with the Jaccard Watch & Jewelry Co., but who is now running a coffee plantation near Mitalanda, Mexico, was in Kansas City last week, on his way to Colorado, where he will spend several weeks.

L. E. Miller will move from 812 Main to the second floor of the new building at 1022 Main St. next week. The Meyer Jewelry Company will move from 804 Main St. to the second story of the building now being built at 1020 Main St., about Sept. 1st.



**Artistic Jewelry in Paris.**

JEWELS WORN AT THE SOIREES OF DUCHESS DONDEAUVILLE AND PRINCESS DE SAGAN — COLORED PEARLS AS PENDANTS OF NECKLACES — VARIOUS NOVELTIES.

PARIS, France, July 13.—Among the last soirees of the season, those which took place at the Duchess Dondeauville and at the Princess de Sagan were particularly remarkable. At the former, the Duchess Dondeauville wore a dress of cornflower colored satin covered with tulle of the same color, and bordered with a narrow silver embroidery. She had a very light yet elaborate diamond corsage garniture of a fancy floral design, a girdle showing a succession of gothic oak leaves formed of brilliants, and a diadem consisting of diamond palms arranged like those worn by the Cæsars. Most ladies had their corsage adorned either with large sprays of flowers in jewelry, or with embroidery showing a tasteful association of colored gems. At the Princess de Sagan's ball, the hostess wore a mandarine colored silk dress with steel spangles, covered with draperies of mandarine colored crepe constellated with diamonds. Her Royal Highness, Princess Laetitia, Duchess of Aoste, wore on her jet black hair a diamond rivièrè coiled around the back knot, and surmounted with three diamond trefoils. The Countess de Talleyrand Perigord wore a diadem of Russian shape consisting of very large precious stones.

Colored pearls, chiefly gray and pink, are used as pendants for necklaces, or salient parts in diadems. They may be replaced by turquoises, peridots, or catseyes. Jewelry in which one or the other of these stones is predominant consists merely, besides, of diamonds of different sizes.

Several Rue de la Paix jewelers exhibit a great variety of articles showing on an uneven ground in chased gold, flowers or leaves in delicate colored enamel, either sunk in the metal, or raised over it as if these had been applied by soldering and touched up by the chaser before the enameling process. I have seen in this line not only brooches, earrings, bracelets, studs and watch cases, but also bonbon and powder boxes, *carnets de bal*, stamp boxes and jewel caskets.

Cigar or cigarette cases in oxidized silver of various shades are studded with tiny diamonds sunk in the metal symmetrically but rather wide apart.

JASEUR.

**A KEENLY FELT WANT.**

"My darling girls," the mother penned,  
"Stay at the seashore, dear,  
And if there's aught that we can send,  
Why do, please, let us hear."

Back came the answer quick next day:  
"Dear mamma, do not fail  
To send to us, without delay,  
Two diamond rings, *by male*."

—Vogue.

ESTABLISHED 50 YEARS.

**RANDEL, BAREMORE & BILLINGS,**

IMPORTERS OF

**DIAMONDS,**

AND OTHER PRECIOUS STONES.

**FINE PEARLS A SPECIALTY.**

MANUFACTURERS OF

**DIAMOND JEWELRY,**

IN THE LATEST DESIGNS.

Diamonds Recut in Modern Styles or Repaired on Premises.

58 Nassau Street,  
29 Maiden Lane  
NEW YORK.

1 Tulp Straat,  
AMSTERDAM.

1 St. Andrews St.,  
Holborn Circus,  
LONDON, E. C.



TRADE MARK.

ESTABLISHED 1841.

**CARTER, SLOAN & CO.,**

**MANUFACTURERS OF GOLD JEWELRY,**

No 15 MAIDEN LANE,

NEW YORK.

A. CARTER, JR.  
A. K. SLOAN.  
C. E. HASTINGS.

GEO. R. HOWE.  
WM. T. CARTER.  
WM. T. GOUGH.

FACTORY, NEWARK, N. J.

**IRONS & RUSSELL,**

(SUCCESSORS TO CHARLES F. IRONS.)  
MANUFACTURERS OF

**SOLID GOLD EMBLEMS ROLL PLATE**  
PINS, CHARMS AND SOLID GOLD RINGS.



102 Friendship Street, - - Providence, R. I.

### Hand Setting for Stem Winders with Two Dials.

THE heavy headed key winding device in watches is gradually disappearing, and already obsolete for the better grade watches. The question at present is to adapt the stemwinding arrangement to all kinds of complicated mechanisms—that is, watches with two separate trains, each with its own mainspring barrel, or those that have several motion works for hands.

Alby, Bellenot & Co., of Biel, Switzerland, have solved this fairly difficult question in a practical manner, however, and obtained a patent for the novelty in that country. THE CIRCULAR is under obligations to the *Deutsche Uhrmacher Zeitung* for the cuts and descriptions. Fig. 1 is the front side of the movement with two motion works, and fig. 2 represents the back of a part of the movement plate. As will be seen by fig. 1, the two motion works are symmetrically organized. The two minute wheels  $m$  and  $m^1$  are kept stationary by small cocks  $CC^1$  on the plate  $P$ . The stoppage and starting, is effected by the pivoted detent  $a$  and its spring  $c$ , which revolves around  $f$  in the left motion work, and by the pivoted detent  $a^1$  with its spring  $C^1$  in the right motion work. Each of these detents is by a broad shoulder screw  $h$  or  $h^1$ , which passes through an elongated slot in the corresponding detent, kept firmly to the movement plate.

The winding pinion, as well as the loose hand setting pinion, are of the ordinary shape; only the groove  $i$  of the latter is somewhat broader than usual, and the ends of the detents  $a$  and  $a^1$  dephthing into this groove are pointed in front. This causes one of the detents to remain stationary, when the other is pressed in by the hand-setting pressure bottom.

In fig. 1 the motion work on the right is placed into dephthing, that to the left is stopped. Each of the two detents  $a$  and  $a^1$  is furnished with an intermediate wheel  $b$ , or  $b^1$ ; these two wheels remain constantly in dephthing with the hand setting wheel  $R$ , but are in a locking position, being taken out of dephthing with the corresponding minute wheel by the pressure of the spring  $c$ , or  $c^1$ . In this manner, for instance, the wheel  $b$ , fig. 1, is out of dephthing with the minute wheel  $m$ .

The detent  $a^1$ , however, is supposed to be displaced to the inward in the direction of the arrow, which motion of the detent is permitted by the elongated slot  $g^1$ , around the shoulder screw  $h^1$ . The intermediate wheel  $b^1$  has here come in dephthing with the minute wheel  $m^1$ , and as the front end of the detent  $a^1$  has at the same time placed the loose pinion upon the rocking bar into dephthing with the hand setting wheel  $R$ , the connection of the rocking bar with the motion work at the right side is thereby established. The detent  $a$  remains unaffected by the motion of the loose pinion, as the groove  $i$  is sufficiently broad that the pointed end of the detent  $a$  is not seized by the outer edge of the groove.

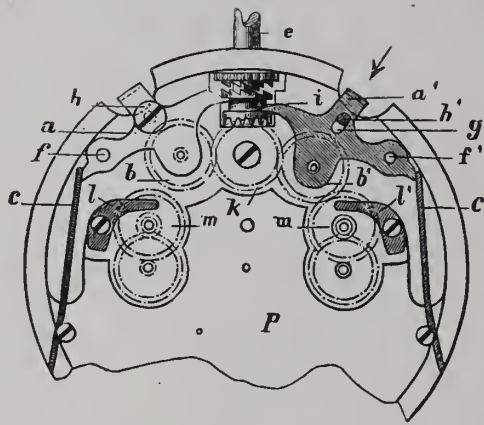

FIG. 1.

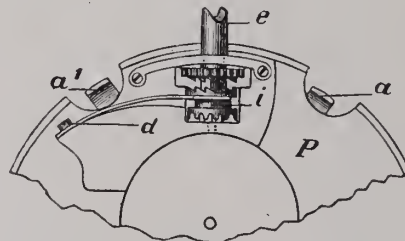

FIG. 2.

When the pressure upon the detent  $a^1$  ceases, it is carried back into its locking position by the spring  $c^1$ . In the same manner, naturally, the motion work to the left may also be geared in with the detent  $a$ , without interference with the detent  $a^1$ .

In consequence of the many motion work wheels in this watch, there is no room for the spring ordinarily used, and another arrangement is introduced. As seen from fig. 2, a countersink is made on the lower

side of the movement plate  $P$ , which produces a fairly high shoulder on the circumference of the plate  $P$ . On one side of this shoulder is screwed the spring  $d$ , formed of a flat blade. The simple form and great length of this spring appear to be more practical as well as durable, than the kinds in use at present.

### Retention of Oil at the Rubbing Surface.

IF two glass plates are laid one upon the other in such a manner, says G. H. L., in *Allg. Journal d. Uhrm.*, that they form an angle, and when next a drop of oil is placed between the plates, it will be found that this drop will approach very closely to the corner or near the point of the angle, if this angle is small. If the angle is made still smaller, the drop of oil will draw away from the point of the angle; by opening the latter, the former will approach the angle; if this is very open, for instance right angled, the oil will lodge in the corner.

If a cylindrical or conical rod is dipped in oil, this will divide throughout the whole length of the rod; but if furnished with a bulbous end a drop will form. These facts were employed in horology, to solve the difficult problem of retaining the oil at the rubbing places. The former, for instance, is used to retain the oil between a cap jewel and the pivot hole. For this reason, the side of the jewel hole turned to the cap jewel is made of spherical shape, and a small space is left between the highest point formed by the hole itself and the cap jewel. In this manner the oil will be retained constantly at this highest point; but if the space is too large, the oil creeps away.

To prevent the oil at the pivot from creeping along the arbor, the end of the latter is shaped like a cone, at the basis of which the oil is placed. To prevent the oil from spreading upon surfaces, they must be ground gorg. Great care, however, is necessary to apply only the required quantity of oil at the pivots or other rubbing parts. Nothing promotes the spreading of the oil as quickly as when an unduly large quantity is present. It is also necessary to place oil at the large pivots, the holes of which have no oil sinks, before they are placed into their holes.

## CROUCH & FITZGERALD,

Jewelry Trunks and Cases.

161 Broadway

Bet. Cortlandt and Liberty Sts.,

688 B'way,

701 6th Ave.,

NEW YORK



## JEWELERS, WAKE UP!



Don't you know there is going to be a *New Tower Clock* in your city, and some one is going to *Make some Money* on it?

Apply to us at once for figures and commissions on our *Electric Tower Clock*, which is the best. *No Winding or Regulating.* Fully warranted.

THE STANDARD ELECTRIC TIME CO.,

739 Chapel St., New Haven, Conn.

(Continued from page 1.)

office which they fulfilled in the arrangement of the hair. Now it was that the hair, rolled up with little bands of gold and purple, was enclosed in a gathered medley of fine pearls; then it would be that gold skewers would replace the pins, and fix the thick tresses around a sparkling diadem of precious stones. Soon these ornaments became so numerous, the richness of the jewels which they laid on the hair became so excessive, that it was this extravagance which distinguished the original head-dress of the elegant patricians.

Then appeared the head-dresses called *amoureuuses* (loving), in which they gave to the hair the form of a dove, or that of an inflamed heart pierced with many darts; next the coiffures in the form of a lyre, disposed in a fashion to represent this instrument of music; and now they would have warrior costumes for the head, imitating either a catapult, a crenelated tower, an arrow, or the like.

These sorts of head-dresses, says a French author, required such a great quantity of material, that it needed, for dressing such a head, the hair of twenty other heads. The most complicated head-dress was, without contradiction, the Olympian coiffure, composed of an infinity of tresses, from the thickness of the finger unto the fineness of a needle, and with a multitude of buckles of all sorts of dimensions. The entire head was covered with trinkets of gold and silver, with pearls, bandlets and ribbons. A diadem of movable precious stones completed this head-dress, which was so brilliant under the sun's rays, that the eyes could not sustain the effort of looking at it.

(To be continued.)

SHORT AND SWEET.

"What did you say he sent her in memory of their short engagement?"

"A pair of little souvenir spoons."

—*Vogue*.

BOBBY.—My father's a diamond setter.

ROBBY.—Huh! My father's got an Irish setter.

Points of Law.

ACTION TO SET ASIDE ASSIGNMENT FOR BENEFIT OF CREDITORS.

Where one creditor alone sues to set aside an assignment for the benefit of creditors and subject the property to the satisfaction of his judgment, it is error, on setting the assignment aside, to decree distribution according to their interest, between he and other creditors, the latter of whom are not parties to the suit, since, as they would not be bound by a judgment against them, they cannot have the benefit of a judgment in their favor.

*Ryttenberg v. Keels, Supreme Court of South Carolina.*

ACTION FOR GOODS SOLD.

Where, in an action to recover for goods sold and delivered, the defense was that the purchaser had been induced to purchase them through false representations of the seller's agent in regard to their use, and the only evidence that the goods were not satisfactory was that the purchaser gave one of the articles to a person to try and he declared it unsatisfactory, the seller was entitled to a judgment.

*Orrick v. Stewart, Supreme Court of Miss.*

RIGHT OF STOCKHOLDERS TO INSPECT BOOKS.

A stockholder has the legal right to inspect the books of the corporation of which he is a member. The error of the secretary in refusing to permit him to inspect the books is not of itself ground for damages against the corporation. The company was not placed in default, and the act is not fixed upon the company as an act for which it is responsible.

*Legendre v. New Orleans Brewing Association, Supreme Court of La.*

TELEGRAPH COMPANIES MADE COMMON CARRIERS.

A bill was passed by the legislature of Michigan, making telegraph companies common carriers. Business men are given recourse against the companies for insufficient

service or errors arising out of the careless transmission of messages. The passage of the bill was stubbornly resisted by a powerful lobby, at the head of which was the private secretary of a prominent United States senator. A bill to reduce the cost of transmitting messages and providing for their prompt delivery, was defeated through the potency of "arguments" disbursed by the influence mentioned above.

RECOVERY OF OVERCHARGES FROM CARRIERS.

Where the act concerning railroads and other common carriers, giving a full and ample remedy to the shipper for the recovery back for any overcharges received by the common carrier, beyond reasonable compensation, is a substitute for the remedy provided in such case at common law. The statute not only permits the shipper to recover the excess of overcharges exacted by the common carrier, but allows three times the excess, or treble damages, with attorneys' fees and costs.

*Beadle v. K. C. F. S. & M. R. Co. Supreme Court of Kansas.*

PROOF OF PARTNERSHIP.

In an action against a partnership, charging fraud in concealing the name of one, who, it was claimed, was the real partner, and screening him from liability, evidence of a conversation with a clerk in the employ of one of the other partners, that he went to him, and proposed a partnership with his employer; that, after considering it for several days, the alleged partner said he would form the partnership, but that he would have to put another man in his place, who would represent his interest in the concern, he was the real partner.

*Webb v. Johnson, Supreme Court of Mich.*

RESCINDING SALE FOR FRAUD.

Where goods are sold on credit induced by the fraudulent representations of the vendee, as to his solvency or ability to pay for the goods bought, the vendor may rescind the sale upon the discovery of the fraud and replevin the goods.

*McKinney v. First National Bank of Chadron, Supreme Court of Neb.*

# R., L. & M. Friedlander,



IMPORTERS OF  
**DIAMONDS.**

WHOLESALE  
**JEWELERS.**

JOBBERS IN  
**American Watches.**

Tools, Materials, and Optical Goods.

Send for Catalogue.

65 & 67 Nassau Street, New York.

# FERDINAND BING & Co.,

106 GRAND ST., N. Y.

**SPECIALTIES IN IMPORTED CLOCKS,**

**MARBLE STATUARY AND BRIC-A-BRAC**

FOR THE JEWELRY TRADE.

ENAMELED AND TRANSPARENT SPOONS FROM ALL PARTS OF THE WORLD

NEW ! IMPROVED NEW !  
Adjustable "Eclipse" Eye Glasses.

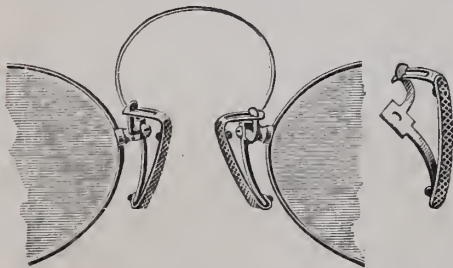

PATENT APPLIED FOR.

We claim this invention the only one which combines the advantages of both the adjustable and offset guards.

We will furnish these frames or guards by Sept. 1st, in either Zelonite or Cork.

WRITE FOR CIRCULAR.



61 Hanover Street, Boston, Mass.

Sales made for Jewelers only in their established places of business. Can give best references of any auctioneers in America.

All communications strictly confidential.

DON'T FORGET the JEWELER'S CIRCULAR PUBLISHING CO.'S BOOK LIST when in want of any technical book in the Jewelry or Kindred Trades.

## C. SYDNEY SMITH,

HAS REMOVED TO 191 BROADWAY,  
New York.

FACTORY:  
PROVIDENCE, R. I.

Manufacturer of { GOLD CHAINS,  
LOCKETS AND CHARMS.

We Have Removed to .....  
**57 MAIDEN LANE.**

LEONHARDT & CURRAN,  
MANUFACTURERS OF DIAMOND MOUNTINGS.



### MUELLER'S ARTIFICIAL EYES.

\$75 per hundred; smaller lots, \$15 per dozen; \$2 each. A large assortment of eyes will be sent to any dealer to enable him to make selection, upon receipt of satisfactory references. We carry the largest stock in America.

ONLY MANUFACTURERS OF THE "DIAMANTA" SPECTACLES AND EYE-GLASSES. Oculists' prescriptions promptly and accurately filled. Catalogue, price lists, test cards, etc., on application.

M. ZINEMAN & BRO., American Agents, 130 South Ninth St., Philadelphia.

### Rich Cut Glass

AND

DECORATED ART WARES.

Mt. Washington Glass Co.,

New Bedford, Mass.

RICH DISPLAY OF GOODS AT

New York Store: 46 Murray St.

When you visit Chicago do not fail to inspect our full line of goods at the new store of Pairpoint Mfg. Co., 224 Wabash Avenue.

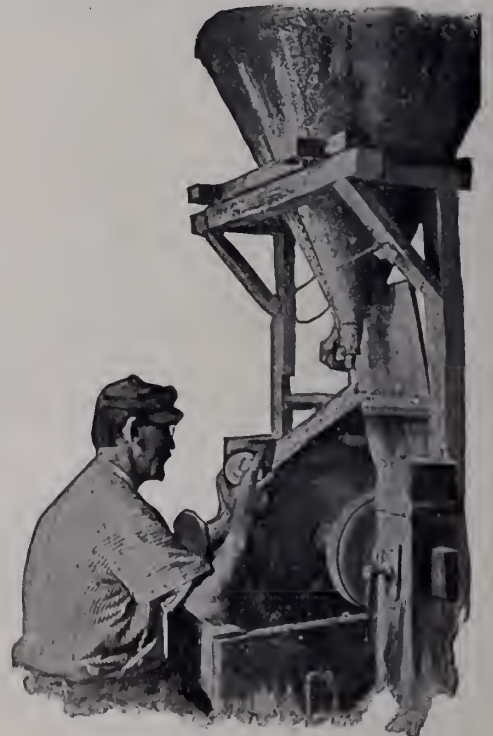

GLASS CUTTER AT WORK.



**Leon J. Glaenzer & Co. at the World's Fair.**

A SEARCH for the source of supply of those French porcelain clocks, without which no jewelry stock is now considered complete, brought the World's Fair correspondent of THE CIRCULAR to a standstill before the magnificent exhibit of Leon J. Glaenzer & Co., in the great bronze room of

clocks and novelties of the smaller descriptions between the regulators and the plate glass fronts. The upper shelf is given to sets of regulators with accompanying candelabra. On either side of the display case are shelves supporting clocks of all descriptions, and at the right and left of the main entrance are box pyramids—the fine line of porcelains on the right and onyx goods on the left.

ceptionally choice set, the Empire wares and Empire green being the extreme style among the best trade.

Regulators range from the plain case to the fancy mounted with columns and filigree work to suit all tastes. They come in numerous styles of new dials and pretty porcelain fronts. The white marble onyx clocks in Empire style are choice selections for the finer trade. Traveling clocks comprise a



THE ARTISTIC DISPLAY OF LEON J. GLAENZER & CO.

the French section in Manufactures building. The handsome display is installed on the west center of the bronze court and is finely arranged to allow of the best possible examination of wares.

At the rear of the exhibit is a huge ebony and plate glass case containing a myriad clocks. At the back of each of three of the deep glass shelves are gilt regulators, with

The center piece of the sets in the rear case is an Empire gilt in the form of a lyre, inlaid with Watteau designs in Empire green porcelain. The side pieces have a square base of Empire green porcelain decorated with Watteau printings and supporting gold bronze statues—one of Fortuna and one of Mercury—each upholding a five light branching candelabra. This is an ex-

large line, from the miniature up to the regulation traveling size in cases from the plain to the fine inlaid cloisonné enamels with porcelain painted portraits on the sides. In all the sizes are complicated movements giving hour strike with or without alarm, repeating hours and quarters. Porcelains are displayed in every variety of tint and color from the white through the delicate

## The Connoisseur.

(Continued from page 41.)

pinks, blues and yellows to the Empire green.

Onyx goods are shown in "Sedan" shapes and up to large onyx clock sets with vases to match. Among the regulators is noticed a particularly fine example of the Louis XIV. pattern with glass sides all around, mounted with gilt bronze. The clock and candelabra to match form an exquisite set. Next this is a gilt regulator with Corinthian columns at front corners supporting a handsome frieze. The dial and a porcelain portrait on the front are encircled with brilliants, the whole being very effective.

A gem in traveling clocks, inclosed in a green velvet case, is of diminutive size with columns, frieze, base, dial and handle set with rows of pearls. One of larger size—the size more generally employed—has a square frame of gilt bronze. The engraved gilt bronze front plate exposes a white porcelain dial with Louis XIV. wreath and a smaller alarm dial. At the two sides are three-inch portraits on porcelain of Marie Louise and Marie Antoinette.

At the left of the exhibit is a row of cloisonné enamels in exquisite designs in different colors, making a very effective and desirable line of goods.

The most expensive piece in the exhibit is a huge gilt clock standing on a gilt base supported by four feet, a piece which would lend ornament to any mansion in the land. A beautiful porcelain set in Empire green, Louis XIV. pattern, with gilt rococco border, has below the dial a handsome Watteau painting with rococco border of raised gold, the border extending around the dial. The candelabra have a scroll base of Empire green matching the clock, and five rococco gilt branches support Empire green porcelain cups decorated with paintings symbolic of music, painting and other arts.

Porcelains are shown in Gothic, rococco,

Empire and Louis XIV. shapes. The Empire is the latest production of the factory. A gem in porcelains is shown in light green with the sides and top entwined with a flowering vine. The front contains a Watteau painting of rare beauty. This clock stands on four gilt feet, with the scroll work extending up the corners and a slight gilt ornamentation above the dial. The rococco clocks have candelabra to match and make beautiful mantel sets.

The fine decorative work on all the pieces is of such delicacy and so artistic as to be particularly noticeable; and it is undeniable that the superiority of Leon J. Glaenger & Co. in this line has been a powerful factor in placing them in the pre-eminent position they now enjoy. The exhibit is remarkable not only for the number of clocks shown, but also for the rare beauty of form and decoration embodied in each individual piece. What is of greater moment to American jewelers, this display shows that the firm are fully alive to the requirements of the American trade and have made their exhibit replete with goods desirable in every way.

The New York office and salesroom, 80 and 82 Chambers Street, constantly receives rich novelties in the clock line in exclusive designs. C. D. Kent is in charge of the World's Fair exhibit.

### The Rambler's Notes.

WHAT THE RAMBLER SAW AND HEARD AMONG THE DEALERS IN ART POTTERY, CUT GLASS, BRONZES, ETC.

VASES, flower holders, pitchers, water bottles, oil bottles and decanters of glass, covered with metal filigree, are among the latest of the attractive novelties shown by Hinrichs & Co., No. 31 Park Place, N. Y. city. The beautiful combination of crystal and metal has already caused this line to become popular. Other lines shown in extensive variety are Italian faience figures of

every description, from small single pieces to the largest group, and the Dresden specialties decorated with raised for-get-me-nots, shown in miniature furniture, musical instruments and cabinet and desk ornaments.

Bawo & Dotter, 30 Barclay St., are showing a new and extensive variety of fish, game and ice cream sets in the Elite French china. Among the new shapes in these sets controlled by this firm, are the beautiful Brintemps and the Marie Antoinette, with rich gold and floral decorations and Empire green colorings. Additions have also been made to their large line of beautifully decorated Coalport plates and after dinner cups and saucers.

Three entirely new patterns in cut glass are now to be seen at the warerooms of T. B. Clark & Co., 53 Park Place, N. Y. city. They are the Majestic, Egyptian and Coral, all brilliant and attractive additions. The Majestic deserves particular mention as it is entirely novel and different from all lines followed in previous cuttings. The main feature of this pattern is a large five or six pointed star of checker work, covering the entire piece. The spaces between the points contain richly cut rosettes. In the center of the large star is another, many pointed, the longer points extending into the points of the checkered star. The effect is rich and beautiful and the pattern will undoubtedly be one of the most popular of the many introduced by this company.

Levy, Dreyfus & Co., 11 Maiden Lane, New York city, have just opened an exquisite line of Royal Crown Derby which was made especially for them. It contains ornamental pieces in great variety, particularly suited for wedding and holiday presents, dejeuner, toilet and brush and comb sets, dessert and "afternoon tea" plates, and also tea and after dinner coffee cups and saucers.



ART NOVELTIES AND BRIG-A-BRAG,  
EXQUISITE  
CLOCKS  
and  
Clock Frames.

SPECIALTIES  
FOR THE JEWELRY TRADE,  
and  
OPERA GLASSES  
Chamois Skins.

# GEO. BORGFELDT & CO.,

18-20-22 WASHINGTON PLACE, COR. GREENE ST., NEW YORK.

# LEON J. GLAENZER & Co.,

80 & 82 CHAMBERS ST., N. Y.

PARIS HOUSE,

35 BOULEVARD DE STRASBOURG



# RICH NOVELTIES

EXCLUSIVELY FOR THE JEWELRY TRADE.

Original and Exclusive Designs in

## CLOCKS,

Onyx, Porcelain, Gilt and Enameled Clock Sets, Gilt Regulators, Traveling Clocks and English Hall Clocks.

GILT AND FILIGREE SILVER-PLATED NOVELTIES AND PHOTOGRAPH FRAMES.



ESTABLISHED 1801.

# HINRICH'S & CO.,

29 & 31 PARK PLACE, Cor. Church Street, NEW YORK.

Art Pottery and Bric-a-Brac, CUT GLASS, FANCY GLASS, CHINA, LAMPS.

THE LARGEST ASSORTMENT OF SPECIALTIES FOR THE JEWELRY TRADE, AT LOWEST PRICES.

## "Old English"

Coffee Spoon.



Towle Mfg. Co.,

MANUFACTURERS OF STERLING SILVERWARE.

NEWBURYPORT: No. 214 Merrimack St. CHICAGO: Nos. 149 & 151 State St.

## WM. BIRMINGHAM & CO.,

MANUFACTURERS OF

All Kinds of Leather Spectacle and Eye Glass

## CASES,

728 Arch Street, PHILADELPHIA, PA

ALUMINUM SOLDER \$2.00 PER POUND.

Instructions for using given gratis.

Practical Processes for Soldering, Dipping, Enameling, Etching, &c., of Aluminum.

C. DE REDON, 43 WEST 21ST ST., NEW YORK.

ESTABLISHED 1837.

## GEO. O. STREET & SONS,

MAKERS OF

Fine Rings, Locketts, Seals,

Sleeve Buttons and Links,

15 John Street, NEW YORK.

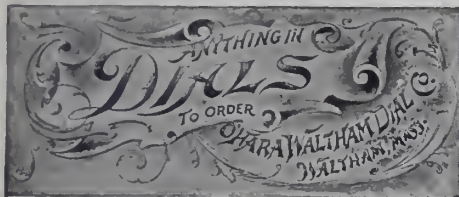

All the illustrations in this issue were made by

W. H. BARTHOLOMEW.

PHOTO-ENGRAVER,

18 SPRUCE ST., NEW YORK.



# The Warren Eye Protector

(Patented Jan. 12, 1892, Feb. 21, 1893.)

Saves the Eyes From Dust, Wind, or Glaring Light.

Folds in a Compact Case, is

Comfortable, Durable, Water and Dust Proof.

Its large field does not obstruct the sight. No brittle substance to endanger face under sudden blows.

Oculists and Physicians Recommend it.

Travelers, Cyclists, Railroadmen, Horsemen, Motormen, Quarrymen, Pronounce it Indispensable for Man or Woman.

Ask your Dealer for it.

Colors, Clear, Smoke, Blue or Green. Black frames, 50c. Silver, 75c. Sent by mail on receipt of price. Manufactured solely by

## The Nour Verrons Company

P. O. Box 3273, Boston, Mass.

WOLFF & GUNZBURGER, Importers of DIAMONDS, (Fulton Building), NEW YORK.

**FALKENAU, OPPENHEIMER & Co.**

**DIAMONDS**  
40 MAIDEN LANE NEW YORK

# RUBIES.

**M. D. ROTHSCHILD,**  
NEW YORK: 41 & 43 MAIDEN LANE  
LONDON: 15 HOLBORN VIADUCT  
PARIS: 58 RUE LAFFITTE.

## CHAS. S. PLATT,

1837. Successor to Geo. W. Platt, 1881.  
GOLD AND SILVER  
REFINER, ASSAYER  
AND SWEEP SMELTER.  
29 & 31 Gold St., <sup>Near John St.</sup> New York.  
Platers' and Electro-Platers' Silver  
Platinum and Aluminum.

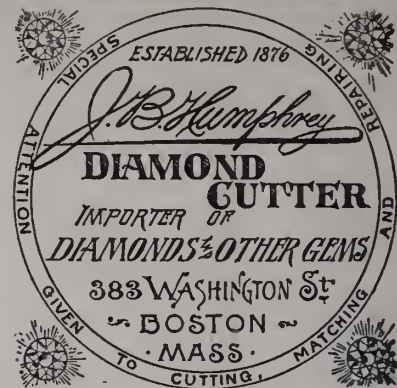

ESTABLISHED 1848.  
**DIAMONDS**  
**BRUHL BROS. & CO.**  
21 Maiden Lane, N. Y., 57 Rue de Chateaudun, Paris.  
**PEARLS**  
and other Precious Stones.

FRENCH WRITE FOR CATALOGUE. ENGLISH

# CLOCKS

AND CLOCK MATERIALS.  
CHAS. JACQUES CLOCK CO., 22 CORTLANDT ST., N. Y.

## L. LELONG & BRO.,

GOLD AND SILVER  
Refiners, Assayers AND Sweep Smelters,  
SOUTHWEST CORNER HALSEY AND MARSHALL STREETS,  
**NEWARK, N. J.**  
SWEEPINGS A SPECIALTY.

# WHY

S. F. MYERS & CO.  
sell more goods than any  
other Wholesale Jewelry  
House.

# BECAUSE

various publications and illustrated catalogues.

They are the only firm in the Metropolis who carry  
in stock a full line of everything a jeweler requires.  
They give the utmost values and endeavor to  
please their trade in every respect. Refer to their  
catalogues.

MYERS BUILDINGS, 48 & 50 Maiden Lane, NEW YORK.

**HENRY FERA,**  
IMPORTER OF DIAMONDS  
AND DIAMOND BORTZ,  
Diamond Cutting and Polishing Establishment,  
10 Maiden Lane, NEW YORK.

**S. P. HOWARD,**  
Gold and Silver Assayer.  
Refiner and Sweep Smelter,  
33 MAIDEN LANE, NEW YORK.  
Smelting and Refining Works,  
28 & 30 Cumberland Street, Brooklyn, N. Y.  
Specialties: Sweepings, Gold, Silver and Platinum.

**Paul Jeanne,** EIGHTEENTH STREET and 4<sup>TH</sup> AVE., N. Y.  
(Bradley Building.)  
MANUFACTURER OF

≡ FINE ⊗ DIAMOND ⊗ JEWELRY. ≡

ESTABLISHED 1870.  
**J. L. CLARK,**  
SWEEP SMELTER AND REFINER OF GOLD AND SILVER.  
Buys every kind of Gold and Silverware, Jewelry, Watches and Platinum. Full market value paid.  
No. 724 Filbert Street, Philadelphia, Pa.  
SEND BY EXPRESS or Registered Mail. If my price is not satisfactory, I will return all articles.

# ALBERT LORSCH & CO.

37 MAIDEN LANE, NEW YORK.

Branch, 167 Broad Street, Providence, R. I.

—\*IMPORTERS OF DIAMONDS,\*—

Rose Diamonds, Rubies, Sapphires, Emeralds, Opals, Moonstones, Fancy and  
IMITATION STONES, NOVELTIES.

SOLE OWNERS AND IMPORTERS OF

*The Sumatra Gem.*  
REG'D.

IT PAYS TO KEEP IN TOUCH WITH TRADE AFFAIRS.  
"THE JEWELERS CIRCULAR," For 4c. a Week will do it, **Subscribe.**

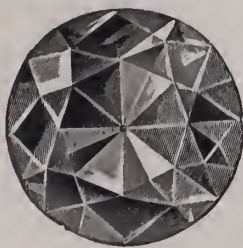



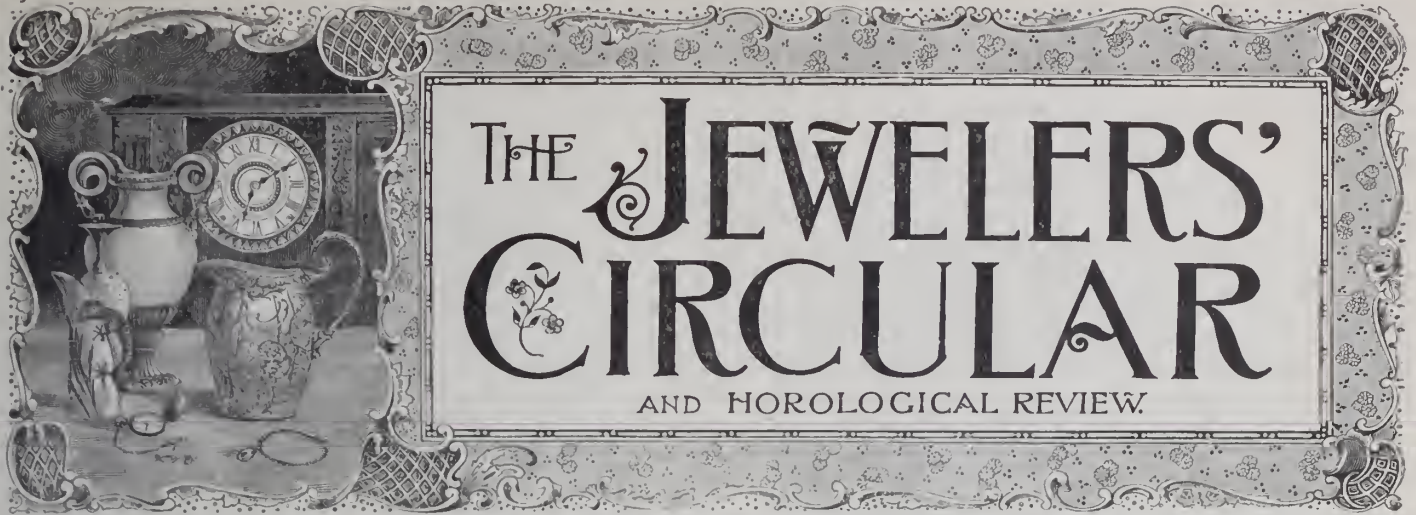

# THE JEWELERS' CIRCULAR

AND HOROLOGICAL REVIEW

Copyright, by THE JEWELERS' CIRCULAR PUB. CO.

189 Broadway, New York.

Entered at the Post Office in N. Y. as second-class matter.

VOL. XXVII.

NEW YORK, WEDNESDAY, AUGUST 16, 1893.

NO. 3.

## ARTISTIC TROPHIES FOR WHITE WINGED WINNERS.

FROM now on till mid-Autumn yachtsmen and all lovers of the finest of sports, yachting, will be occupied in wondering and guessing about the white winged craft with racing records. The approaching occurrence of the international yacht race, and the great preliminary races have aroused an interest in yachting matters that never before has been so general in its manifestations. Introductory to the international event is the cruise of the New York Yacht Club, in which a series of regattas form a most interesting feature. The trophies, made by Tiffany & Co., New York, comprise a collection of specimens in silversmithing worthy earnest study by members of the craft.

The \$1,000 Goelet schooner yacht prize for this year, illustrated here, is a large and truly artistic piece of silver work, in a style suggesting the Louis, though in itself entirely original. Its main feature is that of a mermaid of most graceful form entwined with dolphins and other insignia of the sea, upholding a large and beautiful shell which forms a bowl of usefulness and grace. On each side of the shell is a plaque-like shield, on one of which is the title of the piece, 'Goelet Prize for Schooner Yachts, 1893,' the

other being left vacant for the name of the winner. These are surrounded by beauti-

fully chased wreaths of laurel. The meaning of the design is "True rejoicing on the sea." The cup stands 23 inches high and weighs 418 ounces.

The \$500 Goelet prize for sloops is a wine cup of silver, and in design is quite a departure from what we are accustomed to see. It is of an old Roman period. One of the most striking features of these cups is the peculiar character of the handles which seem to come with grace and boldness from the body of the piece and attach themselves lightly to the upper part of the neck. The handles give the cup a strong suggestion of its use. On each side of the piece is a shield, the border of which is formed by two mermaids whose entwined tails form the lower part of the escutcheon. This is all in raised work chased. On the shield, under full sail, is a sloop yacht etched in a pleasing manner.

The height of the cup is 15 inches, and its weight 232 ounces.

One of the yacht prizes for this year presented by Commodore Morgan is a silver vase of a strictly classical character, being in shape and ornamentation purely Grecian. It has around the upper part of the body a frieze composed of a number of sea gods, nymphs, mermaids and the



THE GOELET PRIZE CUP FOR SCHOONERS. NEW YORK YACHT CLUB.

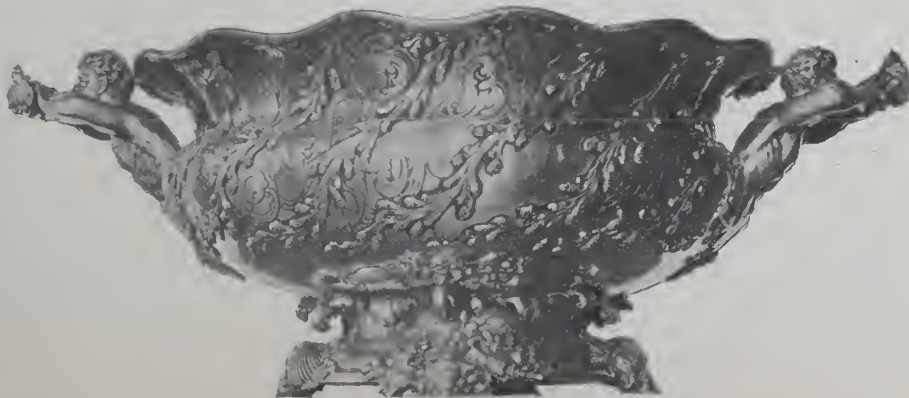

THE ASTOR PRIZE CUP FOR SLOOPS. NEW YORK YACHT CLUB.

MARJORIE.

INITIAL.



ILLUSTRATING THE FOUR DESIGNS OF  
 EBONY AND SILVER

COMBINATIONS

— IN —

TOILET SETS.

DEITSCH BROS.,

— ORIGINATORS OF NOVELTIES —

— IN —

— Leather and Silver Combinations. —

7 EAST 17TH STREET, NEW YORK CITY.

CASTLE.



EMPIRE.



These designs are made in the following articles:

Round and Oval Mirrors,

Bonnet and Velvet Brushes,

Combs,

Manicure Requisites,

Stationary Racks,

Writing Necessities,

Photo Frames,

Stamp Boxes,

Paper Knives,

Pen Trays,

Pin Trays,

Hair Pin Boxes,

Shoe Buttoners,

Love Powder Bottles

Mustache Brushes,

Jewel Caskets,

Letter Clips,

Jewel Trays,

Shoe Horns,

Infant Brushes,

Smoking Sets,

Coasters, Whists.

# DEITSCH BROS.,

MAKERS,

7 East 17th Street,

NEW YORK.

# “DO YOU KNOW?”

**THAT** GOODS **FREE** FROM **SOLDER** ARE THE **BEST**?

**THAT** GOODS MADE FROM **SEAMLESS WIRE** ARE **SUPERIOR**  
**IN FINISH** ON THIS ACCOUNT?

**THAT** **SEAMLESS WIRE** MAKES THE **BEST** FILLED CHAINS?

**THAT** WE ARE THE MAKERS OF THE **ORIGINAL** AND  
CELEBRATED

## Seamless Gold Filled Chains?

Do not fail to visit our beautiful and artistic display at the World's Fair.

The finest of its kind at the Exposition.



Northeast Corner of Manufacturers Building, Department O. Right on the corner.  
See Official Catalogue.

## KENT & STANLEY CO.,

### *Branch Offices:*

NEW YORK, 17 Maiden Lane.

BOSTON, 58 Winter Street.

SAN FRANCISCO,  
Phelan Building.

MONTREAL, Temple Building.

Main Office and Works

PROVIDENCE, R. I.

# THE FAIRPOINT MFG. COMPANY,

NEW BEDFORD, MASS.

FLATWARE.

HOLLOW WARE.

- BERRY FORKS.
- BERRY SPOONS.
- ICE CREAM KNIVES.
- ICE CREAM SPOONS.
- SALAD SETS.
- OYSTER FORKS.
- OLIVE SPEARS.
- PUNCH LADLES.



2410.—OVAL TUREEN.

- BERRY SETS.
- BERRY DISHES.
- ICE PITCHERS.
- ICE TUBS.
- SALAD BOWLS.
- OYSTER LADLES.
- WINE SETS.
- PUNCH BOWLS.

NEW YORK,  
20 MAIDEN LANE.

CHICAGO,  
224 WABASH AVE.

SAN FRANCISCO,  
220 SUTTER STREET.

## CHAS. L. UHRY & Co.

N. Y. OFFICE,  
189 BROADWAY.

- SCARF PINS,
- BROOCHES,
- CHARMS,
- FOBS.
- HAT PINS,
- HAIR PINS,
- CHATELAINES.

336 Mulberry St., Newark, N. J.

## CHAS. L. UHRY & Co.

### Brunor Plating and Jewelry Rep. Co.

Jewelry Matched and Repaired, Engraving,  
Chasing and Enameling, Setting, Polishing and  
Lapping, Battery Gilding and Roman Coloring,  
Watch Cases Repaired, Polished and Gilded.  
32 Maiden Lane, New York.

We sell to the legitimate Jewelry and Stationery  
trade only.



### CHOICE PAPERS

MAKERS OF

## FINE STATIONERY

For Correspondence, Wedding and Business Use, handsomely  
boxed, specially suited to the Jewelry Trade.

18 MURRAY STREET, NEW YORK.

# WORLD'S FAIR SOUVENIRS.

\* STERLING SILVER. \*



THE COLUMBUS.



REVERSE SIDE OF HANDLE.



REVERSE SIDE OF HANDLE.



THE DISCOVERER.



REVERSE SIDE OF HANDLE.



THE AMERICAN.

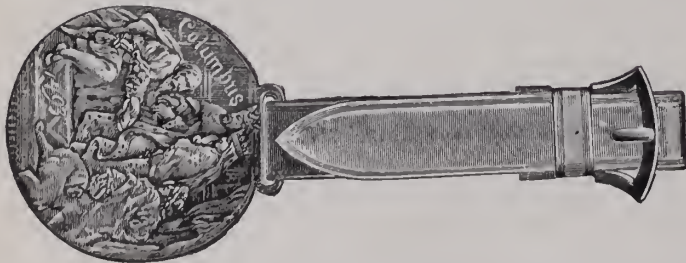

No. 2. BAGGAGE CHECK.

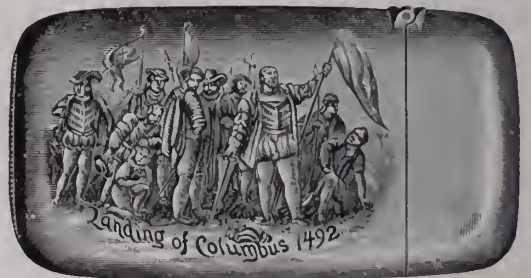

MATCH BOX.

## R. WALLACE & SONS MFG. CO.,

SILVERSMITHS,

WALLINGFORD, CONN.

NEW YORK:  
3 PARK PLACE.

CHICAGO:  
86 WABASH AVENUE.

like, all with their sea horns, shells and trumpets to their mouths sounding the notes of praise to the victors of the day. Under this and a little to the right, is the Greek word "Nekh," victory. The ornamentation introduced on the lower part of the body of the piece is composed of palm branches and tridents with the Greek conventional water border. Around the neck is the laurel wreath. The meaning of the design is "Victory on the sea." The ivy upon the foot bespeaks friendship. The inscription will be added upon the side of the piece when the name of the victor is known. The height of the vase is 17 inches and it weighs 129½ ounces.

The other prize offered by Commodore Morgan is also a vase of graceful form, in Græco-Roman style. Upon the side of the body of the piece is a group composed of Venus and Cupids with the arrows, the bows, the rosewreath and the doves. This piece was designed and made with a view of producing a trophy of a truly classical nature—a true work of art rather than one of a nautical character. It is a specimen of most perfect repoussé work. On the outside of the light and graceful handles is introduced the laurel branches of victory. The borders around the neck and foot are of ivy, treated in the peculiar manner and shape of the period. The ivy leaf of this particular time and for certain uses was represented as heart shaped. The height of this vase is 19½ inches and it weighs 92 ounces.

One Astor prize of this year is a silver bowl, illustrated on the front page of about 9 inches in height and 17 inches in diameter, and weighing 196 ounces. It is in a true nautical design, being thickly covered in a most pleasing manner with seaweeds and shells, with which is introduced on both sides in a most masterly style of etching the wording explanatory of the nature of the prize. The handles are formed of two demi-figures of the sea blowing the shell-like trumpets of reward. On one side of the bowl are the words, "Astor Cups won by \_\_\_\_\_," a space being left for name. On the other side are the words, "Newport, Rhode Island, 1893."

The other Astor prize is of the loving cup form, but having two handles instead of three. The handles and the foot are beautifully chased, the ornament being entirely composed of all things nautical—the heads of dolphins, sea monsters, shells and seaweeds. On the body of the piece is an etching of the yacht race with the words, "Astor Cup, Rhode Island, 1893." The cup stands nearly 15 inches high and weighs 150 ounces.

Adolph Ballott, Boise City, Idaho, has been attached for \$900.

**O. W. BULLOCK & CO.,**  
 SPRINGFIELD, MASS.  
 Makers of Watch and Jewelry Tools,  
 NEW CATALOGUE NOW READY.

Sent on Application. Please Mention this Paper.

**BIPPART & CO.**  
 MANUFACTURERS OF  
**DIAMOND JEWELRY**  
 NEWARK, N. J.

BROOCHES, SCARF PINS, HAT PINS, HAIR PINS, EARRINGS,	LINK BUTTONS, CUFF PINS, BRACELETS, NECKLACES, RINGS.
--	---

NEW YORK OFFICE 19 MAIDEN LANE

## THE BOWDEN SEAMLESS RING

IS MADE ONLY BY

**J. B. BOWDEN & Co.,**  
 Makers of Finger Rings of every Description.  
 COR. BROADWAY & JOHN STREET,  
 NEW YORK.

## J. B. & S. M. KNOWLES CO.,

MAKERS OF

Sterling



Silverware.

FACTORY,  
 Providence, R. I.

SALESROOM,  
 860 Broadway, N. Y.

### CAMPBELL-METCALF SILVER CO.



176 Broadway, N. Y., Room 14. 66 Stewart St., Prov., R. I.  
 Mills Bldg., San Francisco, 8th Floor, Room 1.

**WOOD & HUGHES,**  
 STERLING SILVERWARE MANUFACTURERS.  
 New York Agents for the Derby Silver Co.'s  
 FINE QUADRUPLE PLATED WARE,  
 NO. 16 JOHN STREET, NEW YORK  
 206 Kearney St., San Francisco, Cal.  
 HASKELL & MUEGGE, Agents.



**ARTISTIC  
METAL  
GOODS.**

NEW DESIGNS,  
NEW FINISHES.

Our line of Pitchers, Vases, Tables, Candlesticks, Five O'Clock Teas, Etc., cannot be equaled.

**THE  
CELEBRATED  
"B & H" LAMP.**



BEAUTIFUL DESIGNS,

particularly adapted to the Jewelry Trade.

SEE OUR LINE OF

TABLE, BANQUET AND PIANO LAMPS

before placing your orders. Send for our Little Book.

**BRADLEY & HUBBARD MFG. CO.**

NEW YORK, BOSTON, CHICAGO,  
21 BARCLAY ST., 160 CONGRESS ST. 88 WABASH AVE.  
26 PARK PLACE Factories, MERIDEN, CT.

**"THE BEST BUTTON MADE."**

THE KREMENTZ

IN GOLD

FROM

**KREMENTZ & CO.**

And all Jobbers.



ONE PIECE

IN ROLLED PLATE

FROM

ALL JOBBERS.

**COLLAR BUTTON.**

IS THE ORIGINAL ONE PIECE BUTTON.

IS STILL THE BEST AND STILL UNSURPASSED.

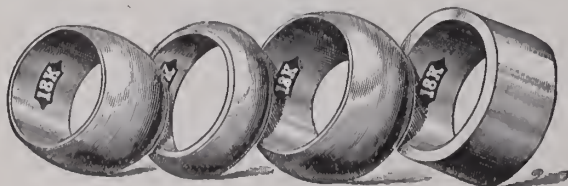

**PLAIN SOLID GOLD RINGS.**

**HILDRETH MFG. CO.,**

53 MAIDEN LANE,

NEW YORK.

**Imports and Exports for June, 1893, and the Preceding Twelve Months.**

WASHINGTON, D. C., Aug. 7.—The summary statement of imports and exports for the month ending June 30, 1893, and for the twelve months ending the same date, compared with the corresponding periods of 1892, has been issued and contains the following figures relative to the jewelry trade:

IMPORTS.—Diamonds and other precious stones, rough or uncut, including glaziers' and engravers' diamonds, not set, and jewels to be used in the manufacture of watches: Month of June, 1893, \$71,388 against \$71,991 same month of 1892, and \$109,063 in May; clocks and parts of, June, 1892, \$17,157 against \$12,033 same month of 1891, and \$19,779, in May; watches and parts of, and watch materials and movements, June, 1893, \$148,272 against \$116,971, same month of 1892, and \$163,025 in May; jewelry and manufactures of gold and silver June, 1893, \$73,966 against \$28,873 same month last year, and \$37,017 in May; precious stones and imitations of, not set, June, 1893, \$1,016,047 against \$1,436,811 same month last year, and \$1,378,119 in May; Platinum, unmanufactured, June, 1893, \$65,874 against \$38,985 same month last year, and \$89,133 in May.

EXPORTS OF DOMESTIC MERCHANDISE.—Clocks and parts of, June, 1893, \$100,436 against \$55,844 same month last year, and \$100,508, in May; watches and parts of, June, 1893, \$49,832 against \$15,977 same month last year and \$34,312 in May; jewelry and manufactures of gold and silver, June, 1893, \$103,484 against \$62,829 same month last year and \$119,237 in May; plated ware, June, 1893, \$31,650 against \$34,571 same month last year and \$30,690 in May.

IMPORTS, for fiscal year ending June 30, 1893.—Diamonds and other precious stones, etc., \$1,066,586 against \$1,096,587 in 1892; clocks and parts of, etc., \$254,391 against \$195,890 in 1892; watches and parts of, etc., \$1,743,591 against \$1,734,648; jewelry and manufactures of gold and silver, \$696,462 against \$618,518 in 1892; precious stones and imitations of, not set, \$15,168,746 against \$12,354,420 in 1892; platinum, unmanufactured, \$639,445 against \$505,205 in 1892.

EXPORTS OF DOMESTIC MERCHANDISE, for fiscal year ending June 30.—Clocks and parts of, \$962,423 against \$1,020,873 in 1892; watches and parts of, \$241,758 against \$208,743 in 1892; jewelry and manufactures of gold and silver, \$881,893 against \$1,026,188 in 1892; plated ware, \$322,016 against \$369,478 in 1892.

EXPORTS OF FOREIGN MERCHANDISE.—Diamonds and other precious stones, etc., June, 1893; nothing against nothing in 1892 and \$355 against nothing for fiscal year of 1892; clocks and parts of, June, 1893, nothing against nothing in June, 1892, and \$1,556 against nothing for fiscal year of 1892; watches and parts of, etc., June, 1893, \$65 against nothing in June, 1892, and \$355 against \$301 for fiscal year of 1892; jewelry and manufactures of gold and silver June



1893, \$985 against \$1,076 in 1892 and \$25,310 against \$74,988 for fiscal year of 1892; precious stones, etc., June, 1893, nothing against nothing in June, 1892, and \$1,561 against \$11,533 for fiscal year of 1892; platinum June, 1893, \$35 against nothing in June, 1892, and \$118 against nothing for fiscal year of 1892. The table of imports during the fiscal year ending June 30, 1893, as compared with the average of the fiscal year of 1892, shows the following: clocks and watches and parts of, increase \$67,444; jewelry and manufactures of gold and silver and precious stones, decrease \$7,107,730. In exports, clocks and watches, decrease \$25,435.

**Attachments Issued Against Taylor & Brother.**

Two attachments were issued Friday against George C. Taylor, doing business under the name of Taylor & Bro., at 860 Broadway, New York. One was for \$7,845, in favor of Frank H. Carpenter, and the other for \$2,070 in favor of Henry Dreyfus & Co. The attachments were issued by Judge Giegerich, of the Court of Common Pleas, on the charge that Mr. Taylor had removed property for the purpose of defrauding his creditors.

In his affidavit Mr. Carpenter alleges that on Aug. 7th he had a conversation with Mr. Taylor regarding money due him, and requested that Mr. Taylor protect him in some way. Mr. Taylor asked what kind of

security Mr. Carpenter wanted, and the latter said a confession of judgment would be the best. Then Mr. Taylor told him to have his lawyer draw up a confession of judgment and he would sign it the next day. Mr. Carpenter went to the office as usual on Aug. 8th, and when he was about to open the safe the bookkeeper, Henry Ten Broeck, informed him that the diamonds and other precious stones had been taken away by Mr. Taylor the night before. Mr. Taylor left his place of business on the afternoon of Aug. 7th as usual, before the employes, but returned later with his brother-in-law, Frank L. Ridgely, of St. Louis, and Mr. Ten Broeck. Mr. Taylor, the affidavit says, opened the safes and took away all the precious stones and watches, and Mr. Ten Broeck, at Mr. Taylor's request, drew up a paper by which Mr. Taylor purported to transfer all his interest therein to Mr. Ridgely. The three men then went to a room at the Hotel Brunswick.

On Aug. 10th Mr. Carpenter was informed by Mr. Ten Broeck that he was acting as agent for Mr. Ridgely in collecting accounts due from customers, which Mr. Taylor had transferred to Mr. Ridgely.

Chas. E. Hill, attorney for Mrs. Taylor, who was seen by a CIRCULAR reporter, said that the reports that Mr. Taylor had run away were wholly untrue, for Mr. Taylor was and had been at his home on Staten Island. The affidavit, he said, was greatly

colored, possibly in order to obtain the attachment. It was true that Mr. Taylor had transferred some of his property to his wife and Mr. Ridgely, his brother-in-law, who were his creditors, which he had a right to do. That there was any dishonesty in Mr. Taylor's action, the attorney denies. What Mr. Taylor's plans were, or whether the creditors would be conferred with, he could not tell, but said that Mr. Taylor was feeling more hopeful about his failure and desired, if possible, to resume business.

Mr. Taylor's failure was a great surprise to many in the trade, as his business was the continuation of one of the oldest and most widely respected houses in the New York jewelry trade, namely Read & Taylor, afterward Taylor, Olmstead & Taylor. That firm was succeeded by Taylor & Bro. in 1875. Frank D. Taylor, brother of George C. Taylor, died in 1879, since which time the latter has carried on the business alone. He formerly did a large business in high art goods, but he sold out his stock of clocks, bronzes, potteries, etc., at auction last April, and confined his business to diamonds, precious stones and watches.

An interesting feature among the many in Midway Plaisance is a Mohammedan jeweler surrounded by the crude implements of his art. He is a swarthy Turk in the exact costume of his native land, and attracts much attention.

**ROGERS, SMITH & CO.**

UNION SQUARE,  
NEW YORK.



MERIDEN,  
CONN.

**BEST QUALITY.**

**GOLD AND SILVER PLATE.**

**A WORD ABOUT OPTICS.**

**D**ID you say you would like to make more money out of your Optical business? How are we to know it if you go on in the old-fashioned "Guess you have fitted them" plan? If you wish to know just how to fit them and do it in a correct and scientific manner, come to us. There is big money in it, and you can increase your business from six to ten times the amount by knowing how to do your work properly. There are more people who need glasses and do not know it than those that are already wearing them. Will you sit idly by and allow this trade to go elsewhere, or will you put yourself in a position to reap the reward? If the former, write to the SPENCER OPTICAL MFG. Co., 15 Maiden Lane, N. Y. City, for their circular, showing you what has been done and what can be done.

**The Thieves Escaped While the Crowd Looked on.**

PATERSON, N. J., Aug. 9.—Henry Salzberg was eating breakfast back of his jewelry store, 342 Grand St., this morning when he heard the crashing of glass. As he reached the front of the store he saw two men attempting to collect the silverware in the show window. The men ran away as they saw the jeweler, who gave chase.

Mr. Salzberg captured one of the men, who, without protest, accompanied him back to the store. The jeweler locked him in and instructed his wife to look for a policeman. Before one arrived the captive's comrade came along and burst open the door, although fully one hundred persons had been attracted to the store. The two men engaged in a fierce encounter with Mr. Salzberg and he was badly beaten. The robbers then made their escape.

**Chicago's Overflow of Thieves is Terrifying Country Dealers.**

MORRIS, Ill., Aug. 10.—Ever since the opening of the World's Columbian Exposition this section of the country has been overrun with thieves and tramps driven out of Chicago by the police and many robberies have occurred.

Some nights ago the jewelry store of D.

A. Meagher, at Kinsman, three miles south of here, was entered and completely looted. Cases of jewelry were removed and it is supposed they were taken away in wagons and secreted in the woods near here. The people are aroused and have employed special officers to watch their stores.

**Last Rites to the Memory of Edward L. White.**

WATERBURY, Conn., Aug. 10.—The funeral of Edward L. White, secretary of the Waterbury Watch Co., took place at 2 o'clock Tuesday afternoon from his late residence in this city. A large number of persons connected with the deceased in a business, social and fraternal way were present, including twenty-five members of Hamilton commandery, No. 5, K. T., of Bridgeport, of which the deceased was a member.

The Rev. Edmund Rowland, D. D. officiated at the house with the Episcopal service. At Riverside Cemetery the Knight Templars' burial service was conducted. There were many handsome floral tributes, including an elaborate piece from the Hamilton commandery.

**The Jewelers' Security Alliance.**

The regular monthly meeting of the executive committee of the Jewelers' Security Alliance was held at the Alliance Office on Friday, there being present H. H. Butts, chairman; Henry Hayes, vice-president; Bernard Karsch, treasurer; Messrs. White and Geo. H. Hodenpyl, secretary.

The following were admitted to membership: Simons, Bro. & Co., 19 Maiden Lane, New York; T. L. Bear, Camden, N. J.; W. H. Blacar, Bangor, Me., and Fredk. H. Brown, Meriden, Conn.

**Frank Reilly Gives a Bill of Sale to His Brother.**

CHICAGO, Ill., Aug. 10.—R. K. Reilly succeeds Frank Reilly at 233 State St. Last January, Reilly, Curtis & Co., 95 Washington St., asked and secured an extension of time from their creditors on something like \$15,000 liabilities. March 1st Mr. Curtis retired from the firm, Frank Reilly assuming all liabilities. Later Frank Reilly, under the firm name of Reilly & Curtis, moved to 233 State St.

August 4th Frank Reilly gave a bill of sale to R. K. Reilly, his brother, for \$5,200. The latter assumes no liabilities. R. K. Reilly is a clerk for the Springfield Insurance Co., Rialto Building. Mr. Curtis is manager for R. K. Reilly.

**Aikin Lambert Jewelry Co.**  
 Importers of  
**Diamonds**  
 Jobbers in **WATCHES**  
 Jewelry Chains etc.  
 19 Maiden Lane.  
*New York*

SAM'L B. MANN.  
Treas.  
FRED. D. ILGEN,  
Sec'y

JAMES C. AIKIN, Pres.  
JOHN B. SHEA, V.-Pres.

**Centennial Timers.**

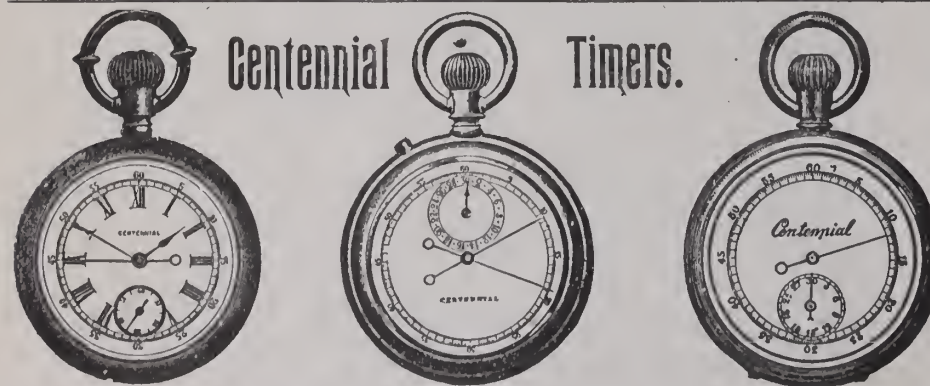

These Watches are one-third larger than above cuts.

**CROSS & BEGUELIN,**  
 Manufacturers, Importers and Jobbers of  
**Watches, Diamonds, Jewelry, Watch Materials, etc.,**  
 17 MAIDEN LANE, NEW YORK.

**JACOT & SON**  
 IMPORTERS AND MANUFACTURERS OF  
**MUSICAL BOXES**  
 298 BROADWAY.  
 NEW YORK



**L. M. Braham & Son Make an Assignment**

CINCINNATI, O., Aug. 12.—L. M. Braham & Son, 171 Vine St., have executed a deed of assignment to Wallace Burch, of the law firm of Burch & Johnson. The assets are estimated at \$30,000, and the liabilities at about \$25,000. Preferences were given as follows: To Isabelle Baker, \$2,300; the Commercial Bank of Jackson, O., \$2,500; the German National Bank, \$1,400. It is the belief of the assignee that if a little time is given for the settlement of the affairs of the firm, they will be possible to pay out in full.

Lewis M. Braham is one of the best diamond experts in the country. He has handled diamonds all his life. Originally he was a pawnbroker. He was for many years located on 4th St., east of Main. The firm has occupied its present location some three or four years. Elias Braham, a brother of Lewis, also recently made an assignment.

**Traveling Auctioneer Norris Gains a Victory.**

LOCKHAVEN, Pa., Aug. 11. Some time ago W. C. Norris, a traveling auctioneer, opened a jewelry store in Renovo. Not procuring a license as the law provides, a warrant was issued for his arrest by a justice of that place to recover the \$100 penalty for violating the law. The warrant was served on the defendant to appear before him in less than five days, contrary to the act of assembly. The accused not appearing, the justice rendered judgment by default.

The case was appealed, and last week Judge Mayer handed down an opinion reversing the decision of the justice, for the irregularity stated above.

**W. C. Pfaeffle Executes a Deed of Assignment.**

FORT WORTH, Tex., Aug. 10.—W. C. Pfaeffle has made an assignment for the benefit of his creditors, naming R. N. Denham as trustee. The assignment was made to secure the Farmers' and Mechanics' Bank and several other creditors. The liabilities are \$3,855. Mr. Pfaeffle transfers his entire stock.

Mr. Pfaeffle also executed two chattel mortgages to the American National Bank to secure certain notes described in a mortgage made.

**"The Prodigal Son Was a Son of a Gun, He Was."**

SAN FRANCISCO, Cal., Aug. 7.—Alfred B. Stead, who has been interested with his father, George Stead, in the jewelry establishment at 316 3d St., is wanted by his father and other parties with whom he has had business dealings. The young man is also wanted by the police, who hold warrants for his arrest under charges of grand larceny and embezzlement. The father has sworn out the warrant on the charge of grand larceny. He accuses his son of having purloined ten watches from the store.

A representative of Nordman Bros. secured the warrant for embezzlement. The young man obtained two watches from this firm upon a representation that the goods were for his father.

**Jeweler Gardner Wants \$10,000 for Malicious Prosecution.**

PATERSON, N. J. Aug. 9.—William T. Gardner, jeweler, has begun a suit in the Circuit Court against Mrs. Jennie McKenzie and William, her husband, for \$10,000 damages for malicious prosecution.

At the last term of court Mrs. McKenzie caused the arrest of Mr. Gardner for stealing a \$10 bill when giving change to her little girl. The jeweler was found not guilty by a jury, and now he wants \$10,000 for the injury done him by the prosecution.

**Demise of an Old Clockmaker.**

ROCHESTER, N. Y., Aug. 10.—William Beary died Saturday, aged eighty-two years. Mr. Beary was for many years a merchant of Bearytown, near Seneca Falls, which place was founded by his father. He manufactured large clocks in New York for several years, and later returned to Seneca Falls where he was in business for some time. He was twice president of the village.

Mr. Beary removed to Rochester four years ago on account of advancing years.

**Heavy Attachments Filed against Adolph Ballot.**

BOISE CITY, Idaho, Aug. 10.—The jewelry store of Adolph Ballot has been closed on attachments aggregating over \$5,600. The first attachment for \$927.28, was in

favor of S. B. Dinkelspiel & Co., San Francisco. This was followed by another attachment for \$4,306.50 filed by F. A. Nourse.

Shortly afterward a third attachment, amounting to \$429 was placed on the stock by the representative of Henry Wolff, San Francisco, making the total amount of claims secured by attachment \$5,662.78.

**Progress of Giles, Bro. & Go's. Settlement.**

CHICAGO, Ill., Aug. 12.—C. K. Giles, on being asked as to the progress of arrangements for a settlement with his firm's creditors, replied: "We are getting along well and now have signatures for over 90 per cent. The parties holding off are trying to have me treat them better than the others. It is only a trade way of extorting more money. I know that if the receiver disposes of the stock the unsecured creditors will not get a cent, and I am trying to work out more than the receiver will get by sacrificing the stock. The creditors have met me very kindly, and I think it will appear to those who have not yet signed that under the circumstances of trade it will be to their advantage to sign."

**Cincinnati Jobbers Heavily Interested in this Failure.**

HAMILTON, O., Aug. 14.—C. G. Schlenker, the Eaton jeweler, has made an assignment. He recently embarked in the dry goods business. The claims against him amount to about \$29,000 and the assets are supposed to be \$23,000. Cincinnati firms are heavily interested in the failure.

**TO THE TRADE:**



WE meet the change in price of Flat Ware, dating from August 7th. Terms as usual, subject to change without notice.

We offer for the coming season many new designs in our usual lines.

**Wood & Hughes,** 16 John Street, New York.

**C. SYDNEY SMITH,**

HAS REMOVED TO 191 BROADWAY, New York.

FACTORY: PROVIDENCE, R. I.

Manufacturer of { GOLD CHAINS, LOCKETS AND CHARMS.

# EBONY AND SILVER TOILET ARTICLES,

IN NEW AND ELEGANT  
COMBINATIONS.



AS these goods are to be very fashionable this season, we have produced the most elaborate line on the market in Ladies' and Gentlemen's Toilet and Manicure Articles.



## MADE IN

- |                         |                        |
|-------------------------|------------------------|
| HAIR BRUSHES.           | SHOE AND BUTTON HOOKS. |
| MILITARY BRUSHES.       | NAIL POLISHERS.        |
| CLOTH BRUSHES.          | POWDER AND PUFF BOXES. |
| HAT BRUSHES.            | NAIL POWDER BOXES.     |
| BONNET BRUSHES.         | SHOE HORNS.            |
| GENTLEMEN'S COMBS.      | NAPKIN RINGS.          |
| LADIES' COMBS.          | PAPER CUTTERS.         |
| ROUND AND OVAL MIRRORS. | HAND BLOTTERS.         |
| WHISK BROOMS.           | NAIL FILES.            |
| PIN TRAYS.              | CORN KNIVES, etc.      |

## J. N. PROVENZANO,

GOLD AND SILVERSMITH,

No. 39 UNION SQUARE.

NEW YORK CITY.

# The Jewelers' Circular

AND  
HOROLOGICAL REVIEW.

PUBLISHED EVERY WEDNESDAY BY

**THE JEWELERS' CIRCULAR PUB'G CO.,**  
189 BROADWAY, NEW YORK CITY.

A JOURNAL DEVOTED TO THE INTERESTS OF JEWELERS, WATCHMAKERS, SILVERSMITHS, ELECTRO-PLATE MANUFACTURERS, AND ALL ENGAGED IN KINDRED BRANCHES OF INDUSTRY

Our Editorial columns will contain our own opinions only, and we shall present in other columns only what we consider of interest or value to our readers. Advertising matter will not be printed as news.

Advertising rates in THE CIRCULAR are lower, considering the number of tradesmen reached by its large circulation, than in any other jewelry journal.

Notices of changes in standing advertisements must be received one week in advance; new matter can be received up to Monday.

### INFORMATION FOR SUBSCRIBERS.

#### Terms of Subscription, Postage Prepaid.

United States and Canada, - - - - -	PER ANNUM	\$2.00
Foreign Countries in Postal Union, - - - - -		4.00
Single Copies, - - - - -		.10

New subscribers can commence at any time. Payments for THE CIRCULAR, when sent by mail, should be made in a Post-Office Money Order, Bank Check or Draft, or an Express Money Order or Registered Letter. All postmasters are required to register letters whenever requested to do so.

Pay money only to authorized collectors having proper credentials.

Returning your paper will not enable us to discontinue it, as we cannot find your name on our books unless your address is given.

In changing address always give the old as well as new one. Your name cannot be found on our books unless this is done.

The Courts have decided that all subscribers to journals are responsible until arrearages are paid in full and an order to discontinue has been received by the publisher.

### Member of the American Trade Press Association.

VOL. XXVII. Aug. 16, 1893, No. 3.

**A** CAREFUL investigation into the numerous failures reported in this number would convince one that a national bankruptcy law would have been quite apropos at the present time.

While silver bullion is worth only some eight or ten dollars a pound, it seems strange that its use in the mechanical arts is not greatly extended.—*Baltimore Sun.*

**I**T is not strange. To transform silver bullion into an article of ornamentation or utility requires artisanship of the highest order. It is in this fact that resides the reason why the prices of works in silver, aside from flatware, do not vary perceptibly with the rise or decline in the market price of bullion. Flatware being essentially a machine product, manufacturers vary its prices with the fluctuations in the price of silver bullion. Articles of silver without embodying ornamentation or fine workmanship would sell in as large quantities as would undecorated Royal Worcester ware, or unpainted Meissonier canvasses.

**Freaky World's Fair Management.** **T**HE council of administration, supposedly an American body, will soon pass an order relative to the sale of exhibits at the World's Columbian Ex-

position which will probably give to all exhibitors the right to sell goods brought to the Fair as exhibits, but not entered in their displays. In that case all that foreign exhibitors will be required to do to sell their extra exhibits will be to pay the duty. It is not possible to stop sales without throwing out a lot of exhibits and this the authorities do not seem to have sufficient American stamina to do. As all American exhibits are entered for display it seems a manifest injustice that foreign firms should be granted this advantage.

**Hope for the Future.** **T**HE long desired special meeting of Congress, a President's message which is a terse, cogent and forcible statement of the reasons

for the repeal of the compulsory purchase clause of the Sherman act, and the arrival of \$13,280,000 gold from Europe with \$10,000,000 more on the way, have not brought the improvement many anticipated. However, much hope for the future is manifested, now that an agreement has been adopted in Congress to limit debate upon the question of the repeal of the clause referred to, to fourteen days, though the debate is entirely unnecessary, and absorbs valuable time; but many Congressmen have promised their constituents that they will speak, and so, while the country waits in anxiety, these representatives of the people are filling the *Congressional Record* with various qualities of twaddle. If only confidence in the future could be restored, the monetary troubles would be soon relieved. The unconditional repeal of the silver purchasing clause of the act of '1890, which is the wish of the business world, will effect this desired end. Then will the Fall season in all lines of industry be satisfactory if not extensive, as to volume of business; otherwise the season upon which depend many classes of industry, notably that which THE CIRCULAR represents, for a prosperous year, will be one of the most disastrous in commercial history.

**A Year's Foreign Business.** **S**TATISTICS of our foreign trade in merchandise and produce for the fiscal year

1892-93 show a grand total during the twelve months ending June 30 last of \$1,772,238,329, a decrease of approximately \$70,800,000, or 3.8 per cent., as compared with the year ending June 30, 1892, due largely to decreases in values of breadstuffs and cotton exported last year. Comparative totals are as follows:

Year ending June 30.	1892.	1893.
Total values, free of duty.....	\$457,999,658	\$519,520,306
Total values, dutiable.....	399,402,804	421,841,115
Total values, importations....	\$827,402,462	\$941,361,421
Total values, domestic exports	1,015,732,011	830,876,908
Total values, foreign trade.	\$1,843,134,473	\$1,772,238,329

One of the most striking decreases in values of dutiable goods imported in 1892-93 was in jewelry, the values being \$12,972,938 in 1892 against \$5,865,208 in 1893, or a decrease of fifty-five per cent. As the classes of merchandise that suffered decreases were

few, it is plain that the undecided course of the Democratic administration with respect to the tariff cannot be assigned as the reason for the great decrease in jewelry imports. As the word jewelry in this connection refers principally to precious stones entering into the manufacture of jewelry, it is only to be concluded that our trade as far as jewelry is concerned during 1892-93 was far from prosperous. The values of the imports of clocks and watches were approximately equal, \$1,930,538 in 1892 to \$1,997,982 in 1893, as were the exports of these articles, namely \$1,229,616 to \$1,204,181.

### The Week in Brief.

**M**AX OLENICK, Minneapolis, Minn., made an assignment—Taylor & Bro., New York, are in financial difficulties—M. C. Kummerer, Minneapolis, Minn., assigned—Harry U. Rogers, Luverne, Minn., made an assignment—J. W. Loewenberg, St. Paul agent for F. M. Sproehle & Co., Chicago, charged with embezzlement, waived examination—Joseph W. Dupont, Minneapolis, filed his schedules—The businesses of Hager & Hetsch, A. Goldstein, and W. P. Brandenburg, Louisville, Ky., were damaged by fire—E. P. Wheeler, Paterson, N. J. has sued the thief who recently robbed his store—C. G. Schlenker, Eaton, O., assigned—The store of Adolph Ballot, Boise City, Idaho, was closed by the sheriff under attachments—The store of Henry Salzberg, Paterson, N. J. was robbed—The monthly meeting of the executive committee of the Jewelers' Security Alliance was held—The store of Marsh & Hoffman, Albany, N. Y., was damaged by water—Alfred B. Stead was charged with larceny by his father George Stead, San Francisco, Cal., and with embezzlement by Nordman Bros., same city—W. C. Pfaeffle, Fort Worth, Tex., failed—William T. Gardner, Paterson, N. J., sued Mrs. Jamie McKenzie and her husband for \$10,000 damages—L. M. Braham & Son, Cincinnati, O., assigned—William Beary, an old time clockmaker of New York, died in Rochester, N. Y.—An explosion occurred in the workrooms of Heeren Bros. & Co., Pittsburgh, Pa.—The window of Forsythe & Hoffman, Philadelphia, Pa., was blown in during a storm—The death occurred of John L. Richards, an old jeweler of Boston, Mass.—Messick & Co., Millington, Md., were robbed—The store of J. W. Vincent, Snow Hill, Md., was burned out—Robert Smith, Hamilton, Ont., assigned—Frank Reilly, successor to Reilly, Curtis & Co., Chicago, gave a bill of sale to R. K. Reilly, his brother—The man who robbed W. G. Pollack, of W. L. Pollack & Co., New York, was captured.

A judgment for \$107 has been entered against Genicke & Caspary, formerly in the jewelry business in Detroit, Mich.

### New York Notes.

A judgment for \$1,291.10 has been entered against Jacob M. Marcus.

John E. Shepard has obtained a judgment for \$74.50 against William K. Walton.

Horowitz & Hershfield have obtained a judgment for \$400.43 against Wolf Glass.

T. G. Frothingham & Co. have obtained a judgment for \$374.16 against Moritz Moos.

The judgment for \$328.92 entered June 19, 1893, against Mordecai S. Kauffman by B. Schnitzer, has been satisfied.

Father Vinez, the eminent Cuban meteorologist, died at Havana July 23d. He was noted as a practical optician and mechanic.

The following judgments were entered last week against F. J. Kaldenberg by the Nassau Bank for \$1,019.03, \$1,349.87 and \$562.47.

L. Maynz, of Edward Posen & Co., 523 Broadway, now represents Martin Mayer, of Mainz, Germany, as his sole agent in this country.

E. O. Ovington, Brooklyn, N. Y., sailed Saturday for Europe on the *Umbria*. H. Bertrand Nemitz left the same day on *La Champagne*.

R. H. Schweikert & Co. have opened a thoroughly equipped factory at 20 Maiden Lane, where they will manufacture fine diamond mountings for the trade.

Louis Friedlander, of R., L. & M. Friedlander, accompanied by his wife, has been spending several weeks in the Catskills. They will go thence to the World's Fair.

Benj. S. Wise is showing in his window, at 861 Broadway, the \$2,000 diamond bird which he is selling by subscription for the benefit of the *Evening World's* Sick Baby Fund.

One of the show windows of John B. Hoecker's optical goods store, 312 Fulton St., Brooklyn, was broken last week and a number of gold eyeglass frames and spectacles stolen.

H. C. Barthman, son of Wm. Barthman, has been unanimously elected captain of Co. 1, of the 47th Regt. Mr. Barthman enjoys the distinction of being the youngest captain in the New York National Guard.

Simon Fink, of Fink, Bodenheimer & Co., who is now in the west, has been appointed to look after the interests of the New York creditors of Leo Hollander, of Salt Lake City, Utah, who recently failed. He will visit Salt Lake City this week.

The following judgments against Solomon Ryshpan have been satisfied: one for \$253.54, entered Feb. 5, 1887, by A. Sussman; one for \$116.60 entered May 9, 1884, by H. Hershkowitz, and one for \$66.72 entered May 10, 1886; by M. Shidlorsky.

Chas. S. McCulloh, receiver for the Non-Magnetic Watch Co. of America, has obtained a judgment for \$89,673.43 against Aeby & Co, of Madretsch, Switzerland, for money advanced in 1888 and 1890. It may

be well to mention that the plaintiffs have no connection with the present Non-Magnetic Watch Co.

The offer of settlement at 25 per cent. cash, made by Henry Abbott & Co., has been generally accepted by the creditors of that firm. W. C. Garrison, the assignee, told a CIRCULAR reporter that creditors representing a majority of the indebtedness had already signed the agreement to accept that amount for their claims.

The report that the Brooklyn Watch Case Co.'s factory, Brooklyn, had shut down temporarily was denied at the New York office of the company. It was there stated that the company had closed the factory on Mondays and Saturdays, as they had done every Summer, and this action had probably given rise to the report.

Samuel Bobier, 305 Madison St., was arrested last week on the complaint of his employer, Nathan Frank, jeweler, 26 Bowery, who in the Tombs Police Court, Wednesday, charged him with stealing nine silver watches, valued at \$175. Bobier claimed that they were not worth \$20 and says that Frank owed him that amount. The prisoner was discharged from custody the following day.

The judgment entered June 27th by B. F. Snow, against Bisbee, Swift & Co., Plainville, Mass., has been satisfied. The judgment was the result of a suit brought by Snow, a former employe of the defendants, for salary due, on the claim that he was discharged before his contract with them had expired. The case was tried in the City Court June 23d. The jury rendered a verdict for the plaintiff for \$289.74.

The beautiful solid silver, gold lined smoking service which was presented to ex-Collector Hendricks, at the Custom House on Aug. 5th, was made by Tiffany & Co. Around the body of the urn is portrayed in raised work the finish of a steeplechase, while above it is this inscription: "Presented to the Honorable Francis Hendricks by the attachés of the New York Custom House, in testimony of their sincere regard, August, 1893."

Simon Sternberg, brother of Moritz Sternberg, Savannah, Ga., was arrested in this city last week. When arraigned in the Tombs Police Court Thursday the technical charge against him was as a suspicious character, but it is said that this charge was merely to hold him until the arrival of requisition papers on which he was to be taken to Savannah, where, it is charged, he had committed forgeries aggregating \$3,000 in amount. Monday morning, however, he was discharged. This is the brother to whose speculations Moritz Sternberg attributed his failure.

Clarence E. Breckenridge, of the Wilcox Silver Plate Co., who lives at Maywood, N. J., was badly injured in a runaway accident Sunday evening, while returning from a drive to Englewood with his wife and some friends. Mr. Breckenridge was thrown over the dashboard, and his

head was badly scraped and his body bruised. His wife and friends were injured by the upsetting of the carriage. It is said at the office of the Wilcox Silver Plate Co., 6 Maiden Lane, that Mr. Breckenridge is improving and is expected there to-day or to-morrow.

The man whom the police say is Michael Moriarty, alias "Mike the Dude," was released from custody Thursday. He was arrested on the Bowery, Aug. 7th, by one of Inspector McLaughlin's men on the charge of having robbed A. Wollouter, a German jewelry pedler, of \$2,000 worth of jewelry. Three years ago it is said he enticed Wollouter into a saloon in Bond St., gave him drugged liquor and then robbed him. He then escaped and later, it is claimed, committed a daring jewelry robbery in Paris and another in London. The New York police were unable to find Wollouter, whom they believe is dead; thus no complaint could be entered against the prisoner and he was discharged.

Henry P. Sandford, jeweler, 823 Broadway, on Thursday caused the arrest of Mary Towle, twenty-two years old, on the charge of larceny. Sandford stated that the woman came to his store and asked to see some rings. After looking over a couple of trays she selected a moonstone ring worth \$250, and saying she would call again started to leave the store. He asked her if she did not wish to buy the one she had in her hand, and when she denied having it he told her she must pay for it or he would have her arrested. Upon her refusal to do so he carried out his threat. No ring was found on her when she was subsequently searched at the Mercer St. police station, and she was then arraigned in the Jefferson Market Police Court. On both telling their story, Justice Hogan had Miss Towle sent to her employers, where so good a character was given her that Sandford finally agreed to withdraw the complaint if Miss Towle would sign a paper not to sue him for false arrest. This was done and the girl was discharged.

### A Probable Settlement in the Failure of M. Fox & Co.

At a meeting of the creditors of M. Fox & Co., held at the office of that firm, 1 Maiden Lane, New York, Thursday, the investigating committee, composed of Benno Loewy, W. B. Durand, Henry Fera, R. A. Breidenbach and J. G. Doty, reported in favor of accepting the following proposition: 40 per cent. in all; 5 per cent. cash, 15 per cent. Jan. 15, 1894, 10 per cent. July 15, 1894, and 10 per cent. Jan. 15, 1895.

All the creditors present agreed to accept this settlement, and it will be considered by M. Fox. If he consents to the agreement and his attorney has unofficially stated that he will do so, the settlement will probably be consummated, as the preferred creditors agree to the stipulation that they put in claims for no part of their preferences until the settlement has been carried out.

Richest

# CUT GLASS

FROM OUR OWN WORKS IN THIS CITY.

None but the Highest Grade in Quality and Workmanship.

LARGEST ASSORTMENT.

MOST MODERATE PRICES.



CARAFE, 455 | 53. COLUMBUS.

A LARGE variety of new and strikingly original shapes and many new cuttings, protected by U. S. Patents.

◆ ◆ ◆ ◆ ◆

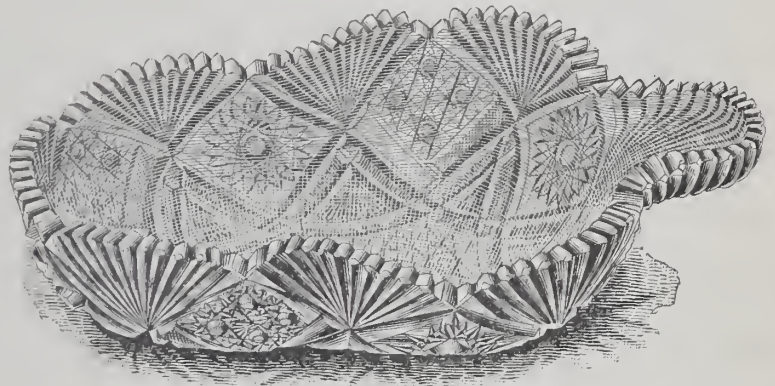

SALAD, 434 | 55. LARABIDA.



PITCHER, 453 | 58. BRAZILIAN.

## L. STRAUS & SONS,

MANUFACTURERS,

42, 44, 46 AND 48 WARREN ST.,

AND 116 CHAMBERS ST.,

NEW YORK.

---

See our Exhibit at the World's Fair, in Section H,  
of the Manufactures Building.



## Our Traveling

## Representatives

Traveling representatives may consider these columns open for the publication of any news or items of interest regarding themselves or their conferees.

AMONG the jewelers of New York and other large cities of the United States W. Wallace Detrick, traveler for J. N. Provenzano, 39 Union Square, New York, is well known and popular. He is a native of the Blue

Grass State, he having been born in New Albany, Floyd Co., Ky, in 1852. From his fifteenth year he has been connected with the jewelry trade in almost every capacity and may be said to know it root and branch. After leaving the Indiana Asbury University, at Greencastle, Ind., where he received his education, he

first entered business with R. Bratton, of that place, with whom he served his apprenticeship in watchmaking, remaining five years. Later he was employed by Harry Craft, Indianapolis, and then by Geo. W.

Chatterton, Springfield, Ill., as a watchmaker. In 1880, he left the latter to accept a position as salesman with the Mermod & Jaccard Jewelry Co., St. Louis, Mo., which position he retained until he started in business two years later as a retail jeweler at Alamosa, Col. A year and a half later, he sold out his business and became a salesman for Giles, Bro. & Co., Chicago. His next position was as traveler for Clapp & Davies, Chicago, with whom he remained until his health broke down about eighteen months later. Recuperated by a trip through the south, he went to New York, and became a salesman for Wm. Moir. After five years he gave up this position to take charge of the watch department of Black, Starr & Frost, in which capacity his early training proved of great advantage. Another breakdown in his health three years later caused him to resign and seek employment less confining. He therefore accepted his present position with J. N. Provenzano, his particular territory being New York, Brooklyn, Washington, Philadelphia, Baltimore and Boston. In April, 1889, Mr. Detrick married the niece of Judge Beebe, deceased, of New York. His forty-one years sit lightly on him, as he is still as young and enterprising as any of the travelers in the trade. He will take a trip to Chicago late this week, where he will combine business and pleasure, meeting his many friends in that city

W. WALLACE DETRICK.

and visiting the World's Fair at the same time.

Fred Leigh left Chicago for the south the past week in the interests of Wm. B. Durgin's western office, 1303 Columbus Building.

Mr. Medbury, F. M. Whiting & Co.; Mr. Wood, Howard Sterling & Co., and Mr. Mutzger, L. H. Keller & Co., were in Springfield, Mass., last week.

The engagement is announced of William G. Snow, salesman of the Meriden Britannia Co., to Miss Bessie Taylor, daughter of Charles L. Taylor, of Meriden.

Z. E. Chambers has resigned as traveler and house salesman for Lapp & Flershem, Chicago, and has accepted a similar position with B. F. Norris, Alister & Co., same city.

Among the travelers in Pittsburgh, Pa., last week were: Fred J. Foster, Unger Bros.; L. Smith, M. B. Bryant & Co.; H. Foster, Whiting Mfg. Co.; R. B. Steele, J. B. Bowden & Co.

Frank H. Walker, representing J. N. Provenzano, 39 Union Square, New York, is now covering the entire south, where he is showing a full line of the Fall novelties manufactured by his firm.

T. F. Sands, traveler for Holmes & Edwards Silver and Manhattan Silver Plate Co.'s, in Iowa and Nebraska, returned to Chicago Friday week and left the present week for the same territory.

Fred. L. Pettee, representing the Waterbury Clock Co., and A. E. Hall, representing the Holmes & Edwards Silver Co. and the Manhattan Silver Plate Co., called on the Twin Cities dealers last week.

Willard H. Wheeler has assumed charge of the office of Hayden W. Wheeler & Co., 1306 Columbus Building, Chicago. T. H. Hollister, formerly in charge of the office, left for New York Aug. 8th, and will shortly leave for his western territory.

Representatives of eastern houses in Chicago last week included Harry Bliss, Kremetz & Co.; W. T. Gough, Carter, Sloan & Co.; Billy Elcox, Larter, Elcox & Co.; L. H. Smith, Bippart & Co.; E. S. Luther, D. F. Briggs Co.; J. Peacock; J. L. Sweet; Dick Robinson, T. G. Frothingham & Co.

Jewelry travelers in Boston last week included: E. R. Horton, J. B. Bowden & Co.; Eugene H. Cox, Sussfeld, Lorsch & Co.; Fred Clarkson, Snow & Westcott; T. B. Wilcox, T. F. Fessenden; James M. Morrow, Columbus Watch Co.; H. C. Rowbotham, H. Muhr's Sons; G. B. Osborn, Wm. Smith & Co.

The following traveling men stopped at Indianapolis, Ind., last week: Fred L. Pettee, Waterbury Clock Co.; C. M. Davis, New Haven Clock Co.; E. A. Tyler, Ansonia Clock Co.; A. Marshuetz, Spencer Optical Mfg. Co.; A. R. Varian, Dennison Mfg. Co.; R. L. Moorhead, R. L. Moorhead & Co., and I. Guntzburger.

Traveling men were scarce in Detroit,

Mich., last week. Among them were the following: S. W. Abbey, E. Ira Richards & Co., C. E. Dorr, Gorham Manufacturing Co.; F. J. Foster, Unger Bros.; D. H. Lowman, Lissauer & Co.; Mr. Steele, J. B. Bowden & Co.; C. M. Davis, New Haven Clock Co.; W. T. Gough, Carter, Sloan & Co., and a representative of Jos. Fahys & Co.

Morris J. Schuster, the popular representative of R., L. & M. Friedlander, New York, has just returned from his vacation spent at the Atlantic Highlands. Abe Harris, western representative of this firm, after taking a two weeks' vacation at Asbury Park, has just started on the road in the interest of his firm. The many friends of Louis Moss, traveler for Messrs. Friedlander, will be pleased to hear that Mrs. Moss has survived a very painful and dangerous operation and is now on the road to health.

### Boston.

C. D. Place has given a chattel mortgage for \$1,400.

A. C. Howell has given a chattel mortgage for \$1,550.

W. H. N. Pratt, of Floyd, Pratt & Co., is at Cottage City for a few days' vacation.

H. A. Pearson, formerly of Lynn, has returned to his native city and opened a new store on Market St.

The assignees of E. C. Woodworth estimate that he will pay ten cents on the dollar and resume business.

Capt. E. D. Smith, of Dover, N. H., and D. C. Barrows, of Willimantic, Conn., were here as buyers last week.

F. A. Robbins, Pittsfield, has been entertaining James C. Donnell, of the Ripley-Howland Mfg. Co., Harry F. Hayes, of this city, and Fred Sloan, of Hartford.

H. B. Mason, of H. B. Mason & Co., Washington, who goes to Bridgeton, Me., on his vacation, stopped over for a brief visit to the trade in this city on his way thither.

Among the deaths of the week is that of John L. Richards, one of Boston's oldest jewelers, who has passed away at his home in the Charlestown district. Mr. Richards was seventy-eight years old. For many years he had a store on Brattle St. in this city.

The creditors of James F. Fitzmorris, instalment dealer in furniture, watches, etc., Marlboro, held a meeting in this city Tuesday last. Mr. Fitzmorris submitted an offer of twenty cents, but the creditors thought they ought to have twenty-five, and the debtor said he would try to pay it.

The new offices of the Plainville Stock Co., Plainville, Mass., are handsome and roomy. They are located in the recent addition to the buildings, and windows at three sides insure ventilation and light in plenty.



THE BEST QUALITY

# ELECTRO SILVER PLATE

IS STAMPED

★ ROGERS & BRO., A. I.

THE  
Original, Genuine  
and  
Celebrated

# STAR ★ BRAND

WHICH  
HAS STOOD THE  
TEST FOR 50 YEARS.

MADE ONLY BY

## ROGERS & BROTHER,

WATERBURY, CONN.

16 CORTLANDT ST., NEW YORK.

MAKERS OF THE FOLLOWING LEADING PATTERNS:

"COLUMBIA," "SAVOY," "TUXEDO" AND "ASSYRIAN."

NEW ILLUSTRATED CATALOGUE NOW READY.

"COLUMBIA"



"SAVOY"

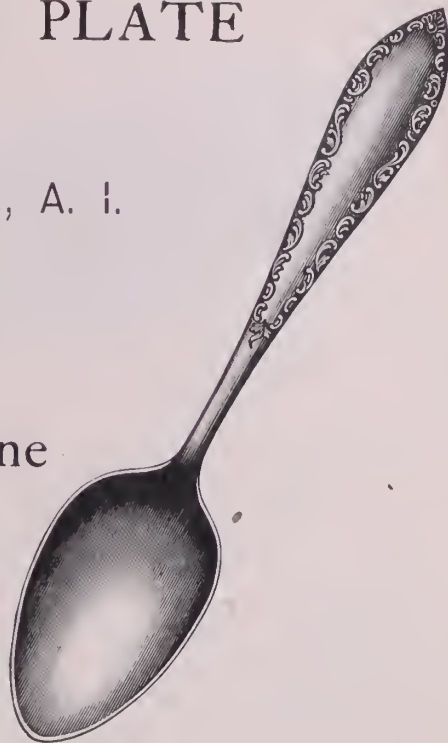

"TUXEDO"



"ASSYRIAN"



FACTORY AND SALESROOM  
PHILADELPHIA,  
616 & 618 CHESTNUT STREET,  
611 & 613 SANSOM STREET.



NO. 20.

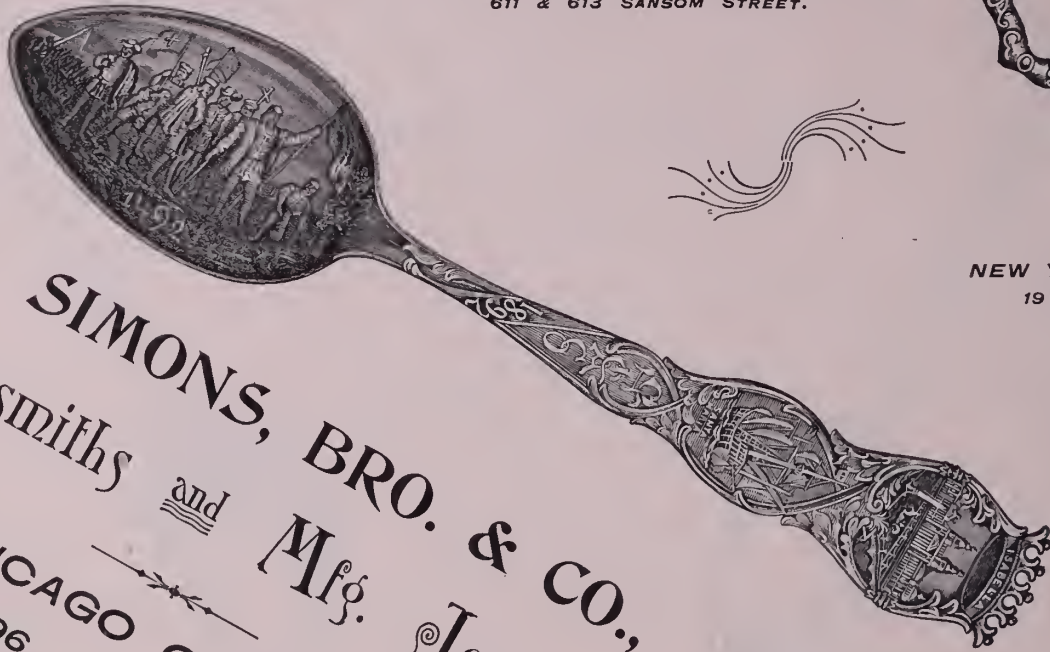

NEW YORK OFFICE:  
19 MAIDEN LANE,

SIMONS, BRO. & CO.,  
Silversmiths and Mfg. Jewelers.  
CHICAGO OFFICE:  
96 STATE ST.

As Regards

SILVER PLATE

WE BELIEVE

THAT an Honest article at an Honest price goes further toward making sales than all the advertising in Christendom,

AND WE WORK ACCORDINGLY.

MAKING and SELLING a BETTER Article for the SAME Money, or an EQUAL Article for LESS Money than any other concern, is the principal cause of our fast increasing business.



2028.—SYRUP AND PLATE.

HOMAN & COMPANY,  
CINCINNATI.

 Visitors to the Columbian Exposition, Remember our Complete Line is displayed at  
155 STATE STREET, CHICAGO.

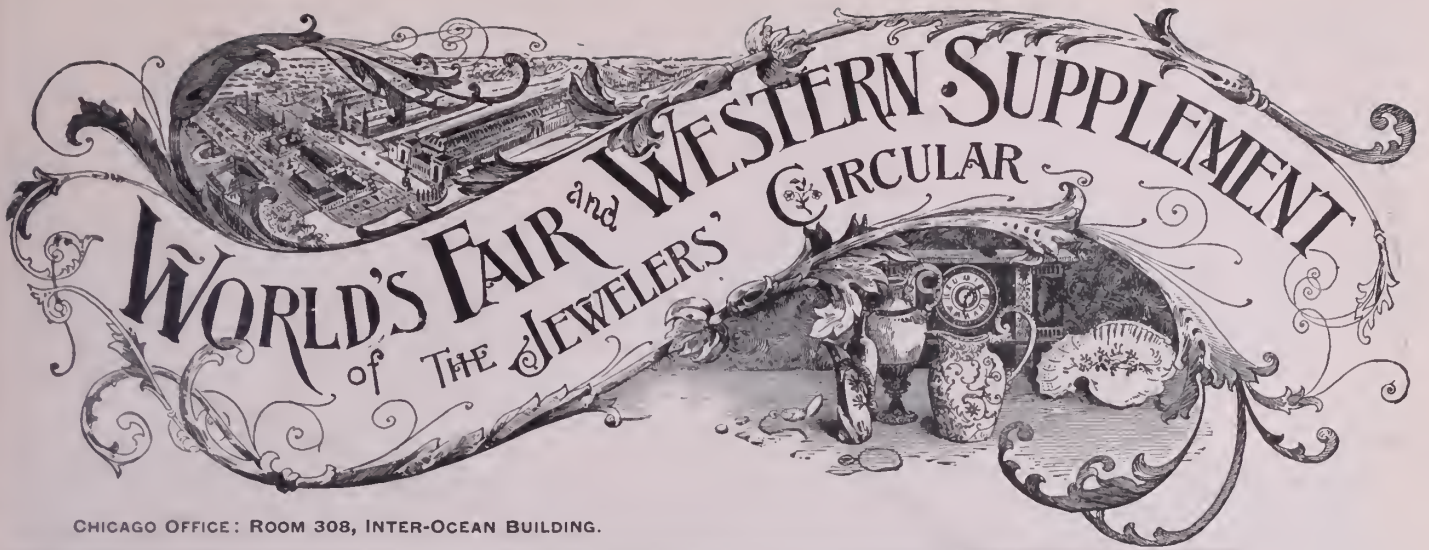

CHICAGO OFFICE: ROOM 308, INTER-OCEAN BUILDING.

VOL. XXVII.

CHICAGO, WEDNESDAY, AUGUST 16, 1893.

NO. 3.

THE INTERESTING EXHIBIT OF ALBERT LORSCH & CO.

IN a previous series of articles under this department, devoted to a consideration of the collective exhibit of the New England Manufacturing Jewelers' Association, a full description of the exhibit of Albert Lorsch & Co., 37 Maiden Lane, New York, was given. However, as an opportunity to give an illustration of the exhibit is now afforded, it is in place to point out to the reader some of the salient features of the display.

The firm have an exhibit that not only

the same azure hue. These cases are raised about three-quarters of an inch above the white velvet base, and serve as receptacles for displaying the wares of the concern.

Conspicuously resting on the circular disk as though upon a sea of foam-crested billows is a two-masted square-rigged miniature model of the ancient flagship *Santa Maria*. The vessel is complete and a most beautiful feature. It is painted pure white,

with all the care and precision of a genuine stone. They are constructed of wood and painted white, but are made to glitter and blaze beneath the rays of the electric light by the closely set Sumatra gems by which they are covered.

The two long and narrow cases are filled with Sumatra gems and numerous other kinds of precious and imitation stones used in jewelry manufacture. Heavy plate glass signs decorated with gilt lettering



ALBERT LORSCH & CO.'S EXHIBIT OF SUMATRA GEMS.

displays their stock of goods to advantage, but also symbolizes and emphasizes the event which the Exposition was designed to commemorate. The effect is pleasing and harmonious. The entire space allotted to them, two by five feet, is covered with snow white velvet, which forms a striking contrast for the two long, narrow, rectangular cases of blue velvet, and the circular case about one foot in diameter, in the center, of

and is thickly studded along its sides by the Sumatra gems, the well known specialty of this house. The sails of the caravel are of ribbed silk and bear a Spanish cross, the contrasting effects being truly pleasing. On either side of the vessel is to be seen an immense fac-simile diamond that is one of the most unique ideas in the entire exhibit. These "diamonds" are about six inches in diameter and are cut and faceted

disclose the name and address of the principal offices of this enterprising and progressive firm. The entire display presents a uniquely rich appearance, and is one of the sights of the jewelry section. The extraordinary brilliancy of the Sumatra gem is universally lauded, and its place in popular favor after the Fair will certainly be an enviable one. Altogether Albert Lorsch & Co. are among the successful exhibitors.

## Rochester Lamps at the World's Fair.

FACING south on the broad street that separates it from the center section of the French Government, the Rochester Lamp Co.'s exhibit, resplendent in its glitter of glass, porcelain and metals, is the subject of universal attention. The pavilion itself is a work of art. Wide avenues are on the four sides of the exhibit and the rich cherry colored structure is accentuated by the white pavilions about it. The entire space, 21x36 feet, is availed of to the best possible advantage.

by twelve square finely carved columns.

From the paneled ceiling are suspended a score of hanging lamps of artistically wrought iron and brass. At the east side is a black display column on which are exhibited bracket lamps in a variety of grades and sizes. In the center of the room stands a large display table on which is a choice selection of porcelain, silver, gilt and iron lamps, the combinations of porcelains and gilds, irons and porcelains, and silver, gilds and porcelains being beautiful gems of the designer's art and worthy the close examination of the connoisseur in art forms. Scattered throughout the building are large

the company for their Exposition display. It is located at the right in the illustration. Beautiful lamps are shown in pink, yellow, opal and blue Pantin ware, in the firm's special designs. The decorations on the bodies include Prince of Wales plumes, bow knots, fleurs-de-lis, pansies and crescents, as well as plain bodies, with chiffon shades to match.

In all Pantin wares shown the vase portion consists of a round body, from which rises a slender neck, slightly flaring at the top, on which rests the round lamp body. The design is highly artistic and one of the most beautiful shown in lamp lines. In cut

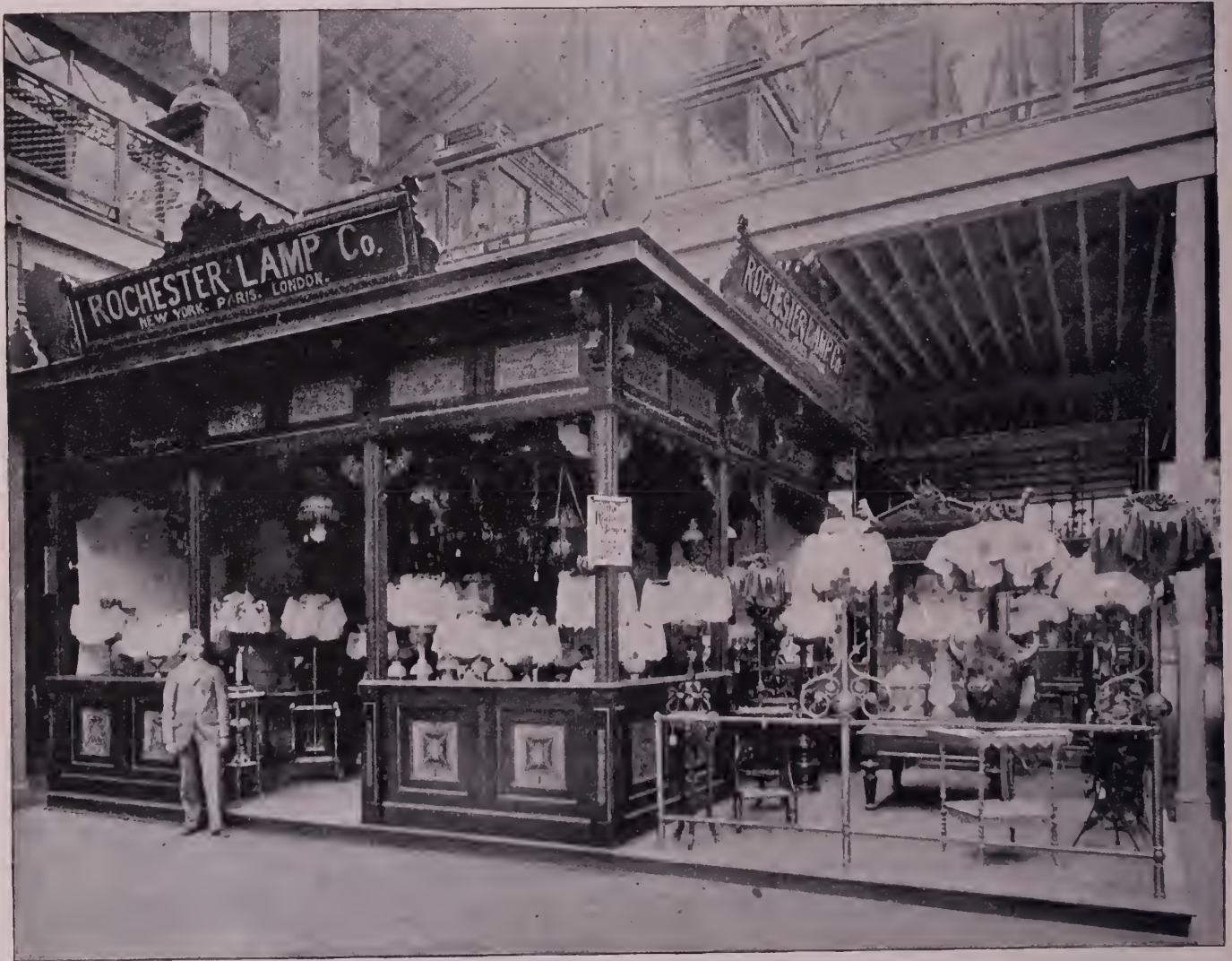

THE EXHIBIT OF THE ROCHESTER LAMP CO. AT THE WORLD'S FAIR.

The lofty pavilion occupies 21x26 feet at the west end of the space. An elevated platform, 6 inches high, is carpeted with light and dark woods in handsomely pressed designs closely resembling inlaid woods. About the pavilion section runs a closed rail four feet high, paneled inside and outside with "inlaid" designs. Seven-foot entrances open from the north and south, and four-foot openings from the east and west. Above, an artistic "inlaid" roof curved at the four sides is richly paneled in inlaid, and the two-foot paneled frieze is supported

numbers of banquet, table and piano lamps of exquisite beauty. Handsome banquet lamps are shown in Sèvres bodies with paintings by Lafarge, Collot, Lohberger and others of repute, with revolving vases from which the receptacle may be removed and the vase used for decorative purposes.

There are lamps in wrought iron and bell bronze; a gilt lamp made by this company for Buffalo Bill, and presented by the latter to President Carnot, of France. The French President being prohibited from receiving presents, Mr. Cody loaned it to

glass goods is shown the first lamp—a banquet—ever made for a Rochester burner. The entire lamp is of cut glass with the exception of the receptacle. The body rests upon a cut glass column and is 28 inches from the base to burner. Another cut glass lamp is supported on a gilt stand with a gilt Pegasus ornamentation on either side below the glass body. The top of body is decorated with a gilt rim, into which the receptacle fits, and gilt brackets and shade holder support a cut glass shade. The chimney even, is of cut glass.

A beautiful thing is shown in a combination music rack and floor lamp, the rack being of light Mexican onyx with solid brass trimmings lacquered to prevent tarnishing. The medal winner over all competitors at the Paris Exposition is exhibited, a combin-

ful pieces shown would fill a large volume, but the extent of the Rochester Lamp Co.'s business may be inferred when it is known that they have 2,700 different artistic designs, with offices at 42 Park Place and 37 Barclay St., New York; London, Old Swan Wharf;

# Great Reduction!

## COLUMBUS 6 SIZE MOVEMENTS.



No 50. GILT, 7 Jewels, Tempered Hair Spring. Fine White Hard Enamel Dial. Regular Price, \$9.00 List. Our Price, \$7.00 List.

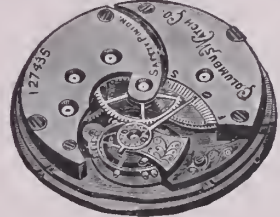

No. 51. GILT, 11 Jewels, Upper Holes Jeweled, Tempered Hair Spring, Sunk Seconds Dial. Regular Price, \$11.50 List. Our Price, \$9.00 List.



No. 52. NICKEL, 11 Jewels, Upper Holes Jeweled, Tempered Hair Spring, Sunk Seconds Dial. Regular Price, \$12.50 List. Our Price, \$10.00 List.



No. 54. NICKEL, 13 Jewels, in Red Gold Settings, Tempered Hair Spring, Sunk Seconds Dial. Regular Price, \$14.00 List. Our Price, \$11.00 List.



No. 55. NICKEL, ADJUSTED, 15 Jewels, Set in Red Gold Settings, Tempered Hair Spring, Sunk Seconds Dial. Regular Price, \$20.00 List. Our Price, \$14.00 List.

FULL LINE OF EVERYTHING NEEDED BY JEWELERS.

**OTTO YOUNG & Co.,**  
CHICAGO, ILL.



EXHIBITION ROCHESTER LAMPS, NOW IN WALDORF HOTEL, NEW YORK.

ation of onyx and solid brass of rare beauty. In Pantin ware banquet lamps a choice piece is shown with filigree brass work nearly covering the vase with filigree work about the brass lamp body and a filigree brass shade, matching the design on the vase, over yellow silk. The same filigree design on Pantin ware is shown in Nile green with a silk shade of the same color

Paris, Rue Scribe. The World's Fair exhibit is in charge of Charles A. Pomeroy, for four years connected with the wholesale department. Mr. Pomeroy is one of those gentlemen whom it is a pleasure to meet. To each visitor is presented a numbered souvenir card, the holder of one of which will be entitled to a \$100 lamp at the close of the Exposition.



EXHIBITION ROCHESTER LAMPS, NOW IN WALDORF HOTEL, NEW YORK.

and lace to match. The court on the east side of the pavilion has in the center a large upright display case containing as a center piece a banquet lamp composed of a Royal Worcester vase with mat gold decoration. The shade is of rainbow chiffon with a deep fall of lace. About this are silver table lamps with decorated porcelain shades.

About the court runs a brass rope rail with posts carried upward in a piano lamp extension. The details of the many beauti-

The new fork and spoon pattern shown by Reed & Barton, Taunton, Mass., is very handsome. The samples shown at the Chicago office, room 204, 34-36 Washington St., comprise table, dessert, tea and after dinner coffee spoons, medium and dessert forks and oyster spears. The pattern is a rococo border on a polished handle, with long, fluted shank, and is pretty and tasteful.

## L. Straus & Sons at the World's Fair.

(Continued from page 31, Aug. 2.)

ONE of the larger pieces shown in the exhibit of cut glass of L. Straus & Sons, 42-48 Warren St., New York, at the World's Fair is the Columbus Egg punch set, which, though smaller than the won-

orate in detail. The shapes lend themselves effectively in bringing out the richness and brilliancy of this beautiful design.

A careful examination of the workmanship expended on the bowl and platter shows them to be among the remarkable features of the exhibit. One of their chief characteristics is the thickness of the glass which is far greater than is customary in pieces of this kind. So heavy are the pieces that it

that when the cover is on it is almost impossible to perceive the line of separation, the piece having the appearance of a solid egg of cut glass.

Coming to the smaller articles, those of ordinary size, the visitor is confronted with a variety which is veritably confusing. In salad and berry bowls alone he sees one of the greatest assortments ever brought together. Originality in shapes seems to

be one of the strong points in the product of this concern; they are not copies even in the slightest particular, but are wholly original and unique.

It is in the smaller pieces that the variety of new rich cuttings, the Grenada, Castillian, Santa Maria and Larabida, are so beautifully shown, particularly in the deeply cut decanters, water bottles, wine pitchers, flower vases, bowls, oil bottles, olive dishes and articles of this kind.

Before closing this article, mention should be made of a decanter, the size of which alone makes it an object of exceeding interest. It stands over 40 inches high and is believed to be the largest decanter ever cut. The stopper which is a beautiful example of lapidary cutting, weighs over thirty pounds. Few who see this piece can appreciate the difficulties and expense attending its manufacture, two similar bottles being broken in the cutting before this perfect one was obtained.

To those who have been among the crowds which constantly swarm about the pavilion of L. Straus & Sons, its importance as one of the principal features in the Manufactures building is well known, and they will doubtless agree in saying that in the magnificence of the large pieces, the originality of the shapes and the rare beauty and brilliancy of the designs, this exhibit stands unsurpassed.

### A Beautiful Exhibit of Cut Glass Bottles.

ONE of the displays at the World's Fair that is receiving much praise is that of Lazell, Denney & Co., New York, perfumers.



COLUMBUS EGG PUNCH SET. L. STRAUS & SONS' EXHIBIT.

derful electroabra and the beautiful épergne described in THE CIRCULAR of Aug. 2, is nevertheless among the most interesting pieces of the display. As the name indicates, the shape of the bowl is that of the fabled egg with which the great discoverer is supposed to have taught the Spanish savants a lesson in sharp practice.

The punch bowl rests on its smaller end on a large platter, 26 inches in diameter, surrounded by two dozen punch cups, similar in shape. The cutting throughout the set is in the new "Columbus" pattern, which consists of a beautiful combination of ovals alternately filled in with stars and double cut hobnails and is very elab-

required four men to hold the platter alone during the process of cutting. With such perfection does the pattern continue from the body of the punch bowl to the cover,

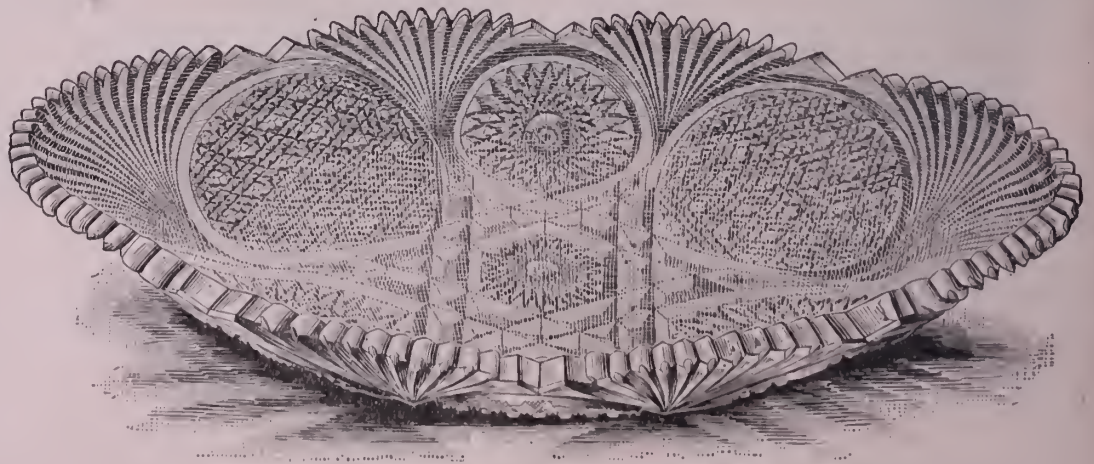

FRUIT DISH IN COLUMBUS PATTERN. L. STRAUS & SONS' EXHIBIT.

The display consists of a large pyramid of cut glass bottles of perfumery, mounted beautifully in silver, and placed in a large glass case so that a tiny electric light bulb is directly underneath each bottle, producing a most bewildering and dazzling effect. The bottles vary in size from one which at the base can just be encircled by a person's

**Horological Novelty at the Fair.**

MARCUS Benjamin, of Sydney, exhibits in the New South Wales section in the Manufactures building, an independent dead beat center seconds stop watch with one train, invented and patented by the exhibitor. To get a full second with one beat, a watch of this kind was formerly made with two movements. By this improvement the mechanism for the center second move-

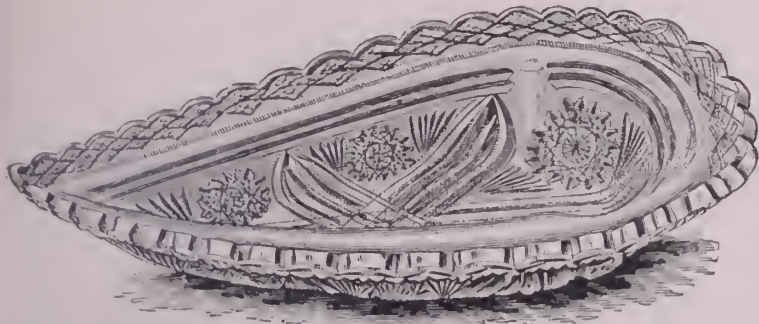

DISH IN SANTA MARIA PATTERN. L. STRAUS & SONS' EXHIBIT.

extended arms to one tiny in proportions. The cutting of the bottles was all done in Corning, N. Y., by T. G. Hawkes & Co.

Great expectations had been formed of ruby mines alleged to have been discovered by the Ameer of Afghanistan about six miles from Paghman, near Cabul. The specimens sent by the British agent at Cabul to the Indian Government have, however, proved to be worthless quartz.

ment is reduced by 75 per cent., and the full beat second is recorded with the same movement. This watch is made on the best principles, many other improvements having been effected by the exhibitor, all of which and the setting of the jewels are in gold, as well as the mounting of the case.

A. Grubener, of Hanau, shows bracelets, fobs, chatelaines and neck chains in which many pretty links are noticed. A specialty is a two strand flat braid bracelet of gold set with gems.

**The Case of H. Bertrand Nemitz Discharged.**

CHICAGO, Ill., Aug. 12.—H. B. Nemitz appeared in Justice Porter's court this week to answer to a charge of embezzlement. Consul Holinger, the prosecuting witness, did not press his case and Nemitz was discharged. The defendant was accused of misappropriating watches and money, the property of Swiss exhibitors at the Fair. He was brought back from Canada to answer charges, but the prosecution was dropped, as was predicted in THE CIRCULAR.

Saturday Mr. Nemitz wrote the following letter to a Chicago paper:

CHICAGO, Aug. 5.—*Editor of The Evening Post:* Referring to an article in your issue of Friday, Aug. 4, 1893, headed "Nemitz is Exonerated," I beg to state that to my knowledge no cable has been sent from the exhibitors of Geneva as to my reinstatement and the recall of Mr. Perrenoud as commissioner.

My innocence on the charge of larceny and embezzlement being acknowledged and the difficulty between the Swiss commissioner and myself having been settled amicably, I shall leave for Switzerland, and I hereby declare publicly that I do not have any bad feeling toward Arnold Holinger and James Perrenoud.

H. BERTRAND NEMITZ.

The jewelry trade has been presented with an artistic advertising card by which Rogers & Bro., Waterbury, Conn., and 16 Cortlandt St., New York, call attention to the special merit of the famous ★ Rogers & Bro. A1 silver plated ware. On the front page of this card is a half-tone illustration of the celebrated painting "L'Etoile Double."

**DIRKSEN SILVER FILIGREE CO.,**

MANUFACTURERS OF

**STERLING © SILVER © SOUVENIR © SPOONS.**

© Napkin Rings, Trays, Vases, Card Cases. ©

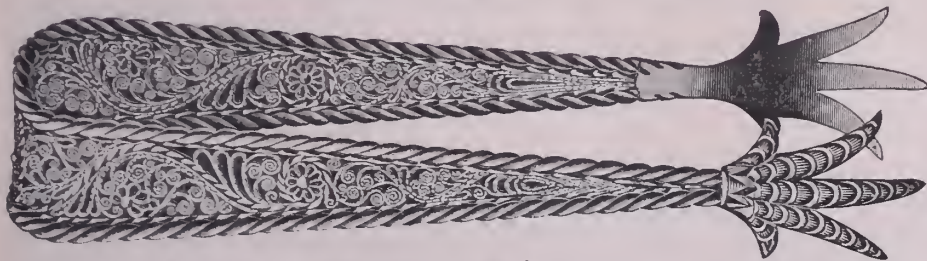

SPECIAL DESIGNS  
AND  
PRESENTATION .: PIECES  
MADE TO ORDER.

See our Exhibit, Section N, Manufactures and Liberal Arts Building, World's Fair, Near Tiffany's.

Send for our New Catalogue and Price List.

**FREEPORT, ILL.**

MOSELEY & COMPANY, ELGIN, ILL., would call your attention to the fact that they had planned to have an exhibit at the World's Columbian Exposition, and after many delays had space assigned, not where they expected it, but in Machinery Hall. During this time orders came in thick and fast, and our stock was so near exhausted that we could not make (to us) a satisfactory exhibit. Though working fifty men and making overtime we are still struggling to catch up with our orders. And still they come. We intend to have a fair exhibit with all the jobbers in Genuine Tools and Materials in Chicago for your inspection, and those wishing to learn the HOW to do any particular thing on the Moseley Lathe or any of its attachments, can do so by calling at the Chicago Watchmakers' Institute, No. 701 Masonic Temple, where the management will be pleased to give you a practical showing of the operation—which may be worth dollars to you, and other schools you may visit will be pleased to do the same.

Present your card, make known your desires, and you will be cordially received.

Yours truly,

**MOSELEY & CO**

Send for this slip and new Catalogue.



### India's Art Exhibit.

WITH the languorous perfume of sandal wood stealing over the senses, the fragrance of tea saluting the nostrils, and a bewildering display of rich silks, embroideries and hangings, greeting the eye, the visitor enters the East India building. The exhibit is under the superintendence of S. J. Tellery, who at the head of a great commercial firm has been the means of introducing to American eyes the wonderful things found in the East India building.

The establishment of art schools in various parts of the British Empire, of which the firm of S. J. Tellery & Co. have control, has brought into activity many arts which have languished for want of patronage and employment is given to hundreds of native workers. To make a market for these wares, especially in America, has been the incentive which led to the bringing by Mr. Tellery of seven hundred tons of exhibits which fill to overflowing the quaint pavilion erected for their accommodation.

An attraction is found in the fine laces, silks and shawls for which India has so long been famous. Here are the price-less Cashmere shawls, made by hand, and which Queen Victoria delights to give as wedding presents. Here are the cloths of gold and silver, thickly encrusted with the precious metals, the curious stuffs from Poona and Satara, studded with small square cut mirrors and splendid with tinsel. Wax printed cloths of Peshawur and Deesa lie beside the muslins of Delhi and the calicos of Calicut. Then there are the magnificent embroideries in gold and silver thread and in silks, on black and colored grounds, representing an infinite amount of patience and skill.

In another section is found the most beautiful work in hammered and engraved copper and brass and lac inlaid ware, the repoussé work by the artists of Jeypore being exceedingly fine. They are in various forms such as trays, vases, lamp-stands,

frames, bowls and statuettes and will prove valuable souvenirs of this great exhibit. There can be found wrought out in intricate lace designs bon-bon boxes, card cases, frames, bracelets, belt clasps, rose bowls, potpourri jars, such as can be obtained from none but the natives of India. Precious stones are set in unique forms, and while the jewelry does not accord with European taste in all things, it possesses an individuality which makes it interesting.

The carvings in ivory and wood are superb. Then there is the collection of old arms, the swords, spears and bows of the Rajputs and weapons of the Mahrattas, Burmese and others. Swords of the famous Damascus steel can be seen which combine the qualities of hardness, toughness and lightness, the material for which is found in India. With this ancient armor is exhibited a collection of more modern arms of Jeypore, Kutch, Patiala and Hyderabad, of original shapes, but handsomely ornamented with gold and silver, making them suitable for decorative purposes.

Carved in alabaster are many beautiful things, among them a model of the famed Taj Mahal, the costliest and most wonderful mausoleum ever erected to the memory of man or woman. There are inlaid tables, chess boards, card trays, lamp stands, paper weights and plaques all made of semi-precious stones inlaid in marble. The many idols and statuettes must not be forgotten. They are in all sizes and postures and are principally in metal, both painted and unpainted. They are not handsome in face and figure, but will doubtless fill many a niche in elegant residences of this country as curios.

### A Stroll Among Japanese Art Works.

CROSSES and mantel ornaments of cut crystal and a line of crystal and Japanese agate cuff buttons are among the curios of this section of the Manufactures building.

A silver plated wedding or banquet set in the exhibit of T. Otsuka in the Kaga and Yokohama room has a base 4 feet long by 18 inches wide at the center and some 3 inches deep. It rests on ten scroll legs, 2 inches high. In the center a gold lined bowl 6 inches deep and 12 across, with chrysanthemum flower and leaf decoration on the side overlying a gold background, has around the base an inch band of the same flowers in colored enamels. The bowl is supported on eight scroll legs, extending outward several inches beyond the circumference of the bowl. On projecting scrolls on the legs, eight birds, distinctive of Japanese bird life, stand in different postures. As side pieces at either end are two storks 10 inches in height with bright silver plumage on the bodies, black tails, bronzed legs, peacock finished necks, oxidized heads and polished beaks. These stand upon mountains of peacock silver of brilliant colorings. Two artistic flower vases with silver stands and four three-light candelabra of bright, oxidized and peacock silver and enameled bands constitute the set. Peacock tints prevail throughout the set.

An interesting case in Japanese silver work has sparrows in bronze finished silver on shocks of grain with gold kernels; an oxidized stork wading in a stream of running water; a carved chrysanthemum bowl of rare beauty; a wooden barrel six inches long by five in diameter on a silver stand four inches high, and on top of the barrel a silver rooster six inches high with gilt beak and legs—a finely executed piece of work; and some two dozen bright silver souvenir spoons with chrysanthemum flowers as the chief ornamentation on handles, and bowls engraved with birds, butterflies and flowers peculiar to that country.

There are many beautiful things in Japanese art work as it relates to jewelry lines, but though of marked beauty and originality they are so foreign to anything seen in this country, that they are to be regarded more in the light of curios than as articles of commercial value to Americans.

DIAMONDS WATCHES BHA TRADE MARK JEWELRY MANUFACTURING

STOCKS CANNES BHA

**LAPP AND FLERSHEM** Chicago, Ill.  
92, 94, 96 & 98 STATE ST. COR. WASHINGTON.

**THE LARGEST SUPPLY DEPOT**  
*For Everything Needed by Jewelers.*  
ILLUSTRATED CATALOGUES FURNISHED JEWELERS.  
SPECIAL FACILITIES FOR FILLING ORDERS. NO RETAILING!

STERLING & SILVER PLATE BHA OPTICAL GOODS



**Chicago.**

The following are enjoying Chicago's Summer resort climate and the cooling breezes at the Fair:

Kerry Conley, Spring Valley, Minn.; Chas. F. Billau, Cedar Rapids, Ia.; Jas. A. Moore, S. Kind & Co. Philadelphia; Jos. Schauweker, Jr., Cleveland, O.; R. G. Fuller, Chesaning, Mich.; M. H. Douglas, Russiaville, Ind.; W. H. May, Cannington, Can.; Joseph Miller, Harper, Kan.; Joseph Goodman, Memphis, Tenn.; J. A. Martin, Paris, Tex.; G. F. Hahnemann, Buffalo, N. Y.; F. F. Hallett, Minneapolis, Minn.; T. A. Beard, F. L. Shephardson & Co., No. Attleboro, Mass.; Johannes Durstein, Glashutte, Germany; Louis P. Weber, Chapman & Armstrong, Galesburg, Ill.; P. R. Bennett, Jr., Urbana, O.; U. Terrot, Coalgate, I. T.; J. J. Hays, Mantua, O.; T. H. House & Co., Galva, Ill.; J. M. Stoner, Jr., Geo. W. Biggs & Co., Pittsburgh, Pa.; Alex. Susen, El Paso, Tex.; F. H. Pitkin, Andover, O.; Jas. R. Ferguson, Cleveland, O.; Aug. H. Marwede, Alpena, Mich.; Samuel Ledman, Louisville, Ky.; E. M. Wilson, Annerson, Ind.; Maurice D. Comor, Geo. H. Richards, Jr., & Co., Boston; Levy Hermanos, Paris, France; T. A. Beard, Australian Pearl Works, No. Attleboro, Mass.; J. D. Huggins, Youngstown, O.; A. M. Kirk, Curwensville, Pa.; G. B. Lyon, Hammondsport, N. Y.; W. F. Laraway, Glenwood, Ia.; August Bruder, Fort Wayne, Ind.; M. E. Flower & Co., West Bay City, Mich.; Ezra L. Valentine, N. B. Levy & Bro., Scranton, Pa.; Chas. Riley, Champaign, Ill.; Miss Benn, Sterling, Kan.; Jas. W. Kirk, Philadelphia W. C. Co. Riversile, N. J.; Wm. Stolz, Saginaw, Mich.; E. Bruce Capper, W. L. Jones, Martinsburg, W. Va.; G. B. Ellestad, Lanesboro, Minn.; L. Luchtemeyer, Blue Island, Ill.; S. H. Quackenbush, Minturn, Col.; H. Capron, Eaton Rapids, Mich.; J. M. Strass, Milwaukee, Wis.; Theo. B. Myers, St. Paul, Minn.; A. F. Hostetter, Lancaster, Pa.; Fred Voedisch, Aberdeen, S. D.; Walter C. Rix, O. B. Rudd, Illion, N. Y.; James Bert, Hardy & Hayes, Pittsburgh, Pa.; G. Judd Williams, Urbana, O.; O. W. Nisewonger, Oran, O.; A. E. Paegel, A. Sanborn & Co., Minneapolis, Minn.; Harrington & Freeman, Boston, Mass.; D. M. Small, J. B. Trickey & Co., Lincoln, Neb.; Chas. S. Sharp, Ripon, Wis.; T. C. Yates, Hopkinsville, Ky.; R. E. Graber, Brenham, Tex.; R. E. King, Hawkinsville, Ga.; Jos. G. Pavian, Minneapolis, Minn.; C. M. Evans, Reading, Pa.; L. C. Garwood, Champaign, Ill.; S. Sutter, Russell, Kan.; Milton Haywort, Haas & Co., Indianapolis, Ind.; G. F. Duncan, Eau Claire, Wis.; I. C. Crane, Indianapolis, Ind.; L. Levy, Syracuse, N. Y.; K. Levy N. B. Levy & Bro., Scranton, Pa.; H. M. Avery, So. Haven, Mich.; Geo. B. Pratt, Grand Ledge, Mich.; W. J. Rack, Milwaukee, Wis.; J. H. Woodstock, Clear Lake, Ind.; Henry W. Schumacher, New York; S. Samuels, Martin, Tex.; D. R. Porter, Marion, Kan.; R. S. Phillips, Waco, Tex.; Frank A. Conant, Santa Barbara, Cal.; H. O. Krone, Loewenstein Bros., St. Louis; Edw. M. Heilig, Philadelphia, Pa.; M. Levy, Minneapolis, Minn.; John C. Moorehouse, North Adams, Mass.; Geo. Myers, Ft. Scott, Kan.; Henry Upsall, Watseka, Ill.; Gustav A. Fehrs, Manitowoc, Wis.; C. W. Gearhart, Arigon, Ill.; Ed. Sickles, Philadelphia; R. Frank Barr, Martinsburg, W. Va.; G. B. Lyon, Hammondsport, N. Y.; D. Bixler, Berne, Ind.; Geo. E. Morrell, Boston, Mass.; M. L. Flower, Bay City, Mich.; Wm. Mithoefer, Cincinnati, O.; H. Rosem, Buffalo, N. Y.; Mr. Pope, New Mexico; M. M. Gumbiner, Luling, Tex.; Mrs. A. Martin, Jacksonville, Fla.

Martinsburg, W. Va.; Kerry Conley, Spring Valley, Minn.; Robert Ernst, Vicksburg, Miss.; W. H. May, Cannington, Can.; G. L. Gunther, Bellevue, O.; W. S. Townsend, Akron, O.; F. W. Stewart, Oberlin, O.; Mr. and Mrs. G. B. Ellestad, Lanesboro, Minn.; John Fee, Grand Rapids, Mich.; W. A. Methvin, Temple, Tex.; Hugo B. Schmidt, Nashville, Tenn.; Joseph Miller and wife, Harper, Tex.; Nettie Sawert, Allegheny City, Pa.; Amelia Sawert, Allegheny City, Pa.; F. Cawker, Tellwide, Cal.; H. A. Maier, Atlanta, Ga.; C. B. Howard, Jr., Atlanta, Ga.; F. J. Paxon, Atlanta, Ga.; R. N. Clark, Sterling, Ill.; Chas. E. Buder, Columbus, Minn.; Mary Q. Davis, Philadelphia; Lillie H. Davis, Philadelphia; Hannah R. Davidson, Philadelphia; Joanna McNamee, Philadelphia; Emma Queen, Philadelphia; H. E. Cobb, Attleboro, Mass.; F. L. Murray, Guthrie, O. T.;

Lon Williams, Wichita, Kan.; V. A. Washburn, Wichita, Kan.; C. A. Garpil, New York; Frank Thomas, West Troy, N. Y.; Chas. A. Dye, Denver, Col.; Geo. C. Mosher, Chattanooga, Tenn.; Mrs. S. Estabrook, Vermont; Miss Haskins, Vermont; J. P. O'Brien, Keokuk, Ia.; A. C. Ebert, McCook, Neb.; H. Rypinski, New York; J. E. Mitchell, Ft. Worth, Tex.; W. G. Murray, Pensacola, Fla.; S. O. Ebersole, Independence, Kan.; J. H. Stouthamer, Milwaukee, Wis.; G. F. Hahnemann, Buffalo, N. Y.; John Conline, Detroit, Mich.; E. F. Strickland, Benton Harbor, Mich.; Louis C. Seng, Louisville, Ky.; M. B. Parks, Peru, Ind.; Alfred M. Ford, London; Adolph Krebs, McKeesport, Pa.; John R. Hess, Fond du Lac, Wis.; J. H. Thomsen, Fond du Lac, Wis.; John Tenner and wife, St. Louis, Mo.; H. Thomas, with D. Jones, Independence, Ia.; P. J. Thomas, Fredonia, Kan.; H.

**RECEIVER'S SALE.**



ENTIRE Stock of Giles, Bro. & Co. Fourth Floor Masonic Temple, consisting of Diamonds, American and Swiss Watches, Jewelry, Silver and Plated Ware, Tools, Materials, etc. will be sold in lots to suit the purchasers, at large reduction from original cost price.

An unusual chance for live Jewelers to obtain bargains.

W. H. GLEASON, Receiver.

July 14th, 1893.



**HARDINGE ROLLER REMOVERS,**  
THE BEST ON EARTH.

MANUFACTURED BY

**HOROLOGICAL TOOL CO.**

OFFICE: 86 N. CLARK STREET,

Factory: 1036 Lincoln Ave., CHICAGO.

For Sale by all Jobbers.

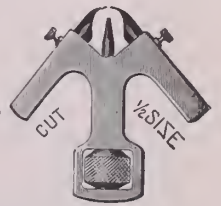

**HENRY J. ROHRBACH,**

94-96 State Street,

(Room 524.) CHICAGO.

SILVERSMITH AND MANUFACTURING JEWELER.

**COLD, SILVER AND NICKEL PLATER.**  
Silver and Silver-Plated Ware of all kinds Repaired, Refinished and Polished at Low Prices.  
SEND FOR PRICE LIST.

ALL KINDS OF BRONZES REPAIRED AND REBRONZED.

Full facilities for manufacturing and repairing all classes of Jewelry for the Trade.

Remember—Room 524.

ESTABLISHED 1879.

G. W. HOOK,

MANUFACTURING JEWELER,

149 and 151 State Street,

Chicago, Ill.

INSPECTION BY THE VISITING TRADE INVITED.

Visitors to the Chicago Jewelers' Association rooms last week were:

Warren Cole, South Chicago, Ill.; Mrs. J. W. Hamlin, Washington, D. C.; Olive A. Hawkins, Washington, D. C.; Chas. B. Wolf, Kansas City, Mo.; C. A. Leach, McCook, Neb.; John E. Joss, New Philadelphia, O.; Wm. Stolz, Saginaw, Mich.; G. H. Cahoone, Providence; August H. Marwede, Alpena, Mich.; W. F. Laraway, Glenwood, Ia.; Alfred E. Patterson, Wright, Kay & Co., Detroit, Mich.; Fred Kiemle, Cincinnati, O.; T. A. Beard, North Attleboro, Mass.; Carl McClure, Watersmeet, Mich.; A. W. Lowell, Battle Creek, Mich.; D. W. Lowell, Battle Creek, Mich.; E. B. Cappen, Martinsburg, W. Va.; W. E. Hoffhims,

C. Woodward, Philadelphia, Pa.; F. W. Kibbie, Drayton, N. D.; H. Capon, Eaton Rapids, Mich.; B. W. Moore, Stewartville, Minn.; G. W. Beekler, Waldo, Wis.; W. N. Hunnicutt, So. Haven, Kan.; F. D. Vittum, Galesburg, Ill.; J. H. Root, Tempe, A. T.; Wm. Hunt, Uniontown, Pa.

Benj. Allen and family are at Mackinac Island, for a few weeks' Summer outing.

H. A. Spaulding returned Aug. 8th from a three weeks' visit at Kennebunkport, Me.

A. Bippart leaves for the east the present week after two weeks of pleasure at the Fair.

Manager Todd, of the Towle Mfg. Co., left Saturday on a short business trip to the factory and New York.

Dan Stevens, Chicago manager for the Bay State Watch Case Co., is back after four weeks of pleasure in the east.

H. C. Woodward, "the growler," for H. Muhr's Sons, Philadelphia, is taking in the Fair and finds nothing but pleasure in it.

Ralph Hamilton, of Hamilton & Hamilton, Jr., and Jerry Phillips, traveler, are receiving and making new acquaintances in Chicago.

Manager Prentiss, of the Gorham Mfg. Co., returned Sunday week from the east, where he was called to attend his father's funeral.

Isidor Stern, of Stern Bros. & Co., New York, left for home Wednesday after ten days here on business and pleasure. Sig. Stern remains a few days longer.

Dan Hyman, Sacramento, Cal., left Chicago for Niagara Falls, thence by boat down the St. Lawrence to Montreal, visiting Boston, New York and Washington before his return.

Will Andersen, of Juergens & Andersen Co. returned Monday week from a week's fishing at Green Lake. Pickerel to the number of eighteen or twenty was considered a good day's work.

Mrs. D. Manheimer, mother of Louis Manheimer, died suddenly of heart disease at Mackinac, July 28th. The remains were brought to Chicago and interred in the family lot in Rosehill Cemetery.

On Aug. 9th the Brethauer Watch & Jewelry Co. received their certificate of incorporation to deal in watches, clocks, jewelry and metal goods with a capital stock of \$10,000. The promoters of the enterprise are: Percival Steele, Jesse E. Roberts and M. W. Zoernsch.

E. B. Downs, in charge of the Waterbury Watch Co.'s exhibit at the World's Fair, left Wednesday for Port Jefferson, L. I., where he will wed Aug. 16th, Miss Sarah Gildersleeve, an estimable young lady of that place. Benjamin Westerbrook, the Waterbury traveler, fills the position vacated by Mr. Downs until the latter's return the end of the present week.

The family of H. D. Parkes, buyer for Lapp & Flershem, are at Lake Paw Paw, near St. Jo, Mich. Mr. Parkes joins the family each Sunday and enjoys fishing at the rate of fourteen bass an hour. M. E. Wolfe, in charge of the silver department of the same firm, spent last Friday and Saturday at Kankakee, and says if Parkes only caught fourteen an hour he doesn't know how to fish.

The fine new jewelry department of Marshall Field & Co.'s retail store, was opened to the public last Monday. The addition to the former store covers a quarter block at the northwest corner of Wabash Ave. and Washington St., and the entire first floor with the exception of three small departments—gloves, handkerchiefs and parasols—is devoted to jewelry and kindred lines. A space 25x5 feet in the center of the jewelry section proper is given to manager R. Quinn's office and the diamond room, which adjoin a 16 foot display case. The silver-

ware section has two 16 foot display cases in the center. Some 250 linear feet of counter cases and 48 feet of display cases are devoted to jewelry and silverware, 50 feet to stationery, 30 to optical goods, 20 to clocks. The unusually deep counter cases are of plate glass set in mahogany frames and rest on solid paneled mahogany tables with brass feet. The display cases are 4 feet wide, 5 high and 16 long with drawers beneath, and are divided into three parts laterally by plate glass shelves.

B. F. Norris, of B. F. Norris, Alister & Co., has returned to Chicago from a trip around the world and relates many interesting incidents. Mr. Norris left last October by way of Vancouver and Japan and traveled extensively through Oriental and European countries. "I wasn't sick a day nor did I lose a meal," said he. "I started alone but afterward joined one of Cook's parties and was treated royally wherever I went. Most of the trip was by rail and steamer, but I rode elephants in India, camels in Egypt, donkeys in Jerusalem, jinrickshas in Japan and sedan chairs in China, but found no balloons or Ferris Wheels. Blackinton overtook me in Paris. On the inland sea between China and Japan our steamer, the English ship *Ravenna*, ran down a new Japanese war vessel and eighty of their crew were drowned. We picked up sixteen. We were transferred to another steamer as the bow of our boat was smashed in. This was the only disagreeable incident on the trip." Mr. Norris is looking well. He will remain in Chicago till the holidays, saying his health is so good there is no excuse for running away to his California home.

J. S. Horner, music dealer at Dayton, O., for the past twelve years has been succeeded by the J. S. Horner Music & Jewelry Co., which will carry a stock of jewelry in addition to musical merchandise.

# The Wadsworth Watch Case Co.



General Offices,  
NEWPORT, KY.

Filled



Cases.



Chicago Office,  
COLUMBUS BUILDING.

**Assignment of a Minneapolis Jobbing House.**

MINNEAPOLIS, Minn., Aug. 10.—Max Olenick, wholesale jeweler, made an assignment on the 8th to Simon Meyers. The assignment was precipitated by a suit brought against Mr. Olenick by Arnold & Steere, Providence, for a claim of \$2,000, papers being served on Mr. Olenick in New York city, where he had gone to effect a settlement with his creditors, but where all offers were refused. Mr. Olenick offered to return the goods bought, but Arnold & Steere would not accept them for more than fifty cents on the dollar owing to the present commercial inactivity, many losses sustained recently and poor collections. The following is a complete list of the insolvent's creditors:

J. W. Smith, \$525; G. H. Cahoone & Co., \$12.79; H. F. Barrows & Co., \$42.71; B. S. Freeman & Co., \$76.82; Flint, Blood & Co., \$17.97; T. I. Smith & Co., \$71.83; Palmer, Capron & Co., \$39.23; R. F. Simmons & Co., \$208.45; Ernest Adler, \$71.22; Plainville Stock Co., \$30.23; Waite, Mathewson & Co., \$27.73; Wightman & Hough Co., \$220.23; Arnold & Steere, \$2,000; Harvey & Otis, \$8.47; L. W. Pierce & Co., \$41.36; J. M. Fisher & Co., \$55.40; A. Bushee & Co., \$38.29; J. K. Webster, \$90.00; Potter & Buffinton, \$18.50; M. L. Olenick, \$175; First National Bank of Minneapolis, \$774.47; liabilities total, \$4,545.70.

The assets, including book accounts, stock and store fixtures, aggregate about \$2,000.

**The Creditors of W. C. Leber, Minneapolis.**

MINNEAPOLIS, Minn., Aug. 11.—The schedules filed by W. C. Leber, who recently assigned, show \$15,927.75 of liabilities against \$7,471.01 of assets. The list of creditors is as follows: Holmes & Edwards Silver Co., \$235.10; Rockford Watch Co. \$250.00; Lissauer & Co., \$135.73; New Haven Clock Co., \$60.00; Manhattan Silver Plate Co., \$97.39; L. Black & Co., \$192.19; C. H. Knights & Co., \$301.90; Henry Cowan, \$1,685.48; L. H. Keller & Co., \$39.65; Minneapolis Jewelry Mfg. Co., \$292.08; Odenheimer, Zimmern & Co., \$215.62; Keller, Ettinger & Fink, \$44.06; Wm. L. Gilbert Clock Co., \$145.95; Winsted Optical Co., \$42.50; H. Z. & H. Oppenheimer, \$207.00; Illinois Watch Co., \$39.55; Edward Todd & Co., \$30.00; Weis & Oppenheimer, \$296.54; J. R. Wood & Sons, \$99.50; M. A. Mead & Co., \$113.75; Reed & de Mars Jewelry Mfg. Co., \$68.05; Gunzburger Bros., \$830.71; Max Kollner, \$15.00; Hampden Watch Co., \$50.00; Dennison Mfg. Co., \$80.13; Kenosha Watch Case Co., \$30.00; Rentz Bros., Minneapolis, \$15.00; Heintz Bros., Buffalo, \$125.85; and the following Minneapolis persons and firms: Jas. Iverson, \$25.00; State Bank, \$2,350.00; Free Press Pub'g Co., \$20.00; C. Rassmussen Pub'g Co., \$15.00; Daniel Engstrom, \$300.00; Otto Witte, \$150.00; J. Blum, \$225.00; Albert Massolt, \$300.00; Frank Wacks, \$300.00; J. C. Witte,

\$200.00; E. Rosenberg, \$600.00; C. L. Ball, 350.00; August Purburg, \$250.00; O. A. Kvam, \$575.00; Miller & Co., \$35.00; Joe Gamble, \$45.00; Louise Dimsing, \$35.00; Galvanized Iron Works, 40.00; Pillsbury, Washburn & Co., \$30.00; A. L. Leber, \$325.00; Minneapolis Paper Co., \$200.00; B. Leber, 338.85; J. Leber, \$2,500.00; Barney Smith, \$450.00.

**Minneapolis and St. Paul.**

B. B. Marshall & Son, Minneapolis, have started again their daily auction sales recently discontinued.

Harry U. Rogers, Luverne, Minn., made a voluntary assignment on the 4th inst. The assets and liabilities are about equal and are reported to be about \$1,300.

M. C. Kummerer, Minneapolis, on the 7th made a voluntary assignment to John Day-Smith. The assets are said not to exceed \$2,000. The assignee's bond was fixed at \$4,000.

Last week the board of tax equalization heard application of the assignee of Harry F. Legg, Minneapolis, to have the assessed value of the jewelry stock reduced from \$12,000 to \$6,000.

Out-of-town jewelers visiting the Twin Cities the past week were: H. A. Barreson, Ellsworth, Wis.; A. L. Mealey, Delano, Minn.; Edward Fisher, Bayfield, Wis.; William Webster, Gibbon, Minn.

In the action of the Flour City National Bank vs. F. H. Clarke an answer was filed stating that the \$6,000 collateral deposited by H. F. Legg, by whom the note is said to have been endorsed, had been sold and enough realized to pay the note.

In the assignment of Joseph W. Dupont the schedules of the assets and liabilities have been filed. The liabilities consist mainly of promissory notes and open accounts valued at \$6,647.18, while the assets are made up of goods and jewelry said to be worth \$6,220.84.

Spaulding & Aicher, Minneapolis, jobbers in tools, materials and jewelers' supplies, have dissolved by mutual consent. F. W.

Spaulding, the purchaser of the business will continue it, and will assume all liabilities and collect all accounts due the old firm.

J. W. Loewenberg who was arrested several weeks ago in St. Paul on the charge of embezzling \$6,500 from F. M. Sproehle & Co., Chicago, whom he represented in the Twin Cities, waived examination on the 8th and was bound over to the Grand Jury. As he failed to furnish \$10,500 bail required, he was remanded to the county jail until the November term of court.

**Indianapolis.**

S. T. Nichols, of Nichols, Pee & Co., is visiting his old home at Palestine, Md.

Chas. A. Herner, of J. C. Walk & Son, has returned from a visit to the World's Fair.

**THE PLANCHAMP & BECKER CO.**

Makers and Repairers of  
**WATCH CASES,**  
Gold and Silver Plating —

— of Watch Cases a Specialty.  
UNEXCELLED FACILITIES.

63 and 65 East Washington St., Chicago.

**PARSONS : SCHOOL**

— FOR —  
**WATCHMAKERS,**  
PEORIA, - - - ILL.

Send for Circular and Terms.  
**PARSONS & CO.**

**IRONS & RUSSELL,**

(SUCCESSORS TO CHARLES F. IRONS.)  
MANUFACTURERS OF

**SOLID GOLD EMBLEMS ROLL PLATE**  
PINS, CHARMS AND SOLID GOLD RINGS.

102 Friendship Street, - - Providence, R. I.



**GIBSON HOUSE,**

CINCINNATI, OHIO.  
ABSOLUTELY FIRST-CLASS AMERICAN PLAN HOTEL. \$3.00 PER DAY.

Extra Charge for Parlors and Rooms with Bath attached. The unequalled advantages in central location, liberal management, modern appointments, experienced service and perfect cuisine, have permanently established the Gibson House as **The Most Popular First-Class Hotel in Cincinnati.**

AMPLE VAULTS FOR THE PROTECTION OF VALUABLES.

**THE GIBSON HOUSE CO.,**

H. B. DUNBAR.

President and Manager.

# FLY BACK AND SPLIT SECONDS,

**ACCURATE  
AND  
RELIABLE.**



**PRICES  
MODERATE.**

**IN SILVER, FILLED AND GOLD CASES.**

**A. WITTNAUER, Manufacturer and Importer,  
19 MAIDEN LANE, NEW YORK.**

## **BLANCARD & CO.,**

LATEST ROCOCO DESIGN IN GALLERY.

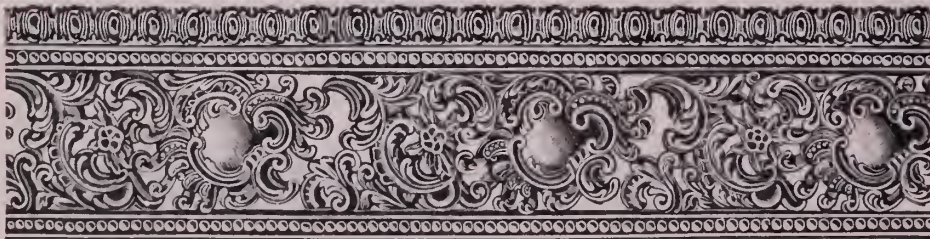

**DIAMOND SETTINGS. GALLERIES. HOLLOW BALLS, ETC.**

**SEND FOR OUR CATALOGUE.**

**45 & 47 John St., New York.**

**Enterprising Jewelers Catch On!**



OBVERSE



REVERSE



BACK

**Jewish Shekel, Masonic Mark or Pocket Piece.  
THE LATEST AND BEST SELLING NOVELTY.**

The mark is struck in coin silver; by using either the obverse or reverse of the coin, the back being the same in either case, and permitting of the purchaser's name, blue lodge, chapter and individual mark, with date of same being engraved thereon, as shown in cut above.

Price, without engraving, ONE DOLLAR. Engraved Mark, Dates, etc., 75c. EXTRA.

Liberal Discount to the Trade.

**CHAS. G. WILLSON, MANUFACTURING JEWELER, READING PA.**

J. C. Sipe left here last Thursday for Buffalo to visit his brother.

Julius C. Walk & Son are repainting and decorating the exterior of their store.

Wm. Linder, after an illness of several weeks, is again able to attend to business.

Edward W. Koehler, L. M. McKinstry, and H. Menough are visitors at the World's Fair.

Wm. T. Gardner, the oldest manufacturing jeweler in Indianapolis, is moving from his old quarters in the Hubbard Block to 28 and 29 E. Market St., where he will conduct a first-class retail store in addition to his manufacturing business.

Craft & Koehler have finished a Grand Army badge that is pronounced the most artistic thing of the kind yet made. The upper part is the eagle with a fine ruby for an eye. Under the eagle are crossed sabers, indicating the cavalry branch of the service, and the yellow shield indicating the 23d Army Corps. The rank strap has two diamonds in it. The pendant is the star of the G. A. R. badge with a brilliant diamond in each of the five points.

### **Detroit.**

C. M. Flagg, of the Keystone Watch Case Co., and W. T. Gough, representing Carter, Sloan & Co., visited the trade here last week.

Charles Burky, formerly traveling salesman for Eugene Deimel, and now with Benj. Allen & Co., Chicago, spent last week in this city.

The business of J. H. Murdock, Dexter, Mich., who was recently crushed to death while moving his safe, will be sold by his daughter Maime.

John H. White, Bad Axe, Mich., was closed up last week on a chattel mortgage held by a local creditor. A number of eastern firms are creditors.

The store of H. A. Harrison, Sault de Ste. Marie, Mich., was burned out last week. The loss is not known. The principal damage was done by smoke and water.

Charles A. Piella, who recently had \$1,600 worth of diamonds stolen from his store at Lansing, Mich., was in this city recently. He has so far failed to recover the stones.

R. M. Schon, formerly of Kern & Schon, manufacturing jewelers, has invented a World's Fair coin brooch. It is composed of silver, and will hold the two different sizes of Columbian coins issued by the Government.

J. L. Hudson recently foreclosed a chattel mortgage on the stock of cutlery, silverware and hardware in the store of R. B. Owen & Sons. The stock has been moved into Hudson's new store, and is being sold by forced sale.

The following Michigan country buyers were in this city last week: J. C. Bacon, St. Clair; J. S. McGlaughlin, Wyandotte; E. V. Allison, Pontiac; Sam. Friedman, Osco; August Marwede, Alpena, and Wm. H. Amber, Northville.

**Some Favorable Reports on Business From the World's Fair City.**

CHICAGO, Ill., Aug. 14.—The consensus of opinion among leading retail jewelers of Chicago, as noted in a canvass, points to numerous sales of small wares to people who are temporarily in the city from outside cities and towns, the sales in the aggregate rather exceeding those of the same months the past year. Novelties and souvenir lines are mostly sought. It is noticeable that few large pieces are being sold. All the large retail stores are well filled with buyers. Asked as to the condition of business, the class of goods sold and to whom, the following replies were elicited:

"We did a great deal better in June and July than a year ago, thanks to the World's Fair. Sales are running largely to small goods, but they exceed last year in the aggregate over 50 per cent., and in some departments, notably silver, sales have doubled."—Mr. Forman, Spaulding & Co.

"So far as we are concerned, the retail trade is very fair, and up to a week ago was good. Everything considered, the trade is good. It is mostly to transient trade and small stuff, but we are selling lots of it. The result is quite satisfactory."—Harry Stevens, C. D. Peacock.

"Business is good; regular trade none, transient very good. We have no complaint to make under the circumstances."—Harry Hyman, Hyman, Berg & Co.

"Trade is good in small articles, which are sold to strangers mostly. Our business is 33 per cent. over that of last year."—Mr. Kasper, Shourds & Kasper.

"We are doing a reasonably good business to a trade largely transient. Silver novelties and smaller articles of jewelry are the best sellers. Considering the conditions generally prevailing, we are doing well."—James L. Rowe, Rowe Bros.

"The class of goods sold is rather knick-knacky and to out-of-town trade almost entirely. Despite this we have doubled our sales over June and July of an ordinary year."—J. B. Mayo, Mayo & Co.

"Trade is up to the standard and divided about equally between transient and regular. Lines selling best are of moderate price."—C. E. Graves, J. B. Chambers & Co.

Increased sales mean depleted stocks later, and it seems there should be a Fall demand in this city for fine goods. Excellent judges of this, however, are on the ground in the persons of L. H. Smith, representing Bippart & Co.; Harry Bliss, Kremetz & Co.; W. T. Gough, Carter, Sloan & Co. and William Elcox, of Larter, Elcox & Co. Appropriate in this connection are the following comments of jobbers and manufacturers:

"Our local business exceeds that of last year."—M. A. Mead, M. A. Mead & Co.

"Trade is very good and business is booming. We are working full force, and there is lots of work."—Paul Juergens, Juergens & Andersen Co.

"Business has been very good, and last month was the largest July we ever had. One reason was our large contract for the diamond and badge work for prizes at the League of American Wheelmen meet."—R. M. Johnson.

"Our prescription trade is immense. We have not had a traveler out since June 1st, and yet our June and July sales were larger than those of the previous year when all the travelers were out."—Mr. Henshaw, Geneva Optical Co.

**Rockford.**

Joseph Peers has erected a handsome residence on N. Court St.

Nate Robinson, one of the oldest employes of the Rockford Watch Co., a member of the G. A. R. and who had worked in all the large watch factories, died here last Wednesday, aged sixty years.

A new 1,000 horse power Corliss engine has been purchased by the Rockford Watch Co. The work of placing it in position has compelled the company to shut down longer than was expected.

The Rockford Silver Plate Co. during the vacation, shipped their steel rollers to be re-ground and as they have not been finished, the directors, in view of this and the present outlook for trade, decided to defer fixing a date for resuming work until their next regular meeting.

**Hair Pin and Eye Glass Chain COMBINED.**



This illustrates the Hair Pin and Eye Glass Chain Combined. It is one of the most dressy as well as the most comfortable ways of securing the Eye Glass ever put on the market, and it is justly becoming very popular.

**S. F. MERRITT, Manufacturer,**

N. Y. Office, 194 Broadway.

SPRINGFIELD, MASS.

**MATHEY BROS., MATHEZ & CO.**

21 & 23 MAIDEN LANE, N. Y., and BRASSUS, SWITZERLAND.

MANUFACTURERS AND IMPORTERS OF

Plain and Non-Magnetic Movements.

Complicated Watches a Specialty.

**A FULL LINE OF 10 and 16 SIZE**

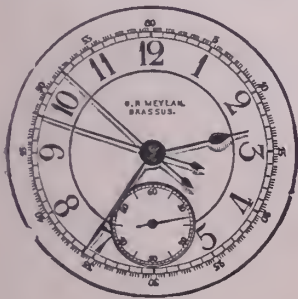

SIZE 10.

**SPLITS**



10 SIZE.

### Cincinnati.

J. Dorst is in Chicago taking in the Fair. Frank Herschede has given a real estate mortgage for \$4,000.

Lee Kaufman says his grip is packed, but times must improve before he goes on the road.

Jos. Noterman and family have returned from a visit to the World's Fair and a tour of the northern lakes and St. Joe River, Mich.

Homan & Co. display the prettiest counting room sign to be seen anywhere. It is a sample of their own production, made of silver plate, 7x10 inches, beautifully etched, with rococco border, and reads, "City Bills paid second Friday of every month."

F. H. & J. F. Terlau, 822 Madison Ave., Covington, last week filed a deed of assignment to H. J. Gausepohl for the benefit of their creditors. No authentic report of the assets or liabilities has been made, but the former consists of nothing but the stock in trade and will not reach \$2,000, while the liabilities are estimated at \$4,000. The stock became depleted, and being unable to replenish it the proprietors decided to assign. C. Oskamp is the principal creditor. The firm claim if given time they will be able to pay their debts in full.

### Kansas City.

Melville Sheely, a negro, has been arrested for breaking into H. M. Bacon's store in

Kansas City, Kan., and stealing many small articles of jewelry.

George McClune, brother of the late Bart McClune, has opened a jewelry store on E. 9th St. near Walnut St.

M. Wood's store, on S. Grand Ave., was last week entered by burglars who tried to break the safe, and failing, contented themselves with stealing a valuable French clock.

J. Fulkerson, of Kansas City, Kan., left a gold watch worth \$100 at the jewelry store of F. Winkler, 504 Minnesota Ave., in that city. Mr. Winkler went to lunch at noon and left a clerk in charge of the store. Presently two men entered and asked for a watch they had left for repairs. The clerk said he knew nothing about the watch, but one man said, "That's it, I believe," pointing to the watch Fulkerson had left. The clerk considered the identification sufficient, collected a dollar charges and gave away Fulkerson's watch.

### Pacific Coast Notes.

Will H. Shainwald, of the Shainwald Jewelry Co., San Francisco, will soon leave for a trip to Europe.

Edward T. Dawson has been arrested for embezzling watches from the Golden Gate Watch Club, San Francisco.

Thomas Kilgo, jeweler, San Francisco, was recently accidentally injured, in Colfax, by the explosion of a brass shell which he was loading.

H. I. Connor, jeweler, Oakland, Cal., will remove his store to San Francisco, if he can secure a suitable location for it.

Julius Cuthler, a San Francisco jeweler, was run over by an express wagon last Wednesday and seriously if not fatally injured.

"Mary and John" is the title of a new comedy drama by Is. Woolf, a San Francisco jeweler, who has won some local fame as an amateur actor.

Notwithstanding the dull times the jewelry business in San Francisco remains firm. So far but few failures have been reported, and those were of small businesses and watch clubs.

### Lancaster, Pa.

Walter C. Herr, of N. Queen and Orange Sts., has sold his store to S. Kurtz Zook, a practical watchmaker, who will take possession about September 1st. Mr. Herr's health compels him to engage in outdoor business.

H. Z. Rhoads has been sadly afflicted in the death of his only daughter, Mrs. Rebekah Rhoads Lowell, which occurred on last Wednesday, from childbirth. Miss Rhoads was married to Dr. Lowell last October, the wedding being one of the society events of the year.

George Eastman has been arrested, charged with robbing Simpson & Lowrey's store, Victor, Ia., on July 28th.

# WALTHAM REPEATERS

## Striking Hours and Minutes.

TO THE TRADE:—

Having purchased the entire remaining stock of WALTHAM REPEATING MOVEMENTS from the American Waltham Watch Co., and cased them in 20 year 14k. Cases, I am prepared to sell them at prices 30 per cent. less than they have ever been offered before.

ARTISTIC SPECIAL CATALOGUE FREE.

SEND FOR PRICES AND TERMS.

# JOHN B. YATES,

21-23 Maiden Lane, New York.

**Connecticut.**

W. A. Lambert, Birmingham, has sold out to A. H. & C. B. Alling.

R. D. Hill, the New London optician, is on a visit to Cleveland, O.

The Wm. L. Gilbert Clock Co.'s factory, Winsted, has started up on short time.

The three shops of the Bristol Brass & Clock Co. are all running on full time.

J. D. Bergen, head of the J. D. Bergen Co., Meriden, and wife are at Nobscesset, Cape Cod.

The E. Ingraham Co. are shipping, according to good estimates, from 500 to 1,000 clocks a day.

Gurdon W. Hull and family, of Wallingford, are guests at the Branford Point house, Branford, Ct.

Phil. Silverthau, of S. Silverthau & Sons, New Haven, is home from a visit to the World's Fair.

Tiffany & Co., Willimantic, are closing out their jewelry business and will remove to Manchester, where they have another store.

A. I. Chatfield has bought out the interest of G. S. Chatfield in the business of the Chatfield Jewelry Co., 44 Bank St., Waterbury.

Chris. Strobel, of Lake, Strobel & Co., Waterbury jewelers, and William Hellmann, started for Chicago Wednesday night.

The New Haven Clock Co.'s manufactory which has been running four days per week has been shut down for three weeks. President Galpin of the company looks for decidedly better times for business in the Fall.

C. D. Warner, of Ansonia, has returned from a two weeks' trip west, during which he visited the World's Fair and imbibed enough new ideas in electricity and electric clocks to keep him thinking for a good many months.

In Waterbury Rogers & Bro's. factory is busy again after a three weeks' shut down for repairs. The Waterbury Clock Co. started up again Aug. 7th. The Rogers & Hamilton Co. will not shut down unless the Holmes, Booth & Haydens Co. do, they renting their power from the Holmes, Booth & Haydens Co.

Saybrook is elated, the project of establishing a silver plate factory there being about to be consummated. Capital enough for the object has been secured and the company will soon be organized. About \$30,000 has been raised in Meriden and Saybrook. The proposed factory will be near Chalker's Mill at Oyster River. Work on the factory will soon be begun.

Mrs. Waite T. Fellows died in New Haven at the home of her only surviving son, F. Wayland Fellows, the wealthy retired artist and member of the Century Club, New York, at midnight, August 7th, at the great age of 101 years. Mrs. Fellows was the wife of James Fellows, who many years ago was a partner in the jewelry firm of Fellows & Read, New York, with Ezra C. Read. In 1838 the firm dissolved, Richard S. Fellows being taken into partnership with his father. A sister of Mrs. Fellows is Mrs. E. C. Read, of New

Haven, still living at the age of eighty-eight. The deceased lady was born in Newport, R. I., April 5, 1792.

The Optical Novelty Co. have organized in New Haven with a capital of \$2,000 in shares of \$50 each. The subscribers are: S. H. Street, C. B. Bryant, L. C. Thompson and Charles J. Henze, of New Haven, two shares each; John H. Marvin, of New Haven, and Fred B. Street and Clifford H. Street, of East Haven, four shares each; William Reeves, of New Haven, twenty shares. The amount of capital paid in cash is \$1,000.

The employes of the Trenton Watch Co., Trenton, N. J., who were to have returned to work last week after the usual Summer vacation, received notice that the works would remain idle for two weeks longer.

**LATEST AND BEST  
ELK'S TOOTH BADGE.**



CAN BE USED AS A  
CHARM BY  
SIMPLY DETACHING  
BAR FROM TOOTH.

Reverse shows the symbolic flower of the Benevolent and Protective Order of Elks, the forget-me-not, beautifully enamelled in colors; also the letters B. P. O. E.

MANUFACTURED BY

**G. A. SCHLECHTER,  
READING, PA.**

**PIVOT DRILLS THAT WILL DRILL.**

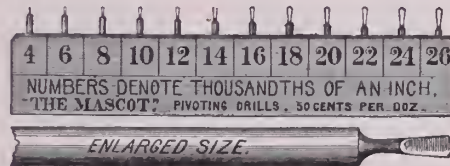

The Mascot is the best made Pivot Drill in the world. This is a strong assertion, but it is justified by the quality of the drills.

The following unsolicited testimonial would also seem to warrant our assertion:

MESSRS. EZRA F. BOWMAN & CO., LANCASTER, PA.:

*Gentlemen*—I am in receipt of your Mascot Pivot Drills that I ordered on the strength of your statement in the May issue of the "Keystone." Having tried every so-called Pivot Drill that my attention was directed to, and meeting with dismal failure, I was naturally inquisitive to learn what your Mascot was capable of doing. I took a Seth Thomas Clock mainspring, and subjected six drills out of each dozen to the test of drilling twenty holes through without drawing the temper. Every drill stood the test and your claim in the "Keystone" is warranted by the facts. Yours truly,  
L. F. GIERING

Send by mail, postage paid, on receipt of 50 cents.

**EZRA F. BOWMAN & CO., Lancaster, Pa.**

**REED & BARTON,  
Silversmiths,**

MANUFACTURERS OF

**STERLING and SILVER PLATED  
SILVER and WARE.**

Salesrooms:

**37 Union Square, New York.**

34-36 WASHINGTON ST.,

**Venetian Building, Chicago.**

FACTORIES, TAUNTON, MASS.

**WATERMAN & LEHMANN,**

MANUFACTURERS OF

**DIAMOND JEWELRY**

AND DEALERS IN

**DIAMONDS,**

No. 37 MAIDEN LANE,

NEW YORK.

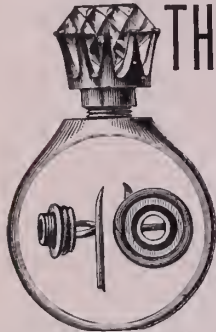

**THE BONNER COMBINATION**

**RING, SCARF PIN AND STUD.**

The Best Combination ever made.

MANUFACTURED BY

**BONNER, RICH & Co.,**

Makers of **DIAMOND MOUNTINGS**  
**RINGS A SPECIALTY.**

To the Jobbing Trade Only.

41 MAIDEN LANE, NEW YORK.  
Factory, 44, 46 and 48 Hill St., Newark, N. J.

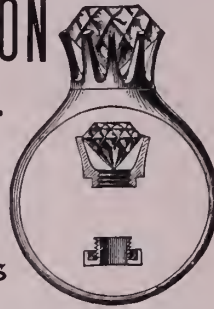

**MUELLER'S ARTIFICIAL EYES.**

\$75 per hundred ; smaller lots, \$15 per dozen ; \$2 each. A large assortment of eyes will be sent to any dealer to enable him to make selection, upon receipt of satisfactory references. We carry the largest stock in America.

ONLY MANUFACTURERS OF THE "DIAMANTA" SPECTACLES AND EYE-GLASSES.

Oculists' prescriptions promptly and accurately filled. Catalogue, price lists, test cards, etc., on application.

**M. ZINEMAN & BRO.,** American Agents, 130 South Ninth St., Philadelphia.

**VICTOR.**

SIMPLEST FEED. ALWAYS THE SAME.  
GUARANTEED FOR ONE YEAR.

**THE VICTOR FOUNTAIN PEN**

(Pat. Feb. 4, 1890.)

**THE BOSTON PEN CO.,**

N. C. Whitaker & Co., Proprietors.

363 Washington Street, - Boston, Mass.,

Manufacturers of finest quality

TORTOISE : SHELL : AND : HORN : GOODS

in every variety Also Aluminum Hair Pins.

Send for illustrated Pen Price List No. 1.

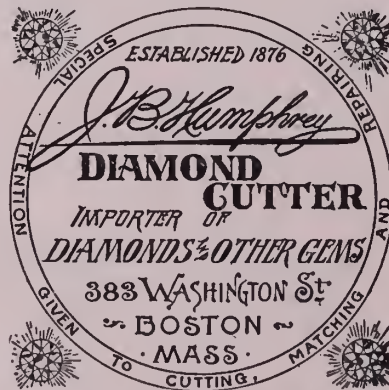

Sold by all wholesale dealers at manufacturer's price.

**A. N. CLARK,**  
PLAINVILLE,  
CONN.

Manufacturer of the Celebrated

**LOOP WATCH KEY.**

The Best for the Price in the World.

CROSBY'S JEWELING TOOLS IMPROVED.



Size of Square

Stamped on each key.



Will quote royalty or price for the manufacturing of articles of real worth.



Patent applied for

Victoria Novelties, many fancy shapes.  
Celluloid Top, Sides, Bottom and Cushions  
**A. TROESCHER & CO.,** 69 Nassau St., N. Y.

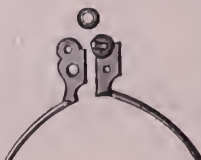

Racine Jewelry Mfg. Co.,  
**SPECTACLE TEMPLE WASHERS,**  
Gross in a Bottle, 25c.  
For Sale by Dealers in Jobbing Materials

**AIKIN, LAMBERT & CO.**

19 Maiden Lane, NEW YORK.

Branch, 42 & 44 East Madison St, CHICAGO, ILL.

Manufacturers and Exporters of

Gold Pens, Holders, Picks, Pencils,

Fountain Pens, etc.

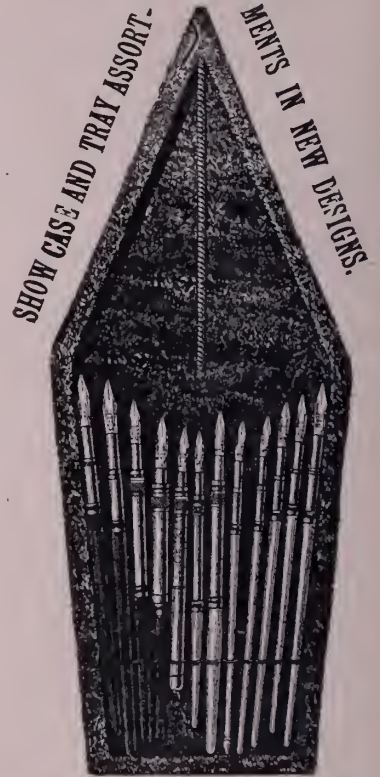

SHOW CASE AND TRAY ASSORT.

MENTS IN NEW DESIGNS.

11 x 5 1/2 inches.

**PUSH TRAY WITH EASEL BACK.**

1 Doz. 16 K. Pens and Assorted Holders, List, \$30

1 Doz. 10 K. Pens and Assorted Holders, List, \$24

Send for Trade Discount.

**OPTICIANS' SUPPLIES**

Jobbing and Prescription Work.

The "Graduate" Trial Cases, 180 1/2 set, \$30.00; 220 lens set, \$37.50. The "Standard" Trial Cases, 220 lens set, \$65.00. All with lenses. Loring Ophthalmoscope, \$9.00. Artificial Eyes, for selection, \$1.00 each, \$50.00 per hundred. Ophthalmometer, \$30.00 to \$70.00. Queen's Standard Perimeter, \$18.50. Queen's Lens Grinding Quilt, \$2.00. Steel Frames, 15 to 30 cents each. Spherical Lenses, 25 cents per pair. Cylinders, 30 cents per pair. Lenticular Bifocals, 80 cents per pair. (all best made) Nose pieces, Gold, \$1.00 per dozen pairs. Silver, \$1.00 per dozen pairs. Gold, \$1.00 per dozen pairs.

**QUEEN & CO.** Wholesale and Retail Opticians and

Catalogue free. 1010 Chestnut St., Phila., Pa.

**THE SIMPLE SAMPLE BOX.**

FOR MAILING JEWELRY & C.

**AMERICAN RAILWAY SUPPLY CO.**  
24 Park Place, NEW YORK.

**J. H. DEDERICK, JR.,**

— DEALER IN —

**Roll Plate Jewelry and Chains,**

Optical Goods and Jewelers' Supplies, &

**16 MAIDEN LANE, NEW YORK.**

JET GOODS A SPECIALTY.



**Pittsburgh.**

Charles Roberts and wife have gone to Atlantic City.

M. Bonn has returned from New York and the Adirondacks.

H. Cerf and S. Cerf, for M. Bonn & Co., are in off the road.

W. Wilson, formerly of Fourth Ave., has removed to 33 Diamond Sq.

G. B. Barrett will be found in New York in a couple of weeks. The firm are busy taking stock.

Joseph D. Roy and family have gone west for a lengthy trip. Renovations and additions to the store are contemplations for the near future.

The explosion of a carboy of ammonia in the work rooms of Heeren Bros. & Co., caused a commotion there Friday last, the fumes completely filling the entire establishment. The damage done, however, was trifling.

**Philadelphia.**

Jacob Muhr has returned home after a second visit to the World's Fair.

Jules Levy has returned with his family from a month's sojourn at Atlantic City.

George M. D. Lewis, 1232 Girard Ave., has returned from a visit to the World's Fair.

Jacob Schimpf, brother of Harry Schimpf, of H. Muhr's Sons, died at Bedford Springs, Pa., on the 2d inst.

E. J. Young, a diamond merchant from South Africa, spent some time in this city last week on his way to the World's Fair.

Among out-of-town buyers here during the week were: S. O. Waller, Smyrna, Del.; H. Fitzsimmons, West Chester, Pa., and M. M. Bovard, Manayunk.

John Brown was on the 8th inst. sentenced to six months imprisonment by Judge Biddle for the larceny of two watches from the jewelry store of T. S. Mitchell.

The firm of Voinoff & Wilson, consisting of Ed. B. Voinoff and N. C. Wilson, has been dissolved. The business will be continued by Ed. B. Voinoff, at 719 Sansom St.

Traveling salesmen here during the past week included Leverett Lewis, Randall, Baremore & Billings; Thomas Woodland, Larter, Elcox & Co.; J. D. Pettingill, Derby Silver Co.

In the Criminal Court before Judge Biddle on the 9th inst., Annie O'Mally was acquitted of stealing rings and brooches valued at \$950, from the residence of Herman Diesinger, of the silversmithing firm of Hamilton & Diesinger.

During a furious wind and rain storm that passed over here on the evening of Sunday, the 6th inst., the large bulk window of Forsythe & Hoffman was blown in and policemen were put on duty to protect the contents of the place until repairs could be made. The damage amounted to about \$500.

Joseph Bailey, of the firm of Bailey, Banks & Biddle, has returned from an extended tour through Europe which he made in the interest of the firm. He was met in New York by a number of his friends from this city and elsewhere. In his travels Mr. Bailey visited the British Isles, France, Germany, Roumania, Austria, Italy, Switzerland and other nations of Europe.

Thomas Wilkinson, of the firm of Bailey, Banks & Biddle, was seriously injured while bathing at Asbury Park on Thursday last. He was hurled against an iron pole supporting a life line and rendered unconscious. When rescued he had a serious cut two inches long on the forehead, another on the side of the face and a gash under the chin, while the tendons of both hands were injured.

**W. G. Pollack's Assailant at Length Come to Book.**

James, alias "Kid" Burke, the man who last November shot W. G. Pollack, traveling salesman for W. L. Pollack & Co., New York, and robbed him of \$15,000 worth of diamonds, has been located in the jail at Leadville, Col., where he was traced by Pinkerton detectives into whose hands the case had been put by the Jewelers' Protective Union.

On November 4th last, while traveling near Omaha, Mr. Pollack was sitting in the smoking car with six other passengers, when a masked man approached him with drawn revolver and demanded his case of diamonds. Upon Mr. Pollack's refusal to give up the case, the robber shot him a number of times and beat him over the head with the butt of the revolver; then taking the diamond case, the thief pulled the bell rope of the train and jumped off and escaped.

W. L. Pollack & Co. immediately notified the Jewelers' Protective Union. The detective agency, after many months' work, located Burke, a noted diamond thief who had been in Omaha about the time of the robbery.

The witnesses being sent for, they positively identified Burke as the man who as-

saulted and robbed Mr. Pollack while on the train. The latter also identified him. The New York office of the Pinkerton Agency has been notified that the authorities at Leadville had given up Burke, and that he would at once be taken for trial at Logan, Ia., the county seat nearest the place where the crime was committed.

**G. W. Fairchild's Jewelry Store the Scene of a Conflagration.**

BRIDGEPORT, Conn., Aug. 15.—A fire occurred about 11:15 yesterday morning in the window of G. W. Fairchild's jewelry store, which, had it not been for the timely work of Mr. Fairchild and his clerks, might have resulted in a serious conflagration. As it was the fire burned a number of unset diamonds and rendered them practically useless, besides burning the lining and lace curtains in the window and scorching a number of pins.

The fire was caused by a small alcohol lamp, which was knocked over on the tissue paper with which the window was dressed. It is feared that some damage was caused which cannot be immediately estimated because of the numerous watches, etc., with which the window was filled.

Queen & Co., Philadelphia, Pa., are furnishing a new lens protractor for laying out and determining the axis of cylindrical lenses which should be in the hands of everyone doing optical work.

Chas. G. Willson, manufacturing jeweler, Reading, Pa., is to exhibit in his window the beautiful gold badges which are to be presented by the Rainbow Fire Company, of that city, to Chief Engineer O'Connor, Assistants Lynch and Donovan, James Dawson, Florence Fisher, Louis Bauer, W. J. Lee and Patrick Burke, of New Orleans; and Chief Wm. Kelley, of Montgomery, Ala., for courtesies shown the Rainbow members on their recent tour in the south. The badges are of solid gold, with suitable designs and descriptions, and show that excellent workmanship which has given Mr. Willson a reputation for fine work.

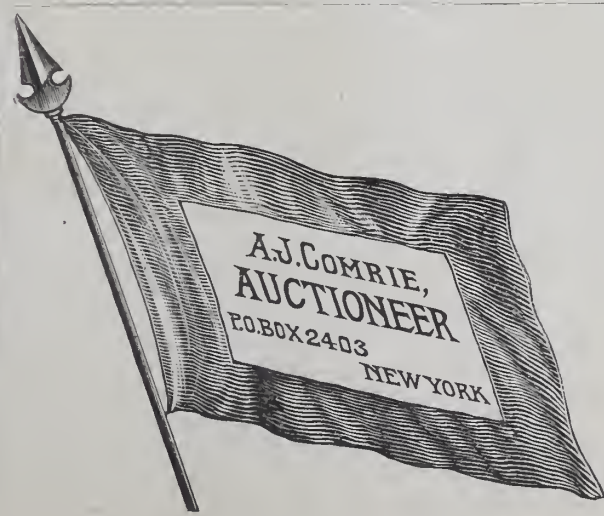

SPECIAL SALESMAN OF

**WATCHES, DIAMONDS,**

**Bric-a-Brac**

and Art Goods

FOR

**Established Jewelers.**

WRITE FOR PARTICULARS.

Communications Strictly Confidential.

References given in all parts of the United States from Retailers and Jobbers.

## News Gleanings.

E. W. Trask, Aurora, Ill., has given a real estate mortgage for \$2,000.

A suit for \$7,500 has been entered against Andrew Jackson and others, Duluth, Minn.

A judgment for \$136 has been entered against L. Crawley, Buffalo, N. Y.

Mr. Warner, of Leon, Ia., will open a jewelry business in Davis City, Ia.

J. C. Horrie, Morris, Ill., on Sept. 1st will open a branch store in Mazon, Ill.

I. A. Foye, Hot Springs, Ark., has just removed to a new store in that town.

Frank Ward, recently of New York, has opened a jewelry store in Pewaukee, Wis.

Chas. H. Hitchcock, Rockford, Ill., has gone out of business.

W. D. Meservey, Fort Dodge, Ia., has given a real estate mortgage for \$1,000.

F. H. & J. F. Terlau, Covington, Ky., have made an assignment.

J. L. Potts, Marceline, Mo., has given a chattel mortgage for \$190.

Robert Smith, Hamilton, Ont., has made an assignment.

I. O. Chapman & Co., dealers in jewelry and musical instruments, Stanton, Mich., have given a chattel mortgage for \$1,673.

A. O. Putnam, Claremont, N. H., has failed and his business has been sold out by the assignee.

A judgment for \$141 has been entered against Carpenter & Christopherson, Buffalo, N. Y.

J. Broghamer, Wilkesbarre, Pa., has removed from S. Main St., to 104 Public Square.

Martin Boek, of Hazleton, Pa., has moved to Wilkesbarre, Pa., and has opened a jewelry store on S. Main St.

The store of Morris M. Molton, Canton, N. Y., was last week entered by burglars, who took jewelry worth \$125.

G. A. Schlechter, Reading, Pa., has opened an optical department in connection with his store.

The death occurred some days ago of Arden Ostrander formerly in the jewelry business in Gloversville, N. Y.

Ike Wartelsky, jeweler, Hastings, Pa., has leased a new building on Beaver St., and will soon move thereto.

In a destructive fire in Snow Hill, Md., last week, the store of J. W. Vincent was burned out; partly insured.

A judgment for \$536 has been entered against A. Jackson and others, Duluth, Minn.

T. J. Cartwright, optical goods dealer, Wheeling, W. Va., has given a deed of trust for \$200.

Jules Petit and C. Nourrie have formed a partnership in Montreal, Can., under the name of Compagnie Parisienne d'Optique.

For a third time L. Youslin, jeweler, Hubbell, Neb., has embarked in the newspaper business. This time he will publish a little sheet called the *Saturday Blade*.

The store of the late P. W. Binger, Lancaster, O., has been purchased by John and Charles Binger who will continue it under the old name.

Thieves entered the store of Messick & Co., Millington, Md., several nights ago by breaking open a rear window with a bar of iron. A lot of watches, jewelry and other goods was secured.

After midnight a few days ago a rock was thrown into the show window at C. W. Rickenbach's jewelry store, Reading, Pa. Two panes of glass, each about 3 feet by 18 inches, were broken.

E. F. Wheeler, jeweler, Paterson, N. J., has instituted suit against Mutaugh, the thief who stole a tray of diamonds from him, for \$2,000, the value of the goods in question. The accused is now in jail.

The store of Marsh & Hoffman, Albany, N. Y., was damaged to some extent one night last week by an overflow of water from the closet of the Empire Clothing Co. The water got into several cases of valuable jewelry.

The A. H. Towar Silver Plate Co., Lyons, N. Y., have shut down their factory for an indefinite period. The New Haven Silver Plate Co.'s factory in the same town has also shut down.

F. G. Bixby, watchmaker for Smyth & Ashe, Rochester, N. Y., has just received the appointment of official watch inspector for the Reading Railroad. For the past three years Mr. Bixby has held this position with the N. Y., L. E. & W. R. R. Co.

P. C. Hirschy and E. C. Regli, the former of St. Paul, Minn., have opened business in Rooms 5 and 6, Ingalls Block, Duluth, Minn. Their specialty is jewelry manufacturing, repairing and engraving. The firm name is Hirschy & Regli.

Barnard Schmidt, of St. Peter, Minn., has entered the employ of Jos. M. Geist, Duluth, Minn., as salesman and repairer. The Libby Cut Glass Co., Toledo, O., have appointed Mr. Geist agent for their goods in Duluth.

In a destructive fire in Louisville, Ky., last week, the business of Hager & Hetsch was affected to the extent of \$900. The stock of A. Goldstein, optician, was damaged to the extent of \$2,000; insurance \$6,300. The business of W. P. Brandenburg also suffered, principally, however, from water.

The funeral of Peter J. Walter, Springfield, Mass., who accidentally killed himself on the 6th inst., was held last week at the Cathedral. Mr. Walter's family are better provided for than was at first supposed for he leaves them heirs to \$10,000 insurance, which he carried. Half the amount was on an accident policy.

## Providence.

The property of William Bonner has been attached by E. A. Cook.

R. G. Schutz proposes to make a vacation trip to Saratoga on his bicycle.

B. F. Gilmore, 242 Westminster St., is out of the retail jewelry business.

Warren C. Greene, 131 Point St., has given up the manufacturing business.

Theodore W. Foster has gone to Martha's Vineyard for his Summer's outing.

G. P. Thurber is reported as having the started in manufacturing jewelry business at Pawtucket.

Martin L. Read is at his Summer cottage at Cananicut Park for the months of August and September.

The creditors in this vicinity of Adolph Goldsmith & Son, New York, are signing the agreement to accept 50 cents on the dollar.

Grover & Gleason have moved into the shop formerly occupied by Charles Sydney Smith in the Fitzgerald Building, 183 Eddy St.

At a recent meeting of the stockholders of the Kent & Stanley Co., the following officers were elected for the ensuing year: President, A. W. Stanley; vice-president, Theodore Harris; treasurer, E. F. Kent; secretary, J. D. Warren.

The stock, tools, machinery and fixtures of R. S. Cutting & Co., 409 Pine St., will be sold at auction at mortgagee's sale on Wednesday, the 16th inst., under foreclosure of two mortgages held by the Waterbury Brass Co., one of Jan. 25, 1890, of \$1, and the other of Jan. 7, 1892, of \$325.13.

Joshua Gray, the oldest retail jeweler in this city and one of the oldest in New England, has sold out and retired from business, being succeeded by Saati Bros., at 419 Westminster St. Mr. Gray commenced business in a small store on Westminster St., near Mathewson, early in the thirties, and for more than half a century daily conducted his business at the same place.

A couple of men stole last Tuesday, a whole tray of rings from M. H. Smith's store. The pair then went into Bogartz's, and called for some watches and jewelry. When the clerk's attention was attracted one of the fellows grabbed everything in sight and ran. Goods to the value of \$500 were taken from the two stores. One of the men was captured. He gave his name as William Lipman.

In a yard on Pine St., Wednesday night, a resident found a box labelled "Boston Beans," and upon removing the cover discovered that instead of containing Boston's favorite fruit it held a large quantity of Providence or Attleboro cheap jewelry. There were all sorts of novelties in it from a "gold collar button," two for five, up to a twenty-three cent lace pin. The box was handed over to the police and the next morning was identified by a Calender St. manufacturer as a package which he had consigned to a pedler.

# THE "SANDRINGHAM"

PATENTED JANUARY 24TH, 1893.

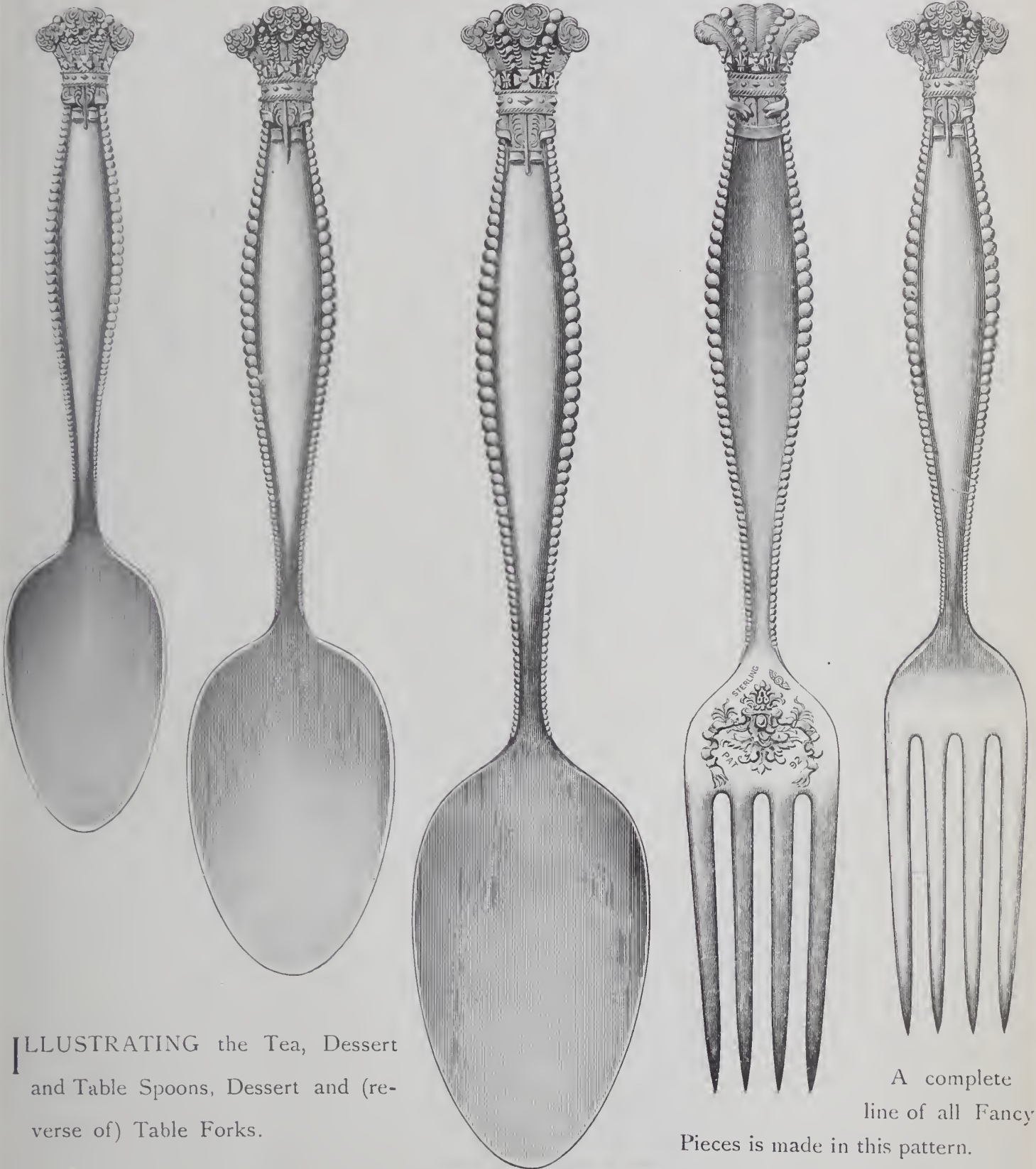

ILLUSTRATING the Tea, Dessert and Table Spoons, Dessert and (reverse of) Table Forks.

A complete line of all Fancy Pieces is made in this pattern.



Geo. W. Shiebler Co., Of the Silversmiths' Company, 179 Broadway, N. Y.

# CLASSIFIED INDEX TO ADVERTISEMENTS.

All Advertisements are entitled to one insertion under proper heading. Extra insertions, \$6.00 per annum. Extra Headings, \$12.00 per annum.

Page.		Page.		Page.
	<b>Aluminum Solder.</b>		<b>Gold and Silver Plating.</b>	
	De Redon, C., 43 W. 21st St., N. Y. .... 47		Brunor Plating and Jewelry Repairing Co.... Maiden Lane, N. Y. .... 5	
	<b>Art Pottery, Bric-a-brac, Etc.</b>		<b>Gold Jewelry.</b>	
	Bing, Ferdinand & Co., 106 Grand St., N. Y. . 44		Bippart & Co., Newark, N. J. .... 7	
	Borgfeldt, Geo. & Co., 18, 20 & 22 Washington Place, New York. .... 46		Carter, Sloan & Co., 15 Maiden Lane, N. Y. . 41	
	Bradley & Hubbard Mfg. Co., Meriden, Conn 8		Hook, G. W., Chicago, Ill. .... 25	
	Gleanzer Leon, J. & Co., 80 & 82 Chambers St., N.Y. .... 43		Kremetz & Co., 182 Broadway, N. Y. .... 8	
	Haviland & Abbott, 26 Barclay St., N. Y. .... 47		Racine Jewelry Mfg. Co., Racine, Wis. . . . . 32	
	Hinrichs & Co., 29 & 31 Park Place, N. Y. .... 47		Smith, C. Sydney, 191 Broadway, N. Y. .... 11	
	<b>Auctioneers.</b>		Street, Geo. O. & Sons, 15 John St., N. Y. .... 47	
	Comrie, A. J., P. O. Box 2403, New York. .... 33		Uhry, Chas. L. & Co., Newark, N. J. . . . . 5	
	Firuski, S. & Son, 85 Bowery, N. Y. .... 37		<b>Horological Schools.</b>	
	<b>Assayers &amp; Refiners.</b>		Parson's School for Watchmakers, Peoria, Ill. 27	
	Clark, J. L., Philadelphia, Pa. .... 47		<b>Hotels.</b>	
	Howard, S. P., 8 John St., N. Y. .... 48		Gibson House, Cincinnati, O. .... 27	
	<b>Badges, Medals, Etc.</b>		<b>Imported Clocks, Bronzes, Etc.</b>	
	Irons & Russell, Providence, R. I. .... 27		Jacques Chas., Clock Co., 22 Cortlandt St., N.Y. 48	
	Schlechter, G. A., Reading, Pa. .... 31		<b>Jewelry Mailing Boxes.</b>	
	Stockwell, E. R., 19 John St., N. Y. .... 37		Am. Railway Supply Co., 24 Park Place, N. Y. 32	
	Wilson, Chas. G., Reading, Pa. .... 28		<b>Jewelry, Silverware and Optical Cases.</b>	
	<b>Chains, Seamless.</b>		Birmingham, Wm. & Co., 728 Arch St., Phila. 47	
	Kent & Stanley Co., Providence, R. I. .... 4		Troesch, A. & Co., 69 Nassau St., N. Y. .... 32	
	<b>Clocks.</b>		Jackson, S. C., 180 Broadway . . . . . 47	
	Standard Electric Time Co., New Haven, Conn. 42		Wiggers & Froelick, 60 Nassau St., N. Y. .... 40	
	<b>Cut Glass.</b>		<b>Jobbers, Watches, Diamonds, Etc.</b>	
	Straus, L. & Sons, 42 to 48 Warren St., N. Y. . 15		Aikin-Lambert Jewelry Co., 19 Maiden Lane.. 10	
	<b>Diamond Cutters.</b>		Bowman, Ezra F. & Co., Lancaster, Pa. .... 31	
	Humphrey, J. B., Boston, Mass. .... 32		Cross & Beguelin, 17 Maiden Lane, N. Y. .... 10	
	<b>Diamond &amp; Precious Stone Importers.</b>		Giles Bros. & Co., W. H. Gleason, receiver, Chicago, Ill. .... 25	
	Bruhl Bros. & Co., 21 Maiden Lane, N. Y. .... 48		Lapp & Flershem, Chicago, Ill. .... 24	
	Disselkoe, John N., 19 E. 16th St., N. Y. .... 41		Myers, S. F. & Co., 48 Maiden Lane, N. Y. . 48	
	Falkenau, Oppenheimer & Co., 40 Maiden Lane, N. Y. .... 48		Yates, John B., Hays Building, Maiden Lane, N. Y. .... 30	
	Hedges, Wm. S. & Co., 170 Broadway, N. Y. . 40		Young, Otto & Co. Chicago, Ill. .... 21	
	Kahn, L. & M. & Co., 10 Maiden Lane, N. Y. . 48		<b>Musical Boxes.</b>	
	Kipling, R. A., Hays Bldg., N. Y. .... 40		Jacot & Son, 208 Broadway, N. Y. .... 10	
	Kling, H. M. & Co., 11 John St., N. Y. .... 48		Wolff, A., 194 Broadway, N. Y. .... 47	
	Ludeke & Power, 23 John St., N. Y. .... 40		<b>Optical Goods.</b>	
	Nissen, Ludwig & Co., 18 John St., N. Y. .... 40		Laurecot, Jules, 49 Maiden Lane, N. Y. .... 44	
	Randel, Baremore & Billings, 29 Maiden Lane, 41		Queen & Co., Philadelphia, Pa. .... 32	
	Smith, Alfred H. & Co., 182 Broadway, N. Y. . 40		Sanborn, J. W. & Co., Boston, Mass. .... 36	
	Taylor & Bro., 860 Broadway, N. Y. .... 43		Spencer Optical Co., 15 Maiden Lane, N. Y. . 10	
	Wolff & Gunzburger, 87 Nassau St. N. Y. .... 48		The Nous Verrons Co., Boston, Mass. .... 47	
	<b>Diamond Jewelry.</b>		Zineman, M. & Bro., Philadelphia, Pa. .... 32	
	Bonner, Rich & Co., 41 Maiden Lane, N. Y. . 32		<b>Pens, Pencil Cases, Etc.</b>	
	Waterman & Lehman, 37 Maiden Lane, N. Y. 32		Aikin, Lambert & Co., 19 Maiden Lane, N. Y. 32	
	<b>Engravers &amp; Designers.</b>		<b>Patents.</b>	
	Bartholomew, W. H., 18 Spruce St., N. Y. .... 47		Cox & Sons, 11 Park Row, N. Y. . . . . 37	
	<b>Fine Stationery.</b>		<b>Rolled Plate Jewelry.</b>	
	Parsons, Green & Co., 18 Murray St., N. Y. . . 5		Dederick, J. H., 16 Maiden Lane, N. Y. .... 32	
	<b>Fountain Pens.</b>		<b>Ring Makers.</b>	
	The Boston Pen Co., Boston, Mass. .... 32		Bowden, J. B. & Co., 192 Broadway, N. Y. . . 7	
	<b>Eye Glass Holders and Chains.</b>		Hildreth Mfg. Co., 51 Maiden Lane, N. Y. . . 8	
	Merritt, S. F., Springfield, Mass. .... 29		<b>Sample Trunks.</b>	
			Crouch & Fitzgerald, 161 Broadway, N. Y. . . . 42	
			<b>Settings and Galleries.</b>	
			Blancard & Co., 36 John St., N. Y. .... 28	
			<b>Silversmith.</b>	
			Rohrbach, Henry J., 94-96 State St., Chicago, 25	
			<b>Silver Mounted Ebony Goods.</b>	
			Deutsch Bros., 7 E. 17th St., N. Y. .... 2-3	
			Provenzano, J. N., 39 Union Square, N. Y. . . . 12	
			<b>Silver Plated Ware.</b>	
			Homan & Co., Cincinnati, O. .... 19	
			Pairpoint Mfg. Co., New Bedford, Mass. .... 5	
			Rogers & Bro., 16 Courtlandt St., N. Y. .... 17	
			Rogers, Smith & Co., Meriden, Conn. .... 9	
			<b>Sterling Silverware.</b>	
			Campbell-Metcalf Silver Co., Providence, R. I. 7	
			Dirksen Silver Filigree Co., Freeport, Ill. .... 23	
			Knowles, J. B. & S. M., Co., Silversmiths' Hall, Union Square, N. Y. .... 7	
			Ovaite & Warner, Portland, Oregon. .... 37	
			Reed & Barton, 37 Union Sq., N. Y. .... 31	
			Shiebler, Geo. W., Co., 179 Broadway, N. Y. . 31	
			Simons Bros. & Co., Chicago, Ill. .... 19	
			Towle Mfg. Co., Newburyport, Mass. .... 43	
			Wallace, R. & Sons Mfg. Co., 3 Park Place, N. Y. .... 6	
			Wood & Hughes, 10 John St., N. Y. .... 11	
			<b>Tool Manufacturers and Dealers.</b>	
			Bullock, O. W., Springfield, Mass. .... . . . .	
			Chicago Watch Tool Co., Chicago, Ill. .... 27	
			Gesswein, F. W., 39 John St., N. Y. .... 44	
			Horological Tool Co., Chicago, Ill. .... 25	
			Mosely & Co., Elgin, Ill. .... 23	
			<b>Show Cases.</b>	
			Smith, B. & W. B., 220 W. 29th St., N. Y. .... 48	
			<b>Trunks and Traveling Bags.</b>	
			Crouch & Fitzgerald, 161 Broadway, N. Y. . . . 42	
			<b>Watch Case Manufacturers.</b>	
			Goll, Henry, 17 John St., N. Y. .... 44	
			The Planchamp & Becker Co., Chicago, Ill. . . 27	
			The Wadsworth Watch Case Co., Newport, Ky. .... 26	
			<b>Watch and Clock Dials.</b>	
			Waltham Dial Co., Waltham, Mass. .... 47	
			<b>Watchman's Clocks.</b>	
			Hausburg, O. E., 41 Maiden Lane, N. Y. .... 37	
			<b>Watch Importers.</b>	
			Hyde's, J. E., Sons., 22 Maiden Lane, N. Y. . . 40	
			Mathey Bros. & Mathez Co., 21 & 23 Maiden Lane, N. Y. .... 29	
			Wittnauer, A., 19 Maiden Lane, N. Y. .... 28	
			<b>Watch Keys.</b>	
			Clark, A. N., Plainville, Conn. .... 32	

## Special Notices.

Rates 75c. per insertion for notices not exceeding 3 lines (25 words), additional words 2 cents each. If answers are to be forwarded, postage stamps must be enclosed. Two insertions, 15 per cent. off; three insertions, 20 per cent. off; four insertions or more, 25 per cent. off. Payable strictly in advance. Display cards on this page will be charged at \$2.00 per inch for first insertion, subject to same discount as above for subsequent insertions.

Under the heading of **Situations Wanted** on this page advertisements will be inserted for **One Cent a Word**. This offer refers to **Situations Wanted only**. Payable strictly in advance. If answers are to be forwarded, postage must be enclosed.

## Situations Wanted.

Notices under this heading **ONLY** are charged at one cent a word, payable strictly in advance. If answer are to be forwarded, postage must be enclosed.

**POSITION** as salesman, Retail jewelry or silverware. Experienced. References. Address, "F," care, **JEWELERS' CIRCULAR**.

**WANTED**—A watchmaker, engraver and salesman, sober, industrious and A1 workman, would like a position with a first-class jewelry firm by Sept. 1st. Address, stating salary, "Business" B, care **JEWELERS' CIRCULAR**.

**SITUATION WANTED**.—An experienced traveler wishes a position in a first-class house. Many years on the road and well acquainted in all sections east of Omaha. Diamond house preferred. Address E. D., **JEWELERS' CIRCULAR**.

**BY WATCHMAKER** with seven years' experience. Fair engraver. Wages \$15 per week. Will furnish my own tools and good reference. None but good houses which can furnish steady position need apply. Address "Staff," care **JEWELERS' CIRCULAR**.

**ENGRAVER AND SALESMAN**.—First-class man with A1 references desires a situation in a large jewelry store. Good all round workman. New York or Brooklyn, Middle or Eastern States preferred. Address Mizpah, care **JEWELERS' CIRCULAR**.

**WANTED**—By a young man 22 years of age, a position to represent a manufacturing jeweler or precious stone house in the city or on the road, or position in office. Reference unquestioned. Long experience in the business. H., care of **JEWELERS' CIRCULAR**.

**WANTED**—Position as first-class watchmaker; experience and constant practice of over twenty years in English and American watchmaking and in all fine and complicated work; competent salesman; references and tools; age, forty-five; not jewelry repairer or engraver. E. H. Sheriff, 136 Elm St. Newark, N. J.

**POSITION** wanted by young Swede as watchmaker and clock repairer; three years' experience; speaks English; own tools; best references. Address Mechanicsville, N. Y. Lock Drawer No. 6.

**SITUATIONS WANTED**—I desire a position as watchmaker, jeweler and optician, or to travel with optical goods, jewelry or silverware. References. Address Watchmaker, Box 592 Ware, Mass.

**SITUATION** Wanted.—By a young man 24 years of age; 7 years' experience at the bench in retail store; Best of references. Address S. H. W., care of **JEWELERS' CIRCULAR**.

**SITUATION** Wanted—Watchmaker and Optician, experienced, wants a position about Oct. 10th. Am considered a good man. Address T. B., 72 Fount Avenue, Delaware, O.

**SITUATION** Wanted as watchmaker and jeweler by a single man 27 years of age. Address Ed S., Dresden, O.

**SITUATION** Wanted—First-class Watchmaker, 30 years of age, desires permanent situation, Indiana or Illinois, after Sept. 18th. References exchanged. Address Mitchell, care of **JEWELERS' CIRCULAR**.

**SITUATION** Wanted by a first-class rapid watchmaker, jobber and plain engraver; good salesman, single man, strictly temperate. Pacific Coast preferred. Address G. W. C., Lock Box 62, Poplar Bluff, Mo.

**WATCHMAKER**—Young man (26) desires permanent situation in New York or vicinity; is first-class workman and has A No. 1 recommendation. Address O. M. X., care **JEWELERS' CIRCULAR**.

**A GRADUATE OPTICIAN** who is thoroughly competent desires a permanent position by Sept. 1st. Will furnish best of references. Address Optician, B, 31 State St., Saratoga Springs, N. Y.

**YOUNG LADY**, four years' experience, desires position in optical store, Philadelphia, as bookkeeper and saleslady. Has done some fitting. Fully competent, understands the business. M. 18, care **JEWELERS' CIRCULAR**.

**FINE WATCHMAKER** and jeweler would like position by Sept. 15th. Good references, own tools, sober. Texas or adjoining States preferred. Salary \$18.00. Address "Texas," Care **CIRCULAR**.

**SITUATION**—First-class American watchmaker. Fine engraver. Married. Good address. Twenty-five years' experience. Fine bench, American lathe. Bench tools. Neat, profitable, reliable. All references. Address "West," care **JEWELERS' CIRCULAR**.

**SITUATION** wanted—Watchmaker and engraver wants a position with some reliable firm; good references. Address Box 21, Bonckville, N. Y.

## Help Wanted.

**WANTED**—Experienced traveling salesman to carry a leading and well-known line of spectacles and eye-glasses; samples easily carried; liberal commission. Address Optics, care **JEWELERS' CIRCULAR**.

**WANTED**—A Salesman for Jewelers' and Machinists' Tools and Supplies. Must have a good trade following. No attention will be paid to applicants not having above qualifications. Address Salesman, **JEWELERS' CIRCULAR**, N. Y.

**WANTED**—A practical jeweler and designer to take charge of a factory in an old established business. To a man with some capital an interest in the business will be given. Address, A. J., care **JEWELERS' CIRCULAR**.

**WANTED**—By a wholesale Maiden Lane firm, an intelligent well educated boy living with his parents, to do general office work. One that has had some experience in the watch line preferred. Will receive advancement if satisfactory. Best references required. Address by letter. L. W. C., care **JEWELERS' CIRCULAR**.

## For Sale.

**FOR SALE**—An electric engraving machine; in good order, with three fonts of type; also battery. Or will exchange it for jewelers' rolls. W. T. Volger & Son, 234 Main St., Winston, N. C.

**FOR SALE**—A first-class jewelry store, established fourteen years, where stock and fixtures costing \$4,500 can be secured for \$2,350, or, if desired, can give lease of store with fixtures and sell stock for \$1,500, one thousand dollars cash and balance on easy terms. Bench work alone amounts to over \$1,800 yearly. The location of the store and profits of the business will stand thorough investigation. Address Frank C. Kibby, No. 366 Broadway, Chelsea, Mass.

**LAKEWOOD**, N. J.—Farm for sale or exchange for first-class jewelry store or diamonds; a home and productive farm, in splendid order. Principals only address P. O. Box 29, Delhi, Delaware Co., N. Y.

**FOR SALE**.—\$500 for \$300 cash. Jewelry, News Depot and furnished rooms for two. Rent \$8. Store pays profit; bench work for one. Address Cyrus Condit, 2344 Bellevue Avenue, Kansas City, Mo.

**FOR SALE**—A Rare Chance. A recently established jobbing, cutlery and silver plated ware business, with New England agencies, is offered for sale. Present proprietor's engagements prevent his devoting the necessary time to the business. A live, pushing man will find this an opportunity seldom offered. Buyer can have immediate possession. Offer must be in cash or well secured paper. Address Jobbing Business, care of **JEWELERS' CIRCULAR**.

## Miscellaneous.

**I BUY JEWELRY STOCKS**—Manufacturers, jobbers and retailers desiring to dispose of surplus or entire stocks of diamonds, watches and jewelry can find quick cash buyer by addressing Stephen S. Harmon, 134 East 96th St., New York city.

## DEMAGNETIZING.

**PERFECT WORK**—Watch repairing in all its branches; all work warranted. Winslow & Penney, 608 Masonic Temple, Chicago.

**FOR FIRST-CLASS INSTRUCTION** in watch work go to W. F. A. Woodcock, Winona, Minn.

**AN** unmarried man to work on shares (one-half) in a village repairing establishment. Enclose stamp if reply is desired. Address Box 37, Smithville, Va.

**BUSINESS OPPORTUNITY**—Good stand for repairing watchmaker and jeweler to rent at Yonkers, N. Y., \$25 per month. Address G. P. Reeve, Yonkers, N. Y.

**HARD** soldering made an easy task for anyone. Guaranteed the best and cheapest thing or money refunded. 50c. F. L. Wells, Marion Center, Pa.

## To Let.

**TO LEASE**—A Game Preserve in the Adirondacks. Plenty of Deer and Trout. Address Chas. Heaton, Jeweler, Potsdam, N. Y.

**TO LET**—Fine front office in Knapp Building; apply to Isidor Elbe, 41 Maiden Lane, Room 17.

## Headquarters

FOR **ELECTRIC & PORTABLE Watchman's Clocks**



Lowest Prices. Latest Improvements, Patents 1886-1893. Send for Circular.

**E. O. HAUSBURG,**

41 Maiden Lane, New York. THE "ALERT."

**SOLICITORS OF AMERICAN & FOREIGN PATENTS**  
 FOR **DESIGNS INVENTIONS & TRADE MARKS**  
 SEARCHES MADE & INFRINGEMENTS PROSECUTED OR DEFENDED  
 THE TRADE WILL BE HAVING THEIR PATENTS TAKEN BY  
**SAVE TIME AND MONEY**  
**COX & SONS 11 PARK ROW, N.Y.**

## PAWNBROKERS' SALES

BY

## S. FIRUSKI & SON,

AUCTIONEERS,

85 Bowery, New York,

AT 11 A. M.

See N. Y. Herald for full particulars of Sales.

The Trade is Respectfully Solicited to Attend.

## JEWELERS.

We guarantee to sell you Sterling Silver Flat Ware at a less price than any other manufacturer, and give you newer designs.

We will increase your profits if you will let us. Is it not worth trying?

**OVAITT & WARNER, Silversmiths, PORTLAND, OREGON.**

## For BADGES AND MEDALS.

Flag Pins, Class Pins, Class Rings

and Special Work of all Descriptions

SEND TO **E. R. STOCKWELL, MANUF'R.**

19 John Street, New York

## CLEAN JEWELRY SELLS QUICK.

Quarters' Cleaning Solution removes dirt and tarnish in an instant, makes stock like new and brings up diamond and stone work to a beautiful lustre. Solution can be used over and over. Highly commended by all who use it. Sent at once \$1.50 for half gallon with full directions. References.

**W. F. QUARTERS, ELECTROPLATER, 139 EDDY STREET. PROVIDENCE, R.**

The Latest Patents.

ISSUE OF JULY 11, 1893.

501,108. STEM WINDING AND SETTING WATCH. NATHAN SILBERBERG, Jassy, Roumania.—Filed Mar. 12, 1891. Serial No. 384,801. (Model.) Patented in Switzerland Sept. 22, 1890. No. 2,657.

In a stem-winding watch, the combination with the main-spring having winding gear g<sup>3</sup>, and the stem arbor A, of winding mechanism consisting of the gear g<sup>2</sup> driven from the arbor A. pinion g<sup>2</sup> meshing with gear g<sup>1</sup>, and movable yoke l carrying the former, piv-

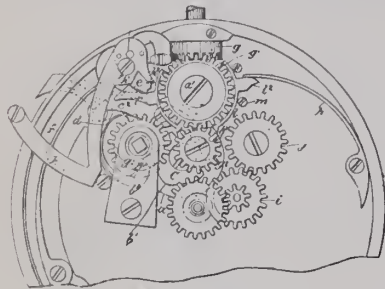

oted axially of gear g<sup>1</sup>, and adapted when moved to bring pinion g<sup>2</sup> into engagement with gear g<sup>3</sup>, to wind the mainspring, and means for controlling the position of said winding mechanism consisting of the lever k engaging the arm l of yoke l and adapted when operated to move the latter on its axis, and a lock for said lever consisting of the stop lever c<sup>2</sup> engaging it, and cam b<sup>1</sup> operated by a moving part of the watch and constructed to free said lock.

511,157. PLATED WIRE STOCK FOR JEWELRY AND METHOD OF MAKING SAME. JOHN S. PALMER, Providence, R. I.—Filed Mar. 16, 1891. Serial No. 385,179. (No model.)

The described process of plating precious metal of unequal thickness upon a rod of baser metal—consist-

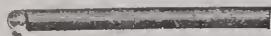

ing in first forming a tube of unequal transverse thickness, next drawing such tube upon a rod of baser metal, and then soldering or "sweating" together such tube and rod.

501,210. WATCH-BOW FASTENER. FRITZ MINK, Philadelphia, Pa., assignor to the Keystone Watch Case Co., same place.—Filed Nov. 29, 1892. Serial No. 453,526. (No model.)

The combination with the pendant of a watch case provided with laterally projecting arms, rotary sleeves

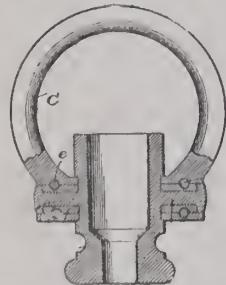

carried by the arms and held thereon, and a bow having its ends provided with eyes fitting over the rotary sleeves on the arms of the pendant and directly secured to said sleeves.

501,232. JEWELRY AND METHOD OF MAKING SAME. HERMAN T. REGGELI, JAMES A. BIGNEY and CHARLES O. SWEET, of Attleboro, Mass.—Filed April 17, 1893. Serial No. 470,732. (No specimens.)

The method herein described for constructing articles of jewelry consisting of forming the petals from sheet metal, next surrounding the same with an ornamental metallic border, then grouping the petals together to form a flower, and finally applying to the central

portion of the petals, coloring matter by brushing the same thereon.

501,332. NAPKIN-RING. ERNEST DREVET, New York, N. Y.—Filed Oct. 11, 1892. Serial No. 448,523. (No model.)

A napkin-ring consisting in the two curved bands 10, 10, overlapped at both of their ends and pivoted

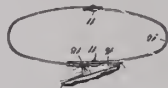

together by pivots 11, 11, and the clasp 14 pivoted between its ends at 18 upon the upper or outer side of the end of one of the bands 10 and provided with a spring pressing one of its ends against the said band, the opposite end of the clasp serving as a finger piece for opening it.

501,365. MEANS FOR SECURING DETACHABLE ORNAMENTS IN ARTICLES OF JEWELRY. JOHANN W. L. ROHDE, London, England.—Filed Dec. 28, 1892. Serial No. 456,539. (No model.) Patented in England July 13, 1892. No. 12,851.

In an article of jewelry having a detachable ornament secured thereto by a screw connection, the herin-



before described means for preventing the unscrewing or loosening of such ornament, consisting of a springless pivoted locking blade or tongue on the article adapted to engage with a slot or notch in the ornament.

DESIGN 22,597. BADGE. ALONZO P. CON-



NOLLY, Chicago, Ill.—Filed Dec. 5, 1892. Serial No. 454,411. Term of patent 7 years.

DESIGN 22,598. WATCH CHARM. ANDREW



MULCAV, Forsyth, Ga.—Filed Jan. 6, 1893. Serial No. 457,550. Term of patent 3 1/2 years.

DESIGN 22,599. WATCH DIAL. JOHN C. DUF-



BER, Canton Ohio.—Filed March 14, 1893. Serial No. 465,974. Term of patent 14 years.

DESIGN 22,602. PLATE. GEORGE A. GLAHN, Wallingford, Conn., assignor to the Simpson, Hall,



Miller & Company, same place.—Filed Apr 21,

1893. Serial No. 471,349. Term of patent 3 1/2 years. DESIGN 22,600. PLAQUE. JOSEPH A. GOLD-



STEIN, Washington, D. C.—Filed June 14, 1893. Serial No. 477,599. Term of patent 3 1/2 years.

TRADEMARK 23,326. GOLD, SILVER, AND PLATED FLAT AND TABLE WARE, AND JEWELRY. WILLIAM B. DURGIN, Concord, N. H.—Filed June 16, 1893.

CROMWELL.

Essential feature.—The word "CROMWELL." Used since May 15, 1893.

TRADEMARK 23,330. EVE GUARDS AND PROTECTORS. EDWARD G. STEVENS, Boston, Mass.—Filed June 7, 1893.

WARREN

Essential feature.—The word "WARREN." Used since December 7, 1892.

ISSUE OF JULY 18.

501,725. LINK FOR SLEEVE OR CUFF BUTTONS. GEORGE F. KURSH, Philadelphia, Pa.—Filed July 11, 1892. Serial No. 439,569. (No model.)

Two cuff buttons having a connecting link consisting of a single piece of material formed with a coiled spring at one end, engaging the eye of one of the buttons, and



having crossed shanks with oppositely formed hooked ends, producing a loop engaging the eye of the other button, said coil spring normally closing said hooked ends, so as to form said loop.

501,895. FOUNTAIN PEN. MORRIS W. MOORE, Holyoke, Mass., assignor of five-sixths to Joseph E. Chase and William B. Park, same place.—Filed Jan. 13, 1893. Serial No. 458,273. (No model.)

In a fountain pen, the combination with the barrel or

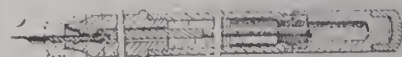

reservoir having in its upper end a circular opening with a peripheral depression, the annular packing of soft rubber having an external circumferential bead and the rod movable through the packing.

DESIGN 22,628. BREASTPIN. EUGENE DE-ROGAT, Newark, N. J. Filed Jan. 28, 1893. Serial



No. 460,169. Term of patent 3 1/2 years.

DESIGN 22,627. BRUSH BACK OR SIMILAR ARTICLE. CHARLES OSBORNE, New York, N. Y., assignor to the Whiting Manufacturing Com-



pany, same place. - Filed May 18, 1893. Serial No. 474,706. Term of patent 3 1/2 years.

DESIGN 22,629. SPOON. FREDERICK F. HORN, Colorado Springs, Colo. - Filed May 29, 1893. Ser-



ial No. 475,971. Term of patent 3 1/2 years.

DESIGN 22,636. BADGE. WILLIAM H. BARTLETT, Worcester, Mass. - Filed April 19, 1893.



Serial No. 471,042. Term of patent 14 years.

DESIGN 22,637. BADGE. CHARLES L. EDWARDS, Dallas, Tex. - Filed May 9, 1893. Serial



No. 473,632. Term of patent 7 years.

DESIGN 22,638. BADGE PIN. HERRERT L. NORRIS, Providence, R. I. - Filed Oct. 5, 1892.

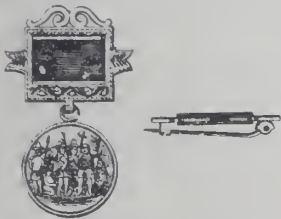

Serial No. 447,964. Term of patent 7 years.

DESIGN 22,641. JEWEL CASSET. JEAN I. BOULAY, Paris, France. - Filed April 20, 1893. Ser-

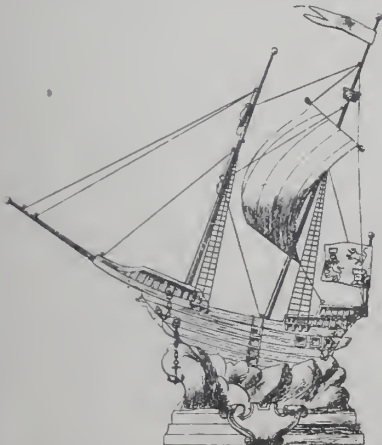

ial No. 471,220. Term of patent 3 1/2 years. Patented in France Jan. 14, 1893, No. 3,071.

DESIGN 22,639. SPOON. CHARLES B. BARKER,



Brooklyn, N. Y. - Filed June 14, 1893. Serial No. 477,600. Term of patent 3 1/2 years.

Last Week's Arrivals.

*THE CIRCULAR* has perfected arrangements for obtaining the names and hotel addresses of all the latest buyers visiting New York, and each day posts in its office, 189 Broadway, a bulletin which every member of the trade is cordially invited to copy.

The following out-of-town dealers were registered in New York during the past week: S. Levi, Baltimore, Md., Imperial II.; J. Newman, Boston, Mass., Vendome II.; E. Cohen, Albany, N. Y., Grand Union II.; W. H. Richardson, Boston, Mass., Everett II.; W. Earle, Philadelphia, Pa., Coleman II.; J. Anderson, Chicago, Ill., St. Stephen H.; W. H. Moore, Philadelphia, Pa., Union Square II.; T. H. Jones, Boston, Mass., Murray Hill II.; H. D. Stern, Chicago, Ill., Murray Hill II.; J. Bennett, Philadelphia, Pa., Broadway Central II.; T. Grunwaldt, New Orleans, La., Astor II.; G. N. Kingsbury, Boston, Mass., Sturtevant H.; D. McCarthy, Syracuse, N. Y., Imperial II.; C. P. Williams, Butler, Pa., Astor H.; S. Oppenheimer, Chicago, Ill., Astor II.; P. Greenberg, San Francisco, Cal., Metropolitan H.; L. L. Camp, New Haven, Conn., Marlborough II.; E. J. Walter, Baltimore, Md., Marlborough II.; L. Emery, Jr., Bradford, Pa., Bartholdi H.; Wm. Nugent, buyer of toilet articles, etc., for B. Nugent & Bros., St. Louis, Mo., 256 Church St.; H. V. Gavigan, buyer for The Daggett D. G. Co., Kansas City, Mo., Park Ave. H.; C. E. Crosby, buyer for The J. S. Menken Co., Memphis, Tenn., St. Stephen H.; M. Parker, Bridgeport, Conn., International H.; F. J. Dorn, Buffalo, N. Y., Sinclair H.; C. E. Goodrich, Chicago, Ill., Astor H.; C. S. Davis, Philadelphia, Pa., Astor H.; J. Van Valkenburg, Albany, N. Y., Murray Hill H.; M. Goldenberg, Baltimore, Md., Broadway Central H.; T. Bell, Baltimore, Md., Coleman H.; G. C. Berry, buyer of crockery, etc., for Berry & Son, Akron, O., Imperial H.

A unique novelty in oxidized silver key-rings is now being placed on the market by Simons, Bro. & Co., Philadelphia, Pa. The ring is of rustic design, circular, with one side nearly straight, forming a reversible screw on which a nut, turning joins the two parts and makes a solid ring. At the opposite side is a pig. A hinge at the pig's snout allows the ring to be opened when the nut is turned to the left. On the segments of the circle between the pig and the screw are, on one side the word, Chicago and the figures, 1893; on the other, World's Fair. It is a sterling silver novelty that forms an interesting souvenir of the great Columbian event.

Trade Gossip.

The Meriden Britannia Co., Meriden, Conn., have just issued a very artistic catalogue of prize emps illustrating over five dozen designs with emblems to suit any event. The cover is in tints in a special design and the book should be in every jeweler's hands.

The New Haven Clock Co., New Haven, Ct., offer the trade some excellent and salable goods in their new line of marbled clocks. An artificial stone, the material is much lighter than either onyx or marble, which it resembles perfectly in their finest effects. The cases are all dovetailed and fitted together, doing away with all plaster, and may be lifted by the tops or any other portion. The clocks are fitted with the highest grade pendulum movements, cast brass Empire sashes and convex glasses. The company have also in readiness a new line of hall clocks which will sell within \$35 at retail.

A beautiful departure in toilet articles has been introduced by J. N. Provenzano, 39 Union Square, New York, in the line of brushes, trays, shoe horns, paper cutters, powder boxes, nail polishers and all other articles for toilet use. Mr. Provenzano is making these articles of solid ebony mounted with sterling silver pierced work. The jet black background gives the silver a wonderful brilliancy, while the artistic scroll work of the silver relieves the dead black color of the ebony, altogether producing a combination which for richness and beauty has never been surpassed. This line, which includes over fifty different pieces, is among the finest ever introduced and needs but to be seen in order to be purchased.

An example of enterprise is the shortest description which can be given the electroplating establishment of Emile Brunor, in the Black Building, 93 William St., New York. The shop, which is fitted up with the latest improved machinery for jewelry polishing, jewelry lapping and gold and silver electroplating, has a capacity for plating one hundred watch cases per hour and employs seventeen hands on jewelry polishing alone. Emile Brunor's father, Martin Brunor, formerly manager of the Brunor Plating & Jewelry Repairing Co., is now in charge of this establishment and has fitted it up with the Brunor dynamo and apparatus for his own new process of electroplating, for which is claimed many advantages over other processes. Mr. Brunor showed a CIRCULAR representative a watch case which had just come from the bath. It was highly polished and needed no retouching. This he said was one of the distinguishing features of his process. He is still working assiduously on his book, "The Practical Electroplater," the publication of which has been delayed by reason of Mr. Brunor's time being taken up by matters subsequent to his recent business changes. He confidently expects to have it ready for distribution within a short time.

**DIAMONDS.**

**Wm. S. Hedges & Co.,**

**Importers of Diamonds,**

And Manufacturers of DIAMOND JEWELRY.

No. 170 BROADWAY,  
S. E. Cor. Maiden Lane, } New York.  
27 Holborn Viaduct, London.



18 JOHN ST. NEW YORK

**Alfred H. Smith & Co.,**

IMPORTERS

**DIAMONDS**

AND

PRECIOUS STONES,

182 BROADWAY, COR. JOHN STREET,

NEW YORK.

33 Holborn Viaduct, London, E. C.

**R. A. KIPLING,**

Importer of

**PRECIOUS STONES,**

21 & 23 Maiden Lane,

19, RUE DROUOT, Paris. New York.



**PEARLS.**

**RUD. C. HAHN,**

194 BROADWAY, NEW YORK.

**GARNETS.**



**LUDEKE & POWER,**

IMPORTERS OF DIAMONDS

AND OTHER PRECIOUS STONES,

ADOLPH LUDEKE,  
CHAS. L. POWER. 23 JOHN STREET, N. Y.

**Jules Jürgensen**  
OF COPENHAGEN

The reputation these watches have maintained for Fifty Years has never been equalled, being made on strictly scientific principles and no expense spared to give the BEST results in mechanism and timekeeping qualities.

SOLE AGENTS,  
**John C. Hyde's Sons,**  
NO. 22 MAIDEN LANE.

**WIGGERS & FROELICK,**  
60 NASSAU ST., NEW YORK.

**Sample Cases and Trays**  
For Watches, Jewelry, Optical Goods, Etc.

**WE STRIVE TO MAKE THE BEST.**

Jewelers who have used the cleaning solution offered by W. F. Quarters, 139 Eddy St., Providence, R. I., commend it highly. It brings diamond and stone work to a beautiful lustre and may be used over and over again. Price \$1.50 per half-gallon.

There is no talk of dull business in the prescription department of the Spencer Optical Mfg. Co. We are told the rush in this department exceeds anything heretofore experienced. A rush in this special department means that thousands of persons are to have special glasses that will be beneficial. The correct and satisfactory fitting of these cases will aid in placing the optical trade or profession on a higher plane.

R., L. & M. Friedlander, 65-67 Nassau St., New York, have at present a very large assortment of sterling silver souvenir spoons, at the very low price of \$6.00 to \$7.50 per dozen. The firm will shortly have ready a new "Diamond, Watch and Jewelry Catalogue No. 50." This book is entirely new, containing only the very latest and most salable patterns with prices suited to the times. Send your business card and you will receive one.

Waterman & Lehmann, 37 Maiden Lane, New York, will soon issue a new catalogue, which will contain all their latest designs in diamond ring mountings, and which will be sent to the trade about Sept. 1st. About one hundred and fifty new styles will be illustrated. These designs will materially help the jeweler in taking orders, for as no name or price will appear on its pages, the catalogue may be exhibited to customers without hesitation. The reputation this firm enjoy for the careful and prompt method in which they fill orders is thoroughly established, and the recipients of the catalogue may rest assured that there will be no delay nor dissatisfaction when ordering from Waterman & Lehmann.

The brahmin who believes that the evolution of matter is always accompanied by an involution of mind would find his theory illustrated in a dozen sheets of half-tones published by Blancard & Co., 45 John St., New York, as an addition to their catalogue of settings and ornamental designs for jewelry of every kind. Time was when the goldsmith was a cunning artificer, ranking as an artist; to-day he may be but a clever mechanic who puts together the graceful designs here furnished in fashion to suit the taste or purse of his patrons, but he must show genius if he has it. The twelve pages are an alphabet of artistic work, duplicated by machine, out of which intelligent mechanical talent can weave a thousand forms of beauty. The jeweler, brought into sharp competition with machine made patterns, and unable to afford the time to use the talent he may possess in fashioning, may by the use of these primary forms create original designs, and give to each customer something unique without the expense which has hitherto stood in the way, enabling the machine made design to drive him out of business.



**Fashions in Jewelry and Silver-Ware.**

A LADY'S RAMBLES AMONG THE JEWELERS.

The sheaths of swords will fair to rival the hilts.

The English have what is called a "tea salkey," but who knows what it is?

A diamond necklace had festoons of oval turquoises set with small diamonds.

A new flower spoon has a stem which terminates in a white enamel lily.

A pitcher in gilt filigree is a trifle scarcely more substantial than a soap bubble.

The slenderest sort of crescent almost three inches from tip to tip is made with pearls.

A glass service for the King of Italy recently made is intended for the use of one hundred and fifty people.

A large cut glass bowl for powder has a shallow cover of lusterless silver gilt on which the powder puff is to rest.

An egg steamer is in the shape of large eggs held over an alcohol lamp, and on the cover is a bird with outstretched wings.

Coral is coming into use for hat pins. Some handsome ones have been seen with carved coral heads an inch and a half long.

A number of pieces of silver gilt with dead surface have been recently seen. They are perhaps more attractive than the polished gilt.

The ever adjustable serpent is coiled at the heads of some of the new pins with jeweled eyes; these are made very ornamental.

There is a new demand for intaglios. The mannishness of women's attire seems to require an intaglio ring as a proper accessory.

English women are going in for diamond belts. Lady Brooke and Lady Londonderry have both appeared recently in magnificent zones in keeping with their tiaras. Another new feature is a turquoise collar.

Roman gold locket with smooth faces and raised gold edges have been brought out in numbers. The center is left smooth for a monogram or has some device in which colored stones or diamonds are set. The stones are not set solid, but at intervals.

There seems to be a fashion for rings with oblong settings. These have an almost geometrical accuracy in the gold outline; within are precious stones in one or two rows. One ring had cross lines of gold set with small stones at the points of intersection.

There is a fancy for large jewels *en cabochon*. Emeralds and sapphires have been seen thus in numbers. In the handsomest brooches a large smooth round stone is set in diamond forms and another pear shaped forms the pendant. Very large colored stones are seen with tubular surface and faceted edges.

ELSIE BEE.

ESTABLISHED 50 YEARS.

**RANDEL, BAREMORE & BILLINGS,**

IMPORTERS OF

**DIAMONDS,**

AND OTHER PRECIOUS STONES.

**FINE PEARLS A SPECIALTY.**

MANUFACTURERS OF

**DIAMOND JEWELRY,**

IN THE LATEST DESIGNS.

Diamonds Recut in Modern Styles or Repaired on Premises.

58 Nassau Street,  
29 Maiden Lane  
NEW YORK.

1 Tulp Straat,  
AMSTERDAM.

1 St. Andrews St.,  
Holborn Circus,  
LONDON, E. C.



TRADE MARK.

ESTABLISHED 1841.

**CARTER, SLOAN & CO.,**

**MANUFACTURERS OF GOLD JEWELRY,**

NO 15 MAIDEN LANE,

NEW YORK.

A. CARTER, JR.  
A. K. SLOAN.  
C. E. HASTINGS.

GEO. R. HOWE.  
WM. T. CARTER.  
WM. T. GOUGH.

FACTORY, NEWARK, N. J.



**JOHN N. DISSELKOEN,**  
Cutter and Importer of  
**DIAMONDS**

FACTORY,  
76 LANGBLEEKERSPAD,  
AMSTERDAM.

19 East 16th St.,  
NEW YORK.

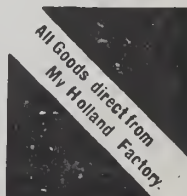

**New Style of Mainspring for Stemwinders.**

TO those parts of the watch the original shapes of which have undergone no alteration since its invention, doubtless belongs the mainspring. It originated from the necessity of making portable the wheel clicks which were until then actuated by water pressure or weight, and from its incipency, it was a long steel ribbon wound into a flat spiral, the inner end of which was fastened to an arbor and the outer end either to the interior side of the spring barrel or direct to the spring wheel,

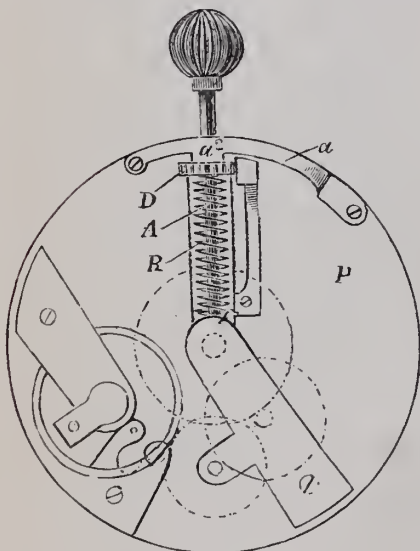

FIG. 1.

and which by the aid of the already known clock work could be brought into tension by being wrapped around the inner arbor. The pressure upon the spring wheel exerted by this tension then served as motive power for the clock.

The first mainsprings of the old wheel clocks look more like the present spiral springs in our doorlocks than like the watch mainsprings of the present days. For over four hundred years the shape has essentially remained the same, as well as the effect to be produced; its style of execution only proclaims an immense stride forward in this period. The absolutely uniform thickness of the blade, the wonderful elasticity of the

spring, resulting from the judicious choice of the material and painstaking care in the manufacture, together with an appropriate number of coils in the barrel regulated by a stopwork of so uniform an action that for some years the fusee has been considered superfluous in movements except marine chronometers, are some of the causes and effects.

Under the circumstances, there is really no need of experimenting with the mainspring, except as concerns its manner of production, because, truly speaking, it is doubtful whether it can ever be replaced by any substitute that discharges the functions as perfectly as the present incumbent does. But THE CIRCULAR does not make history, it simply records it, and for this reason it lays before its readers the details and illustrations of an invention for stemwinders made by two Swiss watchmakers, Messrs. Isaac Grasset, of Geneva, and Auguste Meylan, of Carouge. As it is, the shape is not at all new, although it was hitherto used for other purposes than actuating the train of a watch. The inventors use as mainspring not a spirally wound flat steel ribbon but a cylindrically rolled up wire spring, such as

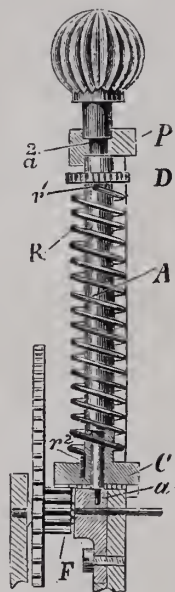

FIG. 2.

is used preferably in small music boxes, to let the stop lever snap in after finishing the piece of music. In the present instance, however, not the contractive force of the several coils exerts the power, but the tension of the spring is produced by torsion—that is, a regular winding of the coils around a staff within them.

Fig. 1 shows the movement with the new mainspring together with its clickwork, as seen from the back, while fig. 2 shows the rocking-bar with the spring on an enlarged scale. As will be seen, the barrel is entirely dispensed with. This may be regarded as an advantage of the novelty, since it makes the watch cheaper; because from the

appearance of things, this invention is principally intended for cheap watches.

The cylindrical steel wire spring R, figs. 1 and 2, is coiled around the staff A of the rocking-bar, and fastened in this staff with its end  $r^1$ , fig. 2, turned toward the rim of the movement. The other end  $r^2$  of the spring R is inserted in a small central wheel C, which sits loosely upon the staff A, and constantly stands in depth with the center pinion F.

The clickwork of the watch consists of a ratchet wheel D, which is fastened near to the other end of the staff A, and stands under the influence of a clickspring E, fig. 1, screwed upon the movement plate P. The rocking-bar has its pivot  $a^1$  in a small cock, and is held by a so-called "bridle" A, the shoulder  $a^2$ , of fig. 2, of which depths into a groove of the staff. The spring R is in the ordinary manner wound by rotating the rocking-bar to the right, and transports its tension to the small wheel C, which thereby actuates direct the center staff.

The wheel C revolves once every two hours; it would be necessary, therefore, that the rocking-bar makes 15 full turns, if the watch is to go 30 hours with one winding. But whether this great number of revolutions can be made without the pinching of the spring coils upon the bar A, is doubtful. It appears, therefore, that the novelty under debate is calculated for very cheap children's watches.

**The Mercurial Pendulum.**—"For the uses of the shop," says Tricotrin, "and for rapid compensation, I prefer the gridiron to the mercurial pendulum, because in the latter the jar of mercury does not so quickly respond to a change of temperature as in the former. It is well known that the temperature increases the higher we ascend in the room; the clockwork is fairly high up in the more heated strata, while the mercury in its jar moves in an essentially cooler temperature from three to four feet lower, and therefore does not fully respond to the heat of the shop. The rods of the gridiron, on the other hand, being larger and well conducting metal, pass through the different strata of the heated air, and in their compensation they will more readily respond to and express the total of heat in that compensation."

**CROUCH & FITZGERALD,**

Jewelry Trunks  
and Cases.

161 Broadway

Bet. Cortlandt and  
Liberty Sts.,

688 B'way,

701 6th Ave.,

NEW YORK



**JEWELERS, WAKE UP!**

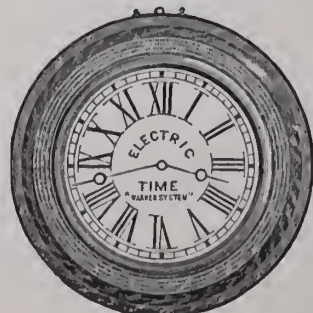

Don't you know there is going to be a **New Tower Clock** in your city, and some one is going to **Make some Money** on it?

Apply to us at once for figures and commissions on our **Electric Tower Clock**, which is the best. **No Winding or Regulating.** Fully warranted.

**THE STANDARD ELECTRIC TIME CO.,**  
789 Chapel St., New Haven, Conn.

## History of Jewelry in Hair-Dressing.

PART II.

**T**HE *Les Arts des Femmes* Exposition of 1892 in Paris disclosed a history of French fashion, since the fifteenth century unto our days, in scenes picturesque and expressive, with wax figures and feminine costumes executed by the great tailors of Paris. These figures and scenes were to address themselves to the syndicated chamber of furnishing and upholstery for the reproduction of interiors and trappings. The program had been thus edited: Under Charles VIII. or Louis XII., in a drawing-room, was seen the woman of a grand vassal of the crown, with her followers; a musical entertainment between two persons characterized the epoch of Francis I; then followed in order "a scene of castle life," under Henri II.; "a *parane* danced by two dames," under Henri III.; "a collation between ladies," under Henri IV. For the reign of Louis XIII., a corner of the celebrated gallery of the palais was reconstituted with its merchants and female buyers. For the period of Louis XIV., two scenes showed the woman in her intimacy at home, making tapestry by her needle, and the other showed her in her mundane high-life, visiting some grand dame. A "depart for the chace," in a magnificent autumn-tinted country, had been chosen for representing the Regency. As to the other periods of the eighteenth century, four subjects of a great variety were decided on: Louis XV., 1st period (1735), "a return from the ball;" Louis XV., 2d period (1765), "an aged lady at work;" Louis XVI. (1775),

"an actress dressing in her lodge;" and Louis XVI. (1789), "a lesson on the harpsichord."

As to the Revolution, "a public promenade" permitted the picturesque framing of the costumes so original of the women of the time. For the first Empire, a scene of a strongly ingenious disposition, presented "some dames acclaiming the return of the victorious troops." For the Restoration, it was "a toilette of the newly wedded wife;" and finally, "a departure for the races" was a résumé of the feminine fashion under

the hairdressers was indispensable; their works would have thus formed or furnished an important adjunct of interest to feminine costumes.

Success justified the devotion and the energetic tenacity needed by the committee to execute, in spite of all difficulties and obstacles the program of the *Union Centrale des Arts Décoratifs*. The history of feminine hairdressing was one of the most seductive attractions of the exposition of the arts of women. It even from the first day conquered Parisian popularity. It should be stated that the styles of head-dresses in this exhibition were commenced by and ended with an empress. Thus the first was a reproduction of the empress Aélia, wife of Claude (50 years before the Christian era); and the last of the ex-empress Eugénie.

Among the most notable head-dresses were a coiffure of Roman antiquity, simple and pleasing; the Greco-Roman head-dress, with a good deal of metal about it; the peculiar coiffure of the Middle ages, resembling some ancient bark placed on top of the head, from which floated delicate textility. Another curio of the same period looked like a capsized bonnet, fronted with ostrich feathers. The Henry II. style was elaborate and graceful. Louis XVI. epoch took us to one of the unique styles ever dreamt of—a full-rigged frigate, with miniature cannon peeping through the portholes, being placed among the wavy light hair. It was quite



HISTORIC MODES OF DECORATING THE HAIR WITH JEWELRY.

the last Bonaparte or Napoleon III.

The history of hairdressing, executed by the corporation of Parisian coiffeurs was to accompany the history of French fashion; moreover in the project of this last, which has just been analyzed, the collaboration of

imposing. The vessel is delicately made, and "light as a feather." Another Louis XVI. looked rather warm for hot weather; so did that of the Revolutionary period. The "coiffure merveilleuse" was ugly, though striking; a "Minerva" was much better.

ESTABLISHED 1837.  
**TAYLOR & BROTHER,**  
 OLD HOUSE READ, TAYLOR & CO.  
 IMPORTERS OF  
 \* **DIAMONDS** \*  
 AND OTHER PRECIOUS STONES.  
 MANUFACTURERS OF  
**DIAMOND JEWELRY.**  
**860 BROADWAY,**  
 Cor. 17th Street, **NEW YORK.**

**"Old English"**  
 Coffee Spoon.

\*\*\*



DESIGN PATENTED.

**Towle Mfg. Co.,**  
 MANUFACTURERS OF  
**STERLING SILVERWARE.**  
 NEWBURYPORT: No. 214 Merrimack St. CHICAGO: Nos. 149 & 151 State St.

# FERDINAND BING & Co.,

106 GRAND ST., N. Y.

## SPECIALTIES IN IMPORTED CLOCKS,

## MARBLE STATUARY AND BRIC-A-BRAC

FOR THE JEWELRY TRADE.

ENAMELED AND TRANSPARENT SPOONS FROM ALL PARTS OF THE WORLD

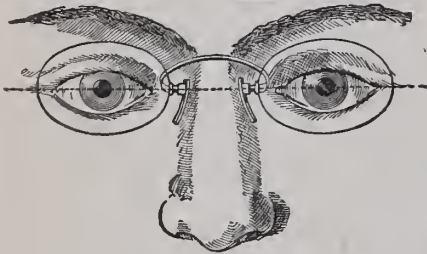

Patented Feb. 9, 1892.

### THE W. B. & E.

Marvel Tilting Spring Eyeglass in Gold, Steel, and Frameless.

### JULES LAURENCOT & CO.,

49 MAIDEN LANE, NEW YORK.

Sole Agents in the United States and Canada.

## HENRY GOLL & CO.,

17 JOHN ST., NEW YORK.



SPECIAL CASES MADE TO ORDER AND REPAIRING IN ALL ITS BRANCHES.

OURS IS THE  
**CH. FIELD HAVILAND**  
LIMOGES CHINA.

WHITE WARE.  
CFH  
GDM  
FRANCE  
TRADE MARK.

FABRIQUE FONDEE EN 1797.

**E. GERARD, DUFRAISSEIX & CIE.,**

SUCCESEURS:

DEPOSE



TRADE MARK

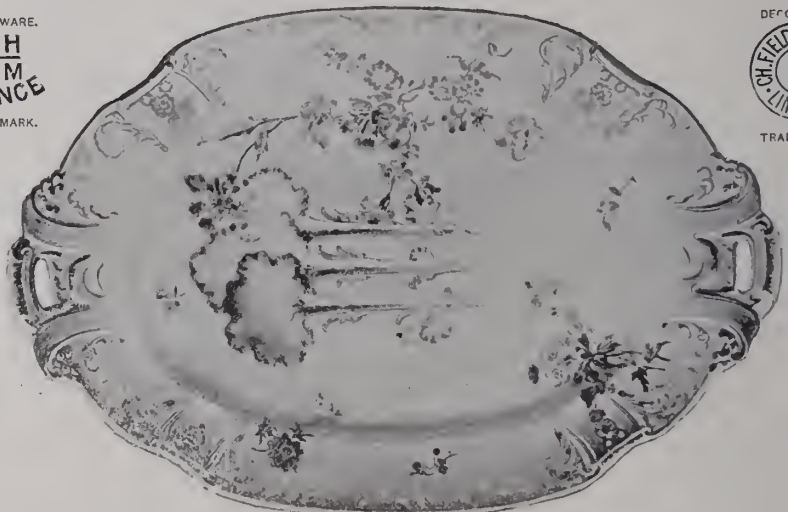

MEAT DIST.

Something absolutely  
**NEW in CERAMICS,**  
**FURNACE FIRE COLORS.**

This illustrates the superb banquet service to be seen in our pavilion at the World's Fair—Ceramic Court, French Section in Manufactures building. The service comprises 210 pieces, decorated throughout in Furnace Fire Colors. Value, \$3,000.

## HAVILAND & ABBOT,

AGENTS FOR THE UNITED STATES,

29 Barclay Street,

NEW YORK.

## No File Equals the "GLARDON" File

is the universal verdict  
of the trade.



LARGEST ASSORTMENT IN  
THE UNITED STATES.

### F. W. GESSWEIN, 39 John Street, New York.

SOLE AGENT FOR UNITED STATES AND CANADA.

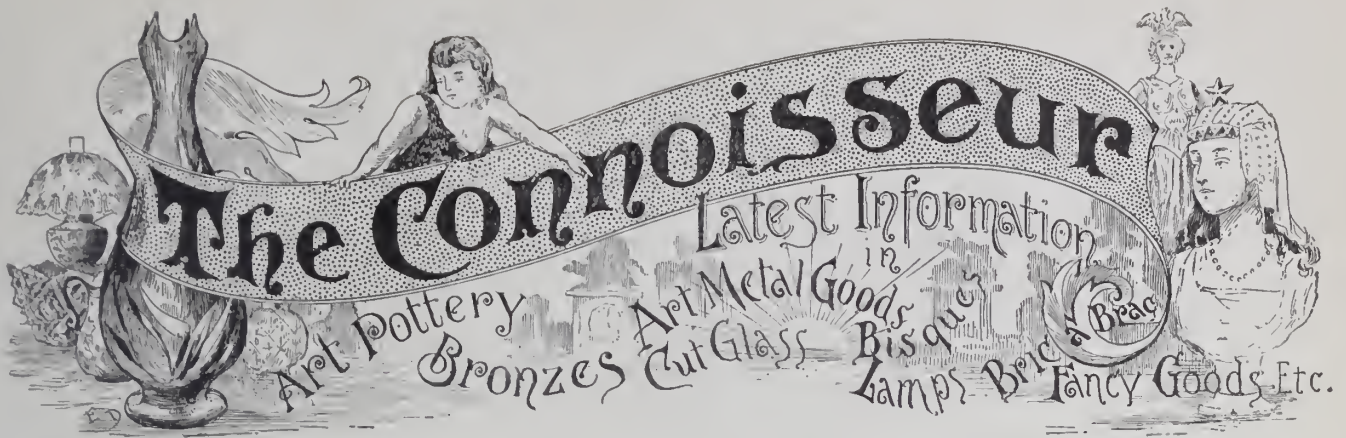

### A Dore Masterpiece.

THE bronzes of France are considered as being among the finest art works exhibited at the World's Columbian Exposition, and the greatest of them is the Dore vase. Single figures are shown that are better examples of skill in modeling, while in some of the groups, notably that of the Defenders of the Flag, the figures are more perfect in minute detail when examined with microscopic precision; but the Dore vase is a truly great art work, a mighty composition, in which detail is subordinated to general effect and the minutiae of form sacrificed where necessary that the eye may grasp figures as related to one another, rather than as solitary instances of patient craftsmanship. The treatment is broad in comparison with that of other good artists of France, who have polished the very creases of a smile in some of their marvelously life-like statuettes.

The vase is 13 feet high, 7 feet in diameter, and weighs nearly 5,600 pounds, while its value in France is 100,000 francs or \$20,000. If sold to remain in this country this will be increased by the amount of the duty. The vase is to be seen in the French section in the Manufactures building, and is under the care of T. D. Deloude. The firm who exhibit it are Thiébaud Frères, Paris, France. It has been given a fine position, the location being just south of the display of Gobelin tapestries and Sèvres wares, in the central court of the exhibit.

The vase has been named "The Poem of the Vine," its decorations being symbolical of its title. On a broad base rests the body of the vase which is globular, receding with a gentle curve to the narrow neck. Hundreds of figures showing joyous beings surround the base, body and lip of the vase, while the vine twines in and out, its persistency being marked while not obtrusive. The illustration shows what is generally

considered the front view. On either side the vine is wreathed to form a chaplet. At the left Bacchus with each arm around a Cupid, holds aloft a cup. To the right Venus

from the vine leaves, and frolic in the depths of the vase. A lizard causes consternation among some frolicsome youngsters. Others are playing with beetles, flies, bees and butterflies. A snake has attractions for some of the infants, while others content themselves with watching the efforts of their companions. With all this wealth of detail the work is not overcrowded. At a distance the effect is of simplicity. It is only when close inspection is made that the wonderful imaginative powers of the artist are made apparent.

As with all others of his greater creations, Dore's style is indelibly stamped on this work. No other artist of his time could have achieved it.

Dore himself would not have been equal to the task had it not been a labor of love. It is related that this, one of the last great works of the master, was the subject of his almost constant care for many months. Besides the toil and anxiety, it is estimated that the vase cost Dore what is equivalent to \$12,000. The vase was modeled in time for display at the Paris Exposition of 1878. Shortly after the close of the Exposition the casting in bronze was made. In 1883 the artist died.

Gustave Dore was born in Strasburg in 1833. At an early age his predilection to art was made manifest. His first lithographs were published when he was only eleven years old. In the following year of his age he went to Paris with his father, where his studies were continued. In 1848 he published his first series of sketches. When he was twenty years old he commenced the exhibition of oil paintings, while in 1854 he illustrated the works of Rabelais. The decoration of the Cross of the Legion of Honor was awarded him in 1861. Until the close of his life he worked indefatigably. The total number of his drawings

and sketchings is variously estimated at from 45,000 to 50,000. Of the many works illustrated by Dore the most important are, in chronological order: Montaigne, Taine's

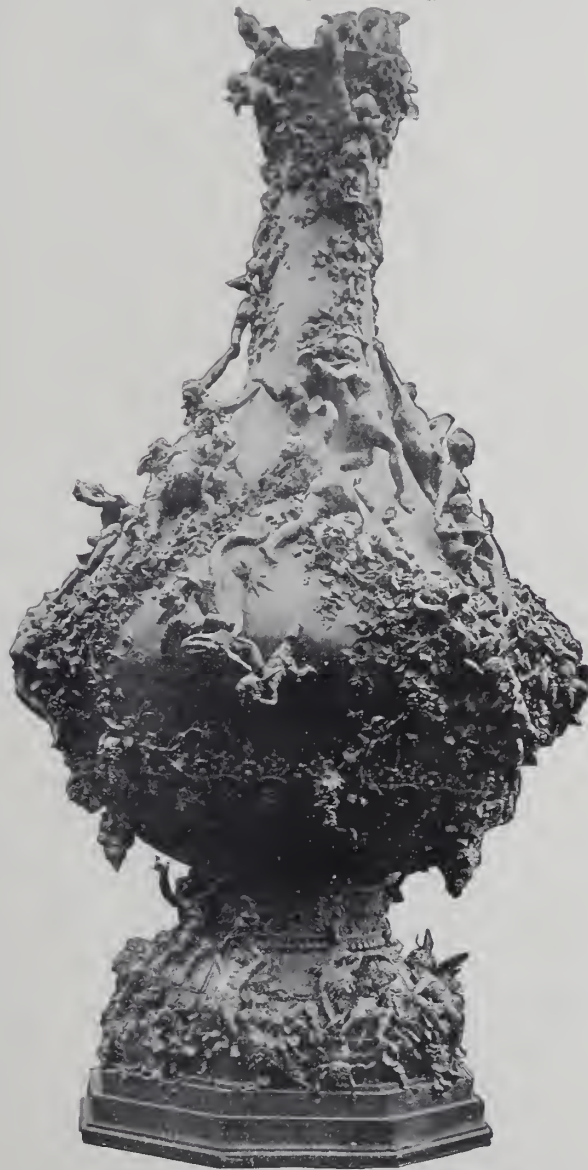

THE GREAT DORE VASE "THE POEM OF THE VINE."

is teaching a Cupid the use of the bow and arrow. Elsewhere are to be seen satyrs and bacchantes.

Cupids are everywhere. Baby faces peer

**The Connoisseur.**

(Continued from page 45.)

*Voyage aux Pyrénées*, Chateaubriand's *Atala*, Tennyson's *Idyls of the King*, the fables of La Fontaine, Dante's *Divina Commedia*, and *Don Quixote*.

Dore's work is known wherever books have penetrated. The dash of his vigorous style, his imaginative powers displayed in picturing scenes that men of less courage fear to think about, and his facility in many departments of art, all entered into the composition of a remarkable mind.

**Artistic Pottery.**

THE sale of pottery in France known as the Spitzer collection, was called by enthusiasts the sale of the century, says the *Pottery Gazette* (London); it included furniture, faience, portraits, brass work, bronzes, and we know not what; but we are only interested in pottery.

A square plaque by Bernard Palissy "L'Eau" fetched 1,080*l.* Poor Palissy! probably more than he ever earned in his laborious life by potting. It represents a girl seated, crowned with aquatic plants, and carrying in her right hand an urn from which escape waves of water, in which disport themselves all kinds of fish—Palissy's favorite subject. The drawing and coloring are fine; the figure is nude, and is backed up by rushes, and it strongly reminds us of the early Staffordshire examples of a little later period.

A ewer in Fayence de Saint-Porchaire fetched 1,280*l.*; it is certainly a fine specimen of the time of Henry Deux. The principal work sold was the "Grand Tableau," by Leonard Limosin, a reproduction of fifteen plaques of enamel of carving executed by Mark Antonie Ramondi, after Raphael. This work was bought for 2,700*l.*

**The Rambler's Notes.**

WHAT THE RAMBLER SAW AND HEARD AMONG THE DEALERS IN ART POTTERY, CUT GLASS, BRONZES, ETC.



A MAGNIFICENT assortment of Carrara and Castellina marble figures has just been opened by Ferdinand Bing & Co., 106 Grand St., New York. The variety is very extensive, and the new and novel subjects are exceedingly numerous. Among the principal subjects in the Carrara marble are: The Prayer, The Secret of Love, a large piece representing the bust of a beautiful girl, into whose ear Cupid is whispering, Cleopatra, The Oriental Dancing Girl, and four beautiful busts typifying The Seasons, Spring, Summer, Autumn and Winter. Representative of the largest and most beautiful groups are: The Cup of Love, Amour and Psyche, Nymph and Cupid, and Faust and Marguerite. The Castellina figures, though smaller and cheaper than the former, are beautiful, and are shown in as great variety. Among the subjects just opened in this line are: Lecture, Violetta, Bianca, The Story, and busts of Cleopatra and The Seasons, somewhat similar to those of Carrara marble. Another line displayed by Ferdinand Bing & Co., which should also be noted is the assortment of handsome green marble pedestals, in sizes to suit any figure or ornament from the largest to the smallest.

The changes in the New York stores of Chas. Ahrenfeldt & Son, 50, 52 and 54 Murray St., which have just been completed

have added greatly to the convenience of the firm and their customers. In removing the offices to the rear of Nos. 52 and 54, not alone have more light given and greater room their clerical department been obtained, but also the firm have been able to add private offices for the accommodation of their patrons. The new Otis electric elevator affords an opportunity of using the upper floors of the buildings to greater advantage and permits buyers to see the entire stock without the fatigue of stair-climbing. These changes will surely prove beneficial to the business interests of this house.

Alfred Hache, of Hache, Jullien & Co., Vierzon, France, the well known makers of fine china, has bought out the interest of his partner, Mr. Jullien, and the firm will hereafter be known as Alfred Hache & Co. Craighead & Wilcox, the New York agents of this firm have received at their salesrooms, 33 Barclay St., extensive invoices of the latest fancy pieces of Hache china in many varieties which they will soon show.

The Chas. Jacques Clock Co., 22 Cortlandt St., New York, are now showing the various lines of beautiful clocks which they have just imported for the Fall trade. Their new line of mounted faience clocks which contains a great variety of odd and beautiful shapes, is one of the largest and most attractive that can be found in America.

One of the many specialties soon to be introduced by Geo. Borgfeldt & Co., 18, 20 and 22 Washington Place, cor. Greene St., New York, will be a line of beautiful Russian bronzes, in subjects distinctly Russian.

THE RAMBLER.

A RETICENT TIMEPIECE.

JEWELER—Does that watch I sold you keep time?

CUSTOMER—Better than a time-lock safe. It hasn't given me a bit of the article since I've had it.—*Truth.*

ART NOVELTIES AND BRIG-A-BRAG,  
EXQUISITE  
CLOCKS  
and  
Clock Frames.

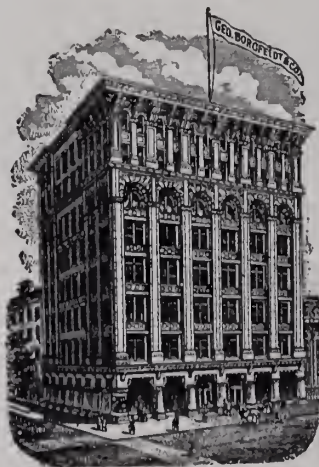

SPECIALTIES  
FOR THE JEWELRY TRADE,  
and  
OPERA GLASSES  
and  
Chamois Skins.

**GEO. BORGFELDT & CO.,**

18-20-22 WASHINGTON PLACE, COR. GREENE ST., NEW YORK.

# LEON J. GLAENZER & Co.,

80 & 82 CHAMBERS ST., N. Y.

PARIS HOUSE,

35 BOULEVARD DE STRASBOURG



## RICH NOVELTIES

EXCLUSIVELY FOR THE JEWELRY TRADE.

Original and Exclusive Designs in

### CLOCKS,

Onyx, Porcelain, Gilt and Enameled Clock Sets, Gilt Regulators, Traveling Clocks and English Hall Clocks.

GILT AND FILIGREE SILVER-PLATED NOVELTIES AND PHOTOGRAPH FRAMES.



WM. BIRMINGHAM & CO.,

MANUFACTURERS OF

All Kinds of Leather Spectacle and Eye Glass

### CASES,

728 Arch Street, PHILADELPHIA, PA

ALUMINUM SOLDER \$2.00 PER POUND.

Instructions for using given gratis.

Practical Processes for Soldering, Dipping, Enameling, Etching, &c., of Aluminum

C. DE REDON, 43 WEST 21st ST., NEW YORK.

ESTABLISHED 1837.

GEO. O. STREET & SONS,

MAKERS OF

Fine Rings, Lockets, Seals,

Sleeve Buttons and Links,

15 John Street, NEW YORK.

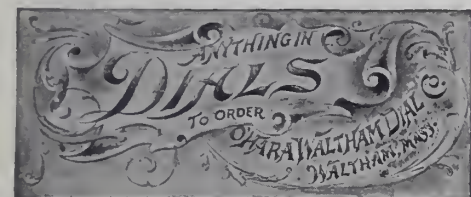

All the illustrations in this issue were made by

W. H. BARTHOLOMEW.

PHOTO-ENGRAVER,

18 SPRUCE ST., NEW YORK.



ESTABLISHED 1801.

## HINRICHS & CO.,

29 & 31 PARK PLACE,

Cor. Church Street,

NEW YORK.

Art Pottery and Bric-a-Brac,

CUT GLASS, FANCY GLASS, CHINA, LAMPS.

THE LARGEST ASSORTMENT OF SPECIALTIES FOR THE JEWELRY TRADE, AT LOWEST PRICES.

S. C. JACKSON, 180 BROADWAY, NEW YORK.

MANUFACTURER OF

Fine \* Cases \* for \* Jewelry, \* Silverware, \* Etc.

ALSO SHOW CASE TRAYS AND FANCY HARD WOOD WORK.

Samples sent on application. Estimates furnished.

ESTABLISHED 1870.

### J. L. CLARK,

SWEET SMELTER AND REFINER OF GOLD AND SILVER.

Buys every kind of Gold and Silverware, Jewelry, Watches and Platinum. Full market value paid.

No. 724 Filbert Street, Philadelphia, Pa.

SEND BY EXPRESS or Registered Mail. If my price is not satisfactory, I will return all articles.



## The Warren Eye Protector

(Patented Jan. 12, 1892, Feb. 21, 1893.)

Saves the Eyes From

Dust, Wind, or Glaring Light.

Folds in a Compact Case, is

Comfortable, Durable, Water and Dust Proof.

Its large field does not obstruct the sight. No brittle substance to endanger face under sudden blows.

Oculists and Physicians Recommend it.

Travelers, Cyclists, Railroadmen, Horsemen, Motormen, Quarrymen, Pronounce it Indispensable for Man or Woman.

Ask your Dealer for it.

Colors, Clear, Smoke, Blue or Green. Black frames, 50c. Silver, 75c. Sent by mail on receipt of price. Manufactured solely by

The Nons Verrons Company

P. O. Box 3273, Boston, Mass.

WOLFF & GUNZBURGER, Importers of DIAMONDS, 87 NASSAU ST., (Fulton Building), NEW YORK.

FALKENAU, OPPENHEIMER & Co.  **DIAMONDS**  
40 MAIDEN LANE NEW YORK

**B** AND **W. B. SMITH,**

220 WEST TWENTY-NINTH ST., NEW YORK CITY,

— AT THE —

**WORLD'S FAIR**

CHICAGO,

OUR EXHIBIT IS IN THE

MANUFACTURES AND LIBERAL ARTS BUILDING

SECTION Q, BLOCK ONE.

**WHY**

S. F. MYERS & CO. sell more goods than any other Wholesale Jewelry House.

**BECAUSE**

They are the only firm in the Metropolis who carry in stock a full line of everything a jeweler requires. They give the utmost values and endeavor to please their trade in every respect. Refer to their various publications and illustrated catalogues.

MYERS BUILDINGS, 48 & 50 Maiden Lane, NEW YORK.

ESTABLISHED 1848.  
**DIAMONDS**  
**BRUHL BROS. & CO.**  
21 Maiden Lane, N. Y., 57 Rue de Chateaudun, Paris.  
**PEARLS**  
and other Precious Stones.

S. P. HOWARD,  
Gold and Silver Assayer.  
Refiner and Sweep Smelter,  
33 MAIDEN LANE, NEW YORK.  
Smelting and Refining Works,  
28 & 30 Cumberland Street, Brooklyn, N. Y.  
Specialties: Sweepings, Gold, Silver and Platinum



**Chas. Jacques Clock Co.,**

22 CORTLANDT STREET, - NEW YORK.

Importers and Manufacturers

SWISS REGULATORS, ELLIOTT'S CHIMING CLOCKS, FRENCH AND ENGLISH MOVEMENTS, HALL CLOCKS, TRAVELING CLOCKS, GILT REGULATORS, FAIENCE & GILT CLOCKS & SETS, ETC.

Complete line of English and French Clock Materials.

Pinions and Wheels Cut on Premises.



**M. H. KLING, \* IMPORTER OF \***  
**DIAMONDS,**

11 JOHN STREET. - - NEW YORK.

IT PAYS TO KEEP IN TOUCH WITH TRADE AFFAIRS. THE JEWELERS CIRCULAR, For 4c. a Week will do it. **Subscribe.**



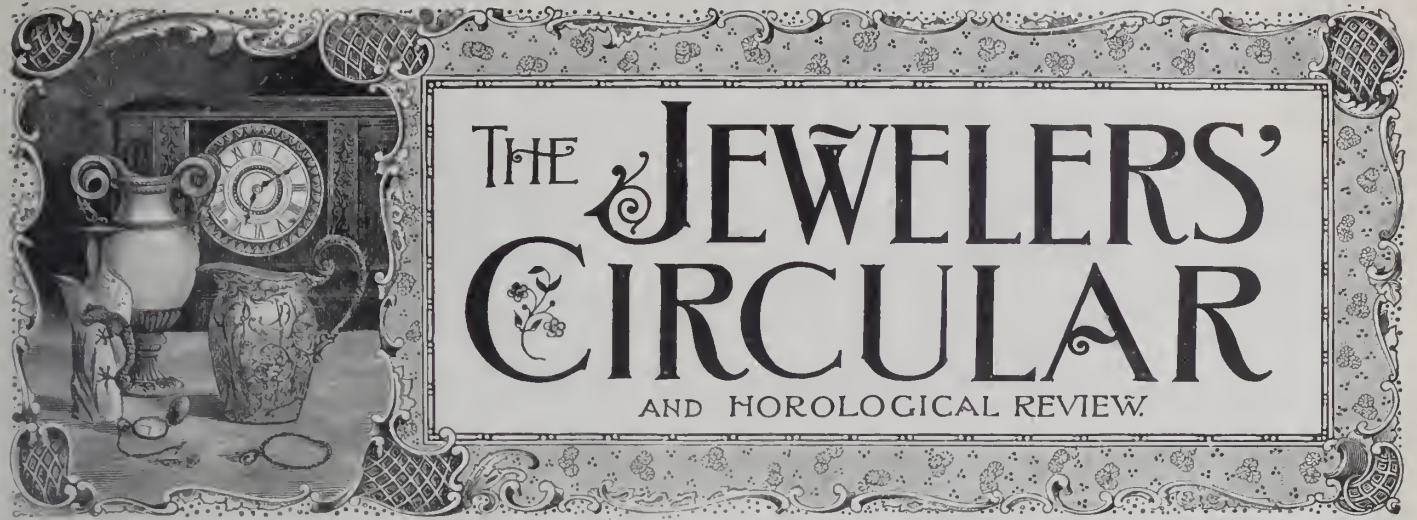

# THE JEWELERS' CIRCULAR

AND HOROLOGICAL REVIEW.

Copyright, by THE JEWELERS' CIRCULAR PUB. CO.

189 Broadway, New York.

Entered at the Post Office in N. Y. as second-class matter.

VOL. XXVII.

NEW YORK, WEDNESDAY, AUGUST 23, 1893.

NO. 4.

## ART IN OUTLINE AND MODELING IN FRENCH SILVER WORK

THE tea service for the Grand Steeplechase of Paris, 1893, made by the house of Boin-Caburet, Paris, one of the French exhibitors at the World's Columbian Exposition, is worthy the earnest study of silverware manufacturers generally and especially of designers in the precious metals. The tea set is in the Regence style. As it has been made to order, Boin could not take it upon himself to introduce striking originality in the design. But what he could do and what he has done has been to devise most elegant outlines, and to have every piece neatly modeled. He studied all proportions to a nicety so that his Regence tea set might be considered as a perfect type of the *genre*. The illustration is so clear that it is easy to appreciate how far the French silversmith has been success-

small articles in gold as bracelets, brooches, bon-bon boxes, etc.

Never who is exhibiting at the World's Fair, deserves special mention among French jewelers. His display is extremely varied

true masterpieces. Among the most curious features of the display are two card markers in rock crystal with chased gold mountings. The marks in gold are adorned with Pompadour *motifs* finely chased. The rock crystal plates, delicately engraved, exhibit pretty Watteau scenes; a swinging scene is full of life, and a minuet scene is very graceful. They are engraved at the back of the plate in a way calculated to produce the effect of relief, and are applied on the top side. The figures, the trees and all the details of the scenes have a snowy appearance which prettily contrasts with the polished ground of the plate. There is something dreamy about the effect.

To be in the fashion every thing possible must be covered with white canvas. White



A PURE REGENCE STYLE. TEA SERVICE MADE FOR THE GRAND STEEPLCHASE DE PARIS, 1893.

ful. The curves and mouldings which form the special features of the various pieces are at once boldly and gracefully drawn. All the chased details, such as fish scales, masks, ripples, leaves, etc., are as *fouilles* as they are, generally speaking, only on very

and all articles in it are worthy of notice. The sprays of flowers in diamond and colored stones are beautifully designed and the settings are as light as possible. Several of his works exhibit mediæval scenes in translucent enamel in relief, which are

canvas belts have buckles of silver; portfolios and writing pads are covered with canvas and mounted in silver. Card cases and pocketbooks are of the same material with silver corners. Silver ornamentation takes the form of cables and ropes in knots.

MARJORIE.

INITIAL.



ILLUSTRATING THE FOUR DESIGNS OF  
 EBONY AND SILVER

COMBINATIONS

— IN —

TOILET SETS.

DEITSCH BROS.,

— ORIGINATORS OF NOVELTIES —

— IN —

— Leather and Silver Combinations. —

7 EAST 17TH STREET NEW YORK CITY.

CASTLE.

EMPIRE.



These designs are made in the following articles

- Round and Oval Mirrors,
- Bonnet and Velvet Brushes,
- Combs,
- Manicure Requisites,
- Stationary Racks,
- Writing Necessities,
- Photo Frames,
- Stamp Boxes,
- Paper Knives,
- Pen Trays,
- Pin Trays,
- Hair Pin Boxes,
- Shoe Buttoners,
- Glove Powder Bottles,
- Mustache Brushes,
- Jewel Caskets,
- Letter Clips,
- Jewel Trays,
- Shoe Horns,
- Infant Brushes,
- Smoking Sets,
- Coasters, Whisks.

DEITSCH  
BROS.,

MAKERS,

7 East 17th Street,  
NEW YORK.

“DO YOU KNOW?”

THAT GOODS FREE FROM SOLDER ARE THE BEST?

THAT GOODS MADE FROM SEAMLESS WIRE ARE SUPERIOR IN FINISH ON THIS ACCOUNT?

THAT SEAMLESS WIRE MAKES THE BEST FILLED CHAINS?

THAT WE ARE THE MAKERS OF THE ORIGINAL AND CELEBRATED

SEAMLESS GOLD FILLED CHAINS?



Do not fail to visit our beautiful and artistic display at the World's Fair. The finest of its kind at the Exposition.



Northeast Corner of Manufactures Building, Department O.  
Right on the corner. See Official Catalogue.



**Kent & Stanley Co.,**

BRANCH OFFICES:

NEW YORK : 17 MAIDEN LANE.      SAN FRANCISCO : PHELAN BUILDING.  
BOSTON, 58 WINTER STREET,      MONTREAL, TEMPLE BUILDING.

MAIN OFFICE AND WORKS:

**PROVIDENCE, R. I.**

**AIKIN, LAMBERT & CO.**

19 Maiden Lane, NEW YORK.

Branch, 42 & 44 East Madison St, CHICAGO, ILL.

Manufacturers and Exporters of

Gold Pens, Holders, Picks, Pencils,

Fountain Pens, etc.



11 x 5 1/2 inches.

PLUSH TRAY WITH EASEL BACK.

1 Doz. 16 K. Pens and Assorted Holders, List, \$30

1 Doz. 10 K. Pens and Assorted Holders, List, \$24

Send for Trade Discount.

**OPTICIANS' SUPPLIES**  
 Jobbing and Prescription Work.  
 The "Graduate" Trial Cases, 180 lenses, \$30.00; 270 lenses set, \$37.50. The "Standard" Trial Case, 220 lenses set, \$65.00. All with lenses. Loring Ophthalmoscope, \$9.00. Artificial Eyes, for selection, \$1.00 each, \$50.00 for hundred. Ophthalmometers, \$50.00 to \$70.00. Queen's Standard Perimeter, \$18.50. Queen's Lens Grinding Outfit, \$3.00. Steel Frames, 15 to 30 cents each. Spherical Lenses, 25 cents per pair. Cylinders, 30 cents per pair. Lenticular Bifocals, 8 cents per pair. All best quality. Nose pieces for Shell's German Silver, \$1.00 per dozen pairs. Gold, \$2.00 per dozen pairs.

**QUEEN & CO.** Opticians.  
 Catalogue free. 7010 Chestnut St., Phila., Pa.



AMERICAN RAILWAY SUPPLY CO.  
24 Park Place, NEW YORK.

For **BADGES AND MEDALS.**

Flag Pins, Class Pins, Class Rings  
and Special Work of all Descriptions

SEND TO **E. R. STOCKWELL**, MANUFACTURER,  
19 John Street, New York

# THE FAIRPOINT MFG. COMPANY,

NEW BEDFORD, MASS.

FLATWARE.

HOLLOW WARE.

- BERRY FORKS.
- BERRY SPOONS.
- ICE CREAM KNIVES.
- ICE CREAM SPOONS.
- SALAD SETS.
- OYSTER FORKS.
- OLIVE SPEARS.
- PUNCH LADLES.



2410.—OVAL TUREEN.

- BERRY SETS.
- BERRY DISHES.
- ICE PITCHERS.
- ICE TUBS.
- SALAD BOWLS.
- OYSTER LADLES.
- WINE SETS.
- PUNCH BOWLS.

NEW YORK,  
60 MAIDEN LANE.

CHICAGO,  
224 WABASH AVE.

SAN FRANCISCO,  
220 SUTTER STREET.

We sell to the legitimate Jewelry and Stationery trade only.



SPECIALTY: SALES OF  
**JEWELRY, BRIC-À-BRAC**  
AND  
ARTICLES OF VERTU



CHOICE PAPERS

MAKERS OF

## FINE STATIONERY

For Correspondence, Wedding and Business Use, handsomely boxed, specially suited to the Jewelry Trade.

18 MURRAY STREET, NEW YORK.

**Trunor Plating and Jewelry Rep. Co.**

Jewelry Matched and Repaired, Engraving, Gilding and Enameling, Setting, Polishing and Repairing, Battery Gilding and Roman Coloring, Watch Cases Repaired, Polished and Gilded.

32 Maiden Lane, New York.

# WORLD'S FAIR SOUVENIRS.

\* STERLING SILVER. \*



THE COLUMBUS.



REVERSE SIDE OF HANDLE.



REVERSE SIDE OF HANDLE.



THE DISCOVERER.



REVERSE SIDE OF HANDLE.



THE AMERICAN.

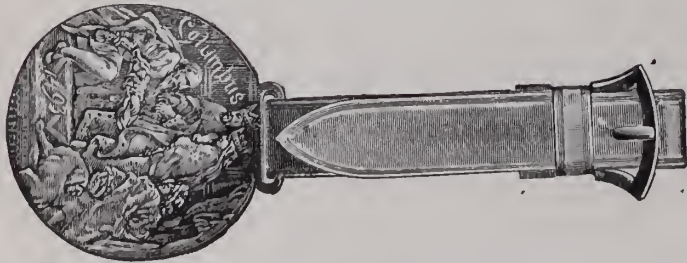

No. 2. BAGGAGE CHECK.

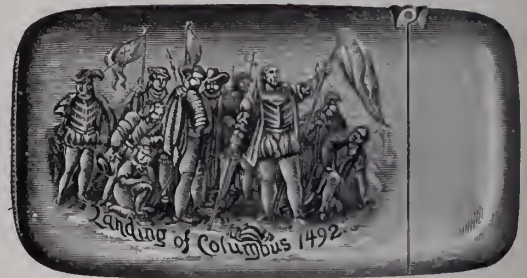

MATCH BOX.

## R. WALLACE & SONS MFG. CO.,

SILVERSMITHS,

WALLINGFORD, CONN.

NEW YORK:  
3 PARK PLACE.

CHICAGO:  
86 WABASH AVENUE.

**Creditors Claim that L. M. Wagner Still Owns his Old Store.**

LOS ANGELES, Cal., Aug. 14.—About six months or more ago, L. M. Wagner, conducting the Kimberley Jewelry Store, at 125 S. Spring St., failed. The failure was a heavy one, the indebtedness aggregating about \$30,000. A receiver was appointed who sold all the stock and fixtures of the store to one, Henry Susskind for upwards of \$7,000.

A singular feature was that Wagner, although making an absolute assignment, never left the store, and has not to this day. When Susskind took possession, Wagner continued to be in the store, sell goods and act to all appearances as an owner. Nor did Wagner's mode of living suggest that he had suffered any pecuniary loss by the failure.

The opinion, therefore, has grown up among some that Wagner and Susskind had an agreement between themselves whereby Susskind was to make the purchase in his own name for Wagner, the latter furnishing the money. This is the belief acted upon by M. Wunsch and Herman Brum, San Francisco, who have recently levied an attachment upon the stock now in the store for \$11,501.07, claiming it to be Wagner's. They declare they can prove that Wagner is the real owner of the store. Susskind, however, shows fight and has entered a suit against the sheriff who levied the attachment for \$20,000 damages. The sheriff, however, has a bond behind him from Messrs. Wunsch and Brum for \$40,000 and is prepared to stand a battle.

**The Affairs of Comptoir Lyon-Alemand**

PARIS, France, Aug. 5.—Mr. Marteau, who was a member of the board of the Comptoir Lyon-Alemand during the prosperous period from 1871 to 1883, and who retired when Mr. Lerigue was appointed manager, has just accepted the presidency of the board and manager of the *comptoir*. Messrs. Murat, Lerigue and Dougé retire.

Actual bill-holders are ill disposed toward the *comptoir*. A large amount of bills drawn by the company on manufacturers, have returned unpaid, and a great many more still circulating will have, undoubtedly, the same fate. Some drawers have come forward to make arrangements with bill holders, and it is hoped that they will be able to maintain their situation, but it may be feared that some, chiefly small manufacturers, will fail.

Mr. Lerigue was evidently an honest man, but he blindly allowed some manufacturers to have uncovered balances at the *comptoir* constantly increasing, which could not be justified by a proportionate increase in business. This fact should have caused him to be more prudent. In France, a goldsmith or a silversmith may want a great quantity of metal and must, therefore, have an important uncovered balance at his banker during the last three or four months of the year. But in the first quarter of the follow-

**BIPPART & CO.**  
 MANUFACTURERS OF  
**DIAMOND JEWELRY**  
 NEWARK N.J.

BROOCHES,  
 SCARF PINS,  
 HAT PINS,  
 HAIR PINS,  
 EARRINGS,

LINK BUTTONS,  
 CUFF PINS,  
 BRACELETS,  
 NECKLACES,  
 RINGS.

NEW YORK OFFICE 19 MAIDEN LANE

**THE BOWDEN SEAMLESS RING**

IS MADE ONLY BY

**J. B. BOWDEN & Co.,**

Makers of Finger Rings of every Description.

**COR. BROADWAY & JOHN STREET,  
 NEW YORK.**

**J. B. & S. M. KNOWLES CO.,**

MAKERS OF

**Sterling**



**Silverware.**

FACTORY,  
 Providence, R. I.

SALESROOM,  
 860 Broadway, N. Y.

**O. W. BULLOCK & CO.,**  
 SPRINGFIELD, MASS.

Makers of Watch and Jewelry Tools,  
 NEW CATALOGUE NOW READY.

Sent on Application. Please Mention this Paper.

**JACOT & SON**  
 IMPORTERS AND MANUFACTURERS OF  
**MUSICAL BOXES**  
 298 BROADWAY.  
 NEW YORK



# ARTISTIC METAL GOODS.

NEW DESIGNS,  
NEW FINISHES.

Our line of Pitchers, Vases, Tables, Candlesticks, Five O'Clock Teas, Etc., cannot be equaled.

## THE CELEBRATED "B & H" LAMP.



BEAUTIFUL DESIGNS,

particularly adapted to the Jewelry Trade.

SEE OUR LINE OF

TABLE, BANQUET AND PIANO LAMPS

before placing your orders.

Send for our Little Book.

**BRADLEY & HUBBARD MFG. CO.**

NEW YORK, BOSTON, CHICAGO,  
21 BARCLAY ST., 160 CONGRESS ST. 88 WABASH AVE.  
26 PARK PLACE Factories, MERIDEN, CT.

## "THE BEST BUTTON MADE."

IN GOLD

FROM

**KREMENTZ & CO.**

And all Jobbers.

THE KREMENTZ



ONE PIECE

IN ROLLED PLATE

FROM

ALL JOBBERS.

**COLLAR BUTTON.**

IS THE ORIGINAL ONE PIECE BUTTON.

IS STILL THE BEST AND STILL UNSURPASSED.

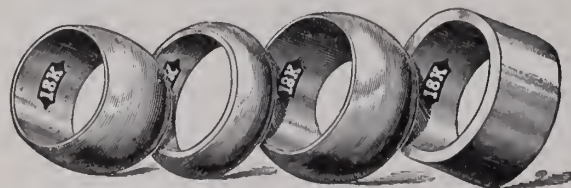

**PLAIN SOLID GOLD RINGS.**

**HILDRETH MFG. CO.,**

53 MAIDEN LANE,

NEW YORK.

ing year, he ought to gradually diminish his debt through remitting to his banker bills on his customers, or money received from them. Business done during the Spring and especially in the Summer is not, as a rule, very important; therefore the jeweler or silversmith who is a debtor to a large amount at his banker, at any time between May and September, must either have accumulated too large a stock or lost a great deal of money in business or otherwise. Now a banker can easily inquire into matters and see how they stand, especially when he is a metal dealer. He ought then to see, at once, from his books, whether the manufacturer is his debtor through having purchased from him a quantity of metal corresponding with the importance of his debt, or whether he is debtor chiefly because he has drawn checks to an amount which cannot in any way correspond to his average manufacturing expenses.

Mr. Lerigue has allowed important uncovered balances to increase at times when they ought to have decreased. The board should have been aware of this fact and insisted upon the accounts being closed before they ran too high. There is every reason to believe that the situation at the *comptoir* will allow the company to pay off all creditors, perhaps with the entire amount of money paid by shareholders, and to settle all bills which may return unpaid; yet billholders want to be on the safe side. They think that the ex-manager of the *comptoir*, Mr. Lerigue, and all members of the board, ought to be held severally and jointly responsible toward creditors of the company.

### The Boy's Screams Frightened Away the Sandbaggers.

NEW HAVEN, Conn., Aug. 16.—A bold attempt at a daylight robbery was made late Monday afternoon at the jewelry store of Edmund Zernitz, 916 State St. Eddie, the twelve year old son of Mr. Zernitz, was alone in the store at the time and busy dusting the cases. Two men whom he describes as fairly well dressed, the older about thirty-five years of age, tall and slim, the younger about twenty-two, short and stout, entered the store and asked if watches were repaired there. They were answered in the affirmative.

The men, however, did not produce any watches, but plied the boy with questions. Finally they asked to be shown the machinery of a large clock in the rear of the store. The boy turned to the clock and was in the act of opening it when one of the men struck him on the head with a sandbag. The boy, though stunned, screamed so violently that the men became alarmed and started for the door. In his hurry to get out of the store one of the men dropped his sandbag and a handkerchief, which the police now have. Three police detectives are now at work on the case. The boy's wounds though severe are not dangerous.

John W. Langley, Sylacauga, Ala., has sold out.



**The Sudden Demise of Walter E. White.**

PROVIDENCE, R. I., Aug. 18.—Local jewelry circles were shocked to learn this morning of the sudden and unexpected death at his home, 1577 Westminster St., of Walter E. White, of Walter E. White & Co., manufacturers of diamond and solid gold jewelry at 86 Page St. The deceased went to his father's home in Attleboro last Friday and while there ate liberally of growing fruit, chiefly pears. Returning home that evening, he was seized with an attack of diarrhoea, but was not thought to be seriously ill although it necessitated his absence from his office the following and next days. Inflammation of the bowels had meanwhile developed and his illness became such that a nurse was required to attend him.

Last night he appeared to be more comfortable and the family retired about midnight. Just before one o'clock the nurse discovered a change in the patient and spoke to him but received no answer, the latter having lapsed into unconsciousness. Mrs. White was called but before she could reach her husband's bedside he had quietly passed away. Deceased had been in delicate health for some time past, having experienced a paralytic stroke about a year ago, and barely pulling through an attack of typhoid pneumonia the past Winter.

Mr. White was one of the best known and most successful manufacturing jewelers in New England. He was born in Attleboro, Mass., forty-five years ago and received his education in the public schools of his native town. Finishing his schooling he apprenticed himself to a firm of Attleboro jewelers and for several years worked at that business. He came to this city about twenty years ago and on Jan. 1, 1873, commenced manufacturing jewelry in this city having as partners Theodore W. Foster and Samuel H. Bailey, now of Foster & Bailey, the firm name being White, Foster & Co. Mr. White retired from the concern in the Fall of 1877, but on April 1, 1878, he re-engaged in business as Walter E. White & Co. At the time of his death he was owner of the large brick block occupied by manufacturing jewelers at the corner of Page and Clifford Sts. He was a member of the West Side Club, Pomnam Club, New England Manufacturing

Jewelers' Association, the Manufacturing Jewelers' Board of Trade and other associations. He leaves a widow, a son and a daughter.

**Treasure Trove of Rings and Watches in the Mud.**

NEW ORLEANS, La., Aug. 17. — Joseph Dozier, a negro, stubbed his toe in the river mud at Old Planters' plantation, six miles below this city, to-day. There was brought to light a bright, shining object, a gold ring. Digging in the mud, he discovered eleven other gold and diamond rings, some gold watches, chains, locketts, earrings, and other articles of jewelry. Over sixty gold, diamond, amethyst, and other rings were found, a dozen locketts, and as many earrings. About one hundred pieces of jewelry were found in all.

Dozier informed the police, and several detectives went to the scene to investigate. The treasure was turned over to them. The theory of the police is that the jewelry was dropped by burglars by accident or when pursued, and it sank in the mud. This theory is not impossible, as the jewelry is of recent fashion, and there have been several burglaries of jewelry stores here of late.

**A Pretty good Story from a Little Town.**

BRIDGEPORT, Ind. Aug. 17.—In 1881 Perley P. Belt, of this place, went to Kansas and settled at Oswego. Being a jeweler he went to work for a jeweler of that place, and at odd times worked on a miniature anvil, made of solid silver, which he mailed to his brother, G. W. Belt, who then lived here but who finally left and located in Columbus, Kan.,

where he now resides. On Friday last Perley P. Belt, who is visiting his parents here, called at the postoffice for his mail and got a package addressed to his brother, G. W., and upon opening it, found the anvil he had mailed his brother in 1881. The package was in a remarkable good condition to have been in the mails for twelve years.

**The Assignment of Joshua Lothrop & Co.**

PROVIDENCE, R. I., Aug. 21.—Joshua Lothrop Co., manufacturing jewelers, 61 Peck St., have made an assignment to Edward A. Potter, of Edward A Potter & Co., manufacturing jewelers in the same building. The business is an old established one having been started by W. A. Beatty & Co., in Pawtucket, about a quarter of a century ago, Mr. Lothrop being a member of the concern. In May, 1883, the concern removed to this city. Mr. Lothrop was the traveling representative and was one of the oldest and most widely and favorably known jewelry salesmen in this section.

About six weeks ago the firm were dissolved by the withdrawal of Mr. Beatty and since then Mr. Lothrop has continued the business with care and economy, but the untoward financial condition of the jewelry business, the general depression of all kinds of business and a limited capital, forced Mr. Lothrop to make the assignment. No estimate can yet be made of the assets and liabilities, although it is thought that the firm will be able to liquidate all their indebtedness and continue business.

James Morris, wanted in Anaconda, Mon., for the burglary of Jos. C. Keppler's jewelry store, was arrested in Butte, Mon., last week.

**C. SYDNEY SMITH,**

HAS REMOVED TO

191 BROADWAY,

New York.

FACTORY:  
PROVIDENCE, R. I.

Manufacturer of

GOLD CHAINS,  
LOCKETS AND CHARMS.

**R., L. & M. Friedlander,**



IMPORTERS OF  
DIAMONDS.

WHOLESALE  
JEWELERS.

JOBBERS IN  
American Watches.

Tools, Materials, and Optical Goods.

Send for Catalogue.

65 & 67 Nassau Street, New York.

## A WORD ABOUT OPTICS.

**D**ID you say you would like to make more money out of your Optical business? How are we to know it if you go on in the old-fashioned "Guess you have fitted them" plan? If you wish to know just how to fit them and do it in a correct and scientific manner, come to us. There is big money in it, and you can increase your business from six to ten times the amount by knowing how to do your work properly. There are more people who need glasses and do not know it than those that are already wearing them. Will you sit idly by and allow this trade to go elsewhere, or will you put yourself in a position to reap the reward? If the former, write to the SPENCER OPTICAL MFG. Co., 15 Maiden Lane, N. Y. City, for their circular, showing you what has been done and what can be done.

## Hon. Hiram Camp's Daughters will Contest His Will.

NEW HAVEN, Conn., Aug. 18.—The daughters of the late Hiram Camp, ex-president of the New Haven Clock Co., Mrs. Jeanette C. Harmount and Mrs. Mary A. White, have filed an application in the New Haven Probate Court praying that an appeal to the Superior Court be taken from the probating of the will. The application was granted Wednesday. The ground on which the appeal was taken, and which will be made the basis of the contest, is that undue influence was used with the testator in the making of the will upon the part of various benevolent institutions which were given considerable property. It appears that the institutions interested would receive, if the provisions of the will were carried out, one-third of the property. The estate is valued at about \$170,000.

It is said that had it not been for the large bequest which was made to the Northfield Seminary, the daughters of Hiram Camp would have made no objection to the will. About a year before his death Mr. Camp had given about \$70,000 to the Northfield school, which is conducted by the Rev. Dwight L. Moody, and the subsequent bequest, \$35,000, it is asserted, was the result

of the influence which was exerted over him by those who had an interest in the school, and received more than was intended.

The executors of the will will fight the case, and believe that when all the facts come out the will cannot be set aside. It is claimed that the daughters had been most amply provided for prior to the death of the deceased, and it was because of this fact that Mr. Camp felt free to make more liberal bequests to the various charitable institutions than he would otherwise have done.

## The Scheduled Assets and Liabilities of M. Fox & Co.

Theodore M. Schulz, assignee of M. Fox & Co., 1 Maiden Lane, New York, filed his inventory and schedules with the clerk of the Court of Common Pleas, on Thursday. They show the value of the assets of the firm to be as follows:

Merchandise on hand, nominal value \$107,256.44, actual value \$80,291.36; book accounts good, \$19,079.63; book accounts bad, nominal value \$23,994.52, worth nothing; bills receivable good, nominal value \$4,124.59, actual value, \$3,136.15; bills receivable bad, nominal value \$1,676.77, worth nothing; and contingent assets \$7,120.54, making the total nominal assets \$163,252.49, the actual value of which is \$109,628.48. The liabilities to unpreferred creditors amount to \$186,988.22 which with the \$29,000 in preferences make the total liabilities \$215,988.22.

The preferences are to Louisa Fox for \$26,000 for borrowed money and interest, and to Cornelia A. Fox for \$3,000 for borrowed money. The contingent assets, amounting to \$7,120.54, consist of \$4,106.02 depending on the validity and maturity of a life insurance policy on the life of Ernest Kretzmar, assigned by him to M. Fox & Co. as security on an account for the above amount, and an account due by Wm. H. Sandifer of \$3,014.52 depending on the amount realized upon the proceeds of that assigned estate. The schedules show that neither Michael Geo. Louis nor Chas. J. Fox have any personal or real estate.

In his affidavit accompanying the schedules, the assignee states that the deficiency between the nominal and actual value of the assets is due to the \$25,671.29 which is in uncollectable accounts and that the deficiency between the nominal and actual values of the merchandise is due to the fact that some of the precious and semi-precious stones have become shopworn, and to the shrinkage in values.

Among the creditors of the firm are: W. B. Durand, E. F. Sanford & Co., Albert Lorsch & Co., Andrews & Doty, R. H. Breidenbach, C. Cottier & Son, Kuhn, Doerflinger & Co., E. Aug. Neresheimer & Co., Philip Bissinger & Co., Justin Wertheimer, Henry Fera, M. J. Lasar, S. Friend & Son, L. Telleinne, Jas. H. Brown, Bruhl Bros. & Co., Ludeke & Co., Schulz & Rudolph, Theo. M. Schulz, Ernest N. Adler, A. J. Grinberg & Co., E. E. Kipling, and the German American

**Aikin Lambert Jewelry Co.**  
Importers of  
**Diamonds**  
Jobbers in **WATCHES**  
Jewelry Chains etc.  
19 Maiden Lane  
*New York*

SAM'L B. MANN. Treas.  
FRED. D. ILGEN, Sec'y

JAMES C. AIKIN, Pres.  
JOHN B. SHEA, V.-Pres.

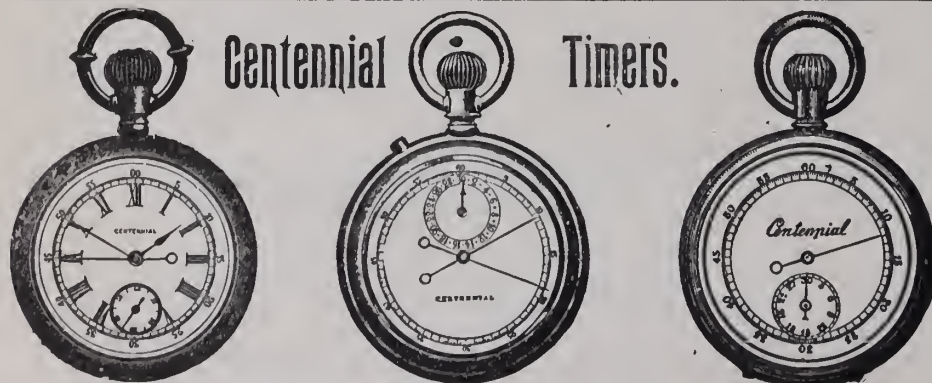

These Watches are one-third larger than above cuts.

**CROSS & BEGUELIN,**  
Manufacturers, Importers and Jobbers of  
**Watches, Diamonds, Jewelry, Watch Materials, etc.,**  
17 MAIDEN LANE, NEW YORK.

Bank. The foreign creditors are : Philip Robinson & Co., L. Keller & Co., E. H. Keller, E. Hahn & Co., J. L. Van Emaden, Louis Purper, Carl Herwagen, Jacob Wild, Mirza Mohammed.

Upon the filing of the schedules, Judge Giegerich of the Court of Common Pleas signed an order fixing the bond of the assignee at \$90,000 and making the provisional bond for that sum, filed July 10th, the final bond of the assignee.

**Charges of Larceny and Judgement Entered against Donnell & Frish.**

PITTSBURGH, Pa., Aug. 19.—Informations were made last week before Magistrate Donahue by W. C. Davis and D. L. Rankin against Donnell & Frish, for larceny by bailee. The business was seized on Thursday by the sheriff. The two prosecutors were clerks in the firm's employ, and were required to put up a deposit when they went to work.

Davis put up a certified check for \$200, and Rankin put up \$65 in cash, all the money he had. When the sheriff seized the store the clerks asked for the return of the check and money, but it was refused them, and they sued to recover. T. E. Donnell, of the firm, went before the magistrate for a hearing on last Friday. It is said that Mr. Frish, the other member, has left town.

Later Mr. Donnell was again arrested by Officer Price and taken before Alderman Reilly on a charge of larceny by bailee, preferred by L. Wittenhauser, a New York wholesale jeweler, who alleges that Donnell & Frish two months ago obtained from him two sets of diamond eardrops valued at \$300 per set, under a promise to sell or return them in thirty days, but that neither the cash nor the eardrops have been received by him. Donnell gave bail of \$500 for a hearing on Aug. 29th.

On the top of all this Heeren Bros. & Co. have entered judgment against Donnell & Frish for \$110 for goods sold them on memorandum.

**A Temporary Shut-Down of the American Waltham Watch factory.**

WALTHAM, Mass., Aug. 19. The announcement is made that the American Waltham Watch Co.'s factory will close again the first week in September.

This action is said to be for the purpose of readjusting some of the machinery and is only a temporary lull. The works will probably start up again Sept. 7 in all probability, says President Fitch.

Assistant superintendent George H. Shirley has resigned his position. Mr. Shirley has been with the watch company since 1864, and was a foreman for nearly ten years prior to receiving his appointment to the place he now relinquishes. He had special charge of forwarding the work and as been a very valuable man in that capacity.

**The Schedules of Assets of F. E. Morse & Son.**

CHICAGO, Ill., Aug. 21.—In the matter of the voluntary assignment of F. E. Morse (as F. E. Morse & Son and individually) debtor, an inventory and valuation of all estate, real and personal, belonging to Mr. Morse or in which he has any interest, that has come into the possession or knowledge of assignee Elbert H. Gary, was filed by the latter in the County Court, Friday morning as follows :

Three pieces of real estate, equity of redemption, - - -	\$55,750.46
Jewelry and precious stones, last inventory, - - - - -	71,467.46
estimated valuation, - - -	61,562.39
Office fixtures, estimated valuation, - - - - -	795.00
Accounts receivable, - - -	29,232.19
Total Assets, estimated, - - -	141,339.58

The liens on real estate were :

Mortgage to Illinois Trust and Savings Bank, - - - - -	18,000.00
Mortgage to Mrs. H. D. Mitchell, - - - - -	36,500.00
" " F. R. Chandler, - - - - -	12,500.00

Total mortgages, - - - - -	\$67,000.00
Leaving equity of redemption, - - - - -	\$55,750.00

The inventory of jewelry fills twenty-three pages of legal cap and embraces precious stones and made up goods usually carried by diamond houses. Besides the above inventory there is \$5,000 stock in the Royal Trust Co. Bank, pledged to the bank to secure a \$5,000 note by F. E. Morse; thirty shares of Alhambra Mining Co. stock which stand in the name of F. E. Morse, but are claimed by John F. Morse, his son; furniture in the house at 3,659 Grand Boulevard, claimed by Mrs. F. E. Morse.

No schedule of liabilities has yet been filed in the case of F. E. Morse & Son and neither assets nor liabilities in the case of Morse, Mitchell & Williams.

**Burglars got to Jacob Price's Store Before He Did.**

BOSTON, Mass., Aug. 19.—When jeweler Jacob Price, 277 West Broadway, opened his store this morning he discovered that burglars had been there before him. The place had been thoroughly overhauled and nearly everything of value was bagged by the robbers.

The property stolen amounts to several hundred dollars in value, and there is no clue to the thieves. It is supposed that they entered by a transom window.

**THE BURGLARS COME TO BOOK.**

BOSTON, Mass., Aug. 21.—Last evening three men were taken into custody in South Boston charged with breaking into and entering the jewelry store of Jacob Price. Some of the stolen property was in their possession. Later a fourth prisoner was brought in charged with receiving some of the jewelry. The names of quartet are : Timothy Callahan, Frank Horn, Frank McDonald, and William Eastman, all residing in South Boston.

**Last Week's Arrivals.**

*THE CIRCULAR has perfected arrangements for obtaining the names and hotel addresses of all the latest buyers visiting New York, and each day posts in its office, 189 Broadway, a bulletin which every member of the trade is cordially invited to copy.*

The following out-of-town dealers were registered in New York during the past week : H. A. Guild, Boston, Mass., Astor H.; M. S. Kennedy, Detroit, Mich., Gilsey H.; J. W. Raphael, San Francisco, Cal., Vendome H.; G. T. Ellis, Toronto, Ont., St. Denis H.; Gus. Heper, buyer of china, glassware, etc., for D. Crawford & Co., St. Louis, Mo., 115 Worth St.; F. B. Ryder, buyer for Sibley, Lindsay & Curr, Rochester, N. Y., Park Ave. H.; P. J. Shekman, buyer for W. M. Whitney & Co., Albany, N. Y., 335 Broadway; T. Kaufman, Pittsburg, Pa.; Imperial H.; M. B. Phillips, Boston, Mass., Astor H.; W. A. Thompson, Boston, Mass., Astor H.; J. C. Lutz, Buffalo, N. Y., Sinclair H.; H. Weil, Buffalo, N. Y., Astor H.; H. Loeb, Chicago, Ill., Astor H.; L. L. Fischer, Chattanooga, Tenn., Imperial H.; A. E. Covell, Pawtucket, R. I., Astor H.; Thos. Witt, of the E. Jaccard Jewelry Co., St. Louis, Mo.; C. Fischer, New Orleans, La., Union Square H.; G. Hausman New Orleans, La., St. Denis, H.; W. A. Thompson, Boston, Mass., Astor H.; C. T. Anderson, Reading, Pa., Astor H.; W. P. Olds, buyer for Olds & King, Portland, Ore., St. Denis, H.; J. Bell, Chicago, Ill., Astor H.; C. A. Strauss, Cincinnati, O., Broadway Central H.; A. M. Hill, New Orleans, La., Marlborough H.; W. Koch, Baltimore, Md., Cosmopolitan H.; L. Baker, Philadelphia, Pa., Grand H.; J. W. Miller, Boston, Mass., Grand Union H.; C. E. Rosencrantz, San Francisco, Cal., Coleman H.; L. Lesser, Syracuse, N. Y., Astor H.; Gustave Fox, Cincinnati, O., Astor H.; S. Frenkel, Toronto, Ont., Imperial.

**A Thief with an Appetite for Pawntickets and Gold Rings.**

Three young men entered the jewelry store of Charles W. Hopkins, 178 Manhattan Ave., New York, on Aug. 15, and asked to be shown some rings. After they had gone some gold rings were found to be missing. Wednesday morning Mr. Hopkins noticed a man answering the description of one of his visitors coming out of William Bennett's jewelry store, at 276 Manhattan Ave.

Hopkins caught hold of the man and took him to the station house. On the way the man attempted to swallow something, and Hopkins choked him and took from his mouth three pawntickets for the missing rings. When searched at the police station the prisoner tried to swallow a gold ring, which was afterward identified as having been stolen from Mr. Bennett's store. He was held for examination.

### The Keystone Watch Case Co.'s Factory Temporarily Shut Down.

PHILADELPHIA, Pa., Aug. 19.—The Keystone Watch Case Co.'s factory practically shut down yesterday. Of the 1800 employes only fifty are now employed in the building. The factory is not expected to reopen until the morning of Sept. 14th, when it is believed the full complement of men will again be employed.

The first notice of the shut down was given the employes on Wednesday last, when the officers of the company at a meeting decided that the business outlook would no longer warrant the employment of so many hands, so all the workmen except the fifty employed in the repair department were given notice that they were to be laid off.

### The Brilliant Display of Watches Temporarily Stopped the Burglars.

COLUMBUS, O., Aug. 16.—One of the bold-est burglaries on record took place in this city at 8:30 last evening. A soldier and a colored man reported to the police that they had just seen a white man coming out of Harrington & Co.'s jewelry store, 46 N. High St., stuffing his pockets with something. Investigation showed that the front door of the store had been "jimmied," entrance gained and fifteen watches taken, one of

which had been dropped on the pavement outside.

The watches belonged to the display of F. A. Brown, salesman of the Waterbury Watch Co., who had his goods on exhibition in the window. A bright electric light was shining in front of the store at the time. Mr. Brown has on exhibition at different jewelry establishments in this city about 1500 watches. About 200 of this number were in the show window of Harrington & Co. It is Mr. Brown's custom to leave the watches in the window at night for the purpose of displaying them. The watches were arranged on a tier of steps in the window, and on the top step was a standard made of large letters covered with velvet so as to form the word "watches." On this standard were fifty-two watches.

### Stole Gold to Furnish a Home for His Bride.

PHILADELPHIA, Pa., Aug. 21.—William Mohr was arrested on Friday on the charge of stealing gold from the establishment of Kiefer & Deschamps, 7th and Chestnut Sts., where he was employed. John M. Scott, an old gold dealer at 903 Filbert St., was also arrested, charged with purchasing the stolen bullion. Magistrate Devlin held Mohr in \$800 bail and Scott in \$1,000.

The arrests were made on a warrant sworn out by Joseph H. Deschamps. Mohr admitted his guilt and said he had disposed of \$200 worth of gold in this way. He sold it to Scott for forty-five cents a penny-weight. His only excuse was that he was recently married, and that being desirous of furnishing a house he adopted this method of accumulating funds.

### The Largest Photographic Telescope in the World.

BOSTON, Mass., Aug. 17.—The Bruce photographic telescope, made by the Alvin G. Clark & Son Co., of Cambridge, after designs made by Prof. Edward C. Pickering, of Harvard University, was tested last night on the grounds at the workshop. A photograph of the north star was successfully taken.

Photographic telescopes with eight-inch lenses have been used before, one of these now being in the Harvard observatory, but the enormous twenty-four inch lens of the new telescope marks an era in photographic astronomy. This new telescope will photograph stars of the seventeenth magnitude.

### Robert Knox, Convicted of Robbery to Have a New Trial.

CITY OF MEXICO, Aug. 18.—Robert J. Knox, the American who was sentenced to five years' imprisonment in this city a short time ago for swindling a local jeweler out of \$12,000 worth of jewelry, has been granted a new trial. Knox formerly resided in Elmira, N. Y., and in Minneapolis, Minn., and is known to the sporting fraternity of those cities. He has influential friends in the United States who are working in his behalf.

### Failure in Joplin, Mo.

JOPLIN, Mo., Aug. 16.—W. P. Owen, jeweler, failed to-day. His stock was seized by the sheriff under attachments in favor of the Bank of Joplin for \$1,000, and Frank Miller of Neosho for \$1,500. The liabilities are believed to be considerably in excess of the assets.

### Trans-Atlantic Voyagers.

Among the departures for Europe during the past week were: S. O. Ovington and G. S. Ovington, Brooklyn, N. Y., on the *Paris*; Henry O. Hurlburt, of H. O. Hurlburt & Sons, Philadelphia, Pa., on the *Rhynland*; J. Badollet, Geneva, Switzerland, on *La Normandie*.

On the *Etruria* that arrived Sunday from Europe were: Chester Billings, of Randel, Baremore & Billings, New York, his wife and son, H. B. Billings, R. E. Burdick, of Bowler & Burdick Co., Cleveland, O.; Joseph C. Dueber and Miss Pauline Dueber, Canton, O., and A. M. Hill, New Orleans, La. On *La Touraine* which arrived the same day, were: C. H. Jacot, of Jacot & Son, New York; M. Guggenheim, of Guggenheim, Alkan & Co., Buffalo, N. Y., and Mr. Francillon, of Longines, France.

# WALTHAM REPEATERS

## STRIKING HOURS AND MINUTES.

TO THE TRADE:—

Having purchased the entire remaining stock of WALTHAM REPEATING MOVEMENTS from the American Waltham Watch Co., and cased them in 20 year 14k. Cases, I am prepared to sell them at prices 30 per cent. less than they have ever been offered before.

Artistic Special Catalogue Free.

Send for Prices and Terms.

# JOHN B. YATES,

21 & 23 MAIDEN LANE, NEW YORK.



## MUELLER'S ARTIFICIAL EYES.

\$75 per hundred; smaller lots, \$15 per dozen; \$2 each. A large assortment of eyes will be sent to any dealer to enable him to make selection, upon receipt of satisfactory references. We carry the largest stock in America.

ONLY MANUFACTURERS OF THE "DIAMANTA" SPECTACLES AND EYE-GLASSES.

Oculists' prescriptions promptly and accurately filled. Catalogue, price lists, test cards, etc., on application.

M. ZINEMAN & BRO., American Agents, 130 South Ninth St., Philadelphia.

# WATERMAN & LEHMANN,

MANUFACTURERS OF

## DIAMOND JEWELRY

AND DEALERS IN

## DIAMONDS,

No. 37 MAIDEN LANE,

NEW YORK.

# The Jewelers' Circular

AND  
HOROLOGICAL REVIEW.

PUBLISHED EVERY WEDNESDAY BY

THE JEWELERS' CIRCULAR PUB'G CO.,  
189 BROADWAY, NEW YORK CITY.

A JOURNAL DEVOTED TO THE INTERESTS OF JEWELERS, WATCHMAKERS, SILVERSMITHS, ELECTRO-PLATE MANUFACTURERS, AND ALL ENGAGED IN KINDRED BRANCHES OF INDUSTRY

Our Editorial columns will contain our own opinions only, and we shall present in other columns only what we consider of interest or value to our readers. Advertising matter will not be printed as news.

Advertising rates in THE CIRCULAR are lower, considering the number of tradesmen reached by its large circulation, than in any other jewelry journal.

Notices of changes in standing advertisements must be received one week in advance; new matter can be received up to Monday.

## INFORMATION FOR SUBSCRIBERS.

### Terms of Subscription, Postage Prepaid.

	PER ANNUM
United States and Canada, - - -	\$2.00
Foreign Countries in Postal Union, - - -	4.00
Single Copies, - - - - -	.10

New subscribers can commence at any time. Payments for THE CIRCULAR, when sent by mail, should be made in a Post-Office Money Order, Bank Check or Draft, or an Express Money Order or Registered Letter. All postmasters are required to register letters whenever requested to do so.

Pay money only to authorized collectors having proper credentials.

Returning your paper will not enable us to discontinue it, as we cannot find your name on our books unless your address is given.

In changing address always give the old as well as new one. Your name cannot be found on our books unless this is done.

The Courts have decided that all subscribers to journals are responsible until arrearages are paid in full and an order to discontinue has been received by the publisher.

### Member of the American Trade Press Association.

VOL. XXVII. Aug. 23, 1893, No. 4.

THE views of a New York diamond merchant on the present depressed commercial conditions, as expressed in a lengthy communication published in this issue of THE CIRCULAR will be read with much interest by the trade generally. The arguments are consecutive and pointed and the conclusions are logical. The writer, we understand, words the opinions of a number of fellow merchants in the diamond trade, and thus the communication is given force and the semblance of truth in the reasons stated for the present untoward financial and commercial conditions.

In the mine of the Newjager's Fontaine Company in the Free State of Orange, a white diamond was found a few weeks ago weighing 971 carats.

—Philadelphia Record.

THE above is quoted to serve as a specimen of the solecisms for which the common daily newspapers are noted. The company the Record evidently refers to is the "New Jagersfontein Company." The error can scarcely be considered one of typography, as the item was quoted from an exchange that formed the same jumble of letters. Reliable news and information anent the jewelry and cognate industries are published only in a reliable journal representing

these industries; and THE JEWELERS' CIRCULAR is this journal.

**To Be Forearmed** **T**HE genus thief since made his pilgrimage in hordes to his Mecca and has performed his devotions with much earnestness. In other words, the World's Fair City has been overrun with enterprising thieves and swindlers whose operations have been somewhat intercepted by Chief of Police McCaughy, while hosts of suspicious characters have been driven from the city with the result that the country within a radius of 100 miles of Chicago has had its population increased by numerous slimy individuals. Let the jewelers in this territory be on their guard, for they are the elected victims.

### An Opportunity for **W**HATEVER Bankruptcy Legislation Sponsors.

may be the ultimate result of the present currency stringency, the number of insolvencies and the amount of liabilities they represent have been so much greater during the first half of the present year than for the average of the same period of the past ten years that interest is likely to be revived in the Torrey Bankruptcy bill, or some other bill covering the subject. The right possessed by Congress to pass bankruptcy laws has been used very conservatively. During the 117 years that the United States has been a nation, three bankruptcy laws have been enacted and repealed. The first, passed in 1800, was designed as a measure of relief for the new country after the prolonged war of the Revolution. It existed two years. Then came an interval of thirty-eight years, extending to 1841, when the second bankrupt law was passed to repair the fortunes of those who were caught in the panic of 1837. This law was on the statute books thirteen months, but great numbers of insolvents took advantage of it and resumed business. There was then another interval of twenty-six years, till 1867, when the third and last bankruptcy law was passed. This was intended to aid those who had failed in consequence of the violent fluctuations of values during and immediately after the civil war. In 1878 this law was repealed, as an amendment introduced in 1874 injuriously affected the creditor class. Since this year several attempts to revive such legislation have been made without avail. While the failures precipitated by the present currency crisis, which is now believed to be receding, have not produced a situation of such gravity as that preceding the three laws mentioned, they should afford a fresh and potent argument to the sponsors of proposed legislation of this nature. At the next Congress, when the full significance of our present depressed commercial and financial condition has been made clear, bankruptcy legislation should be intelligently discussed and acted upon.

## The Week in Brief.

THE death of Walter E. White, of Walter E. White & Co., Providence, R. I., occurred—The schedules of assets and liabilities of M. Fox & Co., New York, were filed—The will of Hon. Hiram Camp, New Haven, Conn., will be contested by the daughters of the deceased—S. Salamon, San Francisco, Cal., filed a petition in insolvency—Joseph Dozier, a negro, stumbled across a considerable quantity of jewelry near New Orleans, La.—Joshua Lothrop & Co., Providence, R. I., made an assignment—The man who recently burglarized the store of J. C. Keppler, Anaconda, Mont., was captured—The death occurred of Abraham Prince, an old-time jeweler of Boston, Neb.—The stock of Shook, Patter & Co., Omaha, Neb., was offered for sale by the sheriff—"Kid" McCoy, charged with robbing W. G. Pollack, salesman for W. L. Pollack & Co., New York, was examined in court—Boy burglars committed several robberies in Halifax, N. S.—The store of George H. Glass, Church's Ferry, N. Dak., was burglarized—The store of Ross Bros., Hartsville, Ind., was robbed by burglars—Charges of larceny were entered against Donnell & Frish, Pittsburgh, Pa.—The American Waltham Watch Co.'s factory will shut down temporarily—The schedules of assets of F. E. Morse & Son, Chicago, Ill., were filed—Burglars entered the store of Jacob Price, Boston, Mass.—James Dixon, New York, assigned—A receiver was appointed for F. Grote & Co., New York, to dissolve the business—Judgments by London creditors were entered against M. Fox & Co., New York—Attachments were issued against Elias S. Pilzer, New York—The sheriff took possession of the store of Abraham Goldberg, New York—The factory of the Keystone Watch Case Co., Philadelphia, Pa., has shut down—The store of Harrington & Co., Columbus, O., was robbed—An employe of Kiefer & Deschamps, Philadelphia, Pa., confessed to the stealing of gold—W. P. Owen, Joplin, Mo., failed—Robert Knox, the American convicted of robbing a jeweler of the City of Mexico is to have a new trial.

### Col. James M. Longstreet Dies from a Stroke of Paralysis.

Boston, Mass., Aug. 20.—James M. Longstreet, 383 Washington St., room 5, was stricken with paralysis this morning and died within a few hours at his home in the Dorchester district. He was 66 years of age and leaves two sons.

Deceased was a veteran of the Florida, Mexican and civil wars. He went out with the 12th Mass. regiment in the last conflict and later was made colonel of the 17th regiment. He was a member of Post 68, G. A. R., and in Providence, R. I., his birthplace, he was connected with the masonic fraternity.

Col. Longstreet had been in the jewelry business here over twenty-five years.

### New York Items.

The Nassau Bank has obtained a judgment for \$1,054.24 against Josie F. Molius.

Leon Tigler, watchmaker and repairer formerly of 50 Nassau St. is now at 1 Maiden Lane.

Benjamin Eichberg, of Eichberg & Co., is making a business trip through Chicago and the west.

A judgment for \$4,157.98 has been entered against Chas. Seale, in favor of Maurice Weil.

Summer Blackinton, of W. & S. Blackinton, returned from Europe, Friday, on the *Fuerst Bismarck*.

Among the passengers on the *Etruria*, which arrived Saturday, was Chester Billings, of Randel, Baremore & Billings.

Alois Kohn & Co. have obtained judgment for \$455.36 against Wolf Glass, who was sold out by the sheriff a short time ago.

Benno Loewry has entered two judgments against M. Fox & Co. in favor of London creditors, one for \$3,863.52 for L. Keller & Co., and one for \$2,407.99 for E. A. Keller.

Deputy Sheriff Heimburger on Thursday took possession of the jewelry store of Abraham Goldberg, at 112 Ridge St., on an execution for \$592.95 in favor of William Solomon.

Burglars, last week, effected an entrance into the store of George F. Leyh, 75 Broadway, Brooklyn, and stole a number of opera glasses and other articles. The police are investigating the case.

C. E. Breckenridge, of the Wilcox Silver Plate Co., has entirely recovered from the injuries he received in a runaway accident on Aug. 13th, as told in THE CIRCULAR last week. He returned to his office Wednesday, and says he feels no ill effects from the bruises he received.

On the consent of counsel, Judge McCarthy of the City Court on Thursday issued an order discontinuing the action brought by the E. Howard Watch & Clock Co., against Benj. S. Wise & Co. The suit was over a disputed difference in an account, and was settled satisfactorily to both firms out of court.

Isidore Stern, 69 Nassau St., commenced supplementary proceedings in the city court some time ago against Zachariah Latshaw, formerly manager of the National Electric Mfg. Co., of Troy, N. Y., on a judgment for \$455 due for diamonds bought by Latshaw, sixteen months ago. Mr. Latshaw satisfied the judgment Saturday.

Judge Freedman, of the Superior Court, on Friday appointed Herman E. Kleber, one of the directors of F. Grote & Co., dealers in ivory and tortoise shell goods on E. 14th St., as receiver for that corporation in proceedings for its voluntary dissolution. Mr. Kleber filed a bond for \$60,000. His surety is William Steinway who owns 1,500 of the 2000 shares of stock.

In speaking of the settlement proposed by Adolph Goldsmith & Son, Sigmund Goldsmith of that firm stated to a CIRCULAR reporter that creditors representing the greater part of the firm's indebtedness had

already signed the agreement to accept the offer of fifty per cent. decided upon at the creditors' meeting held Aug. 7th. Everything, he said, was getting on satisfactorily and his firm hoped to have the settlement consummated very soon.

Upon application of the attorneys for the New York Jewelers' Board of Trade, the money realized from the sheriff's sale of the stock of the Bailey & Esser Co., Milwaukee, Wis., was turned over to the court. The attorneys then moved for the appointment of a receiver, and a decision is expected this week. Secretary H. M. Condit, of the New York Jewelers' Board of Trade, will take charge of the claims of all creditors who may wish to join in these proceedings.

A motion will be made this week, at the Special term of the Supreme Court, by the plaintiffs in the suit of the Dueber Watch Case Mfg. Co. against the Co-Operating Manufacturers, asking for an order granting a commission to examine certain witnesses in Pittsburgh, Pa., on questions touching the issues in this action. The witnesses to be examined are: Isidore Ollendorf, Morris Kingsbacher, Aaron Kingsbacher, Otto Heeren, Wm. F. Hoffman, Geo. B. Barrett, Geo. E. Goddard, and E. H. Hill.

Two attachments were issued last week by Judge O'Brien of the Supreme Court against Elias S. Pilzer, 97 Clinton St., on the ground that Pilzer had concealed property with intent to defraud his creditors. The attachments were for \$879.61 in favor of Julius Bernstein, and for \$1,390.55 in favor of S. F. Myers & Co. No property was found at Pilzer's store, where A. Percher, his brother-in-law, claims to be in possession under a bill of sale. It is said that Pilzer obtained \$1,300 worth of goods on the day before his failure.

The attorneys for the New York Jewelers' Board of Trade, at Memphis, Tenn., have notified the Board that creditors representing \$3,500 of the indebtedness of V. B. Thayer, of that city, have filed a bill against Thayer, his trustee, T. J. Barchus, and the incorporators of the Thayer Jewelry Co., attacking the recent assignment on the ground of fraud, and also attacking the sale of the business by the trustee to the Thayer Jewelry Co., claiming that V. B. Thayer is really the Thayer Jewelry Co.

James Dixon, of 487 W. 22nd St., dealer in jewelry, silverware, clocks and watches, under the name of Jas. Dixon & Co., 323 Eighth Ave., assigned on Friday to Ralph Earl Prime Jr., a lawyer at 25 Warburton Ave., Yonkers, giving preferences amounting to \$1,000; to Mrs. Jane Diggins, Galt, Canada, for \$200, and to John Dixon, his brother, Trenton, N. J., for \$800. The business was started in 1883 by James and Hugh Dixon, and since his, Hugh Dixon's, withdrawal it has been continued by James Dixon under the old name of Jas. Dixon & Co.

Wilbur & Oldham, the attorneys for Allan C. Dalzell, in his suit against Jos. Fahys & Co., moved before Judge Freedman of the New York Superior Court, for an

order permitting them to inspect the books of the defendant company. The suit is to recover \$75,000 for breach of contract, Dalzell claiming that under an agreement made with Fahys & Co., he was to receive as a purchase price for his patents on certain machinery, a sum equal to one half the profits obtained by the company through the use of his patents. The inspection of the books is asked for in order that he may ascertain the amount which he claims is due him. Decision was reserved.

### The Alvin Mfg. Co. to Sue the World's Fair Commissioners.

NEWARK, N. J., Aug. 22.—The Alvin Mfg. Co.'s factory has been partially closed. Of the one hundred and twenty-five men at work in the factory last week only thirteen have been retained. At the factory it was said that no date for the resumption of work had been set, but it is expected to start up in a week or two. One of the causes of the need of this retrenchment is tight money. There is another cause, and this will lead to a suit against the World's Fair Commissioners.

The Alvin Company got a contract from the Commissioners to furnish souvenir silver spoons, and with other contractors, B. F. Norris, Alister & Co., Chicago, were compelled to furnish a certified check for \$35,000 as a guarantee of good faith; and the Commissioners pledged themselves that no other spoons would be sold on the grounds.

The company assert that other manufacturers were permitted to sell souvenir spoons at the Fair, and that as these were not of solid silver they were sold cheaper than those on sale by the regular contractors. The Alvin Company expected to sell 180,000 spoons, but so far have disposed of only 60,000.

### \$30,000 Worth of Black Diamonds Lost and Found.

Charles H. Billings, traveling salesman for S. Dessau, importer of carbons and bort, 4 and 6 John St., New York, telegraphed from St. Louis, Mo., to his house, last week, that he had lost about \$30,000 worth of black drilling diamonds. The lost stones were valued at \$17 a karat. The salesman had about 2,000 karats with him, in a small leather wallet, which he usually carried in the breast pocket of his coat.

On receipt of the telegram Mr. Dessau immediately started for St. Louis, accompanied by a Pinkerton detective. Saturday, F. W. Buckley, manager of Mr. Dessau's office, received a telegram from Mr. Dessau, stating that the package of black diamonds and bort had been recovered and everything was all right. Mr. Dessau is expected home to-day.

A dispatch from St. Louis says that the package containing the wallet was returned by mail, addressed to the day clerk of the Lindell House, where Mr. Billings stopped. With it was a letter unsigned, stating that the wallet was picked up last Tuesday night at the Union Depot. The finder has not been discovered.

HAVE REMOVED  
TO  
BROADWAY & 18<sup>TH</sup> STREET.

TWO BLOCKS ABOVE FORMER  
LOCATION.

Solid Silver  
Exclusively.



WHITING M'F'G CO.

SILVERSMITHS,

Broadway & 18th Street,

NEW YORK.

WORKS--AT FOURTH ST. AND LAFAYETTE PLACE.

## Articles of Silver Ornamented Ebony.

BY ELSIE BEE.

THE audacity of taking ebony, the hardest and heaviest of woods, and using it in light, graceful articles for personal use is in itself captivating. Some time ago when the period of darkness preceded the period of light, as is expressed by dark woods and dark wall papers and the prevailing white and gold, the height of luxury was ebony. There are fine old ebony wainscottings yet to be found among opulent old fashioned people. And yet the glamour of past splendor lingers in the wood. To people to whom ebony was but a name comes the possibility of acquaintance in its present revival. This is where we might least expect to find it, in the hand or on the toilet table.

The ebony for this purpose comes from Africa. The best quality comes from Gaboon. It may not be known, but only the roots of the tree known as ebony is the ebony of commerce. The dense and close grain is the result of something akin to petrification and is the result of the action of the water in the marshy ground, where it is found on the roots. These roots when they are available are rarely over four feet long. The wood is so hard that it cannot be planed, but is made smooth by a scraper.

In the new use of ebony it may be said in general that it is put into all forms in which ivory is found. Ebony is not, however, confined to these. It has invaded also the province of glass and of china. In every case it is combined with silver. This combination of jetty, lusterless wood with graceful polished devices in silver is one of the requirements of taste that belong peculiarly to our age which delights in piquant and unique contrasts.

The wood is used for two general purposes, articles of the toilet and for the library table. These in fact include a very large number of details. The toilet table nowadays is a comprehensive assortment of articles. In its briefest form, it includes combs, brushes, hand mirror. Then comes a long array of buttonhook, shoe horn, powder pomatum boxes. It is most interesting to see all these in ebony bedecked with silver.

The ornamentations which Deitsch Bros. 7 E. 17th St., New York, have applied to the number of articles which they have introduced in ebony and silver enforce the contrast by confining the ornament to borders with central details, so that the wood and the metal bring each the other into thorough relief. These designs are in themselves admirable. Most effective is a festooned edge made of wreaths and bow knots, which howsoever small are carefully worked out. Toilet and maniere sets in cases follow this style. It is interesting to see how the combs are treated. These are of tortoise shell but mounted in ebony and then adorned with silver ornament.

Especially graceful in Deitsch Bros.' line are the boxes and the glove powder bottles with their festooned wreaths. Other designs are the floriated scrolls and shells such as belong to the rococo styles, and again with diamond interlacings between foliations and other rich ornament. In envelope boxes and photograph frames, the same elegance of decoration is found.

At J. N. Provenzano, 39 Union Square, New York, the prevailing style of decoration is an overlay of fine perforated silver with a solid device in the center for the name or initial. This shows particularly well on the military brushes as they are called, which allow for an extent of surface. The hand-mirrors give opportunity for the same style of decoration. An apparently illimitable line of silver mounted ebony goods is produced in Mr. Provenzano's factory.

There is no doubt of the success of ebony in its latest appearance. No doubt it will be used in a far wider range of articles. This is encouraging because it demands artistic treatment. It would be impossible to thrust upon it inartistic decorations that might pass current in other materials.

## Connecticut.

Theo. Tobias, jewelry peddler, Hartford, has given a real estate mortgage for \$200.

C. W. Goodwin & Co., Torrington, have dissolved, and been succeeded by J. B. Lyon & Co.

C. Rogers & Bros.'s factory, Meriden, is running full time with quite a number of the hands laid off.

Edward Sanford, master mechanic of the Seth Thomas Clock Co., accompanied by his wife, has gone to Chicago to visit the World's Fair.

George A. Smith died in Bridgeport last Saturday, in the 63d year of his age. For thirty years Mr. Smith had been a contractor for the New Haven Clock Co.

Gen. G. H. Ford, of the Geo. H. Ford Co., New Haven, has gone on an extended business and pleasure tour in the west which includes a stay of several weeks at the World's Fair. Secretary Tibbal, of the company, has returned from a similar trip.

A handsome watch was presented to alderman Geo. Barnes, of Waterbury, last week, in honor of his 70th birthday by the Waterbury Odd Fellows. It was made for the occasion by the Waterbury Watch Co. It is a beautiful piece of workmanship with the Waterbury movement, the whole being made under the particular supervision of superintendent George E. Hart. The case is an open one of solid gold. The dial of enamel and jewels in colors is of special design, and includes on its illuminated surface the emblems of the patriarchal branch of the order and the patriarch militant as well as the Daughters of Rebecca and the Piscatorial Association, the highest honors of Odd Fellowship.

## Trade Gossip.

The Rockford Silver Plate Co. have imported a large stock of glassware from Bohemia.

H. U. Wheeler, manager of the Dubois Watch Case Co., has just patented a cigar holder which he claims prevents the smoke from absorbing any nicotine or other poisonous substances from cigars or cigarettes.

Lapp & Flershem, "The Busiest House in America" in their latest illustrated circular, which they have sent to the trade, call attention to great reductions in many lines of jewelry, watch movements, flatware, tools, optical goods and novelties.

St. Clair Fechner, who has been in the jewelry business in Washington, D. C., has entered the lists of jewelers' auctioneers. He has issued a neat pamphlet on "Practical Common Sense," which all jewelers contemplating holding a sale should read and ponder over. Mr. Fechner has handled watches, diamonds, jewelry and plated ware for over twenty years, and prides himself on being capable of estimating within 10 per cent. the amount any stock from \$1,000 to \$80,000 will bring at a forced sale.

W. S. Trowbridge has opened a School of letter and monogram engraving at 55 W. 3d St., Winona, Minn. The term commenced Aug. 21. The course of engraving includes designing and cutting every style of letter and monogram now in use. A thoroughly practical and competent instructor has superintendence of the school. The price of tuition is below that in large cities, and Winona being a city of 22,000 people, board can be had at a much lower figure than in the larger cities. Jewelers and others desiring to enter upon a course of instruction in engraving should communicate with Mr. Trowbridge.

The growing craze throughout Europe for toilet articles of ebony and silver in combination has already produced a demand for these goods in this country, to meet which, Deitsch Bros., the well-known originators of leather and silver combinations, 7 E. 17th St., New York, have introduced an assortment of ebony silver mounted goods in four different patterns, which cannot fail to excite the admiration of the most fastidious. Everything in the way of a toilet article can be found in this line, as may be seen in the enumeration in the firm's announcement in the advertising columns of this issue. Ebony which is the heart-wood of the Diospyros, is noted for its heaviness, hardness and deep black color; having all the properties of ivory it is particularly adapted to artistic work and is gradually taking the place of that substance in artistic articles of utility. In the brushes and other toilet pieces introduced by Deitsch Bros., the shapes are exceedingly beautiful and the workmanship perfect. The deep black background forms a brilliant combination in the "Marjorie," "Initial," "Rococo," "Castle" and "Empire" designs.



THE BEST QUALITY

# ELECTRO SILVER PLATE

IS STAMPED

★ ROGERS & BRO., A. I.

"COLUMBIA."

"SAVOY."

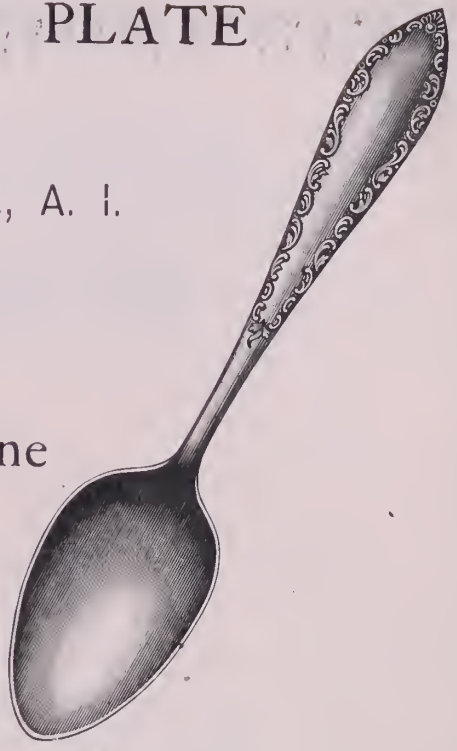
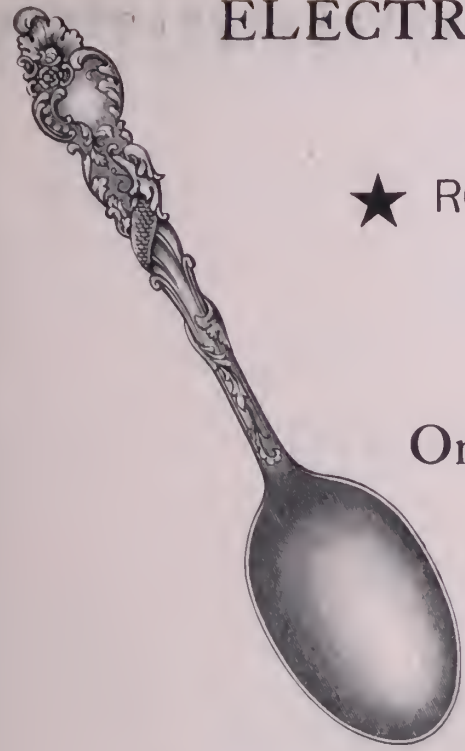

THE  
Original, Genuine  
and  
Celebrated

# STAR ★ BRAND

"TUXEDO."

"ASSYRIAN."



WHICH  
HAS STOOD THE  
TEST FOR 50 YEARS.

MADE ONLY BY

## ROGERS & BROTHER,

WATERBURY, CONN.

16 CORTLANDT ST., NEW YORK.

MAKERS OF THE FOLLOWING LEADING PATTERNS:

"COLUMBIA," "SAVOY," "TUXEDO" AND "ASSYRIAN."

NEW ILLUSTRATED CATALOGUE NOW READY.



# ARE YOU GOING TO THE WORLD'S FAIR?

If You Are Let Us Give You A Pointer.

Collect all the Old Gold, Silver, Plated Scraps, Bench Sweeps, bring same with you, call and see us, we will value your Gold, etc. accurately, and pay you for same while you wait. In this way you can pay a portion or perhaps all your expenses to the World's Fair. If you are not coming, or have more Gold, etc. than you wish to hold, would be pleased to have you ship same to us. Immediately on receipt we will remit by cash or draft. If our offer should not prove satisfactory we will return consignment intact and pay all charges.

Make us a trial shipment and you will ship again. Our Guide to Chicago and the World's Fair, mailed free on application.

**GOLDSMITH BROS.,**  
Gold and Silver Refiners and Assayers,  
63 & 65 Washington St.,

Near State,

CHICAGO, ILL.

MENTION THIS PAPER.



CHICAGO OFFICE: ROOM 308, INTER-OCEAN BUILDING.

VOL. XXVII.

CHICAGO, WEDNESDAY, AUGUST 23, 1893.

NO. 4.

JEWELERS' ARCHITECTURAL WORK AT THE FAIR.

THE exhibit of B. & W. B. Smith in section Q, block 1, col. 99 in Manufacturers building at the World's Fair, is particularly rich in architectural effect. On a space 20x15 feet fluted Corinthian gold bronze columns in pairs on mahogany pedestals support a mahogany frieze, the open corner having triple columns. The north and west walls are paneled in mahogany, the floor is carpeted with Wilton velvet and the ceiling is formed of broad striped canvas.

Standing in the center of the room is an historical table, which has aroused the interest of visitors, especially the Norwegian delegates, to a high degree. The table is of dark oak, the most difficult of all woods to carve, and the carvings are representative of Norway. In the center of the table is a place for a deep punch bowl with a cover forming the central carving, commemorative of the ship in which Leif Ericson came to America in about the year 1000 and from which he was supposed to have landed on the northeast coast. About this are eight rural scenes of Norway life, which are remarkable in

their execution and in their faithful portrayal of Norwegian scenery and costumes. In the circular corners, on the top

ing to the legs, the scroll encircling native animals and scenes. The medallion heads, and those on the top corners represent Ericson's crew. The sidings are slightly curved, eight inches deep in the center and four inches deep at the legs. At two-thirds the height of each elaborately carved leg are four heads, typical of the people and animals of Norway. From the foot of the legs to the ball supporting the base of the punch bowl in the center are four curved rods entwined with mythological serpents. The whole is a masterpiece of carved work, most beautiful in execution and worthily representative of the New York factory. It stands as a proof positive of the superior excellence of their work in furniture lines.

At the back of the exhibit is a mahogany wall case which has one plate glass sash in front, ten feet wide, sliding vertical doors perfectly balanced, closing dust tight. The plate glass door of this case weighs 220

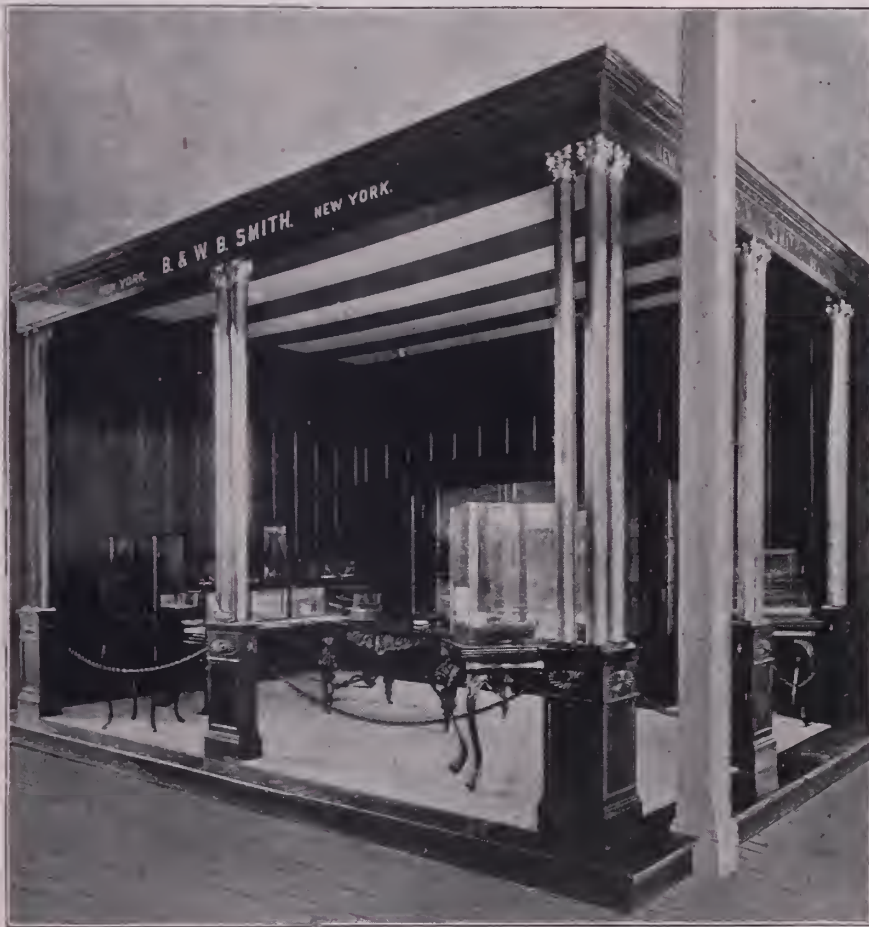

THE EXHIBIT OF B. & W. B. SMITH.

of the table are typical faces, and about the border is a conventional design. The sidings of the table each contain a medallion head in the center with scroll work reach-

pounds but is so delicately balanced that a child of eight years can easily handle it. The pilasters to the case are small and there is no indication of balance weights. Below

# Great Reduction!

## COLUMBUS 6 SIZE MOVEMENTS.

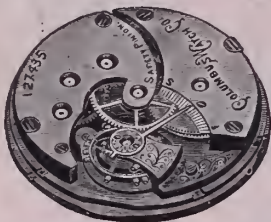

No. 50. GILT, 7 Jewels, Tempered Hair Spring. Fine White Hard Enamel Dial. Regular Price, \$9.00 List.  
Our Price, \$7.00 List.



No. 51. GILT, 11 Jewels, Upper Holes Jeweled, Tempered Hair Spring, Sunk Seconds Dial. Regular Price, \$11.50 List.  
Our Price, \$9.00 List.



No. 52. NICKEL, 11 Jewels, Upper Holes Jeweled, Tempered Hair Spring, Sunk Seconds Dial. Regular Price, \$12.50 List.  
Our Price, \$10.00 List.



No. 54. NICKEL, 13 Jewels, in Red Gold Settings, Tempered Hair Spring, Sunk Seconds Dial. Regular Price, \$14.00 List.  
Our Price, \$11.00 List.



No. 55. NICKEL, ADJUSTED, 15 Jewels, Set in Red Gold Settings, Tempered Hair Spring, Sunk Seconds Dial. Regular Price, \$20.00 List.  
Our Price, \$14.00 List.

FULL LINE OF EVERYTHING NEEDED BY JEWELERS.

**OTTO YOUNG & Co.,**  
CHICAGO, ILL.

are storage apartments for stock and two leaves which may be drawn out and used for showing samples, a most useful adjunct. The finish and workmanship are of the highest class.

At the west side of the exhibit and in each corner are show cases on mahogany tables with finely carved legs. One supports a handsome 7 feet rosewood counter case, so favorably known to the finest trade. The doors slide downward and are constructed with springs which prevent the door from falling suddenly of its own weight. There is also a "London front" jewel case 2x1 1/4 feet, finished in rosewood, the joints of which are made by the factory's new process, a rod 1/8 inch in diameter ornamenting the joints. Beside this are a square and a statutory case of the same make.

In the larger case is exhibited a dome of

ions and borders are "corded" with a delicate rosewood reed. On the shelf below this is a cabinet door, 12 x 18 inches, showing fine workmanship. In the center is a 4 inch diamond surrounded by twelve irregular shaped pieces, four triangles filling in the corners. All are of heavy beveled plate glass with rosewood over the joints. The ensemble is architecturally perfect and is worthy the foremost case makers of America. S. M. Martin, for some time identified with the house in the west, is in charge of the exhibit.

The exhibits of the firm, however, are not confined to their own allotment. The elegant fixtures of Tiffany & Co.'s exhibit, those of the Gorham Mfg. Co. and C. F. Gunther's Sons, and the pavillion of Wessell, Nickel & Gross in the Manufactures building, and Simons, Bro. & Co. and the



A FEATURE OF B. & W. B. SMITH'S EXHIBIT.

heaviest plate glass, bent at the factory, as perfect a piece of difficult bending as ever was accomplished. In one corner is a case with a bent glass front, two shelves and sliding doors, which forms one of the prettiest cases made. In another corner is a "square" case 3 feet long, 1' 9" wide and 2' 8 1/2" high designed for statuary, which is dust and water proof and air-tight. At the front of the exhibit is a large statuary case made by the "Smith process" without rosewood ornamentation — a case entirely of glass with invisible joints. Ensnconced within is a mirror block made in the same manner.

On one of the shelves of the wall case is a small jewel cabinet of the form of a cash register, composed of 240 small pieces of glass. It contains three apartments, a lower, middle and upper. The lower and middle are drawers, the latter with the front of bent glass; the upper has two swinging doors. The entire front with the exception of the bent glass is composed of pieces of beveled plate 3/4 inch square, and all divis-

Nathan Mfg. Co. in Machinery building, are all the product of this factory. Midway of each of the four sides of the 40x40 feet granted C. F. Gunther's Sons, the New York furriers, rise mahogany cases 16x6 feet and 11 feet high, with serpentine bases, carved bracket corners, square Ionic columns at corners supporting a frieze of rich San Domingo mahogany. The pilasters are veneered and have carved capitals.

All cases are made under the Smith patents and all have bent glass tops. Besides the several smaller cases, a marvel in bent glass is shown in a six-foot case, one foot wide and two feet high, the six-foot glass rising fifteen inches in the straight, both front and back, and then descending a perfect curve. A smaller case ten inches wide and two feet high rises straight at the back, and in front is bent in the form of an artists' "line of beauty." Commissioners from a dozen different countries have been deeply interested in B. & W. B. Smith's remarkable case exhibit, and have pronounced it unequaled by anything they had ever seen.

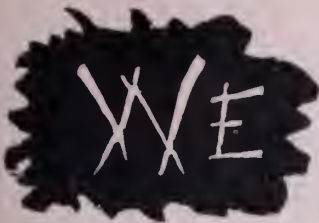

# GERMANY

SEEKS

AMERICAN TRADE,



And for the purpose of securing it has for several years **STUDIED AMERICAN WANTS.** The German exhibit at the World's Fair contains a full line of jewelry, special'y **SUITED TO YOUR NEEDS** and expressly made with a view to furthering the jewelry and silverware trade between the two countries. Mr. Richard Horstmann, under whose supervision and through whose efforts the consolidated German exhibits were secured to the Fair, represents the following lines :

- WATCHES.** { The celebrated patent watches of **DURRSTEIN & CO.'S UNION WORKS AT GLASHUTTE.** Among them movements held by bolts, and not by springs, insuring thinnest cases, split seconds, Chronometers, etc.
- JEWELRY.** { Representative manufacturers of Pforzheim, Hanau and Gmeund. These cities are known worldwide for taste in designs and beauty of gold colorings and enamel work in all branches of the jewelry trade.
- SILVERWARE.** { Reproductions of the best old German, Dutch and Rococo designs.

We can serve your best interests if you will but let us know your wants. Correspondence invited.

**RICHARD HORSTMANN,**

VIENNA.

Seigmundgasse 15. Tel.-Adr.: PARATUS WIEN.

BERLIN, S. W.

Oranienstrasse 101 102. Tel.-Adr.: PARATUS BERLIN.

LONDON, E. C.

13 Charterhouse Street. Tel.-Adr.: WELLROOM LONDON

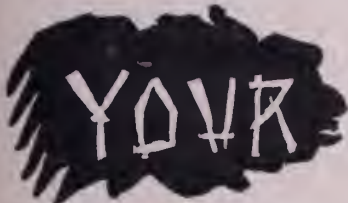

CHICAGO.—German Jewelry Exhibit, Manufactures Building, World's Fair.

GERMAN COURT OF HONOR.

# “WORKSHOP NOTES

For Jewelers and Watchmakers.”

BEING A COLLECTION OF THE LATEST PRACTICAL RECEIPTS ON THE MANUFACTURE AND REPAIRING OF WATCHES AND CLOCKS, AND ON THE VARIOUS PROCESSES ENTERING INTO THE MANUFACTURE AND REPAIRING OF JEWELRY, AS COLORING, POLISHING, ENAMELING, ANNEALING, OXIDIZING, ETC. IN; SHORT A THOROUGH COMPENDIUM OF THE NUMEROUS MECHANICAL DEPARTMENTS OF THE JEWELERS' AND WATCHMAKERS' SHOP.

**200 PAGES, BOUND IN CLOTH, STIFF COVERS.**

**PRICE \$2.50, BY MAIL, POSTPAID,**

**Including a Year's Subscription to the “Jewelers' Circular.”**

**THE JEWELERS' CIRCULAR PUBLISHING CO.,**  
**189 BROADWAY,** **NEW YORK.**

## HOROLOGY AT THE WORLD'S FAIR.

PART X.—EXHIBITS OF MANUFACTURERS OF THE SWISS STATES OUTSIDE OF GENEVA.

THE States outside of Geneva are finely represented in the exhibit of the watch industry of Switzerland in the Swiss section of the Manufactures building. These are Neuchatel, Berne and Vaud, and the showing made in complicated watches and smaller movements in richly decorated cases should deeply interest the practical watchmaker. The exhibits outside the Geneva factories occupy the north pavilion of the Swiss section with Nardin and Jurgensen in the places of honor—the front case.

Paul D. Nardin, successor to Ulysse Nardin, has a large line of complicated watches, all of which carry certificates. Repeaters, sweep seconds and minute registers are numerous, as are also perpetual calendars and repeaters combined. Two tourbillon escapements have a special patent on a winding device regulating the tension so that it is the same when partly as when fully wound. A magnificent double cased watch in Renaissance style entirely engraved by chisel from silver and gold shows two designs, one representing Labor, the other Art. It is a strike, sweep seconds, minute register, and is valued at \$2,000. It is a souvenir or presentation watch, and is not designed to be carried. As a work of art in both movement and case, it is remarkable. There are twenty-two watches, all high class, in twelve movements. The making of marine chronometers is a new industry in Switzerland and the government has fostered it by offering large prizes for the best results. Nardin shows two chronometers which contain recent improvements. One registers the seconds by electrical apparatus and has an improvement for winding. Instead of turning the chronometer and winding from the back, a spring is pressed and the chronometer is wound from

the top. This firm has four first prizes in rating for 1892.

Jules Alfred Jurgensen, of Locle, a son of the Jules Jurgensen so widely known, has thirty-two watches in open face and hunting cases, all high class with certificates. In the line are repeaters, chronometers, sweep seconds,  $\frac{1}{2}$  second fly backs, and a specialty of split and  $\frac{1}{2}$  second minute repeaters and minute registers with seconds and fifth hands both on the same staff. A twenty-four hour watch called the "Cosmopolitan" has two sets of hands, one completing the circle in twelve hours, the other in twenty-four. There are shown a few ten minute repeaters. These are the only ten minute repeaters ever made; the firm has a United States patent covering the device.

Borel & Courvoisier exhibit all sizes but make a specialty of eighteen line movements and ten and twelve line illuminated enamel dials. There are sixty-five watches in the exhibit, many carrying a rate certificate from the National Observatory at Neuchatel. A number of wee mites are shown in open faced gold and enamel dials. The medals shown are a bronze, London, 1862; bronze, Philadelphia, 1876; gold, Paris, 1878; and silver, Chaux-de-fonds, 1881.

Louis Rozat Muller, Chaux-de-Fonds, has a beautiful line of small sized watches running from 8 to 13 lines, also a perpetual strike and repeater in 18 lines and a repeater, sweep seconds and minute register in 18 lines. The cases with small movements are richly decorated in enamels and precious stones. A crystal globe paper weight 3 inches in diameter contains an eight day movement, and a number of eight day watches in silver cases are also shown.

J. Perrenoud & Fils, Chaux-de-Fonds, have fifteen small sized watches, from 8 to 13 lines in cases decorated with enamel,

pearls, and diamonds and other stones.

P. Matthey Doret, Locle, presents a line of large and small chronometers in finely engraved cases. This firm gives a rating certificate. On a patent intermittent strike, by pressing a slide at the side the watch will strike at the time designated and continue each quarter until silenced by changing the slide. Among the watches is a 13 line repeater, minutes, hours and seconds, handsomely engraved, and a few plain polished cases. The firm's trade-mark is "Maisonnette."

Piguet, Guillaume & Co., Sentier and Geneva, exhibit but five watches, all high-class complicated repeaters, including a 10 size split second and  $\frac{1}{4}$  second. The firm are the sole makers of Piguet's isolated split and the Lightning 4th and 5th split second and minute recorder, which they claim is the racing watch of the future.

Droz-Jeannot Fils, Brenets, have a fine line of 18 size chronometer escapements to fit American cases. They are finely jeweled and have jeweled winding in the barrel on which the firm have a United States patent. The firm also have a patent device to prevent overwinding. There are tourbillon escapements, a line of sweep seconds in 18 size, and five chronometer movements that have been granted first-class certificates from the Observatory at Neuchatel.

Maurice Didisheim, Chaux-de-Fonds, makes everything. There is a fine line of very small watches and an elegant assortment of small sizes in blue enamel and incrustated cases that are a delight to the ladies. A huge 40 line watch with enamel dial is flanked by two 12 line repeaters. The dial of this monstrous watch cost 150 francs. There is a large assortment of repeaters, fly backs, and split seconds, many with beautifully illuminated dials. The variety of

DIAMONDS WATCHES BHA TRADE MARK JEWELRY MANUFACTURING

L APP AND FLERSHEM Chicago, Ill.  
92, 94, 96 & 98 STATE ST. COR. WASHINGTON.

**THE LARGEST SUPPLY DEPOT**  
*For everything needed by Jewellers*  
ILLUSTRATED CATALOGUES FURNISHED JEWELERS  
SPECIAL FACILITIES FOR FILLING ORDERS. NO RETAILING.

CLOCK CANE STOCKS & TOOLS BHA MATERIALS

SILVER PLATE BHA OPTICAL GOODS

small decorated cases is specially attractive.

E. Francillon & Co. (Longines Watch Factory), have all kinds of movements in all kinds of cases—gold, silver, oxidized silver, oxidized steel and small enamels. Two large gold cased watches bear in colored enamels the coats of arms of the Argentine Republic and Mexico respectively. There is a fine line of 18 and 16 size movements. A large number of medals, including the Grand Prix, Paris, 1889, attest the superiority of the watches shown.

*(To be continued.)*

**World's Fair Prize Winners  
Exposition.**

THE public of New York and vicinity who are unable to attend the World's Fair in Chicago, are to be given an opportunity to see some of the best exhibits, those which have taken the prizes, through the efforts of the Manhattan Industrial Exhibition Co., who propose to hold an exhibition in the Grand Central Palace, New York in January next.

The object of this exposition is to reproduce, as far as practicable, the prominent and most attractive exhibits at the World's Columbian Exposition. The Grand Central Palace, with its 400,000 square feet of floor space, has been secured for the purpose. Here an opportunity will be offered those New York firms who for one reason or another did not participate in the World's

Fair, to make an exhibit and display their goods, to perhaps as great if not greater advantage than at Chicago. It is proposed to fix the price of admission at the popular figure of twenty-five cents, which alone ought to be sufficient inducement to attract many thousands of people. Further information in regard to the exposition can be obtained by addressing the office, 122 W. 23d St., New York.

**Additional Features of the  
Ansonia Exhibit.**

AMONG the features of the exhibit of the Ansonia Clock Co., additional to those already described in previous numbers of THE CIRCULAR, are the following:

Some magnificent Barbedienne bronzes are shown in quaint designs, each of which has its special attractiveness. The line of bronze and silver goods in all its details shows the perfection to which the art has attained in this country. Wooden cases of varying designs and uses embellish the north and east wall and a portion of the central exhibit, the balance of the top part being devoted to a fine line of cabinet clocks, a number of which are richly carved and artistically decorated with bronze.

Clock and mantel ornaments are shown in all metals and finishes in the north end of the central case, and at the other are full lines of nickel goods and novelties. A fine

display of iron goods occupies the east side of the exhibit. Onyx clocks with gold ornamentation and art pieces in bronze and silver occupy the south case. Seven hinge hall clocks tick away the hours in various parts of the exhibit.

The designs selected in each line are of a high order and the attention bestowed upon the exhibit by visitors at the Fair is a marked tribute to the character of the exhibit as a whole.

The Self-Winding Clock Co., 26 Broadway, New York, have issued an unusually pretty pamphlet entitled "What is Standard time?" the object of which primarily is to aid in spreading a more general knowledge concerning the time service of the United States. The letter press consists of a reproduction of the article, "The United States Government System of Observatory time," by Lieut. Hiero Taylor, U. S. N., in charge of the Government Time Service, specially prepared for publication in THE JEWELERS' CIRCULAR of February 1890. The article is reprinted by the courtesy of this journal. Adjunctive to this article are dissertations on the Western Union Telegraph Co. and on self-winding clocks.

The King of Siam wears a gold hat weighing twenty-seven pounds. When His Majesty talks through that hat whatever he says must have weight. — *Boston Transcript*.

**DIRKSEN SILVER FILIGREE CO.,**

MANUFACTURERS OF

**STERLING SILVER SOUVENIR SPOONS.**

**Napkin Rings, Trays, Vases, Card Cases.**

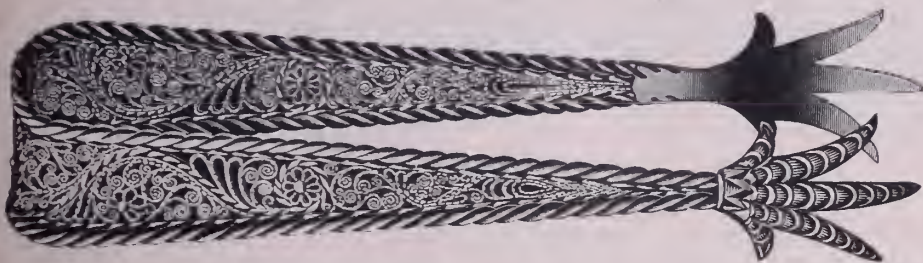

SPECIAL DESIGNS  
AND  
PRESENTATION PIECES  
MADE TO ORDER.

See our Exhibit, Section N, Manufactures and Liberal Arts Building, World's Fair, Near Tiffany's.

Send for our New Catalogue and Price List.

**FREEPORT, ILL.**

MOSELEY & COMPANY, ELGIN, ILL., would call your attention to the fact that they had planned to have an exhibit at the World's Columbian Exposition, and after many delays had space assigned, not where they expected it, but in Machinery Hall. During this time orders came in thick and fast, and our stock was so near exhausted that we could not make (to us) a satisfactory exhibit. Though working fifty men and making overtime we are still struggling to catch up with our orders. And still they come. We intend to have a fair exhibit with all the jobbers in Genuine Tools and Materials in Chicago for your inspection, and those wishing to learn the HOW to do any particular thing on the Moseley Lathe or any of its attachments, can do so by calling at the Chicago Watchmakers' Institute, No. 701 Masonic Temple, where the management will be pleased to give you a practical showing of the operation—which may be worth dollars to you, and other schools you may visit will be pleased to do the same.

Present your card, make known your desires, and you will be cordially received.

Yours truly,

**MOSELEY & CO,**



Send for this slip and new Catalogue.

## The Ceramic Exhibit of Leon J. Glaenger & Co.

THE connoisseur of past ages could he but look upon the great Exposition of the present, would bow the knee to those masterpieces of ceramic art shown in the French section. Among the beautiful pavilions of the French china court the vase exhibit of Leon J. Glaenger & Co., 80 Chambers St., New York, stands pre-eminent. It is in form an open court with the broad side to a wide avenue. Three sides are fitted with shelves and counters for the display of wares, and from either end at the front extend counters, with the main entrance in the center.

In the center of the main entrance stands

high with the corner of brocatelle marble and panels of onyx. Across the centers of the panels are  $1\frac{1}{2}$  inch scroll gilt bands with three circular medallions of *cloisonné* in each panel. The cap, an inch brocatelle marble slab, is overlaid by a half inch, square slab of Algerian onyx. The figures extend an inch beyond the top of the column and the cap an inch over the frieze. The piece stands as a leader in onyx work.

Standing on this beautiful pedestal is a \$2,000 underglaze, soft paste Sèvres vase 42 inches in height. This has a square base of mercury gilt bronze 2 inches high, on which the vase and pedestal revolve. The pedestal or stand that supports the vase is of white Sèvres with gilt rope about the base and overlaid with gold decoration. The stand is concave, 9 inches high, 9 inches

marked by every passer-by and praise is bestowed upon the figure painting of the artist and the graceful outlines, and rich color work of both base and pedestal.

Directly to the rear is a vase on the same order with a larger bowl but of less height. This is flanked on each side by a hard paste Sèvres vase with rococo porcelain side handles. There are over seventy-five vases in the exhibit and each is a work of art. In size from 12 to 36 inches and in colors from the dark Sèvres blue and brilliant Empire green to the more delicate tints of pink and blue, the exhibit comprises the most desirable and salable wares in this line.

An item of special notice is a cabinet of Dresden lace figures (The Return from the Ball) wherein the lady, in full ball costume with lace flounces, bids adieu to her escort

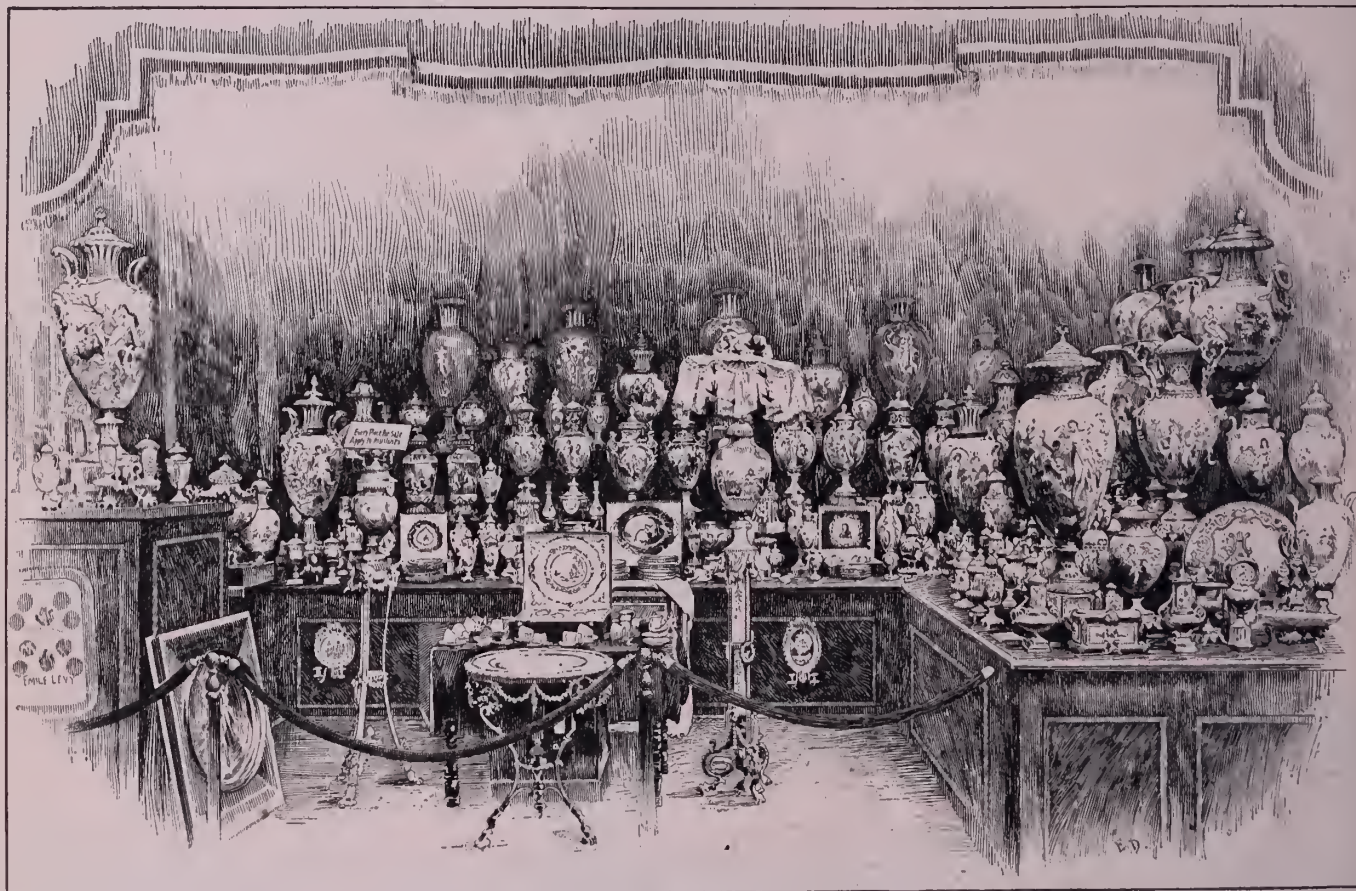

PAVILION CONTAINING THE CERAMIC EXHIBIT OF LEON J. GLAENZER & CO.

a beautiful slender pedestal of Algerian onyx supporting an Empire vase of finest Sèvres. The pedestal has a base twelve inches square with corners of red brocatelle marble and center plate of Algerian onyx in its beautiful shades of mottled greens and pinks. The base is surmounted by a cap of French gilt bronze in dull and polished finish with panels of *cloisonné* enamel in each side. From this rises a column of Algerian onyx tapering outward, six inches square at the base and eight inches at the top, the column rising to a height of three feet. At the smallest part in the center of each side are ornaments of *cloisonné* enamel with French gilt corners terminating in tassels. Then come an inch mold of gilt, a two inch mold of onyx and brocatelle marble, and a frieze six inches

across the base and 4 inches at the top. The concave part has an Empire-fluting in gold bronze. Above this is a rococo chrysanthemum leaf gilt cup, in which rests the graceful Sèvres body. The front of the vase body bears a magnificent painting in most exquisite colorings by A. Tougeron, representative of Music. The principal figure is of a woman playing a harp, while above are female forms in slight drapery floating in ethereal blue.

The body is crowned by a neck of Empire fluted white Sèvres with a cover of gold. On either side is a mercury gilt bronze handle extending from the cover to the center of the body. These are fluted bronze reeds entwined with gilt bronze ribbons. The rare beauty of the piece is re-

as she enters her sedan chair attended by her pages.

Interspersed between the vases are fine decorated plates in all shades from Empire green to cream in many designs. At front of the back counter are inkstands and trays, candlesticks and trays, bonbonnières, cups and saucers in Empire, Chantilly and old fashioned tin dipper shapes and many small wares popular with retail jewelers. Lamps are shown from the small Princess to the large vase lamps in all shapes decorated by leading artists. Handsome jardinières or ferneries in oval and round shapes with gilt rim and feet have in panels beautiful Watteau paintings. Taken all in all the exhibit is full of interest to connoisseurs and the leading jewelry trade.



## Chicago.

Visitors at the Chicago Jewelers' Association rooms last week were:

James W. Anderton, Dayton, O.; John C. Eberhardt, Dayton, O.; I. Peine, Wharton, Texas; Willis B. Musser, Lancaster, Pa.; Luther D. Platt, Elizabeth, N. J.; Ed. Ducas, Indianapolis, Ind.; Paul H. Rosenthal, Philadelphia, Pa.; J. E. Mitchell, Fort Worth, Texas; F. Cawker, Tilluride, Col.; George C. Mosher, Chattanooga, Tenn.; H. W. Carroll, Bennettsville, S. C.; J. A. Martin, Paris, Texas; Chas. C. Buder, Columbus, Miss.; C. W. Havlicek, Crete, Neb.; H. Daur, New York; Sidney Smith, Pine Bluff, Ark.; John Sumner, Iowa City, Ia.; Roy Haish, Vinton, Ia.; H. G. Davis, London, Eng.; A. Byford, London, Eng.; Jacob Dorst, Cincinnati, O.; W. O. McReynolds, with Baldwin & Co., St. Joseph, Mo.; N. S. Plank, Iowa City, Ia.; E. Ainsworth, Pittsburgh, Pa.; F. J. Ives, Norwich, N. Y.; C. O. Leach, McCook, Neb.; R. C. Beman, Chester, S. C.; J. T. Corwin, Union City, Mich.; Adolph Krebs, McKeesport, Pa.; Frank Binder, Greenville, Miss.; G. C. Holz, Philadelphia, Pa.; A. S. Johnson, Hannibal, Mo.; E. C. Stalm, Chester, S. C.; E. W. Furin, Oakland, Neb.; W. B. Saunders, Huntington, Ind.; Fred. C. Saunders, Bedford, Ind.; Charles Lindhorst, Philadelphia, Pa.; Fredk. Leigh, Hartford, Conn.; Geo. W. Birnbaum, with Ehrlich & Sinnock, Newark, N. J.; S. W. Froelichstein, of Henry Froehlich & Co., New York; Professor M. Stein, New York; Isaac Deller, Mineral Point, Wis.; N. H. Loomer, Waterloo, Ia.; Geo. R. Clark, St. Cloud, Minn.; J. H. Hardick, Fairport, N. Y.; A. R. Knights, Dubuque, Ia.; Geo. Knights, York, Neb.; Henry Austin, Belton, Tex.; Daisy Hauser, Milwaukee, Wis.; Irma Hauser, Milwaukee, Wis.; Frank D. Day, Duluth, Minn.; Herman Bruckner, Evansville, Ind.; John Nicholson, Centerville, Ia.; F. C. Babbitt, Wilson Bros., Boston; E. C. Stone, Rock Falls, Ill.; Nathan Adler, Lexington, Ky.; H. S. Crane, Dayton, O.; Ed. Estep, Marion, Ind.; M. Wittelshofer, Grand Forks, N. D.; W. S. Orwin, Rushville, Ind.; Phil. W. Haberman, St. Louis, Mo.; A. C. Newburgh, St. Louis, Mo.; Geo. F. Morris, London, Ont.

Buyers and visitors in Chicago and at the World's Fair last week included:

Edw. Akers, Baltimore, Md.; Hal B. Smith, with Boyne & Badger, Charlotte, N. C.; C. W. Rickarts, Rochester, N. Y.; D. O. Inglis, Montreal, Que.; O. A. Peirce, New Orleans, La.; E. B. Weser, with E. Nash, St. Louis, Mo.; Wm. Mitchell, Amsterdam, N. Y.; Edward R. Roehm, Detroit, Mich.; D. Marx & Son, St. Paul, Minn.; Huston Jackson, Williamsport, Pa.; E. O. Zuern, Shamokin, Pa.; W. J. Durfey, Cross & Beguelin, New York; F. G. Hart, Salem, Ill.; John Nicholson, Centerville, Ia.; C. F. & L. Uhl, Cleveland, O.; F. H. Delano, Russel, Ia.; Geo. W. Jatho, Defiance, O.; Theo. Lindhorst, Phil, Pa.; M. S. Melzer, Cleveland, O.; E. O. Faren, Oakland, Neb.; T. F. Butcher, Brandon, Man.; Wm. R. Abbott, & Co., Decatur, Ill.; E. P. Percival, Philadelphia, Pa.; S. E. Eichenlaub, So. Chicago, Ill.; P. E. Hoshaw, Hebron, Ia.; Mr. Straus, Belleville, Ill.; N. M. Pray, Lansing, Mich.; Chas. H. Lamson, Portland, Me.; Frank Binder, Greenville, Miss.; Rudolph H. Kirschker, Philadelphia, Pa.; M. D. Gallagher, New York; Ed. Ducas, Indianapolis, Ind.; McKee & Schunck, Celina, O.; A. Sumner, Iowa City, Ia.; Mr. Anderton, Dayton, O.; R. Harris, Washington, D. C.; Zerweck Bros., St. Louis, Mo.; Geo. H. Waterhouse, with G. H. Taylor & Son, Pawducket R. I.; Minnette Worley, with T. R. J. Ayres & Sons, Keokuk, Ia.; C. Strouse, Pottsville, and Shenandoah, Pa.; R. J. Hendershott, Hastings, Mich.; Mr. Korfhaze, Racine, Wis.; W. S. Fawcett, Xenia, O.; Richards & Park, Colorado, Tex.; Jas. A. Nelson, Decatur, Alabama; John Prochaska, Toledo, O.; J. M. Boner, with Bitterman Bios., Evansville, Ind.; Moritz Rohrig, Leipzig, Germany; J. D. McGeah of R. T. McGeah & Son, Pittsburg, Pa.; August Bauman, New Orleans, La.; Henry G. Goldschmidt, with T. Kircher, Davenport, Ia.; Joseph Jerger, Thomasville, Ga.; I. Wechsler, San Francisco, Cal. Fred W. Giesemann, Macon, Mo.; I. B. Buzby, Philadelphia, Pa.; H. D. Folsom, Rock Island, Ill.; Wm. T. Nicoll, with J. G. Dillon & Co., Wheeling, W. Va.; A. L. Miller, Malta, O.; L. S. Parsons, Waterloo, Ia.; Julius H. Albers, Washington, D. C.; Fred W. Nagel,

Paducah, Ky.; M. H. Douglas, Russinville, Ind.; Charles C. Buder, Columbus, Miss.; F. E. Ladd, with the A. L. Delkin Co., Atlanta, Ga.; Arthur F. Smith, Max Meyer & Bro. Co., Omaha, Neb.; T. W. Kibbee, Drayton, N. D.; S. Smith, with M. Parse & Co., Pine Bluff, Ark.; Frank Byrd, Memphis, Tenn.; C. A. Sager, Promise City, Ia.; Alfred Lemoine, Fort Plain, N. V.; L. Levy, Syracuse, N. Y.; C. B. Harris, with W. S. Shuttler & Son, Dallas, Tex.; M. H. Loomer, Waterloo, Ia.; Nathan Adler, Lexington, Ky.; J. R. Lasey, Plymouth, Ind.; John Tenner, St. Louis, Mo.; J. M. Washburn, Celina, O.; R. C. Bernau, Chester, S. C.; Wm. Fink, Cincinnati, O.; Henry Dehnel, Sandusky, O.; C. Wright, with F. W. Spangenberg, Kingston, Ont.; F. L. Trepagnier & Bro., Plaquemine, La.; E. C. Stahn, Chester, S. C.; W. S. Orwin, Rushville, Ind.; R. E. King, Hawkinsville, Ga.; Wm. O. Nelson, Neenah, Wis.; Ed. Hoke, Fort Recovery, O.; Edw. C. How, La Porte, Ind.; W. E. Sanders, Forsyth, Ga.; A. R. Peters, Eureka, Kan.; H. D. Folsom, Rock Island, Ill.; B. Kersting, St. Louis, Mo.; Wm. Hunt, Uniontown, Pa.; Chris. Strobel, Waterbury, Conn.; F. J. Ives, Norwich, N. Y.; J. H. Potts, Lyon, Ia.; M. Hendelman, Towanda, Pa.; Alfred D. Brown, Brownsville, Wis.; B. K. Maxfield, Iroquois, S. D.; Paul Fliuchs, St. Louis, Mo.; J. W. Turrell, Longmont, Cal.; E. E. Prentiss, Vernon, N. Y.; J. H. Lynch, Greenville, O.;

R. A. McEhee, Charleston, S. C.; F. Wm. Becker, Canal Winchester, O.; Fred J. Scott, Lebanon, Mo.; W. H. Ives, Oneonta, N. V.; H. C. Thompson, Manston, Wis.; Harry B. Carswell, Kansas City, Mo.; W. B. Sanders, Huntington, Que.; R. L. Fox, Edgefield, S. C.; N. S. Plank, Iowa City, Ia.; Robt. Saloch, with Gerh. Eckhardt, St. Louis, Mo.; J. E. Talley, Frankfort, Ind.; H. E. Norris, Culpepper, Va.; Willis B. Musser, Lancaster, Pa.; J. U. Weber, Cascade, Ia.; John A. Kinsler, Philadelphia, Pa.; L. R. Hapgood, Foxboro, Mass.; F. B. Cole, O'Neill, Neb.; Albert H. Bonnett, Columbus, O.; C. W. Havlicek, Crete, Neb.; E. J. Huber, Booneville, Mo.; J. D. Hughes, with Louis A. Scherr & Co., Philadelphia, Pa.; H. L. Eyster, Navarre, O.; James Lees and wife, Philadelphia, Pa.; James Dimond Hughes, Phoenixville, Pa.; W. E. Reed, Kenosha, Wis.; J. H. Williams, Milwaukee, Wis.; J. Wallace, with Pearce, Kursh & Co., Philadelphia, Pa.; Morgan A. Peters, Allentown, Pa.; Ed. L. Jones, Columbus, O.; Thos. H. McKinley, Easton, Pa.; L. T. Smith, Lexington, Neb.; U. Tessot, Coal Gate, I. T.; Wm. H. Upton, Medway, Mass.; Edw. Sickles, Philadelphia, Pa.; Joseph Oechsle, Brooklyn, N. Y.; James B. Roberts, Philadelphia, Pa.; F. F. Hallett, Minneapolis, Minn.; N. C. Neville, Conneautville, Pa.; R. Frank Barr, Martinsburg, W. Va.; Chas. F. Billau, Cedar Rapids, Ia.; Ike Rosenbaum, Mt.

## RECEIVER'S SALE.



ENTIRE Stock of Giles, Bro. & Co. Fourth Floor Masonic Temple, consisting of Diamonds, American and Swiss Watches, Jewelry, Silver and Plated Ware, Tools, Materials, etc. will be sold in lots to suit the purchasers, at large reduction from original cost price.

An unusual chance for live Jewelers to obtain bargains.

W. H. GLEASON, Receiver.

July 14th, 1893.

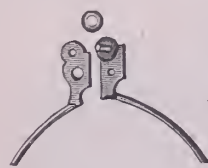

Racine Jewelry Mfg.  
CO.,  
SPECTACLE TEMPLE  
WASHERS,  
Gross in a Bottle, 25c.  
For Sale by Dealers in Jobbing Materials

ESTABLISHED 1879.

### JEWELERS.

We guarantee to sell you Sterling Silver Flat Ware at a less price than any other manufacturer, and give you newer designs. We will increase your profits if you will let us. Is it not worth trying?

OVAITT & WARNER, Silversmiths,  
PORTLAND, OREGON.

G. W. HOOK,

MANUFACTURING JEWELER,

149 and 151 State Street,

Chicago, Ill.

INSPECTION BY THE VISITING TRADE INVITED.

Vernon, Ind.; C. D. Kent, New York; R. C. Glover, Dallas, Tex.; A. Z. Housley, Stonington, Ill.; J. M. Goldberg, St. Paris, O.; H. D. Folsom, Rock Island, Ill.; H. Conger, Wellsville, O.; Geo. A. Clark, Lorain, O.; Chas. Gilmore, Kenton, O.; A. M. Leibman, with E. P. Reichhelm & Co., New York; F. F. Bonnett, Columbus; G. H. Daniels, Kearney, Neb.; R. Wood, Duluth, Minn.; I. Fox, Hartford, Conn.; W. E. Ried, Kenosha, Wis.; Isaac Brilleman, Albany, N. Y.; F. Boos, Rochester, N. Y.; L. B. Mather, Washington, Pa.; B. Baker, Washington, Pa.; Dougherty Bros., Logan, Kan.; H. W. Gilmore, Englewood, Ill.; G. H. Goggins, Lawler, Ia.; A. R. Gray, Indianapolis, Ind.; A. C. Roebuck, Minneapolis, Minn.; J. Weinmann, Philadelphia, Pa.; H. J. Neuberger and wife, Cairo, Egypt; A. H. Wentz, Westminster, Md.; Herman Bruckner, Evansville, Ind.; T. A. Mauch, with Baylers, Bros., Waukon, Ia.; Mooney & Ward, Grand Rapids, Mich.; M. Fried, Milwaukee, Wis.; A. W. Radde, Cleveland, O.; H. P. Hall, Wellington, Kan.; F. J. Cross, Cambria, Wis.; W. G. Gould, Glencoe, Minn.; Derooy Bros., Pittsburgh, Pa.; G. W. Brunner, Marble Rock, Ia.; J. A. Kester, Paris, Ill.; Edw. H. Herbein, Philadelphia, Pa.; Lee Moss, Owensboro, Ky.; R. G. Fuller, Chesaning, Mich.; J. H. Potts, Lyons, Ia.; August Bruder, Fort Wayne, Ind.; Nicholas J. Myers, with F. W. Sim & Co., Troy, N. Y.; F. Walter Stewart, with E. H. Holter, Oberlin, O.; John F. Little, Philadelphia, Pa.; W. J. Rock, Milwaukee, Wis.; D. G. Crow, Fort Clark, Texas; Joseph G. Pavian, Minneapolis, Minn.; H. F. Barker, Churdan, Ia.; W. D. Burk, Black Rock, Ark.; Ezra L. Valentine, with N. B. Levy & Bro., Scranton, Pa.; H. Capron, Eaton Rapids, Mich.; Yager Bros., Calmar, Ia.; L. F. Maple, Chariton, Ia.; G. F. Hahneman, Buffalo, N. Y.; D. Bixler, Berne, Ind.; W. W. Whiteside, Liberty, Mo.; Isador Auer, with A. R. Brooks, Jewelry Co., St. Louis, Mo.; Clarence H. Shafer, Cobleskill, N. Y.; E. H. Dutter, with the Webb C. Ball Co., Cleveland, O.; D. R. Jenkins, El Paso, Ill.; R. E. Burkett, Jr., Lansing, Mich.; J. M. Dikob, Charleston, Ill.; A. R. Peters, Eureka, Kan.; E. D. Beardsley, Harvard, Ill.; Raby Bros., Tacoma, Wash.; Austin & Hunter, Belton, Texas; S. E. Diball, Youngstown, O.

Rahy Bros., Tacoma, Wash., purchased goodly stocks the past week and paid cash in gold.

R. Lange, of A. Lange & Sons, Glashütte, Germany, left Chicago for the Fatherland Saturday week.

Wendell & Co., 67 Washington St., have made large reductions not only in flat ware but in fancy pieces.

George C. Mosher, Chattanooga, Tenn., is taking of optics at the Chicago Ophthalmic College and Hospital, 607 W. Van Buren St.

Johannes Dürrstein, senior partner of Dürrstein & Co., watchmakers, Glashütte, Germany, left Sunday for New York on his return from a visit of inspection at the Fair.

C. F. Whiting, Jr. left Wednesday for a visit to Kansas City, St. Louis, Indianapolis, Cincinnati, Columbus, Cleveland and Detroit in the interests of the Crescent Watch Case Co.

Charles H. Pfeil, formerly of Pfeil & Bredt, opened up his factory at 182 State St. Monday. The shop is fully equipped with improved machinery, and accommodations are made for sixteen men.

The Napoleon watch recently described in THE CIRCULAR, has been secured by Patek, Philippe & Co., and occupies a prominent place among the historical watches exhibited by the firm in the Patek, Philippe & Co. pavilion of the Swiss section.

A. R. Knights and daughter of Dubuque, Ia., and George Knights, of York, Neb., brothers of C. H. Knights are at the Fair. The two sisters of Mr. Knights have visited Chicago the past two weeks returning to the family home at Wardsboro, Vt., Thursday.

The exhibit of Boucheron, the great Paris jeweler, was installed Monday in the centre pavilion of the French bronze court, M. Boucheron personally supervising the installation. With the \$4,000,000 exhibit of the house of Boucheron and the \$2,000,000 display of the house of Veveer as the centers of attraction the bronze court is crowded, from morn to night.

The Council of Administration drew up an order Wednesday to prevent the sale of goods by foreign exhibitors and others in the Exposition buildings until 10 per cent. of the invoice value of the exhibitors' stock has been paid or provision made for its payment. The entire business of sales will be stopped short if the Columbian Guards have to be called in to exercise force. It is estimated that in Manufactures building alone there are 150 unauthorized stands for the sale of goods. These come in direct competition with persons who are paying the Exposition for the right to sell. When the order goes into effect it will close up over 200 places, if it closes any at all.

The election of officers of the Retail Watchmakers' and Jewelers' Association of

Illinois will take place at the October meeting. At the recent meeting a form of warrant was adopted for watchcases and clocks. The warrant for cases is to be placed between the case and cap; that for clocks on the back. It reads to the effect that the Retail Watchmakers' and Jewelers' Association of Illinois recommend the wares bearing the label and warrant the goods to be as represented. The authority to make out certificates is vested in the secretary of the association and warrants will be issued to members of the association only. The purpose is to assure a customer as to the quality of the goods offered. It is proposed to make a test of these warrants in the State association before presenting the plan for the approval of the National body.

**THE PLANCHAMP & BECKER CO.**  
Makers and Repairers of  
**WATCH CASES,**  
Gold and Silver Plating —  
— of Watch Cases a Specialty.  
UNEXCELLED FACILITIES.  
63 and 65 East Washington St., Chicago.

**PARSONS : SCHOOL**  
— FOR —  
**WATCHMAKERS,**  
PEORIA, - - - ILL.  
Send for Circular and Terms.  
**PARSONS & CO.**

**EST. 1870.**  
  
**DR. PETER HENRY,**  
SPECIALIST IN  
**WATCH • CASE • DISEASES**  
Key Winders changed to Stem Winders.  
Hunting Case: changed to O. F.  
English Cases changed to fit American movements  
Can be cured at **53**  
**Longworth St., Cincinnati, Ohio.**

**CHICAGO WATCH TOOL CO.**  
SPECIAL MANUFACTURERS OF  
JEWELERS' MACHINERY,  
WATCH MAKERS' and  
JEWELERS' TOOLS  
Etc.  
52 MADISON STREET  
CHICAGO  
TOOLS MADE TO ORDER

**IRONS & RUSSELL,**  
(SUCCESSORS TO CHARLES F. IRONS.)  
MANUFACTURERS OF  
**SOLID GOLD EMBLEMS ROLL PLATE**  
PINS, CHARMS AND SOLID GOLD RINGS.  
102 Friendship Street, - - Providence, R. I.



**GIBSON HOUSE,**  
CINCINNATI, OHIO.  
ABSOLUTELY FIRST-CLASS AMERICAN PLAN HOTEL \$3.00 PER DAY  
Extra Charge for Parlors and Rooms with Bath attached. The unequalled advantages in central location, liberal management, modern appointments, experienced service and perfect cuisine, have permanently established the Gibson House as The Most Popular First-Class Hotel in Cincinnati.  
AMPLE VAULTS FOR THE PROTECTION OF VALUABLES  
**THE GIBSON HOUSE CO.,**  
H. B. DUNBAR, President and Manager.

**Pacific Coast Notes.**

J. E. Russell has opened a new jewelry store in Monrovia, Cal.

C. J. Morrison has sold out his store at Azusa, Cal., to C. W. Lyman.

L. A. Stephens, Roswell, N. M., is having built a stone business building on Main St.

It is reported that J. E. Dodd, South Riverside, Cal., is closing out his business.

Robert Hetzel, San Francisco, has retired from the jewelry business, and will go to Europe to live.

C. Saladin who has been carrying several lines at Ventura, Cal., will hereafter deal in jewelry exclusively.

S. Albin, a jeweler of Philadelphia, Pa., has removed to Los Angeles, Cal., and opened a jewelry store at 113 S. Broadway.

J. E. Fuhle, San Francisco, has closed his branch store in San Bernardino, Cal., and will move the entire stock to Alameda, Cal., where he will open a new store.

F. I. Muhlen, 1,911 Mission St., San Francisco, has retired from business for the present. He is working on an invention which takes most of his time.

Snow, Field & Harvelle, San Francisco, have dissolved partnership, E. S. N. Field retiring from the firm, which will hereafter be known as the Snow-Harvelle Jewelry Co.

W. K. Vanderslice, San Francisco, is making for Secretary Merry of the Hueneme Ventura Co., Cal., Fair, six silver spoons weighing three ounces each with "Hueneme Fair, 1893," chased on them. The spoons will be awarded as prizes in a baby show.

S. Salomon, 218 Post St., San Francisco, has filed a petition in insolvency. His liabilities are \$6,980; assets, \$1,010. He owes \$1,150 to John S. Bournan, \$1,200 to Oppenheimer & Fieres, \$800 to J. Buss, \$750 to J. Behl, and smaller amounts to numerous other creditors.

Geo. J. Southwick, one of the most prominent travelers on the coast, has written a comic song entitled "Since Michael Learned to Skate," which has just been published by Broder & Schlam, 26 Stockton St., San Francisco. The words of the song are humorous, while the music is novel and pretty. It is dedicated to our trade.

Vantilburg & Davison, Phoenix, Ariz., have exceeded anything thus far attempted in souvenir spoons that embody certain characteristics of the country. The spoon represents a Pima Indian woman supporting on her head an olla (pronounced o-yer) which rests upon a twisted wisp of bear grass, and awaiting a customer for her wares. This is a scene that can be observed every day in the towns throughout Arizona. The olla is a large jar or bowl of pottery for containing and cooling drinking water. It is altogether an Indian invention. Vantilburg & Davison have made a hit with their happy idea.

W. L. Barre, Seattle, Wash., some days ago caused the arrest of Thomas Carroll and Charles Powers, charging them with

**FLY BACK AND SPLIT SECONDS,**

**ACCURATE  
AND  
RELIABLE.**



**PRICES  
MODERATE.**

**IN SILVER, FILLED AND GOLD CASES.**

**A. WITTNAUER,** Manufacturer and Importer,  
19 MAIDEN LANE, NEW YORK.

**MARTIN MAYER,**  
Manufacturing Jeweler,  
(MAINZ, Germany,)

FACTORIES: MAINZ, PFORZHEIM, FLORENCE, (ITALY).

Original Manufacturer of the well-known Cut Silver Articles.

*Silver Filigree, Coral Goods, Garnets, Turquoise, Pearl, and all other kinds of Jewelry. Silver Bric-a-Brac in Every Style, Silver Fancy Clocks, Souvenir Spoons.*

FIRST HAND FOR EUROPEAN NOVELTIES IN THE JEWELRY LINE.

SPECIAL EXHIBIT AT WORLD'S FAIR, CHICAGO.

Represented by Mr. L. Maynz, 523 Broadway, New York.

**Enterprising Jewelers Catch On!**

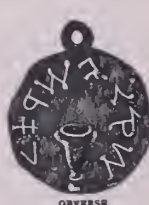

OBVERSE



REVERSE



BACK

**Jewish Sheckel, Masonic Mark or Pocket Piece.**  
THE LATEST AND BEST SELLING NOVELTY.

The mark is struck in coin silver; by using either the obverse or reverse of the coin, the back being the same in either case, and permitting of the purchaser's name, blue lodge, chapter and individual mark, with date of same being engraved thereon, as shown in cut above.

Price, without engraving, ONE DOLLAR. Engraved Mark, Dates, etc., 75c. EXTRA.

Liberal Discount to the Trade.

**CHAS. G. WILLSON, MANUFACTURING JEWELER, READING PA.**

stealing three gold rings from his store. Powers is out on bail pending examination.

W. P. Saneger, Victoria, B. C., has assigned to James Hastis.

A. G. Pernham, late of Kelso, B. C., will embark in the jewelry business at Spokane, Wash.

Shawler & Miller, Pullman, Wash., have dissolved, Levi B. Miller continuing the business.

W. H. Pennock and S. Lowe have gone into the manufacturing jewelry business in Victoria, B. C.

Joseph Mayer, of Rumpf & Mayer, Seattle, Wash., has returned from a business trip to Oregon.

J. W. Minnich's jewelry store, Cheney, Wash., was recently burglarized of \$125 worth of goods. There is no clue to the thieves.

Excitement still continues rife over the opal beds in Idaho, and the fields have been pretty well absorbed by prospectors. Good finds are occasionally made, one prospector who arrived at Tacoma, a few days ago showing a fine flawless opal of 250 karats. The fields will be systematically worked this Fall.

### Minneapolis and St. Paul.

J. H. Bayliss, Minneapolis, has given a chattel mortgage for \$225.

Thomas Gaskill, St. Paul, has given a chattel mortgage for \$1,268.02.

I. B. Miller, Chicago, called on the Twin Cities retail jewelers the past week.

J. B. Hudson, Minneapolis, is remodeling and decorating the interior of his store in elegant style.

J. Petranek, Avoca, Wis., has removed to Minneapolis and has opened a store at 234 Cedar Ave.

William Krohn, Annandale, Minn., spent several days on business in the Twin Cities, the past week.

Mr. Benjamin, of Benjamin & Co., Minneapolis, has gone on a two weeks' trip to Chicago and the east.

Louis Pavian, St. Paul, and Joe Pavian, Minneapolis, have returned from a protracted visit to the World's Fair.

Jos. W. Dupont, Minneapolis, who recently assigned, is selling off his entire stock at auction, conducting two sales daily.

George Hartman, with John Pfister, St. Paul, last week returned from a three weeks' vacation spent at his former home in Mankata.

Clarence Schleicker, formerly with the Minneapolis Jewelry Mfg. Co., Minneapolis, has gone to Chicago with the intentions of locating himself there permanently.

E. B. Woodward & Co., Morris, Minn., have started a new store at 204 Washington Ave. S., Minneapolis. This firm are conducting six stores throughout the State.

### Omaha.

James Bergman, of the Sol. Bergman Co., left last week for a trip through Nebraska.

S. Jonassen will move on Sept. 1 from his present quarters at Farnam and 13th Sts., to 206 N. 16th St.

Max Reichenberg, watchmaker for Jno. Baumer, has returned from a two weeks' trip to Chicago.

Among the jewelers of the State who were in town the past week are: H. T. Fisher, Blair, O. C. Zinn., Hastings, and Alfred Whiting, Greta.

Very few traveling men are visiting Omaha these times. Among the few are: J. H. Hershfield, L. & J. Alder & Co., and Geo. W. Birnbaum, Ehrlich & Sinnock.

A. Mandelberg, who has been for the past ten years with Max Meyer & Bro. Co., most of the time as head salesman of the retail department, is about to open up for himself in a portion of the salesroom formerly occupied by the firm. He will keep a select stock of watches, diamonds and jewelry.

Nebraska was treated on Tuesday last to a very high wind storm which in some places developed into a small cyclone. In Omaha it did only slight damage to roofs and outbuildings in a few places. During its great fury the back door of Fred W. Brodegard's jewelry store was opened and the draft blew out one of his plate glass windows, but no great loss was sustained.

The Max Meyer & Bro. Co. are nicely settled in their new quarters on the corner of 11th and Farnam Sts. Adolph Meyer, accompanied by his wife, is taking in the World's Fair. A. Smith, manager of the wholesale department of Max Meyer & Bro. Co., and Mr. Persell, traveling salesman, accompanied by his wife, are in Chicago. The latter will spend a couple of months there and farther east.

"Kid" McCoy, accused of robbing W. G. Pollack, traveler for W. L. Pollack & Co., New York, of diamonds near California Junction last Winter, was safely lodged in Logan, Ia., Friday last and was arraigned before a justice of the peace for preliminary examination appearing in his own behalf,

and at his own request was granted a continuance of one week to prepare to answer to the charge of robbery.

The stock of the defunct firm of Shook, Patterson & Co. was offered for sale by the sheriff last Tuesday and was bid in by S. Jonassen for \$4,500. The court valued it at not less than \$5,000, and an order from the court will be necessary to allow it to be sold for less. The judge will give a decision some time this week. The stock cost the firm not less than \$16,000 and possibly as high as \$20,000. Mr. Shook has gone to New York to endeavor to redeem the stock.

E. A. Walter, traveling salesman for E. A. Dayton & Co., has just returned from a trip through western Iowa and Missouri. He reports the following new firms: A. N. Reeves, of Iowa City Ia, has opened up a branch in Centerville, Ia; J. S. Cunningham has opened in business in Tarkio, Mo.; Geo. Peters has opened a store in Tarkio, Mo.; Torres, Thompson & Co. have started a new store at Craig, Mo. Mr. Walter leaves again this week for a trip through Nebraska.

Abraham Prince died in this city last week, aged eighty-six years. He came from Amsterdam, Holland, and settled in Boston, Neb., where for nearly forty years he was engaged in the jewelry and optical goods business. During the rebellion he had the contract for supplying the army officers with field glasses, and the great war correspondent, Carleton Coffin, made favorable mention of his skill in several newspaper articles. He was quite a writer on Masonry, and his articles on the subject in the *Occident*, of New York, attracted considerable attention. His apron which he had worn for over fifty years, was buried with him. During his residence of ten years in Omaha he was not engaged in business.

The business of A. Hazy, Durango, Col., was ruined by fire a few nights ago. The insurance was \$2,000. The fire seems to have started in the central portion of the jewelry store among papers and catalogues stacked on the floor under the shelves, but its origin is a mystery.

## BLANCARD & CO.,

LATEST ROCOCO DESIGN IN GALLERY.



DIAMOND SETTINGS.

GALLERIES.

HOLLOW BALLS, ETC.

SEND FOR OUR CATALOGUE.

45 & 47 John St., New York.

### Louisville.

Mr. Montgomery and Mr. Russmann have both just returned from the World's Fair.

H. L. Seng, of Buschemeyer & Seng, has just returned from a trip to the World's Fair.

L. E. Ledman's large plate glass window was last week broken by the falling of an awning pole.

W. G. Pope and Geo. R. Caspari, with Wm. Kendrick's Sons left Saturday for Chicago to see the Fair.

H. R. Mitchell has gone into partnership with a Mr. Fickett, to sell tickets to the World's Columbian Exposition.

J. B. Girardet, of Irion & Girardet, accompanied by his family is in Chicago visiting the Fair, for two weeks.

Geo. Wolf, of Geo. Wolf & Co., has returned from New York and it is reported has got an extension of time from eastern creditors.

The stock of W. P. Brandenburg, damaged by the fire reported in THE CIRCULAR last week, is being sold at auction, which started Saturday.

T. J. Pottinger, of Rodgers & Pottinger, has given a mortgage to the Kentucky Title Co. for \$3,300 on property 47½ feet south side Jacob St. west of Brook.

Joe Cains who broke into A. Seigel's jewelry store was arraigned on the 16th and was bound over to await the action of the grand jury under \$500 bail.

M. Walter Vowels was robbed in broad daylight on last Tuesday morning of three gold and two silver watches. Mr. Vowels went into a back room about fifteen minutes, leaving no one in the store, and when he returned the watches were gone.

E. Ottenheimer has given two mortgages to S. S. Lieberman, one 21x9x12 feet south side Market St., west of Clay, \$3,000; the other one 21x9x12 feet south side Market St. west of Clay, \$3,000. S. S. Liebermann has also taken a mortgage on property of T. C. Jones, 25 feet north side Walnut St., east of 1st, \$2,200.

Hager & Hetsch who were some days ago affected by fire, as reported in last week's CIRCULAR, have moved just opposite the hallway from J. M. Reister on Jefferson St. Jos. Washle, the engraver, claims his loss was \$500, fully covered by insurance. He has moved across the street to the Norton Building. Adolph Goldstein, optician claims damage to the extent of \$1,500, but the insurance companies decline to give him more than \$610. He has moved to 534 N. 4 St.

### Detroit.

Ed. Roehm is in Chicago on business.

The jobbers close at 3 o'clock on Saturday afternoons.

The following Michigan country buyers were here last week: J. S. McLaughlin, Wyandotte; A. W. Kludt, Lennox; William

Ambler, Northville; Eugene Campbell, Pinckney; William Walthers, Wyandotte and August Marwede, Alpena.

J. L. Hudson recently added a stock of gentlemen's jewelry to his department store, corner of Farmer and State Sts.

The common council passed an ordinance last week which requires all jewelry and spectacle peddlers to pay a license of \$25.

Ralph Dewey, who recently entered the firm of Sturgeon & Co., will shortly be married to Miss Francis E. Linington, of Chicago.

The following employes of F. G. Smith, Sons & Co., are spending their vacations at the World's Fair: Jacob Teichner, Fred Burk, Charles Carp, and H. F. Baker.

William Harris, formerly with Wright, Kay & Co., is recovering from a serious illness. He states it as his intention to start a business of his own in a western town.

### Cincinnati.

Rube Hawkins, of C. Hellebush starts out on a northwest trip this week.

D. Schroder is on the sick list; all the firm's travelers are on the road.

Kretschmar & Schwoerer, diamond setters, have opened business at 161 Race St.

The sale of the stock, fixtures, etc., of H. F. & J. F. Terlau, Covington, Ky., was advertised to be sold to the highest bidder on Aug. 22.

B. S. Newman, of Frohman, Wise & Newman has recovered from an illness and will be on the road this week. Sig. Straus of the same firm has just returned.

The Wadsworth Watch Case Co. are running full time and turning out their usual out-put. They are filling orders regularly and introducing new designs. There is no prettier case than their new scalloped, sixteen size case.

### Syracuse.

Chas. L. Becker is spending a two weeks' vacation in the North Woods.

The Standard Watch Co. have called in their agents and shut down for a month.

Edwin E. Buszard, who has been very ill for the past ten days, is able to be about again.

George E. Wilkins left Thursday for Mt. Clemens, Mich., and Chicago. He will be absent three weeks.

Frank D. Enney will remove on Monday from his present location, 122 Vanderbilt Square to 210 Warren St.

H. Ward Dickinson, of Jos. Seymour, Sons & Co. returned Saturday from a two weeks' stay in Boston and vicinity.

Commissioner Perrenoud of the Swiss section left Chicago Monday and sailed yesterday for Switzerland. M. Perrenoud contracted malaria shortly after his arrival here, and his physician advised his immediate return. Arnold Hollinger, Swiss consul to Chicago has been appointed to the place. While M. Hollinger will be nominally Swiss Commissioner. M. Stiefel, M. Perrenoud's secretary, will act for him.

Samples showing the processes of manufacturing silver deposit ware have been added to the line shown by the Wymble Mfg. Co. at the World's Fair. An open salt cellar is shown as it comes from the bath with its heavy coating of silver. The outer surface has the appearance of unglazed china, but a slit cut in the metal reveals a polished inner surface. A wine glass shows the work after it has been buffed and polished, in which the article is completely covered with a silver coat with a V-shaped piece turned up to show the thickness of the deposit. A special feature with the factory is here shown, the production of a bright polish on the inside of the silver, a requisite when the silver is deposited on transparent glass.



## The Warren Eye Protector

(Patented Jan. 12, 1892, Feb. 21, 1893.)

Saves the Eyes From  
Dust, Wind, or Glaring Light.

Folds in a Compact Case, is

Comfortable, Durable,  
Water and Dust Proof.

Its large field does not obstruct the sight. No brittle substance to endanger face under sudden blows.

Oculists and Physicians Recommend it.

Travelers, Cyclists, Railroadmen,  
Horsemen, Motormen, Quarrymen,  
Pronounce It Indispensable for Man or Woman.

Ask your Dealer for it.

Colors, Clear, Smoke, Blue or Green. Black frames, 50c. Silver, 75c. Sent by mail on receipt of price. Manufactured solely by

**The Nous Verrons Company**  
P. O. Box 3273, Boston, Mass.

**CLEAN JEWELRY SELLS QUICK.**

Quarters' Cleaning Solution removes dirt and tarnish in an instant, makes stock like new and brings up diamond and stone work to a beautiful lustre. Solution can be used over and over. Highly commended by all who use it. Send at once \$1.50 for half gallon with full directions. References.

**W. F. QUARTERS, ELECTROPLATER,**  
139 EDDY STREET. PROVIDENCE, R.

ESTABLISHED 1837.

**GEO. O. STREET & SONS,**

MAKERS OF

Fine Rings, Lockets, Seals,

Sleeve Buttons and Links,

15 John Street, NEW YORK.

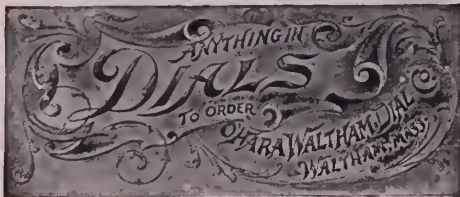

All the illustrations in this issue were made  
by

**W. H. BARTHOLOMEW.**

PHOTO-ENGRAVER,

18 SPRUCE ST., NEW YORK.

**Jules Jürgensen**

OF COPENHAGEN.

The reputation these watches have maintained for  
**Fifty Years** has never been equalled, being made  
on strictly scientific principles and no expense spared to  
give the **Best** results in mechanism and timekeeping  
qualities.

SOLE AGENTS,

**John E. Hyde's Sons,**

NO. 22 MAIDEN LANE.

To insure Publication of Advertisement in  
current week, copy should be received  
not later than Monday Night.

**OLDEST PUBLICATION**

Of all the Jewelry Journals.

**Jewelers' Circular Publishing Co.,**

189 BROADWAY, NEW YORK.

ESTABLISHED 23 YEARS.

**Correspondence.**

A DIAMOND MERCHANT'S VIEWS ON THE PRESENT COMMERCIAL CONDITIONS.

NEW YORK, Aug. 17, 1893.

EDITOR OF *The Jewelers' Circular*:

Opinions concerning the causes of the present financial status of the country and the theories propounded for the alleviation of the depressed and embarrassed conditions which now obtain are as numerous as leaves in Vallombrosa. Having perused with great interest your excellent articles and editorials on this subject, I trust that you will allow me a portion of your valuable space in order to express my ideas in relation to this much mooted topic.

Chief among the causes of the financial depression is the unwise and unpolitic speculation in lands on the part of a large number of merchants and a still larger number of professional speculators. This wild and untoward tendency of investing capital in the purchase of land has led to the sinking of great sums of money in enterprises which have proved barren of results. Statistics demonstrate that the growth of the west has not justified the excessive purchase of land. What was the result? The merchants and professional speculators beheld with consternation that their investments yielded no returns. This accumulation of capital was accordingly diverted from the healthier channels of productive industry, and naturally the wheels of commerce were clogged. All who are conversant with the reports of the commercial agencies will verify the assertion that a heavy percentage of the assets claimed by merchants, particularly in the west, consist of property representing inflated and fictitious values.

The distressing number of bank failures in the west was a consequence, inasmuch as these financial institutions readily supported these unhealthy and fruitless enterprises. Conservative and honest business men, however, who held aloof from these schemes, suffered by reason of not receiving the necessary assistance from the banks in time of legitimate need. As the banks were incapable of realizing on their securities and had their moneys locked up in the shape of excessive loans to speculative corporations, they were compelled to refuse the reasonable demands of the farmer and tradesman.

The present commercial stagnation can be readily understood if we review the methods employed by our merchants in beginning and building up their respective business interests. It has been shown that merchants taking advantage of a prosperous year, invested their surplus, or rather gain of capital, in enterprises of a character extraneous to their own legitimate calling, with the natural anticipation of reaping greater profits from their new ventures than they would otherwise receive in the regular course of their business. Hence the surplus capital involved in these foreign busi-

ness ventures precludes the more proper and advantageous method of increasing and enlarging their regular business, or of establishing a sinking or reserve fund to be used for future emergencies. Statistical reports tell us that ninety per cent. of the new commercial enterprises which spring up meet with disaster. We cannot attribute this to the limited resources of our country, as we have enough, yes, more than enough, to induce our people to invest their labor and capital in productive and fruitful enterprises. This country is so vast, so great in national strength, so generous and munificent in natural resources that it only requires us to utilize and develop the grand offerings which Nature thus bountifully bestows. Availing ourselves of these great opportunities, it is our duty to devote our untiring energies in building up a republic which will command the respect and confidence of our sister nations.

It is generally taught and believed that commercial stagnation is due in great measure to over-population. The sooner we rid ourselves of this erroneous idea, the better for us. Instead of being over-populated, this country is under-populated; for it stands to reason that with a more numerous population our strength will increase, our natural resources will be developed and we will be better fitted to compete with the rest of the world.

Another fallacious theory, widely accepted, is that commercial and financial depression is due to general over-production of commodities. The condition of over-production can only exist when the general wants of the people are satisfied. But we know to-day there are hundreds of thousands, nay, millions of our people who are in need of the very commodities which are proclaimed by the thoughtless as being already over-produced.

The question, then, forcibly presents itself: how can we find relief from the oppressive burden which now weighs us down? Our past experience has conclusively shown that the speculative tendency is a psychological characteristic of the American people. We are a nation inclined to expect quick returns from our investments which are speculative, rather than conservative. We are growing too rapidly. Instead of fortifying and strengthening the resources at our command, we are too impatient to await good results. With the trait dominant in gamblers, we distribute our resources into different channels at the expense of our most vital interests, thus causing a general weakness and debility. The majority of our business men have too many irons in the fire. They are enabled to carry out their schemes by our pernicious credit system. The time and terms extended to one another afford them the opportunity to yield to the temptation of assuming responsibilities which they cannot shoulder. Many of our business enterprises are started with very limited means. Accordingly, the merchants avail themselves of the too liberal

credit granted to them, and they readily incur obligations regardless of their ability to meet them. To be frank, we are inclined to speculate with "other people's money." To remedy this existing evil we must regulate the amount and terms of our credits in accordance with the financial standing of the merchant.

The speculative methods adopted by our banks in their transactions with their customers cannot be too severely condemned. It has been shown and is a public secret that they have recklessly loaned moneys on doubtful securities to the detriment of those mercantile customers whose guarantees are safer, but perhaps less profitable. It is also a noticeable feature that many of our most respected financial institutions concentrate their loans among corporations, whose dealings are of a speculative nature, to such an unwarranted extent as to leave a relatively small balance for the legitimate needs of our tradesmen. Indeed, a large number of bank directors are pecuniarily interested in these great corporations to which preferred and favored loans are made. In consequence of these unfair methods and as a result of this unequal distribution of loans, the farmer and merchant who are the backbone of this country, are hampered in their respective pursuits which benefit not only themselves, but the country at large.

We must also remember that the deplorable increase in cancerous mortgages and the consequent depreciation of farming lands have the tendency to ruin the agricultural industry which is the basis of general prosperity. It is impossible for the farmer to reap the fruits of his labor where his profits are reduced to a minimum by the unjust and oppressive charges of transportation and by the ruinous speculations of those interested in his products. It should be the aim and purpose of honest and proper legislation to check this spreading evil by enacting laws which will encourage, aid and assist the farmer in receiving reasonable profit for his labor. One of the most vital factors for bettering the condition of our farmers lies in the enactment of a national law granting the appropriation of ample funds for the improvement of the miserable roads throughout the country.

Having indicated the general causes of the commercial and financial stagnation, the question now presents itself, how to obtain relief from existing conditions. No one, we think, will deny that there is as much money now in this country as there ever was. How then has the stringency in the money market been brought about? It is due to the fact that immense sums have been hoarded up by the great money centers which the public cannot reach. However true it may be that private individuals and corporations have the right to withhold the circulation of their funds, it is the duty of the Government to relieve us. It must first repeal the Sherman bill. It should then coin the accumulated bullion which is lying idle in its vaults, and distribute this currency through its legal channels, the national

banks, so that our people can resume their respective pursuits which have been discontinued because of the lack of immediate funds. The public demand for commodities is as great as it ever has been, but there is a lack of money to satisfy the purchases of merchandise now accumulated in the stocks of our tradesmen and the mills of our manufacturers. As long as we have sufficient gold to pay for importations and foreign wants, we should be patriotic enough to accept without reserve such form of money as our government guarantees to redeem.

Although the coinage ratio of silver to gold under the present statute is 16 to 1, nevertheless, in times like the present, when there is a manifest demand for ready money, we should have confidence in one another to accept the metal now lying idle

in the Government vaults and waiting to be coined for general circulation and distribution. The strength of our Government, the great resources of our country, the patriotic feeling of our citizens, should be sufficient guarantees that we are fully capable of meeting our obligations, whether foreign or domestic, in such specie as may be demanded of us. If we accept the worthless greenback because it is legalized and stamped with the guarantee of our Government, we can surely accept a metal which has the same guarantee, in addition to possessing an intrinsic value of at least  $\frac{1}{16}$  of gold.

MONROE ENGELSMAN.

The wedding of Joseph Lajoie, Worcester, Mass., to Miss Esmeralda Bousquet is announced to take place on or about Sept 1.

## PIVOT DRILLS THAT WILL DRILL.

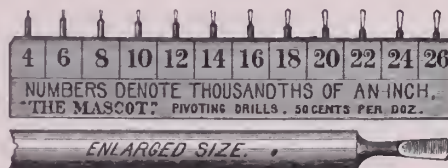

The Mascot is the best made Pivot Drill in the world. This is a strong assertion, but it is justified by the quality of the drills.

The following unsolicited testimonial would also seem to warrant our assertion :

MESSRS. EZRA F. BOWMAN & CO., LANCASTER, PA.:

*Gentlemen*—I am in receipt of your Mascot Pivot Drills that I ordered on the strength of your statement in the May issue of the "Keystone." Having tried every so-called Pivot Drill that my attention was directed to, and meeting with dismal failure, I was naturally inquisitive to learn what your Mascot was capable of doing. I took a Seth Thomas Clock mainspring, and subjected six drills out of each dozen to the test of drilling twenty holes through without drawing the temper. Every drill stood the test and your claim in the "Keystone" is warranted by the facts. Yours truly, L. F. GIERING

Sent by mail, postage paid, on receipt of 50 cents.

EZRA F. BOWMAN & CO., Lancaster, Pa.

# REED & BARTON, Silversmiths,

MANUFACTURERS OF

STERLING *and* SILVER PLATED  
SILVER WARE.

Salesrooms :

37 Union Square, New York.

31-36 WASHINGTON ST.,

Venetian Building, Chicago.

FACTORIES, TAUNTON, MASS.

# PROGRESSIVE PROSPERITY

is indicated when a Jeweler carries a full line of

**HOLMES & EDWARDS,  
SILVER : PLATED : FLAT : WARE.**

STERLING SILVER INLAID.

XIV Extra Plate - - - fancy pieces with gilt, engraved, or gilt engraved bowls and blades.

BEAUTIFUL EFFECTS ARE PRODUCED.

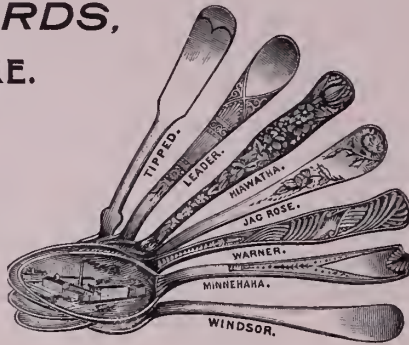

— Salesrooms: New York, Chicago, St. Louis. —

**THE HOLMES & EDWARDS SILVER CO., BRIDGEPORT, CONN.**

## BIG RETURNS MADE FOR OLD GOLD AND SILVER.

Check Forwarded 24 Hours After Receipt of Consignment

# RATHBONE & SMITH,

GOLD AND SILVER REFINERS, ASSAYERS AND SWEEPSMELTERS,  
Nos. 1 to 9 Matthewson St., Cor. Cove, Providence, R. I.



**KETCHAM & McDOUCAL,**  
MANUFACTURERS  
GOLD & SILVER THIMBLES,  
GOLD COLLAR BUTTONS,  
AUTOMATIC EYE-GLASS HOLDERS,  
198 BROADWAY N. Y.

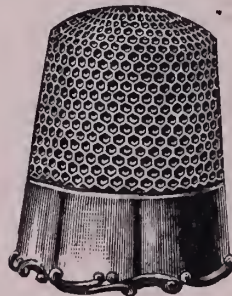

## LATEST AND BEST ELK'S TOOTH BADGE.

CAN BE USED AS A CHARM BY SIMPLY DETACHING BAR FROM TOOTH.



Reverse shows the symbolic flower of the Benevolent and Protective Order of Elks, the forget-me-not, beautifully enameled in colors; also the letters B. P. O. E.

MANUFACTURED BY

**G. A. SCHLECHTER,**  
READING, PA.

DON'T FORGET the JEWELER'S CIRCULAR PUBLISHING CO.'S BOOK LIST when in want of any technical book in the Jewelry or Kindred Trades.



61 Hanover Street, Boston, Mass.

Sales made for Jewelers only in their established places of business. Can give best references of any auctioneers in America.

All communications strictly confidential.

## THE FINEST OILS EXTANT:



**\$1,000 CHALLENGE FOR THEIR EQUAL.**



**Providence.**

John C. Blundell has been confined to his house for several days by rheumatism.

The Standard Seamless Wire Co., Pawtucket, have moved into their new factory.

Fred W. Dexter, Pawtucket, has been sued for the payment of a bill of merchandise by Wm. Smith & Co.

The manufacturers of gold jewelry in this vicinity are at present paying a premium of three per cent. for Government gold.

Henry Abbott & Co., New York, have made an offer of twenty-five cents on the dollar in settlement which is being generally accepted.

John Costello and Robert Fletcher have formed a copartnership and succeed John Costello, retail jeweler, as The Costello Co., at 344 Westminster St.

Joseph H. Fanning is recuperating among the pleasure resorts down in Maine. He has been suffering considerably lately from severe attacks of rheumatism.

Ex-Mayor Charles Sidney Smith has been favorably mentioned as the Republican nominee for Mayor of this city at the approaching municipal election.

Among those who were registered at the Rhode Island State building at the World's Fair the past week were: Horace E. Remington, Albert A. Remington and A. H. Wightman.

The copartnership heretofore existing between Leon L. and Harvey E. Palmer under the firm name of H. E. & L. L. Palmer at 340 Friendship St. has been dissolved by mutual consent. The business will be continued at the same place and under the same style by Leon L. Palmer.

Shepardson & Rounsville is the name of a new concern to engage in the manufacture of chains at 21 Eddy St. The firm is composed of George L. Shepardson, for many years manager and salesman for H. D. Merritt & Co., North Attleboro, and Mr. Rounsville, who was designer and sample maker for the same concern.

The stock, tools, machinery and fixtures belonging to R. S. Cytting & Co., 409 Pine St., were sold at public auction, at mortgagee's sale, at 12 o'clock Wednesday noon. The sale was held under foreclosure of two mortgages held by the Waterbury Brass Co. of \$1 and \$135 respectively. The property was bid in by Attorney Rogers for the Waterbury Brass Co., for \$85 and \$55 on the two mortgages.

Kent & Stanley Co., owners of the valuable Enterprise building on Eddy St., have come into possession of the valuable land on Aborn, Mason and Beverly Sts., which was recently devastated by fire. Upon this site a large brick building for manufacturing purposes will be erected, a portion of which the owners will occupy. The Enterprise building is to be converted into a first-class hotel. The building is practically a new one, as it has only been completed about six years. It is five stories in height and has a large frontage on Eddy and Fountain

Sts. It is generally considered that with the new passenger depot completed, a hotel in such an important location will prove a paying investment.

**Philadelphia.**

Warner Hutchins is sojourning at Atlantic City.

H. O. Hurlburt sailed last week on a two months' visit to Europe.

Wm. H. Earle departed for a three weeks' visit to Chicago on the 15th inst.

Mat Brueckman, 603 Spring Garden St., is summering at Atlantic City.

An optical goods store has been opened at 2356 N. 1st St. by William Fellman.

The working force at Hamilton & Die-singer's has been reduced about fifty per cent.

The late H. W. Levering's store at 2135 Ridge Ave. is advertised for sale by his widow.

The employes of Davis & Galt, silver-smiths, 730 Sansom St., have been put on half time.

The premises 133 S. 8th St. are undergoing alterations, and will be occupied as a jewelry store by Herman Krupnick.

James Paul, a colored man, was on last Friday sent to the Huntingdon Reformatory by Judge Biddle for stealing a watch and chain from Gustave Newfeldt's store.

The rooms of Edward T. Taylor, diamond dealer, on the second floor of 939 Market St., were entered by burglars early in the morning of the 13th inst. The place was considerably upset but no valuables were taken.

Charles Schmidt, colored, was arrested in Camden on the 13th inst., on suspicion of having a large quantity of valuable jewelry in his possession supposed to have been stolen. Thus far, however, no owner has appeared and the jewelry has not been identified.

**Pittsburgh.**

C. S. Hauser is sojourning on a farm.

H. Wallace, Smith's Ferry, Pa., bought here last week.

James McKee, now of Diamond Square, is visiting friends in Canada.

Geo. W. White, of G. B. Barrett & Co., accompanied by E. H. Kennerdell, of Tarentum, has gone to Atlantic City.

Heckel, Bieler & Co. received the commission for thirty medals for the P. A. C. field day, Aug. 26. The work comprises fifteen gold and fifteen silver medals.

John F. Watt, for years engraver with G. B. Barrett & Co., lately in the jewelry business at Freeport, Pa., died on the 12th inst. Mr. Watt left many friends in Pittsburgh to mourn for him.

**Boston.**

A. C. Howell has given a chattel mortgage for \$1550.

Elmer C. Woodworth has discharged a mortgage for \$200.

Elmer C. Woodworth has given a chattel mortgage for \$1,800.

Walter R. Goodnow, formerly of Bigelow, Kennard & Co., and Barton Pickering Jenks, late of Lewis E. Jenks, have formed a copartnership under the firm name of Goodnow & Jenks, to manufacture and sell sterling silverware. The firm's office is at 43 West St., room 41.

Miss Bertha Porter, 28 years of age, who was an employe in the American Waltham Watch Co.'s factory until recently, attempted suicide by shooting herself at her lodgings in Waltham. She was taken to the Waltham hospital with a bullet wound in her left breast. She is likely to recover. On Saturday she was able to talk a little, and her version of the affair is that the shooting was accidental.

Among the recent contracts placed with the E. Howard Watch and Clock Co. are orders for a tower clock with three seven-foot dials, on the Englewood Lyceum, Englewood, N. J.; a striking tower clock with four six-foot dials on a new schoolhouse in Long Island City, N. Y.; a watch clock for four men in the Revere Rubber Works at Chelsea; and a watchman's clock for the Newtown Railroad Co., of Brooklyn. The factory closed Aug. 18th for the regular three weeks' vacation.

E. B. Down, manager of the Waterbury Watch Co.'s exhibit, returned to Chicago Friday with his newly made better half, and on his appearance at the pavilion was presented by the boys with an elegant mantel clock. Benjamin Westervelt made the presentation speech, and Mr. and Mrs. Downs responded in happily chosen words.

**"Old English"**

**Coffee Spoon.**



**Towle Mfg. Co.,**

MANUFACTURERS OF

**STERLING SILVERWARE.**

NEWBURYPORT: No. 214 Merrimack St. CHICAGO: Nos. 149 & 151 State St.

## Our Traveling Representatives



Traveling representatives may consider these columns open for the publication of any news or items of interest regarding themselves or their confreres.

**W**ILLIAM H. Smith for many years traveling salesman for Philip Riley & Co., has severed his connection with that concern.

Traveling men in Louisville, Ky., recently were:

Fred H. England, H. Z. & H. Oppenheimer, Fred Harris, Hayden W. Wheeler & Co., Max Arnstein, J. D. Underwood, Champenois & Co., H. Grahowski, Dätelbaum & Friedman, Nat Wolff, Wolff & Gunzburger, Wm. O. Martin, Acme Silver Plate Co., Louis Barnett, Auerbach & Barnett, Max Stein, Martin Metzger & Co., Louis Bernheim, Leopold Weil & Co.

Fred Weigle, salesman for the Weber Co. has been enjoying a two weeks' vacation.

The following traveling salesmen passed through Detroit, Mich., last week: G. W. Payson, Seth Thomas Clock Co.; N. Gunzburger; Mr. Platt, Foster & Bailey; Harry Osborne, Whiting Mfg. Co.; Martin D. Levy, M. D. Levy & Co.; Mr. Rosenberger. Attieboro Stock Co.; G. D. Munson, Wm. Rogers Mfg. Co.; Mr. Elcox, Larter, Elcox & Co.; Mr. Gibson, Wm. Kinschfer; Mr. Braillard, Braillard & Pfingsten, and E. W. Cook, E. G. Webster & Son.

Travelers in Pittsburg, Pa., last week were: Fred Goodrich, Landers, Frary & Clark; Gus Hoffman, Ansonia Clock Co.; Jacob Adler, L. & J. Adler & Co.; Frank Sherry, Jos. Fahys & Co.; W. R. Bristol, C. Rogers & Bros.; A. M. Thankhauser, for Ludwig Lehman; N. D. Prentiss, Alling & Co.; A. W. Wagner, Leon J. Glanzer & Co.; T. H. B. Davis, Middletown Plate Co.; W. H. Thornton, Kremetz & Co.; Louis E. Smith, M. B. Bryant & Co.; Fred J. Foster, Unger Bros.; Thos. Rogers, Hayes Bros.; Wm. T. Gough, Carter, Sloan & Co.; S. W. Abbey, E. Ira Richards & Co.

Traveling men visiting Syracuse, N. Y., the past ten days were: H. Manning, Smith & Knapp; A. J. Lasher, Whiting Mfg. Co.; Herbert E. Slater, Champenois & Co.; Geo. B. Kenrick, Reed & Barton; A. A. Wood, Howard Sterling Co., J. Goldberg; Frank G. Moyer, Max Freund & Co.; M. Gattle, Falkenau, Oppenheimer & Co.; Sam-Cohn, Oppenheimer Bros. & Veith; L. A. Van Horn, Phillip Zellenka & Son; Daniel Pickering for C. K. Colby; R. L. Moorhead; George Osborne, Wm. Smith & Co.; John McN. Robertson, Bassett Jewelry Co.; F. L. Sherry, Jos. Fahys & Co.; Mr. Brink, Crescent Watch Case Co.; Mr. Weil, Springfels Mfg. Co.; John Platt, Foster & Bailey.

## News Gleanings.

W. B. Rushmer, Cripple Creek, Col., has sold out.

W. P. Owen, Joplin, Mo., has been attached.

O. M. Atwood has bought out S. C. Dickinson, Clifton, Kan.

G. H. Todd, DeKalb, Ill., will go out of the jewelry business.

Frank L. Davis, Harrisburgh, Pa., has made an assignment.

A. C. Lowry, Burlington, Vt., has given a chattel mortgage for \$200.

L. H. Whipcom, Pomeroy, Wash., has given a mortgage for \$400.

C. E. Little has removed from Millville, Pa. to Benton, same State.

The Towle Mfg. Co., Newburyport, Mass., have started up their factory.

Geo. H. Parsons, Menominee, Mich., is advertising a closing-out sale.

G. A. Schlechter, Reading, Pa., has given a real estate mortgage for \$3,000.

Charles Beardsley & Co., Moss Point, Miss., have made an assignment.

H. F. Learman, Milwaukee, Wis., has given a chattel mortgage for \$700.

H. E. Hillman & Co., Wheeling, W. Va., has given a deed of trust for \$800.

Joseph L. Wiseman, Asbury Park, N. J., has given a chattel mortgage for \$3,200.

Frank L. Davis, Harrisburgh, Pa., has made an assignment to William H. Hoerner.

C. E. Carpenter, Horseheads, N. Y., was up on supplementary proceedings some days ago.

A judgment for \$72 has been entered against Levant L. Mason, Jamestown, N. Y.

Moffit & Monroe, Southbridge, Mass., have mortgaged their stock and fixtures for \$3,235.

Boyer & Dittman, Chambersburgh, Pa., have dissolved and been succeeded by W. L. Boyer.

The mortgagee of Robitaille & Lavalley, Lowell, Mass., has foreclosed and removed the stock.

The American Optical Co., Southbridge, Mass., have discharged half of their 900 employes.

I. G. Perry has sold his interest in the jewelry firm of Perry & Gray, Lee, Mass., to his partner.

A. E. Keepert, Reading, Pa., has rented the second floor of the building at 635 Penn St. which he occupied last week.

A. E. Ingalls has closed out his business in Dodge Center, Minn., and has removed to a farm near Hastings, same State.

Owing to the death of G. Oakland, Milwaukee, Wis., the establishment at 152 Reed St., together with fixtures and all, will be sold out by Mrs. Oakland.

Burglars, some days ago, broke into the store of George H. Glass, Church's Ferry, N. Dak., and secured about \$115 worth of jewelry and \$11 in cash.

B. Markson, Elmira, N. Y., had three fingers of his right hand smashed one day last week. He caught his hand behind the door of his big office safe, while shutting it.

Joseph Bevan, Sr. who has been conducting a jewelry store in Winston, N. C. for several years, filed a deed of assignment last Tuesday morning, naming Capt. D. P. Mast trustee.

Charles Eisenmann, who has been watchmaker for Frank Hoff, Huntington, W. Va., for the past four years, is now located at 1053 Third Ave., that town, as a watch and jewelry repairer.

The store of A. C. Carroll & Co., Manchester, N. H., was broken into Sunday night, the 13th, and several watches and chains were stolen, the loss aggregating about \$100. Local talent is suspected.

Henry C. Parsons, long a well-known citizen of Dexter, Me., died some days ago, aged sixty-five years. He had been ill for a long time. In former years he was in the jewelry and insurance business.

Some nights ago burglars made a raid on the business part of Hartsville, Ind., entering three stores. In Ross Bros.' drug and jewelry store the robbers were most successful, securing jewelry and drugs valued at \$300.

There are a couple of rattlesnakes on exhibition in the show windows of C. H. Ankeny & Co.'s jewelry store, Lafayette, Ind. They are shedding their skins, and the operation is witnessed by large numbers of people.

### A Retail Jewelers' Association to be Organized in Georgia.

BIRMINGHAM, Ala., Aug. 21.—Secretary William Rosenstihl, of the Retail Jewelers' Association of Alabama, is in correspondence with E. W. Blue, jeweler, Atlanta, Ga., with a view to organizing an association of retail jewelers in Georgia. Mr. Blue writes that he has been in correspondence with members of the trade throughout Georgia and he finds a general feeling in favor of organization and thinks now is a good time to act. It is expected that a meeting will be called to convene in Atlanta very soon.

Alabama is already well organized. A movement has been on foot in Mississippi for some time to effect an organization in that State.

Louis Keam, for several years with J. W. Grant & Co., has severed his connection therewith and has hired shop room in Attleboro Falls, Mass., where he intends to start in the manufacturing of a general line of chains, bracelets, etc.

# THE "SANDRINGHAM"

PATENTED JANUARY 24TH, 1893.

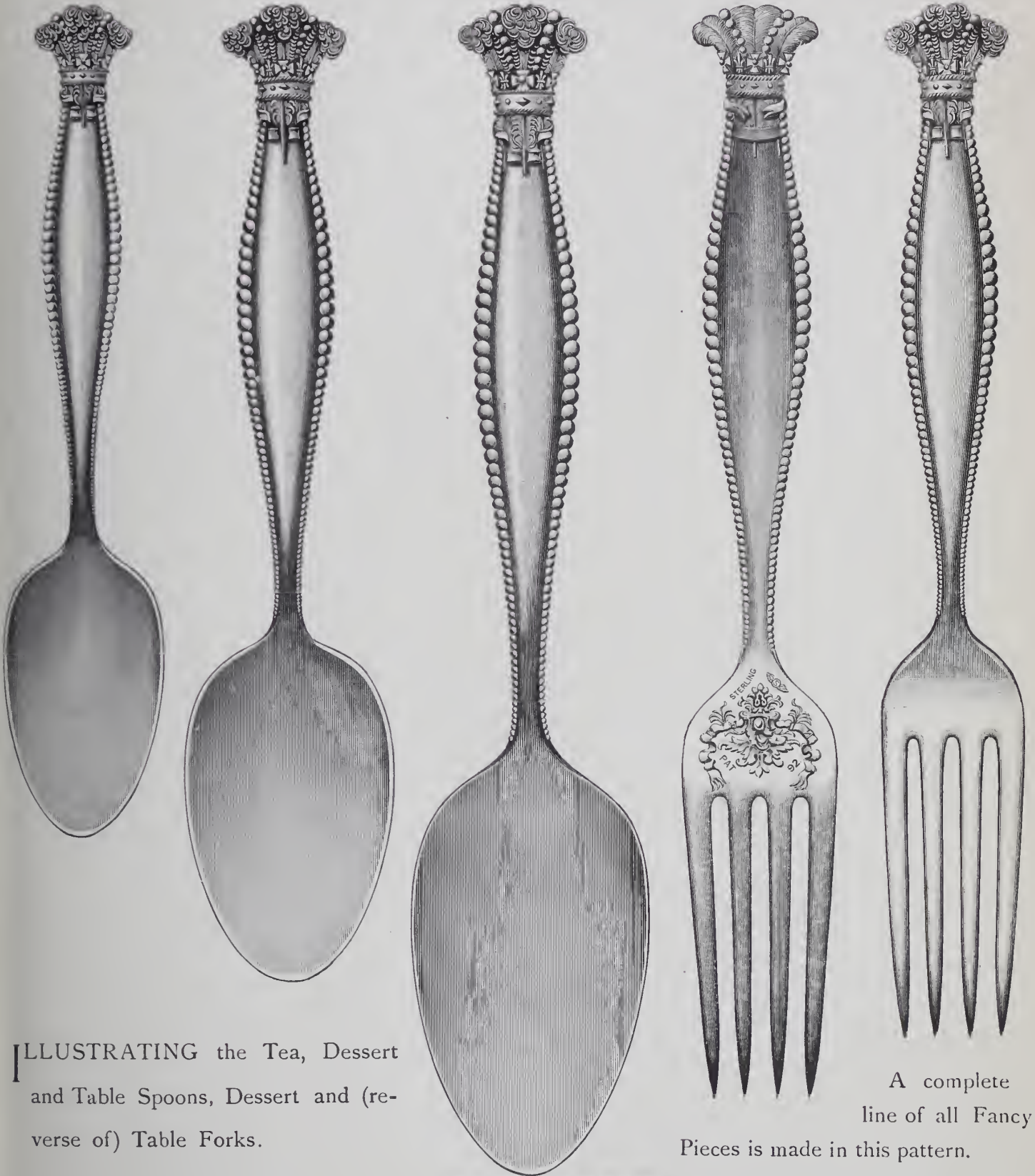

ILLUSTRATING the Tea, Dessert and Table Spoons, Dessert and (reverse of) Table Forks.

A complete line of all Fancy Pieces is made in this pattern.



Geo. W. Shiebler Co., Of the Silversmiths' Company, 179 Broadway, N. Y.

**CLASSIFIED INDEX TO ADVERTISEMENTS.**

**All Advertisements are entitled to one insertion under proper heading. Extra insertions, \$6.00 per annum. Extra Headings, \$12.00 per annum.**

Page.		Page.		Page.
	<b>Aluminum Solder.</b>		<b>Fountain Pens.</b>	
	De Redon, C., 43 W. 21st St., N. Y. . . . . 47		The Boston Pen Co., Boston, Mass. . . . . 43	
	<b>Art Pottery, Bric-a-brac, Etc.</b>		<b>Cleaning Solution.</b>	
	Bing, Ferdinand & Co., 106 Grand St., N. Y. . . . . 44		Quarters, W. F., Providence, R. I. . . . . 30	
	Borgfeldt, Geo. & Co., 18, 20 & 22 Washington Place, New York. . . . . 46		<b>Gold and Silver Plating.</b>	
	Bradley & Hubbard Mfg. Co., Meriden, Conn. . . . . 8		Brunor Plating and Jewelry Repairing Co. . . . . 5	
	Gleanzer Leon, J. & Co., 80 & 82 Chambers St., N. Y. . . . . 47		<b>Gold Jewelry.</b>	
	Hirrichs & Co., 29 & 31 Park Place, N. Y. . . . . 47		Bippart & Co., Newark, N. J. . . . . 7	
	<b>Auctioneers.</b>		Carter, Sloan & Co., 15 Maiden Lane, N. Y. . . . . 41	
	French, J. H., P. O. Box 2775, New York. . . . . 5		Hook, G. W., Chicago, Ill. . . . . 25	
	Firuski, S. & Son, 85 Bowery, N. Y. . . . . 37		Horstman, Richard, World's Fair Grounds, . . . . . 21	
	Rich, H. M. & Co., Boston, Mass. . . . . 32		Krementz & Co., 182 Broadway, N. Y. . . . . 8	
	<b>Assayers &amp; Refiners.</b>		Mayer, Martin, Mainz, Germany. . . . . 27	
	Clark, J. L., Philadelphia, Pa. . . . . 48		Racine Jewelry Mfg. Co., Racine, Wis. . . . . 25	
	Goldsmith Bros., Chicago, Ill. . . . . 18		Smith, C. Sydney, 191 Broadway, N. Y. . . . . 9	
	Howard, S. P., 8 John St., N. Y. . . . . 48		Street, Geo. O. & Sons, 15 John St., N. Y. . . . . 30	
	Le Long, L. & Bro., Newark, N. J. . . . . 48		<b>Horological Schools.</b>	
	Rathbone & Smith, Providence, R. I. . . . . 32		Parson's School for Watchmakers, Peoria, Ill. . . . . 26	
	Platt, Chas. S., 29-31 Gold St., N. Y. . . . . 48		<b>Hotels.</b>	
	<b>Badges, Medals, Etc.</b>		Gibson House, Cincinnati, O. . . . . 26	
	Irons & Russell, Providence, R. I. . . . . 26		<b>Imported Clocks, Bronzes, Etc.</b>	
	Schlechter, G. A., Reading, Pa. . . . . 32		Jacques Chas., Clock Co., 22 Cortlandt St., N. Y. . . . . 48	
	Stockwell, E. R., 19 John St., N. Y. . . . . 30		<b>Jewelry Mailing Boxes.</b>	
	Wilson, Chas. G., Reading, Pa. . . . . 27		Am. Railway Supply Co., 24 Park Place, N. Y. . . . . 30	
	<b>Chains, Seamless.</b>		<b>Jewelry, Silverware and Optical Cases.</b>	
	Kent & Stanley Co., Providence, R. I. . . . . 4		Birmingham, Wm. & Co., 728 Arch St., Phila. . . . . 47	
	<b>Cut Glass.</b>		Troescher, A. & Co., 69 Nassau St., N. Y. . . . . 40	
	Mt. Washington Glass Co., New Bedford, 44		Wiggers & Froelick, 60 Nassau St., N. Y. . . . . 40	
	<b>Diamond Cutters.</b>		<b>Jobbers, Watches, Diamonds, Etc.</b>	
	Humphrey, J. B., Boston, Mass. . . . . 48		Aikin-Lambert Jewelry Co., 19 Maiden Lane. . . . . 10	
	<b>Diamond &amp; Precious Stone Importers.</b>		Bowman, Ezra F. & Co., Lancaster, Pa. . . . . 31	
	Bruhl Bros. & Co., 21 Maiden Lane, N. Y. . . . . 48		Cross & Beguelin, 17 Maiden Lane, N. Y. . . . . 10	
	Disselkoben, John N., 19 E. 16th St., N. Y. . . . . 41		Friedlander, R. L. & M., 65 Nassau St., N. Y. . . . . 9	
	Falkenau, Oppenheimer & Co., 40 Maiden Lane, N. Y. . . . . 48		Giles Bros. & Co., W. H. Gleason, receiver, Chicago, Ill. . . . . 25	
	Henry, Fera, 10 Maiden Lane, N. Y. . . . . 48		Lapp & Flershem, Chicago, Ill. . . . . 22	
	Hedges, Wm. S. & Co., 170 Broadway, N. Y. . . . . 40		Myers, S. F. & Co., 48 Maiden Lane, N. Y. . . . . 48	
	Jeane, Paul, Bradley Bldg., N. Y. . . . . 48		Yates, John B., Hays Building, Maiden Lane, N. Y. . . . . 12	
	Kahn, L. & M. & Co., 10 Maiden Lane, N. Y. . . . . 48		Young, Otto & Co. Chicago, Ill. . . . . 20	
	Kipling, R. A., Hays Bldg., N. Y. . . . . 40		<b>Musical Boxes.</b>	
	Leonhardt & Curran, 44½ Maiden Lane, N. Y. . . . . 44		Jacot & Son, 298 Broadway, N. Y. . . . . 7	
	Lorsch, Albert & Co., 37 Maiden Lane, N. Y. . . . . 48		Wolff, A., 194 Broadway, N. Y. . . . . 30	
	Ludeke & Power, 23 John St., N. Y. . . . . 40		<b>Optical Goods.</b>	
	Nissen, Ludwig & Co., 18 John St., N. Y. . . . . 40		Queen & Co., Philadelphia, Pa. . . . . 30	
	Randel, Baremore & Billings, 29 Maiden Lane, 41		Scheidig, John & Co., 43 Maiden Lane, N. Y. . . . . 44	
	Rothschild, M. D., 41 & 43 Maiden Lane, N. Y. . . . . 48		Spencer Optical Co., 15 Maiden Lane, N. Y. . . . . 10	
	N. Y. . . . . 48		The Nous Verrons Co., Boston, Mass. . . . . 29	
	Smith, Alfred H. & Co., 182 Broadway, N. Y. . . . . 40		Zineman, M. & Bro., Philadelphia, Pa. . . . . 12	
	Wolff & Gunzburger, 87 Nassau St. N. Y. . . . . 48		<b>Pens, Pencil Cases, Etc.</b>	
	<b>Diamond Jewelry.</b>		Aikin, Lambert & Co., 19 Maiden Lane, N. Y. . . . . 30	
	Bonner, Rich & Co., 41 Maiden Lane, N. Y. . . . . 43		<b>Patents.</b>	
	Waterman & Lehman, 37 Maiden Lane, N. Y. . . . . 12		Cox & Sons, 11 Park Row, N. Y. . . . . 37	
	<b>Engravers &amp; Designers.</b>		<b>Ring Makers.</b>	
	Bartholomew, W. H., 18 Spruce St., N. Y. . . . . 30		Bowden, J. B. & Co., 192 Broadway, N. Y. . . . . 7	
	<b>Fine Stationery.</b>		Hildreth Mfg. Co., 51 Maiden Lane, N. Y. . . . . 8	
	Parsons, Green & Co., 18 Murray St., N. Y. . . . . 5		<b>Sample Trunks.</b>	
			Crouch & Fitzgerald, 161 Broadway, N. Y. . . . . 42	
			<b>Settings and Galleries.</b>	
			Blancard & Co., 36 John St., N. Y. . . . . 28	
			<b>Silver Mounted Ebony Goods.</b>	
			Deitsch Bros., 7 E. 17th St., N. Y. . . . . 2-3	
			<b>Silver Plated Ware.</b>	
			Holmes & Edwards Silver Co., Bridgeport, Conn. . . . . 32	
			Fairpoint Mfg. Co., New Bedford, Mass. . . . . 5	
			Rogers & Bro., 16 Courtlandt St., N. Y. . . . . 17	
			<b>Sterling Silverware.</b>	
			Bachrach & Freedman, 183 Union Sq., N. Y. . . . . 39	
			Campbell-Metcalf Silver Co., Providence, R. I. . . . . 40	
			Dirksen Silver Filigree Co., Freeport, Ill. . . . . 23	
			Knowles, J. B. & S. M., Co., Silversmiths' Hall, Union Square, N. Y. . . . . 7	
			Ovaitt & Warner, Portland, Oregon. . . . . 25	
			Reed & Barton, 37 Union Sq., N. Y. . . . . 31	
			Shiebler, Geo. W., Co., 179 Broadway, N. Y. . . . . 35	
			Simons Bros. & Co., Chicago, Ill. . . . . 19	
			Towle Mfg. Co., Newburyport, Mass. . . . . 33	
			Wallace, R. & Sons Mfg. Co., 3 Park Place, N. Y. . . . . 6	
			Whiting Mfg. Co., Broadway and 18th St., N. Y. . . . . 15	
			Wood & Hughes, 10 John St., N. Y. . . . . 40	
			<b>Thimbles.</b>	
			Ketcham & McDougall, 198 Broadway, N. Y. . . . . 32	
			<b>Tool Manufacturers and Dealers.</b>	
			Bullock, O. W., Springfield, Mass. . . . . 7	
			Chicago Watch Tool Co., Chicago, Ill. . . . . 26	
			Gesswein, F. W., 39 John St., N. Y. . . . . 44	
			Mosely & Co., Elgin, Ill. . . . . 23	
			<b>Trunks and Traveling Bags.</b>	
			Crouch & Fitzgerald, 161 Broadway, N. Y. . . . . 42	
			<b>Watch Case Manufacturers.</b>	
			Goll, Henry, 17 John St., N. Y. . . . . 44	
			The Planchamp & Becker Co., Chicago, Ill. . . . . 26	
			<b>Watch and Clock Dials.</b>	
			Waltham Dial Co., Waltham, Mass. . . . . 30	
			<b>Watch and Clock Oils.</b>	
			Nye, Wm. F., New Bedford, Mass. . . . . 32	
			<b>Watchman's Clocks.</b>	
			Hausburg, O. E., 41 Maiden Lane, N. Y. . . . . 37	
			<b>Watch Importers.</b>	
			Hyde's, J. E., Sons., 22 Maiden Lane, N. Y. . . . . 30	
			Wittnauer, A., 19 Maiden Lane, N. Y. . . . . 27	
			<b>Watch Keys.</b>	
			Clark, A. N., Plainville, Conn. . . . . 42	
			<b>Watch Repairers.</b>	
			Henry, Peter, Cincinnati, O. . . . . 26	

## Special Notices.

Rates 75c. per insertion for notices not exceeding 3 lines (25 words); additional words 2 cents each. If answers are to be forwarded, postage stamps must be enclosed. Two insertions, 15 per cent. off; three insertions, 20 per cent. off; four insertions or more, 25 per cent. off. Payable strictly in advance. Display cards on this page will be charged at \$2.00 per inch for first insertion, subject to same discount as above for subsequent insertions.

Under the heading of **Situations Wanted** on this page advertisements will be inserted for **One Cent a Word**. This offer refers to **Situations Wanted only**. Payable strictly in advance. If answers are to be forwarded, postage must be enclosed.

## Situations Wanted.

Notices under this heading **ONLY** are charged at one cent a word, payable strictly in advance. If answer are to be forwarded, postage must be enclosed.

**POSITION** as salesman, Retail jewelry or silverware. Experienced. References. Address, "F," care, JEWELERS' CIRCULAR.

**SITUATION WANTED.**—An experienced traveler wishes a position in a first-class house. Many years on the road and well acquainted in all sections east of Omaha. Diamond house preferred. Address E. D., JEWELERS' CIRCULAR.

**BY WATCHMAKER** with seven years' experience. Fair engraver. Wages \$15 per week. Will furnish my own tools and good reference. None but good houses which can furnish steady position need apply. Address "Staff," care JEWELERS' CIRCULAR.

**WANTED**—By a young man 22 years of age, a position to represent a manufacturing jeweler or precious stone house in the city or on the road, or position in office. Reference unquestioned. Long experience in the business. H., care of JEWELERS' CIRCULAR.

**POSITION** wanted by young Swede as watchmaker and clock repairer; three years' experience; speaks English; own tools; best references. Address Mechanicsville, N. Y., Lock Drawer No. 6.

**SITUATION** wanted - Watchmaker and Optician, experienced, wants a position about Oct. 10th. Am considered a good man. Address G. B., 72 Mount Avenue, Delaware, O.

**SITUATION** wanted - First-class Watchmaker, 30 years of age, desires permanent situation, Indiana or Illinois, after Sept. 18th. References exchanged. Address Mitchell, care of JEWELERS' CIRCULAR.

**WATCHMAKER**—Young man (26) desires permanent situation in New York or vicinity; is first-class workman and has A No. 1 recommendation. Address O. M. X., care JEWELERS' CIRCULAR.

**SITUATION** wanted by an all round workman on watches, clocks and jewelry; am fair engraver, best of references. Address Ed. Brandon, Le Mars, Iowa.

**WATCHMAKER**, 17 years experience, sober industrious, good recommend from present employer, wants position Sept. 1st. Address C. R. Burritt, Norwich, N. Y.

**WANTED**—Situation in New York or Brooklyn to take charge of optical department. References, &c., given by addressing A. G. W., care CIRCULAR.

**SITUATION** wanted by a watchmaker and jeweler in or near New York City. Thirty years' experience and best of references. Address W. H. D., care of JEWELERS' CIRCULAR.

**SITUATION** wanted—Watchmaker and engraver wants a position with some reliable firm; good references. Address Box 21, Bonckville, N. Y.

## Help Wanted.

**WANTED**—Experienced traveling salesman to carry a leading and well-known line of spectacles and eye-glasses; samples easily carried; liberal commission. Address Optics, care JEWELERS' CIRCULAR.

**WANTED**—A practical jeweler and designer to take charge of a factory in an old established business. To a man with some capital an interest in the business will be given. Address, A. J., care JEWELERS' CIRCULAR.

**AN** unmarried man to work on shares (one-half) in a village repairing establishment. Enclose stamp if reply is desired. Address Box 37, Smithville, Va.

**WATCHMAKER WANTED**—One that can engrave preferred. Must be quick and good. Wages \$12. E. C. Kern, 448 Bloomfield Ave., Montclair, N. J.

## For Sale.

**FOR SALE.** Safe—Choice of three. For cash or right kind of gold jewelry. Apply to T. B. Bynner, 177 Broadway, New York.

**FOR SALE**—A first-class jewelry store, established fourteen years, where stock and fixtures costing \$4,500 can be secured for \$2,350, or, if desired, can give lease of store with fixtures and sell stock for \$1,500, one thousand dollars cash and balance on easy terms. Bench work alone amounts to over \$1,800 yearly. The location of the store and profits of the business will stand thorough investigation. Address Frank C. Kibby, No. 366 Broadway, Chelsea, Mass.

**FOR SALE.**—\$500 for \$300 cash. Jewelry, News Depot and furnished rooms for two. Rent \$8. Store pays profit; bench work for one. Address Cyrus Condit, 2344 Bellevue Avenue, Kansas City, Mo.

**FOR SALE**—A Rare Chance. A recently established jobbing, cutlery and silver plated ware business, with New England agencies, is offered for sale. Present proprietor's engagements prevent his devoting the necessary time to the business. A live, pushing man will find this an opportunity seldom offered. Buyer can have immediate possession. Offer must be in cash or well secured paper. Address Jobbing Business, care of JEWELERS' CIRCULAR.

## Miscellaneous.

**I BUY JEWELRY STOCKS**—Manufacturers, jobbers and retailers desiring to dispose of surplus or entire stocks of diamonds, watches and jewelry can find quick cash buyer by addressing Stephen S. Harmon, 134 East 96th St., New York city.

**WANTED**—To purchase. Jeweler's Stock; include if possible, Burglar Proof Safe; Regulator, lathe, tools, Street clock, material, trial lenses; five to eight thousand. H. Bramer, Attica, N. Y.

**ENGRAVING** only is taught at Trowbridge's Engraving School, Winona, Minn. Rates low and good board cheap.

**TO MANUFACTURERS**—Wanted, an agency in Philadelphia for jewelry, watches or diamonds, by a person well known to the trade, in Philadelphia, Baltimore and Washington, D. C. Commission if desired. Address D. H. C., JEWELERS' CIRCULAR.

**A WELL-KNOWN**, established, paying business, owning several valuable patents connected with the jewelry and silverware trades, which is steadily growing in favor with the leading dealers of the country, who is getting beyond the personal care of the owner, who wishes to interest an active young man with some experience in the jewelry or silverware business, with no less than \$5,000 cash, as an active partner to attend to the financial and outdoor interests; the best of references asked and will be given. This is a rare opportunity to a desirable party; no others need reply. Address, giving full name and references, Manufacturer A, JEWELERS' CIRCULAR.

**TROWBRIDGE'S SCHOOL** of Letter and Monogram Engraving, of Winona, Minn., is the place to learn the art. Rates lowest. Good board cheap. New term starting.

## DEMAGNETIZING.

**PERFECT WORK**—Watch repairing in all its branches; all work warranted. Winslow & Penney, 608 Masonic Temple, Chicago.

**HARD** soldering made an easy task for anyone. Guaranteed the best and cheapest thing or money refunded. 50c. F. L. Wells, Marion Center, Pa.

## To Let.

**TO LEASE**—A Game Preserve in the Adirondacks. Plenty of Deer and Trout. Address Chas. Heaton, Jeweler, Potsdam, N. Y.

**TO LET**—Fine front office in Knapp Building; apply to Isidor Elbe, 41 Maiden Lane, Room 17.

**Headquarters**  
FOR  
**ELECTRIC & PORTABLE**  
**Watchman's Clocks**

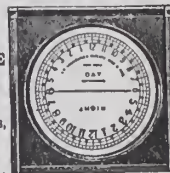

Price,  
Complete  
\$10.00

Lowest Prices.  
Latest Improvements,  
Patents 1886-1893.  
Send for Circular.  
**E. O. HAUSBURG,**  
41 Maiden Lane, New York. THE "ALERT."

**SOLICITORS OF**  
**FOR DESIGNS** **AMERICAN & FOREIGN**  
**INVENTIONS** **PATENTS** **SEARCHES MADE &**  
**TRADE MARKS** **THE TRADE WILL** **INFRINGEMENTS**  
**SAVE TIME AND MONEY BY HAVING THEIR** **PROSECUTED**  
**COX & SONS 11 PARK ROW, N.Y.** **PATENTS TAKEN BY**  
**OR DEFENDED**

## PAWNBROKERS' SALES

BY

**S. FIRUSKI & SON,**

AUCTIONEERS,

85 Bowery, New York,

AT 11 A. M.

See N. Y. Herald for full particulars of Sales.

The Trade is Respectfully Solicited to Attend.

**IF** YOU WANT A POSITION  
YOU NEED A SALESMAN  
YOU NEED A WORKMAN  
YOU DESIRE TO EXCHANGE  
YOU WANT A PARTNER  
YOU WISH TO SELL OUT  
YOU HAVE TOOLS TO SELL  
YOU HAVE A PLACE TO LET  
YOU WANT ANYTHING

USE THE  
SPECIAL NOTICE PAGE

OF THE

**JEWELERS' CIRCULAR,**

Published Every Wednesday.

ONE YEAR'S SUBSCRIPTION

—TO—

The Jewelers' Circular,

—At \$2.50,—

Entitles the subscriber to a copy of "WORK-NOTES" free, a 200 page book, bound in cloth, containing a fund of information for the workshop that can be found in no other work.

The Latest Patents.

ISSUE OF JULY 25, 1893.

501,981. GRIP-BUTTON. WILLIAM F. WHITING, Providence, R. I., assignor, by mesne assignments, to the Howard & Son Co., same place.—Filed June 28, 1890. Serial No. 357,077. (No model.)

In a grip button the combination with the outer plate or the inner plate having a concave inner surface, a spring plate corresponding in length to the diameter of the outer plate and having its end secured between the edges of said two plates, and having a curve from



end to end corresponding approximately to the concavity of the inner plate, prongs on said spring plate intermediate of its ends and constructed to extend through an opening in the inner plate, and a grip lever having a pivotal connection with the inner plate and having its inner end bearing upon the spring plate.

502,001. JEWELRY-CASE. WILLIAM HEATLEY, London, England, assignor to the Detector Patent Safety Postal Box Syndicate, Limited, same place.—Filed Aug. 31, 1892. Serial No. 444,640. (No model.)

A wooden box or case having beveled top edges and having side grooves in opposite faces of its walls, com-

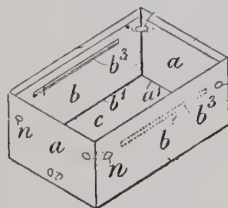

bined with a cover provided with a locking cross bar having projecting tongues, and which when applied to the box and pressed down, cause the walls to spring slightly to lock the bar in such grooves.

502,026. ARTICLE OF JEWELRY OR PLATE. WILLIAM W. BRADLEY, Philadelphia, Pa., assignor to the Keystone Watch Case Co., same place.—Filed June 3, 1892. Serial No. 435,340. (No model.)

As an article of manufacture, a piece of jewelry or plate having an inner filling of base metal and a thin outer covering of precious metal and one or more



ornamental pieces of metal of different character or color from the surface metal, but of a thickness less than the thin outer covering of precious metal, pressed into the surface metal.

502,036. THREAD-CUTTING ATTACHMENT FOR THIMBLES. MARY FOGG, Beaver Dam, Wis.—Filed April 17, 1893. Serial No. 470,669. (No model.)

An attachment for thimbles comprising a recurved



spring-plate having offset prongs of less length than itself, and a cutting blade projecting outward from the plate.

502,060. WATCH-KEY. IRVING WILLIAMS, Nelson, Mo.—Filed March 20, 1893. Serial No. 466,811. (No model.)

In a watch key, the combination of an outer barrel provided with handles or loops 4, with the inner barrel

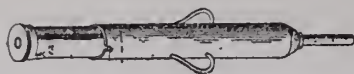

guided in the outer barrel and held from rotary movement by means substantially as described, the interior surface of the inner barrel being formed with a spiral groove, the coiled spring arranged within the outer barrel and bearing against the inner barrel, and the winding-shaft passing through the outer barrel and received at its inner end within the inner barrel and provided with a lug to engage the spiral groove.

502,156. SELF-WINDING AND SYNCHRONIZING CLOCK. ARTHUR G. WISEMAN, St. Louis, Mo.—Filed Oct. 28, 1892. Serial No. 450,210. (No model.)

In a self-winding and synchronizing clock, the combination of a single magnet, an armature lever, mechanism operated by said magnet and lever to synchronize the clock, whereby but one magnet and armature is required to both wind and synchronize.

502,157. ELECTRIC-CLOCK SYNCHRONIZER. ARTHUR G. WISEMAN, Webster Groves, Mo.—Filed April 29, 1892. Renewed March 24, 1893. Serial No. 467,451. (No model.)

In a synchronizing mechanism for clocks, an armature, a seconds-hand shaft, a scape wheel carried loose on said shaft, a clutch adapted to engage the said shaft and scape wheel and mechanism between the armature and seconds-hand shaft adapted to rotate the shaft and disconnect it from the scape wheel.

502,161. ILLUMINATED CLOCK. WILLIAM H. ALDERSON, Withington, near Manchester,

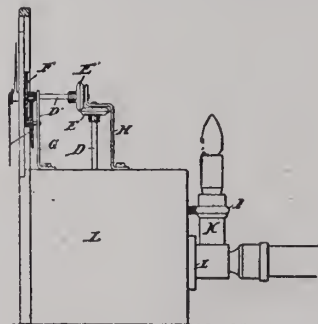

England.—Filed Oct. 18, 1892. Serial No. 449,274. (No model.)

502,215. ELECTRIC WINDING ATTACHMENT FOR CLOCKS. ARTHUR G. WISEMAN, St. Louis, Mo.—Filed July 30, 1892. Serial No. 441,720. (No model.)

The combination, with a gear-shaft 15; wheel turning free on the shaft, a main spring with ends connected to the shaft and said wheel, a disk 5; a lever pivoted to said wheel and adapted to bear against said disk to close the circuit, and mechanism carried by said wheel to operate said lever.

502,226. WORKMAN'S TIME-RECORDER. SEWARD A. DEAN, Minneapolis, Minn, assignor of one-half to Harry L. Woodburn, same place.—Filed June 28, 1892. Serial No. 438,262. (No model.)

DESIGN 22,612. HAIRPIN. GEORGE P. FARMER,



Montclair, N. J.—Filed June 8, 1893. Serial No. 477,017. Term of patent 14 years.

DESIGN 22,613. SPOON. CARRIE P. TRUSDELL,



Cleveland, Ohio.—Filed May 14, 1893. Serial No. 473,047. Term of patent 7 years.

Issue of Aug. 1.

502,268. WATCHCASE - PENDANT. OLE O. AUNE, Columbus, Ohio.—Filed Jan. 25, 1893. Serial No. 459,655. (No model.)

In a stem setting watch the combination with the case, case stem and watch mechanism and a setting and winding mechanism in connection therewith, of a



winding stem or stem, a spring collet surrounding said stem or winding stem, notches in said collet above and below its end meeting points and a screw or pin entering said stem and normally in engagement with one of said collet notches, the position of the winding and setting mechanism of said watch being dependent upon the position of said winding stem.

502,311. ELECTRIC SYNCHRONIZER FOR CLOCKS. HENRY S. PRENTISS, Elizabeth, N. J.—Filed May 19, 1892. Serial No. 433,505. (No model.)

A time piece provided with a mechanical detent adapted to engage with the governing member to arrest its motion and stop the train, a cam on one of the arbors of the train, an operative connection between

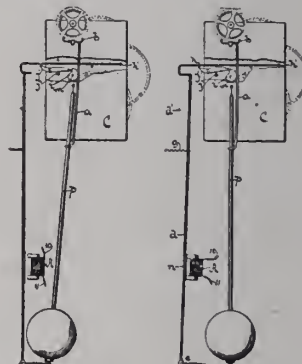

said cam and the detent for actuating the latter to lock the governing member and arrest the motion of the train at the hour as indicated by the time piece, and an electro-magnet for effecting the release of the governing member from the detent.

502,588. COMBINATION CUFF - BUTTON AND LINK. LEWIS S. SAMPSON, New York, N. Y.—Filed Apr. 20, 1893. Serial No. 471,177. (No model.)

As an improved article of manufacture, a button consisting of a head A provided with a shank composed of a link section B, a link section D pivoted to the latter,



and a link section F pivoted to said section D and having its free end provided with a fastening for engaging the base, and a catch secured to the base for engaging and holding the link sections when they are folded beside one another.

502,618. JEWEL AND PIVOT GAGE. JOSEPH E. ADCOX, Lebanon, Oreg.—Filed July 8, 1892.

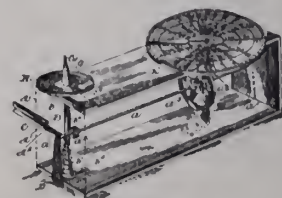

Serial No. 439,424. (No model)

A gage for jewels and arbors, pivots and the like,

having a dial of the character stated, the index hand moving thereover, a movable bar having an upper reduced end for the jewels, a pair of calipers connected with said bar, and suitable connecting mechanism between said bar and said index hand.

DESIGN 22,659. BADGE. CHARLES G. WILSON.



Reading, Pa.—Filed Apr. 14, 1893. Serial No. 470-382 Term of patent 14 years.

DESIGN 22,660. SPOON. WILLIAM A. MONTAGUE, Daluth, Minn.—Filed Mar. 18, 1893. Serial No. 466,717. Term of patent 3½ years.



DESIGN 22,661. SPOON. CHARLES E. PRÉTAT, Waterbury, Conn., assignor to the Rogers & Hamilton Company, same place.—Filed May 12, 1893. Serial No. 474,028. Term of patent 14 years.



DESIGN 22,662. CUT-GLASS DISH. DANIEL FORBES, Brooklyn, N. Y.—Filed May 10, 1893. Serial No. 473,731. Term of patent, 3½ years.

DESIGN 22,663. CUT-GLASS DISH. DANIEL FORBES, Brooklyn, N. Y. Filed May 10, 1893. Serial No. 473,732. Term of patent 3½ years.

**Canada and the Provinces.**

Kingham & Minor, Victoria, B. C., have dissolved, Joshua Kingham continuing.

The death of John Herbin, of Windsor, N. S., is reported from Laveta. Twenty years ago Mr. Herbin did a flourishing jewelry business in Windsor.

Messrs Cuthbertson and McCann formerly connected with the firm of J. M. Jones & Co., Montreal, are doing business in their own account in Toronto, principally in the novelty line.

Fred Roberts, Toronto, on Friday last assigned to A. W. Campbell who took charge of the estate which is estimated at being worth \$3,000 or \$4,000. The total of his liabilities have not yet been ascertained.

J. Johnston, jeweler, of Atwood, Ont., and John Maynard, jeweler, of Bowmanville, Ont., have both assigned to Henry Barber. Montreal, Toronto and London wholesalers are interested, but the liabilities in both cases are small.

In a fire in Ottawa, Ont., a few days ago, the store with residence over, of F. & J. Grant was damaged slightly, mostly by water. The shop of C. W. Willemott, lapidary, was also damaged; the loss here was quite heavy. Mr. Willemott lived above the store.

By the alleged alienation of his wife's affections, Chester O'Brien says he has suffered \$5,000 worth of pain of mind, at least that is the amount he claims from jeweler Frederick Roberts, Toronto, Ont., who he says acted as a gay lothario and despoiled his home.

The American Watch Case Co., Toronto have moved into new and magnificent premises at 511 and 513 King St. W., Toronto. The building is four stories high and was specially built for the requirements of the company. It is a fireproof structure and complete in every respect.

A gang of boys ranging in age from 12 to 14 years have been arrested in Halifax, N. S., and sentenced to two years each in reformatory schools for burglarizing the jewelry store of T. D. Spike, of that city. A quantity of the jewelry stolen was found hidden under gutter bridges of the streets.

**St. Louis.**

Fred. W. Drost, the Olive St. jeweler, is in Chicago.

Hess & Culberson have moved from their old stand on the west side of 6th St., just south of Olive St., to the north east corner of 6th and Locust Sts.

The fourth annual picnic of the Retail Jewelers' Association of Missouri, took place on Sunday. The excursionists left the city at 9 A.M. sharp on the steamer *Spread Eagle* and disembarked at the club grounds of the North St. Louis Fishing & Hunting Club, on the Illinois shore, just opposite the mouth of the Missouri River. A number of traveling men took part in the excursion.

Traveling men in St. Louis, last week included H. A. Bliss, Kremetz & Co., Fred L. Pettee, Waterbury Clock Co; Wm. Pflueger, Jos. Notenman & Co; E. M. Beasher, Lissauer & Co.; John S. Jepson, Veit Hirsch & Co; Tom B. Davis, Middletown Plate Co.; Louis E. Smith, M. B. Bryant & Co; Louis Bernheimer, Leopold Weil & Co; Fred England, H. Z. & H. Oppenheimer; and J. Underwood, Champenois & Co.

From "A to Z of a Watch Case," an attractive twenty page illustrated pamphlet published by Joseph Fahys & Co., contains a concise and interesting sketch of the Fahys' factory at Sag Harbor, N. Y., together with illustrations and a full description of the manufacture, qualities, etc., of the celebrated Monarch cases. Joseph Fahys & Co. are offering to send any dealer in the trade 100 of these pamphlets with his business card neatly printed on the cover, on receipt of one dollar, or 250 for two dollars. This offer holds good until Sept. 1st.

**"The Enterprising Burglar Goes a-Burgling" in Philadelphia.**

PHILADELPHIA, Pa., Aug. 20.—Burglars have been particularly industrious in this city for the past few weeks, and jewelry houses have not escaped. Clark Bros.' store at 1,227 Chestnut St. was visited on Wednesday night or Thursday morning and robbed of thirty watches valued at \$300 which were in a bulk window in the front. Jewelry and watches of a cheap pattern were not disturbed. The windows had been broken.

The same parties it is believed visited H. R. Saunder's optical goods store, 133 S. 3d St. about the same time. Here also the windows were broken and opera glasses, gold eyeglass frames, opera glass holders and lorgnettes valued at about \$200 were stolen. The thieves removed a pane of glass from the side of the window nearest an alley, and it is supposed secured the articles with a cane.

**THE THIEVES CAUGHT AND GOODS RECOVERED.**

PHILADELPHIA, Pa., Aug. 22.—The thieves who robbed Clark Bros.' jewelry store, 1227 Chestnut St., and Saunder's optical goods store, 133 S. 13th St., last week, have been arrested. They are Thomas Sabey and Joseph McArdle. They were betrayed by two men named Curry and Smith, who had previously been arrested on suspicion of having stolen jewelry in their possession. Nearly all of the stolen articles have been recovered, the thieves having made a clean breast of the affair. They have been committed for trial.

**THE ALARM CLOCK.**

HER heart was a clock, and it ticked in time  
To her thoughts that flowed as a running rhyme—

Tick-tock, tick-tock, and tick!  
And I wondered much if that time was slow  
With the grief of life or the pain of woe—  
Tick-tock, tick-tock, and tick!

What sort of a clock was the maiden's heart?  
Was it going fast at youth's happy start?  
Tick tock, tick-tock, and tick!  
Did its love swing onward in glad some ways,  
Or its works run down with a long eight days?  
Tick-tock, tick-tock, and tick!

So I watched her face through our idle talk  
Till, listen! a step on the garden walk—  
Click! went the gate, and click!  
And Love's alarm-clock went off to tell  
That a certain hour was known full well—  
Tick went her heart, and tick!

EDITH L. CRARY in *Judge*.

O. E. Bell & Co., Cincinnati, O., have bought out a printing establishment and will now do their own circular printing which has become quite an item in the past year.

LARGE AND VARIED ASSORTMENT OF HIGH CLASS  
**SILVER • NOVELTIES.**  
Transparent, Inlaid, and Painted Enamel Fancy Spoons.  
**BACHRACH & FREEDMAN,**  
SILVERSMITHS, 1 & 3 UNION SQUARE, NEW YORK.  
3 CHARTERHOUSE ST., LONDON, ENG.

**DIAMONDS.**

**Wm. S. Hedges & Co.,**

**Importers of Diamonds,**

And Manufacturers of DIAMOND JEWELRY.

No. 170 BROADWAY, } New York.

S. E. Cor. Maiden Lane, }

27 Holborn Viaduct, London.



**Alfred H. Smith & Co.,**

**IMPORTERS**

**DIAMONDS**

AND

**PRECIOUS STONES,**

182 BROADWAY, COR. JOHN STREET,

NEW YORK.

33 Holborn Viaduct, London, E. C.

**CAMPBELL-METCALF SILVER CO.**



176 Broadway, N. Y., Room 14. 66 Stewart St., Prov. R. I.  
Mills Bldg., San Francisco, 8th Floor, Room 1.



Victoria Novelties, many fancy shapes.  
Celluloid Top, Sides, Bottom and Cushions  
A. TROESCHER & CO., 69 Nassau St., N. Y.

**Among the South African Diamond Fields.**

"THE JAGERSFONTEIN EXCELSIOR," A 971 KARAT DIAMOND FOUND BY AN AFRICAN NATIVE.

KIMBERLEY, July 8.—It has been my good fortune to witness a great sight. I have witnessed the christening and was nearly in at the discovery, the other day, of what I believe is the biggest white diamond ever unearthed since the world began. As it will doubtless be a stone somewhat famous in the future, I may state at the outset that it was found on the evening of the 30th June at Jagersfontein, in the Orange Free State. I happened to reach there on July 1st, and noted there was much local excitement.



THE JAGERSFONTEIN EXCELSIOR.

All through the forenoon of the 1st inst. the compound manager, Mr. Gifford, rode round the camp drawing a sort of triumphal procession after him, for it was known that he was casually wearing the big diamond in his right hand trousers pocket. In the afternoon, at the office of the Jagersfontein Diamond Mining Co., I had a full opportunity of seeing the stone. The stone was picked up by a native while he was loading a truck, and although a white overseer was standing near him he managed to secrete it and kept it on his person for some time. In this case, however, it did not appear that he purposed stealing the gem, but only wished to deliver it personally to the manager. This he did, and as a bonus he has received £150 and a horse, saddle and bridle.

The diamond weighs exactly 971 3/4 karats or about 7 1/4 ozs. avoirdupois. It is of a beautiful bluish white color, and shaped like the broken off end of an icicle. The diamondiferous monster measures three inches in length, one and a half inches in thickness, two and a half inches in greatest and one and one-third inches in least breadth. Unfortunately it has a black spot about the middle which will somewhat mar its beauty as a single stone, but the spot is so placed

**R. A. KIPLING,**

Importer of

**PRECIOUS STONES,**

21 & 23 Maiden Lane,

19, RUE DROUOT,  
PARIS.

New York.

**LUDEKE & POWER,**

**IMPORTERS OF DIAMONDS**

AND OTHER PRECIOUS STONES,

ADOLPH LUDEKE,  
CHAS. L. POWER.

23 JOHN STREET, N. Y.

**WOOD & HUGHES,**  
STERLING SILVERWARE MANUFACTURERS

New York Agents for the Derby Silver Co.'s  
FINE QUADRUPLE PLATED WARE,  
NO. 16 JOHN STREET, NEW YORK  
206 Kearney St., San Francisco, Cal.  
HASKELL & MUEGGE, Agents.

**WIGGERS & FROELICK,**  
60 NASSAU ST., NEW YORK.

**Sample Cases and Trays**  
For Watches, Jewelry, Optical Goods, Etc.

**WE STRIVE TO MAKE THE BEST.**



as to allow of the stone being cut into two with the spot falling out. It would, I think, make two superb brilliants. Being unique in size, however, the value of the gem may be almost anything when it reaches Europe. On the spot it is valued at £200,000.

The diamond was christened "The Jagersfontein Excelsior," amid copious champagne libations. The unexpected revealing of so much hitherto hidden wealth seemed to justify even THE CIRCULAR representative in rejoicing with the rest, and he has to admit that he "rejoiced" until the big diamond seemed like a leviathan gem of 971,000 karats. A somewhat curious circumstance should be mentioned in connection with the ownership. The company have for some time sold by contract all the diamonds in advance, at a fixed price. Messrs. Breitmeyer and Berheim held the contract until the 30th of June, and a new syndicate were to have the purchasing right from that date. The diamond was found only a few hours before the expiration of their contract.

Several big diamonds have been found in the Jagersfontein mine. During the present year a fine stone of 692 karats was unearthed. The Porter-Rhodes diamond, which was discovered in the Kimberley mine early in the eighties, only weighed 150 karats. It was of a good shape, and the color was perfect, a frosted blue white. It was valued at £150,000, but no buyer could be found at that figure. Diamonds were very low at the time, owing to the companies producing one against the other regardless of the demand. Eventually, I believe, the diamond was cut up.

ST. GEORGE.

**The Beautiful Opal.**

**B**ELIEF in the ill-luck conferred by the opal is entirely a modern one. Surely no stone is more beautiful, scintillating as it does with all the sunset lines of the other gems, and in ancient times it was believed to combine their virtues. Especially for one born in October is the opal considered fortunate, for, according to the old rhyme,

"October's child is born for woe  
And life's necessities must know;  
But lay an opal on her breast  
And hope will lull those woes to rest."  
—Philadelphia Times.

The true luxury of an alarm clock lies in its reminder that with a little extra haste you can spare fifteen minutes for another nap.—Washington Star.

WHAT WAS THE USE?

"What? You shook a teaspoon out of the window into the street when shaking the tablecloth, and didn't go down after it?"

"No," answered the domestic; "if it was a plated one, it wasn't worth going down two flights of steps for, and if it was silver, some one would have got it before I could get there."—Star Sayings.

ESTABLISHED 50 YEARS.

LANDEL, BAREMORE & BILLINGS,

IMPORTERS OF

DIAMONDS,

AND OTHER PRECIOUS STONES.

FINE PEARLS A SPECIALTY.

MANUFACTURERS OF

DIAMOND JEWELRY,

IN THE LATEST DESIGNS.

Diamonds Recut in Modern Styles or Repaired on Premises.

58 Nassau Street,  
29 Maiden Lane  
NEW YORK.

1 Tulp Straat,  
AMSTERDAM.

1 St. Andrews St.,  
Holborn Circus,  
LONDON, E. C.



ESTABLISHED 1841.

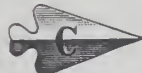

TRADE MARK.

CARTER, SLOAN & CO.,

MANUFACTURERS OF GOLD JEWELRY,

No. 15 MAIDEN LANE,

NEW YORK.

A. CARTER, JR.  
A. K. SLOAN.  
C. E. HASTINGS.

GEO. R. HOWE.  
WM. T. CARTER.  
WM. T. GOUGH.

FACTORY, NEWARK, N. J.



JOHN N. DISSELKOEN,  
Cutter and Importer of  
DIAMONDS

FACTORY,  
78 LANGEBLEEKERSPAD,  
AMSTERDAM.

19 East 16th St.,  
NEW YORK.

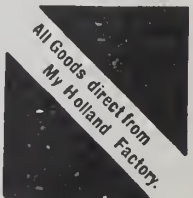

### Detached Escapement Without Unlocking Resistance.

IN 1859, I constructed an escapement with cylindrical double locking, but it did not give the satisfaction I had expected. Both the sketch and description of it appeared soon after in the *Revue Chronométrique* and years afterward in a German horological paper. From the time of recognizing the shortcomings of the original escapement, I have been engaged trying to correct these faults. It may

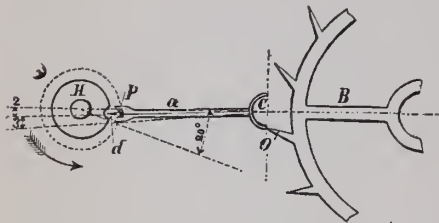

FIG. 1.

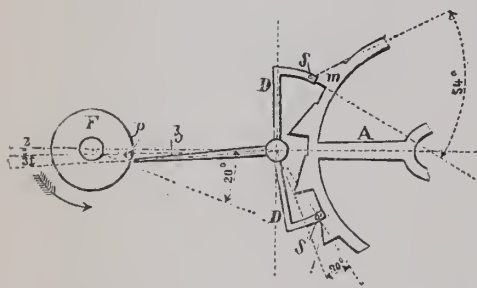

FIG. 2.

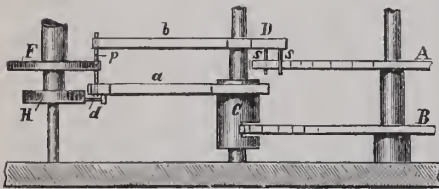

FIG. 3.

be said that all our detached escapements ail more or less with the insufficiencies of the unlocking resistance, and I finally concluded to construct an escapement without any locking. I solved the problem by combining the cylinder with the anchor escapement, as represented in accompanying cuts and description.

Fig. 1 is an elevation of the escapement; figs. 2 and 3 are plans. The former represents the lifting wheel of the escapement with the anchor belonging thereto, while the latter shows the depthing of the locking wheel into the cylinder.

As will be seen in fig. 1, the scape wheel of this escapement is double; B, figs. 1 and 3, is the locking wheel, the teeth of which lean alternately on the outer and inner sides of the cylinder C. Upon the cylinder, fig. 3, is fastened the fork *a*; this is moved to and fro by the impulse pin *p* on the impulse roller T, whereby the unlocking of the escape wheel is effected. The guard pin *d* and the safety roller H are, as far as regards their condition and effect, identical with the similar parts of the ordinary anchor escapement; they secure the locking during the excursion of the balance. As shown by the sketch, fig. 3, the pin *p* has entered the fork and liberated the tooth *o* from its locking of 3°, so that the wheel can move along. This would now drop through if it were not prevented by the twin wheel A, figs. 1 and 2, which, united with the first, enters into effectiveness at the same moment, by indirectly conducting the balance together with the fork to the other side, and thus prepares the interior locking.

This twin wheel or lifting wheel, A, fig. 2, the teeth, *m*, of which have a bevel as lifting plane (of which more anon) is at the required distance above the locking wheel B (see fig 1). The anchor D D is movable upon the cylinder arbor, and is furnished with two lifting pins, *s s* and a long lifting arm, *b*. The pins *s s* form at the same time the limitation of the anchor D D because the tooth, *m*, fig. 2, only drops when the wheel begins to move. The attacking tooth now raises the pin *s* at the entrance arm of the anchor, 10° high, the anchor overtakes the forward motion of 3° of the fork, drops with its lifting arm *b* from the side against the pin *p*, and thereby imparts to the balance its impulse in the direction of the arrow in fig. 2. Both parts, fork and anchor, move along together, until arrived at their point of limitation—that is, until the anchor pin entering into the escape wheel strikes upon the bottom of the teeth.

I must at this time remark that the pin *p*, which I would make of stone, has a

double action, similar to the anchor, which is best seen in fig. 1; at the lower part it effects the unlocking of the scape wheel by the fork *a*, and with its upper part it serves at the same time for receiving the impulsion exerted by the lever arm *b*. As regards the lifting plane of the teeth *m* of the wheel A, I have in the sketch (see fig. 2) constructed the angle with 54°; in the practical execution, however, for instance, in my model, I found out that this bevel must be at an angle of only 45° if a lifting of 10° is expected, since also the thickness of the pins *s s* and the drop of the wheel must be taken into account, which could not be experienced from the drawing.

The principal characteristic of this escapement is already expressed in its name, to wit: that the unlocking resistance is gotten rid of. In support of this, I will only mention the fact that the watch, for instance, was without balance spring down to the last tooth. Next, the required exactness of the limitation of the anchor motion in an anchor escapement is no longer necessary. For the limitation of the fork from 10° to 12° may be allowed, without having disturbances in the rate produced thereby. The anchors can be made in large quantities. When the pallet holes have been determined, they may be drilled in by the dozen. Nor does the making of the cylinder offer any difficulties. The proportions of size are the same as in ordinary cylinder escapements; the lips, however, must be filed back almost to the center and beveled in a direction contrary to the present. It is also well to state that the tooth shape of the wheels does not in their execution offer the difficulties incident to the making of anchor escape wheels; the anchor also is more readily made than the present. The two pallets also are dispensed with, and since the anchor is not required to be of steel, the lifting arm *b* can by bending be easily brought into its correct position to the pin *p*. In the same manner, when a trifling inexactness occurs, it can be corrected by bending the pins *s s* to remedy the anchor motion.—J. BERTSCHINGER, in *D. Uhrm. Ztg.*

A new comb for the back hair has a solid metal top with a rough granulated finish. Over this is raised tracery in white enamel.

### CROUCH & FITZGERALD,

Jewelry Trunks and Cases.

161 Broadway

Bet. Cortlandt and Liberty Sts.,

688 B'way,  
701 6th Ave.,  
NEW YORK



Sold by all wholesale dealers at manufacturer's price.

A. N. CLARK,  
PLAINVILLE,  
CONN.

### Manufacturer of the Celebrated LOOP WATCH KEY.

The Best for the Price in the World.  
CROSBY'S JEWELING TOOLS IMPROVED.

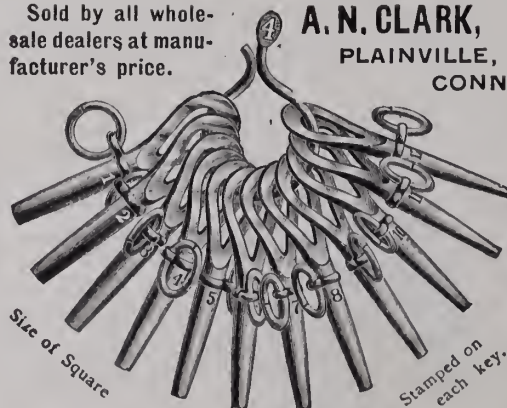

Size of Square

Stamped on each key.

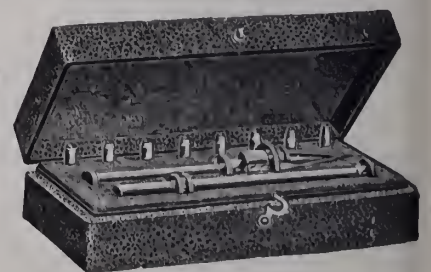

Will quote royalty or price for the manufacturing of articles of real worth.

### A Marvel in Complicated Watches.

**I**N horology gigantic strides have been made within the last few years, and difficulties hitherto considered insurmountable have been overcome. It is probable that any problem that may hereafter be proposed in the manufacture of complicated watches will be capable of being solved. The house of Patek, Philippe & Co., Geneva, have just accepted an order for a watch which will contain all improvements known up to the present time. This marvel will be absolutely unique, but only so, of course, until exceeded by some new invention. As the construction of this watch will occupy about two years, we have no doubt that some new device will meanwhile be invented.

The proposed watch, the price of which will be between 12,000 and 15,000 francs, will have a diameter of 6 centimetres, equal to 2 3/8 inches, and a thickness of 20 to 22 millimetres, equal to a little less than 1/2 inch; thus it will be of a size adapted to be easily carried in a vest pocket. Let us take an ordinary watch with a small seconds hand, but without a minute hand, and let us add successively the following points:

**FIRST:** Two dials side by side upon the face, each independent of the other; these will show the time of two different countries.

**SECOND:** A minute repeater; by pushing the button the bell will sound the hours or quarters and minutes.

**THIRD:** "Une grande sonnerie"—when the hands pass the hour or the quarter, the bell will strike of itself.

**FOURTH:** An alarm; there is no explanation needed regarding this, but one observation is to be made: will the ringing of the bells be satisfactory for the proposed purpose?

**FIFTH:** A chronograph hand from the center showing the fifth seconds, which has not been utilized to the present day.

**SIXTH:** A double chronograph hand, independent of the foregoing.

**SEVENTH:** A minute marker at the service of the chronograph hands.

**EIGHTH:** A center seconds hand moving with lightning rapidity, traveling around the dial once a second, and stopping five times, indicating fifths of seconds.

**NINTH:** A dial showing by a hand the defects each day between the mean time and a correct time for a certain meridian.

This is one of the grandest victories in modern horology.

**TENTH:** A bi-metallic thermometer.

**ELEVENTH:** A perpetual calendar; that is to say, three dials and as many hands, showing the week day, the date and the month, without its being necessary to make corrections even in leap years.

**TWELFTH:** Perpetual phases of the moon. This calendar system showing any date, month and phase of the moon will be so constructed that at every midnight all the hands will jump together and indicate the next day. The invention of this perfect device is of quite recent date.

**THIRTEENTH:** A barometer on the cap inside of the watch.

This will be a watch without a parallel. The addition of a solar dial and a compass is also contemplated. What else could be added? Naturally this watch will be adjusted to heat, cold and position, as are all other timepieces of precision. It is the perpetual calendar especially that excites curiosity. It is hardly possible to believe that such a small and complicated watch, containing such a large number of wheels, can indefinitely perform with such precision, and establish the difference between the months of 30 and 31 days.

An officer of the English army, Major St. ———, possesses a similar watch. One evening, on the 28th of February of a leap year, he was at his club and was boasting of the qualities of his timepiece. His companions were, of course, incredulous, and would not believe that the watch would show the 29th of February without being touched or set for such a feat. The discussion grew lively, and 1,000 guineas were wagered. The watch was sealed up and put into the safe of the club house for the night. The next morning it was found that the watch showed the exact date. Of course, the Major had won his bet, but some one insinuated that the watch then indicating the 29th of the month, would, on the following morning show the 30th, instead of the 1st of March. Thereupon the watch was again sealed up and placed in the safe to remain over night. When opened the following morning it was found to indicate the 1st of March. The Major's friends were more than amazed, and the 1,000 guineas were paid over to him.

Pocket calendars are round silver disks with raised backs.

### Fashions in Jewelry and Silver-Ware.

A LADY'S RAMBLES AMONG THE JEWELERS.

The tiniest of alcohol lamps are now prepared for the smoker.

A new belt is made of shells fastened together with flexible links.

Fine large pearls are superb sleeve buttons surmounted by tiny diamonds.

A little pocket piece contains chamois and flannel leaves and is intended for needles.

A new thermometer is a silver circle supported by a back leg like a photograph frame.

A charming chatelaine pin is an overlapping wreath of white enamel leaves with a tiny pearl between.

A handsome design is a diamond fleur-de-lis holding by two diamond chains a bar made of four lustrous colored pearls.

The Roman fasces of white enamel and gold tied with ribbons and hung with a white enamel wreath is a distinctly novel and pretty brooch.

Hairpins with gold enameled balls are among the prettiest novelties. The ball may be of white enamel with gold markings, or gold and dark blue.

A necklace is made of small chrysoberyls and pale blue sapphires. These are connected by little gold disks, and have two lower festoons similarly combined.

There is a distinct fancy for circular brooches. One is of white enamel circles each holding a small pearl, with pearls on the outside. Another is of alternate sapphires and diamonds.

Imperfect pearl growths are used in the handsomest jewelry. A brooch was made of leaf shapes in dead rough gold with indented edges set around a central disk. Each held a large imperfect pearl.

A new spool holder has holders for eight spools and two places for special silks. The central column around which these revolve holds the thimble on the apex. When the thimble is removed this column opens for long needles and bodkin. Each spool similarly turns on a cylinder with a cover which is intended to hold needles. These are of different sizes. A new spool holder is in the form of a high chair. The spools are between the legs. The seat of the chair is a pin cushion. Another form is a stove.

ELSIE BEE.

## VICTOR. ⊗ ⊗

SIMPLEST FEED. ALWAYS THE SAME. GUARANTEED FOR ONE YEAR.

### THE VICTOR FOUNTAIN PEN

(Pat. Feb. 4, 1890.)

THE BOSTON PEN CO.,  
N. C. Whitaker & Co., Proprietors.

363 Washington Street, - Boston, Mass.,  
Manufacturers of finest quality

TORTOISE : SHELL : AND : HORN : GOODS  
in every variety. Also Aluminum Hair Pins.

Send for illustrated Pen Price List No. 1.

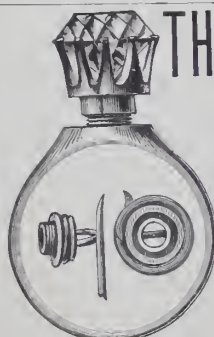

## THE BONNER COMBINATION

RING, SCARF PIN AND STUD.

The Best Combination ever made.

MANUFACTURED BY

BONNER, RICH & Co.,

Makers of DIAMOND MOUNTINGS  
RINGS A SPECIALTY.

To the Jobbing Trade Only.

41 MAIDEN LANE, NEW YORK.  
Factory, 44, 46 and 48 Hill St., Newark, N. J.



# FERDINAND BING & Co.,

106 GRAND ST., N. Y.

SPECIALTIES IN IMPORTED CLOCKS,

MARBLE STATUARY AND BRIC=A=BRAC

FOR THE JEWELRY TRADE.

ENAMELED AND TRANSPARENT SPOONS FROM ALL PARTS OF THE WORLD

NEW! IMPROVED NEW!  
Adjustable "Eclipse" Eye Glasses.

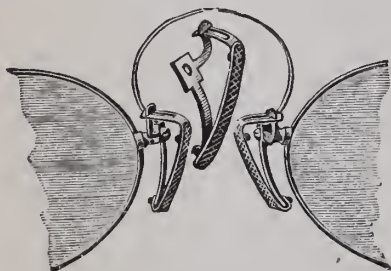

PATENT APPLIED FOR.

We claim this invention to be the only one which combines the advantages of both the adjustable and offset guards. We will furnish these frames or guards by Sept. 1st, in either Zylonite or Cork.

WRITE FOR CIRCULAR.

JOHN SCHEIDIG & CO., SOLE AGENTS,  
43 MAIDEN LANE, NEW YORK.

**HENRY GOLL & CO.,**

17 JOHN ST., NEW YORK.

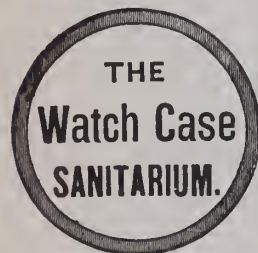

SPECIAL CASES  
MADE TO  
ORDER  
AND  
REPAIRING IN  
ALL ITS  
BRANCHES.

**Rich Cut Glass**

AND

DECORATED ART WARES.



'Mt. Washington Glass Co.,

New Bedford, Mass.

RICH DISPLAY OF GOODS AT

New York Store: 46 Murray St.



When you visit Chicago do not fail to inspect our full line of goods at the new store of Pairpoint Mfg. Co., 224 Wabash Avenue.



GLASS CUTTER AT WORK.

We Have Removed to ●●●●●●●●●●  
**57 MAIDEN LANE.**

**LEONHARDT & CURRAN,**  
MANUFACTURERS OF DIAMOND MOUNTINGS.

No File Equals the "GLARDON" File

is the universal verdict  
of the trade.



LARGEST ASSORTMENT IN  
THE UNITED STATES.

**F. W. GESSWEIN,** 39 John Street, New York.

SOLE AGENT FOR UNITED STATES AND CANADA.



### World's Fair Exhibit of Ch. F. Haviland China.

THE exhibit of Ch. Field Haviland china in the French section of the Manufactures building at the World's Fair, is magnificent in its entirety and in detail. In a post of honor eminently fitting such an exposition of the porcelain maker's art, the firm have produced a display that is at once a

with tables covered with cloth to match the draperies. This arrangement facilitates the examination of the wares, as all can be reached without effort

The banquet service on the centre table is a masterpiece of the factory and consists of 210 pieces, including center and end pieces, decorated in *couleur de four* (underglaze colors fired at a heat of 3000° F. and is valued at \$3000. Four large ornamental flower

ly modeled, and a flaxen haired child reclining with arms outstretched. The jagged mount is a delicately shaded grayish blue with high lights accentuated in gilt. The shades of lilac, blue, gray, white and gilt are finely contrasted and combined with artistic modeling form a piece of rare beauty. The interiors of the bowls are tastefully decorated with scattered sprays of hand painted flowers, the seeming intention having been



THE PAVILION OF E. GÉRARD, DUFRAISSEIX & CO., HAVILAND & ABBOT, AGENTS.

study for the connoisseur in art subjects and a source of pleasure for lovers of the beautiful. Their covered court has entrances in the center of each of its four sides with arches and open spaces draped with wine colored billiard cloth. A large oval table occupies the center of the pavilion and the sides between the entrances are taken up

bowls, each some 24x18 inches and 4 inches deep, surround a mount of scroll work on which partly recline two female figures, barefooted and in French peasant dress, one in lilac and the other in blue. The postures denote merriment and the conception is well carried out, even to the features. By the side of the principal figures are a goat, fine-

ly modeled, and a flaxen haired child reclining with arms outstretched. The jagged mount is a delicately shaded grayish blue with high lights accentuated in gilt. The shades of lilac, blue, gray, white and gilt are finely contrasted and combined with artistic modeling form a piece of rare beauty. The interiors of the bowls are tastefully decorated with scattered sprays of hand painted flowers, the seeming intention having been

to simply relieve the broad expanse of white. An inch band on the outer edge of the bowls is of light mauve bearing floral decorations of darker shade and a rim of gilt. At each end of the centerpiece is a child conforming to the general figure designs. Each bowl rests upon four scroll legs extending but one-half inch below the base,

## The Connoisseur.

(Continued from page 45.)

the design on the two front feet being carried to the rim of the bowl in a neat panel scroll of shaded mauve, with a decoration of darker mauve and gilt. The Cupids at either end of the piece are supported by heavy scroll bases and the jointures of the bowls are similarly treated and embellished with grains, fruits and flowers in relief.

In the end pieces the four bowl design is carried out, but each is irregular in shape, of differing size and partakes more of the shell pattern. At the back center of one, the Goddess of Flowers sits on a raised mound with blossoms scattered about her feet, and with her dress gathered up in both hands Flora holds in her lap a wealth of flowers. In the other Ceres, with golden sickle in her right hand, holds in her left a sheaf of freshly garnered grain. The smaller bowls, tureens and platters are treated in the artistic designs above described. The general design of the smaller pieces is a floral decoration extending over the drop, and a melted mauve rim containing six paneled scrolls equi-distant, outlined and decorated with light lines of gilt. A description and illustration of the centerpiece of the Exhibition dinner service were given in a previous number of THE CIRCULAR.

The three large tables on the west side of the exhibit are laden with all the treasures

of underglaze hard fired, produced at the factory. These consist of fish and game sets, roast course sets, jardinieres, etc. Some rare effects are shown in a delicate shade of light chocolate, wherein the colors are applied to the places usually left plain, the design being left unpainted, giving a relief effect of white that is truly beautiful. The order of painting on China is simply reversed and the colors as applied leave the original ware pattern seemingly standing out in bold relief though the surface is perfectly smooth. This is a class of high art that is destined to become very popular with connoisseurs and credit is due the firm for originality in the process.

The exhibit is remarkable for the articles decorated with oxide colors, fired at a heat of 3,000 °F in the same kiln as the white ware is baked; also for the absolutely new manner in which this style of decoration is applied. From a ceramic standpoint, this constitutes an indisputable and decided advance upon the methods hitherto employed. A glance will enable one to recognize this difference and to compare these with other articles in the same exhibit that have been decorated by the ordinary processes, or with the other exhibits of hard porcelain, (*porcelaine dure*).

The oxides formerly employed produced only sombre colors and it was impossible to make this kind of decoration attractive. Table services demand a bright, cheerful appearance, and these desirable qualities not

being attainable with underglaze decorations, purchasers have preferred others made with greater or less care and usually with relief or "raised" gold, which produces an effect like tinsel. With their new discoveries the firm have attained the aim so long sought—to render practical the decorating of hard porcelain with colors produced by furnace heat (*au feu de four*.)

On other tables are five o'clock teas in large and varied lines; plates with beautiful French hand painted figures; plates with raised incrustated gold borders with flowers in relief; after dinner coffee cups and saucers, dozen in case, in Ribbon, Brittany, Limoges, Hebe and 20th Century patterns; dinner sets in Brittany, Ribbon, Limoges and Louis XV. running through all wares; a trinket set in shaded olive green with gilt ornamentation and solid mat gold handles, consisting of two colognes, pomade box, puff box, ring tray and comb and brush tray. The twelve piece sets have in addition two candlesticks.

Haviland & Abbot, 29 Barclay St., New York, are the agents for the factory in the United States. E. W. Abbot installed the exhibit but the firm have adopted a policy that gives each of six men associated with the firm an opportunity to enjoy a month at the Fair. L. S. Hinman and W. E. Knowles have stood their turns. G. S. Smallwood will remain in charge during August to be followed in turn by Willard Aikman and W. P. Miller.

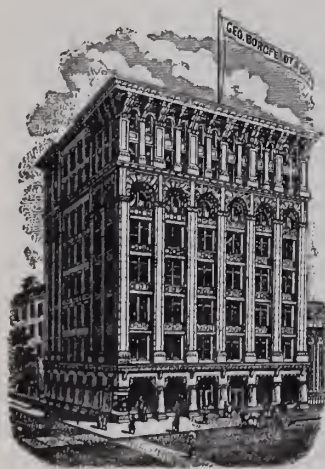

## Exceptional Opportunity

FOR

## Bric-a-Brac Buyers!

OUR entire collection of IMPORT SAMPLES comprising \$100,000 worth of HIGH ART NOVELTIES, specially imported for the Jewelry

Trade, are now on exhibition and will be sold on and after Sept. 1st, at **Big Reductions** to make room for new importations of Fine Pottery, Art Furniture, Marbles, Exclusive Art Productions, &c.

## GEO. BORGFELDT & CO.,

18, 20, 22 WASHINGTON PLACE, cor. Greene Street, NEW YORK.

**The Connoisseur.**

(Continued from page 46.)

**The Rambler's Notes.**

WHAT THE RAMBLER SAW AND HEARD AMONG THE DEALERS IN ART POTTERY, CUT GLASS, BRONZES, ETC.

A fine line of Italian glassware comprising fruit holders, cake dishes, flower holders, vases, bottles, ewers, glasses etc. has been opened by A. Klingenberg, 35 Park Place, New York. The odd shapes, peculiar decorations and beautiful colors make them exceedingly attractive. One of the peculiarities of this ware is the representation of a dragon or snake around the handle or stem of nearly all the pieces. A pleasing feature, is the beautiful combina-

tions of two, three or more colors shown in many pieces. Another new line which shows equally beautiful combinations of color is the assortment of Bohemian glass flower holders, hexagonal in shape with gold decorations. In many instances the color at the top of the holder is a deep green which gradually shades into a golden yellow tint at the centre, and thence into a beautiful red at the base. Holders in other combinations of colors and in the pure green and pure white glass are also evident in great variety.

\*

From the earliest days of history ivory has been considered an article of luxury. To-day, although ivory plays an important part in the manufactures, unlike other substances, its price is rapidly increasing. This is in part due to the gradual extirpation of the elephant, the chief source of supply, but

more so to the increasing demand for it as an article of luxury, which is owing solely to the great taste and skill of the artists who work in this material. The extraordinary progress which has recently been made in the beautiful art of ivory carving is well shown in the magnificent line of miniature figures, busts, groups, etc., carried by Lazarus, Rosenfeld & Lehman, 60-62 Murray St., New York. The workmanship in the busts, which are set on small pillars, is finely executed, particularly in those of the great musicians. The largest piece shown in this line, a ten inch copy of the "Awakening of Love," is one of the most exquisite pieces of ivory carving that has ever been shown in the United States, and will compare favorably with some of the most beautiful of the smaller pieces produced in India, where this art doubtless had its origin.

THE RAMBLER.



**ANNOUNCEMENT**

**FALL, 1893.**

OUR Importations for the coming season are now arriving and we have on exhibition at our ware-rooms a complete assortment of exclusive

**NOVELTIES AND SPECIALTIES.**

SELECTED FOR THE JEWELRY TRADE.

Clocks, Bronzes, Sevres Vases, Fine Decorated Porcelains, Cups and Saucers, Tea Sets, Lamps and gilt and silver plated filigree Photo Frames in endless variety.

**LEON. J. GLAENZER & CO.,**

35 Boulevard de Strasburg,  
PARIS.

80 & 82 CHAMBERS ST., N. Y.

**WM. BIRMINGHAM & CO.,**

MANUFACTURERS OF

All Kinds of Leather Spectacle and Eye Glass

**CASES,**

728 Arch Street, PHILADELPHIA, PA

**ALUMINUM SOLDER \$2.00 PER POUND.**

Instructions for using given gratis.

Practical Processes for Soldering, Dipping, Enameling, Etching, &c., of Aluminum.

C. DE REDON, 43 WEST 21ST ST., NEW YORK.



ESTABLISHED 1801.

**HINRICHS & CO.,**

29 & 31 PARK PLACE,

Cor. Church Street,

NEW YORK.

**Art Pottery and Bric-a-Brac,**  
CUT GLASS, FANCY GLASS, CHINA, LAMPS.

THE LARGEST ASSORTMENT OF SPECIALTIES FOR THE JEWELRY TRADE, AT LOWEST PRICES.

WOLFF & GUNZBURGER, Importers of DIAMONDS, 87 NASSAU ST., (Fulton Building), NEW YORK.

**FALKENAU, OPPENHEIMER & Co. DIAMONDS**  
40 MAIDEN LANE NEW YORK

**EMERALDS.**  
  
**M. D. ROTHSCHILD,**  
NEW YORK: 41 & 43 MAIDEN LANE  
LONDON: 15 HOLBORN VIADUCT  
PARIS: 58 RUE LAFFITTE.

**CHAS. S. PLATT,**  
1837. Successor to Geo. W. Platt, 1881.  
GOLD AND SILVER  
REFINER, ASSAYER  
AND SWEEP SMELTER.  
29 & 31 Gold St., Near John St. New York.  
Platers' and Electro-Platers' Silver  
Platinum and Aluminum.

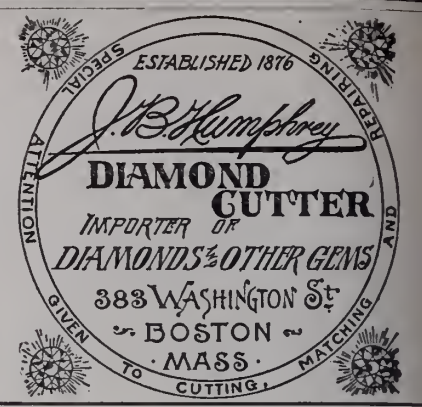

ESTABLISHED 1848.  
**DIAMONDS**  
**BRUHL BROS. & CO.**  
21 Maiden Lane, N. Y., 57 Rue de Chateaubain, Paris.  
**PEARLS**  
and other Precious Stones.

FRENCH WRITE FOR CATALOGUE. ENGLISH  
**CLOCKS**  
AND CLOCK MATERIALS.  
CHAS. JACQUES CLOCK CO., 22 CORTLANDT ST., N. Y.

**L. LELONG & BRO.,**  
GOLD AND SILVER  
Refiners, Assayers AND Sweep Smelters,  
SOUTHWEST CORNER HALSEY AND MARSHALL STREETS,  
**NEWARK, N. J.**  
SWEEPINGS A SPECIALTY.

**WHY** S. F. MYERS & CO. sell more goods than any other Wholesale Jewelry House.  
**BECAUSE** They are the only firm in the Metropolis who carry in stock a full line of everything a jeweler requires. They give the utmost values and endeavor to please their trade in every respect. Refer to their various publications and illustrated catalogues.  
**MYERS BUILDINGS, 48 & 50 Maiden Lane, NEW YORK.**

**HENRY FERA,**  
IMPORTER OF DIAMONDS  
AND DIAMOND BORTZ,  
Diamond Cutting and Polishing Establishment.  
10 Maiden Lane, NEW YORK.

**Paul Jeanne,** EIGHTEENTH STREET and 4<sup>TH</sup> AVE., N. Y.  
(Bradley Building.)  
MANUFACTURER OF  
**FINE DIAMOND JEWELRY.**  
ESTABLISHED 1870.

**S. P. HOWARD,**  
Gold and Silver Assayer.  
Refiner and Sweep Smelter,  
33 MAIDEN LANE, NEW YORK.  
Smelting and Refining Works,  
28 & 30 Cumberland Street, Brooklyn, N. Y.  
Specialties: Sweepings, Gold, Silver and Platinum

**J. L. CLARK,**  
SWEEP SMELTER AND REFINER OF GOLD AND SILVER.  
Buys every kind of Gold and Silverware, Jewelry, Watches and Platinum. Full market value paid.  
No. 724 Filbert Street, Philadelphia, Pa.  
SEND BY EXPRESS or Registered Mail. If my price is not satisfactory, I will return all articles.

**ALBERT LORSCH & CO.**  
37 MAIDEN LANE, NEW YORK.  
Branch, 167 Broad Street, Providence, R. I.

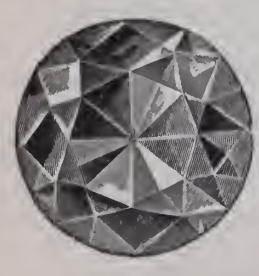

— **IMPORTERS OF DIAMONDS,** —  
Rose Diamonds, Rubies, Sapphires, Emeralds, Opals, Moonstones, Fancy and  
IMITATION STONES, NOVELTIES.



SOLE OWNERS AND IMPORTERS OF *The Sumatra Gem.* REG'D.

**IT PAYS** TO KEEP IN TOUCH WITH TRADE AFFAIRS. THE JEWELERS CIRCULAR, For 4c. a Week will do it. **Subscribe.**



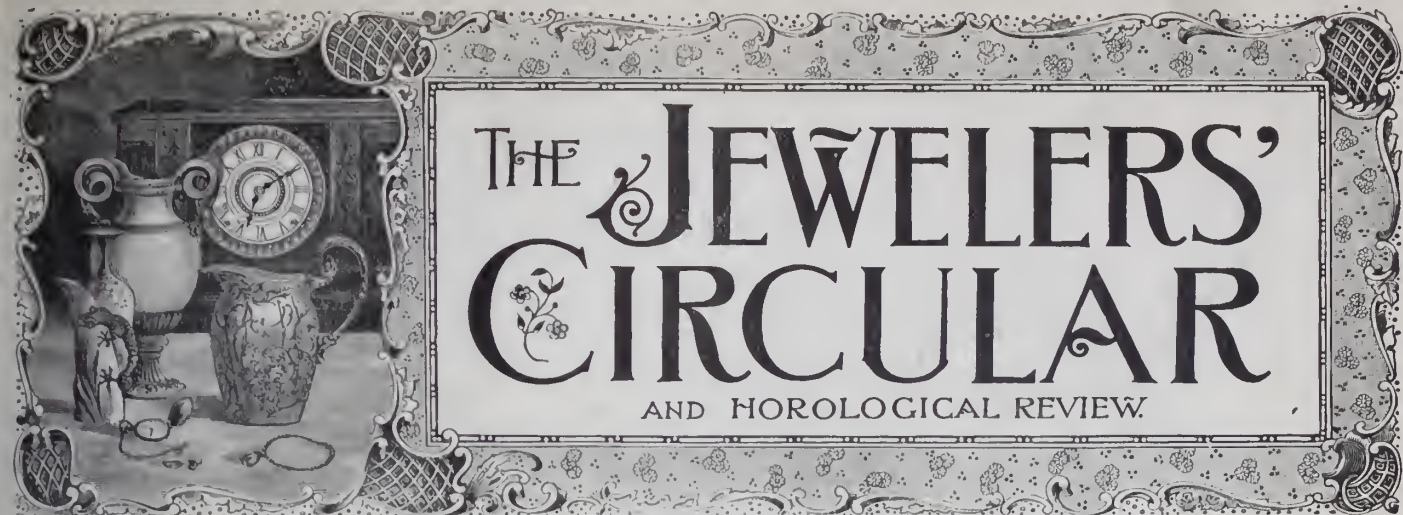

# THE JEWELERS' CIRCULAR

## AND HOROLOGICAL REVIEW.

Copyright, by THE JEWELERS' CIRCULAR PUBLISHING CO.

189 Broadway, New York.

Entered at the Post Office in N. Y. as second-class matter.

VOL. XXVII.

NEW YORK, WEDNESDAY, AUGUST 30, 1893.

NO. 5.

### ARTISTIC WORK IN MASONIC JEWELS.

REFERENCE was already made to the magnificent masonic jewel here illustrated, in a previous number of this journal. The jewel which has just been finished by the Jaccard Watch & Jewelry Co., Kansas City, Mo., is of a character that entitles it to serve as a model in the class of work of which it is representative, to badge makers and artisans in the precious stones and metals generally. It is considered the handsomest and most costly lodge emblem ever seen in Kansas City.

The jewel is a solid gold cross, four and one-half inches long, with proportionate width, and weighing one-fourth of a pound. On it are all the emblems of the orders to which the party for whom it was made belongs. The square, compasses and the letter G represent the master mason; the keystone is an emblem of the chapter degree; the Maltese cross indicates the knight templar; the broken triangle shows the wearer to be a member of the royal and select masons; the double eagle is typical of the thirty-second degree mason, and the claws reveal the Mystic Shrine order. On the back of the cross is the name of Pedros Ferdinand Nishkian to whom the emblem has been presented, together with appropriate devices relating to his life. A large diamond glistens from the mass of solid gold. Mr. Nishkian will wear the jewel at all times beneath his clothing.

The photograph from which the engraving was reproduced was taken expressly for the purposes of THE CIRCULAR.

Work. Some of them set up in England in the seventeenth century are furnished with curious devices, which have gradually

and who used to move and follow the course of the sun. Most of them are attached to the bells and chime the hours.

Stamford, which we may almost look upon as a legacy from Queen Elizabeth's Lord Burleigh, is rich in the matter of church clocks, and over all the Elizabethan houses, with their bay windows and dormers and sunny gardens full of pear trees and bees, and over the wide river and lowly meadows by the side of it, passes a wave of silvery sound every quarter of an hour that is delightful to hear. On Uffington church in the same neighborhood the clock face has the semblance of a hatchment. The tower is capped with a very lofty crocheted octagonal spire with flying buttresses, and on the string course of the third stage is fixed the dial in question.

Further north, about seven miles out of Newcastle, is the pleasant village of Ponteland. Situated beyond the influence of the smoke of the numerous works along the Tyne, it is very green and leafy. The chief hostelry is an addition to an old fortified tower, with archways, mullioned windows and turrets, and is a fair specimen of ancient Border architecture. The vicarage house stands in well wooded grounds where there are the remains of another bell tower. The church is on a large scale, and has a tower like many others in this contested part of the country that could afford protection to many refugees when occasion required it to do so. Within this valiant old tower is a clock, and on the face of a large dial, six feet across, it shows the time

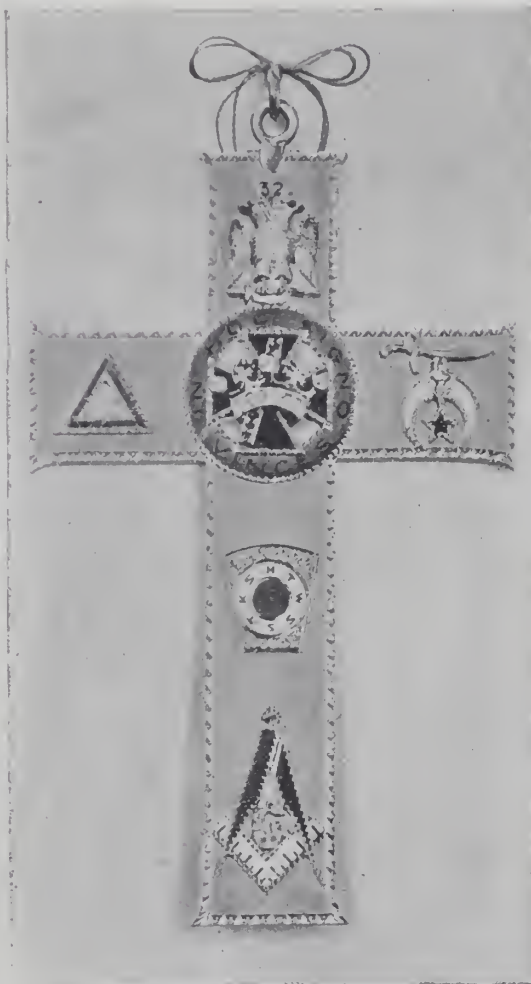

COMBINATION JEWEL OF MASONIC EMBLEMS.

### Church Clocks.

IT must be allowed that church clocks in country towns are very considerable additions to the general convenience of the inhabitants, says the *Christian at*

got out of order, as in the case of the Church of St. Martin-le-Grand, York, which had the figure of a naval officer on the top of it in the act of taking a solar observation,

of day, like an admonition to all who care to look up at it. The greater number of small churches in rural districts, however, have to content themselves with mural sundials.

THE BEST QUALITY

ELECTRO SILVER PLATE

IS STAMPED

★ ROGERS & BRO., A. S.

THE  
Original, Genuine  
and  
Celebrated

STAR ★ BRAND

WHICH  
HAS STOOD THE  
TEST FOR 50 YEARS.

MADE ONLY BY

ROGERS & BROTHER,

WATERBURY, CONN.

16 CORTLANDT ST., NEW YORK.

MAKERS OF THE FOLLOWING LEADING PATTERNS:

"COLUMBIA," "SAVOY," "TUXEDO" AND "ASSYRIAN."

NEW ILLUSTRATED CATALOGUE NOW READY.

"COLUMBIA."



"SAVOY."

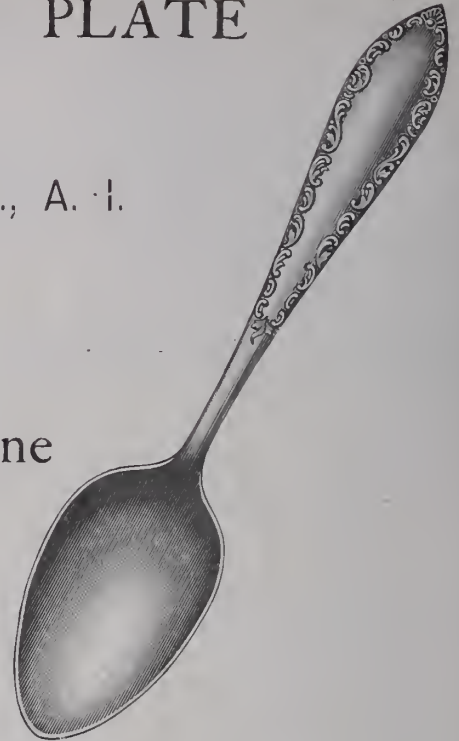

"TUXEDO."



"ASSYRIAN."



# ARTISTIC METAL GOODS.

NEW DESIGNS,  
NEW FINISHES.

Our line of Pitchers, Vases, Tables, Candlesticks, Five O'Clock Teas, Etc., cannot be equaled.

## THE CELEBRATED "B & H" LAMP.

BEAUTIFUL DESIGNS,

particularly adapted to the Jewelry Trade.

SEE OUR LINE OF

TABLE, BANQUET AND PIANO LAMPS

before placing your orders. Send for our Little Book.

### BRADLEY & HUBBARD MFG. CO.

NEW YORK, BOSTON, CHICAGO,  
21 BARCLAY ST., 160 CONGRESS ST. 88 WABASH AVE.  
26 PARK PLACE Factories, MERIDEN, CT.



## THE BEST BUTTON MADE.

THE KREMENTZ

IN GOLD

FROM

KREMENTZ & CO.

and all Jobbers.



ONE PIECE

FROM

IN ROLLED PLATE

ALL JOBBERS.

COLLAR BUTTON.

IS THE ORIGINAL ONE PIECE BUTTON.

IS STILL THE BEST AND STILL UNSURPASSED.

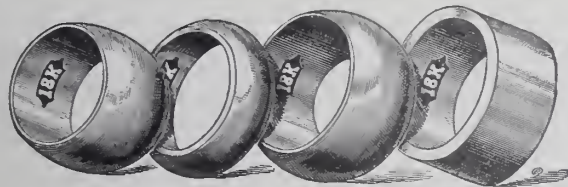

PLAIN SOLID GOLD RINGS.

HILDRETH MFG. CO.,

53 MAIDEN LANE,

NEW YORK.

## LATEST AND BEST ELK'S TOOTH BADGE.

CAN BE USED AS A CHARM BY SIMPLY DETACHING BAR FROM TOOTH.



Reverse shows the symbolic flower of the Benevolent and Protective Order of Elks, the forget-me-not, beautifully enamelled in colors; also the letters B. P. O. E.

MANUFACTURED BY

G. A. SCHLECHTER, READING, PA.

DON'T FORGET the JEWELER'S CIRCULAR PUBLISHING CO.'S BOOK LIST when in want of any technical book in the Jewelry or Kindred Trades.

ESTABLISHED 1837

GEO. O. STREET & SONS,

MAKERS OF

Fine Rings, Locketts, Seals,  
Sleeve Buttons and Links,  
15 John Street, NEW YORK.

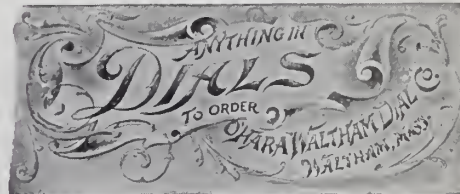

All the illustrations in this issue were made by

W. H. BARTHOLOMEW.

PHOTO-ENGRAVER,  
8 SPRUCE ST.. NEW YORK.

Jules Jürgensen

OF COPENHAGEN.

The reputation these watches have maintained for Fifty Years has never been equalled, being made on strictly scientific principles and no expense spared to give the Best results in mechanism and timekeeping qualities.

SOLE AGENTS,

John C. Hyde's Sons,  
NO. 22 MAIDEN LANE.



“DO YOU KNOW?”

THAT GOODS FREE FROM SOLDER ARE THE BEST?

THAT GOODS MADE FROM SEAMLESS WIRE ARE SUPERIOR IN FINISH ON THIS ACCOUNT?

THAT SEAMLESS WIRE MAKES THE BEST FILLED CHAINS?

THAT WE ARE THE MAKERS OF THE ORIGINAL AND CELEBRATED

SEAMLESS GOLD FILLED CHAINS?

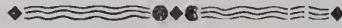

Do not fail to visit our beautiful and artistic display at the World's Fair. The finest of its kind at the Exposition.



Northeast Corner of Manufactures Building, Department O.  
Right on the corner. See Official Catalogue.

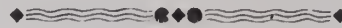

Kent & Stanley Co.,

BRANCH OFFICES:

NEW YORK : 17 MAIDEN LANE. SAN FRANCISCO : PHELAN BUILDING.  
BOSTON, 58 WINTER STREET, MONTREAL, TEMPLE BUILDING.

MAIN OFFICE AND WORKS:

PROVIDENCE, R. I.

**AIKIN, LAMBERT & CO.**  
19 Maiden Lane, NEW YORK.  
Branch, 42 & 44 East Madison St, CHICAGO, ILL  
Manufacturers and Exporters of  
Gold Pens, Holders, Picks, Pencils  
Fountain Pens, etc.

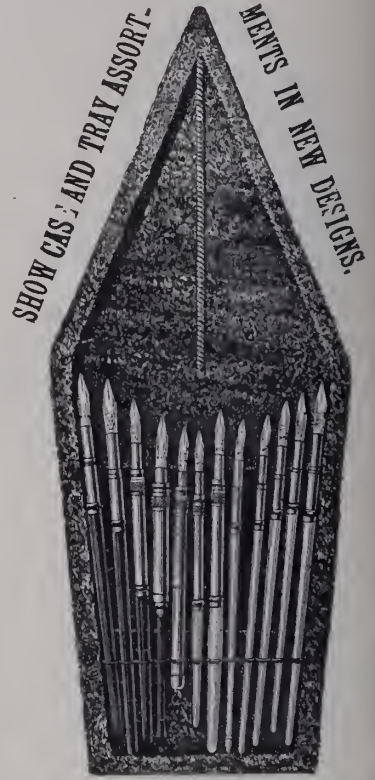

11 x 5 1/2 inches.

PLUSH TRAY WITH EASEL BACK.

1 Doz. 16 K. Pens and Assorted Holders, List, \$31  
1 Doz. 10 K. Pens and Assorted Holders, List, \$24  
Send for Trade Discount.

**OPTICIANS' SUPPLIES**

Jobbing and Prescription Work.

The "Graduate" Trial Cases, 180 lens set, \$30.00; 220 lens set, \$37.50. The "Standard" Trial Case, 220 lens set, \$65.00. All with lenses. Loring Ophthalmoscope, \$30.00. Artificial Eyes, for selection, \$1.00 each, \$30.00 for a hundred. Ophthalmometers, \$50.00 to \$70.00. Queen's Standard Perimeter, \$18.50. Queen's Lens Grinding Outfit, \$30.00. Steel Frames, 15 to 20 cents each. Spherical Lenses, 25 cents per pair. Cylinders, 30 cents per pair. Lenticular Bifocals, 80 cents per pair, full box. Queen's Lenses, 50 or 60 shells. German Silver, \$1.00 per dozen pairs. Total \$50 per dozen pairs.

**QUEEN & CO.** Opticists and Opticians,  
Catalogue free. 1010 Chestnut St., Phila., Pa.



AMERICAN RAILWAY SUPPLY CO  
24 Park Place, NEW YORK.

For **BADGES AND MEDALS.**

Flag Pins, Class Pins, Class Rings  
and Special Work of all Descriptions  
SEND TO **E. R. STOCKWELL**, MANUF'G.  
19 John Street, New York

# THE FAIRPOINT MFG. COMPANY.

NEW BEDFORD, MASS.

FLATWARE.

HOLLOW WARE.

- BERRY FORKS.
- BERRY SPOONS.
- ICE CREAM KNIVES.
- ICE CREAM SPOONS.
- SALAD SETS.
- OYSTER FORKS.
- FISH SPEARS.
- PUNCH LADLES.



2410.—OVAL TUREEN.

- BERRY SETS.
- BERRY DISHES.
- ICE PITCHERS.
- ICE TUBS.
- SALAD BOWLS.
- OYSTER LADLES
- WINE SETS.
- PUNCH BOWLS.

NEW YORK,  
60 MAIDEN LANE.

CHICAGO,  
224 WABASH AVE.

SAN FRANCISCO,  
220 SUTTER STREET.



SPECIALTY: SALES OF  
**JEWELRY, BRIC-À-BRAC**  
 AND  
 ARTICLES OF VERTU

We sell to the legitimate Jewelry and Stationery trade only.



## CHOICE PAPERS

MAKERS OF

# FINE STATIONERY

For Correspondence, Wedding and Business Use, handsomely boxed, specially suited to the Jewelry Trade.

18 MURRAY STREET, NEW YORK.

### Bruner Plating and Jewelry Rep. Co.

Jewelry Matched and Repaired, Engraving,  
 Chasing and Enameling, Setting, Polishing and  
 Lapping, Battery Gilding and Roman Coloring,  
 Watch Cases Repaired, Polished and Gilded.

32 Maiden Lane, New York.

# WORLD'S FAIR SOUVENIRS.

\* STERLING SILVER. \*



THE COLUMBUS.



REVERSE SIDE OF HANDLE.



REVERSE SIDE OF HANDLE.



THE DISCOVERER.



REVERSE SIDE OF HANDLE.



THE AMERICAN.

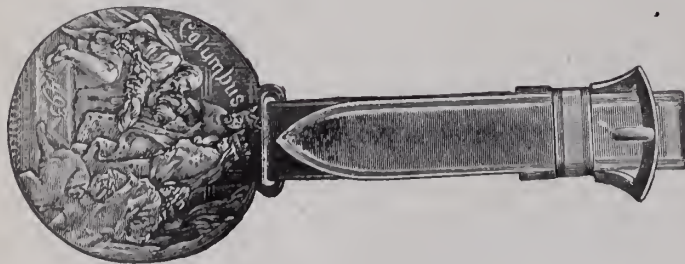

No. 2. BAGGAGE CHECK.



MATCH BOX.

## R. WALLACE & SONS MFG. CO.,

SILVERSMITHS,

WALLINGFORD, CONN.

NEW YORK:  
3 PARK PLACE.

CHICAGO:  
86 WABASH AVENUE.

**Arrest of a Thief who Skipped his Bond.**

BIRMINGHAM, Ala., Aug. 24.—At Bridgeport, this State, Guy Bowne who it is said was in some way connected with a big robbery of the jewelry store of Carl Bradish, Kalamazoo, Mich., two or three years ago, and who is alleged to have skipped a \$1,000 bond was arrested this week and lodged in Jackson County jail, Scottsboro, Ala. It is said that a large reward was offered for Bowne's apprehension.

The full facts of the charge against Bowne are not known here but the arrest was made on advices received from the authorities at Kalamazoo.

**A Gold, Silver and Nickel Plating Business for St. Joseph.**

ST. JOSEPH, Mo., Aug. 24.—George C. Darche, of Chicago, has written to Secretary Maxwell of the Commercial Club, of this city, to ask what the outlook would be in St. Joseph for the establishment of a gold, silver and nickel plating shop here. Mr. Darche is the inventor of a number of electrical appliances which he will manufacture.

Secretary Maxwell has informed the correspondent that the outlook is good and has asked him to come to St. Joseph and look over the field. The shops would employ about fifteen or twenty men to start with.

**Smashed a Jeweler's Window because of His Distress.**

Raymond Scott, a carpenter, walked into the police station in E. 104th St., New York, last Tuesday, and surrendered himself, stating that he had thrown a brick through the window of a jewelry store on Third Ave. The store is kept by Isaac Boltansky, formerly of 61 Nassau St., but now at 1876 Third Ave.

When arraigned in the Harlem Police Court, Wednesday, Scott stated that he had no work and was starving. The act was not prompted by a vicious nature nor a malicious spirit; he simply wished to do something that would put him where his distress would for a time at least be ended. Justice Welde sent him to Blackwell's Island for six months. The broken window was of plate glass worth \$125 and was fully insured.

An attempt was made, a few days ago, to break into A. T. Robert's jewelry store, Haughville, Ind. The window was smashed with a coupling-pin, but the noise awoke the proprietor and brought the marshal and his deputy quickly to the scene. A number of tramps were arrested next morning, but nothing criminating was found upon them.

**CLEAN JEWELRY SELLS QUICK.**

Quarters' Cleaning Solution removes dirt and tarnish in an instant, makes stock like new and brings up diamond and stone work to a beautiful lustre. Solution can be used over and over. Highly commended by all who use it. Send at once \$1.50 for half gallon with full directions. References.

W. F. QUARTERS, ELECTROPLATER,  
139 EDDY STREET, PROVIDENCE, R.

**BIPPART & CO.**  
MANUFACTURERS OF  
**DIAMOND JEWELRY**  
NEWARK N.J.

BROOCHES,  
SCARF PINS,  
HAT PINS,  
HAIR PINS,  
EARRINGS,

LINK BUTTONS,  
CUFF PINS,  
BRACELETS,  
NECKLACES,  
RINGS.

NEW YORK OFFICE 19 MAIDEN LANE

**THE BOWDEN SEAMLESS RING**

IS MADE ONLY BY

**J. B. BOWDEN & Co.,**  
Makers of Finger Rings of every Description  
**COR. BROADWAY & JOHN STREET,**  
**NEW YORK.**

**J. B. & S. M. KNOWLES CO.,**

MAKERS OF

**Sterling**



**Silverware.**

FACTORY,  
Providence, R. I.

SALESROOM,  
860 Broadway, N. Y.

**O. W. BULLOCK & CO.,**

SPRINGFIELD, MASS.

Makers of Watch and Jewelry Tools,

NEW CATALOGUE NOW READY.

Sent on Application.

Please Mention this Paper.

JACOT & SON  
IMPORTERS AND MANUFACTURERS  
OF  
MUSICAL BOXES  
298 BROADWAY.  
NEW YORK

# THE "SANDRINGHAM"

PATENTED JANUARY 24TH, 1893.

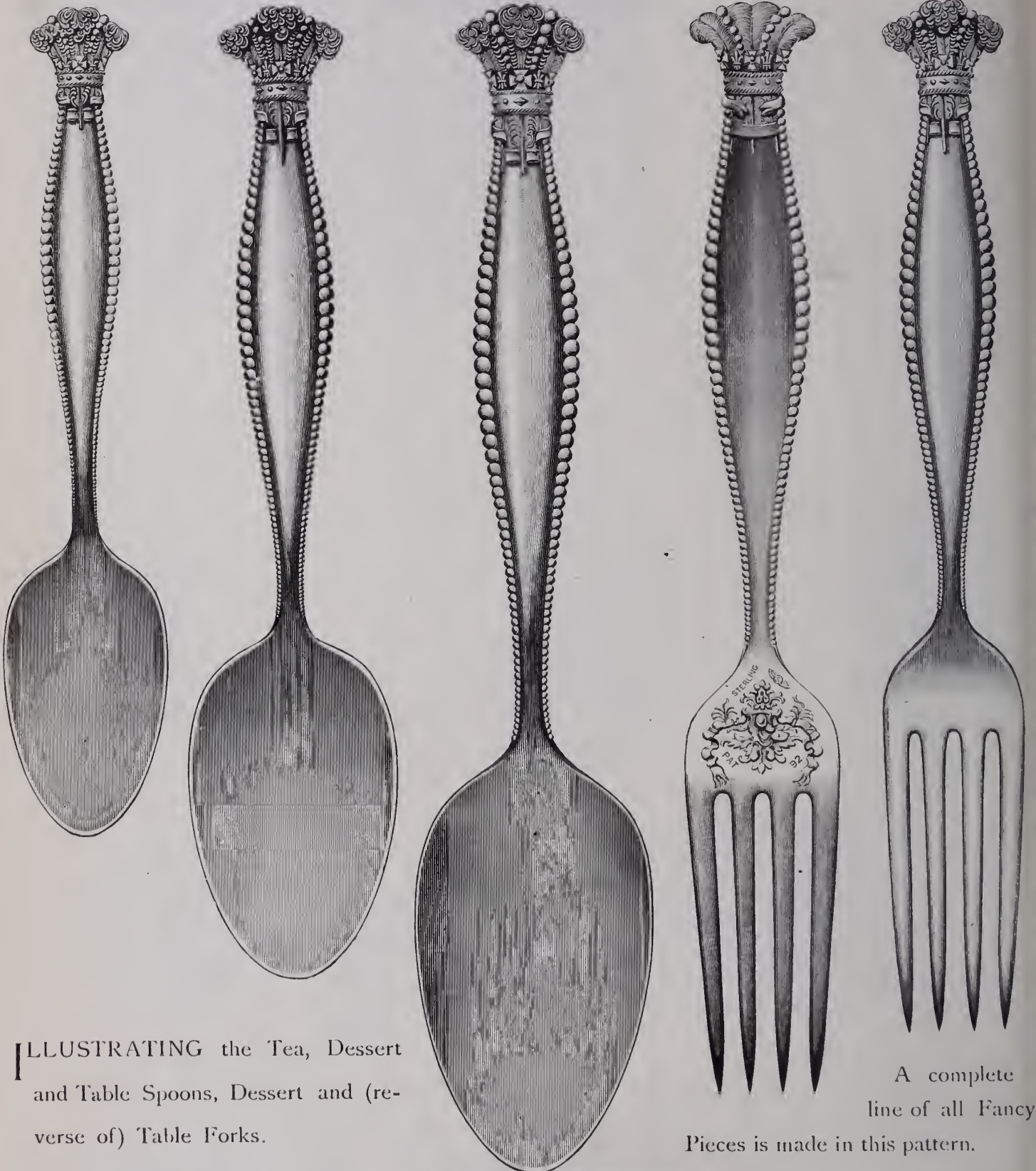

ILLUSTRATING the Tea, Dessert and Table Spoons, Dessert and (reverse of) Table Forks.

A complete line of all Fancy Pieces is made in this pattern.



Geo. W. Shiebler Co., Of the Silversmiths' Company, 179 Broadway, N. Y.



**The Death of Frederick E. Parsons.**

Frederick E. Parsons, secretary and treasurer of the Brooklyn Watch Case Co., died Wednesday at South Egremont, Mass., where he was spending the Summer season. His death was due to complications arising from an attack of malarial fever with which he had been suffering for some time past. Mr. Parsons, who was the son of the late Lewis A. Parsons, president of the Brooklyn Watch Case Co., was born at Manlius, N. Y., Nov. 11th, 1851. He received his education at the Brooklyn Polytechnic Institute, and after graduating therefrom first entered business with Fellows & Co., 17 Maiden Lane, New York. A few years later he became salesman for Wheeler, Parsons & Hayes, in which his father was partner. He left this firm to enter upon the business of a stock broker, and was until six years ago, junior member of the firm of Roundfit & Parsons, at Broad St. and Exchange Place. He sold out his membership in the Stock Exchange to become the secretary and treasurer of the Brooklyn Watch Case Co.

Nine years ago Mr. Parsons married Miss Mary B. Smith, daughter of the Rev. James Morgan Smith, of Grand Rapids, Mich. His wife and three sons survive him. The funeral services were held Friday afternoon at the residence of his mother, 746 St. Mark's Ave., Brooklyn, N. Y., the Rev. Theodore L. Cuyler, officiating.

**Death of a Pioneer California Jeweler.**

HARTFORD, Conn., Aug. 26.—The body of George H. Parker, of San José, Cal., arrived in this city yesterday for burial. Mr. Parker was a native of Bristol, and was seventy-five years of age. He removed to Hartford, but in 1858 went to San Francisco, where he resided until six years ago, when he changed his residence to San José. In California he conducted a clock and jewelry business. This, however, was not as profitable as he desired, and by small

speculations he succeeded in becoming the owner of several business lots. Though purchased with but small capital, time increased their value so that about twenty years ago he retired from active business life and merely attended to his possessions.

Mr. Parker's death resulted from a runaway accident, a tram of horses crashing into the carriage occupied by himself and his housekeeper. He died on the 17th inst.

**Arrested While Disposing of Stolen Watches and Cases.**

LANCASTER, Pa., Aug. 25.—James Perry, a young colored man, was arrested in this city on Wednesday while trying to dispose of a gold watch and several watch cases. It subsequently developed that Perry was the thief who on Tuesday morning smashed a window of Frank E. Bailey's jewelry store, Steelton and grabbed about \$75 worth of goods.

On being confronted with the facts Perry confessed and was sent to Harrisburg for trial.

**The Handkerchief Trick Did Not Work on This Salesman.**

CHICAGO, Ill., Aug. 25.—A man named Texas, with many other aliases, tried the handkerchief trick this week on Harry Leon, salesman for E. H. Goodrich & Co., 90 E. Madison St. The fellow went into the store and asked to look at some diamond lockets. The tray was brought and he looked them over pretty thoroughly. Then he asked to see another tray. This the clerk brought also, but noticed that the customer kept one hand clinched and closed against his breast while he used the other in handling the gems.

These actions aroused the clerk's suspicions, which were still more excited when the man mopped his face with a silk handkerchief and then put that in the clinched hand. When the man finally prepared to go out and lifted this hand to replace his handkerchief in his pocket the clerk snatched it away and the locket fell out. The man started to run and then the clerk pulled out his revolver, threatened to shoot, and gave chase, capturing his man after a pursuit of one block.

**Hair Pin and Eye Glass Chain COMBINED.**



This illustrates the Hair Pin and Eye Glass Chain Combined. It is one of the most dressy as well as the most comfortable ways of securing the Eye Glass ever put on the market, and it is justly becoming very popular.

**S. F. MERRITT, Manufacturer,**

N. Y. Office, 194 Broadway.

SPRINGFIELD, MASS.

**MATHEY BROS., MATHEZ & CO.**

21 & 23 MAIDEN LANE, N. Y., and BRASSUS, SWITZERLAND.

MANUFACTURERS AND IMPORTERS OF

Plain and Non-Magnetic Movements.

Complicated Watches a Specialty.

**A FULL LINE OF 10 and 16 SIZE**

**SPLITS**

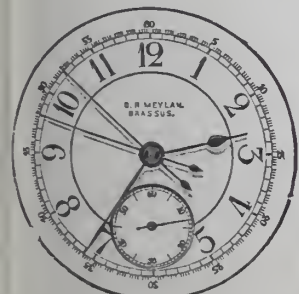

SIZE 10.



10 SIZE.

**A WORD ABOUT OPTICS.**

**D**ID you say you would like to make more money out of your Optical business? How are we to know it if you go on in the old-fashioned "Guess you have fitted them" plan? If you wish to know just how to fit them and do it in a correct and scientific manner, come to us. There is big money in it, and you can increase your business from six to ten times the amount by knowing how to do your work properly. There are more people who need glasses and do not know it than those that are already wearing them. Will you sit idly by and allow this trade to go elsewhere, or will you put yourself in a position to reap the reward? If the former, write to the SPENCER OPTICAL MFG. Co., 15 Maiden Lane, N. Y. City, for their circular, showing you what has been done and what can be done.

**The Failure of W. S. & J. B. Wilkinson.**

CHICAGO, Ill., Aug 26.—William S. Wilkinson and John B. Wilkinson, individually and as co-partners composing the firm of W. S. & J. B. Wilkinson, made a voluntary assignment to Elwin H. Murdoek yesterday. No further statement is made in the Circuit Court files, and at the present writing no cause of the failure can be learned from the firm.

Owing to the suddenness of the liquidation, the firm were not able to prepare a schedule of their assets and liabilities, but a statement will be filed by the assignee in a few days. "They have a large amount of money tied up in their business," said the attorney of the firm "and were not able to readily meet the demands of their creditors. It is thought the assets will be largely in excess of the liabilities." An order was entered by Judge Brown permitting the assignee to continue the business at the same location.

W. S. & J. B. Wilkinson are manufacturers of fine jewelry cases, trays and hardwood trunks for silverware, at 9 Madison St. The business was started by W. S. Wilkinson in September, 1879. In 1882 J. B. Wilkinson entered into partnership, the firm name being changed to W. S. & J.

B. Wilkinson. More commodious quarters being needed, the factory, office and sales-room were moved to 51 Wabash Ave., May, 1884, and again to 9 Madison St., May, 1889, where a large number of experienced hands have been engaged in making cases, etc., for jewelry, silverware, watches, rings, etc. Both partners are young men well thought of in Chicago business circles.

**This Gold Mine is Claimed to be Free From Gold.**

LOS ANGELES, Cal., July 24.—A suit for \$7,800 was commenced last week against S. E. Lucas and F. A. Marcher, both jewelers of this city, by W. H. Toler and B. E. Toler. The complaint alleges that the defendants sold to plaintiffs a one-fourth interest in a quantity of placer ground in San Bernardino County under the representation that it contained large quantities of free gold; that they, the defendants, had worked the ground extensively and had taken quantities of gold from it; that plaintiffs parted with their money upon such representations and it turned out that there was not a particle of gold in the ground and that there never had been any. They want their money back.

**Beware this Swindler with a New Dodge.**

CHICAGO, Ill., Aug. 28.—A man giving the name of James J. Brown, showing pension papers, and claiming to be a fireman on the Michigan Central Railway has been victimizing retail jewelers on the west and north sides of the city. He relates a tale of woe to the effect that his watch had been stolen from a vest hanging in his room and that he must have a watch to go out on his train. In this manner he secured a watch from the son of T. A. Albertson, 292 W. Madison St and left him his pension papers as security.

Albertson discovered his mistake when he presented the papers to the pension office and was told that a penalty clause at the bottom had been torn off. This clause provides for a fine of \$100 for taking pension vouchers as collateral. The north side jeweler received for a watch and ring only the official envelope and a worthless certificate. It is likely that several jewelers have been victimized who have not applied for redress to the pension office.

James J. Brown was discharged from the regular army for lung troubles, is 35 years of age, tall and rather slender, dark complexion and mustache, fairly good looking and a plausible talker.

The Western Onyx Co., of Eau Claire Wis., have organized with a capital stock \$25,000. The president is John Mendl Manitowoe; secretary, A. J. Sutherland Eau Claire; treasurer, Archibald Hammon Eau Claire. The company have seven mines in Utah, and will ship from them a manufacture at Eau Claire.

**Aikin Lambert Jewelry Co.**  
 Importers of **Diamonds**  
 Jobbers in **WATCHES**  
 Jewelry, Chains etc.  
 19 Maiden Lane.  
 New York.  
 SAM'L B. MANN, Treas.  
 FRED. D. ILGEN, Sec'y

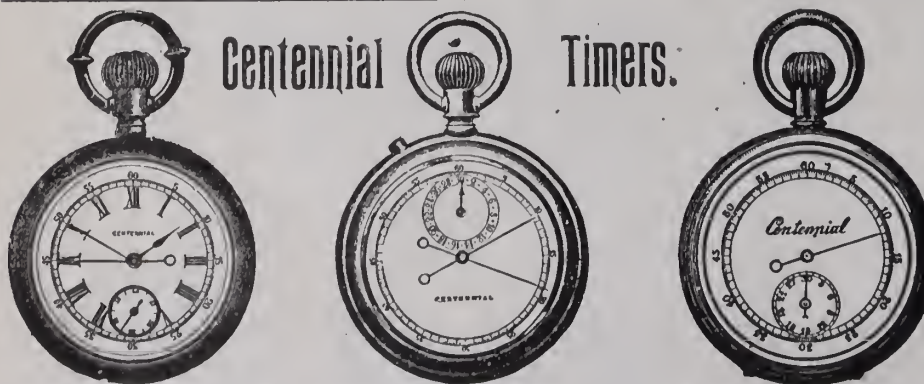

These Watches are one-third larger than above cuts.

**CROSS & BEGUELIN,**  
 Manufacturers, Importers and Jobbers of  
**Watches, Diamonds, Jewelry, Watch Materials, etc.,**  
 17 MAIDEN LANE, NEW YORK.

**Gold Dust Swindlers Redivivus in the Dominion.**

TORONTO, Can., Aug. 26.—The "gold" dust swindle was played upon Harris Rosenthal, of this city, last week and he was euchred to the tune of \$2,000. The operators were Sam Levi, of Hamilton, and Abe. Kilman. The parties met in Toronto and after some conversation about gold, Rosenthal and his brother went up to Hamilton to do business. Calling at Macnab St. they saw Kilman and re-opened negotiations.

After receiving the sample young Rosenthal returned to Toronto, and his father had it tested by a metallurgist, who pronounced it to be 23 23-250 karats fine, and contained as an alloy nothing but silver, being what miners call wash gold. A second sample was obtained and tested, and the result again substantiated the Russian exile's story of the dust having been taken from the mines and smuggled into Canada.

Young Rosenthal then decided to make the purchase, drew the \$2,000 from the bank, and proceeded to Hamilton on Monday, again met Levi and Kilman at 107 Macnab St., paid over the money and received two bags. Under the contract with Kilman the purchase price was to be \$175 per pound. Kilman did not know the actual weight of the gold and Rosenthal was to return all over 30 pounds after it had been refined.

Rosenthal went straight to the metallurgist on his arrival in Toronto, who cut a hole in the bag and tested the contents, which were found to be brass filings. Meanwhile Levi and Kilman had disappeared. Rosenthal went to Hamilton and swore out a warrant for the arrest of Levi and Kilman. He also ordered notices to be sent to all the police officers in Canada and the United States offering \$500 reward for the capture of either man.

**The Preliminary Trial of W. G. Pollock's Alleged Assailant.**

LOGAN, Ia., Aug. 22.—Kid McCoy had his preliminary trial yesterday among much excitement. The trial was held before Justice Wilson, with county attorney H. H. Rodifer for the State and S. H. Cochran, of this place, appearing for defendant. The prisoner was neatly attired. W. G. Pollock was the first witness called and proved to be a very good one. Conductor E. M. Ashmore, who had charge of the train on which the robbery was committed, and J. H. Shaw, an artesian well digger, who rode from Omaha to Blair on that train swore positively that McCoy was the man.

It is evident to the casual observer that if McCoy, or Shercliff as he prefers to be called, is the robber he has attained a high degree in his art, for his imperturbable countenance is enough to turn away all suspicion. Attorney Cochran approached the State's witnesses very cautiously, and succeeded in pumping them dry, and it is plainly seen that with both sides a determination is firmly set to win or fail at the end

of law. Mr. Pinkerton of the St. Paul agency attended the trial in person.

After the witnesses had been examined the State rested, and defendant waived. The court held the prisoner to the amount of \$6,000. At this writing bail has not been furnished, and it is possible that he will be compelled to rest in the county jail until the grand jury meets.

**ANOTHER MAN SUSPECTED TO HAVE BEEN MR. POLLACK'S ASSAILANT.**

TERRE HAUTE, Ind., Aug. 25.—M. J. Mable, of Logan, Ia., visited the county jail today and took a look at the five safe blowers, Bruce, O'Brien, Henry and the two women, Florence Wilkins and Mrs. Bruce. He thinks Bruce is the man who robbed W. G. Pollack, of New York, of diamonds valued at \$15,000. He says the description answers to that of Bruce.

It is hinted that the quintette of safe blowers will not be tried on Sept. 4, the date their cases are set for trial here, but that they will ask for a change of venue out of this county on the ground that they cannot obtain a fair trial here because of prejudice. The diamonds taken from the prisoners are valued at \$4,000. The prisoners are receiving money from some source, and have not been lacking for the comforts of life during their confinement.

The contest for the America cup makes the subject of mugs and mug-hunting timely, and the Meriden Britannia Co. have issued a beautifully illustrated catalogue printed on heavily calendered paper, of the prize cups they make in silver and gold plate, ranging in price from \$400 to \$6, and in height from 30 to 6 inches. These are designed for yachting, hunting, rowing, bicycling, tennis, base ball, running, leaping and other trophies, and furnish associations for out door sport an opportunity to gratify the demand for rich and artistic prizes at a moderate outlay. For example, \$55 will purchase three beautiful tennis cups, one 16 inches high and the others 9 and 6 inches. The wise jeweler will not only keep this catalogue convenient for reference but he will make an extra effort to get it to the knowledge of members of athletic associations and of all who intend offering prizes.

**Last Week's Arrivals.**

*THE CIRCULAR has perfected arrangements for obtaining the names and hotel addresses of all the latest buyers visiting New York, and each day posts in its office, 189 Broadway, a bulletin which every member of the trade is cordially invited to copy.*

The following out-of-town dealers were registered in New York during the past week: W. Schweigert, Augusta, Ga., St. Nicholas H.; J. Nelson, Dunkirk, N. Y., St. Denis H.; A. H. Hamrick, Philadelphia, Pa., Cosmopolitan H.; A. Lathrop, Syracuse, N. Y., Astor H.; J. A. Harwood, Boston, Mass., Murray Hill H.; C. P. Gilkison, buyer for Dernberg, Hick & Horner, Chicago, Ill., 96 Spring St.; J. Nelson, Boston, Mass., Astor H.; J. R. Newman, Boston, Mass., Astor H.; W. M. Weston, Boston, Mass., Murray Hill H.; C. Smith, Washington, D. C., Astor H.; W. F. Nye, New Bedford, Mass., Grand Union H.; H. M. Betz, Philadelphia, Pa., Astor H.; J. T. Bonestall, San Francisco, Cal.; H. Fudger, Toronto, Ont., Astor H.; C. R. Hinsel, Hartford, Conn., Everett H.; S. Saloman, San Francisco, Cal., Coleman H.; F. H. Voight, Philadelphia, Pa., Cosmopolitan H.; R. V. Johnson, Boston, Mass., Astor H.; Mr. McNamara, buyer for the W. Barr D. G. Co., St. Louis, Mo., St. Stephen H.; G. Illich, Albany, N. Y., Rodgers H.; H. Van Valkenburgh, Albany, N. Y., Metropole H.; N. Salzmann, Galveston, Tex., Morton H.; W. W. Huber, Philadelphia, Pa., Murray H.; A. Andrews, San Francisco, Cal., Coleman H.; G. D. Hall, San Francisco, Cal., Astor H.; R. Ernst, Vicksburg, Mass., Coleman H.; A. E. Rogers, Scranton, Pa., Morton H.; W. P. Adams, Chicago, Ill., Morton H.

**VICTOR.** ⊗ ⊗  
 SIMPLEST FEED. ALWAYS THE SAME.  
 GUARANTEED FOR ONE YEAR.  
**THE VICTOR**  
**FOUNTAIN PEN**  
 (Pat. Feb. 4, 1890.)  
**THE BOSTON PEN CO.,**  
 N. C. Whitaker & Co., Proprietors.  
 363 Washington Street, - Boston, Mass.,  
 Manufacturers of finest quality  
 TORTOISE : SHELL : AND : HORN : GOODS  
 in every variety. Also Aluminum Hair Pins.  
 Send for Illustrated Pen Price List No. 1.

ESTABLISHED 1801.



**HINRICHS & CO.,**

29 & 31 PARK PLACE,

Cor. Church Street,

NEW YORK.

**Art Pottery and Bric-a-Brac,**

CUT GLASS, FANCY GLASS, CHINA, LAMPS.

THE LARGEST ASSORTMENT OF SPECIALTIES FOR THE JEWELRY TRADE, AT LOWEST PRICES.

# EBONY AND SILVER TOILET ARTICLES,

IN NEW AND ELEGANT  
COMBINATIONS.



AS this combination is to be very fashionable this season, we have produced the most elaborate line on the market in Ladies' and Gentlemen's Toilet and Manicure Articles. These goods are mounted with pierced Sterling Silver, and decorated by the most artistic hand engraving.

A full line of these goods will make a beautiful window display. Send for samples.



## MADE IN

HAIR BRUSHES.	SHOE AND BUTTON HOOKS.
MILITARY BRUSHES.	NAIL POLISHERS.
CLOTH BRUSHES.	POWDER AND PUFF BOXES.
HAT BRUSHES.	NAIL POWDER BOXES.
BONNET BRUSHES.	SHOE HORNS.
GENTLEMEN'S COMBS.	NAPKIN RINGS.
LADIES' COMBS.	PAPER CUTTERS.
ROUND AND OVAL MIRRORS.	HAND BLOTTERS.
WHISK BROOMS.	NAIL FILES.
PIN TRAYS.	CORN KNIVES, etc.

## J. N. PROVENZANO,

GOLD AND SILVERSMITH,

No. 39 UNION SQUARE.

NEW YORK CITY.

# The Jewelers' Circular

AND  
HOROLOGICAL REVIEW.

PUBLISHED EVERY WEDNESDAY BY

THE JEWELERS' CIRCULAR PUB'G CO.,  
189 BROADWAY, NEW YORK CITY.

A JOURNAL DEVOTED TO THE INTERESTS OF JEWELERS, WATCHMAKERS, SILVERSMITHS, ELECTRO-PLATE MANUFACTURERS, AND ALL ENGAGED IN KINDRED BRANCHES OF INDUSTRY

Our Editorial columns will contain our own opinions only, and we shall present in other columns only what we consider of interest or value to our readers. Advertising matter will not be printed as news.

Advertising rates in THE CIRCULAR are lower, considering the number of tradesmen reached by its large circulation, than in any other jewelry journal.

Notices of changes in standing advertisements must be received one week in advance; new matter can be received up to Monday.

## INFORMATION FOR SUBSCRIBERS.

### Terms of Subscription, Postage Prepaid.

United States and Canada,	PER ANNUM	\$2.00
Foreign Countries in Postal Union,		4.00
Single Copies,		.10

New subscribers can commence at any time.

Payments for THE CIRCULAR, when sent by mail, should be made in a Post-Office Money Order, Bank Check or Draft, or an Express Money Order or Registered Letter. All postmasters are required to register letters whenever requested to do so.

Pay money only to authorized collectors having proper credentials.

Returning your paper will not enable us to discontinue it, as we cannot find your name on our books unless your address is given.

In changing address always give the old as well as new one. Your name cannot be found on our books unless this is done.

The Courts have decided that all subscribers to journals are responsible until arrears are paid in full and an order to discontinue has been received by the publisher.

### Member of the American Trade Press Association.

Vol. XXVII. Aug. 30, 1893. No. 5.

#### A MOTTO FOR THESE TIMES.

"They helped every one his neighbor; and every one said to his brother, Be of good courage."—*Isaiah, xli. 6.*

TWO dispatches from Chicago published in this issue show that the ingenious thief and swindler are abroad in the land. In one case the jewelry salesman's coolness and courage frustrated the designs of a thief who dexterously employed a handkerchief to aid him in stealing a valuable article of jewelry, while in the second case the swindler, who operated a new dodge, was successful in his enterprise. We reiterate our advice to the jewelers of Chicago: Avoid any but cash dealings with strangers while the city is so infested with crooks.

Beginning of **N**OW that the Wilson bill repealing the bullion purchase clause of the Sherman law has been passed by the House of Representatives, we are at the beginning of the end of the principal cause of national distress. The Voorhees bill in the Senate is to like effect, with a declamatory addendum that it is the policy of the United States to maintain gold and silver at a parity. The Voorhees law

will probably be the final form of legislation sent to the President for his signature. The passage of the Wilson bill by the House is a moral, political and physical argument for repeal in the Senate that cannot be over measured nor resisted. The purchase clause of the Sherman law was repealed by a majority which sweeps the silverites from the field.

### Fortunes in Diamonds.

THE London *Standard* in considering M. Moissan's experiments, feels so confident that the alchemists dream for centuries past—to manufacture diamonds—will soon be realized, that it is already bemoaning the fate of the possessors of fortunes in these stones. Our English contemporary seems to forget that M. Moissan himself, whose discovery has filled with delight the hearts of visionaries, affirms that it is impossible to produce diamonds of a marketable size. The expense in producing the infinitesimally small stones as the result of his experiments, was many times larger than the value of the stones as gems. It is not unreasonable to suppose that M. Moissan and his fellow laborers will go further, but only a Col. Sellers will believe that these ingenious chemists will ever reach a point where they will be able to produce the finest of gems in quantities that will allow them to compete with the fruitful South African mines. The production of diamonds on a commercial scale must prove a commercial success to permit its continued existence. The most enthusiastic experimenter asserts it to be futile to attempt such an enterprise. The mines of Kimberly are practically inexhaustible; yet diamonds are the most expensive and luxurious items of personal adornment. Altogether, notwithstanding the *Standard's* pessimism or optimism, if you like, we would be quite willing to have a fortune in diamonds, or two if available.

A Word to **D**URING the past week THE CIRCULAR has received anonymous communications attacking the letter published in the preceding issue of this journal, discussing the untoward financial and commercial conditions that have been existing. It is desirable on our part to impress upon our readers that anonymous communications will receive from us no consideration whatsoever; they will not even be read, but instead will find a resting place in the cool recesses of the editorial waste paper basket. THE CIRCULAR under its department "Correspondence" will publish open letters from any member of the trade, though the opinions expressed in them will not necessarily receive our endorsement; but these letters will find room in the columns of this journal only under the conditions stated at the head of the "Correspondence" department.

## The Week in Brief.

THE death occurred of Frederick E. Parsons, secretary and treasurer of the Brooklyn Watch Case Co., New York. —A man named Texas unsuccessfully endeavored to work the "handkerchief trick" on a salesman in the store of E. H. Goodrich & Co., Chicago—James Perry was arrested in Lancaster, Pa., charged with robbing the store of Frank E. Bailey, Steelton, Pa.—The death occurred of Geo. H. Parker, formerly a jeweler of San Jose, Cal.—M. C. Kummerer, Minneapolis, Minn., filed his schedules of assets and liabilities—Christopher Bernloehr, Indianapolis, Ind., was robbed—W. S. & J. B. Wilkinson, Chicago, made an assignment.—S. E. Lucas and F. A. Marcher, jewelers, Los Angeles, Cal., have been sued—A clever swindler has been operating in Chicago—The death of B. A. Buerkle, Pittsburgh, Pa., occurred—The store of A. Vineburg & Co., Albany, N. Y., was seized under attachments—P. A. Fischer, Worcester, Mass., attempted to commit suicide—The Boston Jewelers' Club enjoyed an outing—The E. A. Whitney Co., to succeed E. A. Whitney, incorporated in Boston, Mass.—Schedules in the failure of Morse, Mitchell & Williams, Chicago, Ill., were filed—The stores of J. F. Bates and the McAlister Optical Co., Philadelphia, Pa., were burglarized—The store of H. A. Liffiton, Kingston, Ont., was damaged by fire—Seth Nash, Barrie, Ont., assigned.—The Rockford Silver Plate Co., Rockford, Ill., entered suit against the Barrett Hotel Co., Chicago—The United States Optical Co., Detroit, Mich., increased their capital stock—M. C. Kummerer, Minneapolis, Minn., filed his schedules of assets and liabilities—Rickert & Stiehle, Newark, N. J., gave a bill of sale—The motion of Allan C. Dalzell asking permission to examine the books of Jos. Fahys & Co., in his suit against that firm was denied—The members of the Attleboro Stock Co., New York, confessed four judgments—Albert Lorsch & Co., New York, are missing a case of diamonds—The gold dust swindle was successfully played in Canada.

### The Desperate Accounts of Strauss & Stern for sale.

CINCINNATI, O., Aug. 26.—The following advertisement has been appearing in the newspapers:

#### ASSIGNEE'S SALE.

The undersigned solicits sealed bids for the desperate accounts belonging to the estate of Strauss & Stern, a list of which is on file in the Probate Court of Hamilton County, Ohio, in the matter of the assignment of Strauss & Stern. Bids must be presented not later than August 29, 1893, at 10 o'clock A. M., at which time they will be submitted to the Probate Court for its action.

Terms of sale—Cash.

For further particulars inquire of

SAMUEL WOLFSTEIN,

Assignee of Strauss & Stern, South East Corner Third and Walnut Streets.

KRAMER & KRAMER, Attorneys.

### New York Notes.

J. M. Lyon has obtained a judgment for \$61.44 against Wolff Glass.

The Western National Bank has obtained a judgement for \$1,523,34 against Frederick J. Kaldenberg.

Anton Hodenpyl, of Hodenpyl & Sons, is on a fishing trip in Maine. He will return in about three weeks.

Alfred B. Jaroworer, attorney for A. Gottlieb, has entered a judgment for \$800 against Benj. Shapiro. The judgment was confessed last Friday.

On invitation of Isidor Stern, of Stern Bros. & Co., the office force of the firm spent Sunday at Mr. Stern's country residence, at Auverne, L. I.

Henry C. Barthman, son of William Barthman, accompanied by his wife and sister, is spending three weeks in Chicago, visiting the World's Fair.

H. U. Wheeler, who was mentioned last week in these columns as being manager of the Dubois Watch Case Co., is not connected in any way with that concern.

Geo. A. French, 198 Broadway, who assigned June 22d to Anton Hodenpyl, has effected a settlement with his creditors at 50 per cent., and will resume business this week.

The following judgments have been entered against Frederick J. Kaldenberg and Benjamin Crane: one by the Nassau Bank for \$2,415.59; one by the Western National Bank for \$1,845.51.

Sidney S. Fearn, a gold and silver plater at 117 Bowery, died suddenly in his office Wednesday night. Mr. Fearn was forty years old. He lived with his family at 472 Bergen St., Brooklyn.

Johannes Dürrstein, senior partner of Dürrstein & Co., watch manufacturers, Glashütte, Germany, was in New York last week on his return from a visit of inspection at the World's Fair. He sailed for Europe on the *Fuerst Bismarck*.

William Barthman showed in his window at 174 Broadway, last week, a large diamond pin in the shape of an anchor, which contained sixty-nine diamonds, ranging from  $\frac{1}{4}$  to 3 karats each. The setting was of platinum backed with gold.

Aaron Weinstein, whose wife and son were killed in the terrible accident on the Long Island Railroad on Saturday, and who was himself badly injured, was for a number of years bookkeeper for Stern Bros. & Co., 30 Maiden Lane.

Frederick J. Dorn, a jeweler, of Buffalo, N. Y., accompanied by Thomas Walsh, of the same city, have been "doing" the metropolis under the guidance of jeweler John C. Proudman, 307 Eighth Ave. They have examined every section of the city from the Battery to the city line and from the East River to the North River.

The suit brought by Marcus & Co. to recover \$650, the value of jewelry sold to

Bertha Spargur, has been settled. On motion of A. W. Van Winkle, the plaintiffs' attorney, Judge Van Brunt of the Superior Court, on Thursday, discontinued the action and vacated the attachment issued against the defendant June 21st.

George Pratt, who said he slept in Central Park, passed the window of jeweler Edward Mahler, 662 Sixth Ave., Thursday. A watch labeled Mrs. F. Smith hung on the repair hook and Pratt wrote a note asking for it, signing Mrs. F. Smith's name. Unfortunately for him Mrs. Smith had got the timepiece in the mean time. In Jefferson Market Court, Pratt was held for trial.

Harry Smith, 917 Broadway, Williamsburg, was held in the Lee Avenue Police Court last week on a charge of larceny made by Adolph Fisher, jeweler, 738 Park Ave. Fisher engaged Smith to sell watches on the instalment plan. Many of Smith's customers disappeared after the first month and Mr. Fisher claims that he discovered that Smith kept the watches, his customers' names being fictitious.

The motion made by the Dueber Watch-Case Mfg. Co., in their suit against the Co-operating Manufacturers, asking for a commission to take the testimony of certain residents of Pittsburgh, Pa., came up before Judge Van Brunt, of the Supreme Court Thursday morning. At the request of the attorneys for the Keystone Watch Case Co., argument was postponed until Sept. 7th, the judge ordering, however, that no further postponements be granted unless for legal excuses.

John Kehoe, a burglar, arrested in Williamsburg for complicity in the robbery of H. H. Bolton's jewelry store, 2,625 Atlantic Ave., Brooklyn, on Aug. 8th, committed suicide last week by cutting his throat while handcuffed to Detective Ryan. Detectives were searching his room at 205 Lee Ave. Detective Rohl was handing the stolen goods, which included silverware, gold spoons and cutlery, to Detective Ryan, when Kehoe suddenly seized a pen knife and gashed his throat terribly. He died almost instantly.

The motion made by the attorney for the plaintiff in the suit of Eichberg vs. Wickham to remove E. T. Wood, the referee who was appointed to take the accounts of Nathan J. Newwitter, the receiver for D. H. Wickham & Co., was denied by Judge O'Brien of the Supreme Court, last week. A decree having been given adjudging the estate of Samuel Eichberg to have the first lien on the estate of D. H. Wickham & Co., an accounting by Mr. Newwitter was ordered to be taken before E. T. Wood as referee. The plaintiff moved for the removal of Mr. Wood, on the ground that he was partial to the receiver.

Judge Friedman of the Superior Court last week decided the motion made by Allan C. Dalzell in his suit against Jos. Fahys & Co., by which he asks for an order permitting him to examine the defendants' books.

In the affidavits opposing the motion the defendants give certain figures relating to the sale of watch crowns manufactured under Dalzell's patent and declare that their books will give no more information necessary as testimony in this suit than is contained in these figures. The motion was denied with \$10 costs. Dalzell sues for half the profits accruing from the use of certain of his patents, which he claims were assigned to Jos. Fahys & Co. on that condition.

L. Barre, of Tiffany & Co., arrived Sunday from Europe on *La Bourgoigne*.

James Knowles, southern representative of S. F. Myers & Co., is at Green's Farms, on the Connecticut shore, spending his vacation with his mother.

Benno Loewy has entered five judgments aggregating \$4,352.61 against David W. Rosenthal and Isidor Rosenberg, dealers in jewelry, at 491 Broadway, under the name of the Attleboro Stock Co. The judgments, which were confessed Friday, were as follows; \$514.47 to Joseph Weil for balance due on money collected; \$877.28 to Eichold & Miller, for money loaned; \$1,049.10 to F. Meyer for money loaned; \$518.73 to Freilag & Co. for merchandise; and \$1,933.03 to Carl Rosenberg for salary and commission. Executions were issued to the sheriff who took charge of the store. The firm started on Jan. 1, 1891. They were believed to have a capital of about \$8,000. The principal creditors are in Providence, New York and Europe.

Paul Cherry, watchmaker and jeweler, of 45 Vandam St., was held up, assaulted and robbed of a valuable gold watch and chain in front of 724 Greenwich St., at 2 o'clock Sunday morning by six men. Mr. Cherry was on his way home and as he was passing 724 six men came out of the doorway and one of them grabbed him by the hand and said: "Hello friend." Then another asked him to have a drink, and pushed a can of beer up to his mouth; at the same time some one snatched his watch and chain, and then all of them ran away. Detectives arrested James Logan, aged 30, at his house, 722 Greenwich St., and Mr. Cherry positively identified him as the man who held the can of beer up to his mouth. In the Jefferson Market Police Court, Logan was held for trial.

Jewelers who are not skilled in optical fitting and optical advertising would be greatly surprised at the amount of business they would get if they prepared for it by taking an optical course at the Spencer Optical Institute, and by inculcating ideas as to how to place the subject rightly before the public. The people are neglectful of the requirements of the eyes, and are suffering from imperfectly fitting glasses. The jeweler who ought to do the work skillfully, allows the peddler to invade his field and humbug his possible customers. Our advice is to get in line and claim your share of the profits of the optical business.

# Riches CUT GLASS

FROM OUR OWN WORKS IN THIS CITY.

None but the Highest Grade in Quality and Workmanship.

LARGEST ASSORTMENT.

MOST MODERATE PRICES.



CARAFE, 455 | 53. COLUMBUS.

A LARGE variety of new and strikingly original shapes and many new cuttings, protected by U. S. Patents.

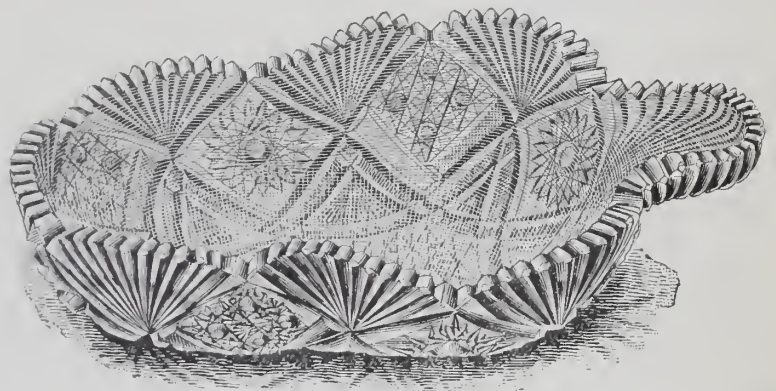

SALAD, 434 | 55. LA RABIDA.

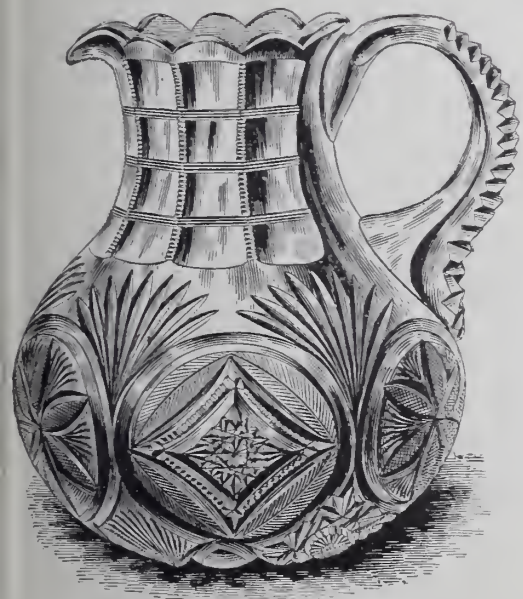

PITCHER, 453 | 58. BRAZILIAN.

## L. STRAUS & SONS,

MANUFACTURERS,

42, 44, 46 AND 48 WARREN ST.,

AND 116 CHAMBERS ST.

NEW YORK.

See our Exhibit at the World's Fair, in Section H, of the Manufactures Building.

**Boston Jewelry Merchants Become Jolly Tars for the Nonce.**

BOSTON, Mass., Aug. 26.—A group of business men stood this afternoon on the balcony of the South Boston Yacht Club house overlooking Boston harbor. They were members of the Boston Jewelers' Club, assembled for a cruise in the bay, and a few minutes later all were reclining in picturesque and comfortable attitudes on board the *Navarch*, guests of their president, Com. Charles F. Morrill, owner of the dainty craft.

Released from her anchorage away sped the yacht toward Hull, where dinner awaited the arrival of the party at the Hull Yacht Club house. There was enjoyable impromptu speechmaking, a pleasant hour in the bowling alley afterward, and then the yacht was headed for Marblehead, and supper was spread for the excursionists at the quarters of the Corinthian Yacht Club.

More speeches, a social hour ashore and a moonlight sail home to Boston, enlivened by songs of ye olden time, made up the program of a most delightful outing, which was heartily enjoyed by all the participants.

The new members, especially, to whom the trip was an exceedingly agreeable initiation into the Club's customs, were profuse in their expressions of pleasure, and the older members joined them no less heartily in proposing cheers and a vote of thanks to their genial host.

Those present were: President Charles F. Morrill, Charles Harwood, J. B. Humphrey, Austin T. Sylvester, M. N. Smith, Henry W. Patterson, William B. Thompson, James S. Blake, Dean Southworth, D. C. Percival, Jr. and W. H. N. Pratt, Boston; E. W. Martin and R. M. Hamilton, Providence; Louis Blackinton, Attleboro.

**Peter A. Fischer Attempts to Commit Suicide.**

WORCESTER, Mass., Aug. 23.—Peter A. Fischer attempted suicide by cutting his throat last evening at his home, 43 Thomas St. The attempt was almost successful, as only prompt medical assistance saved his life. Fischer had been an inmate of the lunatic hospital, Bloomingdale, several months and was discharged as cured only four weeks ago.

He was out during the afternoon and returned home for supper. During the even-

ing he chatted with his wife and prepared to retire about 9 o'clock. He had entirely disrobed and had put on his night shirt. The family were in the next room and were startled by a fall and outcry. They rushed into the room to find Fischer bleeding profusely from a wound in the throat inflicted by a razor. The police were notified and Medical Examiner Keefe was promptly summoned. His family stated that he had acted rather queerly during the evening, and it is very probable that he did the deed during a temporary fit of insanity. He now lies in a precarious condition.

Fischer is about 55 years of age. He has resided in this city about four years.

**The Sheriff Seizes A. Vineberg & Co.'s Store on Attachments.**

ALBANY, N. Y., Aug. 23.—Two attachments were secured yesterday by S. M. and M. N. Shimberg, of Syracuse, against A. Vineberg & Co., opticians, doing business at 65 N. Pearl St., and in the afternoon Sheriff Cross took possession of the place.

One of the attachments was secured on judgments obtained on notes past due given in payment for goods purchased, and the second was also on notes overdue, but in the latter case the allegation is made that the defendants fraudulently misrepresented the value of the goods in their house, on the strength of which money was borrowed. The whole amount of the attachments is in the neighborhood of \$650.

**Demise of a Prominent Retailer of Pittsburgh.**

PITTSBURGH, Pa., Aug. 24.—B. A. Buerkle, jeweler and bookseller, 1410 Penn Ave., died Sunday at his residence, corner Hamilton and Downing Sts., Troy Hill. Death was due to heart disease.

Mr. Buerkle was born in Pittsburgh sixty years ago and has resided here most of his life. A daughter, Miss Philomenia, is the one member of the family that survives him. The funeral services were held at the residence at 8:30 A. M., Tuesday. Interment was in St. Mary's.

**Burglars and Thieves Much in Evidence in Philadelphia.**

PHILADELPHIA, Pa., Aug. 28.—Thieves are still particularly active in Philadelphia. Last Thursday night the jewelry store of

John F. Bates, 3,402 Market St., was entered from the rear and \$196 worth of articles stolen. On the same night the McAlister Optical Co.'s store, 705 Chestnut St., was broken into and spectacles and opera glasses valued at \$400 were carried away. In neither case were the thieves captured.

On the following day two colored men entered the store of Wm. Van Aken, 2,249 Germantown Road. They asked to be shown some watches, and finding nothing to suit them departed. Soon after Mr. Van Aken discovered that they had smashed a show case near the door and had taken three silver watches. This is the fourth time in a couple of months that Mr. Van Aken has been the victim of thieves.

**The Scheduled Assets of Morse, Mitchell & Williams.**

CHICAGO, Ill., Aug. 28.—The assignee for Morse, Mitchell & Williams has filed an inventory of assets, of which the totals are as follows:

Equity of redemption in real estate—321 lots @ \$246, 1 lot at \$346, - - - - -	\$77,312.00
Merchandise on hand, - - - - -	13,004.21
Furniture and fixtures (estimated), - - - - -	150.00
Accounts receivable (mdse. business), - - - - -	27,182.40
Bills receivable (Mitchell Park business, - - - - -	700.64
Amount due on contracts, - - - - -	5,067.74
“ “ “ “ - - - - -	11,391.78
“ “ “ trust notes, - - - - -	5,027.76
Balance due on trust notes, - - - - -	1,513.60
“ “ “ contracts, - - - - -	14,517.20
Open accounts (real estate), - - - - -	136.24
	<hr/>
	\$141,972.80

The title to the real estate is in Francis E. Morse who holds it in trust for the firm. In the merchandise account 25 per cent. has been deducted from the original footing of the inventory. An amount of \$2,351.40 which figures in bills receivable is against the Trenton Watch Co. and is in dispute. The contracts for \$5,067.74 were given to Mrs. H. Drusilla Mitchell as security for guarantee at banks, and contracts for \$11,391.78 and trust notes for \$5,027.76 were given to C. W. Deering as collateral security for \$15,000 borrowed money. No inventory of liabilities has been filed.

In the case of F. E. Morse & Son, Lewis Kaiser & Luthy, creditors in the sum of \$14,888., have filed a petition for citation for the purpose of ascertaining the assets and liabilities and also the condition of the estate.

The foundry of the Brown & Sharpe Mfg. Co. and Darling, Brown & Sharpe, Providence, R. I., started up after the usual vacation, on Aug. 14th, and all departments of the machine shops resumed work on Aug. 28th.

**S. C. JACKSON, 180 BROADWAY, NEW YORK.**

**Fine \* Cases \* for \* Jewelry, \* Silverware, \* Etc.**

ALSO SHOW CASE TRAYS AND FANCY HARD WOOD WORK. Samples sent on application. Estimates furnished.

A. A. MARGOT. **MARGOT BROTHERS,** E. F. MARGOT:

Watch Case Manufacturers, Engine Turners and Jobbers, 11 FRANKLIN ST. (FORMERLY 23 WATER ST.) BOSTON, MASS.

Special Attention to Watch Case Repairing, Springing, Re-engine Turning, Engraving, Polishing, etc. Flat Glasses Fitted, Jewelry, Silverware, Dies, etc., engine turned.

Particular Attention to Orders from Expresses.



# CHAS. L. UHRY & Co.

N. Y. OFFICE,  
189 BROADWAY.

SCARF PINS,  
BROOCHES,  
CHARMS,  
FOBS.  
HAT PINS,  
HAIR PINS,  
CHATELAINES.

336 Mulberry St., Newark, N. J.

# CHAS. L. UHRY & Co.

WM. BIRMINGHAM & CO.,  
MANUFACTURERS OF  
All Kinds of Leather Spectacle and Eye Glass  
**CASES,**  
728 Arch Street, PHILADELPHIA, PA.

**ALUMINUM SOLDER \$2.00 PER POUND.**  
Instructions for using given gratis.  
Practical Processes for Soldering,  
Dipping, Enameling, Etching, &c.,  
of Aluminum.  
C. DE REDON, 43 WEST 21ST ST.,  
NEW YORK.

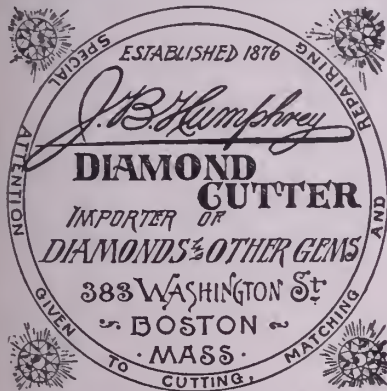

**PEARLS.**  
**RUD. C. HAHN,**  
194 BROADWAY, NEW YORK.  
**GARNETS.**

# C. SYDNEY SMITH,

HAS REMOVED TO 191 BROADWAY,  
New York.

FACTORY:  
PROVIDENCE, R. I.

Manufacturer of } **GOLD CHAINS,  
LOCKETS AND CHARMS.**

## Enterprising Jewelers Catch On!



OBVERSE



REVERSE



BACK

## Jewish Shekel, Masonic Mark or Pocket Piece. THE LATEST AND BEST SELLING NOVELTY.

The mark is struck in coin silver; by using either the obverse or reverse of the coin, the back being the same in either case, and permitting of the purchaser's name, blue lodge, chapter and individual mark, with date of same being engraved thereon, as shown in cut above.

Price, without engraving, ONE DOLLAR. Engraved Mark, Dates, etc., 75c. EXTRA.

Liberal Discount to the Trade.

CHAS. C. WILLSON, MANUFACTURING JEWELER, READING PA.

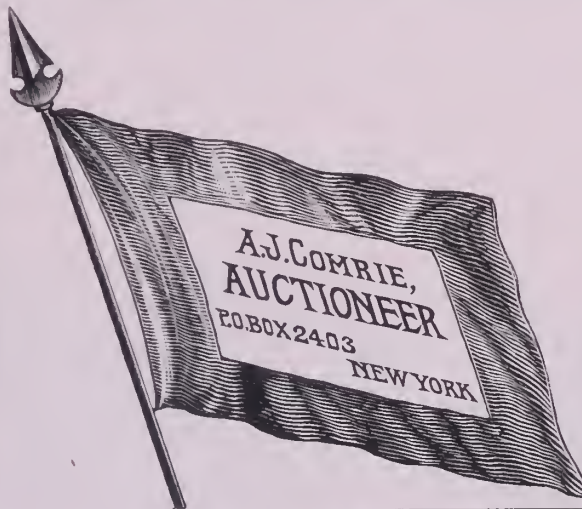

SPECIAL SALESMAN OF

**WATCHES, DIAMONDS,**  
Bric-a-Brac  
and Art Goods  
FOR  
**Established Jewelers.**

WRITE FOR PARTICULARS.

Communications Strictly Confidential.

References given in all parts of the United States from Retailers and Jobbers.



## The Warren Eye Protector

(Patented Jan. 12, 1892, Feb. 21, 1893.)

Saves the Eyes From

**Dust, Wind, or Glaring Light.**

Folds in a Compact Case, is

**Comfortable, Durable,  
Water and Dust Proof.**

Its large field does not obstruct the sight. No brittle substance to endanger face under sudden blows.

Oculists and Physicians Recommend it.

Travelers, Cyclists, Railroadmen,  
Horsemen, Motormen, Quarrymen,  
Pronounce it Indispensable for Man or Woman.

Ask your Dealer for it.

Colors, Clear, Smoke, Blue or Green. Black frames, 50c. Silver, 75c. Sent by mail on receipt of price. Manufactured solely by

**The Nous Verrons Company**

P. O. Box 3273, Boston, Mass.

BAUME & CO., 

21 HATTON GARDEN, LONDON, ENGLAND  
AND SWITZERLAND.

EXHIBITORS AT CHICAGO OF

TOURBILLION CHRONOMETER WATCH

WHICH HOLDS THE RECORD AT THE ROYAL OBSERVATORY KEW.

HIGH CLASS SWISS WATCHES, PLAIN AND COMPLICATED.

PATENTEES FOR SPLIT SECONDS CHRONOGRAPHS (Treble Action.)

AGENT FOR U. S., GEO. E. WILKINS, SYRACUSE, N. Y.

As Regards

SILVER PLATE

WE BELIEVE

THAT an Honest article at an Honest price goes further toward making sales than all the advertising in Christendom,

AND WE WORK ACCORDINGLY.

MAKING and SELLING a BETTER Article for the SAME MONEY, or an EQUAL Article for LESS Money than any other concern, is the principal cause of our fast increasing business.



572.—BUTTER DISH.

HOMAN & COMPANY,

CINCINNATI.

 Visitors to the Columbian Exposition, Remember our Complete Line is displayed at,

155 STATE STREET, CHICAGO.

# WORLD'S FAIR and WESTERN SUPPLEMENT of THE JEWELERS' CIRCULAR

CHICAGO OFFICE : ROOM 308, INTER-OCEAN BUILDING.

VOL. XXVII.

CHICAGO, WEDNESDAY, AUGUST 30, 1893.

NO. 5.

## JACOT & SON'S REMARKABLE EXHIBIT OF MUSIC BOXES.

THE old truism that music hath charms to soothe the savage breast may account for the gentle manners of W. A. Sambalino, and gentleness is an essential requisite in the performance of his duty, inasmuch as he is called upon to answer thousands of questions each day. This gentleman is the representative of the American house of Jacot & Son, 298 Broadway, New York, and is in charge of the World's Fair

cabinets, chairs, etc., and on each side of these, occupying the rear half of the platform, are tables filled with the medium sized instruments. The smaller boxes rest on shelves still higher up, the whole forming a solid bank over six feet in height by fifty feet long. Above the boxes is a drapery effect formed of scores of cylinders, the smallest in the center and graduated outward to 24½ inch cylinders at the ends.

Berne, in 1848. The "Ideal" boxes, to which special attention is directed, are all cased in American woods which, being adapted to the climate, enables the firm to guarantee that they will not warp or split. Oak and mahogany, both plain and carved are the principal woods shown. While the guarantee against warping and splitting of case is of marked advantage, it is a minor consideration when compared to the many



THE NOTABLE EXHIBIT OF JACOT & SON AT THE WORLD'S FAIR.

exhibit of the celebrated music box manufacturers, in the Swiss section, at the south end of Manufactures building.

The entire rear wall of the section for a distance of fifty feet is banked deep with these marvelous musical creations. The exhibit is displayed on a raised velvet carpeted platform, at the front of which are arranged the larger boxes. The center is given up to carved musical sideboards,

Surmounting the exhibit are two huge paintings of the City of Geneva and the Jungfrau, crowned by the Swiss colors. In the center the firm's name is flanked by Swiss carved frames around the inscription in gilt letters on black velvet background, "Ideal music boxes. Peerless music boxes." At the right of the exhibit is a frame of first prize medals, obtained wherever the firm have exhibited since the Exposition of

recent improvements shown in mechanism improvements which insure the most musical sound, the greatest durability and remarkable ease of manipulation.

The Jacot & Son music boxes are the only ones made by American machinery of their own invention and a special point is made that no box was ever guaranteed, no matter how fine it might have been until the Jacot patent safety check which pre-

vents the running of the cylinder was introduced. Another difficulty formerly experienced with boxes arose from complicated mechanisms, easily put out of order, and generating too much noise. These difficulties are obviated by the ball bearing noiseless winder, by which the operator may unwind the spring by simply touching a small lever. The indicator and tune skipper on old styles were separate; now an indicator and tune skipper combined will allow of changing either backward or forward and cannot be set in the middle of a tune; consequently each tune is in itself perfect.

An improvement for placing in of the cylinder consists of a spring that throws the cylinder into its true place as soon as it is set in the box. There are no clamps or levers and changes can be made instantly. The horizontal fly wheel has the advantage over the perpendicular in that it gives a better distribution of oil and places it when and where needed. All the pins are turned by hand so that when they touch the teeth they glide off instead of striking and grating off as in cheaper boxes. All these various parts being made by American machinery they can be changed from one box to another. No old style parts are now used.

The gem of the exhibit is a "Soprano" with cylinder  $3\frac{1}{2}$  inches in diameter which plays a full hour at each winding and is the largest interchangeable box ever made. The case is of carved oak 44 inches long

and rests on a handsome carved table. The front panel bears a light colored lyre and scroll on a darker etched background. Another musical wonder is a combination box valued at \$1,475. There are six cylinder combinations in one box, comprising barytone, soprano, quatuor, sublime harmony, piccolo, and sublime harmony tremulo, and they play thirty-six tunes. Additional cylinders can be furnished. The box and table are finely inlaid with brass, bronze and German silver in conventional designs, with the edge of the table, table legs and corners of the box heavily ornamented with brass. That the Jacot is without a competitor is ably proven by a glance at the following improvements:

1. Tune skipper, changing tune at will.
2. Indicator showing tune it plays.
3. Speed regulator, moving cylinder slow or fast.
4. Double springs, playing double length of time of ordinary music box.
5. Compensating fan, so that it will play at same speed whether full wound or partly run down.
6. Ball-bearing, noiseless winder.
7. Jacot's patent safety check.
8. Horizontal fly wheel.

The firm carry in stock at all times all the best known tunes and make any special piece to order. In the World's Fair exhibit all sizes and a wide range of pieces are shown, from the smaller mahogany to the

exquisitely carved oak soprano, which good judges of music admit is the finest toned box they ever heard.

The graining and mottled designs in woodwork form the chief feature of case ornamentation and the line shown gives evidence of an unequaled selection from the choicest markings of American wood. Mr. Sambalino paid the following high tribute to jewelers: "The finest class of boxes are handled by jewelers and it is easier for the smallest jeweler to sell a \$400 box than it is for a drygoods or department store to sell one for \$150. There is nothing too nice for the jewelry trade."

Samples of a new line of enameled tableware, of German silver, triple plated and triple gilded, are shown by Sophus Samson, 802 Columbus building, Chicago. The wares are made in Copenhagen, Denmark, and have every appearance of sterling goods. Two choice patterns are shown in full lines, one with fluted shank and handles decorated in light and dark blue enamels, the other with "rope" handles widening out into flat enameled surface near the end. Both are very tasteful. The prices is but a trifle more than that asked for ordinary plated goods and places enameled wares within the reach of all. Mr. Samson has the sole rights for the United States.

## ALBERT H. BONNET,

ONLY EXCLUSIVE WHOLESALE JEWELRY HOUSE IN OHIO.

COLUMBUS, WALTHAM, ELGIN, HOWARD AND STANDARD WATCHES,  
GOLD AND FILLED CASES, JEWELRY, CHAINS, CLOCKS.

FULL LINE OF TOOLS AND MATERIALS.

No. 24 E. SPRING STREET, COLUMBUS, OHIO.

## DIRKSEN SILVER FILIGREE CO.,

MANUFACTURERS OF

STERLING © SILVER © SOUVENIR © SPOONS.

© Napkin Rings, Trays, Vases, Card Cases. ©

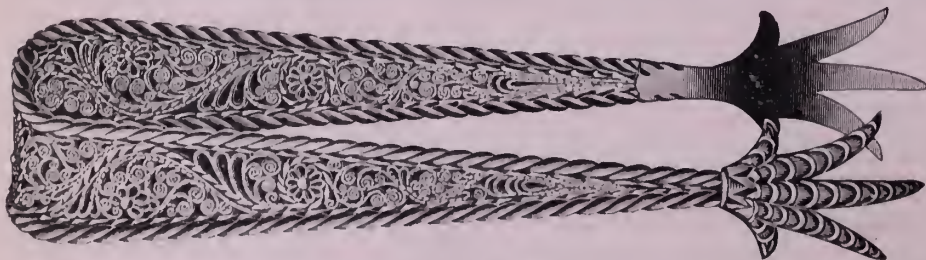

SPECIAL DESIGNS  
AND  
PRESENTATION .∴. PIECES  
MADE TO ORDER.

See our Exhibit, Section N, Manufactures and Liberal Arts Building, World's Fair, Near Tiffany's.

Send for our New Catalogue and Price List.

FREEPORT, ILL.

HOROLOGY AT THE WORLD'S FAIR.

PART XL.—THE EXHIBIT OF DURRSTEIN & CO., CONTAINING MANY IMPROVEMENTS IN HOROLOGICAL SCIENCE.

OF the attention bestowed upon the German jewelry display, the watch exhibit of Durrstein & Co. claims a large share. There are two ebony and plate glass cases, each some 3 feet square by 4 inches deep, lying flat and supported at table height, wherein is exhibited on dark wine colored velvet a large number of watches containing special improvements for which the firm hold patents.

Durrstein & Co. are owners of six patents in Germany, America, England, Austria and Switzerland. The most important of these would seem to be that of substituting bolts for screws in holding the movement in the case. In the Durrstein watch the part of the movement at the seconds dial is first placed in the case, and when the stem is inserted the movement is firmly held. A simple touch of a lever releases the movement. This method is an improvement over screws and permits of a very thin case. The cases require no cap as the movement is removed from the front. With one and the same works the firm can on this account make thinner watches. The movements shown are of ordinary height, the saving in thickness of the complete watch being effected by the bolt method of fastening movements. The cases are dust proof and there is no danger of the bolts loosening. They can be applied to gents' or ladies' watches of any material, open or hunting case; and no extra charge for the improvement. It is a modern invention, the patent having been taken out Jan. 30, 1893.

Another practical idea is a torsion spring for cases. If a lever breaks, a torsion spring can be placed in any case. When the case is closed the coils are brought close together, and released when the case is opened. The setting in of the spring can be done by any one, and it is unbreakable.

An improvement in winding mechanism was patented in February, 1892, in Germany and America. The mechanism is similar to that of a pedometer, and winds the watch when the person carrying it walks. The improvement is a stem wind

which is detached, but can be put in connection with the winding mechanism by a pressure on two levers, which slides two beveled gears on the stem together, the watch thereby becoming a stem wind. As at times a man is forced to relinquish walking for a day or two the improvement is an important one for this class of watches.

A recent patent was granted for improvements in watches for the blind, wherein points project from the bezel, the hours 3, 6,

case, which requires that the blind person shall open the case. The hands are of tempered steel not easily bent and cannot be turned by pressure of the fingers.

Watches showing double time have dials front and back. These are used in Europe, where there is frequent change of time between points not far removed, but they have as yet been little introduced here. The back dial can be covered by the back of the case, and the watch can be made into a hunting case which by removing one case becomes an open face; or an exposed movement can be had by taking off a dial and covering the works with a glass cap.

In another line of watches the dial shows the hours and minutes by exposed plates bearing Arabic figures under the dial, the hours at the top, minutes in the center, and an ordinary seconds dial. Their main point of difference from other watches is that hour and minute plates moving in this way require a stronger mainspring. For the purpose of giving the extra power two barrels are used, both winding at the same time.

The gem of the exhibit is a large watch illustrated here that has been sold for 5,000 marks since it was placed on display. It is self strike, minute repeater, chronograph, double fly back seconds and fifth seconds, and perpetual calendar showing the day of the month, day of the week, month of the year and phases of the moon. It can be set so that the strike will be silent, when it becomes simply a repeater. By means of levers on the outside, every one of the ten hands on the dial can be set without opening the case. The seconds is doubled, one indicating the fifths, going around sixty times a minute, while the other makes but one revolution. When the chrono-

graph is stopped by the lever and the fly back push is touched, the small fifths second stops also and flies back. This is one of the most complicated watches ever made and is a beautiful mechanism.

Durrstein & Co. make a specialty of repeaters, self striking minute and quarter repeaters, chronographs, chronometers, finest

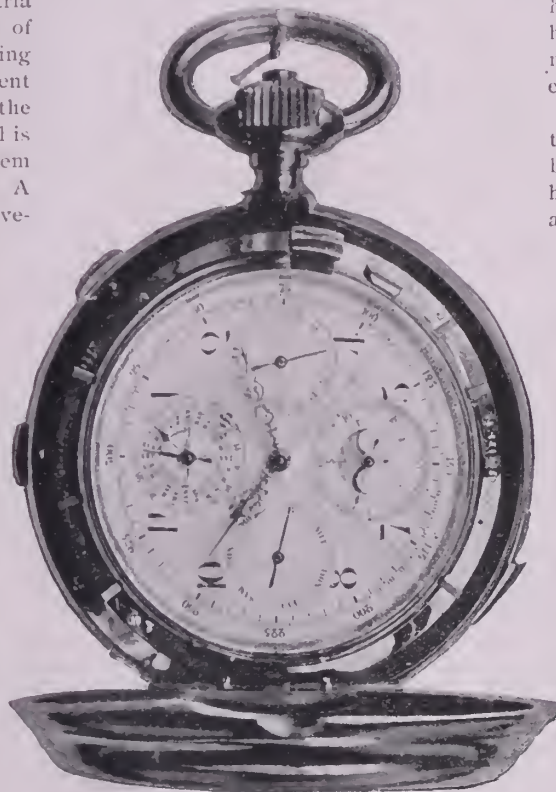

5000 MARKS WATCH IN DURRSTEIN & CO.'S EXHIBIT.

9 and 12 having balls attached while the others are plain. These watches are without crystals and the bezel is beveled to the dial. The practical part consists in the fact that pins are fixed to the bezel which enables a blind person to feel the time. Blind people, it seems, prefer open face watches. To fill this demand glass is set in a hunting

JUERGENS & ANDERSEN COMPANY,

DIAMONDS AND MOUNTINGS,

Order Work a Specialty.

125-127 State St., Chicago.

Glaschütte anchor watch, Union in sizes for ladies and gentlemen, in gold, silver and metal cases, both plain and richly ornamented in engraving, chasing, enameling and diamonds. These anchor watches for ladies are specially desirable by reason of their small size, and have attracted much attention from practical watch men.

Numerous cases are shown with designs in colored gold drawn by Professors Graff, Rade, Naumann and others of the Art School; also monograms in yellow gold and

silver, enameled cases with heads of Fortuna and other goddesses in the center, a small diamond studded case with engraved flower design on bezel, a small sized blue enamel decorated in the lower part with a gold lyre and leaf branches set with diamonds, engraved cases in variety, and silver in plain, engraved and *repoussé*.

A brilliant dial has various bright colored enamels on gold, applied in geometric designs. Hand painted portraits on ivory are set into caps in the same manner as a

crystal. A beautiful example of this work is shown in a portrait of Therese Malten, the famous singer.

The factory turns out annually 56,000 watches at its works. The principal offices are in Dresden. Richard Horstman, who is exclusive agent for Dürstein & Co., in the United States has supervision over the World's Fair exhibit in the German Court of Honor, Manufactures building.

**Gossip of the Exposition.**

The custom house Thursday released from bond for purposes of sale \$3,193 worth of goods in the jewelry exhibit of G. A. Scheid, Vienna, Austria. It is notable that foreign houses are having goods released in large quantities. The firm pay 80 per cent. duty, any surplus being returned after goods are appraised.

The American Exhibitors at their regular meeting Thursday decided to appoint a committee of fifteen members to arrange for a reception and banquet to all American exhibitors at Jackson Park just before the close of the Fair.

Peter L. Krider returned to Philadelphia last Monday after a careful examination of the silverware and jewelry sections of the various countries as a member of the jury in those groups. Mr. Krider, associated with David P. Secor and Goodman King, passed judgment on the most prominent exhibits at the Fair, including that of the Gorham Manufacturing Co. Mr. King left Saturday week for St. Louis. Mr. Secor remains to continue his investigations.

S. H. Brower, manager of the collective exhibit of the New England manufacturers at the Fair, rusticated at Fox Lake, Ill., three days of the past week.

"Marie, what do they mean by a 'diamond in the rough?'"  
 "Oh, those are diamonds worn by the aldermen."—Judge.

**DÜRRSTEIN & CO., Watch Manufacturers,**

**DRESDEN AND GLASHÜTTE, GERMANY.**



**SPECIALTIES:** Repeaters, self-striking minute and quarter repeaters, chronographs, chronometers, finest Glashütte anchor watch (patent union) in sizes for ladies and gents, in plain cases and in cases richly chased, engraved, enameled and diamond set.

**PRODUCTS OF FACTORY FOR SALE BY LEADING JEWELERS.**

REPRESENTED BY

**Richard Horstmann,**

BERLIN, S. W.

ORAMENSTRASSE 101, 102.

World's Fair, German Court of Honor.

MANUFACTURES BUILDING.

**DIAMONDS WATCHES BHA JEWELRY MANUFACTURING**

**L APP AND FLERSHEM** Chicago, Ill.  
 92, 94, 96 & 98 STATE ST. COR WASHINGTON

**THE LARGEST SUPPLY DEPOT**

*For Everything Needed by Jewelers.*

ILLUSTRATED CATALOGUES FURNISHED JEWELERS  
 SPECIAL FACILITIES FOR FILLING ORDERS NO RETAILING!

**STERLING & SILVER PLATE BHA OPTICAL GOODS**

**CLOCKS CANES BHA STUOLS & SEWING MACHINES BHA**

**Montana's interesting Exhibit.**

THE Exhibit of the State of Montana at the World's Columbian Exposition is a fair index of the resources of one of the youngest States in the sisterhood, and may well command from the visitor more than a passing observation. Unquestionably it is the most popular exhibit in the Mining building.

In the center of the mineral exhibit, the chief of all attractions, stands the silver statue of Justice, the largest figure ever cast in any precious metal, so far at least as revealed in the annals of history, ancient or modern. The fame loving Egyptians, Grecians and Romans carried statuary to extremes, seeking thereby to perpetuate the memory of their rulers and warriors and to do homage to their gods, but the enduring marble and bronze were the best materials employed. Justice stands with one foot on a globe, and the entire outline of the splendid and massive figure gives the idea of a forward movement. The goddess wears a tunic which drapes the figure from the swelling breast to a point just below the knee, but the sculptor's work has revealed every line of the nether limbs. The left arm holds aloft the historic scales, and the right grasps firmly the familiar two edged sword which points downward at an angle of forty-five degrees. The expression of the face is grave, but gracious. The tunic, or rather the drapery, with its metal girdle, is Grecian.

The figure rests upon the back of a Montana eagle, also of solid silver. From the eagle to the top of Miss Ada Rehan's head the statue measures nine feet and rests upon a plinth of solid gold, the base being formed of mineral bearing rock. The whole has a height of fifteen feet. The silver was furnished by the First National Bank of Helena, through Ex-Governor S. T. Hauser and Hon. W. A. Clark, of Butte. The gold in the plinth is

loaned by the "Spotted Horse" mine, of Maiden, Mon. The American Bronze Co., Chicago, cast the immense affair. It will be noted that the bandage has been removed from the eyes of Justice, who, for

The display of Montana sapphires, rubies and garnets is excellent and arouses great interest. Many specimens of these gems, both cut and in the rough, are on exhibition. The shades are usually light, but the stones possess a far greater brilliancy than do the Oriental stones. In this connection it may be interesting to note that the Montana Sapphire and Ruby Co., Limited, of London, have made their first shipment of precious stones. This lot contained 33,000 karats. Detail articles on the ruby and sapphire mines of Montana have been published in previous issues of THE CIRCULAR.

**Remarkable Agates from Idar.**

A NUMBER of items of universal interest are shown in the many beautiful forms displayed in the exhibit of the Oberstein-Idarer agate industry by Peter Krauth and August Dreher in the German section of the Mines and Mining building. A very rare piece of agate work which cannot be duplicated in markings is a curiously spotted vase bowl resting on a silver stand. The bowl is twelve inches across and eight inches deep, with a turned over rim, and is oddly spotted with different shades of black, red, brown, blue and gray. The price asked for this piece is \$2,000.

There is probably no finer stone engraving at the Fair than is shown in this exhibit. Most of the designs are taken from Greek and Roman mythology, but the special value lies in the skilled workmanship embodied in the cutting. On a red onyx setting 1x1 1/2 inches in size is a raised white intaglio of Tyche, the goddess of fortune. A profile of Rubens is finely cut in crocidolite, and

Neptune shows out in white relief on brown onyx. Medusa is carved on prima crystal, the size of a dollar. Mars and Venus are carved in white relief from black and white onyx; on the shield of Mars are a chariot and horses. A Bacchalian piece is carved from green jasper. Other beautiful carvings and onyx pieces completely fill a tall case 3x10 feet at base.

Facing the end of the case is the largest piece of agate ever found in Idar. It is in the form of a column, 24 inches long and 6x12 inches at base, tapering to a point. This rests upon a huge base of handsomely carved agate and is a piece of work worthy of earnest inspection. A 4-inch eagle of tiger-eye perches on the top; in the center is a clock. Above the clock in his recessed lair lies a lion of crocidolite; below the clock is a saucer shaped recess showing the beautiful veining of the piece.



THE SILVER STATUE OF JUSTICE IN THE MONTANA EXHIBIT.

no satisfactory reason has groped her way in darkness for 200 years or more. The first sculptors, the earliest painters, the primeval wood engravers all depicted Justice with very wide open eyes.

**"Old English"**

**Coffee Spoon.**



DESIGN PATENTED.

**Towle Mfg. Co.,**

MANUFACTURERS OF

**STERLING SILVERWARE.**

NEWBURYPORT: No. 214 Merrimack St. CHICAGO: Nos. 149 & 151 State St.

### Chicago.

The following buyers and visitors at Chicago and the Fair were noted last week.

Frank D. Day, Duluth, Minn.; P. W. Ellis & Co., Toronto, Can.; J. B. Ferguson, Princeville, Ill.; Wm. G. Earle, Philadelphia, Pa.; Ed. A. Waite, Clare, Mich.; Hugo Carlman, E. O. Zadek Jewelry Co., Mobile, Ala.; Adolph Hopke, with N. V. Cole, Mohegan City, Ind.; Charles C. Crooks, Crooks & Metcalf, Baltimore, Md.; Artes & Alt, Evansville, Ind.; H. M. Rebert, York, Pa.; E. M. Baringer, J. B. Storer & Co., Akron, O.; Joseph Goodman, Memphis, Tenn.; Edward A. Buder, Cairo, Ill.; R. M. Hughes, Adolph Fox, Lima, O.; Justice Stahn, Baltimore, Md.; F. A. Marshall, East Syracuse, N. Y.; M. Strauss, Brooklyn, N. Y.; G. V. Luce, A. E. Luce & Son, Ashland, O.; Mr. Rosenberg, Grand Rapids, Mich.; Chas. Esberger, Cincinnati, O.; Phil. S. Child, A. J. Child & Son, St. Louis; W. J. Van Keuren, Honesdale, Pa.; Mr. Dudley, Indiana Furniture Co., Ft. Wayne, Ind.; Wm. Hooper, Leadville, Col.; Miss Ella Parrott, West Union, Ia.; John J. Cluin, Lowell, Mass.; Jos. Barlorka, Iowa City, Ia.; Mr. Tusten, Shreveport, La.; J. L. Ackerman, Monon, Ind.; Alva Snider, A. L. Howard, Beloit, Wis.; N. S. Plank, Plank Bros., Iowa City, Ia.; H. L. Rost, Columbus, Ind.;

Adolph Staib, Baltimore, Md.; John C. Henn, Wm. Kendrick's Sons, Louisville, Ky.; C. A. Thomas, Hollinsburg, O.; Max Bloch, Roseman & Levy, Elmira, N. Y.; W. A. Wortman, Canton, O.; C. B. Harris, W. S. Shuttler & Son, Dallas, Tex.; A. W. Radde, Cleveland, O.; J. A. Reuling, Wymore, Neb.; J. E. Jarck, Danville, Va.; Isaac Deller, Mineral Point, Wis.; W. S. Dippo, George R. Holmes, St. Paul, Minn.; C. G. Potter, Pittsburg, Pa.; Alfred Lemoine, Fort Plain, N. Y.; F. J. Peterson, Chapman & Jakeman, Norfolk, Va.; J. H. Williams, Scott & Rigby, Milwaukee, Wis.; Chas. Stein, Cleveland, O.; Geo. Lerew, Sidney, Ia.; Oscar F. Sturmer, J. E. Jarck, Danville, Va.; Geo. R. Clark, St. Cloud, Minn.; Menger, Bro. & Wagner, Baltimore, Md.; M. T. Torsen, Decorah, Ia.; O. C. Cobb, Ezra Nuckolls, Eldora, Ia.; A. M. Stein, Albert Lea, Minn.; I. A. Rasmussen, Rasmussen, Webb & Co., London, Eng.; C. N. Husting, New Hampton, Ia.; C. S. Martin, Hamilton, Ont.; E. O. Faren, P. E. Flodman & Co., Oakland, Neb.; H. A. George, Charlottesville, Va.; T. F. Butcher, Brandon, Mass.; Chas. D. Brooke, Coshocton, O.; Benj. F. Spink, Baltimore, Md.; F. G. Altman, Kansas City, Mo.; Rudd & Neilson, Perth, Ont.; Frank P. Nuse, Buffalo, N. Y.; Gustav Spickhart, Nurnberg, Germany; Heinrich Blab, Nurnberg, Germany; Wm. W. Foyt, L. M. LeBron & Son, Ga.

Iena, Ill.; A. Maier, London; Aug. M. Johnson, Manistee, Mich.; M. S. Melzer, Cleveland, O.; S. F. Kaufman, Attica, O.; W. H. Arul, Potsdam, N. Y.; H. C. Bott, Bunde & Upmeyer, Milwaukee, Wis.; E. P. Culver, Iowa City, Ia.; Will G. Gould, Glencoe, Minn.; J. O. Endres, New Albany, Ind.; A. Y. Moorefield, Waco, Tex.; Robert C. Green, Jr., Pottsville, Pa.; E. R. Britton, Eaton Rapids, Mich.; J. J. Weisser, Pittsburg, Pa.; Aug. F. Margilette, Springfield, O.; J. P. Weaver, Miamisburg, O.; Frank J. Schneider, Dubuque, Ia.; Clay Henry, Ironton, O.; Henry Schmiedie, Washington, D. C.; R. M. Buckley, Enterprise, Miss.; Charles C. Barnum, Onarga, Ill.; B. K. Maxfield, Iroquois, S. D.; Fred Aid, Aid Bros., Gallatin, Mo.; O. C. Herold, Ardmore, Va.; A. L. Coleman, Carruth Jewelry Co., Plattsmouth Neb.; C. G. Potter, Pittsburg, Pa.; A. H. Wagner, Prairie City, Ill.; Abr. Yarntzky, L. Kramer & Co., New Orleans, La.; J. C. Northway, La Porte Ind.; Geo. M. Bailey, Uniontown, Pa.; L. S. Grimm, Lebanon, Kan.; M. C. Ellis, Toronto, Can.; P. W. Ellis, Toronto, Can.; S. B. Millard, Litchfield, Minn.; Chas. W. White, Titusville, Pa.; J. H. Wright, Manitou, Ill.; O. B. Marvin, Findlay, O.; John T. Buker, Ranford, Ill.; Geo. B. Bridestone, Sigler Bros., Cleveland, O.; Chas. G. Wood, Indianapolis, Ind.; O. W. Heineman, Philadelphia, Pa.; S. P. Ginnes, St. Louis, Mo.; G. Heckerman, San Antonio, Tex.; Chas. B. Jandorf, New York; W. W. Trigg, Peoria, Ill.; H. F. Barker, Churdan, Ia.; R. J. Schaefer, with Mrs. R. Tuellemann, Milwaukee, Wis.; H. A. George, Keller & George, Charlotteville, W. Va.; F. Goosman, Somerville, Tenn.; H. C. Grawe, St. Louis, Mo.; Geo. La Rue, Sidney, Ia.; Leo. Berg, Stinson & Berg, Camden, Ark.; G. R. Evans, Kendall, Wis.; H. Spahr, Orangeburg, S. C.; E. H. Lumley, Ravenswood, W. Va.

## RECEIVER'S SALE.



ENTIRE Stock of **Giles, Bro. & Co.** Fourth Floor Masonic Temple, consisting of Diamonds, American and Swiss Watches, Jewelry, Silver and Plated Ware, Tools, Materials, etc. will be sold in lots to suit the purchasers, at large reduction from original cost price.

An unusual chance for live Jewelers to obtain bargains.

W. H. GLEASON, Receiver.

July 14th, 1893.



Racine Jewelry Mfg.  
CO.,  
SPECTACLE TEMPLE  
WASHERS,  
Gross in a Bollo, 25c.  
For Sale by Dealers in Job-  
bing Materials

### JEWELERS.

We guarantee to sell you Sterling Silver Flat Ware at a less price than any other manufacturer, and give you newer designs. We will increase your profits if you will let us. Is it not worth trying?

**OVAITT & WARNER, Silversmiths,  
PORTLAND, OREGON.**

ESTABLISHED 1879.

G. W. HOOK,

MANUFACTURING JEWELER,

149 and 151 State Street,

Chicago, Ill.

INSPECTION BY THE VISITING TRADE INVITED.

The following jewelers and their friends visited the rooms of the Chicago Jewelers' Association last week:

Mrs. E. Estep, Marion, Ind.; Sadie Kaye, Pittsburg, Pa.; R. Harris, Washington, D. C.; W. C. Williams, Philadelphia, Pa.; J. R. Heiss, Philadelphia, Pa.; R. C. Beman, Chester, S. C.; S. F. Kaufman, Attica, O.; Carl McClure, Watersmeet, Mich.; E. O. Furen, Oakland, Neb.; D. J. Kramer, Fairmount, Neb.; Abr. Yarntzky, New Orleans, La.; F. E. Dayton, Auburn Park, Ill.; Arnold Zerweck, St. Louis, Mo.; E. Baumgartz, Brenham, Tex.; S. T. McClarren, Pittsburg, Pa.; Orlando H. Slacer, Buffalo, N. Y.; Harry McNaughton, Minneapolis, Minn.; F. J. Peterson, Norfolk, Va.; Sophie Hauser, Milwaukee, Wis.; W. B. Saunders, Huntington, Que.; W. G. Gould, Glencoe, Minn.; J. H. Pink, Puntawney, Pa.; W. S. Orwin and wife, Rushville, Ind.; M. E. Rosenheim, Philadelphia, Pa.; J. O. Endris, New Albany, Ind.; J. N. Mulford, Memphis, Tenn.; Roy Harsh, Vinton, Ia.; J. S. Trepagnier, Plaquemine, La.; F. L. Trepagnier, Plaquemine, La.; D. J. Hurley, New Haven, Conn.; C. F. E. Peterson, Minneapolis, Minn.; M. E. Wilson, Minneapolis, Minn.; M. Wittelschouer, Grand Forks, S. D.; Gustave Speckhart, Nurnberg, Germany; L. Peine, Wharton, Tex.; Geo. C. Mosher, Chattanooga, Tenn.; James Robinson, Melbourne, Australia; Moffett Bros., Edinburgh City, Ind.; Frank J. Schmeltie, Dubuque, Ind.; W. S. Tiffany, Providence, R. I.; Will S. Carpenter, Gaylord, Mich.; Ben Guider, Sr., Vicksburg, Miss.; Geo. M. Guider, Vicksburg, Miss.; Wm. Vollinger, Vicksburg, Miss.; Z. Gamlin, Vicksburg, Miss.; Geo. E. Gail, New Orleans, La.; M. Reinhardt, Jr., Lincoln, Ill.; Anna Reinhardt, Lincoln, Ill.; J. B. Gerkunkel, Columbia, S. C.; Wallace Stevens, Reading, Pa.; John Stevens, Reading, Pa.; A. L. Coleman, Plattsmouth, Neb.; M. E. Miller, New Castle, Wyo.; R. M. Meyer, New Castle, Wyo.; Robert Feickert, St. Louis, Mo.; I. S. Alder, New York; George Young, Jr., Bellevue, Ia.; Frank E. Holmes, Pawtucket, R. I.; Leo Berg, Camden, Ark.; Charles E. Crane, Lake City, Minn.; W. C. Wood, Fairbank, Minn.; George W. Plinke, Louisville, Ky.; J. Han-ni-gs, Philadelphia, Pa.; George Krenzel, George-owa, S. C.; H. G. Fisher, Blair, Neb.; J. P. Gleason and wife, Grand Rapids, Mich.; P. W. Graff, Lyons, N. V.; E. C. Long, Mattona, Ill.; A. B. Hull, Hastings, Mich.; John J. Cluin, Lowell, Mass.; M. E. Smith, West Superior, Wis.; W. D. Sproesser, Water-town, Wis.; J. R. Ray, Salem, Mo.; E. Sedgwick,



Philadelphia, Pa.; W. N. Sedgwick, Philadelphia, Pa.; H. F. Lushbough, Mt. Pulaski, Ill.; W. E. Wilson, Narasota, Tex.; Fred. Goemann, Somerville, Tenn.; I. A. Worch, Fort Wayne, Ind.; R. L. Moore, Mt. Airy, N. C.; Wm. Hooper and wife, Leadville, Col.; L. H. Guernsey, Hastings, Neb.; J. W. Garman, Ft. Wayne, Ind.; George Lees, Hamilton, Ont.; H. Voight, Baltimore, Md.; F. H. Frohnhauser, Baltimore, Md.; L. Gutmann, Cincinnati, O.; L. W. Sween, West Liberty, Iowa; W. A. Sheaffer, Bloomfield, Ia.; H. L. Rost, Columbus, Ind.; B. F. Jeter, Butler, Ind.; Ed. A. White, Clare, Mich.; A. L. Coleman, Plattsmouth, Neb.; F. H. Delano, Russell, Ia.; W. H. Wright, Binghamton, N. Y.

John T. Holmquist, 1343 Belmont Ave., has confessed judgment for \$590.

Philip Muhr, of H. Muhr's Sons, is expected in the city the present week.

Aaron Herman, of D. Schroder & Co., Cincinnati, is visiting the Fair with his family.

Mr. Barton, of Ostby & Barton Co., looked in on the firm's Chicago office the past week.

S. K. Zook and bride, of Lancaster, Pa., late of Kayser, W. Va., are among the World's Fair visitors.

Daniel Earl, opal and precious stones dealer of Sidney, New South Wales, is visiting Chicago merchants.

F. Haviland, of Haviland & Abbot, left for New York Friday, well pleased with a week's outing at the Fair.

There is talk of extending the Saturday closing of wholesale places of business from Sept. 1 to Oct. 30, when the Fair closes.

M. Redon, of Limoges china fame, will leave Limoges, Sept. 2nd, arriving in New York about the 12th. M. Redon will spend a few weeks at the Fair.

G. A. Scheid, the Vienna manufacturer of silver and enameled wares, left Friday,

having spent a month at the Fair examining exhibits as a member of the jury.

Chas. M. Rosenthal, representing several of the Bohemian glass manufacturers at the Fair, has left the city for a short vacation on account of ill health.

A. E. Berndt, engraver, 802 Columbus building, expects to increase his force the present month. Mr. Berndt reports a large amount of work.

O. A. Schneider, representing Hammel, Riglander Co., has returned from Omaha and Kansas City, and reports sales to every dealer approached in both cities.

The Rockford Silver Plate Co., Rockford, Ill., brought suit in attachment in the Circuit Court Saturday week, against the Barrett Hotel Co., laying damages at \$2,007.

John M. Bredt & Co., manufacturers and dealers in jewelry, have incorporated with a capital stock of \$5,000; incorporators, John M. Bredt, John S. Butler and Willard M. McEwan.

A case for trespass in the sum of \$1,000 has been filed in the Circuit Court by Louis

Manasse against the World's Columbian Exposition. The suit is on account of articles stolen from the plaintiff's exhibition cases.

Sophus Samson the past week received from the Alvin Mfg. Co. a line of their souvenir spoons of latest patterns. The firm have established a branch office at 802 Columbus Memorial building, with Mr. Samson in charge.

K. V. R. Alberston, Australian traveler for the Meriden Britannia Co., has returned to Chicago, after an absence of two years. Mr. Alberston reports business in his particular line very good, despite the Australian bank failures. On Sept. 15th he leaves for the factory.

Hyman, Berg & Co., State and Washington Sts., exhibit in their north show window the black diamond recently cut by Stein & Ellbogen Co. at the latter's diamond cutting establishment in the Columbus Memorial building. The stone is finely cut, weighs five karats and is valued at \$700.

**QUALITY IS THE STANDARD OF VALUE.**

ONE OF THE BEST OF THE VERY BEST

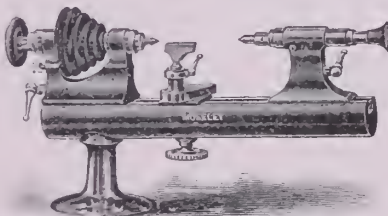

MEN INTERESTED WRITE YOUR JOBBER OR

HAS LENGTH, STRENGTH, ACCURACY.

**MOSELEY & CO., - - ELCIN, ILL.**

**IRONS & RUSSELL,**

(SUCCESSORS TO CHARLES F. IRONS.)  
MANUFACTURERS OF

**SOLID GOLD EMBLEMS ROLL PLATE**  
PINS, CHARMS AND SOLID GOLD RINGS.

102 Friendship Street, - - Providence, R. I.



**THE PLANCHAMP & BECKER CO.**

Makers and Repairers of

**WATCH CASES,**

Gold and Silver Plating —

— of Watch Cases a Specialty.

UNEXCELLED FACILITIES.

63 and 65 East Washington St., Chicago.

**PARSONS : SCHOOL**

— FOR —

**WATCHMAKERS,**

**PEORIA, - - - ILL.**

Send for Circular and Terms.

**PARSONS & CO.**

**HENRY J. ROHRBACH,**

94-96 State Street,  
(Room 524,) CHICAGO.

SILVERSMITH AND MANUFACTURING JEWELER,

**COLD, SILVER AND NICKEL PLATER.**

Silver and Silver-Plated Ware of all kinds Repaired, Refinished and Polished at Low Prices.

SEND FOR PRICE LIST.

ALL KINDS OF BRONZES REPAIRED AND REBRONZED.

Full facilities for manufacturing and repairing all classes of Jewelry for the Trade.

Remember—Room 524.

**GIBSON HOUSE.**

CINCINNATI, OHIO.

ABSOLUTELY FIRST-CLASS AMERICAN PLAN HOTEL. \$3.00 PER DAY

Extra Charge for Parlors and Rooms with Bath attached. The unequalled advantages in central location, liberal management, modern appointments, experienced service and perfect cuisine, have permanently established the Gibson House as The Most Popular First-Class Hotel in Cincinnati.

AMPLE VAULTS FOR THE PROTECTION OF VALUABLES

**THE GIBSON HOUSE CO.**

H. B. DUNBAR,

President and Manager



**CHICAGO WATCH TOOL CO.**

SPECIAL MACHINES

MANUFACTURERS OF  
**JEWELERS' MACHINERY,**  
**WATCH MAKERS'**  
and  
**JEWELERS' TOOLS**  
Etc.

TOOLS MADE TO ORDER

**52 MADISON STREET CHICAGO**

**Detroit.**

H. N. Rolshoven has gone on a pleasure trip around the lakes.

Frank S. Ring will attend the G. A. R. encampment at Indianapolis, next week.

The United States Optical Co. have given notice of an increase in their capital stock from \$50,000 to \$100,000.

S. Blashill & Son, Imlay City, Mich., have dissolved partnership. Mr. Blashill will continue the business, and his son will start a new jewelry store at Oxford, Mich.

Robert Beaty, watchmaker for Eugene Deimel, has bought the jewelry stock of Jerome Oliver, 548 Baker St., and will continue the business. Mr. Oliver will retire.

The following Michigan country buyers were here last week: J. C. Bates, New Haven; William Ambler, Northville; A. W. Kludt, Richmond, and Eugene Campbell, Pinckney.

Leon Schon, the young diamond setter, who was falsely imprisoned by a suburban justice, will be released this week. He and other innocent victims will commence damage suits. The justice has resigned.

A foot-pad attempted to hold up jeweler G. M. Laurie, 952 Grand River Ave., last week, while he was walking on Commonwealth Ave. The jeweler's cries brought the police, but the thief escaped.

The following jewelers have contributed handsome prizes for the winners in the races to be held here Sept. 4 by the Diamond Cyclists: Black & Connolly, Adolph Enggass, F. G. Smith, Sons & Co., and Wright, Kay & Co.

**Louisville.**

J. B. Girardet, of Irion & Girardet, has just returned from a visit to the World's Fair.

S. S. Lieberman leaves Sept. 9th for the World's Fair.

Hogan & Co., art and bric-à-brac dealers, 534 4th St., have moved to 264 W. Main St.

Coleman Adler, L. & J. Adler & Co.; Millard Veit, Marx, Veit & Co.; S. Veit, Marx, Veit & Co., were here last week.

M. Loreh, formerly on Market near 4th St., has moved his entire stock to the store of Geo. W. Chreste & Co. on Market near Brook Sts. It is said he holds a partnership interest in the firm of Geo. W. Chreste & Co.

**Kansas City.**

H. B. Carswell has returned from New York and the World's Fair.

The Jaccard Watch and Jewelry Co. have secured the contract for all the prizes for the bicycle meeting at Fairmount Park this week.

J. R. Gleason, who was with M. B. Wright & Co., expects soon to open a jewelry store at 1,007 Walnut St. He has not yet bought his stock.

It is reported from Mound City, this State, that last Monday night the jewelry store of Wampler & Lidstone was broken into. The thieves stripped the cases of everything they contained. The goods taken will reach several hundred dollars in value.

**Cleveland.**

Davis & Co., 560 Pearl St., have removed to Lorain St.

Wm. H. Wightman, of R. F. Simmons & Co., was in town last week.

Russell E. Burdick, of the Bowler & Burdick Co., has just returned from a business trip to Europe.

Joe Eddell is preparing to open a retail watch and jewelry store at 221 Superior St., and will be ready for business by Sept. 15th.

**Cincinnati.**

John Holland is remodeling his office and salesroom.

Frank Herschede has canceled a real estate mortgage for \$3,000.

Joseph T. Homan and wife have returned from a visit to Cape May, N. J.

W. T. Eichelberger and wife and Jos. Noterman, son and wife are in Chicago this week.

Jos. Mehmert has invented a new tool for jewelers that he will soon place on the market.

Duhme & Co. will start up neither their watch case nor silverware factories, until the silver question is settled.

Homan & Co. report an improved condition of business. Orders for future delivery are coming in rapidly.

Wm. Plueger, of Jos. Noterman & Co., has returned and reports trade fair. He will go out again in a few days.

W. T. Eichelberger & Co. are settled in their new quarters at 153 W. 5th St. Ed. Croniger is in charge during Mr. Eichelberger's absence.

Wm. H. Ludwig, who since '79 has been in Geo. W. Ludwig's jewelry store, Chambersburgh, Pa., and for recent years the skilled repairer, decorator and head clerk, has left for Cincinnati, where he will have charge of the six large windows and the watch department of Oskamp, Nolting & Co. His original, artistic window decorations, reproduced in THE CIRCULAR attracted much attention everywhere and secured for him a deserved prominence.

Sheriff E. A. Day, of Warsaw, N. Y., is offering a reward of \$100 for the capture of the thief who stole a quantity of jewelry from the store of H. D. W. English, Arcade, N. Y., on July 26th.

# The Wadsworth Watch Case Co.



General Offices,  
NEWPORT, KY.

Filled



Cases.



Chicago Office,  
COLUMBUS BUILDING.

**The Assets and Liabilities of M. C. Kummerer.**

MINNEAPOLIS, Minn., Aug. 25.—The schedules filed by M. C. Kummerer, who recently assigned show the following figures. The assets are as follows:

Stock of merchandise on hand, \$1,700.00; equity in diamonds and jewelry, hypothecated amount of \$2,000, \$300.00; store fixtures, mortgaged to secure rent of store from May 1, 1893 for one year's lease at \$1,500 per year, \$1,000.00. Total amount of assets, \$3,000.00, against \$5,030.28 liabilities.

The following is a correct list of all the creditors:

C. H. Knights & Co., \$324.00; A. Hirsch & Co., \$180.87; Geneva Optical Co., \$275.00; M. A. Mead & Co., \$225.30; Wendell Mfg. Co., \$41.57; Pairpoint Mfg. Co., \$76.38; Giles, Bro. & Co., \$207.00; Wm. L. Gilbert Clock Co., \$125.70; Seth Thomas Clock Co., \$59.97; Arnstein Bros. & Mier, \$842.17; Kent & Stanley Co., \$147.81; Waterbury Clock Co., \$38.75; Goldsmith Mfg. Co., \$111.81; Ed. Todd & Co., \$15.25; Seckels & Oppenheimer, \$650.00; Henry Muller, \$220.00; Trier Bros., \$412.26; Aikin, Lambert & Co., \$76.74; Heintz Bros., \$248.03; A. F. Towle & Son Co., \$131.60; L. H. Keller & Co., \$8.65; A. Sanborn, \$240.00; Aurora Silver Plate Co., \$371.34.

**Minneapolis and St. Paul.**

W. C. Baker, Billingham, Minn., has sold out his business.

A judgment for \$215 has been entered against M. C. Kummerer.

Arthur Fritz, Minneapolis, has gone on a two weeks' vacation to Chicago.

C. Benjamin, of Benjamin & Co., Minneapolis, has returned from a ten days' trip to Chicago.

Ed. Fessler, St. Paul, who has been on a visit to his former home at Fort Dodge, Ia., returned last week.

Z. Edelstein, Minneapolis, formerly with S. Lacs, has started in the jewelry business for himself at 103 Nicollet Ave.

W. C. Weld, of Weld & Sons, Minneapolis, has gone east on business, and on his return intends to visit the World's Fair.

**Indianapolis.**

Edward Ducas and family have returned from the World's Fair.

J. B. Sprunger, Berne, Ind., has given a chattel mortgage for \$300.

Abbott & Fewell have opened a new jewelry store at Dupont, Ind.

H. L. Kepler, Fairmount, Ind., has sold out to G. B. Hale.

S. Cohen, Anderson, Ind., and I. Booth, Tipton, Ind., bought goods in this city last week.

Christopher Bernloehr, jeweler, 43 Russell Ave., was robbed last week of several rolls of chains valued at \$150.

**PIVOT DRILLS THAT WILL DRILL.**

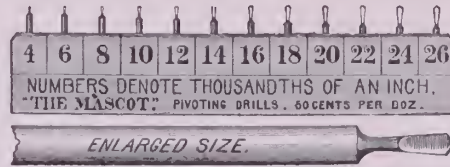

The Mascot is the best made Pivot Drill in the world. This is a strong assertion, but it is justified by the quality of the drills.

The following unsolicited testimonial would also seem to warrant our assertion:

MESSRS. EZRA F. BOWMAN & CO., LANCASTER, PA.:

Gentlemen—I am in receipt of your Mascot Pivot Drills that I ordered on the strength of your statement in the May issue of the "Keystone." Having tried every so-called Pivot Drill that my attention was directed to, and meeting with dismal failure, I was naturally inquisitive to learn what your Mascot was capable of doing. I took a Seth Thomas Clock mainspring, and subjected six drills out of each dozen to the test of drilling twenty holes through without drawing the temper. Every drill stood the test and your claim in the "Keystone" is warranted by the facts.

Yours truly,

L. F. GIERING

Sent by mail, postage paid, on receipt of 50 cents.

**EZRA F. BOWMAN & CO., Lancaster, Pa.**

**BLANCARD & CO.,**

LATEST ROCOCO DESIGN IN GALLERY.



DIAMOND SETTINGS. GALLERIES. HOLLOW BALLS, ETC.

SEND FOR OUR CATALOGUE.

**45 & 47 John St., New York.**

**REED & BARTON,**

**SILVERSMITHS,**

MANUFACTURERS OF

STERLING <sup>and</sup> SILVER PLATED  
SILVER WARE.

SALESROOMS:

**37 Union Square, New York.**

34-36 WASHINGTON STREET,

**Venetian Building, Chicago.**

FACTORIES, CAUNTON, MASS.

**Connecticut.**

Breckbill & Maarsh, Bridgeport, are adding a stock of optical goods.

The E. A. Bliss Co., Meriden, are enlarging and improving their main office.

W. A. Wallace, wife and daughter, Wallingford, are at the World's Fair.

The Meriden Silver Plate Co. are now running five days a week on eight hours' time.

S. E. Root's clock dial factory, Bristol, closed Saturday last until Sept. 4th.

The Wm. L. Gilbert Clock Co., Winsted, have shipped 100 "nickel in the slot" machines to western parties.

At John B. Gardner's clock dial factory, Ansonia, work has been resumed on three days a week time.

J. D. Bergen, head of the J. D. Bergen

Co., Meriden, and wife have returned home from a very enjoyable vacation at Cape Cod.

The Waterbury Clock Co.'s works started up Aug. 28th after a week's shut down for repairs.

Samuel H. Kirby, New Haven, wife and family are in the White Mountains and return about Aug. 31st.

Clarence Griswold, traveling salesman for the Middletown Plate Co., is home in Westfield, for a short vacation.

A son was recently born to Mr. and Mrs. William S. Rice, at Elyria, O. Mr. Rice is traveling salesman for the Wileox Silver Plate Co.

The E. Ingraham Co., Bristol, are calling in some of their men and the chances are that their shops will be running before September 1st.

F. A. Shepard, of Torrington, is making an appraisal with Lawyer Roberts of the stock of W. A. Beach, of Litchfield, who failed a short time ago.

Col. Leavenworth and Gurdon W. Hull, Wallingford, have returned from a short stay at Block Island, where Col. Leavenworth's daughter is spending the Summer.

The Scovill & Adams Mfg. Co., manufacturers of the Scovill kodak, opera glasses and optical goods, posted a notice Aug. 18th stating that their shop would be closed down until further notice.

Simpson, Hall, Miller & Co. have made to order a beautiful silver cup now on exhibition at Frank's jewelry store, Meriden, which will be awarded to the most popular man in the Labor Day parade in New Haven.

**THE OLD FAMILY CLOCK.**

It stands in the corner of the room  
Behind the door, in the shade and gloom,  
In a heavy antique case—  
Rich mahogany, maple and oak;  
Battered and scratched, and dim with smoke,  
And the hands are bent on the face.

The knob and hinges are red with rust,  
The top of the molding covered with dust,  
The panels are yellow with stains;  
And a ragged web, like a tattered pall,  
Runs from its side to the somber wall,  
And over the window panes.

The pendulum swings, the wheels go round,  
Making a dull monotonous sound,  
As the vanishing moments fleet;  
A tick, like falling grains of sand,  
As Time was pouring from out his hand  
The dust of years at his feet.

Years have vanished—forgotten years,  
With all their sorrows and sins and tears  
And left their mark in the hall.  
The old have died, the young grown old;  
Generations have gone to mold,  
And the clock survives them all.

—Selected.

Harvey H. Shomo, formerly in the jewelry business on Penn St., Reading, Pa., has accepted the secretaryship of the National Brass and Iron Works, of that city.

# WALTHAM REPEATERS

## STRIKING HOURS AND MINUTES.

TO THE TRADE:—

Having purchased the entire remaining stock of WALTHAM REPEATING MOVEMENTS from the American Waltham Watch Co., and cased them in 20 year 14k. Cases, I am prepared to sell them at prices 30 per cent. less than they have ever been offered before.

Artistic Special Catalogue Free.

Send for Prices and Terms.

# JOHN B. YATES,

21 & 23 MAIDEN LANE, NEW YORK.



## THE BONNER COMBINATION

### RING, SCARF PIN AND STUD.

The Best Combination ever made.

MANUFACTURED BY

## BONNER, RICH & Co.,

Makers of DIAMOND MOUNTINGS  
RINGS A SPECIALTY.



To the Jobbing Trade Only. 41 MAIDEN LANE, NEW YORK.  
Factory, 44, 46 and 48 Hill St., Newark, N. J.

ESTABLISHED 1870.

## J. L. CLARK,

**SWEEP SMELTER AND REFINER OF GOLD AND SILVER.**

Buys every kind of Gold and Silverware, Jewelry, Watches and Platinum. Full market value paid.

**No. 724 Filbert Street, Philadelphia, Pa.**

SEND BY EXPRESS or Registered Mail. If my price is not satisfactory, I will return all articles.



## MUELLER'S ARTIFICIAL EYES.

\$75 per hundred; smaller lots, \$15 per dozen; \$2 each. A large assortment of eyes will be sent to any dealer to enable him to make selection, upon receipt of satisfactory references. We carry the largest stock in America.

ONLY MANUFACTURERS OF THE "DIAMANTA" SPECTACLES AND EYE-GLASSES.

Oculists' prescriptions promptly and accurately filled. Catalogue, price lists, test cards, etc., on application.

M. ZINEMAN & BRO., American Agents, 130 South Ninth St., Philadelphia.

# WATERMAN & LEHMANN,

MANUFACTURERS OF

## DIAMOND JEWELRY

AND DEALERS IN

## DIAMONDS,

No. 37 MAIDEN LANE,

NEW YORK.

### Boston.

Labor day (Sept 4) will be celebrated with a harbor excursion by the employes of Morrill Bros. & Co.

J. W. Goddard and wife sailed for England on the *Patonia* last Saturday. They will remain abroad until October.

The United States Watch Co.'s factory, at Waltham shut down Saturday night for one week, in order to make necessary repairs on the boiler.

Dean Southworth has opened an office in the Marlboro Building, room 4, 403 Washington St. Mr. Southworth was formerly of the firm of D. C. Percival & Co.

On the vacation list are Miss May M. Smith, assistant bookkeeper for Harwood Bros., who is at Skowhegan, Me.; C. S. Watson, with Morrill Bros., & Co. F. C. Graves, with Robbins, Appleton & Co., who is at Onset Bay.

A paper has been circulated through the jewelry jobbing trade for a continuation of the Summer early closing arrangement through September. Several of the leading firms agreed to the proposition.

The E. A. Whitney Company has been organized to continue the business of E. A. Whitney, the old firm having paid the amount confirmed by the court to the creditors, receiving thereupon a discharge. The new concern is capitalized at \$35,000 and officered as follows: President, Charles P. Fenno; secretary, C. E. Stiles; treasurer, Edward A. Whitney.

### Providence.

The report that E. A. Mitchell, 10 $\frac{1}{2}$  Plainfield St., was out of business, is incorrect.

George Becker, of Hancock, Becker & Co., left Friday for an extended trip through Canada.

R. G. Schutz has accepted a position with J. W. Grant & Co., as designer for a new line of chains and as market representative.

By the recent failure of A. Bornstein, Philadelphia, local manufacturers are interested in amounts aggregating nearly \$10,000.

The inventory of the estate of William F. Cuddy (minor) has been accepted by the Municipal Court; pers. nal, \$6,666.66; real, \$2,600.

John A. Buffinton, father of John M. Buffinton, of Potter & Buffinton, died on the 22d inst., at his home at South Rehoboth, Mass., in the 83d year of his age.

News was received in this city Saturday morning that the Attleboro Stock Co., having headquarters in New York, had confessed judgment for a large amount. Providence and Attleboro manufacturers are said to be interested to the extent of from \$15,000 to \$20,000.

In the Municipal Court on Friday last the sad case of Thomas W. Lind, the well known manufacturer of jewelers' findings, was considered and he was adjudged to be wanting

in discretion in managing his business and estate, and his brother, Peter Lind, was appointed guardian of his person and estate; bond, \$5,000; surety Thomas Grimes; appraisers, Louis L. Angell, Harry C. Curtis and John McWilliams.

### Albert Lorsch & Co. Lose a Case of Diamonds.

A package of diamonds valued at \$1,800 is missing from a box of jewelry shipped to Albert Lorsch & Co., 37 Maiden Lane, New York, on *La Normandie*, which arrived on Aug. 14th. The box in which the jewels were packed was about three feet long and two feet wide. It was opened by a Custom House officer in the presence of several other employes of the Custom House. When he missed the diamonds he reported the loss to Albert Lorsch & Co. at once.

The rest of the jewelry in the box was in good order. The examiner said that the inner box which was supposed to contain the diamonds, was intact when he examined it. This fact led Albert Lorsch & Co. to cable to Europe to ask if the diamonds had actually been shipped. Word was received that they had been sent in the case with the other jewels. The loss will probably fall on the firm if the diamonds are not traced.

Albert Lorsch & Co. were the victims of another mysterious robbery, about a year ago. Over \$7,000 worth of goods was abstracted from a case while it was being transferred from the Barge Office to 37 Maiden Lane.

### Several Philadelphia Crooks Brought to Book.

PHILADELPHIA, Pa., Aug. 28.—The police have succeeded in bringing several of the jewelry robbers to book. Yesterday Ernest Hughes, colored, was arrested in West Philadelphia on suspicion of being the man who broke into Joseph E. Daily & Co.'s store, 3301 Market St., on Thursday last and got away with watches and money. He admitted his guilt and to-day Magistrate Clement held him for trial.

Another important capture was made on Saturday. William Sibley was arrested while peddling jewelry at the Ninth Ward Gas Works. He had a satchel containing a large number of gold watches, rings and other articles of jewelry. It was afterwards found that they were the property of John F. Bates, 3402 Market St., whose store had been robbed some time ago. Sibley was also committed for trial to-day.

John Curry, Joseph Mc. Ardle and Chas. Savery, the three men arrested last week for breaking into Clark Bros.' Chestnut St. jewelry store, and H. T. Sanders' optical goods store in 13th St., were to-day held in \$2,000 bail each for court.

Jeweler E. Kretzmar, 1802 Chestnut St., reports that on Friday last he lost a \$500 diamond ring. A paste stone was substituted by a stylishly dressed customer who he says looked over some jewelry on that day.

### Points at Law.

#### AFFIDAVIT OF ATTACHMENT.

Where an affidavit for attachment, made by a partnership, stated that the debtors are justly indebted to the "said plaintiff," and that they are likely to lose their debt, the use of the word plaintiff is a clerical error, and such affidavit is unobjectionable.

*Weis v. Chipman. Court of Civil Appeals of Tex.*

#### MEASURE OF DAMAGES FOR FAILURE TO DELIVER MESSAGE.

Where a message relates to a sale and delivery of cattle, the contract for which was made by the sender on the owner's behalf, the measure of damages for failure to deliver the message is the difference between the market value where the cattle were at the time, and the contract price at the place of delivery, less the cost of transportation to the latter place.

*W. U. Tel. Co. v. Vifford. Court of Civil Appeals of Tex.*

#### POSSESSION BY ASSIGNEE.

Under the statute which prohibits an assignee for the benefit of creditors from taking possession until after the filing of an inventory of the property, and a bond, with the clerk of the court, it is the duty of the assignor to remain in control of the property and to protect it until the inventory and bond are completed; and the taking of exclusive possession by the assignee, before that time, though for the purpose of making the inventory, avoids the assignment.

*Smith v. Patterson. Supreme Court of Ark.*

#### PARTNERSHIP ACCOUNTING.

Where one bought a half interest in a business, it was agreed that the partnership could be terminated by him at the end of a year, on 30 days' notice, he to be repaid the purchase price. Each partner was to enter in the firm books, all moneys received by him. He did not forfeit his rights, in the absence of fraud, because of an omission to charge himself with a small amount received in the business. An agreement that if he withdrew, he should forfeit his undivided one-half share of the earnings of the partnership during the year, meant one-half of the net earnings.

*Kemp v. Smith, Supreme Court of Iowa.*

**Preparing for Wet Coloring.**—There are several methods of preparing work for wet coloring, each operator adopting the one which suits him best and appears to claim an advantage over the others. We do not intend to assert that there is any particular advantage in the adoption of any particular process. The main principles are thorough polishing (this need not be so much the case as for dry coloring, though it is of great importance) and cleanliness, the latter element being very essential in the production of a good color. The operator cannot be too careful in enforcing these two conditions.

## Our Traveling Representatives

Traveling representatives may consider these columns open for the publication of any news or items of interest regarding themselves or their confreres.

**T**HE St. Louis members of the Retail Jewelers' Association of Missouri gave an excursion up the Mississippi, Sunday, Aug. 20th, taking with them as their guests the following representatives of New

York wholesale jewelers: L. Barnett, Auerbach & Barnett; L. Bernheim, L. Weil & Co.; Fred England, H. Z. & H. Oppenheimer; J. S. Jepson, Veit Hirsch & Co.; I. Freundlich, Odenheimer, Zimmern & Co.; J. Marx, Kossuth Marx Jewelry Co.; E. Bernstein, Wolf & Co.; C. W. Battley, Waite, Mathewson & Co.; G. V. Dickinson, Elgin National Watch Co.; F. R. Cross, Columbus Watch Co.; and G. W. Mindil, Du Bois Watch Case Co.

The party assembled at the Southern Hotel, at 8 A. M., and with a band of music composed of twenty pieces, were driven to the boat landing. The New Yorkers wore badges inscribed "New York Jewelry Travelers' Delegation," besides a 50 karat "diamond" in their shirt fronts. After a day pleasantly spent in various sports as target shooting, football, baseball and dancing, the boys returned to the hotel at 9 P. M. as happy a lot of drummers as ever carried a gripsack.

Jos. E. Reagan, salesman for Baldwin, Miller & Co., Indianapolis, Ind., is enjoying the sights of Chicago.

Eugene C. Holbrook, Pooh Bah for Frank W. Smith, Gardner, Mass., arrived Wednesday in Chicago and displayed full lines of the factory at the Palmer.

C. B. Bartlett, Whiting Mfg. Co.; S. B. Hodgins, Rogers & Bro.; and a representative of the Western Clock Mfg. Co., will visit Kansas City this week.

George Greubel, the genial missionary for the Keystone Watch Case Co., returned to Philadelphia last Tuesday. G. W. Roberts assumes the charge of the Keystone Watch Case Co. exhibit.

Waite, Thresher Co., by E. L. Mumford; M. A. Mead & Co., by Tom Hoeser; and the Geneva Optical Co., by T. Wall; were the eastern firms represented in the Twin Cities the past week.

F. O. Fuller and J. M. Gurley, missionaries for the American Waltham Watch Co., returned from a two months' trip west, and late in the week E. H. Wells in the same capacity left for the territory immediately east of Chicago.

Among the travelers visiting the Chicago trade last week were noticed: John Platt, Foster & Bailey; J. D. Underwood, Cham-

penois & Co.; J. J. Sullivan, W. M. Carr & Co.; Mr. Ripley, Watson, Newell & Co.; Mr. Barton, Ostby & Barton Co.; Dick Robinson, T. G. Frothingham & Co., and J. Solinger, S. & B. Lederer.

The following traveling salesmen were in Kansas City, Mo., last week: George L. Brenning, Dennison Mfg. Co.; Henry H. Jacobson, Jacobson Bros.; C. F. Livermore, Middletown Plate Co.; H. A. Bliss, Krenmentz & Co.; Herman Kind, Graef & Schmidt; Charles Altschul, Oppenheimer Bros. & Veith; A. B. Speir, Champenois & Co.

Travelers in Pittsburgh, Pa., last week were: Mr. Wagoner, L. J. Glaenger & Co.; Arthur Bradshaw, Meriden Britannia Co.; W. J. Carrow, Mandeville & Co.; H. B. Kennion, H. D. Merritt & Co.; Ed. Rogers, Park Bros. & Rogers; John Platt, Foster & Bailey; Col. Stevens, Brooklyn Watch Case Co.; J. E. Simonson, A. J. Hedges & Co.; and H. W. Towade, N. Glauber & Co.

Traveling men who recently stopped at Indianapolis, Ind., were: M. L. Jacoby, Providence Stock Co.; F. C. Somes, Marsh & Bigney; J. Fuller, Fuller & Mayer; Jos. Becker, Jos. Fahys & Co.; Chas. Whiting, Jr., Crescent Watch Case Co.; Mr. Cross, Columbus Watch Co.; E. L. Mumford, Waite, Thresher Co.; Louis Rauch, Strauss & Stern; and a representative of Waite, Mathewson & Co.

Traveling men in Detroit, Mich., last week were few and far between. Among them were noticed: Harry Osborne, Whiting Mfg. Co.; Eugene Holbrook, Frank W. Smith; Mr. Simonson, A. J. Hedges & Co.; Tom Davis, Middletown Plate Co.; Arthur Pinover, A. Pinover & Co.; H. C. Kinney, Silver Metal Mfg. Co.; Charles F. Ketcham, Riker Bros.; Alfred R. Varian, Dennison Mfg. Co., and a representative of the Waterbury Clock Co.

Traveling representatives calling on Syracuse, N. Y., firms the past week were: M. L. Hammel, Keller, Ettinger & Fink; E. Kubie, Levy, Dreyfus & Co.; R. T. Supple, William B. Durgin; Frank E. Davis, Hayden W. Wheeler & Co.; J. N. Beckwith, Jos. H. Fink & Co.; Fred S. Failing, the Silver Metal Mfg. Co.; W. T. Sherman, Gustave Walter Optical Co.; Mr. Weil, J. M. Weil & Bros.; Harry B. Kennion, H. D. Merritt & Co.; Col. Stevens, Brooklyn Watch Case Co.; B. C. Crandall, Crandall & Pardee; F. W. Bliss, Unger Bros.; E. Jacobson, Jacobson Bros.; Joe Beach, Wilcox Silver Plate Co.; Mr. Rosenbaum, B. H. Davis & Co.; A. A. Dorchester, Kent & Stanley Co.; W. M. Clements, Waterbury Clock Co.; Sam Cohn, Oppenheimer Bros. & Veith; L. A. Van Horn, Philipp Zellenka & Son; C. F. Goodwin.

### Springfield, Mass.

J. W. Nickels has purchased the business of the late P. J. Walter, 441 State St.

Charles E. Van Norman, of the Waltham Watch Tool Co., has been granted two pat-

ents, 502,894 and 502,895, the former on setting lacing-studs, eyelets etc., and the other on a hopper and delivery mechanism for studs.

The Ames Mfg. Co., Chicopee, have completed a coin silver statuette of the trotter, Sunol, hitched to a sulky, upon which is seated an equally noted driver. The piece is one-fifth life size, and is mounted upon a bronze standard. The sculptor is C. E. Dallin, of Salt Lake. The whole piece was molded from silver dollars. It required three hundred and thirty-one ounces of silver. The sulky is an exact fac-simile of the one in which the mare made her record of 2.08¼, which for a time was a world-beater.

### The Attleboros.

Edward Whitney, formerly with Kent & Stanley Co., of Providence, and now a resident of this village, is erecting two large hot houses in the rear of his residence on the Boston and Providence turnpike.

Over the polishing bench of D. F. Briggs Co.'s shop revolves a hugh paper fan to drive the heat, flies and hard times away; in consequence this shop has been signally successful in vanquishing these Summer plagues.

George D. Bullock, his wife and daughter, were thrown from their buggy some evenings ago. Mrs. Bullock was slightly injured and the daughter badly bruised and cut about the face and right arm. Mr. Bullock sustained severe injuries to his skull. The shadow of a bicycle frightened the horse, which turned in the street, throwing the occupants of the vehicle upon the concrete walk.

### Pittsburgh.

Mrs. Otto Heeren is in Chicago.

J. Alex. Hardy leaves for the east this week.

Joseph Burkle, traveler for Heeren Bros. & Co., has gone to Erie, Pa., for a pleasure trip.

G. B. Barrett has gone to Wildwood Springs, Pa., for a brief sojourn with his family.

Steele Roberts left on Monday with a party of eighteen for a couple of weeks in Chicago.

H. H. Weylman, Kittanning, Pa.; Wm. B. Neville, Dawson, Pa., were here last week.

R. Siedle & Sons received the order from the Pittsburgh Athletic Club for the handsome gold and silver medals to be given by the club at their open meeting, Sept. 2d. This is the second large order for medals given by the club this month.

The court refused to allow any of the exceptions filed by the attorneys for the Keystone Watch Case Co., Simons, Bro. & Co. and Kenosha Watch Case Co. to the account of Frank Hartman, assignee for John O. Slemmons. The account as filed declares a dividend of 25 per cent.

## News Gleanings.

E. Baldwin, Lexington, Neb., has given a bill of sale.

Frank Reed will open a new jewelry store in Lowville, N. Y.

B. F. Stenzel, Vail, Ia., has given a chattel mortgage for \$132.

J. H. Cooper, Marshall, Tex., is advertising his store for sale.

W. L. Hollar, Humboldt, Ia., has given a chattel mortgage for \$300.

Sherborne Bros., Harvard, Neb., have given a bill of sale for \$1,400.

F. G. B. Weihe, Ocala, Fla., has given a chattel mortgage for \$1,180.

Otis Hood, North Abington, Mass., has given a chattel mortgage for \$50.

H. A. Hoyt, Sumter, S. C., has given a real estate mortgage for \$517.

W. F. Main, Iowa City, Ia., is spending a short vacation in South Dakota.

Mrs. E. G. Carter, Smethport, Pa., has given a realty mortgage for \$500.

J. W. Gish has removed from Staples, Minn., to Parkertown, same State.

L. Crawley, Buffalo, N. Y., has a judgment for \$143 entered against him.

E. M. Edgerton will open a jewelry store in the DeWolf block, Englewood, Ill.

A. C. Blackney has removed from Ipswich, S. Dak., to Rapid City, S. Dak.

Lawrence W. Folsom, Sumter, S. C., has given a real estate mortgage for \$1,000.

John Weiser, optician, San Francisco, Cal., has given a bill of sale for \$1,500.

A judgment for \$200 against Louis Bernard, Bloomsburg, Pa., has been entered.

C. D. Platt, of Platt & Harris, Los Angeles, Cal., has given a chattel mortgage for \$195.

L. A. West, recently of Manitou, Col., will open a jewelry store in Livingston, Mon.

H. Menger, of Menger, Bro. & Wagner, Baltimore, Md., has decded real estate for \$600.

Two judgments aggregating \$215 have been entered against F. P. Nuse, Buffalo, N. Y.

In a fire in Springfield, Minn., a few days ago, the store of H. O. Schlender was destroyed.

J. A. Beck, Portland, Ore., has given Laura A. Beck, a deed for a nominal consideration.

M. Chassnoff, Sioux City, Ia., has given two chattel mortgages for \$1,350 and \$750 respectively.

The jewelry store of Denney Bros., Portland, Ill., was affected by fire last week to a slight extent.

McEachron & Robson, Hoosick Falls, N. Y., have dissolved partnership, Mr. McEachron continuing the business.

J. J. Barnes, receiver for the Henderson Jewelry Co., Atlanta, Ga., is selling at auction the entire stock of the concern.

Chester Shepard, of the Shepard Mfg. Co., silverplaters, Melrose, Mass., has mortgaged real estate for \$3,500.

W. F. & W. M. Wurzburg, wholesale jewelers, Grand Rapids, Mich., have given three chattel mortgages aggregating \$8,286.

The Rockford Watch Co., Rockford, Ill., have given notice that the factory will start up again Sept. 4th with a full force.

A man named Cooper has been arrested charged with burglarizing the store of George H. Glass, Church's Ferry, N. Dak.

The Weber Jewelry Co., of Milwaukee, Wis., have incorporated with a capital stock of \$20,000. The promoters are J. Wilbert, H. R. Pestalozzi and F. J. Goermiller.

Clara Deckelman, wife of Jacob Deckelman, jeweler, 503 Ensor St., Baltimore, Md., has applied for a divorce from her husband on the ground of non-support and desertion.

The jewelry store known as the City of New York, in the City of Mexico, Mexico, was entered last Friday night and robbed of several thousand dollars worth of goods. The clerks of the store have been arrested on suspicion.

The Lovell Jewelry Co., of Racine, Wis., have incorporated with a capital stock of \$2,000 to manufacture and deal in jewelry real estate, etc. C. C. Lovell, L. M. Lovell and M. L. Lovell are the promoters of the enterprise.

Walter J. Buckley, of the Seth Thomas Clock Co., is in Uniontown, Pa., to superintend putting a big clock in the tower. The clock is exactly similar to the one the Seth Thomas people placed in the tower of the Pennsylvania building at the World's Fair.

Joslin & Park, Denver, Col., have brought suit against Joseph Solomon for \$410, the value of diamonds alleged to have been taken from their store by Albert Levy and pawned. A similar suit was instituted against Samuel Mayer, pawnbroker, for \$330 worth of diamonds pawned by Levy.

The firm of Vineberg & Shimberg, doing an optical business on River St., Troy, N. Y., was last week dissolved by mutual consent. Dr. S. J. Shimberg will continue the business at the old stand, and Dr. A. Vineberg will start in business for himself in Troy. The firm was established in April, 1892, and was a branch of the Syracuse Optical Co., Syracuse, N. Y.

Edward Ryan has sued Durward Danks, an instalment jeweler, of Rochester, N. Y., for \$1,000 damages for false imprisonment. Danks caused Ryan's arrest several weeks ago on the charge of petit larceny in stealing a ring. Ryan claimed that the ring had been purchased by him on the instalment plan, and that he had not completed the payments. He was discharged in the Police Court.

The windows of the jewelry stores of Columbus, O., are eliciting much comment

by reason of their attractive decorations. T. T. Tress shows the Brooklyn bridge covered with Waterbury watches, with boats loaded with the same sailing up through Hell Gate. Barnitz & Nuncmacher have a star window which eclipses the sun's rays in brilliancy and beauty, covered with the same watches. Aug. A. Gerlach has Old Father Time, bent with age and the weight of the Waterbury watch surmounting a monument of the same rich goods. James Savage has a beautiful monogram chanting the praises of the same goods.

## Canada and the Provinces.

Seth Nash, Barrie, Ont., has assigned to O. H. Lyon.

W. J. Crockett will open a jewelry store in Alberton, P. E. I.

The stock of L. Dupuy, Sherbrooke, Que., has been seized for rent.

The liabilities of J. H. Johnston, Grimsby, Ont., are \$800 and the assets are about \$300.

In a fire in Kingston, Ont., the jewelry store of H. A. Liffiton sustained some damage. The fire is supposed to have been of incendiary origin.

John Maynard, Bowmansville, Ont., who recently assigned, is offering 40 cents on the dollar, spread over a year. The liabilities are valued at \$1,900 and the assets at \$3,500. The latter, chiefly stock, would sell for about 50 cents on the dollar.

## Los Angeles, Cal.

J. P. Trafton has returned from a trip east.

George Jordan, San Bernardino, has left for the east.

A. O. Gott is selling out his stock of jewelry at Alameda, Cal., at auction.

In Phoenix, Ariz., recently occurred the marriage of George H. Cook, of Cook & Lee, to Miss Jean Crottiers.

The Imperial Watch Co. have opened an office in Los Angeles in rooms 29 and 30 New Wilsa Block. Very recently they opened an office at Santa Cruz in charge of T. B. Valdez. The Los Angeles office is in charge of F. O. Zeigler. The company have five offices in this State and one in Portland, Ore.

Bartlett Bros., 103 N. Spring St., have sold out their jewelry business to J. A. Campbell, who is now conducting it under the firm name of the Sunset Jewelry Co. Bartlett Bros. have had two jewelry stores, one in Los Angeles in charge of A. G. Bartlett and one in Ventura in charge of C. G. Bartlett. A music business was started in connection with the Los Angeles store which grew to such proportions that it gradually squeezed out the jewelry business, so that the sale leaves A. G. Bartlett running a music store, while the Ventura establishment is unaffected.

**CLASSIFIED INDEX TO ADVERTISEMENTS.**

All Advertisements are entitled to one insertion under proper heading. Extra insertions, \$6.00 per annum. Extra Headings, \$12.00 per annum.

	Page.
<b>Aluminum Solder.</b>	
De Redon, C., 43 W. 21st St., N. Y. ....	17
<b>Art Pottery, Bric-a-brac, Etc.</b>	
Bing, Ferdinand & Co., 106 Grand St., N. Y. ....	40
Borgfeldt, Geo. & Co., 18, 20 & 22 Washington Place, New York.....	42
Bradley & Hubbard Mfg. Co., Meriden, Conn	3
Gleanzer Leon, J. & Co., 80 & 82 Chambers St., N.Y.....	43
Haviland & Abbott, 26 Barclay St., N. Y.....	40
Hinrichs & Co., 29 & 31 Park Place, N. Y.....	33
Levy, Breyfus & Co., 9 & 11 Maiden Lane, N. Y.....	44
Straus, L. & Sons, 42 to 48 Warren St., N. Y....	15
<b>Auctioneers.</b>	
Comrie, A. J., P. O. Box 2403, New York.....	17
Firuski, S. & Son, 85 Bowery, N. Y.....	37
French, J. H., P. O. Box 2775, New York.....	5
<b>Assayers &amp; Refiners.</b>	
Clark, J. L., Philadelphia, Pa.....	28
Howard, S. P., 8 John St., N. Y.....	44
<b>Badges, Medals, Etc.</b>	
Irons & Russell, Providence, R. I.....	25
Schlechter, G. A., Reading, Pa.....	3
Stockwell, E. R., 19 John St., N. Y.....	4
Wilson, Chas. G., Reading, Pa.....	17
<b>Chains, Seamless.</b>	
Kent & Stanley Co., Providence, R. I.....	4
<b>Diamond Cutters.</b>	
Humphrey, J. B., Boston, Mass.....	17
<b>Diamond &amp; Precious Stone Importers.</b>	
Bruhl Bros. & Co., 21 Maiden Lane, N. Y.....	44
Disselkoe, John N., 19 E. 16th St., N. Y.....	37
Falkenau, Oppenheimer & Co., 40 Maiden Lane, N. Y.....	44
Hahn, Rud. C., 194 Broadway, N. Y.....	17
Hedges, Wm. S. & Co., 170 Broadway, N. Y....	36
Juergens & Andersen Co., 125, 127 State St., Chicago.....	21
Kahn, L. & M. & Co., 10 Maiden Lane, N. Y....	44
Kipling, R. A., Hays Bldg., N. Y.....	36
Kling, H. M. & Co., 11 John St., N. Y.....	44
Ludeke & Power, 23 John St., N. Y.....	36
Nissen, Ludwig & Co., 18 John St., N. Y.....	36
Randel, Baremore & Billings, 29 Maiden Lane,	37
Smith, Alfred H. & Co., 182 Broadway, N. Y....	36
Wolff & Gunzburger, 87 Nassau St. N. Y.....	44
<b>Diamond Jewelry.</b>	
Bonner, Rich & Co., 41 Maiden Lane, N. Y....	28
Wat rman & Lehman, 37 Maiden Lane, N. Y....	28
<b>Engravers &amp; Designers.</b>	
Bartholomew, W. H., 18 Spruce St., N. Y.....	3
<b>Eye Glass Holders and Chains.</b>	
Merritt, S. F., Springfield, Mass.....	9
<b>Fine Stationery.</b>	
Parsons, Green & Co., 18 Murray St., N. Y....	5
<b>Fountain Pens.</b>	
The Boston Pen Co., Boston, Mass.....	33

	Page.
<b>Cleaning Solution.</b>	
Quarters, W. F., Providence, R. I.....	7
<b>Gold and Silver Plating.</b>	
Brunor Plating and Jewelry Repairing Co....	5
Maiden Lane, N. Y.....	5
<b>Gold Jewelry.</b>	
Bippart & Co., Newark, N. J.....	7
Carter, Sloan & Co., 15 Maiden Lane, N. Y....	37
Hook, G. W., Chicago, Ill.....	24
Krementz & Co., 182 Broadway, N. Y.....	3
Racine Jewelry Mfg. Co., Racine, Wis.....	24
Smith, C. Sydney, 191 Broadway, N. Y.....	17
Street, Geo. O. & Sons, 15 John St., N. Y.....	3
Uhry, Chas. L. & Co., Newark, N. J.....	17
<b>Horological Schools.</b>	
Parson's School for Watchmakers, Peoria, Ill.	25
<b>Hotels.</b>	
Gibson House, Cincinnati, O.....	25
<b>Imported Clocks, Bronzes, Etc.</b>	
Jacques, Chas., Clock Co., 22 Cortlandt St., N. Y.	44
<b>Jewelry Mailing Boxes.</b>	
Am. Railway Supply Co., 24 Park Place, N. Y....	4
<b>Jewelry, Silverware and Optical Cases.</b>	
Birmingham, Wm. & Co., 728 Arch St., Phila.?	17
Jackson, S. C., 180 Broadway.....	16
Troesch, A. & Co., 69 Nassau St., N. Y.....	36
Wiggers & Froelick, 60 Nassau St., N. Y.....	36
<b>Jobbers, Watches, Diamonds, Etc.</b>	
Aikin-Lambert Jewelry Co., 19 Maiden Lane..	10
Bowman, Ezra F. & Co., Lancaster, Pa.....	27
Cross & Beguelin, 17 Maiden Lane, N. Y.....	10
Bonnet, Albert H., Columbus, O.....	20
Giles Bros. & Co., W. H. Gleason, receiver, Chicago, Ill.....	24
Lapp & Flershem, Chicago, Ill.....	22
Myers, S. F. & Co., 48 Maiden Lane, N. Y....	44
Yates, John B., Hays Building, Maiden Lane, N. Y.....	28
<b>Musical Boxes.</b>	
Jacot & Son, 298 Broadway, N. Y.....	7
Wolff, A., 194 Broadway, N. Y.....	3
<b>Optical Goods.</b>	
Laurencot, Jules, 49 Maiden Lane, N. Y.....	40
Queen & Co., Philadelphia, Pa.....	4
Spencer Optical Co., 15 Maiden Lane, N. Y....	10
The Nous Verrons Co., Boston, Mass.....	17
Zineman, M. & Bro., Philadelphia, Pa.....	28
<b>Pens, Pencil Cases, Etc.</b>	
Aikin, Lambert & Co., 19 Maiden Lane, N. Y....	4
<b>Patents.</b>	
Cox & Sons, 11 Park Row, N. Y.....	33
<b>Ring Makers.</b>	
Bowden, J. B. & Co., 192 Broadway, N. Y....	7
Hildreth Mfg. Co., 51 Maiden Lane, N. Y....	3
<b>Sample Trunks.</b>	
Crouch & Fitzgerald, 161 Broadway, N. Y....	38

	Page.
<b>Settings and Galleries.</b>	
Blancard & Co., 36 John St., N. Y.....	27
<b>Show Cases.</b>	
Smith, B. & W. B., 220 W. 29th St., N. Y.....	44
<b>Silver Mounted Ebony Goods.</b>	
Provenzano, J. N., 39 Union Square, N. Y.....	12
<b>Silver Plated Ware.</b>	
Homan & Co., Cincinnati, O.....	18
Pairpoint Mfg. Co., New Bedford, Mass.....	5
Rogers & Bro., 16 Courtlandt St., N. Y.....	2
<b>Silversmith.</b>	
Rohrbach, Henry J., 94-96 State St., Chicago.	25
<b>Sterling Silverware.</b>	
Campbell-Metcalf Silver Co., Providence, R. I.	26
Dirksen Silver Filigree Co., Freeport, Ill....	20
Knowles, J. B. & S. M., Co., Silversmiths' Hall, Union Square, N. Y.....	7
Ovatt & Warner, Portland, Oregon.....	24
Reed & Barton, 37 Union Sq., N. Y.....	27
Shiebler, Geo. W., Co., 179 Broadway, N. Y....	8
Towle Mfg. Co., Newburyport, Mass.....	23
Wallace, R. & Sons Mfg. Co., 3 Park Place, N. Y.....	6
Wood & Hughes, 10 John St., N. Y.....	30
<b>Tool Manufacturers and Dealers.</b>	
Bullock, O. W., Springfield, Mass.....	7
Chicago Watch Tool Co., Chicago, Ill.....	25
Gesswein, F. W., 39 John St., N. Y.....	40
Mosely & Co., Elgin, Ill.....	25
<b>Tortoise Shell Goods.</b>	
Rice & Hochster, 483 & 485 Broadway, N. Y....	38
<b>Trunks and Traveling Bags.</b>	
Crouch & Fitzgerald, 161 Broadway, N. Y....	38
<b>Watch Case Manufacturers.</b>	
Goll, Henry, 17 John St., N. Y.....	40
Margot Bros., Boston, Mass.....	16
The Planchamp & Becker Co., Chicago, Ill....	24
The Wadsworth Watch Case Co.....	26
<b>Watch and Clock Dials.</b>	
Waltham Dial Co., Waltham, Mass.....	3
<b>Watchman's Clocks.</b>	
Hausburg, O. E., 41 Maiden Lane, N. Y.....	33
<b>Watch Importers.</b>	
Hyde's, J. E., Sons., 22 Maiden Lane, N. Y....	3
Mathey Bros. & Mathez Co., 21 & 23 Maiden Lane, N. Y.....	3
<b>Watch Keys.</b>	
Clark, A. N., Plainville, Conn.....	38
<b>Watch Manufacturers.</b>	
Baume & Co., London, England, and Syracuse, N. Y.....	14
Durrstein & Co., World's Fair, Chicago.....	22



## Special Notices.

Rates 75c. per insertion for notices not exceeding 3 lines (25 words), additional words 2 cents each. If answers are to be forwarded, postage stamps must be enclosed. Two insertions, 15 per cent. off; three insertions, 20 per cent. off; four insertions or more, 25 per cent. off. Payable strictly in advance. Display cards on this page will be charged at \$2.00 per inch for first insertion, subject to same discount as above for subsequent insertions.

Under the heading of **Situations Wanted** on this page advertisements will be inserted for **One Cent a Word**. This offer refers to **Situations Wanted only**. Payable strictly in advance. If answers are to be forwarded, postage must be enclosed.

## Situations Wanted.

Notices under this heading **ONLY** are charged at one cent a word, payable strictly in advance. If answer are to be forwarded, postage must be enclosed.

**POSITION** as salesman, retail jewelry or silver ware. Experienced. References. Address, "F," care, JEWELERS' CIRCULAR.

**SITUATION WANTED.**—An experienced traveler wishes a position in a first-class house. Many years on the road and well acquainted in all sections east of Omaha. Diamond house preferred. Address E. D., JEWELERS' CIRCULAR.

**WANTED**—By a young man 22 years of age, a position to represent a manufacturing jeweler or precious stone house in the city or on the road, or position in office. Reference unquestioned. Long experience in the business. Address, H., care of JEWELERS' CIRCULAR.

**POSITION** wanted by young Swede as watchmaker and clock repairer; three years' experience; speaks English; own tools; best references. Address Mechanicsville, N. Y., Lock Drawer No. 6.

**SITUATION** Wanted—Watchmaker and Optician, experienced, wants a position about Oct. 10th. Am considered a good man. Address G. B., 72 Fount Avenue, Delaware, O.

**SITUATION** Wanted—First-class Watchmaker, 30 years of age, desires permanent situation, Indiana or Illinois, after Sept. 13th. References exchanged. Address Mitchell, care of JEWELERS' CIRCULAR.

**SITUATION** wanted by an all round workman on watches, clocks and jewelry; am fair engraver, best of references. Address Ed. Brandou, Le Mars, Iowa.

**WATCHMAKER**, 17 years experience, sober industrious, good recommend from present employer, wants position Sept. 1st. Address C. R. Burritt, Norwich, N. Y.

**WANTED**—Situation in New York or Brooklyn to take charge of optical department. References, etc., given by addressing A. G. W., care CIRCULAR.

**SITUATION** wanted by a watchmaker and jeweler in or near New York City. Thirty years' experience and best of references. Address W. H. D., care of JEWELERS' CIRCULAR.

**WANTED.**—Position by first-class watchmaker, clockmaker, jeweler, and repairer of musical toys, etc. Can put my hands to any kind of repairing work. Have had thirty years' experience, and can furnish best of references. Would prefer position in New York City or nearby town. Address D. H. Jacquard, Westwood, N. J.

**SITUATION WANTED.**—By young man to finish trade. Two and a half years' experience; good references. Address Box 24, Denison, Iowa.

**STEADY MAN** wants position as first-class lapper and polisher; fourteen years' experience; understands every branch of the business; best references given. Write to W. E. Smith, 2137 Third Ave., New York.

**WANTED**—Position to represent good jewelry or silver house in Chicago or California by experienced traveling man; best of references. Address J. A. Limbach, 9 Lakeside Building, Chicago.

**SITUATION** Wanted—By a young man as improver; three years' experience at watch, clock and jewelry repairing. Age twenty, best of references. Address, C. W. Parsons, Menominee, Mich.

**POSITION WANTED.**—By a young lady experienced in etching, lettering and drawing for a silver factory. References given. Address Box 74, N. Attleboro, Mass.

**SITUATION WANTED** by an all-around workman on watches, clocks and jewelry. New York, Pennsylvania or Ohio preferred; best references; own tools. G. H. Wilkinson, Medina, N. Y.

**SITUATION** wanted as watchmaker and plain engraver by young man, twenty-years of age. Good set of tools and references. Speaks German and English. Address A. A. M., care JEWELERS' CIRCULAR.

**BY** young man, age 22 years. Five years' experience as watchmaker, clock repairer and engraver; do some optical work and wait on trade. Speak German and strictly temperate. Address, Arthur W. Miller, Monroe, Wis.

**WANTED.**—To represent in Chicago, an eastern manufacturer. Have been fifteen years in jewelry business. Am well acquainted with eastern trade. Address Geo. A. Karr, care O. W. Wallis & Co., 103 State St., Chicago, Ill.

## Help Wanted.

**WANTED**—Experienced traveling salesman to carry a leading and well-known line of spectacles and eye-glasses; samples easily carried; liberal commission. Address Optics, care JEWELERS' CIRCULAR.

**WATCHMAKER WANTED**—One that can engrave preferred. Must be quick and good. Wages \$12. E. C. Kern, 448 Bloomfield Ave., Montclair, N. J.

**WANTED**—jeweler and engraver, or good all-round man. Address W. E. Avery, Columbia, S. C.

## For Sale.

**FOR SALE.**—Safe. Choice of three. For cash or right kind of gold jewelry. Apply to T. B. Bynner, 177 Broadway, New York.

**FOR SALE.**—\$500 for \$300 cash. Jewelry, News Depot and furnished rooms for two. Rent \$8. Store pays profit; bench work for one. Address Cyrus Condit, 2344 Belleview Avenue, Kansas City, Mo.

**FOR SALE**—A Rare Chance. A recently established jobbing, cutlery and silver plated ware business, with New England agencies, is offered for sale. Present proprietor's engagements prevent his devoting the necessary time to the business. A live, pushing man will find this an opportunity seldom offered. Buyer can have immediate possession. Offer must be in cash or well secured paper. Address Jobbing Business, care of JEWELERS' CIRCULAR.

**FOR SALE.**—At Cleveland, O., a watch and jewelry business. Wishing to retire, on account of failing health, I am obliged to sell my business; a good opportunity to purchase a business established over 25 years; central location; clean stock; plenty work; stock and fixtures invoice about \$3,000; terms cash. Address R., Lock Box 89, Cleveland, O.

## Miscellaneous.

**I BUY JEWELRY STOCKS**—Manufacturers, jobbers and retailers desiring to dispose of surplus or entire stocks of diamonds, watches and jewelry can find quick cash buyer by addressing Stephen S. Harmon, 134 East 96th St., New York city.

**WANTED**—To purchase, Jeweler's Stock; include if possible, Burglar Proof Safe; Regulator, lathe, tools, Street clock, material, trial lenses; five to eight thousand. H. Bramer, Attica, N. Y.

**TO MANUFACTURERS**—Wanted, an agency in Philadelphia for jewelry, watches or diamonds, by a person well known to the trade, in Philadelphia, Baltimore and Washington, D. C. Commission if desired. Address D. H. C., JEWELERS' CIRCULAR.

## DEMAGNETIZING.

**PERFECT WORK**—Watch repairing in all its branches; all work warranted. Winslow & Penney, 608 Masonic Temple, Chicago.

## To Let.

**TO LEASE**—A Game Preserve in the Adirondacks. Plenty of Deer and Trout. Address Chas. Heaton, Jeweler, Potsdam, N. Y.

**TO LET**—Fine front office in Knapp Building; apply to Isidor Elbe, 41 Maiden Lane, Room 17.

**TO LET**—Large well-lighted floor, with steam power, in Twenty-Sixth Ward, Brooklyn, suitable for jewelry manufacturer or kindred trades. Rent moderate. Address T. E. H., care of JEWELERS' CIRCULAR.

**Headquarters**  
FOR  
**ELECTRIC & PORTABLE**  
**Watchman's Clocks**

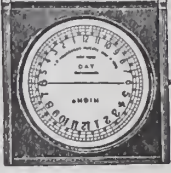

Lowest Prices.  
Latest Improvements,  
Patents 1888-1893.  
Send for Circular.  
**E. O. HAUSBURG,**  
41 Maiden Lane, New York. THE "ALERT."

Price, Complete \$10.00

**SOLICITORS OF**  
**AMERICAN & FOREIGN**  
**PATENTS**

FOR  
DESIGNS  
INVENTIONS  
&  
TRADE MARKS

SEARCHES  
MADE &  
INFRINGEMENT  
PROSECUTED  
OR  
DEFENDED

THE  
TRADE WILL  
BE HAVING THEIR  
PATENTS TAKEN BY

SAVE TIME AND MONEY

**COX & SONS 11 PARK ROW, N.Y.**

## PAWNBROKERS' SALES

BY

## S. FIRUSKI & SON,

AUCTIONEERS,

85 Bowery, New York,

AT 11 A. M.

See N. Y. Herald for full particulars of Sales.

The Trade is Respectfully Solicited to Attend.

No jeweler or watch repairer should be without a copy of "WORKSHOP NOTES," a new and very useful book for the workshop. Send for circular containing a complete index of the book, and judge of its merits for yourself.

**IF** YOU WANT A POSITION  
YOU NEED A SALESMAN  
YOU NEED A WORKMAN  
YOU DESIRE TO EXCHANGE  
YOU WANT A PARTNER  
YOU WISH TO SELL OUT  
YOU HAVE TOOLS TO SELL  
YOU HAVE A PLACE TO LET  
YOU WANT ANYTHING

USE THE

## SPECIAL NOTICE PAGE

OF THE

# JEWELERS' CIRCULAR,

Published Every Wednesday.

The Latest Patents.

ISSUE OF AUGUST 8, 1893.

**502,782. FRAME FOR SPECTACLES.** JOHN S. SPENCER, New York, N. Y.—Filed June 18, 1892. Serial No. 437,173. (No model.)

The frame F composed of the independent upper and lower sections G H, grooved on their facing edges

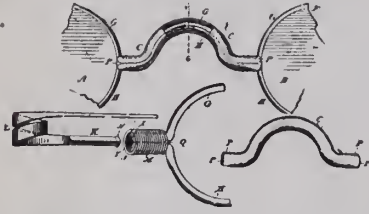

and at their outer portions inclosing the lenses, combined with the tubular nose piece C encircling the upper and lower sections throughout their length between the lens inclosing portions to cover the joint between the two sections.

**502,801. EAR-RING.** JULIUS WODISKA, New York, N. Y. Filed May 7, 1891. Serial No. 391,916. (No model.)

In an ear-ring the main continuous wire A and catch



E, combined with the post D which is adapted to traverse the loop formed by the continuous wire A.

**502,811. ELECTRIC ALARM CLOCK.** WILLIAM H. DEANE, Brooklyn, N. Y. Filed Dec. 15, 1892. Serial No. 455,214. (No model.)

The combination with an alarm clock of a rod, a weight adapted to slide over said rod, a projection

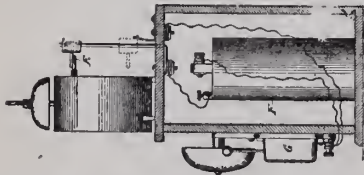

upon said weight adapted to be supported by an extension of the winding arbor of the alarm mechanism, and an electric circuit including an electric generator and bell adapted to be closed by the weight when it descends.

**502,831. SLEEVE OR COLLAR BUTTON.** THOMAS W. F. SMITEN, Brooklyn, N. Y. Filed Nov. 16, 1892. Serial No. 452,114. (No model.)

A sleeve or collar button adapted to be inserted and removed from the garment at will, having an oblong



and concave back plate and a post, the lower portion of which post conforms throughout the extent of the bottom of the post, both to the transverse and to the longitudinal shape of the back plate, the post and the back plate being rigidly attached together.

**502,852. BOUTONNIERE.** HENRY W. FISHEL, New York, N. Y. Filed May 10, 1893. Serial No. 473,669. (No specimens.)

**502,853. BOUTONNIERE.** HENRY W. FISHEL, New York, N. Y. Filed May 10, 1893. Serial No. 473,670. (No specimens.)

**502,851. BOUTONNIERE.** HENRY W. FISHEL, New York, N. Y. Filed May 26, 1893. Serial No. 475,584. (No specimens.)

**502,855. BOUTONNIERE.** HENRY W. FISHEL, New York, N. Y. Filed May 26, 1893. Serial No. 475,585. (No specimens.)

**502,917. REPEATING MECHANISM FOR TIMEPIECES.** FRED TERSTEGEN, Elizabeth, N. J. Filed May 21, 1890. Serial No. 352,654. (No model.)

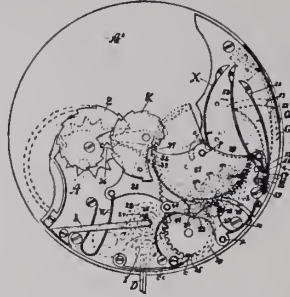

In a repeating watch, a device for releasing one or more ratchets so that they can be set to a striking position, a gear-wheel forming part of the winding mechanism provided with a projection or guide-device for actuating the said device to release one or more racks, a winding-pinion and suitable gearing for operating the said gear-wheel.

**502,918. REPEATING MECHANISM FOR TIMEPIECES.** FRED TERSTEGEN, Elizabeth, N. J. Filed June 16, 1890. Serial No. 355,671. (No model.)

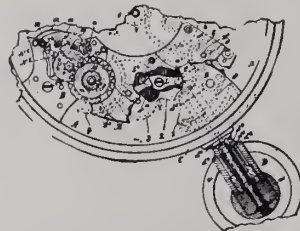

A stem-winding watch having a rotatable and longitudinally movable stem, the rotatable movement for operating a stem winding mechanism of a watch and the longitudinal movement for actuating a repeating mechanism.

**502,935. SELF-WINDING ELECTRIC CLOCK.** FREDERICK M. SCHMIDT, Brooklyn, assignor to the Self-Winding Clock Company, New York, N. Y. Filed Jan. 19, 1893. Serial No. 458,911. (No model.)

In a self winding clock the combination of the going barrel, a spring drum and an electric motor having an

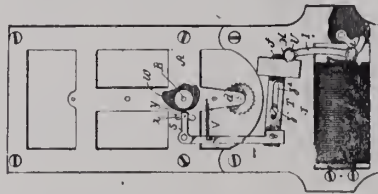

oscillating or reciprocating armature, a rotative crank connected therewith, and mechanism between said crank and said going barrel for turning the latter by the former.

**502,879. EYEGLASSES.** WILLIAM H. ECCLESTON, Southbridge, Mass.—Filed Jan. 21, 1893. Serial No. 459,037. (No model.)

In an eyeglass, the combination with the frame, and a nose guard, adjustably connected at its upper end to

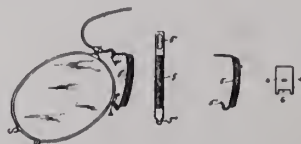

said frame, of means for securing the lower end of the nose-guard to the frame, consisting of a bracket or arm secured at its inner end to the eyeglass rim, and provided at its outer end with a notched or cut out portion, into which the lower end of the nose guard extends,

and a hole therein through which the tongue on the lower end of the nose guard projects, and is bent over to rigidly attach the lower end of the nose guard to said bracket or arm.

**502,881. WATCH-WINDING DEVICE.** ISAAC GRASSET and AUGUSTE MEYLAN, Geneva, Switzerland.—Filed Oct. 4, 1892. Serial No. 447,793. (No model.) Patented in Switzerland May 28, 1892. No. 5,019.

The combination with the watch plate of a winding stem and crown, a helical spring around the stem, a



pinion with which one end of the spring is connected, a ratchet wheel and pawl for holding the stem and a bridge across the stem for holding the same in position in the watch plate.

**DESIGN 22,675. MEDAL.** EDGAR J. HAHN, St. Louis, Mo.—Filed March 30, 1893. Serial No. 468,403. Term of patent 3 1/2 years.

**DESIGN 22,676. FINGER-RING.** MAURICE L.



POWERS, New York, N. Y.—Filed June 3, 1893. Serial No. 476,522. Term of patent 3 1/2 years.

**DESIGN 22,678. SPOON.**—WILLIAM H. JAMON-BAU, Newark, N. J., assignor to B. F. NORRIS,

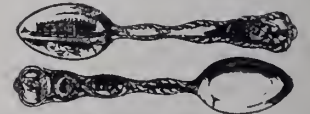

Allister & Co., Chicago, Ill.—Filed April 6, 1893. Serial No. 469,358. Term of patent 3 1/2 years.

**DESIGN 22,679. SPOON.** JUSTUS VERSCHUER,



Jersey City, N. J.—Filed May 2, 1893. Serial No. 472,791. Term of patent 3 1/2 years.

**DESIGN 22,680. FORK, &C.** SIDNEY SMITH, Bridgeport, Conn., assignor to the Holmes &



Edwards Silver Company, same place.—Filed June 26, 1893. Serial No. 478,897. Term of patent 7 years.

**DESIGN 22,681. KNIFE-HANDLE, &C.** JOSEPH



H. CROSBY, Jr., Jacksonville, Fla.—Filed July 5, 1893. Serial No. 479,658. Term of patent 7 years.

**TRADEMARK 23,170. ALARM CLOCKS. ELECTRICAL REMINDER COMPANY, Chicago, Ill.—Filed July 5, 1893.**

ELECTRICAL REMINDER.

Essential feature. The words "ELECTRICAL REMINDER." Used since July 17, 1890.

**Philadelphia.**

A new store has been opened at 1349 Passyunk Ave., by Wornington & Aston.

Samuel Cherry, 720 N. 2d St., has been making a prolonged stay at Atlantic City.

In speaking of the seven hundred employes of H. Muhr's Sons watch case factory having been put on shorter hours, Philip Muhr says: "The decreased business of the firm was very clearly due to the general depression. All classes felt its effects, and as watches are rather luxuries than absolute necessities, their sale for the while grew smaller." Mr. Muhr is not yet able to state when full time will be resumed.

**Newark.**

Louis Seeger, 392 Halsey St., has been granted an absolute decree of divorce from

his wife, Clara Durand Seeger, on statutory grounds.

Tiffany & Co.'s new cutlery factory at Rose Hill is nearing completion and will be occupied some time in October.

The firm of Rickert & Stiehle has been dissolved. Mr. Rickert retires and Mr. Stiehle continues the business. Previous to dissolution the firm gave a bill of sale for \$1,000 to Glorieux & Woolsey.

Thieves broke into the store of James M. Williams, 139 Elm St., on Thursday night, and stole about four gross of gold plated collar buttons and a dozen pairs of eyeglasses. There is no clue to the robbers.

The Alvin Mfg. Co. last week sent a solid gold spoon from one of the Columbian dies for ex-assemblyman William L. Glorieux, who has sent it to senator Jas. Smith, Jr. Only two of these gold spoons have been manufactured, the first one having been

presented to President Grover Cleveland.

**Syracuse.**

Calvin S. Ball is ill at his cottage on Round Island, St. Lawrence River.

Charles Hoskins, with H. J. Howe, was married yesterday to Laura Van Schoick.

The jewelers' mid-Summer half-holidays close with this week.

Frank D. Enney removed Monday from Vanderbilt Square to 210 Warren St., where he is very pleasantly located.

Albert M. Rich, traveling salesman for the J. R. White Jewelry Co., has been arrested, charged with stealing samples.

William Lesser and Benjamin Lesser, sons of the late Aaron Lesser, have been added to the force of A. Lesser's Sons, wholesale jewelers, which firm will soon have a corps of five travelers on the road.

**RICE & HOCHSTER'S,**

Nos. 483 & 485 BROADWAY.  
NEW YORK.

ARTISTIC DISPLAY OF TORTOISE SHELL WORK AT THE WORLD'S FAIR.

THE perfection reached by workers in tortoise shell will be amply exemplified at the World's Columbian Exposition by the display of Rice & Hochster, New York. The exhibit is in the Manufactures building, Gallery F and Pillar No. 83. The articles are displayed within a case, upon a pyramid. Surmounting this pyramid are shown the marvelous ornamental work in tortoise shell illustrated on this page, and represents an arch, upon which are groups of figures typifying agriculture, commerce, machinery, electricity, the press, iron work, chemistry, sculpture, painting

*motto palmam qui meruit ferat* (let him bear the palm who merits it).

The workmanship is as fine and perfect as

ing. In the working of the shell, the amber colored portions have been made to represent the flesh, while the brown parts, the draperies.

The exhibit contains two figures of Washington and Columbus, made of solid shell. On one panel of the pyramid are cut in relief cameos of the twenty-three presidents of the United States. Prominent also are three large combs, one foot square, representing the landing of Columbus, the four Seasons and the five Continents. A great many styles of hair ornaments and lorgnettes made from select shell are in the exhibit. Five

WRITE FOR

Selection

Packages of

Tortoise Shell

Hair Ornaments

and Lorgnettes.

Repairing of

Tortoise Shell

Goods Equal

to New.

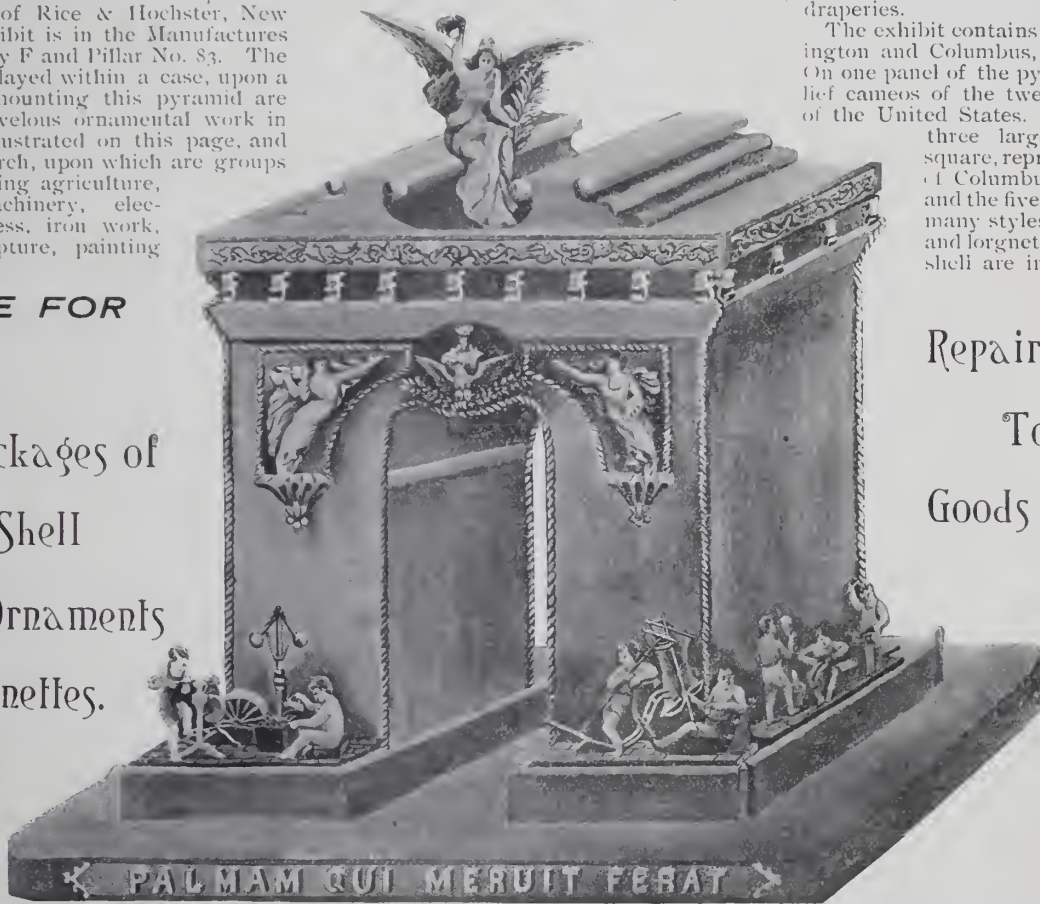

ORNAMENTAL PIECE IN TORTOISE SHELL, EMBLEMATIC OF THE TRIUMPH OF INVENTION AND ART.

and other arts. The angel which surmounts the piece is a faithful miniature of the figure which tops one of the buildings of the World's Fair. In relief, on the base, is the

the conception of the piece is artistic. In the manipulation of the miniature figures the ingenuity of the artisans has been taxed to its utmost and has not been found want-

stuffed tortoises surmount the case which is of white and gold; the letters of the name of the firm are in tortoise shell. From THE JEWELERS' CIRCULAR, May 3d, '93.

**DIAMONDS.**

**Wm. S. Hedges & Co.,**  
**Importers of Diamonds,**  
 And Manufacturers of DIAMOND JEWELRY.  
 170 Broadway, New York.  
 27 Holdorn Viaduct, London.



18 JOHN ST. NEW YORK

**R. A. KIPLING,**  
 Importer of

**PRECIOUS STONES,**  
 21 & 23 Maiden Lane,

19. RUE DROUOT. New York.  
 PARIS.

**Alfred H. Smith & Co.,**

IMPORTERS

**DIAMONDS**

AND

PRECIOUS STONES,

182 BROADWAY, COR. JOHN STREET,  
 NEW YORK.

33 Holborn Viaduct, London, E. C.

**CAMPBELL-METCALF SILVER CO.**



176 Broadway, N. Y., Room 14. 66 Stewart St., Prov., R. I.  
 Mills Bldg., San Francisco, 8th Floor, Room 1.



Patent applied for.

Victoria Novelties, many fancy shapes.  
 Celluloid Top, Sides, Bottom and Cushions.  
**A. TROESCHER & CO., 69 Nassau St., N. Y.**

**LUDEKE & POWER,**  
**IMPORTERS OF DIAMONDS**

AND OTHER PRECIOUS STONES,

ADOLPH LUDEKE,  
 CHAS. L. POWER.

23 JOHN STREET, N. Y.

**WOOD & HUGHES,**  
**STERLING SILVERWARE MANUFACTURERS**

New York Agents for the Derby Silver Co.'s  
 FINE QUADRUPLE PLATED WARE,  
 NO. 16 JOHN STREET, NEW YORK  
 206 Kearney St., San Francisco, Cal.  
 HASKELL & MUEGGE, Agents.

**WIGGERS & FROELICK,**  
 60 NASSAU ST., NEW YORK.

**Sample Cases and Trays**  
 For Watches, Jewelry, Optical Goods, Etc.

**WE STRIVE TO MAKE THE BEST.**

**Interesting Gossip from Paris.**

ROUCHERON'S NEW STORE AND SOME UNIQUE JEWELRY DISPLAYED THEREIN—NEW PIECES IN SILVER—A HANDSOME BOUQUET HOLDER.

PARIS, France, Aug. 15.—Boueheron has just left the Palais Royal and settled at the corner of the Rue de la Paix and the Place Vendôme in large premises which have been handsomely fitted. The place, which previously had a low story (*entresol*) above it, has been entirely altered. The windows, which extend almost from the ground floor up to what used to be the second floor, are arched at the top, and have a lofty appearance. The walls of the show rooms are all laid with dull oak decorated with semi-polished carvings in the Louis XIV. style, so as to match the style of the buildings, two centuries old, surrounding the Place Vendôme.

Works of art in chased silver, or gold and enamel, rest on graceful little tables of carved oak placed here and there about the room. Other tables, near the windows, support glass cases, in which varied articles of jewelry or small specimens of goldsmith's work are exhibited. On a pedestal in the hall is a graceful little boy in silver with his left knee resting on a tree stump. Among the jewelry and silverware are many old acquaintances, the most striking of the new pieces have been sent to the World's Fair. However, there are several handsome diadems, necklaces, bracelets, etc., consisting of floral or fanciful designs, well worthy of admiration. A remarkable diadem consists of a tuft of diamond feathers, curled and arranged like those worn by knights on their helmets; there is an almond shaped sapphire at the base of each feather. The band of the diadem shows a succession of large diamonds and sapphires divided by slanting gold motifs. This piece can be separated so that the tuft of feathers may be worn alone at the corsage; the band being divided, forms two bracelets.

An elegant *porte-bouquet* has the shape of a Hispano-Moorish vase, with two flat handles displayed like wings. The base of the vase stretches all round so as to form a large shallow basin. The whole piece is in oxidized silver inlaid with pale gold forming faint lines crossing and recrossing bright enameled lines. Very fine and elaborate pierced work completes the effect produced by these pretty arabesques.

Several original pieces have been produced in the silver line. A curious fruit dish consists of a plain shaped tray, like a large and shallow cup, held by two country girls, one on each side. These figures are perfectly modeled and true to life; they stand on a roughly chased ground.

A bouquet holder in silver has the shape of a gourd resting slantingly on an uneven ground over which spread the bent stalk and leaves. A human being crouching underneath the gourd grasps it with a feverish thirst, while another climbs over it, both emulating to reach the mouth of the gourd.

JASEUR.

**Fashions in Jewelry and Silver-Ware.**

A LADY'S RAMBLES AMONG THE JEWELERS.

A summerlike substitution for perforated work is seen in the use of silver wire, now especially popular.

Round ebony rulers are sumptuous. They have a silver bar on handle for their manipulation, with a beautiful perforated ornament in the center.

Large cable cord chains of silver are made for Summer gowns. These, it must be understood, are not heavy, but although large have distinctly a light effect.

Large silver bracelets are worn. They have a lunked rope effect, but are not weighty. The union of polished and dull metals is decidedly valuable in these.

Briar wood pipe have been a feature in view of vacations. They are besprinkled with tiny horse shoes, bound with cables, they display blazonry of colors in yacht flags and insignia of that sort.

There is sentiment in a heart shaped cigar set. The lamp crowns the edifice. Below is a gilt lined cavernous opening for cigars and two smaller receptacles for cigarettes with a silver bar on which to rest the lighted weed.

Large silver drapery pins are made with a view to the Summer's diversions. As there are horsey women, so there are long whips across which a saddle perfect in every detail is hung. Tennis and croquet devices also appear, but the prettiest devices are floral.

A new pocket receptacle for postage stamps has a little book of rice paper in flat silver covers. They are only long enough to hold two of the old and one of the new issues. In the back of one of the covers is a little celluloid calendar.

Claret jugs and champagne jugs are now in order. These are of cut glass silver mounted with a separate silver mounted glass bowl for ice. In England claret jugs are made with an inner glass silver mounted receptacle which fits into the mouth and holds the ice. Cut glass silver mounted salad bowls are made to match these jugs for the luncheon table. ELSIE BEE.

**Registering the Tide by Clock.**

The chamber of commerce of Rouen have erected a clock tower which gives the time on three sides and the height of the tide on the fourth, namely that fronting on the harbor. The tide indicator consists essentially of a float which by means of a cord and counter weight hung on a drum, actuates a series of shafts with bevel wheel gearing and moves a hand or pointer on a dial like that of a clock, marked with the necessary figures to show the level of the tide.

The dials are of opal glass and are illuminated at night. The clock has an apparatus for distributing the time to other clocks in Rouen and also for unifying the time, after the method adopted in Paris.

ESTABLISHED 50 YEARS.

LANDEL, BAREMORE & BILLINGS,

IMPORTERS OF

DIAMONDS,

AND OTHER PRECIOUS STONES.

FINE PEARLS A SPECIALTY.

MANUFACTURERS OF

DIAMOND JEWELRY,

IN THE LATEST DESIGNS.

Diamonds Recut in Modern Styles or Repaired on Premises.

58 Nassau Street,  
29 Maiden Lane  
NEW YORK.

1 Tulp Straat,  
AMSTERDAM.

1 St. Andrews St.,  
Holborn Circus,  
LONDON, E. C.



TRADE MARK

ESTABLISHED 1841.

CARTER, SLOAN & CO.,

MANUFACTURERS OF GOLD JEWELRY,

No 15 MAIDEN LANE,

NEW YORK.

A. CARTER, JR.  
A. K. SLOAN.  
C. E. HASTINGS.

GEO. R. HOWE.  
WM. T. CARTER.  
WM. T. GOUGH.

FACTORY, NEWARK, N. J.



JOHN N. DISSELKOEN,  
Cutter and Importer of  
DIAMONDS

FACTORY.  
76 LANGBLEEKERSPAD,  
AMSTERDAM.

19 East 16th St.,  
NEW YORK.

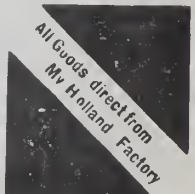

**The Watch.**

THE following is quoted from a lecture by R. Felsz: When the verge escapement was invented toward the end of the 10th century, not even the wisest head had any idea of the pendulum—for an extremely simple reason: it had not yet been invented. Fully five centuries had to elapse before the time-measuring properties of the oscillating rod became known, and another century passed before the endeavor of uniting this simple apparatus with the

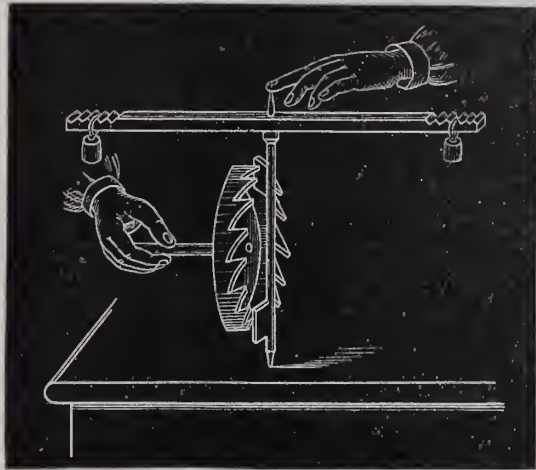

clockwork was successful. Intelligent heads recognized the necessity of a regulator, in order to divide the motions of the verge into definite parts of time. The first essay was a kind of double balance mounted upon the verge in the manner as I do now. To this were suspended small weights for adjusting the clock to time.

Gradually these adjusting arms were made in different shapes, at first, perhaps, for simply decorative reasons—for instance, the Z shape, from which most probably emanated our present circular balance. The adjustment of clocks by means of a balance is consequently far older than that by pendulum.

The invention of the balance spring, also, is older, and one that has cost scientific men any amount of study. The circumstance was well recognized that balances still required a certain support in their motion, partly in order to make this more regular, partly (especially in portable watches) to insure the return excursion, all of which could

be secured by a little spring fastened to the balance. But the only correct shape of this spring, to wit, its spiral shape, did not suggest itself at first, but experimenters vainly tried every other shape—straight, bent, twisted, serpentine, etc.—and at the same time using all manner of material; for instance, very old watches have—a hog bristle! And this novelty was the invention of one of the foremost mechanicians of his time, the Abbé Hautefeuille.

The balance with the balance spring was known for a long time previous, because about 1500 Peter Henlein manufactured the first portable verge watch and about 1550 the well known Nuremberg eggs were manufactured in large quantities; but only as late as 1657 the celebrated mathematician, Huyghens (a Dutchman) was successful in introducing the pendulum to the verge escapement. It is true that Galileo invented not only the pendulum, but also the laws governing it; he was not successful, however, in uniting it with the clock escapement. His son, Vincenzo, states that his father when a young student, one day attended divine worship in the beautiful dome at Pisa, but was not very devout in his prayers, and while

his lips pronounced the formula, his eyes followed the oscillation of a lamp suspended at great height from the ceiling, and moved by wind. This observation gave rise to the pendulum.

When finally Huyghens had "married" (the lecturer happily says) the pendulum with the verge 100 years afterward, he was compelled to recognize that the union was not a happy one, because Mrs. Verge was a very lively lady, while Mr. Pendulum was very sedate. It is true as long as he was small and light, it stood under the influence of his partner, but she soon found out that the long and heavy fellow had no inclination for light tripping and dancing to suit her whims and she was compelled to suit her fancy to his moroseness. And this is the saving clause of the clock movement; the small pendulum is influenced by the incorrectness of the train, and therefore unrelia-

ble; but the large one is not controlled by these shortcomings, but corrects those of the train, and for this reason it gives us the measurement of time with a wonderful precision.

**A Balance Spring Gauge.**

BY CLAUDIUS SAUNIER.

A back view and side elevation of the device above mentioned are shown in the accompanying cut; it can be made without difficulty by any watchmaker. Through the middle of the plate passes a staff *ab* lightly pivoted between the cock *p* and the plate, and projecting on the left-hand side as far as the point *a*. Between the cock and plate it carries the collet of the spiral spring *s* and the stop finger *dc*, and at the point *s* is a light finger *yz* that passes over the graduations on the dial.

When the stop-finger *dc* is free it stands in the direction of the dotted line *i*; on rotating the staff, by taking hold of the pivot *a*, in the direction of the arrow *z*, the extremity *c* of the finger will be brought round till it presses against the inclined plane *r*, which it will force back and, on coming against the stop near *c*, it will be held fast in the notch of the small bent lever that terminates at *r*. A spring maintains this lever

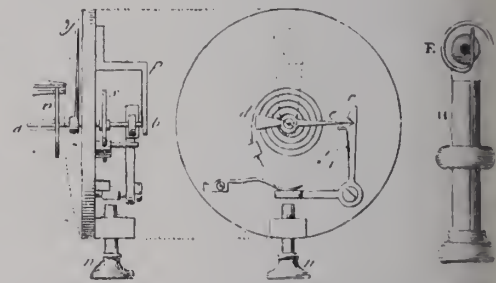

always against a pin set in the plate. The index finger *yz* will now be standing over the zero of the scale, and will be maintained in that position until the finger *dc* is released by a momentary pressure of the hand on the push piece *u*, when it will fly back to the initial position corresponding to the dotted line *i*. The instrument is used as follows:—

The small sliding holder *II* to which is

**CROUCH & FITZGERALD.**

Jewelry Trunks and Cases.

161 Broadway

Bet. Cortlandt and Liberty Sts.,

688 B'way,

701 6th Ave.,

NEW YORK



Sold by all wholesale dealers at manufacturer's price.

**A. N. CLARK,**  
PLAINVILLE,  
CONN.

Manufacturer of the Celebrated  
**LOOP WATCH KEY.**

The Best for the Price in the World.  
CROSBY'S JEWELING TOOLS IMPROVED.

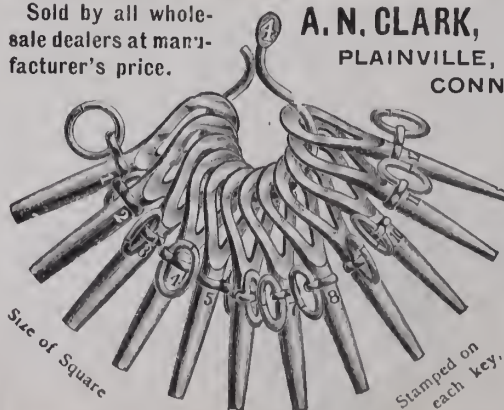

Size of Square

Stamped on each key.

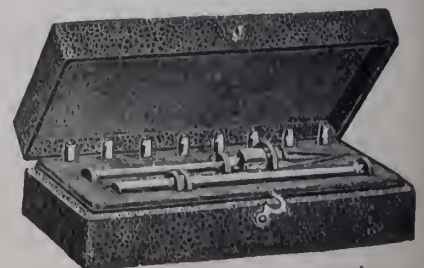

Will quote royalty or price for the manufacturing of articles of real worth.

shown in section at E (both of these figures being much enlarged since it is extremely fine and light), has a hole through its center that fits into the axis at *a*. Having set a balance spring in the clip as indicated at E, place *ll* on the pivot *a*, tightening the slide so that it can be used to rotate *a b* and bring the stop-finger round to the position *d c*. Holding the outer coil of the spring in tweezers at *v*, its inner coil being held in the clip, release the bent arm by means of the push piece *n*. The point on the dial at which the finger *y z* is arrested will give a measure of the force of the balance spring *v*.

It will be evident that a spring can now be easily selected of the same strength as *v*, or stronger or weaker within definite limits which will become well known when some use has been made of the instrument. The entire mechanism is inclosed within a box covered by a glass, through the middle of which a hole is made for the passage of *a*. The spring *s* is of about the strength ordinarily used for 18-line watches.

**Workshop Notes.**

**De-Silvering Fluid.**—The following fluid will dissolve silver (without attacking copper, brass or German silver) from silver-plated objects and ware. It is a mixture of one part nitric acid with six parts sulphuric acid, heated in a bath to 160° F., at which temperature it works best.

**Washing Clock Movements.**—In washing a clock movement, a tolerably stiff brush should be used; and in washing the plates, if care is used in manipulating the brush, very little if any pegging out of pivot holes will be needed. Of course, any and all repairs must be done previous to the washing. The use of benzine for clock cleaning, except for removing gummy oil from the main-spring, is of questionable service I believe. Let any person give warm water and soap and benzine both a fair, square trial, and there will be but one verdict, and that will be for the soap and water.

**Poising the Balance.**—If a balance be poised as perfectly as possible, and the spring mounted without curb pins, and the watch shows pendant right 4 sec. + and pendant left 6 sec.—, it can be known whether the fault lies in the balance or its pivots, by turning the rollers and the balance spring exactly half way around on the staff, and if the differences remain the same, it will be proof that the error is not due to either the balance or its pivots. If also it is necessary to prove that the fault is due to an out-of-poise balance spring, turn the spring half way round on the staff, and fasten the stud on the outer side of the cock. The error will at once be reversed, showing how pendant right 6 sec.— and pendant left 4 sec. +. These are a few out of the many experiments made many years ago to prove my theory, and which led me to the conclusion that with a perfectly poised spring, a well conditioned anchor or chronometer escapement would show the exact same rate in the four vertical positions.

**Correspondence.**

Anonymous communications will not receive any consideration whatever. A correspondent may employ a *nom de plume*, but must furnish his real name as an evidence of good faith.

DOES NOT BELIEVE IN PERPETUAL MOTION.  
BOUND BROOK, N. J., July 24, 1893.

Editor of THE JEWELERS' CIRCULAR:—No. 22 of your publication contained an item under the heading, "Perpetual Motion at Last," to which I take decided objections. First, the "perpetual motion" business was played out, let us hope, with the Keely motor. You say, "the inventor has been studying the subject for the past twenty-five years." Studying what? If he has been studying it very hard, he found out that no "perpetual motion" exists beyond that covered by letters patent granted to Mrs. Nature, and she does it by attraction and repulsion in the solar system. When we humans, however, attempt to devise such a thing, we must make use of wheels and pinions, and that means friction, which means consumption of power.

It is ridiculous, in this the end of the nineteenth century, to assert that a man can by studying, no matter how hard, for a number of years, devise a piece of machinery productive of power greater than itself. It smacks of the Baron von Munchausen assertion that he pulled himself by his hair out of the mire. Again you say, "No description of the machine can be given, as the owner allows no one to view it," in which he is perfectly right; I wouldn't either. The next assertion is that the thing is "founded on the principle of the clock, the lever." Now what is there in the clock or the lever? I, the owner of a clock store, by my superior force, a force superior to that doled out again by the spring to the escapement or pendulum in order to overcome the friction of the pivots, pinions, wheels; or by winding up the weights, I impart to the clock a power superior to that required actually keeping it in motion, but which is superior simply for the purpose of overcoming above said friction. The greater the number of wheels, pinions, pivots, depths, etc., the greater must be the force to overcome the friction of these parts and the greater the consumption of power. Now do the laws of physics fail to inform me what great secret power the lever, simple or compound, possesses? The force of the lever depends upon the spot where the fulcrum is placed. But if the weight at the long end is not superior to that to be moved, no legerdemain can pronounce an incantation and move it in spite of natural laws and in spite of the exclamation of Archimedes: "Give me a lever long enough and I'll move the world."

The assertion that certain parties are trying to get hold of it, I readily believe. The Keely motor was a demonstration, if one is needed, that there is a certain class that never dies, you know. I'll not mention green-goods dealers, mountebanks and others of the same ilk.

DOUBTER.

**BUNCO MAN WORKETH THE CHESTNUT SCHEME.**



1. BUNCO STEERER—My dear sir, if you can make an accurate count of the swings of that pendulum for three hours, your fortune's made and you're the only man living that can accomplish the feat. Why I'll bet a thousand dollars it can't be done.



2. BUNCO STEERER—I mean exactly what I say, farmer. Meanwhile, I'll take a stroll.



3. BUNCO STEERER—It'll take some lively hustling, but I guess I can make a scoop of all the truck worth having.



4. SNODGRASS—Hooray! Won the bet, by thunder! I knowed I could do it slick as a whistle, and I'm the only man on record has done it.—*Godley's Magazine.*

# FERDINAND BING & Co.,

106 GRAND ST., N. Y.

SPECIALTIES IN IMPORTED CLOCKS,

MARBLE STATUARY AND BRIC-A-BRAC

FOR THE JEWELRY TRADE.

ENAMELED AND TRANSPARENT SPOONS FROM ALL PARTS OF THE WORLD

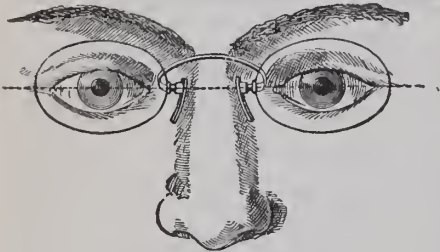

Patented Feb. 9, 1892.

THE W. B. & E.

Marvel Tilting Spring Eyeglass in Gold, Steel, and Frameless.

JULES LAURENCOT & CO.,

49 MAIDEN LANE, NEW YORK.

Sole Agents in the United States and Canada.

HENRY GOLL & CO..

17 JOHN ST., NEW YORK.

SOMETHING ABSOLUTELY NEW IN CERAMICS, FURNACE FIRE COLORS.

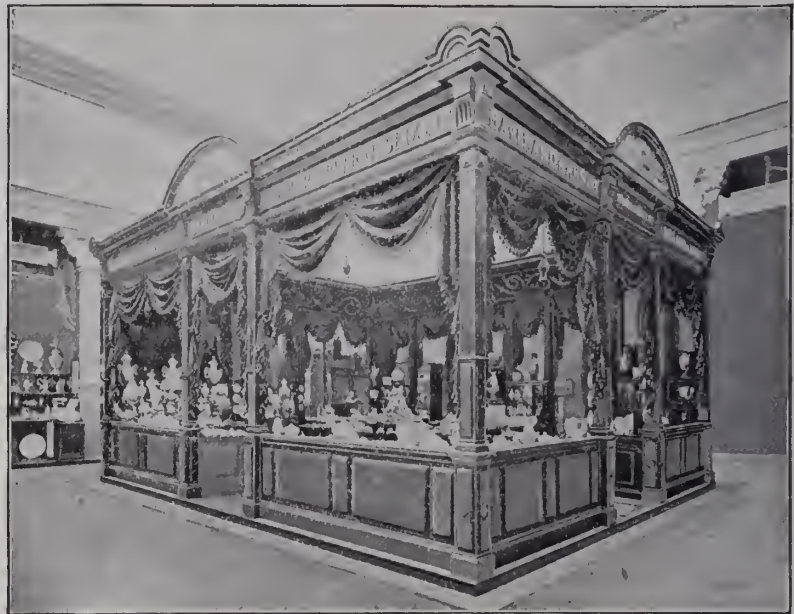

THE EXHIBIT of THE at WORLD'S FAIR, Chicago.

CH. FIELD HAVILAND  
LIMOGES CHINA.

FABRIQUE FONDEE EN 1797.

E. GERARD, DUFRAISSEIX & CIE.,

SUCCESEURS:

DEPOSEE.



TRADE MARK.

WHITE WARE.



TRADE MARK.

HAVILAND & ABBOT, AGENTS FOR THE U. S.,  
29 BARCLAY STREET, NEW YORK.

## No File Equals the "GLARDON" File

is the universal verdict  
of the trade.



LARGEST ASSORTMENT IN  
THE UNITED STATES.

F. W. GESSWEIN, 39 John Street, New York.

SOLE AGENT FOR UNITED STATES AND CANADA.





THE WORLD'S FAIR EXHIBIT OF BAWO & DOTTER.

PASSING from the great bronze room in the French section of Manufactures building to the court containing those wonderful works of French ceramic art, the first exhibit to attract attention is the "Elite" china exhibit of Bawo & Dotter, 28 30, 32 Barclay St., New York. A goodly representation of the products of their factories at Limoges is here made, showing in extensive lines their well-known fine quality of French china in all articles for the table and in many new patterns. The Turgot shape comes in dinner, fish, game, tête-à-tête and oyster sets. It is a neat and attractive pattern consisting of a rococo rim with double clouded decoration, and is brightened by flowering vines with blossoms of brilliant colorings.

A dinner set of 125 pieces is shown in Marie Antoinette pattern. In this the rim of the plates is decorated with six aprons of very pale chocolate, widest at the edge and extending to a rounded point below the drop. There are festoons of gilt connecting the points of the aprons, a small gilt floral design in the center of each piece, and other tasteful gilt decorations. Berry sets, ice cream sets and tête-à-tête sets are also shown in this pattern, the first in light green, the last in bright yellow. Chocolates and coffees, cups and saucers, teas and after dinners are in Bengaline style, which is a slightly torse pattern, wide grooves running spirally from bottom to top, with single cloud decoration, solid gold handles and floral ornamentation.

The Trocadero is shown in coffee pots, chocolates, teas, coffees and salads. It is a handsome pattern with the lower half of upright pieces and the centers of plates in solid color, a deep, bright rose, overlaid with a narrow band each of pink, white, pale green and gold. The upper parts of standing pieces and the rims of plates have panels of pink and lavender bearing odd gilt representations of bird life. The pattern is an oddity which breaks away from conventionalism and is quite an attractive addition to decorative effects.

A very pretty shape is the Russia, shown in cups and saucers, teas and chocolates. The pattern narrows just above the center

and then flares slightly outward, with a double cloud effect. In color the articles shown are a melted blue. A rare pattern, the Odette, is in teas, chocolates, after dinners and tête-à-tête sets on china trays. Handsome fish sets are shown in Turgot and Watteau shapes. The latter pattern is also shown in a game set and is pretty and effective, with a deep gilt perforated rim. The artistic excellence of workmanship shown in the representations of fish and bird life is remarkable in all these pieces.

About the walls are decorated plates in a wide range of patterns and decorations. The centre of the north wall is given to a Watteau fish set, which is flanked on either side by plaques in velvet mats. Gilt framed single plates are shown nearby with raised ornamentation of bird and fish life, each valued at \$40. Around the court on counters with wine colored felt covering, are shown the various beautiful wares of which the above described are but a small part. The factory and its products are well named, "Elite," referring to the quality and not to shapes. In the cities of greatest culture these wares have obtained a foothold not excelled by any French factory producing china, and they well deserve the meed of praise they have won. But a few of the many patterns shown have been mentioned, but those described will serve the purpose of calling attention to the high grade of designing in these wares. The Elite is also sold in all shapes in white china for decoration, this white line being the largest in America.

At the right and left of the main entrance to the exhibit are two remarkable vases four feet in height, the pair requiring an expenditure of \$4,000 by the purchaser. They have artistic bases of French gold with high lights in gilt, and a stand of white Limoges ware enriched with heavy gilt decoration. A gold cap receives the white Limoges body, which is handsomely embellished with hand paintings. The vase to the right pictures the arrival of a French marquise; that on the left a reception given by Louis XVI. The reverse of each shows a garden scene from the Tuileries. Each vase is a magnificent specimen of French ceramic art.

"Quality and price speak louder than words" is the motto on the wall of the Chicago sample room of the firm, 75-77 Lake St., where Paul Tueslein, in charge, will be pleased to show the visiting trade the largest line in the country, replete with new wares direct from Bawo & Dotter's factories in Limoges, France, and Carlsbad and Steinschoenau, Bohemia.

Antiquity of Glass.

IN the face of abundant evidence furnished by ancient writers, and the no less abundant corroborative proof supplied by existing remains, it is remarkable that the knowledge of the ancients in glass making should have been so long and so generally disputed. This popular error must now be considered as dispelled, for we have before our eyes examples which prove that modern science has added comparatively little to what was practised in this useful and elegant art thousands of years ago.

Passing over the paintings at Beni-Hassan, representing glass blowers at work, we may refer to the Roman productions which are accessible to all—the celebrated Portland vase in the British Museum, the amphora-shaped vase exhumed at Pompeii, the extraordinary collection in the museum of Boulogne, and to private museums—as attesting the wide range taken by the ancients in the various manipulatory processes of the art. According to Pliny, in his time the manufacturing of glass had extended to Spain and Gaul, and from these countries were probably imported most of the glass vessels and ornaments discovered in England.

The large cinerary urns of green glass so frequently found in Roman burial places, and the graceful vessels in white and in colored glass, cannot but excite the admiration of all interested in this art, especially when it is borne in mind the difficulties which the modern glass maker would have to surmount in executing many of them. Among those involving particular skill in moulding is a class ornamented with projecting pillars, of which several in green,

**The Connoisseur.**

(Continued from page 41.)

blue and mixed colors have been found in London and at Richborough. Pillar moulding is among the greatest improvements in glass-making of the present century. It was supposed to be a modern invention, but the discovery of the specimens just mentioned demonstrate that it is merely a revival of a lost ancient art.

It is very probable that some of the specimens of ancient glass brought from Thebes and other places in Egypt, may be of Greek or Roman manufacture. Many of them closely resemble authenticated Roman examples. To determine this point, however, the utmost caution is needed in ascertaining and verifying the circumstances under which they are found.

The silver crash doesn't affect the value of prize medals of that metal. But then, they're evidence of another kind of mettle.—*Puck.*

MERCHANT—I hate to deal with Gotrox. He is such slow pay. He hates to part with his money.

JUMPUPPE—Yet he can make his money talk as well as any one else when he takes a notion.

MERCHANT—I don't know about that. It always seems to me that his money stutters.—*Puck.*

**The Rambler's Notes.**

WHAT THE RAMBLER SAW AND HEARD AMONG THE DEALERS IN ART POTTERY, CUT GLASS, BRONZES, ETC.

AN extraordinary opportunity is now offered to jewelers handling of bric-à-brac, art pottery, fancy goods, etc., by Geo. Borgfeldt & Co., 18, 20 and 22 Washington Place, corner Greene St., New York, who will on Sept. 1st commence a sale of their entire present collection of over \$100,000 worth of samples in these lines at prices far below any previously put on these goods. Their stock of art specialties imported especially for the jewelry trade is the most extensive ever put under one roof. The stock is to be sold in order to make room for new importations.

Among the new importations in Limoges china sets and novelties shown by F. W. Büning, 58 Murray St., New York, are some handsomely decorated fish and game sets, with cobalt and gold, and apple green borders. The latter color is also appropriately shown in the exquisite lily-of-the-valley decorations on the chocolate sets, after dinner coffee sets, trays, and other novelties handled by jewelers. The forget-me-not, violet, and lily-of-the-valley decorations on the new and extensive assortment of Limoges photograph frames here shown are both delicate and artistic.

T. B. Clark & Co. are showing in their salesrooms, 53 Park Place, New York, full lines of cut glass ware in their three new patterns, the Egyptian, Majestic and Coral. A large variety of beautiful trays are ornamented with the Majestic cutting, which is particularly brilliant in these pieces. The pattern consists of a centerpiece, a many pointed, deeply cut star, surrounded by a border of strawberry diamonds and checker work; outside of this are fans opening toward the bottom of the dish. Among other new goods exhibited is a fine line of colored glassware, the largest they have ever shown.

Levy, Dreyfus & Co., 11 Maiden Lane, New York, are making many new additions to their Carrara and Castellina marble busts, groups, figures, etc. These and other lines, especially the porcelain clocks, appear to be well appreciated by the buyers who have seen them. Their artistically decorated Royal Halford ware described in this column some time ago, has proved itself a most popular line, and the many new and beautiful pieces which have lately been shown will surely add to its popularity.

THE RAMBLER.

Persons extremely reserved are like old enameled watches, which had painted covers that hindered your seeing what o'clock it was.—*Walpole.*



**Exceptional Opportunity**

FOR

**Bric-a-Brac Buyers!**

OUR entire collection of IMPORT SAMPLES comprising \$100,000 worth of HIGH ART NOVELTIES, specially imported for the Jewelry

Trade, are now on exhibition and will be sold on and after Sept. 1st, at Big Reductions to make room for new importations of Fine Pottery, Art Furniture, Marbles, Exclusive Art Productions, &c.

**GEO. BORGFELDT & CO.,**

18, 20, 22 WASHINGTON PLACE, cor. Greene Street, NEW YORK.

# ANNOUNCEMENT



**FALL, 1893.**

Our Importations for the coming season are now arriving and we have on exhibition at our ware-rooms a complete assortment of exclusive

## Novelties and Specialties

SELECTED FOR THE JEWELRY TRADE.

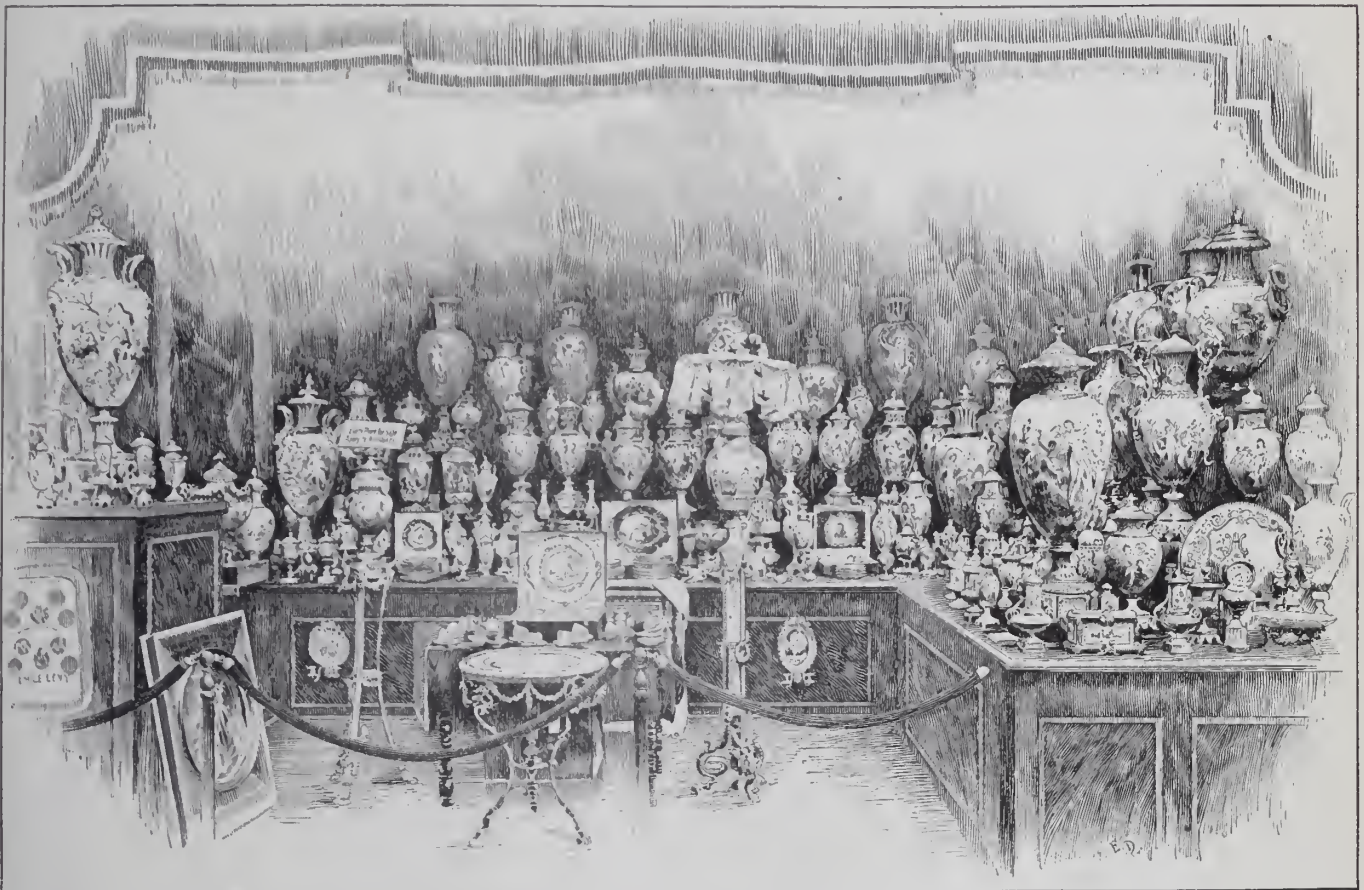

PAVILION CONTAINING THE KERAMIC EXHIBIT OF LEON J. GLAENZER & CO., AT THE WORLD'S FAIR.

Clocks, Bronzes, Sevres Vases, Fine Decorated Porcelains, Cups and Saucers, Tea Sets, Lamps and gilt and silver plated filigree Photo Frames in endless variety.

# LEON. J. GLAENZER & CO.,

35 Boulevard de Strasburg, Paris.

80 & 82 CHAMBERS ST., N. Y.

**B. & W. B. SMITH,**

220 WEST 29<sup>TH</sup> ST.,

NEW YORK CITY.

AT THE

**WORLD'S FAIR, CHICAGO,**

OUR EXHIBIT IS IN THE

Manufactures and Liberal Arts Building, Section A, Block One.

CALL AND SEE US AT OUR OFFICE IN NEW YORK.

Porcelain, Onyx, Gilt and Enamel Clocks and Clock Sets.

POPULAR GOODS AT POPULAR PRICES.

SPECIAL DESIGNS CONTROLLED BY US IN

Clocks, Art Pottery, Etc.

Fancy Glassware, Vienna Vases, Tete-a-tete Sets.

MARBLE STATUARY

in Carrara and Castellana, Etc., Etc.

LEVY, DREYFUS & CO., 9 and 11 Maiden Lane, New York City.

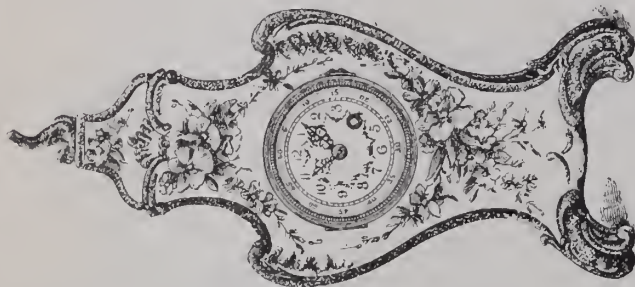

THE SECURIUS.

WOLFF & GUNZBURGER, Importers of DIAMONDS, (Fulton Building), NEW YORK. 87 NASSAU ST., NEW YORK.

**WHY**

S. F. MYERS & CO. sell more goods than any other Wholesale Jewelry House.

**BECAUSE**

They are the only firm in the Metropolis who carry in stock a full line of everything a jeweler requires. They give the utmost values and endeavor to please their trade in every respect. Refer to their various publications and illustrated catalogues.

MYERS BUILDINGS, 48 & 50 Maiden Lane, NEW YORK.

ESTABLISHED 1848.  
**DIAMONDS**  
**BRUHL BROS. & CO.**  
21 Maiden Lane, N. Y., 57 Rue de Chateaudun, Paris.  
**PEARLS**  
and other Precious Stones.

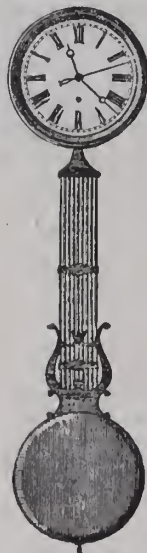

**Chas. Jacques Clock Co.,**

22 CORTLANDT STREET, NEW YORK.

Importers and Manufacturers

SWISS REGULATORS, ELLIOTT'S CHIMING CLOCKS, FRENCH AND ENGLISH MOVEMENTS, HALL CLOCKS, TRAVELING CLOCKS, GILT REGULATORS, FAIENCE & GILT CLOCKS & SETS, ETC.

Complete line of English and French Clock Materials.

Pinions and Wheels Cut on Premises.



S. P. HOWARD,  
Gold and Silver Assayer.  
Refiner and Sweep Smelter,  
33 MAIDEN LANE, NEW YORK.  
Smelting and Refining Works,  
28 & 30 Cumberland Street, Brooklyn, N. Y.  
Specialties: Sweepings, Gold, Silver and Platinum

**M. H. KLING, \*IMPORTER OF\***  
**DIAMONDS,**  
11 JOHN STREET, NEW YORK.

IT PAYS TO KEEP IN TOUCH WITH TRADE AFFAIRS. THE JEWELERS CIRCULAR, For 4c. a Week will do it. **Subscribe.**

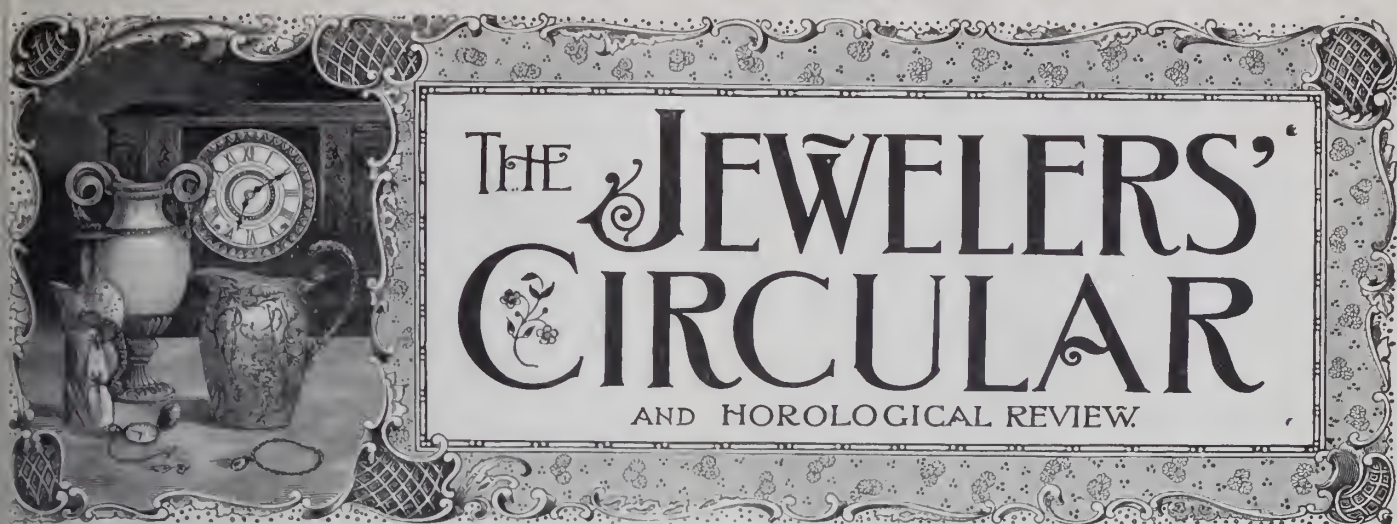

Copyright, by THE JEWELERS' CIRCULAR PUB. CO.

189 Broadway, New York.

Entered at the Post Office in N. Y. as second-class matter.

VOL. XXVII.

NEW YORK, WEDNESDAY, SEPTEMBER 6, 1893.

No. 6.

ART IN ENGLISH SILVERSMITHING.

A VERY finely chased silver-gilt centre-piece and dessert dishes valued at \$1,000 was presented by the Royal Tradesmen to their Royal Highnesses, the Duke and Duchess of York, on the occasion of their marriage. The silverware is in the Queen Anne style. The centre-piece stands 31 inches high and 27 inches long. The base is in the form of a richly paneled plateau with scroll feet. There are finely engraved scroll standards supporting an open scroll canopy carrying a basket at the top for flowers or fruit.

From each side of the canopy spring branches for six lights. Under the canopy and between the standards is a finely modeled and highly finished group of children with a goat. The whole were designed and manufactured by R. & S. Garrard & Co., Crown jewelers, Haymarket, London, S. W. Garrard & Co. have also designed and manufactured the very handsome pearl and diamond tiara presented to their Royal Highnesses by the girls of England. It is a diamond tiara of filiated scrolls, with fourteen large and fine graduated drop pearls, the whole design resting upon a triple row of brilliants. These two pieces have received publication in either the trade papers or periodicals, aside from that now in this journal.

which strikes the hours on a large full toned gong, and chimes the quarters on eight bells. In connection with the clock there is

There is a military procession worked by the clock, representing various branches of the British army, consisting of artillery, cavalry and infantry, and the staff in review order. There is also a sentry on duty, who salutes a drummer who beats the drum, and a bugler who raises his bugle to his mouth every few minutes. All of these figures are arranged at the top of the dial. A musical instrument plays while the procession is marching in review.

Near the bottom of the clock is placed a military band which is concealed by a curtain, which is raised every hour when the music is playing and the procession moving, and falls again immediately after the clock has struck, and remains drawn until the next hour. The case, made of ebonized mahogany, is about six feet high, three feet six inches wide, and two feet six inches deep, highly ornamented with brass trimmings. The circles on the dial to show minutes, hours, days of the month, etc., are engraved and silvered. The center and sides of the dial are richly enameled. At the sides of the case are massive brass ornamental handles and ornamental fretwork.



ROYAL TRADESMEN'S GIFT TO THE DUKE AND DUCHESS OF YORK.

Marvel of Ingenuity.

A FIRM in Calcutta, India, has lately completed a very ingenious time-piece in the shape of an eight day clock,

a perpetual calendar, which gives the correct days of all the various months, including the twenty-nine days of February in leap year.

While the two sides balance they are rarely repeated.

Bracelets in enamels are very Oriental in character. The enameling is usually only on one side; the other is enriched with gems. In most Oriental jewelry it may be observed that

MARJORIE.

INITIAL.



ILLUSTRATING THE FOUR DESIGNS OF  
 EBONY AND SILVER

COMBINATIONS

— IN —

TOILET SETS.

DEITSCH BROS.

≡ ORIGINATORS OF NOVELTIES ≡

— IN —

— Leather and Silver Combinations. —

7 EAST 17TH STREET NEW YORK CITY.

CASTLE.



EMPIRE.



These designs are made in the following articles

Round and Oval Mirrors,

Bonnet and Velvet Brushes,

Combs,

Manicure Requisites,

Stationary Racks,

Writing Necessities,

Photo Frames,

Stamp Boxes,

Paper Knives,

Pen Trays,

Pin Trays,

Hair Pin Boxes,

Shoe Buttoners,

Glove Powder Bottles,

Mustache Brushes,

Jewel Caskets,

Letter Clips,

Jewel Trays,

Shoe Horns,

Infant Brushes,

Smoking Sets,

Coasters, Whisks.

# DEITSCH BROS.,

MAKERS.

7 East 17th Street,

NEW YORK.

“DO YOU KNOW?”

THAT GOODS FREE FROM SOLDER ARE THE BEST?

THAT GOODS MADE FROM SEAMLESS WIRE ARE SUPERIOR IN FINISH ON THIS ACCOUNT?

THAT SEAMLESS WIRE MAKES THE BEST FILLED CHAINS?

THAT WE ARE THE MAKERS OF THE ORIGINAL AND CELEBRATED:

SEAMLESS GOLD FILLED CHAINS?



Do not fail to visit our beautiful and artistic display at the World's Fair. The finest of its kind at the Exposition.



Northeast Corner of Manufactures Building, Department O.  
Right on the corner. See Official Catalogue.

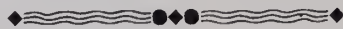

**Kent & Stanley Co.,**

BRANCH OFFICES:

NEW YORK: 17 MAIDEN LANE. SAN FRANCISCO: PHELAN BUILDING.  
BOSTON, 58 WINTER STREET, MONTREAL, TEMPLE BUILDING.

MAIN OFFICE AND WORKS:

**PROVIDENCE, R. I.**

**AIKIN, LAMBERT & CO.**  
19 Maiden Lane, NEW YORK.  
Branch, 42 & 44 East Madison St, CHICAGO, ILL.  
Manufacturers and Exporters of  
Gold Pens, Holders, Picks, Pencils,  
Fountain Pens, etc.



11 x 5 1/2 inches.

PLUSH TRAY WITH EASEL BACK.

1 Doz. 16 K. Pens and Assorted Holders, List, \$30  
1 Doz. 10 K. Pens and Assorted Holders, List, \$24  
Send for Trade Discount.

**OPTICIANS' SUPPLIES**  
Jobbing and Prescription Work.  
The "Graduate" Trial Cases, 180 1/8 set, \$30.00; 220 lens set, \$37.50. The "Standard" Trial Case, 220 lens set, \$65.00. All with rings. Loring Ophthalmoscope, \$9.00. Artificial Eyes, for selection, \$1.00 each; \$50.00 per hundred. Ophthalmometer, \$50.00 to \$70.00. Queen's Standard Perimeter, \$15.50. Queen's Lens Grindin' Outfit, \$20.00. Steel Frames, 15 to 30 cents each. Spherical Lenses, 25 cents per pair. Cylinders, 31 cents per pair. Lenticular Bifocals, 8 cents per pair, [all best made] nose pieces, [all best made] German Silver, \$1.00 per dozen pairs. Gold, \$2.00 per dozen pairs.  
**QUEEN & CO.** Opticians and Catalogue No. 1010 Chestnut St., Phila., Pa.



AMERICAN RAILWAY SUPPLY CO.  
24 Park Place, NEW YORK.

For **BADGES AND MEDALS.**  
Flag Pins, Class Pins, Class Rings  
and Special Work of all Descriptions,  
SEND TO **E. R. STOCKWELL**, MANUF'R.  
19 John Street, New York.



# THE FAIRPOINT MFG. COMPANY.

NEW BEDFORD, MASS.

FLATWARE.

HOLLOW WARE.

- BERRY FORKS.
- BERRY SPOONS.
- ICE CREAM KNIVES.
- ICE CREAM SPOONS.
- SALAD SETS.
- OYSTER FORKS.
- OLIVE SPEARS
- PUNCH LADLES.



2410.—OVAL TUREEN.

- BERRY SETS.
- BERRY DISHES.
- ICE PITCHERS.
- ICE TUBS.
- SALAD BOWLS.
- OYSTER LADLES.
- WINE SETS.
- PUNCH BOWLS.

NEW YORK,  
20 MAIDEN LANE.

CHICAGO,  
224 WABASH AVE.

SAN FRANCISCO,  
220 SUTTER STREET.

We sell to the legitimate Jewelry and Stationery trade only.



SPECIALTY: SALES OF  
**JEWELRY, BRIC-À-BRAC**  
AND  
ARTICLES OF VERTU



CHOICE PAPERS

MAKERS OF

## FINE STATIONERY

For Correspondence, Wedding and Business Use, handsomely boxed, specially suited to the Jewelry Trade.

18 MURRAY STREET, NEW YORK.

**Bruner Plating and Jewelry Rep. Co.**

Jewelry Matched and Repaired, Engraving, Chasing and Enameling, Setting, Polishing and Lapping, Battery Gilding and Roman Coloring, Watch Cases Repaired, Polished and Gilded.

32 Maiden Lane, New York.

# WORLD'S FAIR SOUVENIRS.

\* STERLING SILVER. \*



THE COLUMBUS.



REVERSE SIDE OF HANDLE.



REVERSE SIDE OF HANDLE.



THE DISCOVERER.



REVERSE SIDE OF HANDLE.



THE AMERICAN.

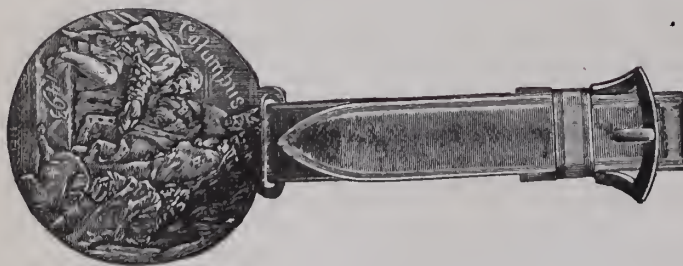

No. 2. BAGGAGE CHECK.



MATCH BOX.

## R. WALLACE & SONS MFG. CO.,

SILVERSMITHS,

WALLINGFORD, CONN.

NEW YORK:  
3 PARK PLACE.

CHICAGO:  
86 WABASH AVENUE.

**The Creditors of Joseph W. Dupont.**

MINNEAPOLIS, Minn., Aug. 30.—The schedules filed by the assignee of J. W. Dupont, some days ago show the assets to be \$6,220.84 and the liabilities \$6,697.18. The list of creditors is as follows:

Commercial Bank of Minneapolis, \$2,200; G. Alford & Co., \$199; Ernest Adler, \$275.25; Wm. L. Gilbert Clock Co., \$106.75; Illinois Watch Co., \$123.65; Louis Kaufman & Co., \$27; Lapp & Flershem, \$175.44; Minneapolis Jewelry Mfg. Co., \$250; New Haven Clock Co., \$13.50; M. A. Mead & Co., \$228.80; Reed & de Mars Jewelry Mfg. Co., \$39.20; Rentz Bros., \$7.68; J. R. Wood & Sons, \$66.14; Sigler Bros., \$223.49; A. Sanborn & Co., \$16.64; Pairpoint Mfg. Co., \$38.14; Dr. Laliberte, of Minneapolis, \$1,500; Trier Bros., \$252; Michael Roller, \$150; S. A. Rice, \$150; T. W. Emery, \$20; Charles Marshall \$50; E. Miller, \$13; J. J. Macky, \$300.

**Assignee Patterson of the Keystone Standard Watch Co. Enters Suits.**

LANCASTER, Pa., Aug. 30.—Interest in the affairs of the old insolvent Keystone Standard Watch Co. was aroused this week by the institution in the courts of this county of two suits of very large amounts. D Ramsay Patterson, assignee of the company, brought suit against Geo. M. Franklin, J. Fred Sener, George Steinman, Henry S. Franklin and J. P. Stormfeltz, administrator of Clarence S. Stormfeltz, to recover the sum of \$50,000 with interest from Nov. 6, 1886.

The plaintiff claims that the defendants, who were the five original incorporators of the Keystone Standard Watch Co., should have paid in cash ten per cent. or \$50,000 of the capital stock, which was \$500,000, but failed to do so.

On Wednesday, D. Ramsay Patterson, the assignee, brought an action in trespass in the Common Pleas Court to recover \$200,000 damages from Hugh M. North, a prominent attorney. The plaintiff alleges that the defendant on April 16, 1892, at a sheriff's sale of real estate, bought the real estate of the Keystone Standard Watch Co., and that he, under a title claimed by him by reason of the sale, took and converted to his own use all the machinery valued at \$200,000, in the factory, when according to the plaintiff's claim, the liens, to satisfy which the sheriff's sale took place, did not cover the machinery, which the defendant has since refused to give up.

The sheriff's sale of the real estate of the Keystone Standard Watch Co., took place on April 16, 1892, and Hugh M. North bought the property for \$6,000, subject to a mortgage for \$50,000. The sheriff's levy

**BIPPART & CO.**  
 MANUFACTURERS OF  
**DIAMOND JEWELRY**  
 NEWARK, N. J.

BROOCHES, SCARF PINS, HAT PINS, HAIR PINS, EARRINGS,	LINK BUTTONS, CUFF PINS, BRACELETS, NECKLACES, RINGS.
--	---

NEW YORK OFFICE 19 MAIDEN LANE

**THE BOWDEN  
 SEAMLESS RING**

IS MADE ONLY BY

**J. B. BOWDEN & Co.,**

Makers of Finger Rings of every Description.

**COR. BROADWAY & JOHN STREET,  
 NEW YORK.**

**J. B. & S. M. KNOWLES CO.,**

MAKERS OF

Sterling



Silverware.

FACTORY,  
 Providence, R. I.

SALESROOM,  
 860 Broadway, N. Y.

**O. W. BULLOCK & CO.,**  
 SPRINGFIELD, MASS.

Makers of Watch and Jewelry Tools,  
 NEW CATALOGUE NOW READY.

Sent on Application.

Please Mention this Paper.

**JACOT & SON**  
 IMPORTERS AND MANUFACTURERS OF  
**MUSICAL BOXES**

298  
 BROADWAY,  
 NEW YORK

**CLEAN JEWELRY SELLS QUICK.**

Quarters' Cleaning Solution removes dirt and tarnish in an instant, makes stock like new and brings up diamond and stone work to a beautiful luster. Solution can be used over and over. Highly commended by all who use it. Send at once \$1.50 for half gallon with full directions. References.

**W. F. QUARTERS, ELECTROPLATER,**  
 39 EDDY STREET, PROVIDENCE, R.

# Craighead & Wilcox,

NO. 33 BARCLAY STREET, }  
NO. 38 PARK PLACE, }

NEW YORK CITY.



REPRESENTING

CRAIGHEAD & KINTZ CO., Makers of Lamps and Metal Fancy Goods.

WALTER S. BERG, Maker of Silk Lamp Shades.

HARTFORD SILVER PLATE CO., Makers of Silver Plated Goods.

HACHE, JULLIEN & CO., Vierzon, France, Makers of French China.

---

THE COMPLETE NEW LINES ARE NOW ON EXHIBITION AT OUR SALESROOM.

described the property as including two 30-horse power boilers, one 30-horse power engine, shafting, hangers, pulleys, belting, rods with counter hangers for bench machinery, bench machinery, benching with drawers, and all the necessary machinery and tools for the operation of a first class watch factory.

All the real estate and machinery which passed to Mr. North have since been transferred to the Hamilton Watch Co., formed by a combination of local interests and the Aurora Watch Co., of Aurora, Ill.

**Demise of an Old-Time Clock Manufacturer.**

BRISTOL, Conn., Aug. 30.—The body of William W. Carter, who died at Sachem's Head, Conn., last Thursday, arrived here this week. Mr. Carter was an old resident of Bristol, had held the office of first select-

man besides various other town offices.

The deceased was engaged in the manufacture of clocks in Ansonia for many years and later was engaged with Elias Burwell in the same business in Bristol. He was also an agent through the west for the sale of clocks and timepieces. He was possessed of considerable property, consisting largely of railroad stocks.

**A Most Desirable Burglar Caught at Last.**

ST. LOUIS, Mo., Aug. 31.—A despatch from Caddo, I. T., states that the City Drug Store was burglarized and about \$1,500 worth of jewelry was taken. The thief was seen leaving the house, where he had made his entrance through a back window, and when asked what he was doing he made off as fast as possible. He was followed about two miles from town and captured.

He refused to give his name. He is a medium-sized negro, about twenty-six years old. When caught he went back and showed his capturers the jewelry where he had thrown it away in the weeds. He had two satchels full. He said he had been in St. Louis and Kansas City a great deal, and had made several good hauls there, but never had been arrested before.

**The Oldest Jeweler of Erie, Pa., Passes Away.**

ERIE, Pa., Sept 1.—The death of Lorenz Kossbiel, which occurred this week, removes from our midst one of the oldest settlers. Deceased was born in Loeffinger, Baden, Aug. 19, 1802. He came to Erie in 1833 and his family followed several years later.

For the last thirty years Mr. Kossbiel had lived on E. 9th St., where he had been en-

**RICE & HOCHSTER'S,**

Nos. 483 & 485 BROADWAY, NEW YORK.

ARTISTIC DISPLAY OF TORTOISE SHELL WORK AT THE WORLD'S FAIR.

THE perfection reached by workers in tortoise shell will be amply exemplified at the World's Columbian Exposition by the display of Rice & Hochster, New York. The exhibit is in the Manufactures building, Gallery F and Pillar No. 83. The articles are displayed within a case, upon a pyramid. Surmounting this pyramid are shown the marvelous ornamental work in tortoise shell illustrated on this page, and represents an arch, upon which are groups of figures typifying agriculture, commerce, machinery, electricity, the press, iron work, chemistry, sculpture, painting

motto *palmam qui meruit ferat* (let him bear the palm who merits it).

The workmanship is as fine and perfect as

ing. In the working of the shell, the amber colored portions have been made to represent the flesh, while the brown parts, the draperies.

The exhibit contains two figures of Washington and Columbus, made of solid shell. On one panel of the pyramid are cut in relief cameos of the twenty-three presidents of the United States. Prominent also are three large combs, one foot square, representing the landing of Columbus, the four Seasons and the five Continents. A great many styles of hair ornaments and lorgnettes made from select shell are in the exhibit. Five

WRITE FOR  
Selection  
Packages of  
Tortoise Shell  
Hair Ornaments  
and Lorgnettes.

Repairing of  
Tortoise Shell  
Goods Equal  
to New.

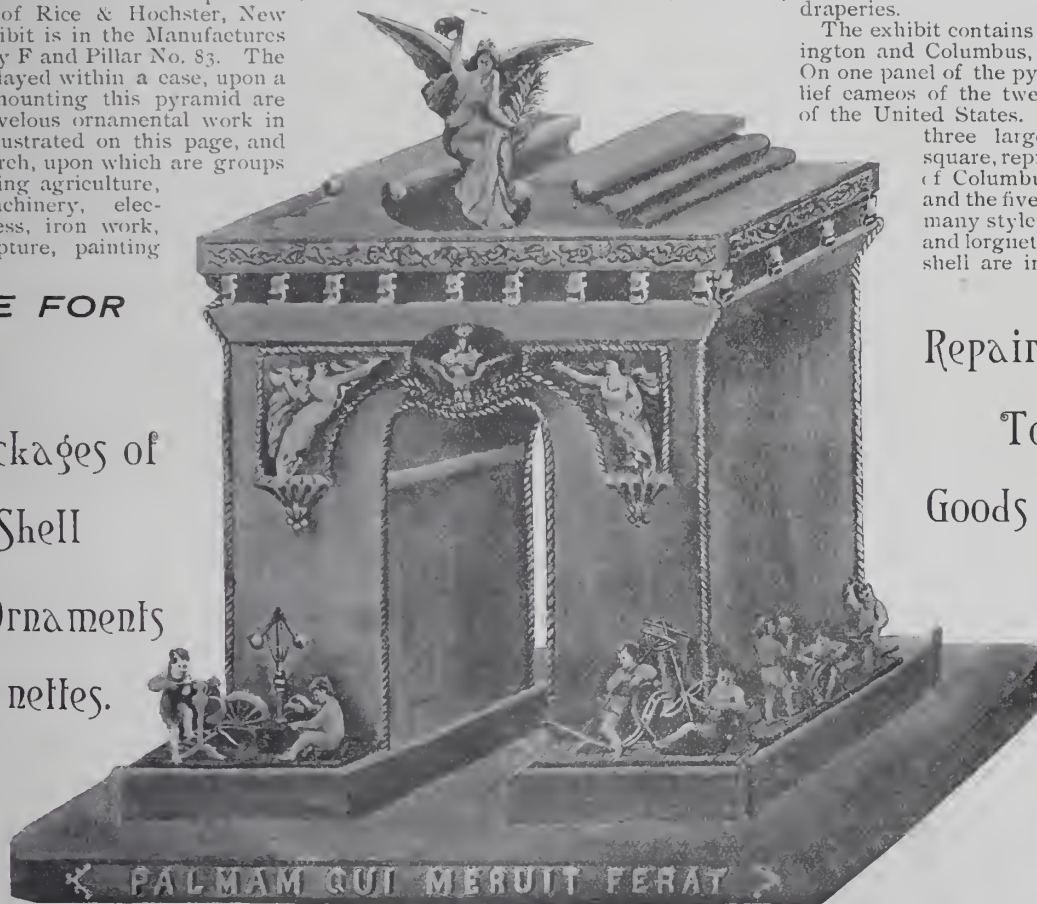

ORNAMENTAL PIECE IN TORTOISE SHELL, EMBLEMATIC OF THE TRIUMPH OF INVENTION AND ART.

and other arts. The angel which surmounts the piece is a faithful miniature of the figure which tops one of the buildings of the World's Fair. In relief, on the base, is the

conception of the piece is artistic. In the manipulation of the miniature figures the ingenuity of the artisans has been taxed to its utmost and has not been found want-

stuffed tortoises surmount the case which is of white and gold; the letters of the name of the firm are in tortoise shell. From THE JEWELERS' CIRCULAR, May 3d, '93.

gaged in clock repairing and keeping a Catholic book and news store. He has always enjoyed good health, notwithstanding his old age. Deceased was one of the few who assisted in organizing St. Mary's Catholic Church congregation, of which he was a life-long member. He leaves to mourn his death a son, Victor Kossbiel; also grandchildren and great-grandchildren. The business will be continued by his grandson, John Kossbiel, who had been with him for many years.

#### A Clever Robbery But a Cleverer Capture.

ST. LOUIS, Mo., Aug. 31.—William F. Kemper last Saturday morning left his store in charge of his lady assistant. Shortly after he left two strangers came in and asked to see some chains. She took one of them to the far end of the showcase and while engaged in showing him the jewelry the other fellow reached over the counter and unclasping the back lid of the show case extracted therefrom half a dozen gold watches and quietly "stole away."

When Mr. Kemper returned home he immediately discovered his loss, and informed the police. Tuesday morning the police succeeded in running down Charles W. Gunn, alias Newton, and on Wednesday in finding Joseph Fine, alias Schultz, both of whom confessed to being the culprits.

A warrant for grand larceny was sworn out against the men.

#### Salesman Rich Confesses He Pawned Goods Given Him to Sell.

TROY, N. Y., Sept. 1.—Albert M. Rich, the traveling salesman for Frank F. Pulver, manager of the Troy branch of the J. R. White Jewelry Co., of Syracuse, who was arrested for converting to his own use about \$500 worth of goods given him to sell, has confessed to Chief Detective Markham that he pawned the articles.

Rich gave to the detectives the names of the pawnbrokers with whom he left the articles, and several of them have been recovered. He is now in jail awaiting examination.

#### Who is Zach H. Madison Who Committed Suicide?

CHICAGO, Ill., Aug. 30.—The following dispatch has been received in this city, dated Quincy, Ill., Aug. 27: "Zach H. Madison, of the firm of Madison Brothers, opticians, of Chicago and St. Joseph, Mo., committed suicide at the Tremont House in this city. He came here Saturday somewhat under the influence of liquor and at noon drained a two-ounce vial of laudanum in his room. He was discovered in a dying condition at 4 o'clock. Doctors labored over him to no effect and he died about 1 o'clock this morning. He left word to notify his father, Harvey Madison of Milwaukee, Ill. His wife and family arrived this morning from Girard, Ill., and were horrified to find him dead. No reason beyond that of recent dissipation can be assigned for the deed. He formerly made his home in Quincy, but most of his time was spent on the road."

The directory gives no firm as above named and several members of the trade when approached by THE CIRCULAR correspondent, said they had never heard of any such house.

#### A New Clock Company in the Northwest.

MILWAUKEE, Wis., Sept. 4.—Articles have been filed incorporating the Appleton Clock Co., of Appleton, with a capital of \$150,000. The incorporators are: D. M. Hyde, W. B. Pelton, G. W. Pelton. The officers are: President, G. W. Pelton; secretary and treasurer, D. M. Hyde. The company will manufacture medium priced clocks.

The company have about \$40,000 worth of partly finished goods on hand from a factory which recently failed in Chicago. The company expect to have one building erected and part of the plant in operation this season. The plant will eventually employ five hundred hands, so it is said.

#### Heavy Taxpayers Among Providence Jewelers.

PROVIDENCE, R. I., Sept. 2.—The assessors of taxes at this city have just concluded their labors, by which it has been

learned that among the individuals and corporations that pay taxes on more than \$50,000 are the following interested in the jewelry and kindred trades:

John Austin, \$73,000; Barton A. Ballou, trustee, \$100,000; Nathan B. Barton, \$67,040; Charles W. Bowen, \$65,660; Brown & Sharpe Mfg. Co., \$669,480; John M. Buffinton, \$71,020; Caleb G. Burrows, \$161,250; George A. Champlin, \$52,540; Stanton B. Champlin, \$96,180; Prescott O. Clark, \$65,520; Joseph P. Cory, \$79,140; William H. Crins, \$75,180; Thomas Davis, \$30,260; Michael Fitzgerald, \$105,820; James A. Foster, \$75,860; Gorham Mfg. Co., \$491,640; Henry A. Hidden, \$293,060; Stearns Hutchins, \$57,440; Kent & Stanley Co., \$81,520; John C. Knowles, \$133,960; Benedict B. Lederer, \$66,600; Sigmund L. Lederer, \$72,660; Sylvester G. Martin, \$67,760; Nicholson File Co., \$213,200; Englehardt C. Ostby, \$50,000; Lydia D. Smith Owen, executrix, \$100,000; Lydia D. Owen; \$177,360; John S. Palmer, \$161,400; Isaac M. Potter, \$74,640; Gorham Thurber estate, \$103,100; Lorenzo Vaughn, \$64,100; Beriah Wall, \$188,840; Dutee Wilcox, \$195,080; George Wilkinson *et ux.*, \$57,880.

#### The Horn Western Gem and Lapidist Co., of Denver, Col.

DENVER, COL., Sept. 2.—The certificate of incorporation of the Horn Western Gem and Lapidist Co. was filed this week in the office of the Secretary of State. The capital stock of the company is \$10,000, divided into 1,000 shares at \$10.

The object of the enterprise is the collecting, prospecting for, cutting and dealing in precious stones and the manufacturing of natural jewelry. Fred F. Horn, B. Irwine and W. R. Barnes are the directors.

#### It Seems that Safe Blower Bruce was W. G. Pollack's Assailant.

TERRE HAUTE, IND., Aug. 31.—There seems to be no doubt but that Frank Bruce, the noted safe blower, who as dispatched to THE CIRCULAR last week, is under arrest here, perpetrated the daring diamond robbery on the Chicago, Burlington and Quincy road last Fall, when W. G. Pollack, salesman for W. L. Pollack & Co., New York was robbed of \$15,000 worth of diamonds.

Last week Mr. Mable, of Logan, Ia., who was a passenger on the train, identified Bruce as the robber who shot Pollack and made off with his diamond case, and this week Robert G. Fleming, of Missouri Valley, Ia., who was in the car in which the robbery was perpetrated, positively identified Bruce. Fleming sat in the next seat to the robber when the assault was made on Mr. Pollack, and he was sent here to look at the prisoner by the New York firm that lost the diamonds. If Bruce is not convicted here for safe-blowing, he will be taken to Iowa.

Geo. K. Foltz, Cleveland, O., has made an assignment.

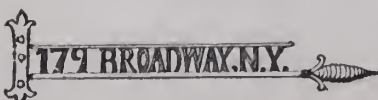

PROSPECTS FOR FALL TRADE.

THE jewelry trade with this month enters upon its busiest season of the year, a season that is essentially the jewelers'. In the minds of manufacturers, jobbers and retailers alike, has dwelt and perhaps does dwell, an anxiety regarding the prospects for business during the next three months. No members of the trade should be in a position to see more certainly into the future than the heads of the powerful commercial organizations of the trade. With this opinion in our minds, the following questions were last week submitted to the presidents of the eight or ten associations:

How have the present financial conditions affected the jewelry and kindred lines?

What, in your opinion, are the prospects for Fall trade?

Up to the time of going to press the adjoined replies were received:

PRESIDENT SEXTON'S LOGICAL VIEWS.

New York, Sept. 1, 1893.

Editor of THE JEWELERS' CIRCULAR:

The stagnation which has pervaded our trade in sympathy with the demoralization in all financial circles of our country, is as reasonable as the panic itself, which is the cause of it, has been unreasonable. Every careful observer has for some time realized that there were conditions existing in our National financial policy which, sooner or later, would bring about a dangerous state of affairs, but no conservative person would have predicted, that, in the midst of a fairly prosperous season, a crisis such as has been present with us during the past three months, could have occurred, and exerted such a baneful influence over all interests alike. Without stopping here to reason out what to many seems so unreasonable, and only calling attention to the fact that thus far the disturbance has not been so much a commercial panic as it has been a monetary one, I would call attention to the effect of it upon our own trade.

Careful observation and inquiry have developed the fact that the wholesale branches of our trade have been more seriously affected than the retail; that there has been no extensive and general curtailing of expenditures by consumers, and that notwithstanding the cry of hard times, and allowing for the usual dullness of the Summer months, the retail dealers will find that their sales will not fall very much below that of ordinary Summer seasons. Notwithstanding this, their purchases have been greatly curtailed, either through sympathy with the general financial stringency, or from the uncertainty as to what might happen later on. This has necessitated, upon the part of manufacturers and wholesale dealers, a cessation of all active preparations for the Fall season, and a more general shutting down and closing up of factories than has occurred since 1857.

The spirit of accommodation and leniency shown throughout the trade in connection with the settlement of accounts is a matter worthy of comment and commendation. There has been apparently very little disposition to crowd to the wall those who were temporarily embarrassed. To the contrary there has been a very fraternal disposition shown which is greatly to the credit not only of the prudence, but also of the generosity of our trade.

The prospects for the next four or six months are still in doubt, owing to the uncertainty as to how much general confidence will be restored by the action of Congress. To a sanguine person it would seem that, with the return of confidence and with the necessary redistribution and reinvestment of the immense sums so recently and suddenly withdrawn from circulation, there would be a marked improvement of our business, and that a fair Fall business might be expected. It will not do, though, to count too surely upon a greatly improved state of affairs. The more prudent course to take at present will be to act entirely uninfluenced by any expectation of an immediate increased demand until renewed confidence has shown itself in trade circles generally.

WM. L. SEXTON,  
President, New York Jewelers' Assn.

A GRADUAL IMPROVEMENT AND A FAIR TRADE THINKS PRESIDENT ANKENY.

Cincinnati, O., Sept. 1st.

Editor of THE JEWELERS' CIRCULAR:

Replying to your favor will say I do not think my views in regard to the present condition of trade will be of any importance, but I fully believe that there will be a gradual improvement during September and October and that we will have a fair trade the balance of the year.

Truly yours,  
C. H. ANKENY.  
President, Cincinnati Wholesale Jewelers' Association.

DUTEE WILCOX CONSIDERS THE TARIFF THE MAIN ISSUE.

Providence, R. I., Aug. 30.

Editor of THE JEWELERS' CIRCULAR:

Your favor requesting me to write you a communication giving my views on the present and the future outlook of the jewelry business is received. You will please excuse me writing anything for publication; this is a subject I would not attempt to discuss.

Our business, like all others that are done on long credits, depends almost entirely upon confidence; when that is restored I look for our usual volume of trade. It is my opinion that confidence will not be restored until the manufacturing industries of our country know what Congress is going to do with the tariff, and until they know

what the future financial policy of our Government is to be.

Respectfully yours,  
D. WILCOX,  
President, Manufacturing Jewelers' Board of Trade.

PRESIDENT BRYANT OFFERS PARTICULAR CASES. Chicago, Ill., Sept. 12.

Editor of THE JEWELERS' CIRCULAR:

In answering your questions "How the present financial conditions have affected the jewelry and kindred lines?" and "Prospects for Fall trade in our line?" it has been necessary to consider the causes of the depression which have affected every business, and, speaking from my large acquaintance with the Middle and Western States, our own trade to so great an extent during the past sixty days.

No doubt the silver question plays a considerable part in the trouble, inasmuch as the fear that the United States in her desire to appreciate the value of silver would declare that the silver dollar should be taken in all payments as equal to the gold dollar, caused foreign investors to withdraw their capital. But though this has affected business to some extent the effect of the unsettled condition of the tariff has been immensely greater.

Leaving entirely to the domain of politics the question of free trade *v.* protection, since the nation so pronouncedly declared last November for the modification of the tariff, this should be made at once instead of allowing manufacturers to remain in the disastrous state of uncertainty in which they now are placed. Stocks cannot be made up, and capital which is proverbially timid, dares not embark in enterprises that in a short time may have to face entirely different conditions.

Passing from general to particular causes of depression, the bane of our own trade is the unfair competition of the vegetable, molasses and dry goods man, who, using jewelry, watches and clocks as "leaders," trashy stuff, such as fifteen-cent rings and ten-cent silver thimbles, persuades a numerous and gullible public that all jewelers overcharge. This is, of course, untrue. The jeweler is a man who must know his business thoroughly, and his reputation is at stake for all he sells; but no one thinks of holding the dry goods man responsible for the meretricious rubbish which he, by the fraud and false pretense of cheapness, imposes upon purchasers who cannot judge for themselves.

The heavy clouds are passing away, and though it will be some time before we are again in the full sunshine of prosperity things are already much brighter in these parts. Our great west, young and rich in products of all kinds, is beginning to recover itself, and probably will do so much more rapidly than the older and less prolific east. I say this with some regret, being born and bred in New York State.

The prosperity of our own trade would be much strengthened by a larger organization of its members. I have arrived at this conviction by seeing how useful the "Watchmakers' and Jewelers' Association of Illinois" has been, although only formed less than two years ago.

In spite of the stringent financial conditions there have been comparatively few failures in our lines, and none at all among the conservative and substantial jewelers, whether in a large or small way of business. So far as I know, only those have gone over whose flighty and "spread-eagle" methods of business must sooner or later have ended in bankruptcy.

With the hope and belief that prospects for Fall trade are not only good but may be even better for the passing trouble I am yours truly,

O. G. BRYANT.

*President, Retail Watchmakers' and Jewelers' Assoc'n of Illinois.*

PRESIDENT GOODMAN NOT SANGUINE OVER THE PROSPECTS.

Philadelphia, Pa., Sept. 1.

*Editor of THE JEWELERS' CIRCULAR:*

Responding to your desire for an opinion of the effect of the financial conditions in the jewelry trade, and incidently the prospects for Fall trade, I express myself from a retailer's point of view and I may err.

The fact is too apparent to deny that the past few weeks has seen the country and particularly the jewelry and kindred trades suffering from a deplorable depression of business, and while it is natural for men to look hopefully upon every crisis in life, business or otherwise, it would require, I am sure, a large stretch of imagination and an extraordinary amount of buoyancy to permit one to say that the coming Fall trade can by any manner of means reach the standard of previous years.

It is true that a reaction has set in, but the time is too short to enable the trade to realize very largely from the restoration of business confidence and stability; consequently he who is satisfied with moderate returns, and prepared to await a later season for that stimulant of business, a "rush," will be a man of judgment and contentment. The retailer with caution in his buying, may look forward to, at the utmost, but a fair season; but should it prove otherwise and develop on a par with the past two or three years, none will rejoice more than yours very truly,

ARTHUR S. GOODMAN,

*President, Nat. Retail Jewelers' Assn., U. S.*

#### The Green-Smith Watch and Diamond Co. in the Sheriff's Hands.

DENVER, Col., Sept. 2.—The Green-Smith Watch and Diamond Co. were attached yesterday and the business is now in the hands of the sheriff. The attachments are by Denver National Bank, \$25,991.50; John W. Knox, \$59,685; Susan T. Knox, \$59,-

948.35; Washington S. Green, \$19,000; Washington S. Green, \$6,000.

John W. and Susan T. Knox are the father-in-law and mother-in-law of Mr. Green, and Washington S. Green is the father of the same.

#### The Liabilities and Assets of F. E. Morse & Son.

CHICAGO, Ill., Sept. 4.—The following list of creditors on July 31, 1893, has been filed by F. E. Morse & Son:

R. A. Kipling, notes \$1,615.28, open acct. \$173.08, \$1,788.36; E. L. Anrich, notes \$6,547.48; Lewis, Kaiser & Luthy, notes \$14,344.93, open acct. \$543.14, \$14,888.07; L. Strasburger's Son & Co., notes \$10,442.75; Randel, Baremore & Billings, notes \$10,000; Henry Dreyfus & Co., notes \$3,894.66, open acct. \$61.88, \$3,956.54; E. Karelsen & Co., notes \$1,118.11; A. H. Smith & Co., open acct. \$347.56; Paul Jeanne, open acct. \$556.77; Tatsch & Wild, open acct. \$327.72; J. R. Keim, open acct. \$197.65; G. Armcny, open acct. \$142.67; D. Wilcox & Co., open acct., \$113.77; Wallach & Schiele, open acct. \$201.21; Wm. Kinscherf, open acct. \$167.85; M. A. Mead & Co., open acct. \$74.02; Wm H. Ball & Co., open acct. \$90.68; L. Manheimer, open acct. \$71.13; Gorham Mfg. Co., open acct. \$62.20; many small accounts aggregating \$300.95; First National Bank, Chicago, notes \$8,500; Atlas National Bank, Chicago, notes \$6,500; Morse, Mitchell & Williams, \$20,546.33; Illinois Trust and Savings Bank, second \$18,000; note to F. B. Chandler, trustee, second, \$12,500; note signed by various parties, \$12,500; note to Royal Trust Co., second, \$5,000; note to Mrs. H. D. Mitchell, balance \$2,700; creditors not on books, \$767.70; total \$139,409.52.

The schedule of inventory is as follows:

Interest in lands,	-	Equity doubtful
Stock of merchandise, inventory		
\$71,467.46 (estimated),	-	\$61,562.37
Office fixtures,	-	795.00
Household effects, etc.,	-	100.00
Outstanding accounts, \$6,448.42		
Bills receivable, \$752.25		
Estimated as good	-	4,637.18
" " doubtful, \$555.94		
" " desperate, \$2,007.55		
		Total, \$67,094.55

[In addition to above accounts, an account styled F. E. Morse & Son is shown on the books, which represents equities in real estate values, impossible at this time to state.]

Total liabilities	-	\$139,409.52
Secured " (as per schedule)		35,500.00
Unsecured	-	\$104,909.52

It was stated at the office of F. E. Morse & Son that an appointment was made for Tuesday last week, with the attorney for the creditors, but that he failed to appear or send word. No examination has yet taken place.

The Geneva Optical Co., Geneva, N. Y., reopened their factory, Monday.

#### Last Week's Arrivals.

**THE CIRCULAR** has perfected arrangements for obtaining the names and hotel addresses of all the latest buyers visiting New York, and each day posts in its office, 189 Broadway, a bulletin which every member of the trade is cordially invited to copy.

The following out-of-town dealers were registered in New York during the past week: L. C. Claudel, New Orleans, La.; Astor H.; A. Myers, Philadelphia, Pa.; Astor H.; S. L. Cohen, St. Louis, Mo.; Everett H.; W. F. Podmore, Troy, N. Y.; Grand Union H.; J. F. Jones, buyer for J. N. Adams & Co., Buffalo, N. Y., 55 White St.; T. Lovell, Cincinnati, O., St. Denis H.; Lee Lewis, buyer for J. C. Lewis & Co., Louisville, Ky., Sinclair H.; Mr. Pilling, buyer for Jordan, Marsh & Co., Boston, Mass., 8 Greene St.; J. C. Lutz, Buffalo, N. Y., Sinclair H.; H. E. Hall, San Francisco, Cal., Imperial H.; H. L. Frankle, Washington, D. C., Lincoln H.; H. Eisenberg, buyer for Dives, Pomeroy & Stewart, Reading, Pa., 120 Franklin St.; E. E. Durant, New Haven, Conn., Park Ave. H.; A. Judis, San Francisco, Cal., Astor H.; M. S. Liberman, Syracuse, N. Y., Astor H.; C. J. Foster, of Geo. C. Shreve & Co., San Francisco, Cal., Victoria H.; J. E. Mitchell, Fort Worth, Tex.; J. E. Ladd, Bristol, Conn., Astor H.; C. K. Giles, Chicago, Ill., Astor H.; H. S. Hoyt, Danbury, Conn., Grand Union H.; A. Oppenheimer, Philadelphia, Pa., Imperial H.; S. D. Cook, Denver, Col., Astor H.; J. S. MacDonald, Baltimore, Md., Astor H.; G. A. Montgomery, Los Angeles, Cal., Everett H.; A. Andrews, San Francisco, Cal., Coleman H.

#### The Death of Charles W. Fogg.

BOSTON, MASS., Sept. 3.—Charles W. Fogg, one of the directors of the American Waltham Watch Co., died to-day at his residence in Waltham, Mass. Mr. Fogg was widely known in the trade as the inventor of the safety pinion.

Deceased was born in Meredith, N. H., Jan. 25, 1817, and was 25 years of age when he located in Waltham. At first he carried on the business of watchmaker and jeweler, but when the watch company was started he became the superintendent of the factory, having charge of it for about 25 years.

During the past ten or twelve years Mr. Fogg had not been in active business, although he retained a place in the directory. At the Philadelphia Centennial Exposition he was one of the judges in the watch department. He had been a director in the Waltham National Bank and the Waltham Savings Bank, and was prominent in the Masonic fraternity. He leaves a widow, one son and two daughters.

It is not well to judge of a man's possessions by the number of keys he carries on his ring.

—Puck.



# The Jewelers' Circular

AND  
HOROLOGICAL REVIEW.

PUBLISHED EVERY WEDNESDAY BY

THE JEWELERS' CIRCULAR PUB'G CO.,  
189 BROADWAY, NEW YORK CITY.

A JOURNAL DEVOTED TO THE INTERESTS OF  
JEWELLERS, WATCHMAKERS, SILVERSMITHS,  
ELECTRO-PLATE MANUFACTURERS, AND ALL  
ENGAGE IN KINDRED BRANCHES OF INDUSTRY

Our Editorial columns will contain our own opin-  
ions only, and we shall present in other columns only  
what we consider of interest or value to our readers.  
Advertising matter will not be printed as news.

Advertising rates in THE CIRCULAR are lower,  
considering the number of tradesmen reached by this  
large circulation, than in any other jewelry journal.

Notices of changes in standing advertisements  
must be received one week in advance; new matter  
can be received up to Monday.

## INFORMATION FOR SUBSCRIBERS.

### Terms of Subscription, Postage Prepaid.

United States and Canada,	PER ANNUM	\$2.00
Foreign Countries in Postal Union,		4.00
Single Copies,		.10

New subscribers can commence at any time.  
Payments for THE CIRCULAR, when sent by mail, should be  
made in a Post-Office Money Order, Bank Check or Draft, or  
an Express Money Order or Registered Letter. All post-  
masters are required to register letters whenever requested to  
do so.

Pay money only to authorized collectors having proper  
credentials.

Returning your paper will not enable us to discontinue it,  
as we cannot find your name on our books unless your ad-  
dress is given.

In changing address always give the old as well as  
new one. Your name cannot be found on our books unless this  
is done.

The Courts have decided that all subscribers to journals  
are responsible until arrearages are paid in full and an order  
to discontinue has been received by the publisher.

## Member of the American Trade Press Association.

VOL. XXVII. Sept. 6, 1893. No. 5

It has been expressed by some pessimist  
that the science of horology has ere this  
reached the end of its tether. We are in-  
clined to disagree with our Diogenes, how-  
ever, when we observe the score of patents  
relating to horology, granted during one  
week, by the United States patent office, as  
set forth in others of this number of THE  
CIRCULAR.

### The Clouds Dispelling.

FROM several quarters  
come announcements  
of increased business in the  
jewelry trade, and expres-  
sions of faith that the volume of Fall busi-  
ness will be fair. According to *Bradstreet's*  
the clouds over the general business situation  
throughout the country have continued to  
break away through the second week in  
which an actual improvement has been  
recorded, as indicated by an increase  
in volume and distribution in merchan-  
dise reported at Cincinnati, Indianapolis,  
Chicago, St. Louis, Kansas City and  
Omaha. More travelers have been sent  
out from these and other points, and  
manufacturing industries there, as well  
as at large eastern centers, have in a num-  
ber of instances begun starting up, some  
without special orders. At cities other than

those specified, with few exceptions, there  
is an improvement in the feeling among  
merchants and bankers as to the prospects  
for Fall trade, and at all points with very  
few exceptions, there is a growth of con-  
fidence in a revival or demand during the  
Autumn months. As far as the jewelry trade  
is concerned the many new advertisements  
in this number of THE CIRCULAR necessi-  
tating the addition of another form to the  
standard number of pages, indicate that  
there is a disposition on the part of the  
trade to enter upon its Fall campaign with  
its usual vim and energy.

**Illegal Selling** AT length a move-  
ment has been  
inaugurated to stop  
the selling of trashy  
jewelry by "fakirs" at the World's Colum-  
bian Exposition. THE CIRCULAR has de-  
voted considerable space in its columns in a  
crusade against this illegitimate practice.  
As reported elsewhere in this issue Chief  
Allison has issued a letter to the commis-  
sioners of foreign countries calling upon  
them for assistance in the matter of ridding  
the Fair of this disgrace. While the action  
of Chief Allison is laudable in many regards,  
we were not aware that it was necessary for  
the exposition authorities to ask the co-  
operation of any one whatsoever to enforce  
obedience to the contracts entered into by  
foreigners and Americans alike, when the  
space was granted them at the opening of  
the Fair. The section of the contract re-  
garding sales is explicit and reads:

RULES. Special rules will be issued governing each  
department and the sale of articles within the build-  
ings or on the grounds, but no articles shall be sold  
for removal previous to the close of the Exposition  
unless a concession or privilege for the same has been  
granted by the Committee on Ways and Means.  
"Privileges" refer to the sale of such goods as are  
manufactured in order to illustrate a machine or pro-  
cess exhibited. "Concessions" refer to the sale of all  
goods and operation of attractions from which the  
securing of revenue is the sole object of the lessees.  
The removal of exhibits will not be permitted prior  
to the close of the Exposition.

We have not been informed that any ac-  
tion has been taken to amend this rule so  
far as it relates to sales. Foreign exhibitors  
have entered their goods as exhibits and  
then released them from bond and sold  
them as openly as Chicago stores; an Amer-  
ican exhibitor of low priced watches was  
ordered out of the Manufactures building for  
alleged selling of goods. If this be not  
discrimination, what is it? Mr. Allison  
states he has evidence in his office that will  
criminate certain parties. Out with it.  
Open the desk drawer and let the American  
people hear a tale of woe from a country  
farmer to the effect that he paid \$13 for three  
articles of jewelry in the French section  
thinking the "girls at home" should have  
something from the Fair and that it ought  
to be imported. Tell the public how he  
claims the goods were sold to him for solid  
gold set with amethysts, and how they  
proved to be brass and glass. Have the  
drawers opened, General Davis, but before

doing so shut up all the fakirs' stands,  
despite any protestation from those who  
may be interested in two score booths for  
the sale of cheap jewelry from Gablonz,  
Bohemia. Silence in matters "that will  
criminate" is little short of venality. Close  
up the fakirs' stands and those of exhibitors  
who make illegal sales. American exhibi-  
tors at all times are willing to live up to the  
rules and regulations when impartially  
administered.

## The Week in Brief.

THE death occurred of William W.  
Carter, of Bristol, Conn., at one time  
a clock manufacturer—A desperate jew-  
elry store burglar was captured in Caddo,  
I. T.—The death of Lorenz Kossbiel,  
Eric, Pa., occurred—E. A. Heeren, a jew-  
eler of Luring, Tex., was found dead in his  
room—The store of W. R. Bell, Chatta-  
nooga, Tenn., was damaged by fire—  
Heavy judgments were entered against  
Charles Bickelman, Schenectady, N. Y.—  
Joshua C. Goodale, Aurora, Ill., gave a bill  
of sale—The store of W. F. Kemper, St.  
Louis, Mo., was robbed by sneak thieves  
who were captured later—The jewelers of  
Indianapolis, Ind., decorated their stores in  
honor of the National G. A. R. encamp-  
ment—The North Attleboros tax assessors  
completed their work—The death occurred  
of W. A. Wilmarth, father of several jewel-  
ers of the Attleboros—Several factories  
which were shut down on account of the  
untoward commercial conditions started up  
—D. Ramsey Patterson, assignee of the  
old Keystone Standard Watch Co., Lan-  
caster, Pa., entered two heavy suits—  
News of a gigantic deal in diamonds was  
received from Kimberley, South Africa—  
Chief Allison, of the Manufactures Depart-  
ment of the World's Fair, issued a letter in  
protection of the confessional rights of B.  
F. Norris, Alister & Co., Chicago—The  
death occurred of Erhard Mauthe, Galves-  
ton, Tex.—World's Fair exhibitors were  
warned against having dealings with the  
United States Importing and Exporting Co.  
and T. J. Clendenning & Co., Philadelphia,  
Pa.—A sharp scheme was worked  
to force Edward H. Malliet, jeweler,  
Jersey City, N. J., to satisfy a judg-  
ment—A slight fire occurred in the  
store of F. A. Robbins, Pittsfield, Mass.—  
Heavy attachments were issued against the  
Green-Smith Watch & Diamond Co., Den-  
ver, Col.—Sam Levi, one of the pair who  
played the "gold dust" swindle upon  
Harris Rosenthal, Toronto, Can., was cap-  
tured—The window of the store of John  
Zelly, Eaton, O., was smashed by thieves.  
—Albert M. Rich, salesman for the J. R.  
White Jewelry Co., Troy, N. Y., confessed  
to embezzling goods from the firm—It is  
now positively thought that Bruce, the safe  
blower in jail in Terre Haute, Ind., was the  
assailant of W. G. Pollack, salesman for W.  
L. Pollack & Co., New York—The Apple-  
ton Clock Co., Appleton, Wis., organized

### New York Notes.

Cora L. Magnus has obtained a judgment for \$259.79 against Geo. W. Huesart.

L. Straus & Sons have obtained a judgment for \$1,808.08 against Leon Cottentin.

James A. Smith, of M. B. Bryant & Co., spent a short vacation in the Catskills last week.

Mark Cohn left Monday on a trip through Pennsylvania and Ohio for Max Freund & Co.

D. R. Corbin is visiting Chicago where he will remain until the close of the World's Fair.

The German-American Bank have obtained a judgment for \$2,334.38 against M. Fox & Co.

A judgment for \$481.80 has been entered against Samuel Eilprin, in favor of, Alois Kohn & Co.

The Jewelry Makers' Union has removed its headquarters from Walhalla Hall to 162 East Broadway.

P. A. Frasse & Co. have obtained a judgment for \$359.22 against the Equitable Mfg. & Electric Co.

A judgment for \$410.17 has been entered against R. H. Dana & Co., by the Price Flavoring Extract Co.

A judgment for \$5,572.13 has been entered by the Murray Hill Bank against Frederick J. Kaldenberg.

E. W. Beebe, assignee of Joseph C. Maigne, has obtained a judgment for \$140 against Jos. H. Schletzer.

A judgment against Edward F. Sanford and Wm. T. Coombs, for \$2,264.87, has been ordered by H. Vector.

An attachment for \$286.56 has been issued against A. and Victor Gold, jewelry peddlers, in favor of Morris Goldberg.

William E. Cohn, formerly with Roseman & Levy, has started in business as a manufacturer of diamond jewelry and mountings, at 14 John St.

A second payment will be made to the depositors of the National Bank of Deposit during this month. Twenty-five per cent is the amount to be paid.

Hays & Greenbaum, attorneys for C. Cottier & Son, state that a settlement with the creditors of that firm has been practically effected. The composition offer was 60 per cent.

Monroe Engelsman, of Peabody & Engelsman, left New York Friday, accompanied by Mr. Tas, of Amsterdam, Holland, and M. J. Lasar, of New York, to visit the World's Fair.

The sheriff's sale of the stock of the Attleboro Stock Co., 491 Broadway, took place Thursday. About \$3,500 was realized from the sale. The judgments against the firm aggregate \$4,352.

George Agassiz, of St. Imier, Switzerland, and his son, arrived in this city last week. They will visit Chicago and other

cities and will remain in the United States about two months.

Sam Stern, of Sam Stern & Co., leaves for Chicago and the World's Fair this week, and Benjamin Eichberg, of Eichberg & Co., returns from a three weeks' visit to the Fair within the next few days.

C. K. Giles, of Giles, Bro. & Co., Chicago, was in this city last week endeavoring to get the signatures of the few remaining creditors who have not signed the agreement to compromise at 25 per cent.

Taylor Bros., pawnbrokers and jewelers at Grand and Hester Sts., have given a bill of sale to Martin Simons. A judgment for \$1,414.10 has since been entered against them in favor of F. W. Mitchell.

Albert Lorsch & Co. have received no further information regarding the diamonds, valued at \$1,800, which were missing from a box of jewelry shipped to that firm on *La Normandie*, as told in *THE CIRCULAR* last week.

Julius Newwitter, a well-known retired merchant, who died last week at his residence, 234 E. 58th St., was the father of Morris J. Newwitter, of Newwitter & Rosenheim, manufacturing jewelers.

D. R. Corbin, manufacturer of jewelry, 10 Cortlandt St., has applied for space at the World's Fair Prize Winners' Exposition, to be held at the Grand Central Palace, 43d St. and Lexington Ave., during January next.

Robert Stoll, 10 John St., has made a handsome medal which will be presented by the *New York Times* to the athlete making the best individual performance at the World's Fair sports, to be held at Chicago next month.

A settlement with the creditors of Edward F. Sanford & Co., 14 John St., has been practically effected. William Zigler, a friend of Mr. Sanford, has bought up all the claims against the insolvents at 30 per cent., and the firm will immediately resume business as heretofore.

Louis Tas, one of the extensive diamond commission merchants in Amsterdam, has been in New York looking after his interests here. His headquarters are, at the office of Oppenheimer Bros. & Veith, 35 Maiden Lane. Mr. Tas left for Chicago Friday and returns to New York this week.

The motion for a commission to take testimony in Pittsburgh, Pa., to be introduced in the suit of the Duerber Watch Case Mfg. Co. against the Co-operating Manufacturers, is to be made in the New York Supreme Court, to-morrow, by the plaintiffs' attorneys.

Joseph C. Maigne, 419 Broadway, who assigned May 20th to E. W. Beebe, is attempting to effect a settlement with his creditors at 25 cents cash. Most of the creditors have already accepted the offer, and it is expected that the settlement will be consummated within a short time.

The store of the A. De Riesthal Co., dealers in fine china, art pottery and glassware, 55 Murray St., was taken charge of by the sheriff, Friday, on two executions; one for \$3,066, in favor of Wm. C. Bowers, on a demand note, and the other for \$6,143, in favor of Helene de Riesthal, who obtained judgment in Kings County.

When A. Teitz left his jewelry store at 82 Ave. B, at 1.30 o'clock Wednesday morning, he forgot to fasten the door, and went away leaving his store invitingly open. Luckily no loss resulted from the act as the fact that the door was open was discovered by a policeman before anything had been stolen.

Stex & L'Allemand, composed of Henry Stex and Ernest A. L'Allemand, manufacturers of silver plated ware, 73 Fulton street, dissolved partnership Thursday, Mr. Stex retiring. Mr. L'Allemand continues the business under his own name at the same address. The firm started five years ago, succeeding E. H. Rowley & Co.

Henry Abbott & Co. have consummated a settlement with their creditors, at 25 cents cash. The business will be removed from the Havemeyer building at Church and Cortlandt Sts., to 2 Maiden Lane, where Henry Abbott will resume business alone, Walter B. DeCamp, his former partner, having retired. The "Co." is dropped from the firm name.

The assignment of James Dixon, 323 8th Ave., on Aug. 18th, caused his appearance in the Yorkville Police Court, last week, to answer to the charge of stealing a watch left for repairs, which was preferred by Maggie Green, 424 W. 27th St. Dixon said that the watch had been turned over to his assignee with his other effects, and the assignee came into court later and returned Miss Green's property to her.

John S. Grey was held for examination, in Mount Vernon, N. Y., Thursday, upon a charge of blackmail, preferred by John A. Fletcher, of the Fletcher Watch & Jewelry Co., 182 Broadway. It is said that Grey wrote a letter to Mr. Fletcher threatening that unless the firm did certain things he would publish an account of the way the firm did business, and that he called them swindlers. Grey pleaded not guilty.

Simon Dessau returned to his office from St. Louis last week. In speaking of the lost black diamonds he said that the package has been returned intact and that the first reports that some stones were missing was owing to a mistake of his clerk in telegraphing the amount of goods the package originally contained. He attributes their recovery to the fact that to anyone but an expert the stones appeared worthless. Mr. Billings, the salesman who lost the diamonds, is no longer with him. The newspaper story that the whole matter was an advertising scheme he brands as totally untrue and a piece of sensational journalism.

Solid Silver  
Exclusively.



WHITING M'F'G CO.

SILVERSMITHS,

Broadway & 18th Street,

NEW YORK.

WORKS--AT FOURTH ST. AND LAFAYETTE PLACE.

### Philadelphia.

R. S. Milner, 4029 Lancaster Ave., will shortly visit the World's Fair.

Mr. and Mrs. Simon Pfaelzer have been visiting friends at Newport and Narragansett Pier.

Mr. and Mrs. Herman Diesinger left for Chicago on Saturday and will be absent for a couple of weeks.

S. J. Downes & Co., the West Philadelphia jewelers and opticians, have recently made some important alterations and improvements in their establishment, 4030 Market St.

Harry Logan was held without bail by Magistrate Pole, Wednesday last, on the charge of being implicated in the robbery of J. F. Bates' jewelry store, 3402 Market St.

A serious accident occurred at the establishment of Queen & Co., 1010 Chestnut St. on the 29th ult. J. A. O. Danby, a native of Venezuela, who had visited the place to make purchases, fell down an elevator shaft. His collar bone was broken and his leg fractured.

During the storm of last week a falling tree dashed against a traction trolley pole, which in turn fell against the residence of Fred. Lingg, the 8th St. jeweler, at 922 Pine St. The house was considerably damaged, and Mr. Lingg is about to bring suit against the Traction Company for damages.

E. Kretzmar, whose loss of a \$300 diamond through a thievish customer substituting a paste stone was recorded in last week's CIRCULAR, states in a published interview that he has been robbed of \$3,600 worth of diamonds in three years, that he is tired of notifying the police of his losses, and that he has abandoned all hope of receiving any return of his property through their vigilance or ability.

John H. Evans was held in \$600 bail by Magistrate Ladner, on Thursday last, charged with stealing three watches from the store of Frank Nottenberg, 608 N. Front St. Evans sneaked into the store while the family were at dinner, and got the watches out of the window. The proprietor saw him, but not in time to catch him. He was later arrested, however, from the description furnished by Mr. Nottenberg.

Another suspected jewelry thief has been captured. He says his name is Harry Sack, but a letter found on him from his wife was signed "H. C. Lesser," and dated from 426 52d St., New York city. He was

arrested on Thursday, and six pairs of gold spectacles were found in his possession. From the description of the goods stolen from Clark Bros.' store, the police believe they are part of the booty. The man has been committed for trial.

### Syracuse, N. Y.

C. L. Becker returned Monday from a three weeks' stay in the North Woods.

C. E. Eager has returned from a month's stay at Glen Oaks, on Skaneateles Lake.

George E. Wilkins returned Thursday from a stay at Chicago and Mt. Clemens, Mich.

C. S. Ball returned Wednesday from his vacation, spent at his cottage on Round Island, St. Lawrence River.

Tom Cheney, now with the Gorham Mfg. Co., has returned to New York, after spending his vacation at his old home in Syracuse.

A. Goldstein, who formerly conducted a repair shop at the corner of Madison and Mulberry Sts., is now with F. C. Meyers & Co., Cornwall, Ont., Canada.

### Springfield, Mass.

M. D. Fletcher has sold his house, at the corner of Mariner Ave. and Locust St., for \$6,500.

E. M. Dickinson, North Adams, has moved into the Miner residence on E. Main St.

Mr. Barker, J. W. Reddall & Co. and Mr. Jones, Larter, Elcox & Co., were in Springfield, last week.

There was a small blaze in Jeweler Robbins' store, Pittsfield, one evening last week, but little damage was done. The blaze was caused by the ignition of some oil which painters had left on the floor.

There is considerable competition among local jewelers for the pleasure of furnishing the \$4,000 worth of diamonds to be given as prizes in the coming bicycle tournament. Jeweler Hubbard has been awarded the contract for furnishing two handsome charms as prizes.

### Canada and the Provinces.

D. F. Didier, Three Rivers, Què., wishes to compromise with his creditors.

Mr. Knowles, jeweler, has opened business at Muisfail, Alberto, N. W. T.

The business of Kingham & Minor, Victoria, B. C., is being continued by J. Kingham & Co.

Mr. Shaw, watchmaker and jeweler of Souris, P. E. I., has fitted up a shop in Charlottetown and has opened with a full stock of goods.

Myer Moss, Jr., jeweler, Lunenburg, N. S., has taken up an additional line of business. He with Wm. Young, of that town, is about introducing an improved pneumatic tire for cycles and trotting vehicles.

Sam Levi, one of the pair who played the "gold dust" swindle upon Harris Rosenthal, of Toronto, as mentioned in last week's CIRCULAR was arrested a day or two after in Hamilton. He was brought to Toronto and committed for trial and afterwards let out on bail of \$400 for himself and two sureties of \$200 each.

### Detroit.

Edward Rochm has returned from a two weeks' trip on business and to see the World's Fair.

Martin Burk, head of F. G. Smith, Sons & Co's. watch department, has gone to the World's Fair.

Frank Robertsky and Frank Kelbe have been found guilty of robbing the jewelry store of Henry Baumann and sentenced to three months in the penitentiary.

A. M. Ward, foreman in the Johnston Optical Co.'s factory, has invented a facial meter, which was patented last week. The company will manufacture the device.

A tramp smashed the plate glass window in Shelk's jewelry store at Cheboygan last week, and stole three watches and some chains. He was caught at Pattersonville, and most of the property recovered.

The following Michigan country buyers were here last week: F. C. Barbour, Oxford; S. A. Cleveland, Utica; C. E. Montford, Utica, and George Chambers, Mt. Clemens. A large number of Canadian jewelers were in the city last week.

### Two Important Arrests Made in the City of Detroit.

DETROIT, Mich., Sept. 1.—The detectives of this city made two important arrests last Thursday night, in the persons of Eddie Mines of this city, and David Burke of Chicago. There is no definite charge against the prisoners yet, but they are suspected of being the two men, who, when Forepaugh's circus was parading at Lansing, Mich., went into Charles A. Piella's jewelry store, and while one attracted the proprietor's attention, the other stole \$1,000 worth of diamonds.

They answer the description of the thieves in almost every particular, and the police are positive they have the right people. Mr. Piella and Lansing officers are on their way to identify the prisoners.

## C. SYDNEY SMITH,

HAS REMOVED TO

191 BROADWAY,

New York.

FACTORY:  
PROVIDENCE, R. I.

Manufacturer of

GOLD CHAINS,  
LOCKETS AND CHARMS.

◆ THE ◆

# COLUMBUS-AMERICAN

## ❖ Souvenir Spoon. ❖



OBVERSE.



. MADE IN .

Plain or

Gilded

◆ BOWLS ◆

... ALSO ...

Enameled : Figures.



REVERSE.



TRADE MARK.

# GEO. W. SHIEBLER CO.,

179 BROADWAY, NEW YORK.

**BIG RETURNS MADE FOR OLD GOLD AND SILVER.**

Check Forwarded 24 Hours After Receipt of Consignment.

**RATHBONE & SMITH,**  
 GOLD AND SILVER REFINERS, ASSAYERS AND SWEEPSMELTERS,  
 Nos. 1 to 9 Matthewson St., Cor. Cove, Providence, R. I.

**Enterprising Jewelers Catch On!**



OBVERSE



REVERSE



BACK

**Jewish Sheckel, Masonic Mark or Pocket Piece.**  
 THE LATEST AND BEST SELLING NOVELTY.

The mark is struck in coin silver; by using either the obverse or reverse of the coin, the back being the same in either case, and permitting of the purchaser's name, blue lodge, chapter and individual mark, with date of same being engraved thereon, as shown in cut above.

Price, without engraving, ONE DOLLAR. Engraved Mark, Dates, etc., 75c. EXTRA.

Liberal Discount to the Trade.

**CHAS. G. WILLSON, MANUFACTURING JEWELER, READING PA.**

**A WORD ABOUT OPTICS.**

**D**ID you say you would like to make more money out of your Optical business? How are we to know it if you go on in the old-fashioned "Guess you have fitted them" plan? If you wish to know just how to fit them and do it in a correct and scientific manner, come to us. There is big money in it, and you can increase your business from six to ten times the amount by knowing how to do your work properly. There are more people who need glasses and do not know it than those that are already wearing them. Will you sit idly by and allow this trade to go elsewhere, or will you put yourself in a position to reap the reward? If the former, write to the SPENCER OPTICAL MFG. Co., 15 Maiden Lane, N. Y. City, for their circular, showing you what has been done and what can be done.

**The Warren**  
**Eye Protector**

(Patented Jan. 12, 1892, Feb. 21, 1893.)

Saves the Eyes From

**Dust, Wind, or Glaring Light.**

Folds in a Compact Case, is

Comfortable, Durable,  
 Water and Dust Proof.

Its large field does not obstruct the sight. No brittle substance to endanger face under sudden blows.

Oculists and Physicians Recommend it.

Travelers, Cyclists, Railroadmen,  
 Horsemen, Motormen, Quarrymen,  
 Pronounce it Indispensable for Man or Woman.

Ask your Dealer for it.

Colors, Clear, Smoke, Blue or Green. Black frames, 50c. Silver, 75c. Sent by mail on receipt of price. Manufactured solely by

**The Nous Verrons Company**

P. O. Box 3273, Boston, Mass.



**ALUMINUM SOLDER \$2.00 PER POUND.**

Instructions for using given gratis.

Practical Processes for Soldering,  
 Dipping, Enameling, Etching, &c,  
 of Aluminum.

**C. DE REDON, 43 WEST 21st ST., NEW YORK.**

**WM. BIRMINGHAM & CO.**

MANUFACTURERS OF

All Kinds of Leather Spectacle and Eye Glass

**CASES,**

728 Arch Street, PHILADELPHIA. PA.

DON'T FORGET the JEWELER'S CIRCULAR PUBLISHING CO.'S BOOK LIST when in want of any technical book in the Jewelry or Kindred Trades.

**R., L. & M. Friedlander,**



IMPORTERS OF  
**DIAMONDS.**

WHOLESALE  
**JEWELERS.**

JOBBER IN  
**American Watches.**

Tools, Materials, and Optical Goods.

Send for Catalogue.

65 & 67 Nassau Street, New York.

### CHICAGO OFFICE: 24 ADAMS STREET.

Handsome Display of High Class STERLING SILVER NOVELTIES, SPOONS, &c.

## BACHRACH & FREEDMAN,

13 CHARTERHOUSE STREET, LONDON.

1 & 3 UNION SQUARE, NEW YORK.



### "TIME IS MONEY"

SEND YOUR PRESCRIPTIONS AND REPAIR WORK WHERE IT IS DONE ACCURATELY WITHOUT DELAY.

**E. KIRSTEIN'S SONS CO.**

SEND FOR CATALOGUE. ROCHESTER, N.Y.

LATEST AND BEST

### ELK'S TOOTH BADGE.

CAN BE USED AS A CHARM BY SIMPLY DETACHING BAR FROM TOOTH.

Reverse shows the symbolic flower of the Ben- evolent and Protective Order of Elks, the forget-me-not, beautifully enam- eled in colors; also the letters B. P. O. E.

MANUFACTURED BY

**G. A. SCHLECHTER,**  
READING, PA.

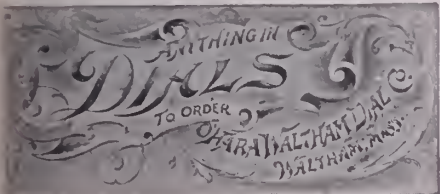
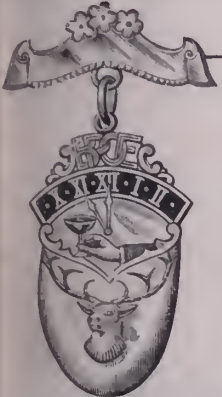

ESTABLISHED 1837

**GEO. O. STREET & SONS,**

MAKERS OF  
Fine Rings, Locketts, Seals,  
Sleeve Buttons and Links,

15 John Street, NEW YORK.

**Jules Jürgensen**

OF COPENHAGEN

The reputation these watches have maintained for Fifty Years has never been equalled, being made on strictly scientific principles and no expense spared to give the Best results in mechanism and timekeeping qualities

SOLE AGENTS.

**John C. Hyde's Sons,**  
NO. 22 MAIDEN LANE.

All the illustrations in this issue were made by

**W. H. BARTHOLOMEW.**

PHOTO-ENGRAVER,

8 SPRUCE ST., NEW YORK.

## ARTISTIC

## METAL

NEW DESIGNS,  
NEW FINISHES.

## GOODS.

Our line of Pitchers, Vases, Tables, Candle- sticks, Five O'Clock Teas, Etc., cannot be equaled.

### THE CELEBRATED

## "B & H" LAMP.

BEAUTIFUL DESIGNS,

particularly adapted to the Jewelry Trade.

SEE OUR LINE OF

### TABLE, BANQUET AND PIANO LAMPS

before placing your orders.

Send for our Little Book.



### BRADLEY & HUBBARD MFG. CO.

NEW YORK, BOSTON, CHICAGO,  
21 BARCLAY ST., 160 CONGRESS ST. 88 WABASH AVE.  
26 PARK PLACE. Factories, MERIDEN, CT.

## "THE BEST BUTTON MADE."

### THE KREMENTZ

IN GOLD

IN ROLLED PLATE

FROM

**KREMENTZ & CO.**

ONE PIECE

FROM

And all Jobbers.

ALL JOBBERS.



### COLLAR BUTTON.

IS THE ORIGINAL ONE PIECE BUTTON.

IS STILL THE BEST AND STILL UNSURPASSED.

### THE IMPROVED RIVAL FOUNTAIN PEN.

MOST RELIABLE AND GUARANTEED TO GIVE PERFECT SATISFACTION. OVER 75,000 IN USE.

Send for Price List.



Liberal Dis- counts to the Trade.

**D. W. BEAUMEL,**

Inventor and Manufacturer,  
REPAIRING A SPECIALTY,

17 John St., New York.

# BAUME & CO.,

21 HATTON GARDEN, LONDON, ENGLAND,  
AND SWITZERLAND.

EXHIBITORS AT CHICAGO OF 

## TOURBILLION CHRONOMETER WATCH,

WHICH HOLDS THE RECORD AT ROYAL OBSERVATORY KEW.

HIGH CLASS SWISS WATCHES, PLAIN AND COMPLICATED.

PATENTEES FOR SPLIT SECONDS CHRONOGRAPHS (Treble Action.)

AGENT FOR U. S., GEO. E. WILKINS, SYRACUSE, N. Y.



# GERMANY

SEEKS

AMERICAN TRADE,

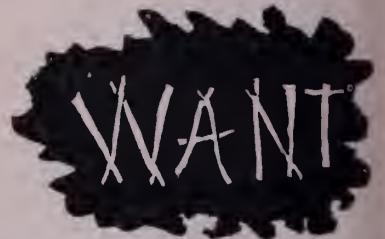

And for the purpose of securing it has for several years **STUDIED AMERICAN WANTS.** The German exhibit at the World's Fair contains a full line of jewelry, specially **SUITED TO YOUR NEEDS** and expressly made with a view to furthering the jewelry and silverware trade between the two countries. Mr. Richard Horstmann, under whose supervision and through whose efforts the consolidated German exhibits were secured to the Fair, represents the following lines:

**WATCHES.** { The celebrated patent watches of **DURRSTEIN & CO.'S UNION WORKS AT GLASHUTTE.** Among them movements held by bolts, and not by springs, insuring thinnest cases, split seconds, Chronometers, etc.  
**JEWELRY.** { Representative manufacturers of Pforzheim, Hanau and Gmeund. These cities are known worldwide for taste in designs and beauty of gold colorings and enamel work in all branches of the jewelry trade.  
**SILVERWARE.** { Reproductions of the best old German, Dutch and Rococo designs.

We can serve your best interests if you will but let us know your wants. Correspondence invited.

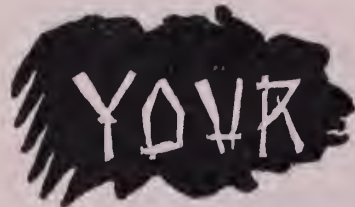

## RICHARD HORSTMANN,

VIENNA.

Seigmundgasse 15. Tel.-Adr.: PARATUS WIEN.

BERLIN, S. W.

Oranienstrasse 101 102. Tel.-Adr.: PARATUS BERLIN.

LONDON, E. C.

13 Charterhouse Street. Tel.-Adr.: WELLROOM LONDON



CHICAGO.—German Jewelry Exhibit, Manufactures Building, World's Fair.

GERMAN COURT OF HONOR.



# WORLD'S FAIR and WESTERN SUPPLEMENT of THE JEWELERS' CIRCULAR

CHICAGO OFFICE: ROOM 308, INTER-OCEAN BUILDING.

VOL. XXVII.

CHICAGO, WEDNESDAY, SEPTEMBER 6, 1893.

NO. 6.

## A FEATURE OF THE AUSTRIAN SECTION.

FOR thirty-one years Scheid has been high art in jewelry manufacture in Vienna, Austria. It was fitting then, as became the leading Austrian manufacturer that he should have received the position of honor in the Austrian section at the World's Fair, a position in the very center of the great Bohemian glass exhibit and the most advantageous it was in the power of the representatives of the Austrian government to give. Right worthily, too, has the firm accepted the opportunity to present to the American public the various high class wares for which it is noted. The attractive pavilion, herewith illustrated, is of ornamental iron and consists of four corner display towers connected by three low steel framed counter cases, which inclose three sides of an open court, the fourth being left as an entrance to the office in the center. The base is of ebony-black wood ornamented with lines of gold and the panels are covered with olive green velvet.

In the left front tower is displayed a fine line of hand carved silver novelties consisting

the name of G. A. Scheid, synonymous with

of animals for mantel ornaments, paper weights and a line of hand carved silver

fully in line with American ideas, is a silver statue of Chicago's "I Will" maiden. It is

a diminutive affair, but 2 inches in height, mounted on a square base of ebony. In execution it is a faithful portrayal even in the finest lines, of the original. Mirrors with silver frames, tortoise shell lorgnette handles and ivory paper cutters mounted with oxidized silver trimmings are also shown.

The right front tower is similar in arrangement. At the back are an eagle and a chamois perched upon masses of cut crystal. In the foreground a silver Cupid turns somersaults on a base of ivory. Smaller silver paper knives have handles of brilliant enamels terminating in oxidized silver work, representing Bartholdi's two statues, Liberty and Columbus. Ivory paper knives and cutters are exquisitely ornamented with gold open work scrolls and flower designs brightened by colored enamels.

Magnificent examples are shown of flowers and conventional designs in colored enamels on silver gilt, and small photo frames are displayed in variety. A beautiful enameled jew-



THE PAVILION OF G. A. SCHEID AT THE WORLD'S FAIR.

largely of animals and figures of medals several times. At the back are larger figures

figures mounted on ebony bases. A small piece, notable as showing that the house is

eled case has the cover and sides paneled with hand painted enamels and borders

**THE PLANCHAMP & BECKER CO.**

Makers and Repairers of

**WATCH CASES,**

Gold and Silver Plating —

— of Watch Cases a Specialty.

UNEXCELLED FACILITIES.

63 and 65 East Washington St., Chicago.

**PARSONS : SCHOOL**

— FOR —

**WATCHMAKERS,**

PEORIA, - - - ILL.

Send for Circular and Terms.

**PARSONS & CO.**

**CHICAGO WATCH TOOL CO.**  
SPECIAL MACHINES  
MANUFACTURERS OF  
JEWELERS' MACHINERY  
WATCH MAKERS'  
and  
JEWELERS' TOOLS  
Etc.  
TOOLS MADE TO ORDER  
52 MADISON STREET  
CHICAGO

of fine hand carved silver, oxidized and gilt. Bonbon boxes are shown in etched and enameled lines. Small wares in enamel and silver gilt are very pretty, and cut glass bottles with enameled silver tops are rich.

Card cases, match boxes and cigarette cases fill the entire front case, showing a great variety of designs in carved and enamel work, among them being some handsome Watteau paintings surrounded by rococo borders. Green and red transparent enamels on silver are shown in all their brilliancy. A pretty case is of blue enamel with markings of silver to represent alligator skin. Enameled azure spoons are shown in many handsome patterns, in translucent designs and on silver backs. Mr. Scheid is the largest manufacturer in Vienna of high quality transparent enamel spoons, and makes only high grade goods in this line.

An entire case is devoted to these goods. Many of the spoons have been made expressly for America, New York, Chicago, Philadelphia, Buffalo and other cities having symbolic spoons. A fine spoon with the eagle and shield of the United States in gold in the center of the bowl has above this a blue enamel with the names of vari-

ous American cities inset in gold. The point of the bowl is of green transparent enamel and the handle is of colored enamel vine and flowers inlaid in white on silver gilt.

Beautiful enamels are shown in diminutive clocks, vignette frames, and champagne glasses with tracery of silver gilt and enamel. Tortoise shell hair ornaments with transparent enamels are among the beautiful wares shown that have largely interested American ladies. There is an exceedingly choice line of enamels in butterfly pins in which the tints rival prismatic colors in their brilliancy. A number are enameled on silver and then painted on the enamel, giving a peculiar attractiveness in colors obtainable by no other method. The appointment of G. A. Scheid to the jury of awards for silverware and jewelry at the Fair is a high distinction and removes the firm from competition of award. Thomas Dotzler is in charge of the World's Fair exhibit.

Joseph Hirst, secretary of installation at the Fair, and one of the most efficient workers, is seriously ill from heart trouble, and is not expected to recover.

The Swiss jury, having completed the work assigned them, left for home the past week. Mr. Rouge, of the jury, and Mr. Hoffer, official delegate, left Thursday, and Mr. Tissot, of the jury, on Saturday. The party will stop a week at Niagara Falls en route east.

**IRONS & RUSSELL,**

(SUCCESSORS TO CHARLES F. IRONS.)

MANUFACTURERS OF

**SOLID GOLD EMBLEMS ROLL PLATE**

PINS, CHARMS AND SOLID GOLD RINGS.

102 Friendship Street, - - - Providence, R. I.



# Finest Enamels in America.

While you are visiting the World's Columbian Exposition call and examine closely our lines of

**Transparent Enamel Wares and Silver Fancy Goods.**

**THE FINEST LINES EVER SHOWN IN AMERICA.**

They will be found in the very center of the Austrian Exhibit, in Manufactures Building.

**TRADE RESPECTFULLY INVITED TO CALL.**

**G. A. SCHEID, VI. GUMPENDORFERSTRASSE 85, AUSTRIA.**

New York, G. Cramer, Kauffeld & Co., 457 and 459 Broome Street.

CHICAGO, AUSTRIAN SECTION, WORLD'S FAIR.

# REMARKABLE WORLD'S FAIR EXHIBIT

OF

## MUSICAL BOXES.

### JACOT & SON, 298 BROADWAY, NEW YORK.

From THE JEWELERS' CIRCULAR, August 30, 1893.

THE old truism that music hath charms to soothe the savage breast may account for the gentle manners of W. A. Sambalino, and gentleness is an essential requisite in the performance of his duty, inasmuch as he is called upon to answer thousands of questions each day. This gentleman is the representative of the American house of Jacot & Son, 298 Broadway, New York, and is in charge of the World's Fair exhibit of the celebrated music box manufacturers, in the Swiss section, at the south end of Manufactures building.

The entire rear wall of the section for a distance of fifty feet is banked deep with these marvelous musical creations. The exhibit is displayed on a raised velvet carpeted platform, at the front of which are arranged the larger boxes. The center is given up to carved musical sideboards, cabinets, chairs, etc., and on each side of

which special attention is directed, are all cased in American woods which, being adapted to the climate, enables the firm to guarantee that they will not warp or split. Oak and mahogany, both plain and carved are the principal woods shown. While the guarantee against warping and splitting of case is of marked advantage, it is a minor consideration when compared to the many recent improvements shown in mechanism, improvements which insure the most musical sound, the greatest durability and remarkable ease of manipulation.

The Jacot & Son music boxes are the only ones made by American machinery of their own invention and a special point is made that no box was ever guaranteed, no matter how fine it might have been until the Jacot patent safety check which prevents the running of the cylinder was introduced. Another difficulty formerly experi-

and where needed. All the pins are turned by hand so that when they touch the teeth they glide off instead of striking and grating off as in cheaper boxes. All these various parts being made by American machinery they can be changed from one box to another. No old style parts are now used.

The gem of the exhibit is a "Soprano" with cylinder 3½ inches in diameter which plays a full hour at each winding and is the largest interchangeable box ever made. The case is of carved oak 44 inches long and rests on a handsome carved table. The front panel bears a light colored lyre and scroll on a darker etched background. Another musical wonder is a combination box valued at \$1,475. There are six cylinder combinations in one box, comprising barytone, soprano, quatuor, sublime harmony, piccolo, and sublime harmony tremulo, and they play thirty-six tunes. Additional cyl-



THE NOTABLE EXHIBIT OF JACOT & SON AT THE WORLD'S FAIR.

these, occupying the rear half of the platform, are tables filled with the medium sized instruments. The smaller boxes rest on shelves still higher up, the whole forming a solid bank over six feet in height by fifty feet long. Above the boxes is a drapery effect formed of scores of cylinders, the smallest in the center and graduated outward to 2½ inch cylinders at the ends.

Surmounting the exhibit are two huge paintings of the City of Geneva and the Jungfrau, crowned by the Swiss colors. In the center the firm's name is flanked by Swiss carved frames around the inscription in gilt letters on black velvet background, "Ideal music boxes. Peerless music boxes." At the right of the exhibit is a frame of first prize medals, obtained wherever the firm have exhibited since the Exposition of Berne, in 1848. The "Ideal" boxes, to

enced with boxes arose from complicated mechanisms, easily put out of order, and generating too much noise. These difficulties are obviated by the ball bearing noiseless winder, by which the operator may unwind the spring by simply touching a small lever. The indicator and tune skipper on old styles were separate; now an indicator and tune skipper combined will allow of changing either backward or forward and cannot be set in the middle of a tune; consequently each tune is in itself perfect.

An improvement for placing in of the cylinder consists of a spring that throws the cylinder into its true place as soon as it is set in the box. There are no clamps or levers and changes can be made instantly. The horizontal fly wheel has the advantage over the perpendicular in that it gives a better distribution of oil and places it when

inders can be furnished. The box and table are finely inlaid with brass, bronze and German silver in conventional designs, with the edge of the table, table legs and corners of the box heavily ornamented with brass. That the Jacot is without a competitor is ably proven by a glance at the following improvements:

1. Tune skipper, changing tune at will.
2. Indicator showing tune it plays.
3. Speed regulator, moving cylinder slow or fast.
4. Double springs, playing double length of time of ordinary music box.
5. Compensating fan, so that it will play at same speed whether full wound or partly run down.
6. Ball-bearing, noiseless winder.
7. Jacot's patent safety check.
8. Horizontal fly wheel.

The firm carry in stock at all times all the best known tunes and make any special piece to order. In the World's Fair exhibit all sizes and a wide range of pieces are shown, from the smaller mahogany to the exquisitely carved oak soprano, which good judges of music admit is the finest toned box they ever heard.

The graining and mottled designs in woodwork form the chief feature of case ornamentation and the line shown gives evidence of an unequalled selection from the choicest markings of American wood. Mr. Sambalino paid the following high tribute to jewelers: "The finest class of boxes are handled by jewelers and it is easier for the smallest jeweler to sell a \$400 box than it is for a drygoods or department store to sell one for \$150. There is nothing too nice for the jewelry trade."—*Adv.*

**THE BEST  
PIVOT DRILLS IN THE WORLD.**

One Gross without charge for proof that this is not so.

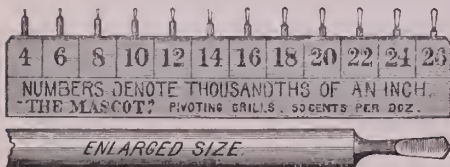

The Mascot, 50 Cents per doz.

By all Jobbers, or sent post-paid on receipt of price.

**Ezra F. Bowman & Co.,  
LANCASTER, PA.**



61 Hanover Street, Boston, Mass.

Sales made for Jewelers only in their established places of business. Can give best references of any auctioneers in America.

All communications strictly confidential.

**REED & BARTON,  
SILVERSMITHS,**

MANUFACTURERS OF

**STERLING and SILVER PLATED  
SILVER WARE.**

SALESROOMS:

**37 Union Square, New York.**

34-36 WASHINGTON STREET,

**Venetian Building, Chicago.**

FACTORIES, CAUNTON, MASS.

**MARTIN MAYER,  
Manufacturing Jeweler,  
(MAINZ, Germany,)**

FACTORIES: MAINZ, PFORZHEIM, FLORENCE, (ITALY).

Original Manufacturer of the well-known Cut Silver Articles.

*Silver Filigree, Coral Goods, Garnets, Turquoise, Pearl, and all other kinds of Jewelry. Silver Bric-a-Brac in Every Style, Silver Fancy Clocks, Souvenir Spoons.*

FIRST HAND FOR EUROPEAN NOVELTIES IN THE JEWELRY LINE.

SPECIAL EXHIBIT AT WORLD'S FAIR, CHICAGO.

New York Office, with L. Maynz, 523 Broadway, New York.

**BLANCARD & CO.,**

LATEST ROCOCO DESIGN IN GALLERY.



DIAMOND SETTINGS. GALLERIES. HOLLOW BALLS, ETC.

SEND FOR OUR CATALOGUE.

**45 & 47 John St., New York.**

## HOROLOGY AT THE WORLD'S FAIR.

PART XII.—EXHIBITS OF THE WATCH MANUFACTURERS OF SWITZERLAND, OUTSIDE GENEVA.

**G**INDRAT-DELACHAUX, Chaux-de-Fonds, display a full line of 16, 17 and 18 line watches, but their specialty is calendar watches showing the day, month and phases of the moon through mortises in the dials. In the fifty-two watches shown are a few chronometer escapements of medium grade. This firm succeeded Kocher, Hanni & Kunzli, since the World's Fair opened.

Ch. Coulerou-Meuri, Chaux-de-Fonds, exhibits 38 calendar watches with highly decorated dials that attract a large measure of attention. They are medium priced, the majority being cased in silver and oxidized steel. With three exceptions they are 18 line, the exceptions being 36 line. There is here a blind man's watch. In the numerals designating the hours is a protruding pin. As the hour is reached the pin drops, the owner locating the hour by means of the missing pin. It has a nickel dial and but one hand, an hour hand sunk in the dial.

Wiell & Co., Chaux-de-Fonds, have thirty-seven sweep and split seconds on exhibition. A new feature is the showing of seven different times on one dial—those of Chicago, London Paris, Washington, Calcutta, San Francisco and St. Petersburg. This is accomplished by having seven small dials, about the size of a seconds space, on one full dial.

P. Brunner Gabus, Locle, a jewel maker, exhibits a movement showing what a jeweler can do with jewels in watch manufacture. In the movement shown fifty-six jewels are set in all positions and give a beautiful effect.

Jeanneret & Frères, St. Imier, have all kinds of watches, from the smallest to the largest. There is a fine line of chronometers in sixteen size, and in cases are used gold, silver, niello and steel in various forms of decoration. There are four complicated calendar paper weights. A handsomely chased case bears on its front the coat of arms of the United States in colored enamel. Gold and silver in clever combinations are shown, and an oxidized silver case with gold lions rampant, bearing between them a shield, is an attractive piece.

Arthur Graizely, La Ferriere, exhibits a great line of eight-day watches. There are seventy-two pieces, each eight-day and complicated, in all styles and sizes. All the dials are cut to show exposed balance. There are also twelve crystal ball paper-weight watches of all sizes. These eight-day watches are here exhibited for the first time at any exposition and are the special novelty presented.

Wuillenmier Frères, Renan, show watches that are wound by the motion of walking. The mechanism is similar to that introduced into watchmaking by H. Von der Heydt, of Chicago. A lever with hammer head at the end acts as a ratchet and does the winding. A light spring throws back the hammer, but allows the least motion to operate it. A man must walk fifteen minutes a day to keep it wound. Among scientific instruments shown by this firm are a measuring dial for map drawers which indicates the measurement of distance on a map, and cyclometers

for bicycles and other vehicles. The self winding watches are shown in large variety in gold and silver cases.

Fritz Chatelain, Neuchatel, has pedometers and step markers. His pedometers have a patent regulating wheel and record the exact distance traversed by walking. The new step marker also measures the distance walked, by recording the number of steps taken. Both are carried in the vest pocket and are useful in their places.

Albert Didisheim & Frères, St. Imier, show gold and silver cased 18-line movements with a few 14 and 16-line. In the center is an open faced silver perpetual calendar and a few chronometers.

Droz & Co., St. Imier, have both large and small sized watches as chronometers and plain. The firm received silver medals at Paris 1878, National Exposition of Watch-makers, at Chaux-de-Fonds 1881, Amsterdam, 1883, Antwerp 1885 and Paris 1889.

Jeanneret & Kocher, whose exhibit was but recently installed, show complicated watches of all kinds, chime and minute repeaters, perpetual calendars, chronographs and chronometers with observatory certificate. Among the watches exhibited are a 20 line minute repeater chiming every  $\frac{1}{4}$  hour, perpetual calendar and chronograph; a 20 line lever chronometer escapement, bascule; a 20 line minute repeater; 20 line and 19 line lever; a 14 line minute repeater chiming every  $\frac{1}{4}$  hour, the only watch of the kind exhibited; a 20 line repeater with automatons.

# ALBERT H. BONNET,

ONLY EXCLUSIVE WHOLESALE JEWELRY HOUSE IN OHIO.

COLUMBUS, WALTHAM, ELGIN, HOWARD AND STANDARD WATCHES,  
GOLD AND FILLED CASES, JEWELRY, CHAINS, CLOCKS.

FULL LINE OF TOOLS AND MATERIALS.

No. 24 E. SPRING STREET,

COLUMBUS, OHIO.

## JUERGENS & ANDERSEN COMPANY,

DIAMONDS AND MOUNTINGS,

Order Work a Specialty.

125-127 State St., Chicago.

# Geneva Optical Company.

Our new catalogue giving new prices, new goods and a full line of Optical Outfits, Trial Cases, Lens Measures, Prism Measures and all kinds of Optical Goods now ready, and sent at request.

WE ILLUSTRATE BELOW A FEW OF OUR NEW SPECIALTIES.



### COMPLETE SET TRIAL LENSES.

No. 995. Contains 32 pairs+(convex) spherical, .25 to .20D; 32 pairs (concave) spherical .25 to .20D; 20 pairs+(convex) cylinders, .25 to .650D; 20 pairs-(concave) cylinder .25 to .650D; 10 prisms; 4 pairs, plain colored lens; 1 white glass; 1 half-ground disc; 2 stenoptics; 1 solid and 2 discs with small hole: discs of hard rubber.

Rims on all the lenses, nicked on the convex, gilded on concave.

Graduated trial frame No. 915. Plain trial frame No. 919. All in well made morocco case, lined with velvet.

This case for accuracy, we are willing to have compared with any either of foreign or American manufacture.

The exceptionally low price, must not be taken to indicate its quality, as that must be judged by the case itself. Price \$59.00.

Special offer 10 and 6 off, net Cash \$50.00.

### OUR PRESCRIPTION WORK

is now the most accurately and promptly done. Try a month and see.

### DIRECTIONS TO USE THE PRISM MEASURE AND LENS CENTERING INSTRUMENT.

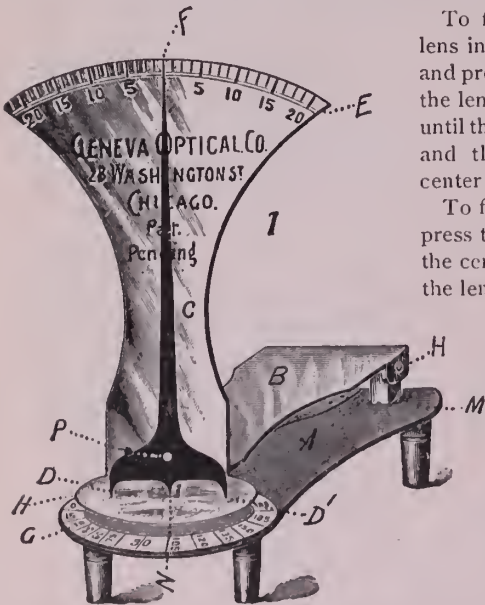

To find the center of a lens, put the lens in as shown in illustration at "H," and press the points "DD" down firmly on the lens, sliding it across the instrument until the index finger "F" points to "O" and the center point will be over the center of the lens.

To find the amount of prism in a lens, press the points "DD" firmly down with the center point "N" over the center of the lens. The index finger will point to the degree indicating strength of prism either plain or in combination with spherical or cylindrical surfaces.

To cut a spherical or cylindrical lens to get any required degree of prism, find the points in the lens, where the index finger will indicate the degree of prism required, and cut the lens with its center at the point

under the center points of index finger. Price \$5 00.



### THE GENEVA LENS MEASURE IMPROVED.

"You press the lens, it tells the focus."  
For full description see catalogue.

Price \$10.00.

67 & 69 Washington Street, Chicago, Ill.

## The Exhibits of the Geneva Optical Co.

FROM the heavy iron-bowed, hinged temple spectacles of Colonial times, with their large circular glasses with parallel surfaces, to the modern spectacles as presented to the visitor at the World's Fair in the exhibit of the Geneva Optical Co., great progress in optical science is marked. Great as the strides have been in spectacles and eye glass making, the recent years have produced far greater results in scientific optics as relate to the determination and correction of errors of vision with mathematical exactness by means of recently improved instruments.

In these improvements the exhibit of the Geneva Optical Co. is particularly rich. Along the west side of the company's 252 square feet in the gallery of Manufactures and Liberal Arts building are large upright exhibition cases; at the front and rear are counter cases, and on the east wall are displayed astigmatic diagrams, test types, and photos of the factories.

A fine line of trial cases occupies the major portion of the larger cases, among them the firm's "specialists' " set. This is most complete and consists of 40 pairs each of spherical convex and concave lenses, from .25D to 20.D; 24 pairs each of cylindrical convex and concave lenses, from .25D to 8.; 15 single prisms, from 1/2 degrees to 20 degrees; 8 plane colored lenses, 1 opaque glass disc, 1 half opaque glass disc, 2 stenoptic discs, 2 pin-hole discs, 1 solid disc, 1 muscle test, 1 chromatic test, 1 bar of prisms, from 1/2 degrees to 5 degrees. The lenses are mounted in finely finished spring-tempered rims, nicked on convex, gilded on concave. There are also an improved graduated and a plain frame and the cases are arranged to hold the improved Geneva lens measure, ophthalmoscope, etc., if desired. The complete set (No. 995) of trial lenses of this firm will compare for accuracy with any of either American or foreign make, and for quality with any case made except their own 9c4 1/2, and all this at an exceptionally low price.

In instruments for the ready detection of myopia, hypermetropia and astigmatism, in all their forms, a new eye piece has recently been added to the prisoptometer, which is a decided improvement. This eye piece will readily detect the error of refraction, and determine the correcting lens.

A recent invention that has received merited praise from the specialists who have examined the instrument is Brayton's optomyometer for determining the tendency to deviation in the ocular muscles. It readily determines the weakness of muscles of rotation and enables the specialist to promptly ascertain the correcting prism. It is also useful in exercising the ocular muscles.

The improved Geneva lens measure, also an invention of Mr. Brayton, is the only instrument of its kind manufactured, the Geneva Optical Co. holding the original

patent. The principle of the lens measure as constructed is to have two fixed points touching the lens, and a movable point between the two fixed ones that shall have a spring motion below to allow its being depressed when a lens is pressed on the three points, until the lens comes up solid against the fixed points. The three points will then be on the arc of a circle giving the curvature of that lens. This movement, by suitable mechanism, is communicated to a hand, which passes over a dial gauge to indicate the refraction of that surface of the lens. The convenience and accuracy of the little instrument has brought it at once into use in all parts of the world and specialists from all sections have written their congratulations on the invention.

tains four panels, 24 inches long, sliding upward, which are operated from the table at which the patient sits. The table has drawers divided, to hold spectacle frames and other necessary articles.

The Ridgeway chromatic test for errors of refraction, and Ridgeway's muscle test, and Maddox's double prism, to diagnose muscle insufficiency, are also manufactured by the Geneva Optical Co., and exhibited by them. In ophthalmoscopes a very complete line is shown, including the improved Loring, with rectangular mirror, giving seventy-five combinations of lenses. It is stated on authority that the Geneva Optical Co. are the only American exhibitors in the Manufactures building displaying spectacles and eye glass frames of their own manufacture.



PAVILION IN MANUFACTURES BUILDING OF THE GENEVA OPTICAL CO.

An invention that excites the curiosity and admiration of opticians visiting the exhibit is a compound lens and prism measure which analyzes the power of lenses and gives at one and the same operation the power of each surface, the axes of cylinders and the degree of the prism. On the lower dial it gives the power of the resultant prism when two or more prisms are employed with axes crossing, the power being figured out mechanically. Professor Wm. Harkness, of the Naval Observatory, spent an hour in a close examination of this instrument and many foreign professors and men of science have been deeply interested.

The company show the most complete line of test types and astigmatic diagrams ever published. In connection with these is shown a test type cabinet in practical operation. This is 24 inches wide by 35 inches high, made of paneled hard wood. It con-

Among other scientific instruments exhibited are three different styles of photomicrographe for enlarging or diminishing microscope specimens, the invention of Professor W. H. Walmsley; the Aladdin camera, "the best magazine camera in the market," and the celebrated Parvin telephoto lens, which takes a picture nearly six-fold larger than the rapid rectilinear from the same standpoint.

J. T. Brayton is chief in charge of the entire World's Fair exhibit of the company and is ably assisted in the Liberal Arts section by W. L. Nason. The various exhibits of the Geneva Optical Co. in Machinery Hall, the Ethnological building and the English and French sections will be treated of in a subsequent article. The factories of the company are at Geneva, N. Y., and the principal offices and salesrooms at 67-69 Washington St., Chicago.

### Three Thousand Dollar Toilet Set.

IN the Mappin Bros. \$3,000 toilet set exhibited in the pavilion of the Goldsmiths' and Silversmiths' Co., of London the firm present artistically modeled pieces of silverwork. Art in silver is always beautiful, the beauty oftentimes being enhanced by the simpler decorative effects. There is nothing of the striving after effectiveness in the pieces under consideration, but a chasteness in detail, made prominent by its very simplicity.

The set comprises forty-seven pieces, as follows: Table mirrors, oval and round hand mirrors, square and round pin trays, two cut glass cologne bottles, curling set, two trinket boxes, covered pin box for assorted sizes, brush and comb tray, face brush, bonnet whisk pomade jar, glove stretcher, shoe horn, shoe buttoner, two combs, and a manicure set of seventeen pieces. In the tray are a jewel casket, two puff boxes, two hair and two clothes brushes, a heart shaped box for odds and ends, two candlesticks and a tray 8 x 12 inches.

The design is in Mappin Bros.' registered Louis XVI. style, and is executed in richly hand chased solid silver, heavily gilt. All the details are carefully executed, and the design, with its polished shield in the center and repoussé scroll work, solidly covering each article in bold relief, is most attractive. The pieces are mounted in an elegant Russia leather case, with cushions of light green velvet, the lid being lined with gathered white satin. They are exhibited in an upright plate glass case. The set is one of the special features of the exhibit of the Goldsmiths' and Silversmiths' Co.

### Strudelsteinware and Mosaics.

"THE greatest novelty of the Exposition," is what Arthur Fischer, representing Philipp Fischer, Karlsbad,

says of the latter's strudelsteinware and mosaic exhibit in the Austrian section of the Mines building. The display is in the northwest corner of the building and consists of inlaid and mosaic Karlsbad stone in boxes of plaulescenta wood, a dark brown wood, inlaid with silver.



LADIES' TOILET SET OF 47 PIECES.

Visitors to Karlsbad need no introduction to the various colorings of the strudelstein; all colors are shown, but brown shades predominate. The stone is a mineral from the surcharged waters of the springs, is deposited, and petrifies.

Some handsome jewelry caskets are displayed with silver frames and sides and cover solid with stones in mosaic of various colors and markings. There is jewelry of all kinds to which stone is applicable, minute

stones inlaid in the metal and in raised mountings forming a handsome line of everything carried by jewelers. The reasonableness of the price is likely to make the goods well known in this country.

### Gold Incrustation on Steel.

THE art of incrusting gold on steel is most beautifully set forth in the exhibit of Felipa Guisasola, Madrid, in the Spanish section of the Manufactures building. Gold is applied in raised designs on a black steel background, and the effect can best be described as resembling engraved work in design. Where engraving is done on ordinary articles, it is here applied in raised gold, and hand engraved after application, the polished or plain surfaces on ordinary engraved goods being represented by black steel in the incrustated warcs.

The steel in color is a blue black and is oxidized in appearance. Watch cases and all descriptions of jewelry are shown in hundreds of pretty designs. In the foreground are two remarkable vases. One is in Renaissance style with pure gold incrustation on black steel. It stands over 4 feet high with exquisite designs in gold of eight different colorings and is valued at \$40,000. The other is a Greek style Amphora vase 6 feet in height of the same materials, and is valued at \$20,000. These vases are claimed to be the only two originals in the world and are designed for the center of a drawing room or museum.

Various designs of vases from 6 to 12 inches in height are shown in the jewelry case.

All this beautiful work is that of a woman Mrs. Felipa Guisasola, of Madrid.

Fogg doesn't consider himself absent-minded, but he did catch himself the other day before the mirror taking off his glasses to see how he looked in them. — *Boston Transcript*.

DIAMONDS WATCHES BHA JEWELRY MANUFACTURING

**LAPP AND FLERSHEM** Chicago, Ill.

92, 94, 96 & 98 STATE ST. COR. WASHINGTON

**THE LARGEST SUPPLY DEPOT**

*For Everything Needed by Jewelers.*

ILLUSTRATED CATALOGUES FURNISHED JEWELERS

SPECIAL FACILITIES FOR FILLING ORDERS NO RETAILING!

STERLING & SILVER PLATE BHA OPTICAL GOODS

STOOLS & MATERIALS



## Chicago.

Sightseers in Chicago and at the World's Columbian Exposition last week included :

A. McHenry & Co., Hornellsville, N. Y.; Charles H. Winter, Minneapolis, Minn.; J. A. Shomaker, Vork, Pa.; T. Dryden, Spring Hill, Kan.; S. M. Ladd & Co., Morrison, Ill.; Smith & Flower, Fond du Lac, Wis.; J. R. Baylers, Waukon, Ia.; E. F. Hirst, Richmond, Ind.; C. G. Johnson, Denison, O.; E. L. Park, Essex, Ont.; Geo. Logemann, Jr., Milwaukee, Wis.; Alfred Moser, Dayton, O.; George R. Caspari, Louisville, Ky.; Robert S. Weaver, Miamisburg, O.; Andrew Humio, Cumana, Venezuela; E. D. Beardsley, Harvard Ill.; Chas. F. Artes, Evansville, Ind.; N. J. Fellows, Portage, Wis.; Julius A. Oswald, Nashville, Tenn.; Gleason & Co., Grand Rapids, Mich.; F. O. Hannan, Unionport, O.; Herman Lemp, Covington, Ind.; Mr. Bohle, St. Louis, Mo.; George W. Plinke, Louisville, Ky.; Bessessen & Steen, Albert Lea, Minn.; Fred J. Thomas, Cairo, Ill.; W. J. Sarver, Allegheny, Pa.; Fred Halter, St. Louis, Mo.; Emile F. Renaud, Keokuk, Ia.; Arthur Rifenborgh, Brooklyn, N. Y.; Ben Guider, Vicksburg, Miss.; L. S. Grimm, Lebanon, Kan.; Will H. Torrance, Monmouth, Ill.; T. Henry McClure, Nashville, Tenn.; Ferguson & Page, St. John, N. B.; George W. Reid, Mt. Vernon, Ill.; Gotthelf & Voellinger, Vicksburg, Miss.; Ph. Zuellner, Portsmouth, O.; C. Forstner, New Orleans, La.; L. Lilienthal, New York; Dan. I. Murray, Dayton, O.; Wm. Barthman, Jr., New York; L. Hartman & Co., Titin, O.; C. W. Freeman, Scranton, Pa.; Geo. Huwald, Lake View, Ill.; Geo. D. Wiegmann, Newark, N. J.; L. Luchtemeyer, Blue Island, Ill.; Moses Strauss, St. Louis, Mo.; C. P. Hedenstad, Albert Lea, Minn.; J. F. Fruhling, Salt Lake, Utah; L. M. Bassett & Son, Coldwater, Mich.; Edward R. Koehn, Detroit, Mich.; A. C. Hailey, Harrison, Ark.; C. L. Griswold, Blue Island, Ill.; M. C. Motch, Covington, Ky.; D. J. Treat, Decatur, Mich.; Orlando Bacon, North Vernon, Ind.; A. F. Larson, Gd. Rapids, Mich.; C. E. Riddeford, New Milford, Conn.; A. Wilton, Alexandria, Minn.; Franz Bernhardt, Butler, Mo.; John E. Bayles, Plainfield, Ill.; G. H. McKelvey, St. Joseph, Mo.; H. T. Fisher, Blair, Neb.; E. A. Johnson, Rome, Ga.; W. T. Knox & Bro., Social Circle, Ga.; L. W. Sturdevant, Newark, O.; W. R. Haselwood, Bardwell, Ky.; Horace J. Brown, Columbus, Kan.; David S. Gribben, Indianapolis, Ind.; D. P. Richards, Columbia, Mo.; S. L. Rowe, Milford, Mich.; P. H. Knapp, Belleville, Ill.; F. P. Berwick, Racine, Wis.; W. R. Abbott, Decatur, Ill.; Rud. H. Krischker, Philadelphia, Pa.; Isaac O. Harrell, Greenville, Tenn.; H. G. Schramm, New York; L. W. Sweni, West Liberty, Ia.; John F. Vork, Greensboro, N. C.; Chas. Neubert, Kansas City, Mo.; Wm. C. Crossman, Auburn, N. V.; H. J. Bassett, Coldwater, Mich.; Heller & Sangel, Berlin, Can.; Louis Reichenberg, Omaha, Neb.; S. Bakkers, Roseland, Ill.; A. M. Lovell, Riverdale, Ill.; S. Heyfield, Selma, Ala.; Emerson Allen, Denver, Col.; N. L. Hope, with C. H. Case, Hartford, Conn.; Geo. M. Winchester, New York; A. K. Philles, Alexis, Ill.; Henry Fox, Cincinnati, O.; F. W. Bromberg, Mobile, Ala.; F. A. Fiedler, Milton, Pa.; S. D. Cook, Denver, Col.; Maurice Weil, New York; Alf. Hurlbert, Philadelphia; C. A. Kreich, Quincy, Ill.; W. Jones, Middletown, N. Y.; O. J. J. Werley, Middletown, N. V.; C. Victor Craigen, Washington, D. C.; T. S. Brown, Kearney, Wis.; J. H. Williams, Macon, Ga.; F. C. Ries, Macon, Ga.; Thomas H. Lord, San Francisco, Cal.; M. Jacobs, Washington, D. C.; W. A. Wortman, Canton, O.; J. D. Wyman, St. Albans, Vt.; Chas. A. Uhl, Evansville, Ind.; Fred Hollander, Ludington, Mich.; R. Lippman, Bradford, Pa.; A. W. Coney, Batavia, Ill.; L. W. Nichols, Samonau, Ill.; Albert Van Buskirk, Cleveland, O.; Jesse M. Poe, Rushville, Ind.; G. T. Sadtler & Sons, Baltimore, Md.; J. W. Brown, Ortonville, Minn.; T. A. Haney, Lyons, Kan.; J. Ramser & Son, Rock Island, Ill.; Shores & Travis, Saybrook, Ill.; R. J. Schaefer, with R. Fuelleman, Milwaukee, Wis.; Visanska & Garfunkel, Columbia, S. C.; Marwell & Olwin, Albion, Ill.; W. D. Sproesser, Watertown, Wis.; Traub Bros., Detroit, Mich.; N. Salzman, Galveston, Tex.; A. A. Bush, Hickory Corners, Mich.; Henry A. Voight, Baltimore, Md.; N. B. Levy, Scranton, Pa.; H. B. Mason & Co., Washington, D. C.; W. H. Wright

wife and daughter, Binghamton, N. Y.; J. H. Whitlock, Eufaula, Ala.; John B. Whitlock, Eufaula, Ala.; E. E. Trim, La Porte City, Ia.; Norman Clark, Sterling, Ill.; E. Curtis, Downers Grove, Ill.; W. F. A. Woodcock, Winona, Minn.; Wm. Hooper, Leadville, Col.; M. Meckes, Cleveland, O.; Frank C. Worrell, Minneapolis; J. E. Gelleland, New Cambria, Mo.; Will & Stark, Albany, Ore.; John M. Ackerman, Navasota, Tex.; A. Braun, Baltimore, Md.; Alexander Morris, Philadelphia, Pa.; Ed. A. Waite, Claire, Mich.; J. H. Hardick, Fairport, N. Y.; Joe Leighton, St. Charles, Ill.; Harry Livingston, Winona, Minn.; J. Currie Gregory, F. G. S., C. E., London; A. Peabody, New York; Burt Jones, Stuart, Ia.; M. J. Smith and wife, Pittsburgh, Pa.; M. Marks, Lawrence, Kan.; Fredk. Dalzell, New York; L. & B. Meyon, Buffalo, N. Y.; Arthur Freedman, Denver, Col.; Jenkins & Son, Warsaw, Ind.; Frank S. Shaw, Toledo, Ia.; Edward Otting, Cincinnati, O.; A. F. King, Buffalo, N. Y.; A. C. Hathaway, Elizabeth City, N. C.; W. F. Trewin, Philadelphia, Pa.; E. F. Hirst, Richmond, Ind.; Charles Carey, Swartz Creek, Mich.; Wm. D. Ogden, Franklin, N. V.; I. J. Rosenthal, New York; S. M. Kitzmiller, Waynesboro, Pa.; K. G. Skortum, Lake Benton, Minn.; R. C. Houghton, Fort Scott, Kan.; A. M. Bigelow, Marquette, Mich.; Peterson Bros., Plymouth, Wis.; J. E. Reagan, Indianapolis, Ind.; J. M. Thrasher, Barrington, Ill.; F. Maxwell, Albion, Ill.; Sam. C. Ladd, Morrison, Ill.; E. Weinzierl, Ely, Minn.; Harry Stom, St. Joseph, Mich.; W. S. Dapps, St. Paul, Minn.; W. E. Fiezenbaum, Oregon, Mo.; J. H. Kemis, Silver City, Mo.; C. E. Ryan, Baraboo, Wis.; H. Strouse, McGregor, Ia.; Mr. Richards, Richards & Park, Colorado, Tex.; M. A. Hagen, Fargo, Dak.; C. W. Davey, Hamburg, Ia.; H. C. Korfhage, Kenosha, Wis.; W. F. Poole, St. Anne, Ill.; E. M. House, Clinton, Ia.

The following were guests of the Chicago Jewelers' Association during the past week:

Mr. and Mrs. Wm. T. Flomerfeh, New York; Albert Miller, Monroe, Wis.; R. E. Brackett, Jr., Lansing, Mich.; Muta U. Swiger, Shinnston, W. Va.; S. D.

Cook, Denver, Col.; J. P. Gleason, and wife, Grand Rapids, Mich.; W. H. S. Wetherby, Clyde, N. V.; F. Topliiff, St. Paul, Minn.; S. L. Rowe, Milford, Mich.; H. Strouse, McGregor, Ia.; Frank Muhr, Philadelphia; J. E. Lockwood, Chariton, Ia.; A. C. Hailey, Harrison, Ark.; Arnold Huber, Paris, Tex.; Geo. Young, Jr., Bellevue Ia.; M. B. Kiester, Bellevue, Ia.; J. W. Talbot, Nevada, Mo.; B. F. Jetter, Butler, Mo.; C. G. Harris, Niles, Mich.; J. W. Watson, Providence, R. I.; A. B. Hull, Hastings, Minn.; Geo. Wenzel, Georgetown, S. C.; A. M. Biglow, Marquette, Mich.; O. W. Heineman, Philadelphia; Horace J. Brown, Columbus, Kan.; C. H. Winter, Minneapolis, Minn.; Geo. M. Geer, Providence; W. A. Sheaffer, Bloomfield, Ia.; Cl. Zailler & Son, Portsmouth, O.; Frank D. Day, Duluth, Minn.; A. F. King, Buffalo, N. V.; M. J. Smit, Pittsburgh, Pa.; Mrs. K. Smit, Pittsburgh, Pa.; E. M. Smit, Pittsburgh, Pa.; Ed. W. Bohle, St. Louis, Mo.; A. Dannenhaus, St. Louis, Mo.; John S. Barnard, Whitby, Ont.; E. F. Strickland, Benton Harbor, Mich.; J. P. Parrott, West Union, Ia.; L. W. Nimschke, New York; Fred. Hulter, St. Louis, Mo.; Henry J. Rosenstihl, Union Springs, Ala.; A. W. Ford, Freeport, Ill.; P. G. Burkhardt, Jefferson City, Mo.; R. D. Carstins, Grand Rapids, Mich.; S. Lindenberg, Cincinnati, O.; N. B. Barton, Providence, R. I.; Samuel A. Otis, Providence, R. I.; Orin M. Otis, Providence, R. I.; R. Cowles, New York.

Geo. N. Rouse, traveler for the Geneva Optical Co., is laid up at the Marquette Hotel with a severely sprained ankle.

Frank Huntley, formerly of Cadillac, Mich., has moved to Chicago and is looking for a good location for a retail jewelry store.

F. B. Tiffany, M.D., Kansas City, Mo., arrived in Chicago Thursday. Mr. Tiffany is writing a very complete work on optics which will be in press the present month.

## RECEIVER'S SALE.



ENTIRE Stock of **Giles, Bro. & Co.** Fourth Floor Masonic Temple, consisting of Diamonds, American and Swiss Watches, Jewelry, Silver and Plated Ware, Tools, Materials, etc. will be sold in lots to suit the purchasers, at large reduction from original cost price.

An unusual chance for live Jewelers to obtain bargains.

W. H. GLEASON, Receiver.

July 14th, 1893.

Walter Davis, factory superintendent for the Ansonia Clock Co., is visiting the Fair with his family.

Joseph Schweizer, superintendent for the Ansonia Clock Co., has engaged rooms in Chicago for the present week.

E. E. Bausch, of E. E. Bausch & Son, opticians, Rochester, N. Y., spent the past week in the city visiting the Fair.

All the Gorham Mfg. Co.'s travelers are out. W. S. Willis, W. H. Burton and T. G. Jewett represent the Chicago house.

Sam A. Otis, of Harvey & Otis, and family and Orin M. Otis and family, of Providence, R. I., are all making merry at the Fair.

Z. E. Chambers, with B. F. Norris, Alister & Co., left for the west the first of the month, with two trunks of the "handsome line ever carried on the road."

Richard Horstmann, in charge of the consolidated German jewelry and silverware exhibit, has increased his working forces in the person of Otto Vaihinger, of Pforzheim, who will assist Mr. Bek.

W. T. Nicholson, president of the Nicholson File Co., came to the Fair with his wife and daughter, intending to remain a week. Six weeks have elapsed and Mr. Nicholson and family are yet with us.

Charles Binns, of Worcester, England, gave an illustrated lecture on Royal Wor-

cester ware and decoration, early in the week at the Atheneum, under the auspices of the Columbian Ceramic Society.

Charles F. Carpenter, M.D., Louisville, Ky., United States commissioner to Vienna in 1873, and a juror on instruments of precision, is a new member on the jury on horology at the World's Columbian Exposition.

A. H. Vorster, who has represented the cut glass department of L. Strauss & Sons at the Fair since its opening, has returned to New York to look after his Fall trade. G. F. Wade succeeds to the position vacated by Mr. Vorster.

H. M. Lane, manager in this city for Reed & Barton, has been confined to his home the entire month of August by a complication of illnesses. He is improving and will resume his duties the coming week. E. A. Reed, traveler, will have charge of the office until Mr. Lane's recovery.

Secretary Frederick Correll, Jr., of the Retail Watchmakers' and Jewelers' Association of Illinois, is working in the interest of the association among the Chicago trade, looking for new members, collecting dues, and explaining plan and scope of work done and to be done. On the completion of city work Mr. Correll will canvass the country towns of the State.

Lyman & Co., etchers and engravers, 96 State St., have opened a school for etching

in connection with their regular business. Mr. Lyman, of the firm, has devoted ten years to this particular line and the instruction given is thorough and most useful to every jeweler. Those attending the Fair will there be enabled to combine business with pleasure and receive individual instructions from one of the leading etchers of the country.

While staying at the house of C. E. Hornberger, at Providence, R. I., Mrs. Maude Helene Sparrow, wife of W. S. Sparrow, manager of the Chicago office of Stern Bros. & Co., in a moment of nervous prostration, Aug. 16th, dropped her four-year-old daughter Edith, from a second story window and then plunged after her. Both fell on the top of a bay window several feet below. The child was badly, but not seriously injured, and is now recovering nicely. Mrs. Sparrow when taken into the house showed no mark whatever, but was confined to her bed from the shock and died a week later. The doctor gave a certificate of death from natural causes. She leaves two girls, one aged four years, the other seven months. Mr. and Mrs. Sparrow had been married five years and lived at 6144 Sheridan Ave., this city.

**Cincinnati.**

Jos. Goesling goes to Chicago again this week.

D. Schroder is on the road, and meeting encouragement from his customers.

Rube Hawkins, of C. Hellebush, started out last week with elegant samples.

A. G. Schwab and wife and Mrs. M. Schwab are at the World's Fair this week.

Philip Blanc and daughter, of Henderson, Ky., were guests of friends in Cincinnati last week.

The jewelers give better reports of trade this week. The travelers continue to send in small orders.

The assignee of Strauss & Stern has sold the desperate claims belonging to the estate to Bernard Ottinger, for \$800.

The Braham Jewelry Co., capital stock \$10,000, have been incorporated, for the purpose of dealing in watches, diamonds, etc., by Harry L. Braham, Daniel J. Sugarman, Helen Braham, Philip Joseph and Godfrey Joseph.

The rumor that Duhme & Co. had settled with their eastern creditors at fifty cents on the dollar is untrue. Mr. Ankeny is anxious to refute this rumor, and says he would be glad at any time to make such an easy settlement, but the firm have not been pushed.

**St. Louis.**

Ed. Boehmer has entirely recovered from the effects of his fall at the jewelers' picnic.

Julius G. Friton, of Friton Bros., 326 Market St., and son of Julius Friton, is to be married on Sept. 6th to Miss Anna Castlehuhn, daughter of Mr. and Mrs. C. Castlehuhn, at the home of the bride's parents, 2646 Geyer Ave.

**ETCHING TAUGHT FOR \$10.**

Having received numerous requests for our formulas in silver etching, we have decided to give individual instruction to those desiring to do their own work and save delay and shipping expenses. Jewelers can take advantage of this offer while visiting the Fair. Printed formulae and practical instruction in their use will be given where time is limited. Refer to any jewelry firm in Chicago. All kinds of etching done for the trade.

**LYMAN & CO.,** ETCHERS AND ENGRAVERS, 96 State Street, Chicago.

ONE OF THE BEST OF THE VERY BEST.

QUALITY IS THE STANDARD OF VALUE.

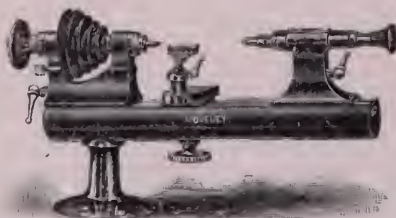

MEN INTERESTED WRITE YOUR JOBBER OR

**MOSELEY & CO., - - ELCIN, ILL.**



HAS LENGTH, STRENGTH, ACCURACY.



**GIBSON HOUSE.**

CINCINNATI, OHIO. ABSOLUTELY FIRST-CLASS AMERICAN PLAN HOTEL. \$3.00 PER DAY

Extra Charge for Parlors and Rooms with Bath attached. The unequalled advantages in central location, liberal management, modern appointments, experienced service and perfect cuisine, have permanently established the Gibson House as **The Most Popular First-Class Hotel in Cincinnati.**

AMPLE VAULTS FOR THE PROTECTION OF VALUABLES

**THE GIBSON HOUSE CO.**

H. B. DUNBAR. President and Manager

**Pacific Coast Notes.**

J. W. Stanton is a new jeweler at Escondido, Cal.

Hoyt Bros., Forest Grove, Ore., will open a branch store in Monmouth, same State.

J. M. Seamans, Friday Harbor, Wash., is reported to have removed to Seattle, Wash.

Robert Brown has leased a portion of A. J. Show's dry goods store, Petaluma, Cal., and opened up a watch repairing business.

In a destructive fire in Winlock, Wash., a few days ago, the jewelry and cigar store of Whistler & Phillips, was damaged to the extent of \$1,000; insurance, \$500.

The Occidental Jewelry Co., San Francisco, entrusted \$500 worth of diamonds to Antoine Schwabacker to sell on commission. The firm have had the agent arrested, charging him with embezzlement.

The Reynolds Jewelry Co., Providence, R. I., now exhibiting at the World's Fair, have made application for space in the California Mid-Winter International Exposition, San Francisco. The Wilkins Jewelry Co. have also applied for space for an exhibit of Pacific Ocean shells.

Arthur Rhodes, jeweler, Napa, Cal., met with quite a serious accident a few days ago. He had just opened his store, and was in the act of rising from a stooping position when a large glass door fell, striking him on the head. He was badly cut, an artery being severed in his forehead.

A Palermo, Cal., paper says: "A report was published in several papers last week to the effect that Harry Jacoby, the Oroville jeweler was about to make an assignment. We have since learned from Mr. Jacoby, personally, there was no truth whatever connected with it, and that on the contrary business with him is as prosperous as ever."

The store of Reed & Malcolm, dealers in optical goods, Portland, Ore., was burglarized between 4.35 and 5.30 o'clock on the morning of Aug. 21st. The plate glass window was smashed near the sash. Through the hole thus made the burglar thrust his hand and gathered in three dozen pairs of spectacles, pocket compasses and artificial eyes, all of which were valued at \$200.

**Minneapolis and St. Paul.**

I. B. Miller, Chicago, is visiting the Twin Cities, combining business with pleasure.

C. W. Davies, Minneapolis, has removed from 36 S. 5th St. to more commodious quarters at 520 Nicollet Ave.

Joe Aicher, formerly of Spaulding & Aicher, Minneapolis, is arranging to go south for the coming Winter.

Simon Meyer, assignee of Max Olenick, Minneapolis, last week sold the stock of jewelry on hand to M. L. Olenick, a brother of Max.

I. O. Brown & Bro., Appleton, Minn., have notified the Minneapolis jobbers that they have opened a branch store at Bellingham, Minn.

Ed. Fessler, St. Paul, has gone to his home at Fort Dodge, Ia., where he contemplates opening a jewelry store in the near future.

Eustis Bros., Minneapolis, and John Pfister, St. Paul, are advertising a twenty-five per cent. discount reduction sale on all goods in stock.

M. C. Fish, representing the Kent & Stanley Co., Providence, R. I. called on the Twin Cities dealers the past week, showing a fine line of chains.

The St. Paul Jewelry Co., St. Paul, have purchased the safes and office fixtures from F. M. Sproehle & Co., Chicago, recently used in their branch store in this city.

The assignee of Wm. C. Leber, Minneapolis, has been given an order of the court allowing him to accept a bid of \$1,600 for the total assets. B. Leber, a brother of W. C. Leber, made the bid which was accepted.

E. B. Meyrowitz, optician, Minneapolis, will soon remove from his present quarters at 42 S. 4th St., to the corner of Nicollet Ave. and 6th St., into the new Medical building. He will occupy the store next the corner, on 6th St.

The assignee of Harry F. Legg, Minneapolis, last week petitioned the court for an order allowing him to carry on the business and to receive goods on consignment, to thereby enable him to pay a larger dividend

to creditors when the settlement is effected.

George Greenleaf, manufacturing jeweler and engraver, Minneapolis, has sold out his tools and machinery to his former workman, J. Ellingboe, who has opened a shop at 45 Washington Ave. S. Mr. Greenleaf has opened an office at the corner of 4th St. and Hennepin Ave., where he intends to do only engraving for the trade.

**DALE CHUCKS.** 

Manufactured by  
**HOROLOGICAL TOOL CO.,**  
86 N. CLARK STREET,  
CHICAGO.  
For Sale by all Jobbers

**EST. 1870. DR. PETER HENRY,**  
SPECIALIST IN  
**WATCH • CASE • DISEASES**

Key Winders changed to Stem Winders.  
Hunting Cases changed to O. F.  
English Cases changed to fit American movements  
Can be cured at **53**  
**Longworth St.,**  
Cincinnati, Ohio.

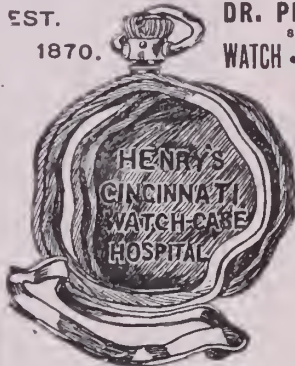

**ENGEL'S IMPROVED PATENT RING GAUGE.** Ask your Jobber for Them.

ENGEL'S RING GAUGE PAT. SEPT. 23. 90 PAT. SEPT. 1. 91 1 2 3 4 5 6 7 8 9 10 11 12 13  
A.W. ENGEL M'FG. CHICAGO U.S.A.

USED BY ALL BY MAIL SAMPLE 15 CENTS. PRICE PER DOZEN, \$1.25

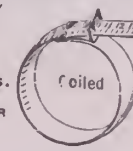
 THE DEVICE BEING MADE OF DURABLE FLEXIBLE MATERIAL IN A STRAIGHT TAPE, IS ADAPTED TO BE SENT THROUGH THE MAIL.

25 DIFFERENT SIZES ALL IN ONE. SIZES CORRESPOND TO ANY STANDARD RING GAUGE.

SPACE FOR NAME AND ADDRESS WHICH WE PLACE ON LARGE QUANTITIES FREE OF CHARGE. WRITE FOR QUANTITY PRICE EXCELLENT ADVERTISING MEDIUM.

**A. W. ENGEL,** { Manufacturer, Jobber and Watchmaker for the Trade } 115 Dearborn Street, CHICAGO, ILL.

**"Old English"**

Coffee Spoon.



**Towle Mfg. Co.,**

MANUFACTURERS OF  
**STERLING SILVERWARE.**

NEWBURYPORT: No. 214 Merrimack St. CHICAGO: Nos. 149 & 151 State St.

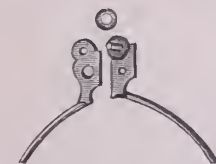

**Racine Jewelry Mfg. CO.,**  
**SPECTACLE TEMPLE WASHERS,**  
Gross in a Bottle, 25c.  
For Sale by Dealers in Jobbing Materials

**JEWELERS.**

We guarantee to sell you Sterling Silver Flat Ware at a less price than any other manufacturer, and give you newer designs. We will increase your profits if you will let us. Is it not worth trying?

**OVAITT & WARNER, Silversmiths,**  
PORTLAND, OREGON.

ESTABLISHED 1879.

**G. W. HOOK,**

**MANUFACTURING JEWELER,**

149 and 151 State Street,

Chicago, Ill.

INSPECTION BY THE VISITING TRADE INVITED.

# ROGERS, SMITH & CO.

UNION SQUARE,  
NEW YORK.

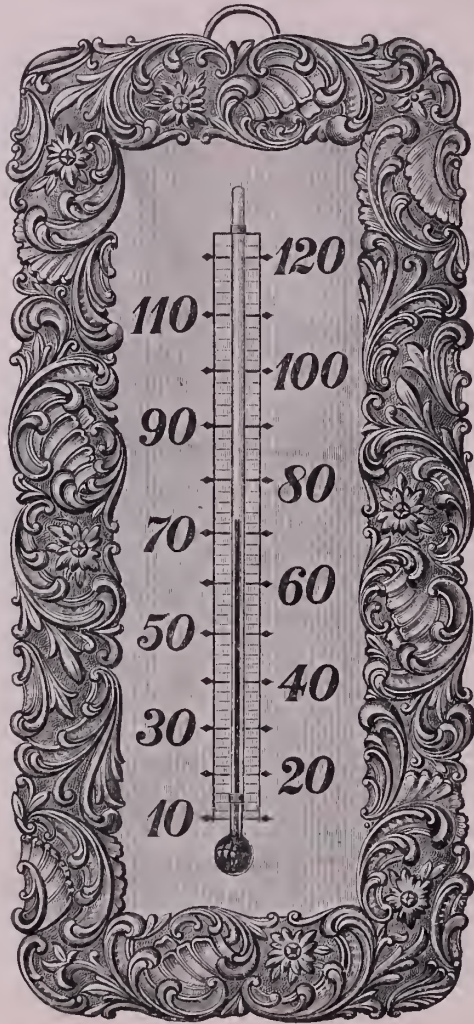

MERIDEN,

CONN.

~ BEST QUALITY ~

## GOLD AND SILVER PLATE.



### MUELLER'S ARTIFICIAL EYES.

\$75 per hundred; smaller lots, \$110 per dozen; \$2 each. A large assortment of eyes will be sent to any dealer to enable him to make selection, upon receipt of satisfactory references. We carry the largest stock in America.

ONLY MANUFACTURERS OF THE "DIAMANTA" SPECTACLES AND EYE-GLASSES. Oculists' prescriptions promptly and accurately filled. Catalogue, price lists, test cards, etc., on application.

M. ZINEMAN & BRO., American Agents, 130 South Ninth St., Philadelphia.

## WATERMAN & LEHMANN,

MANUFACTURERS OF

### DIAMOND JEWELRY

AND DEALERS IN

### DIAMONDS,

No. 37 MAIDEN LANE,

NEW YORK.

### B. F. Norris, Alister & Co. to be Protected in their Concession.

CHICAGO, Ill., Sept. 1.—The evil of selling trashy jewelry on "fakir" stands at the Exposition is in a fair way of being abolished. In a letter sent to the commissioners of foreign countries represented at the Fair, Chief Allison, of the Manufactures Department, calls upon them for assistance in the matter of ridding the Exposition of this disgrace and intimates that prompt action will be taken to enforce the instructions of Director-General Davis. What these instructions were is not stated, but it is to be inferred that General Davis is the party the jewelry trade must look to for redress of the evil complained of. The following is Chief Allison's letter:

DEAR SIR:—I desire to call your attention to the fact that the sale of Columbian Souvenir Spoons by others than those holding a permit from the proper authorities for such concession and sale, is positively forbidden, and I am instructed by the Director-General of the Exposition to effect such measures as will immediately prevent this traffic. I have, therefore, notified the parties who have been reported to me as making such sales, to stop it at once, or the stands will be closed and their passes to the Exposition revoked.

I desire also to call your especial attention to the traffic in the various sections that has grown to such proportions as to make it the source of very grievous annoyance to this department and the purchasers, i. e.: the sale of very trivial and inferior jewelry and other small articles, which are misrepresented to the purchaser, and which in no manner can be classed as exhibits. I have evidence in my office that will criminate the parties making such sales, and reflects no credit on the commissioners or countries in whose sections they are to be found and offered for sale. I, therefore, in the most cordial spirit, ask that you will at once institute such measures as will assist me in carrying out my instructions from the Director-General, and avoid unnecessary trouble.

Very respectfully yours,

(Sgd.)

JAMES ALLISON,

Chief, Department of Manufactures.

The protection of B. F. Norris, Alister & Co.; as concessionaires, is just and proper though somewhat tardy; but it is safe to say that no American exhibitor violated his contract with the Exposition until he had personally known of its being violated with impunity by foreigners.]

The taking of orders for future delivery cannot be stopped, and the Exposition authorities have no desire to interfere with such sales. It would be a serious matter to attempt it; but the sale and delivery of goods should be effectually stopped. The unlicensed sale of articles at the Fair is discreditable to the management.

### World's Fair Exhibitors Warned Against this "Company."

CHICAGO, Ill., Aug. 31.—A warning comes from Philadelphia, that under no circumstances should World's Fair exhibitors consign goods to the United States Importing and Exporting Co., nor to Nos. 1306, 1308, 1310 Filbert St., Philadelphia, nor have any dealings with a so-called firm of brokers styled T. J. Clendenning & Co., 17 S. Juniper St., same city. They are one and the same concern, and it has developed into one of the biggest frauds of later days.

The following letters give the *modus operandi* of the Philadelphia firm:

THE UNITED STATES IMPORTING AND EXPORTING Co., 1306, 1308, 1310 FILBERT STREET, AND 1305, 1307, 1309 SILVER STREET, PHILADELPHIA, PA., U. S. A., July 28, 1893.

Mr. H. Heymann, Danzig, Germany.

Dear Sir.—Enclosed please find letter of credit for one thousand dollars. We wish you to send us immediately one thousand dollars worth of "Ornaments, etc., of amber." We will leave all details as to selection to you; shall expect your very best cash prices; if goods prove satisfactory you will hear from us often. Hope you will ship without delay.

Please send us in advance samples of the shipment immediately.

Respectfully,  
U. S. IMP. & EXP. CO.

The enclosed letter of credit reads as follows:

OFFICE OF T. J. CLENDENNING & Co., BANKERS AND BROKERS, PHILADELPHIA, JULY 22, 1893.  
Mr. H. Heymann, Danzig, Germany.

Dear Sir:—We will be responsible to the amount of one thousand dollars for goods purchased by The United States Importing and Exporting Co., of Philadelphia, in case of their non-payment.

Yours truly,  
T. J. CLENDENNING & Co.

Brown, Heymann & Co., formerly the Brown Amber Mfg. Co., are the American representatives of H. Heymann, Danzig, Germany. The letter was forwarded to Mr. Brown at the World's Fair exhibit of the company. Mr. Brown, however, was suspicious, and wrote to a Philadelphia friend requesting a telegram if all was satisfactory. The goods will not be shipped.

**A Sharp Scheme to Make Jeweler Malliet Satisfy a Judgment.**

JERSEY CITY, N. J., Aug. 30.—Several months ago Clapp & Co. obtained judgment against Edward H. Malliet, jeweler, 47 Montgomery St. The creditors tried hard to levy on something, and then Lawyer Dougherty thought of a sharp move. Arthur Archibald and Dennis Ryan, two young men in his office, purchased each a diamond ring at \$225, to be paid for on the installment plan. They paid \$5 down. The next day these rings were levied on, in behalf of Clapp & Co.

When Mr. Malliet demanded further payment on the rings, Ryan and Archibald refused to pay, saying that they no longer held possession of the rings, as they had been seized by Clapp & Co., to satisfy their claim. Mr. Malliet brought an action in tort against Ryan and Archibald, but to-day District Court Judge Puster decided in favor of the two men, and Mr. Malliet will not be able to get either his money or the rings.

**The Death of Erhard Mauthe.**

GALVESTON, Tex., Aug. 30.—Erhard Mauthe, the well known watchmaker and jeweler, on the corner of Broadway and Center St., died at his home a few days ago. The deceased was sixty-seven years of age, and had lived in Galveston since 1871. He had many friends, who will deeply regret to learn of his demise. He leaves a sorrowing wife.

Clyde Mitchell has opened a new jewelry store in Findlay, O.

**WALTHAM REPEATERS**  
STRIKING HOURS AND MINUTES.

TO THE TRADE:—

Having purchased the entire remaining stock of WALTHAM REPEATING MOVEMENTS from the American Waltham Watch Co., and cased them in 20 year 14k. Cases, I am prepared to sell them at prices 30 per cent. less than they have ever been offered before.

Artistic Special Catalogue Free.

Send for Prices and Terms.

**JOHN B. YATES,**

21 & 23 MAIDEN LANE, NEW YORK.

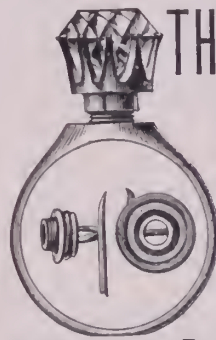

**THE BONNER COMBINATION**

RING, SCARF PIN AND STUD.

The Best Combination ever made.

MANUFACTURED BY

**BONNER, RICH & Co.,**  
Makers of DIAMOND MOUNTINGS  
RINGS A SPECIALTY.



To the Jobbing Trade Only.

41 MAIDEN LANE, NEW YORK,  
Factory, 44, 46 and 48 Hill St., Newark, N. J.



**KETCHAM & McDOUGAL,**  
MANUFACTURERS  
GOLD & SILVER THIMBLES,  
GOLD COLLAR BUTTONS,  
AUTOMATIC EYE-GLASS HOLDERS,  
198 BROADWAY N. Y.

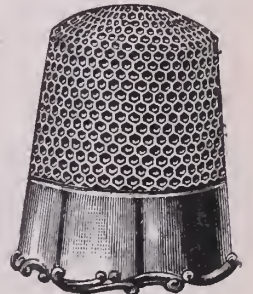

**Welded Chrome Steel and Iron**

5 PLY



FOR BUILDING

Jewelers' Safes, Vaults, Etc.

Positively BURGLAR PROOF, cannot be Cut, Sawed or Drilled.

WE are the only manufacturers of Chrome Steel in the United States. None genuine unless stamped with our Trade Mark.

**CHROME STEEL WORKS,**

KENT AVENUE, KEAP AND HOOPER STREETS, BROOKLYN, N. Y.



**Aikin Lambert Jewelry Co.**  
 Importers of  
**Diamonds**  
 Jobbers in **WATCHES**  
 Jewelry Chains etc.  
*New York*

19 Maiden Lane.

JAMES C. AIKIN, Pres.  
 JOHN B. SHEA V-Pres

SAM'L B. MANN. Treas.  
 FRED. D. ILGEN, Sec'y



**NEW ! IMPROVED NEW !**  
 Adjustable "Eclipse" Eye Glasses.

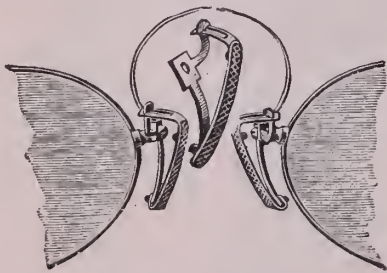

PATENT APPLIED FOR.

We claim this invention to be the only one which combines the advantages of both the adjustable and offset guards. We will furnish these frames or guards by Sept. 1st, in either Zylonite or Cork.

WRITE FOR CIRCULAR,  
 JOHN SCHEIDIG & CO., SOLE AGENTS  
 43 MAIDEN LANE, NEW YORK.

**HENRY GOLL & CO.,**  
 17 JOHN ST., NEW YORK.



SPECIAL CASES  
 MADE TO  
 ORDER  
 AND  
 REPAIRING IN  
 ALL ITS  
 BRANCHES.

**Rich Cut Glass**

AND

**DECORATED ART WARES.**



**Mt. Washington Glass Co.,**

**New Bedford, Mass.**

RICH DISPLAY OF GOODS AT

**New York Store: 46 Murray St.**

When you visit Chicago do not fail to inspect our full line of goods at the new store of Pairpoint Mfg. Co., 224 Wabash Avenue.

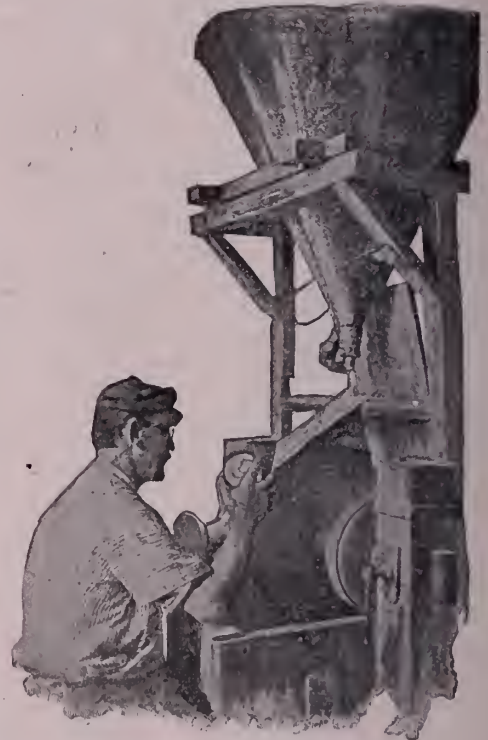

GLASS CUTTER AT WORK.

**We Have Removed to** ○○○○○○○○○○  
**57 MAIDEN LANE.**  
**LEONHARDT & CURRAN,**  
 MANUFACTURERS OF DIAMOND MOUNTINGS.

**No File Equals the "GLARDON" File**

is the universal verdict  
 of the trade.



LARGEST ASSORTMENT IN  
 THE UNITED STATES.

**F. W. GESSWEIN, 39 John Street, New York.**

SOLE AGENT FOR UNITED STATES AND CANADA.

**The Attleboros.**

Last Thursday John H. Bens, a young jeweler, and Miss Bertha F. Witzke, daughter of Amand Witzke, were married.

E. S. Horton, of Horton, Angell & Co., was elected president of the Providence branch of the Union Veterans' Association at the meeting of that organization Wednesday.

W. H. Riley, of Riley, French & Heffron, returned Tuesday last from a seven weeks' trip through Germany, France, Switzerland and England. He is much improved in health.

W. H. Tappan started for Chicago, Friday. Several of the salesmen will go west this week in hopes that the repeal of the Sherman law will be the means of enlivening trade there.

W. A. Wilmarth, father of several young men engaged in the jewelry business, died last Sunday, and the funeral took place Wednesday. Mr. Wilmarth was in his seventy-first year.

On Labor Day a grand flower parade was held in Attleboro. On the general committee that arranged for the successful affair were H. A. Clark, E. A. Sweeney, D. E. Holman and F. A. Adams. H. A. Clark was chief marshal of the procession.

The funeral of William J. Kilty, formerly in business and who was burned to death by the upsetting of a lamp on Friday night, the 25th inst., took place Tuesday last. The jewelers who were pall bearers were F. G. Pate, Samuel Gross, A. N. Quinley and John G. Hull.

A new street railway company known as the South Side Street Railway Co. have incorporated to connect Lowell and Lawrence. The capital stock, \$90,000, is nearly all taken by residents of these towns. The heaviest stockholders are H. C. Bacon, of Lincoln, Bacon & Co., T. I. Smith, John P. Bonnett, A. H. Whiting, George Demarest, A. H. Watkins, E. S. Capron and Mace B. Short.

The North Attleboro tax assessors have just completed their work and in the books THE CIRCULAR correspondent has found the heaviest tax payers in the town are as follows: H. F. Barrows, \$1,845; Abiel Codding, \$1,251; O. M. Draper, \$1,209; D. D. Codding, \$420; Arthur E. Dean, \$290; J. E. Draper, \$702; Frank E. Draper, \$439; G. Herbert French, \$308; E. L. Hixon, \$373; the Lucy Richards estate, \$2,920; Josiah Richards estate, \$1,366; Ira Richards, \$206; H. F. Richards, \$363; C. E. W. Sherman & Son, \$206; T. I. Smith, \$507; T. I. Smith & Co., \$240; E. D. Sturtevant, \$204; Thos. Totten & Co. \$404; F. M. Whiting & Co., \$220; W. D. Whiting estate, \$1,037; Charles P. Young, \$205. The tax rate is \$20 on the thousand.

Homan & Co., Cincinnati, O., are filling a number of orders regularly. They are working on various new designs for the Fall trade.

**A NOVELTY FOR  
BICYCLE AND DASHBOARD.**

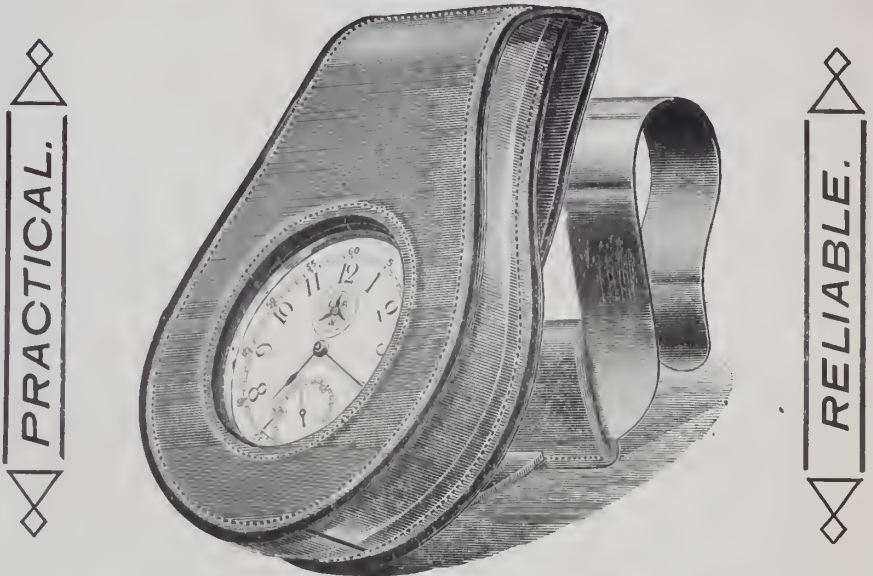

**A. WITTNAUER,**

Manufacturer and Importer,

**19 MAIDEN LANE,**

**NEW YORK.**

**PROGRESSIVE  
PROSPERITY**

is indicated when a  
Jeweler carries a full line of

**HOLMES & EDWARDS,  
SILVER : PLATED : FLAT : WARE.**

**STERLING SILVER INLAID.**

XIV Extra Plate - - - fancy pieces with  
gilt, engraved, or gilt engraved bowls  
and blades.

**BEAUTIFUL EFFECTS ARE PRODUCED.**

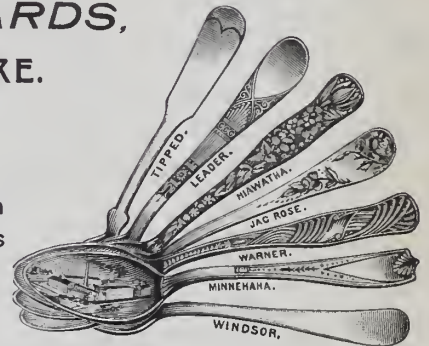

— Salesrooms: New York, Chicago, St. Louis. —

**THE HOLMES & EDWARDS SILVER CO., BRIDGEPORT, CONN.**

ESTABLISHED 1801.

**HINRICHS & CO.,**

29 & 31 PARK PLACE,

Cor. Church Street,

NEW YORK.

**Art Pottery and Bric-a-Brac,**

CUT GLASS, FANCY GLASS, CHINA, LAMPS.

THE LARGEST ASSORTMENT OF SPECIALTIES FOR THE JEWELRY TRADE, AT LOWEST PRICES.



**Providence.**

Joshua Gray is now to be found at 446 Pine St.

Willard C. Haskell is now connected with Ettlenger & Safford.

Benjamin Lederer has returned from a successful western trip.

H. Rosenkrantz, of San Francisco, has been here the past week purchasing goods.

Frank B. Crandall, of Bowers & Crandall, has returned from an extended western trip.

Henry Blundell has attached the property of W. D. Pearce *et al.*, on Potter's Ave., for \$1,500.

Joseph H. Fanning has returned from a three weeks trip to Waterford, Me., much improved in health.

Thomas G. Gardiner is still at 227 Eddy St., notwithstanding reports to the contrary, and is manufacturing a new line of solid gold goods.

N. H. Holt, manager of the Providence branch of the Jewelers' Mercantile Agency,

gave a clam bake to the clerks in his office, at his Summer home at Sabin's Point, last Saturday.

Among the petit jurors chosen by the Board of Aldermen under the new law which went into effect in this State on September 1st are the following: Rudolph Ludwig, Walter S. Hough, Jr., Theodore W. Foster, Sigmund L. Lederer, William Barton, Charles Sydney Smith, Frederick P. Gorham and John W. Atwood.

E. A. Potter, assignee for Joshua Lothrop & Co., states that he has not as yet fully investigated the books, papers and affairs of the concern, but that his inventory will be finished in a few days, when he is in hopes in about ten days, to be able to make a liberal offer of settlement. It is thought that the liabilities will amount to between \$9,000 and \$10,000.

The business outlook in this vicinity has improved considerably within the past week or ten days, and the manufacturers are greatly encouraged, several making preparations for starting up for Fall business, while others are getting their representatives ready for the road. During the past week a number of firms have started up, although on only short time.

Pending the appointment of an executor of the estate of the late Walter E. White, the business will be continued under the management of Samuel H. Baldwin, of the New York office, assisted by Miss Cora B. Dunn, bookkeeper of the local factory. William G. Hopkins will have charge of the estate, and Mr. White's widow has petitioned the Municipal Court to appoint Mr. Hopkins as administrator.

M. Koerberle's jewelry store, Sumner, Ia., was burglarized a few nights ago. Entrance was made by breaking a window glass. The burglars carried off forty-two watches, most of which had been left for repairs.

## FRENCH CHINA SPECIALTIES FOR JEWELERS.

BRUSH & COMB TRAYS,  
CARD TRAYS,  
MANICURE TRAYS,  
PEN TRAYS,

PHOTOGRAPH FRAMES,  
FRUIT PLATES,  
ODD CUPS AND  
SAUCERS, ETC.

◁ SEND \* ORDER \* FOR \* SAMPLE \* ASSORTMENT. ▷

### F. W. BUNING & CO.,

58 MURRAY STREET,

NEW YORK.

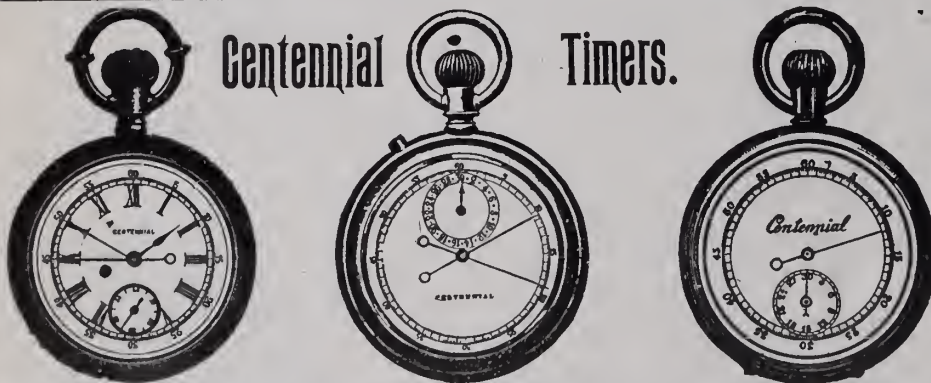

These Watches are one-third larger than above cuts.

## CROSS & BEGUELIN,

Manufacturers, Importers and Jobbers of  
Watches, Diamonds, Jewelry, Watch Materials, etc.,  
17 MAIDEN LANE, NEW YORK.

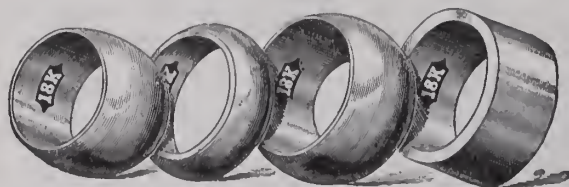

### PLAIN SOLID GOLD RINGS.

### HILDRETH MFG. CO.,

53 MAIDEN LANE,

NEW YORK.

### A. J. LOGAN,

MANUFACTURER OF  
WATCH TOOLS, HAIR SPRINGS AND  
WATCH MATERIALS.

◁ New Catalogue just issued, Sent on Application. ▷  
WALTHAM, MASS.

### VICTOR. ⊕ ⊕

SIMPLEST FEED. ALWAYS THE SAME.  
GUARANTEED FOR ONE YEAR.

### THE VICTOR FOUNTAIN PEN

(Pat. Feb. 4, 1890.)

THE BOSTON PEN CO.,

N. C. Whitaker & Co., Proprietors.

363 Washington Street, - Boston, Mass.,

Manufacturers of finest quality

TORTOISE : SHELL : AND : HORN : GOODS  
In every variety. Also Aluminum Hair Pins.

Send for Illustrated Pen Price List No. 1.



## Our Traveling Representatives



Traveling representatives may consider these columns open for the publication of any news or items of interest regarding themselves or their conferees.

**T**RAVELING men in St. Louis, Mo., last week included: C. B. Bryant, Whiting Mfg. Co., and Mr. Strang, Jonas, Dorst & Co.

David J. Reagan has returned from an extended western trip for Baldwin Miller & Co., Indianapolis, Ind.

Traveling men recently in Indianapolis, Ind., were: J. J. Somers, Thomas Totton & Co.; Mr. Joseph, Albert Lorsch & Co.; Mr. Jepson, N. Wolf & Co.; Messrs. Veit and Phillips, Marx, Veit & Co.; Geo. Fox, Fox Bros. & Co., and Chas. Berry, Wilcox Silver Plate Co.

W. S. Tiffany, Kent & Stanley Co.; J. F. Ripley, Watson, Newell & Co.; H. W. Newton; Dave Untermeyer, Keller & Untermeyer Mfg. Co.; T. B. Kennon, for John T. Maurant; Max Potter, J. M. Fisher & Co.; Sam A. Otis, Harvey & Otis; J. J. Sullivan; Charley Darling; Geo. M. Geer, Tilden, Thurber Co. were visitors to Chicago tradesmen last week.

The following traveling salesmen passed through Detroit last week: C. W. Battey, Wait, Mathewson & Co.; W. H. Bryant, T. G. Hawkes & Co.; Albert F. Carter, Carter, Sloan & Co.; A. U. Liebman, E. P. Reichhelm & Co.; Fred Foster, Unger Bros.; Gus Kaiser, Lewis, Kaiser & Luthy; E. P. Atwood, Lewisson, Boice & Smith; H. E. O. Hartung, Sussfeld, Lorsch & Co.; and a representative of Parks Bros. & Rogers.

Traveling men visiting Syracuse, N. Y., the past week were: A. M. Thanhauser, representing Ludwig Lehmann; Joseph W. Weiss, Henry E. Oppenheimer & Co.; F. W. Sackett; J. Moore, for J. B. Laurençot; Theodore L. Parker, Martin, Copeland & Co.; W. F. Corey, Corey & Osmun; V. W. Henderson, Enos Richardson Co.; Frank W. Harmon, M. B. Bryant & Co.; Mr. Gregory, Strobell & Crane; Chas. F. Ketcham, Riker Bros.; Gilbert F. Foote, Towle Mfg. Co.; Dan. F. Pickering, for C. K. Colby and Bioren Bros.; E. H. Cox, Sussfeld, Lorsch & Co.; M. Simons, Stern Bros. & Co.; C. C. Bates, R. L. Griffith & Son; Mr. Ripley, Watson, Newell & Co.

### Newark.

F. E. Warner has given a chattel mortgage on watches and stock to S. E. Warner for \$350.

John Jennings has given a chattel mortgage on jewelry stock to W. L. Glorieux, for \$2,094.

Orvis C. Gonzales, a young jeweler, of 215 N. 6th St., together with his wife and child, lie dangerously ill with fever contracted by drinking water from Lake Hopatong, where they had been stopping.

The brass band composed exclusively of employes of the Crescent Watch Case Co., are giving weekly open air concerts at the Roseville Station of the D. L. & W. R. R., this city. The concerts take place on Friday evenings and are largely patronized. The band is first-class in every respect and their renditions are enthusiastically received.

Joseph Battin, of Elizabeth, N. J., and formerly a resident of Newark, died at the Faith Cure Home, in New York, last week, aged eighty-seven years. Mr. Battin was the father of S. S. Battin, of the old firm of Kerr & Battin, and the grandfather of S. S. Battin, Jr., of Leroy W. Fairchild & Co. Mr. Battin was a civil engineer and made a large fortune. He gave considerable to charitable institutions. The funeral was held from the residence of S. S. Battin, in Newark. He leaves two sons and two daughters.

### The Death of George L. Bulkley.

George L. Bulkley, a director and stockholder in the Whiting Mfg. Co., New York, and brother of C. E. Bulkley, president of that company, died at North Granville, Washington Co., N. Y., Thursday, after a brief illness. Mr. Bulkley was a prominent citizen of Hartford, Conn., and had gone to rest a few days at his old home in North Granville, where he was born 60 years ago.

The deceased was formerly in the dry goods business in New York, as a member of the old firm of Perego, Bulkley & Plymton, but retired from active business many years ago. He was one of the stockholders in the Whiting Mfg. Co. from the time of its formation.

The remains were taken to Hartford, Saturday, and the burial took place Monday, at Woodlawn Cemetery.

### Jeweler Speaker Forced to Suspend on Account of High Rent.

BIRMINGHAM, Ala., Sept. 1.—To-day A. Speaker, the oldest jeweler in Birmingham suspended business. The direct cause of the suspension was high rent. Mr. Speaker has of late repeatedly called on his landlord to reduce his rent which the latter refused to do. He asked to be either released from his two years' lease, or to make a satisfactory reduction, so as to allow him to continue in business. As Mr. Speaker has as yet secured no reduction or release he suspended business. It is stated that if he can secure a reduction in rent or arrange satisfactory terms he will resume. It is understood that he is able to meet his obligations. Unfortunately the State laws of Alabama give the landlord every advantage.

BLEVINS.—Talk is cheap.

BACKRACK.—Yes; "speech is silver," you know. —Puck.

### Trade Gossip.

J. L. Clark, 724 Filbert St., Philadelphia, Pa., buys all kinds of old gold and silverware, jewelry, watches, platinum, etc., for which he promptly remits the full market value. If you have not already done so, give him a trial.

The E. Kirstein's Sons' Co., Rochester, N. Y., make a specialty of prescription and repair work, guaranteeing accuracy and promptness. Send them a sample job, and get the catalogue offered in their announcement on another page.

An ingenious mechanism is the cyclometer recently invented by S. W. Risien, a jeweler of Mexia, Tex. As the word indicates the device is intended to register the number of miles traveled on a bicycle, and will record as high as 110 miles. It is two and one-half inches in diameter and contains 126 different pieces of metal in its construction.

In the course of a season THE CIRCULAR receives many catalogues and publications of various character from firms in the trade, but seldom has there come under our notice a volume so artistically bound and printed, so complete, comprehensive and convenient, and so valuable to the members of the trade as the new enlarged and revised catalogue and price list gotten up at considerable expense by Rogers & Bro., 16 Cortlandt St., New York, to illustrate and describe their celebrated ★ Rogers & Bro. A 1 silver-plated flat ware. The book is undoubtedly the most complete and concise price list of its kind ever published. The volume contains considerable information anent the Star brand of flat ware, extra plate, sectional or XII plate, triple plate and double plate. A feature of the volume is two pages showing the style of packages, labels and wrappings of the various makes printed in their real colors. Then come illustrations of the firm's famous patterns, the Savoy, Tuxedo, Assyrian, Assyrian Head, Siren, Newport, Saratoga, Embossed, Dundee, Lorne, Olive, Windsor, Belle, Shell, Savarin, French Tipped, Fiddle, and Tipped, besides miscellaneous coffees, egg and ice cream spoons, five o'clock teaspoons, bouillon, orange, salt and mustard spoons, fancy pieces, individual forks of various shapes, oyster forks, butter knives and spreads, ladles, tongs, etc., in numerous designs and sizes. Examples of flat ware in plush lined paper cases are illustrated, while a colored supplement discloses the new Columbia pattern, designed in honor of the World's Fair. A revised classified price list of spoons, forks, knives, etc., then follows, closing with a chapter on table cutlery, orange knives, etc. Altogether the volume contains 114 pages of convenient size, of heavy coated paper. The engraving and printing, and the arrangement of the cuts and price list are worthy the earnest study of all manufacturers who issue catalogues. The book will be sent to the trade upon application accompanied a business card.

### Indianapolis.

E. C. Miller and family have returned from a pleasure trip east.

L. C. Fitch, White Lick, Ind., has sold out his jewelry business to J. Long.

Chas. H. Mueller, formerly watchmaker with Fred. H. Schmidt & Co., has accepted a like position with Wm. J. Eisele.

E. M. Wilhite, Danville, Ind.; R. A. Clark, Anderson, Ind.; and E. T. Jordan, Harmony, Ind., were among the wholesale houses last week.

G. F. Long, New Richmond, Ind., and James Rogers, Rockville, Ind., are in the city, taking a course of instructions in engraving and watch repairing from Dyer & Matsumoto.

Indianapolis jewelers have made extensive preparations to decorate their business houses in honor of the National G. A. R. Encampment. Noticeable are the retail houses of J. C. Walk & Son, H. A. Comstock, F. M. Herron, Wm. T. Marcy, W. J. Eisele, Ed. Ducas and W. T. Gardner. The jobbing houses of Baldwin, Miller & Co. and Nichols, Pee & Co. are to be ablaze with the red, white and blue.

Recently was published in these columns an item to the effect that Thomas Gaskill, St. Paul, Minn., had given a chattel mortgage for \$1,268.02. This was an error and, according to the statement of Mr. Gaskill's lawyer, the former has never given a chattel mortgage in his life.

## W. F. Evans & Sons

SOHO CLOCK FACTORY,

HANDSWORTH,  
BIRMINGHAM,  
ENGLAND.

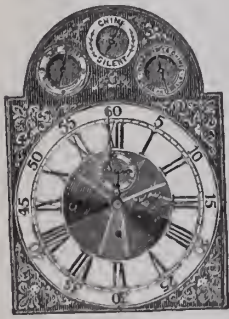

Manufacturers of  
CHURCH,  
CHIME &  
QUARTER  
CLOCKS,

SCHOOL AND  
HOUSE CLOCKS

With arch brass dials to chime upon  
Bells, Gongs, and Harrington's  
Patent Tubes.  
ESTABLISHED 1805.

J. R. WOOD & SONS,  
14 JOHN STREET, NEW YORK.

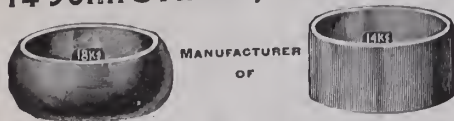

PLAIN SOLID GOLD RINGS.  
SEAMLESS PLAIN SOLID GOLD RINGS.  
ENGRAVED AND CHILD'S RINGS.

No Ring Stamped Different from Quality.  
Send for Catalogue and Price List.

Old Gold and Silver received and estimated on; if amount allowed does not give satisfaction, notify at once and will return at our expense, in same condition as received.

### News Gleanings.

Wm. Hopper, Leadville, Col., has discontinued business.

Joshua C. Goodale, Aurora, Ill., has given a bill of sale for \$1,000.

The death occurred last week of E. Mauthe, Galveston, Tex.

Mr. Brennan, of J. J. Cohn, was in Wilmington, Del., last week.

Max Goldstein, Butte City, Mon., has given a bill of sale for \$578.

C. E. Tillson, Clarion, Ia., has given a chattel mortgage for \$2,475.

Chas. D. Hedinger, Clio, Mich., has given a chattel mortgage for \$171.

Chas. J. Bengston, Madrid, Ia., has given a chattel mortgage for \$2,463.

Rudolph Tausig, Hammond, Ind., has given a chattel mortgage for \$500.

A jewelry and fancy goods store will be opened in Kestel's Block, Ft. Wayne, Ind.

The store of W. R. Bell, Chattanooga, Tenn., was badly damaged by fire a few days ago.

Judgments aggregating \$2,700 have been entered against Charles Bickelman, Schneectady, N. Y.

S. Lubin, optician, 22 W. Lexington St., Baltimore, Md., has handsomely refitted and renovated his store.

Julius Basinski & Bros., stationers and jewelers, Bozeman and Miles City, Mon., have made an assignment.

Robert D. Williams, Albany, N. Y., one of the judges on jewelry at the World's Fair, has returned home enthusiastic over the sights he saw.

The jewelry store formerly owned by R. H. Kuhn, Quincy, Ill., has been bought by the Stein & Ellbogen Co., Chicago, who have bought the interest of Ed. Donahue. It will be reopened with R. H. Kuhn as manager.

A few nights ago E. A. Heeren, a jeweler, who had been at work for M. M. Gumbiner, Luling, Tex., was found dead in his room. He had been drinking heavily and it was supposed that he died from the effects of liquor and heat.

One of the boldest burglaries ever attempted in Eaton, Ohio, was committed last Tuesday evening, when thieves threw a brick through the plate glass in the south window of John Zelly's jewelry store, and grabbed a gold watch and several chains. People were not yet off the street, and the store front was brilliantly lighted by electric lights.

**HENRY FERA,**  
IMPORTER OF DIAMONDS  
AND DIAMOND BORTZ,  
Diamond Cutting and Polishing Establishment,  
10 Malden Lane, NEW YORK.

Wells & Co. have filed a judgment against Levi Paltowitz, Elmira, N. Y., for \$148.46.

A judgment in favor of James W. Tufts, Boston, Mass., against Morgan A. Ruger for \$144.45 has been filed.

W. H. Etz, jeweler, Wheeling, W. Va., was married, a few days ago to Miss Cecelia Nelly, of Parkersburg, W. Va.

A small fire occurred in the show window of Harry E. Thomas & Co., Wilmington, Del., last week. The damage caused was slight.

H. M. Rich & Co., jewelers' auctioneers, 61 Hanover St., Boston, Mass., report having made successful sales during last month for H. G. Hudson, Amesbury, Mass., and F. W. Nichols, Barre, Vt.

Samuel Parsons, who has been engaged in the jewelry business at Santa Paula, Cal., for the past few years, made an assignment some days ago for the benefit of his creditors. The assets are about \$1,000; liabilities about the same.

The store of Theodore J. Meir, Racine, Wis., was burglarized last Tuesday night, and about \$100 in cash and five watches were taken. The police are inclined to the belief that the work was done by some one familiar with the premises.

Abraham Kavajack, alias Joseph Greene, said to be wanted in Paterson, N. J., for robbing a jewelry store, was placed under arrest in Lewiston, Me., last week. He had two watches, a diamond ring and several pieces of jewelry in his pocket; also a ticket for a pair of eye glasses from a Bowery pawnshop.

### Louisville.

H. C. Montgomery and wife have returned from Chicago.

L. C. Huber and family are visiting the great Exposition at Chicago.

Geo. R. Caspari and W. G. Pope, with Wm. Kendrick's Sons, have returned from a visit to the World's Fair.

Ben Gildhaus, watchmaker for C. P. Barnes & Bro., was married on the 28th.

Philip Hager, of Hager & Hetsch, is attending the G. A. R. encampment at Indianapolis.

The one o'clock Saturday afternoon closing came to an end on Aug. 26th. Hereafter the stores will remain open to the usual hour.

Wm. Kendrick's Sons will fit their store Sept. 10th, with new rosewood counters and show cases. They will also have natural gas put in for heating purposes.

### THE INCUMBRANCE.

REDDY MADE.—I got this watch with a suit of clothes.

WOOL SACK.—And the suit wore out months ago.

REDDY MADE.—Yep; but that isn't the worst of it—I've still got the watch.

—Puck.

THE BEST QUALITY  
ELECTRO SILVER PLATE

IS STAMPED

★ ROGERS & BRO., A. I.

THE  
Original, Genuine  
and  
Celebrated

STAR ★ BRAND

WHICH  
HAS STOOD THE  
TEST FOR 50 YEARS.

MADE ONLY BY

ROGERS & BROTHER,

WATERBURY, CONN.

16 CORTLANDT ST., NEW YORK.

MAKERS OF THE FOLLOWING LEADING PATTERNS:

"COLUMBIA," "SAVOY," "TUXEDO" AND "ASSYRIAN."

NEW ILLUSTRATED CATALOGUE NOW READY

"COLUMBIA."

"SAVOY."

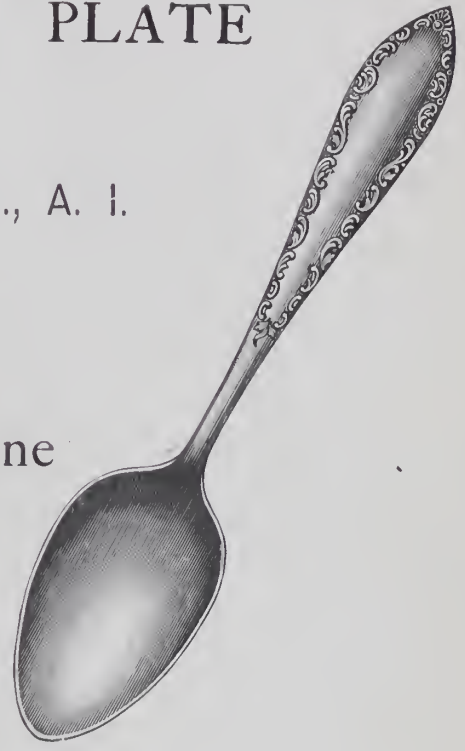

"TUXEDO."

"ASSYRIAN."



CLASSIFIED INDEX TO ADVERTISEMENTS.

All Advertisements are entitled to one insertion under proper heading. Extra insertions, \$6.00 per annum. Extra Headings, \$12.00 per annum.

Table with 4 columns: Category, Page, Category, Page. Categories include Aluminum Solder, Art Pottery, Auctioneers, Assayers & Refiners, Badges, Medals, Etc., Chains, Seamless, Chrome Steel, Cut Glass, Clocks, Diamond Cutters, Diamond & Precious Stone Importers, Diamond Jewelry, Engravers & Designers, Etching School, Fine Stationery, Fountain Pens, Cleaning Solution, Gold and Silver Plating, Gold Jewelry, Horological Schools, Hotels, Imported Clocks, Bronzes, Etc., Jewelry Mailing Boxes, Jewelry, Silverware and Optical Cases, Musical Boxes, Optical Goods, Pens, Pencil Cases, Etc., Patents, Ring Makers, Ring Gauges, Sample Trunks, Settings and Galleries, Silver Mounted Ebony Goods, Silver Plated Ware, Sterling Silverware, Tool Manufacturers and Dealers, Thimbles, Tissue Paper, Tortoise Shell Goods, Trunks and Traveling Bags, Transparent Enamel Wares, Watch Case Manufacturers, Watch and Clock Dials, Watchman's Clocks, Watch Importers, Watch Keys, Watch Manufacturers, Watch Repairers.

## Special Notices.

Rates 75c. per insertion for notices not exceeding 3 lines (25 words), additional words 2 cents each. If answers are to be forwarded, postage stamps must be enclosed. Two insertions, 15 per cent. off; three insertions, 20 per cent. off; four insertions or more, 25 per cent. off. Payable strictly in advance. Display cards on this page will be charged at \$2.00 per inch for first insertion, subject to same discount as above for subsequent insertions.

Under the heading of **Situations Wanted** on this page advertisements will be inserted for **One Cent a Word**. This offer refers to **Situations Wanted only**. Payable strictly in advance. If answers are to be forwarded, postage must be enclosed.

## Situations Wanted.

Notices under this heading **ONLY** are charged at one cent a word, payable strictly in advance. If answer are to be forwarded, postage must be enclosed.

**POSITION** as salesman, retail jewelry or silverware. Experienced. References. Address, "F," care, JEWELERS' CIRCULAR.

**SITUATION WANTED.**—An experienced traveler wishes a position in a first-class house. Many years on the road and well acquainted in all sections east of Omaha. Diamond house preferred. Address E. D., JEWELERS' CIRCULAR.

**A YOUNG MAN**, twenty-one, desires position with jewelry house; seven years' experience; good reference. Jos. Marks, care CIRCULAR.

**SITUATION WANTED** by a boy fifteen years old in a wholesale jewelry establishment, is at present in a retail jewelry store, therefore has some knowledge of the same and able to give good reference. Address M. R., care, JEWELERS' CIRCULAR.

**WANTED.**—Position by first-class watchmaker, clockmaker, jeweler, and repairer of musical toys, etc. Can put my hands to any kind of repairing work. Have had thirty years' experience, and can furnish best of references. Would prefer position in New York City or nearby town. Address D. H. Jacard, Westwood, N. J.

**SITUATION WANTED.**—By young man to finish trade. Two and a half years' experience; good references. Address Box 24, Denison, Iowa.

**SITUATION Wanted**—By a young man as improver; three years' experience at watch, clock and jewelry repairing. Age twenty, best of references. Address, C. W. Parsons, Menominee, Mich.

**SITUATION WANTED** by an experienced and good workman as watch and clock jobber. Good references. Address M. J., care of JEWELERS' CIRCULAR.

**SITUATION** wanted as watchmaker and plain engraver by young man, twenty years of age. Good set of tools and references. Speaks German and English. Address A. A. M., care JEWELERS' CIRCULAR.

**BY** young man, age 22 years. Five years' experience as watchmaker, clock repairer and engraver; do some optical work and wait on trade. Speak German and strict temperate. Address, Arthur W. Miller, Monroe, Wis.

**WANTED.**—To represent in Chicago, an eastern manufacturer. Have been fifteen years in jewelry business. Am well acquainted with eastern trade. Address Geo. A. Karr, care O. W. Wallis & Co., 103 State St., Chicago, Ill.

## Help Wanted.

**WANTED**—Experienced traveling salesman to carry a leading and well-known line of spectacles and eye-glasses; samples easily carried; liberal commission. Address Optics, care JEWELERS' CIRCULAR.

**WANTED**—jeweler and engraver, or good all-round man. Address W. E. Avery, Columbia, S. C.

**ENGRAVER WANTED** December 1. Six months' engagement. Must be skillful and quick on all kinds of fine work. Address, with samples, stating wages, Greenleaf & Crosby, Jacksonville, Fla.

## For Sale.

**FOR SALE**—A first-class jewelry store, established fourteen years, where stock and fixtures costing \$4,500 can be secured for \$2,350, or, if desired, can give lease of store with fixtures and sell stock for \$1,500, one thousand dollars cash and balance on easy terms. Bench work alone amounts to over \$1,800 yearly. The location of the store and profits of the business will stand thorough investigation. Address Frank C. Kibby, No. 366 Broadway, Chelsea, Mass.

**FOR LOS ANGELES, CAL.** Engraver to commence in the Fall; must be an expert workman on monograms and general letter work; no other will do; if a watchmaker, a jeweler, or able to repair fine French clocks, or even a good salesman, it would add to the value of his services; sample of engraving must accompany application. State wages, and if you write before Sept. 9 address Geo. A. Montgomery (of Montgomery Brothers), care of Gorham Mfg. Company, Nineteenth Street and Broadway, New York. After Sept. 9, write to Los Angeles.

**FOR SALE.**—\$500 for \$300 cash. Jewelry, News Depot and furnished rooms for two. Rent \$8. Store pays profit; bench work for one. Address Cyrus Condit, 2344 Bellevue Avenue, Kansas City, Mo.

**FOR SALE**—A Rare Chance. A recently established jobbing, cutlery and silver plated ware business, with New England agencies, is offered for sale. Present proprietor's engagements prevent his devoting the necessary time to the business. A live, pushing man will find this an opportunity seldom offered. Buyer can have immediate possession. Offer must be in cash or well secured paper. Address Jobbing Business, care of JEWELERS' CIRCULAR.

**FOR SALE.**—At Cleveland, O., a watch and jewelry business. Wishing to retire, on account of failing health, I am obliged to sell my business; a good opportunity to purchase a business established over 25 years; central location; clean stock; plenty work; stock and fixtures invoice about \$3,000; terms cash. Address R., Lock Box 89, Cleveland, O.

## Miscellaneous.

**I BUY JEWELRY STOCKS**—Manufacturers, jobbers and retailers desiring to dispose of surplus or entire stocks of diamonds, watches and jewelry can find quick cash buyer by addressing Stephen S. Harmon, 134 East 96th St., New York city.

**WANTED**—To purchase, Jeweler's Stock; include if possible, Burglar Proof Safe; Regulator, lathe, tools, Street clock, material, trial lenses; five to eight thousand. H. Bramer, Attica, N. Y.

**TO MANUFACTURERS**—Wanted, an agency in Philadelphia for jewelry, watches or diamonds, by a person well known to the trade, in Philadelphia, Baltimore and Washington, D. C. Commission if desired. Address D. H. C., JEWELERS' CIRCULAR.

## DEMAGNETIZING.

**PERFECT WORK**—Watch repairing in all its branches; all work warranted. Winslow & Penney, 608 Masonic Temple, Chicago.

**WANTED**—A second-hand Transit, if it can be warranted to be correct for watchmaker's use. Dealers and makers of transits will please send catalogues and lowest cash prices. Address, John Wagner, 116 Sunset Ave., Utica, N. Y.

**ONE CUSHION TIRE SAFETY BICYCLE;** high grade; to trade for jeweler's safe, at once. Address P. O. Box 426, Cherokee, Iowa.

## To Let.

**TO LEASE**—A Game Preserve in the Adirondacks. Plenty of Deer and Trout. Address Chas. Heaton, Jeweler, Potsdam, N. Y.

**TO LET**—Fine front office in Knapp Building; apply to Isidor Elbe, 41 Maiden Lane, Room 17.

**TO LET**—Large well-lighted floor, with steam power, in Twenty-Sixth Ward, Brooklyn, suitable for jewelry manufacturer or kindred trades. Rent moderate. Address T. E. H., care of JEWELERS' CIRCULAR.

**Headquarters**  
FOR  
**ELECTRIC & PORTABLE**  
**Watchman's Clocks**

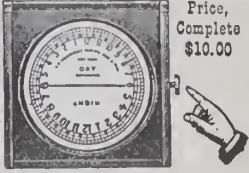

Price, Complete \$10.00

Lowest Prices.  
Latest Improvements,  
Patents 1886-1893.  
Send for Circular.

**E. O. HAUSBURG,**  
41 Maiden Lane, New York. THE "ALERT."

**SOLICITORS OF**  
FOR **DESIGNS** **AMERICAN & FOREIGN**  
**INVENTIONS** **PATENTS** **TRADE MARKS**

SEARCHES MADE & INFRINGEMENTS PROSECUTED OR DEFENDED

THE TRADE WILL PATENTS TAKEN BY

**SAVE TIME AND MONEY**

**COX & SONS 11 PARK ROW, N.Y.**

## PAWNBROKERS' SALES

BY

**S. FIRUSKI & SON,**

AUCTIONEERS,

85 Bowery, New York,

AT 11 A. M.

See N. Y. Herald for full particulars of Sales.

The Trade is Respectfully Solicited to Attend.

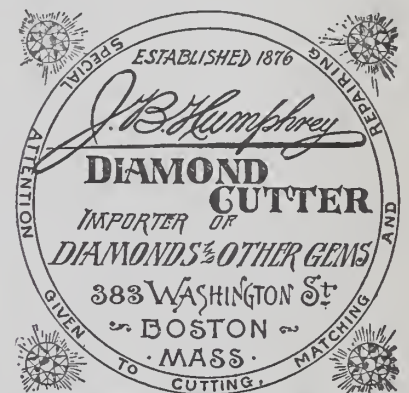

ESTABLISHED 1876

**J. B. Humphrey**

**DIAMOND CUTTER**

IMPORTER OF  
**DIAMONDS & OTHER GEMS**

383 WASHINGTON ST  
BOSTON MASS.

GIVEN TO CUTTING. MATCHING AND

ATTENTION REPAIRING

**Paul Jeanne,** EIGHTEENTH STREET and 4<sup>TH</sup> AVE., N. Y.  
(Bradley Building.)

MANUFACTURER OF

≡ FINE ⊗ DIAMOND ⊗ JEWELRY. ≡

ESTABLISHED 1870.

**J. L. CLARK,**

**SWEEP SMELTER AND REFINER OF GOLD AND SILVER.**

Buys every kind of Gold and Silverware, Jewelry, Watches and Platinum. Full market value paid.

**No. 724 Filbert Street, Philadelphia, Pa.**

SEND BY EXPRESS or Registered Mail. If my price is not satisfactory, I will return all articles.

The Latest Patents.

ISSUE OF AUGUST 15, 1893.

**503,218. JEWELER'S ROLL.** JOHN C. ROCHELEAU, Worcester, Mass. Filed June 5, 1890. Serial No. 354,401. (No model.)

In a machine for enlarging jewelers' rings, the combination of an upper roll, provided with a projecting

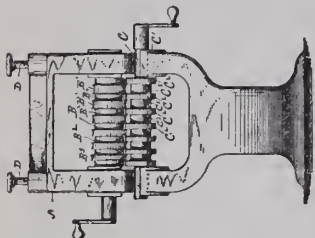

surface bearing upon the outer surface of the ring to be enlarged, a lower roll provided with screw threaded sections, and flanged nuts carried upon said screw threaded sections and enclosing the ring, whereby it is held from lateral displacement.

**503,238. WATCHMAKERS' GAGE.** JOSHUA D. HOWELL, Livonia, N. Y. Filed Aug. 29, 1892. Serial No. 444,471. (No model.)

In a watchmaker's tool, the combination, with a support provided with means for attaching it to a lathe

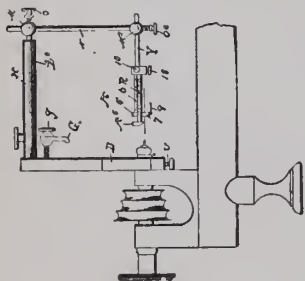

and with means for holding an article to be measured, of a gage adjustably secured adjacent one side of said support, whereby the article may be located between the gage and the support.

**503,310. CLOCK STRIKING MECHANISM.** LOUIS E. COURTIN, Paris, France. Filed July 20, 1892. Serial No. 440,604. (No model.)

In striking clocks, the combination with the striking mechanism of means for automatically repeating the

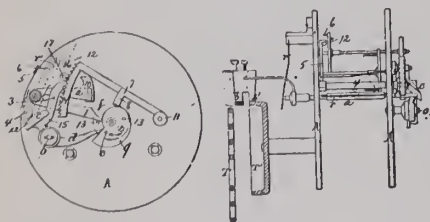

hour numbers at the half hours, and means for sounding a bell or gong at the half hours different from that sounded at the hours.

**503,314. WATCH-CASE SPRING.** JAMES H. FLEMING, Newark, N. J. Filed Feb. 12, 1889. Serial No. 299,646. (No model.)

The improved watch-case spring herein described, consisting of a curved piece of spring metal adapted to lie in the watch case center and having a spur or lock



to engage the lid or cover of the case and having at its convex side a projecting loop, *c*, to receive the holding pin, and back of said loop, opening through the body of the spring to the concave side thereof, having a too

passage or opening, *c*, to enable the workman to pass his tool from the interior of the case to the pin lying concealed at the convex side of the spring.

**503,416. STOP-WATCH.** ALFRED C. GUNN, Geneva, Switzerland. Filed Jan. 25, 1893. Serial No. 459,636. (No model.)

In a stop watch, the combination with the push lever, pawl and cam wheel, of a hammer N, a spring R hav-



ing downward projections  $r^1$   $r^2$  on its under side adapted to be acted upon by the hammer N in its extreme movements, the arbor D and friction disk P upon said arbor, a sleeve around said arbor and the disk Q and the seconds hand D connected therewith, said spring R maintaining contact between the disks P and Q and the hammer N raising said spring to separate said disks.

**503,480. WATCH-GUARD.** HENRY S. HOPPER, Detroit, Mich.—Filed April 4, 1893.—Serial No. 469,010. (No model.)

In a watch-guard, the combination with a spiral spring adapted to fit into the pocket with the watch

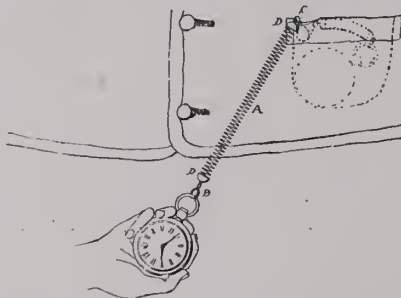

when collapsed, and means for attaching one end of same to the watch, of a hook or pin engaged with the opposite end, whereby it is attached to the garment at or about the inside of the watch pocket.

**503,482. STEM WINDING AND SETTING WATCH.** GEORGE E. HUNTER, Elgin, assignor to the Elgin National Watch Company, Chicago, Ill.—Filed Jan. 25, 1893. Serial No. 459,696. (No model.)

A stem winding and setting watch in which are combined a rotatable, longitudinally movable, stem arbor,



a train driven thereby adapted to alternately communicate its motion to the winding and the dial wheels, and mechanism adapted only by a partial inward movement of the stem arbor after the same has been drawn outward, to place said stem driven train in setting engagement.

**503,483. MECHANISM FOR SETTING WATCH JEWELS.** GEORGE E. HUNTER, Elgin, assignor to the Elgin National Watch

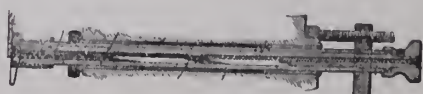

Company, Chicago, Ill.—Filed Aug. 22, 1892. Renewed July 19, 1893. Serial No. 480,953. (No model.)

As an improvement in mechanism for mechanically setting jewels, a holder having a jewel receiving opening to receive and hold a number of jewels, and a detent, or stop, movable into and out of the path of a jewel in making its exit from said opening.

**503,485. CYCLOMETER.** GUSTAV E. KUHN, Schmolln, Germany.—Filed Feb. 23, 1893. Serial No. 463,429. (No model.)

**503,502. STEM WINDING AND SETTING WATCH.** JOHN STARK, Waltham, Mass., assignor to Royal E. Robbins, Boston, Mass., and Thomas M. Avery, Chicago, Ill., trustees for the American Waltham and Elgin National Watch Companies.—Filed March 5, 1892. Serial No. 423,879. (No model.)

As an improvement in stem winding and setting watches, in combination with a sliding clutch which is adapted to be engaged with the winding wheel or the dial wheels, a spring arm that holds such clutch with a

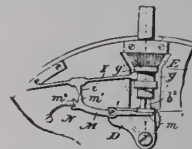

yielding pressure in engagement with the dial wheels and is provided with a cam lug, a lever which is actuated by a spring and is provided with two cam projections, either of which by the movement of such lever in opposite directions, may be caused to engage with said cam lug and thereby produce winding engagement of said clutch, and a stem arbor which is adapted to be rotated and to be moved longitudinally, and by its longitudinal movements to control the movements of said cam lever.

**503,516. STEM WINDING AND SETTING WATCH.** CHARLES H. BAGLEY, Thomaston, Conn., assignor, by mesne assignments, to Royal E. Robbins, Boston, Mass., and Thomas M. Avery, Chicago, Ill., trustees.—Filed Mar. 29, 1893. Serial No. 468,100. (No model.)

In a stem winding and setting watch, the combination of a pivoted yoke which carries a portion of a stem actuated train and by movement upon its pivotal bearing is adapted to effect the winding and setting engagements, a spring that operates to hold such yoke

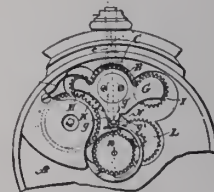

with a yielding pressure in winding engagement; a longitudinally movable or sliding part which is adapted to be engaged with the edge of said yoke and to lock it in winding and setting engagements; a second stronger spring that holds said sliding part with a yielding pressure in engagement with said yoke, and a stem arbor which has no positive connection with the movement and by longitudinal and rotative movement is adapted to control the engagements of said sliding part with said yoke.

**503,517. STEM WINDING AND SETTING WATCH.** CHARLES H. BAGLEY, Thomaston, Conn., assignor, by mesne assignments, to Royal E. Robbins, Boston, Mass., and Thomas M. Avery, Chicago, Ill., trustees.—Filed Mar. 29, 1893. Serial No. 468,101. (No model.)

In a stem winding and setting watch, the combination of the pivoted yoke which carries a portion of the stem actuated train, and is provided with the hook shaped arm having a semi-circular notch, and an inclined face, a spring that operates to hold such yoke with a yielding pressure in winding engagement, a longitudinally movable and sliding piece which is adapted to engage with such notch and inclined face,

a spring that operates to hold said piece with a yielding pressure in engagement with said yoke arm, and a stem arbor which has no positive connection with the

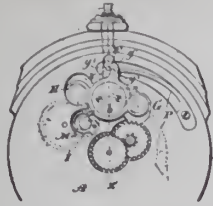

movement and, by longitudinal movements, is adapted to disengage said sliding part from and permit it to engage with said yoke arm.

**503,527. STEM WINDING AND SETTING WATCH.** CHARLES P. CORLISS, Elgin, assignor to the Elgin National Watch Company, Chicago, Ill.—Filed Mar. 29, 1893. Serial No. 468,097. (No model.)

A stem winding and setting watch in which the winding and setting engagements are produced by

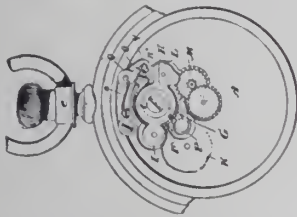

means of a stem arbor that is adapted to be rotated and moved longitudinally, and the stem driven train is locked out of setting engagement by means of a device which may be released by causing said stem arbor to be partially rotated, in either direction.

**503,533. STEM WINDING AND SETTING WATCH.** EDWIN H. FLINT, Cincinnati, Ohio, assignor to George S. Prindle, Washington, D. C.,—Filed April 10, 1893. Serial No. 469,795. (No model.)

As an improvement in stem winding and setting watches, the combination of a rotatable, longitudinally movable stem arbor, winding and dial wheels adapted

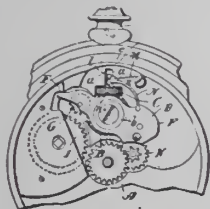

to be alternately actuated by said arbor, and means shiftable by the rotation of said arbor for producing alternate connection between the stem arbor and said wheels, whose movements are controlled by a part connected therewith having inclined faces adapted for cooperation with a part actuated by the stem arbor.

**DESIGN 22,696. BADGE.** ABBOT A. LOW, Brooklyn, N. Y.—Filed June 29, 1893. Serial No. 479,172. Term of patent 14 years.

**DESIGN 22,697. SLEEVE-BUTTON OR LIKE**



**ARTICLE. PHILIP H. FRASER,** Bayonne, N. J.—Filed June 19, 1893. Serial No. 473,172. Term of patent 3½ years.

**DESIGN 22,698. SPOON.** JOHN T. CURRAN,



Brooklyn, assignor to Tiffany & Co., New York, N. Y.—Filed April 22, 1893. Serial No. 471,501. Term of patent 3½ years.

**DESIGN 22,699. BOWL FOR SPOONS.** ULYSSES RACINE, Providence, R. I., assignor



to Watson, Newell & Co., Attleborough, Mass.—Filed July 5, 1893. Serial No. 479,661. Term of patent 3½ years.

**DESIGN 22,700. KNIFE.** CHARLES F. SMITH, New Britain Conn., assignor to the Landers



Frary & Clark, same place.—Filed July 1, 1893. Serial No. 479,392. Term of patent 7 years.

**DESIGN 22,702. HAND FOR TIME PIECES.**



WEBSTER C. BALL, Cleveland, Ohio.—Filed April 26, 1893. Serial No. 471,982. Term of patent 14 years.

**DESIGN 22,703. HAND FOR TIME PIECES.**



WEBSTER C. BALL, Cleveland, Ohio.—Filed April 26, 1893. Serial No. 471,983. Term of patent 14 years.

**DESIGN 22,704. BACK FOR BRUSHES OR HAND-MIRRORS.** JOSEPH WALTER, New

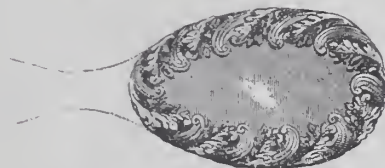

York, N. Y., assignor to John F. Simons, Frederick M. Simons, and Edwin S. Simons, Philadelphia, Pa.—Filed July 14, 1893. Serial No. 480,533. Term of patent 7 years.

**TRADEMARK 23,199. WATCH CASES.** ROSEMAN & LEVY, New York, N. Y.—Filed July 24, 1893.

# SENATOR

*Essential feature.*—The word "SENATOR." Used since June 1, 1893.

## Connecticut.

Business at the Meriden Britannia Co.'s factory is improving in all the departments.

The Phelps & Bartholomew Co.'s clock shop, Ansonia, has resumed work after a suspension of ten days.

C. W. Leavenworth is to be the new superintendent of the solid silver department

of R. Wallace & Sons Mfg. Co., Wallingford.

C. D. Warner, New Haven, left for Hastings, Mich., Tuesday, to complete the electric time system he put in a few weeks ago.

The J. D. Bergen Co., Meriden, started up this morning. President Bergen is quite hopeful that the factory will be running on full time shortly.

Wilbur T. Rogers, of C. Rogers & Bros., Department Commander of the Connecticut G. A. R., left Friday morning to attend the National convention of the Grand Army in Indianapolis, Ind.

E. M. Munger, of New Haven, has been bereaved in the death of his mother, who died Tuesday, aged eighty-eight. She was the widow of Geo. N. Munger, who was for many years a New Haven jeweler.

Last week has been the busiest one J. B. Gardner's Sons, Ansonia, have had since June. Not only has the shop been run every day but the full force of employes has been kept busy with regular hours and overtime for some of them.

Samuel Taylor, born in Birmingham, England, in 1812, who came to this country to make gilt buttons, died in Waterbury last week in his 83d year. He was the only man in this part of the country who could burnish stones from native blood stones. After working awhile in Massachusetts he went to Waterbury in 1837 and worked for the founders of the Scovill Mfg. Co., where he has been engaged the past fifty-six years.

One of the handsomest and most perfect souvenir spoons that has ever passed from the hands of the silversmith is the American-Columbus souvenir spoon, just introduced by the Geo. W. Shiebler Co., 179 Broadway, New York. As an example of the artistic heights to which silversmithing has attained, this spoon stands unsurpassed, both as to the striking originality of the design, and to the perfection of the workmanship. A native American Indian, in full feathers and war accoutrements, forms the handle of the spoon. He stands upon a small globe connected with the bowl by two dolphins gracefully entwined. The bowl, representing the fabled egg of Columbus, contains a representation of *Santa Maria* in full sail upon the ocean, and underneath the date, 1492. On the back of the bowl is represented the Administration building of the World's Columbian Exposition, below which is the date, 1893. So perfect is the die work and so elaborate the details embodied in the design, that even the texture of the blanket worn by the Indian and the cadaverous and characteristic expression of his face are wonderfully natural. The die work throughout has never been exceeded. The spoons are made with gilt or silver bowls, and handles of plain silver or enameled in brilliant colors, portraying the Indian in his native gorgeousness. Illustrations of this remarkable spoon are given on another page.

**DIAMONDS.**

**Wm. S. Hedges & Co.,**  
 Importers of Diamonds,  
 And Manufacturers of DIAMOND JEWELRY.  
 170 Broadway, New York.  
 27 Holdorn Viaduct, London.



18 JOHN ST. NEW YORK

**R. A. KIPLING,**  
 Importer of

**PRECIOUS STONES,**  
 21 & 23 Maiden Lane,  
 19, RUE DROUOT, Paris. New York.

**Alfred H. Smith & Co.,**

**IMPORTERS**

**DIAMONDS**

AND

**PRECIOUS STONES,**

182 BROADWAY, COR. JOHN STREET,  
 NEW YORK.

33 Holborn Viaduct, London, E. C.

**CAMPBELL-METCALF SILVER CO.**



176 Broadway, N. Y., Room 14. 66 Stewart St., Prov. R. I.  
 Mills Bldg., San Francisco, 8th Floor, Room 1.



Patent applied for.

Victoria Novelties, many fancy shapes.  
 Celluloid Top, Slides, Bottom and Cushions.  
**A. TROESCHER & CO., 69 Nassau St., N. Y.**

**LUDEKE & POWER,**  
 IMPORTERS OF DIAMONDS

AND OTHER PRECIOUS STONES,

ADOLPH LUDEKE,  
 CHAS. L. POWER.

23 JOHN STREET, N. Y.

**WOOD & HUGHES,**  
 STERLING SILVERWARE MANUFACTURERS  
 New York Agents for the Derby Silver Co.'s  
 FINE QUADRUPLE PLATED WARE,  
 NO. 16 JOHN STREET, NEW YORK  
 206 Kearney St., San Francisco, Cal.  
 HASKELL & MUEGGE, Agents.

**WIGGERS & FROELICK,**  
 60 NASSAU ST., NEW YORK.  
**Sample Cases and Trays**  
 For Watches, Jewelry, Optical Goods, Etc.  
**WE STRIVE TO MAKE THE BEST.**

**Among the South African Diamond Fields.**

PERHAPS THE HEAVIEST DEAL ON RECORD CONSUMMATED ON THE FIELDS.—A 271½ KARAT DIAMOND FOUND AT HEBRON.—ACTIVITY IN THE SEARCH FOR DIAMONDIFEROUS AREAS.—MINING AT KLIPDAM.

KIMBERLEY, July 29, 1893.—There has just taken place one of the heaviest deals in diamonds on record; it is probably the largest transaction in uncut gems ever made. The contracting parties were Cecil J. Rhodes, the chairman of the De Beers Consolidated Mines, Limited, and B. J. Barnato, head of the firm of Barnato Bros., diamond merchants. The latter purchased the entire stock of the company's diamonds, but whether for their own account or on behalf of a London syndicate is not disclosed. The amount of money involved in this sale is over one million pounds sterling. The diamonds were of all sizes and qualities, but nothing as to prices has been allowed to transpire.

There has been found another monster diamond. This time it is at the dry diggings at Hebron, near the Baal River, some thirty miles from Kimberley. The fortune finder is Mr. Beaumont and the weight of the stone is 271½ karats. It appears to me to be almost perfect in shape and of a glassy color. It is valued on the spot at £27,000 and the general consensus opinion is that it is the finest stone yet found at the so-called River Diggings.

Great activity continues in the search for new diamondiferous areas. As showing the greatly enhanced value of ground which proves to contain diamonds within a reasonable distance of the surface, I will mention one place called Schmidt's Drift, about fifteen miles from Kimberley. This is a farm and twenty years ago was sold for £125. Ten years later its value was £675 and it was acquired by its present owner for that sum. In recent years it has been discovered that the farm carries immense diamondiferous wealth and this week the owner has received a *bona fide* offer of £150,000 for it. Within fifty miles of Kimberley there are large tracts of country known to carry diamond ground, whether in payable quantities can only be ascertained by costly experiment.

There are fully 2,000 Europeans and some 3,000 natives engaged in diamond digging at Klipdam, and although all are not prospering yet the finds continue fairly good.

ST. GEORGE.

A pair of magnificent diamonds, weighing 20½ karats, of pure white color and very brilliant, adorn earring settings in the office of Tatch & Wild, dealers in precious stones, 801 Columbus building, Chicago. The stones are regular brilliant cut and perfectly matched, and are valued at \$4,000.



### Fashions in Jewelry and Silver-Ware.

#### A LADY'S RAMBLES AMONG THE JEWELERS.

A much needed novelty recently brought out is a silver rest for a tea ball.

A new mounting of pearls on a round brooch is on the end of gold spikes set closely together.

From Egypt come little idols carved in lava-like stone. These are used as amulets. They pass for antiques.

Perforated silver receptacles are taking a new start, and are prettier than ever. Without being filagree, they approach its delicacy.

It is interesting to see the new ways silversmiths have of attaching handles to objects. Wherever it is possible to do so, these are varied in their points of contact.

Sword chatelaines are exceedingly attractive. The chain on which the device is attached hangs as the officer's sword straps hang. The scabbard is broad and covered with repoussé work.

A most curious fancy is the giving of gold safety pins as bridesmaids' and wedding presents in England. At a recent wedding gold safety pins with the bride's initial on them was her gift to the bridesmaids.

There is certainly a fancy for Oriental jewelry among women of taste and fancy, for the two are distinct. The use of amulets in jewelry appeals to many women. A necklet was recently seen of pearl and gold beads from which were suspended five jade stones set with rubies and emeralds.

There seems to be more World's Fair goods shown now than earlier in the season. A World's Fair souvenir is a pepper and salt in the form of a globe with the grand divisions carefully outlined. These the inventor remarks are perforated at the north pole, unscrewed at the equator and stand on the south pole.

Surely the Summer sleeve buttons are pretty. White enamel set in a gold rim for the beginning. This is trimmed with fine cross bars in red with parallel lines of blue in tiny figures like baby calico. Nothing prettier is seen. Likewise is pretty the bar and buttons in wrought gold and in platinum and gold. New buttons have one stone such as turquoise in gold united to a bar. Still later are sards in intaglio with a plain bar.

The Chinese regard the jade as a talisman, and presents of jewelry in which the jade is found are considered as suitable on wedding occasions. The East Indians regard the emerald in the same light. An emerald with any kind of hieroglyphics carved on it is held in high favor by most women. Turquoise slabs with Persian lettering, as brooches and pendants fill this demand on the part of lovely woman and have been provided for her. The lettering is in gold.

ELSIE BEE.

ESTABLISHED 50 YEARS.

# RANDEL, BAREMORE & BILLINGS,

IMPORTERS OF

## DIAMONDS,

AND OTHER PRECIOUS STONES.

### FINE PEARLS A SPECIALTY.

MANUFACTURERS OF

# DIAMOND JEWELRY,

IN THE LATEST DESIGNS.

Diamonds Recut in Modern Styles or Repaired on Premises.

58 Nassau Street,  
29 Maiden Lane  
NEW YORK.

1 Tulp Straat,  
AMSTERDAM.

1 St. Andrews St.,  
Holborn Circus,  
LONDON, E. C.



TRADE MARK.

ESTABLISHED 1841.

# CARTER, SLOAN & CO.,

## MANUFACTURERS OF GOLD JEWELRY,

No 15 MAIDEN LANE,

NEW YORK.

A. CARTER, JR.  
A. K. SLOAN.  
C. E. HASTINGS.

GEO. R. HOWE.  
WM. T. CARTER.  
WM. T. GOUGH.

FACTORY, NEWARK, N. J.



# JOHN N. DISSELKOEN,

Cutter and Importer of

## DIAMONDS

FACTORY,  
70 LANGEBLEEKERSPAD,  
AMSTERDAM.

19 East 16th St.,  
NEW YORK.



## French Fire-Gilding.

AS is known, says the *Metallarbeiter*, immense quantities of imitation jewelry, such as watch chains, necklaces, brooches, etc., are sent from the jewelry manufacturing centers of Germany to Paris to be "fire-gilt" and returned to the German jewelers. The price of this gilding moves between 40 and 60 francs per kilogram, according to the gold coating. This proceeding essentially increases the price of the articles, because the French understand how to place an immense value on their skill, and it would, therefore, be well if the German manufacturer were to acquire this skill himself. The method is based on the fact that it is extremely simple to deposit with a correctly working galvanic bath the same quantity of gold upon a certain article as can be done by fire-gilding when applying and dissipating the gold amalgam.

The objection that a heavy galvanic precipitation is very brittle, and does not enter into the same intimate connection with the underlying metal as the coating of the fire-gilding does, is correct. In consequence of this defect it is apt to rise up in polishing, and scale when the article is worn, which can be prevented by the following treatment:

The articles are entered for from 30 minutes to one hour, according to the required thickness of the coating, in a medium rich gold bath, during which time they remain suspended to the action of a correctly regulated current; once or twice in the course of the work they are entered into a cyanide of mercury bath, in which they are exposed to the influence of a weak current, until well and equally quickened, for which from one minute to two minutes is sufficient. They are then carefully rinsed and returned into the gold bath. When the gilding operation is ended, they are quickened another time, and the mercury is then evaporated over a uniform charcoal fire, the articles lying upon a wire netting.

The following method is still more simple: The article is gold plated without intermission, until a sufficiently heavy precipitate is deposited; then quickened in an aqueous solution of proto-nitrate of mercury and dissipated. A yellow deposit will become green after the mercury is driven off; since, however, the gold plater must imitate

the alloys of genuine gold jewelry, with the exception of a few articles like the sprays of lightning rods, etc., he has to imitate the color of 12, 13 and 14 karat gold, and gold-plate the articles red, which is done by an addition of copper to the gold bath. This addition of copper, however, must be made with care, because most of the baths, after having been used for a time, are inclined to become red; this caution must be observed especially in cases when the bath is to be used until exhausted, in place of being renewed. If the gold plater is using such a bath, he had better dispense entirely with the addition of copper, using a new bath for first gilding, and an old for finishing.

Articles gilt red in this manner more or less assume, after driving of the Mercury, the colors of above stated alloys; I say more or less because even a skilful workman will experience great difficulties in imitating a certain color precisely. Beside this, the demands of customers vary greatly, and it is well to keep on hand several small baths of different colors in which the articles, after having been scratch-brushed, are colored to shade. The coloring baths consist of the ordinary fresh gold bath to which, according to requirement, from ten to thirty per cent of cyanide of copper and very small quantities of cyanide of silver are added.

A definite formula cannot be given because the different colors vary too largely, but the gold plater with even a little experience will quickly compose a bath approximating very closely to the shade desired. The following direction may serve him in composing his bath: To a new cold bath add sufficient cyanide of copper until a rose color is produced in gold plating, and when this has been obtained, an addition by drops, of silver is to be made until the shade is as desired. A platinum wire is used as a rule, and as the coloring is the work of a moment; it is advisable not to hang in large lots, but always small ones at a time.

In spite of the most thorough cleansing by hand or revolving scratch brush, and subsequent polishing with bloodstone, strongly gilt small articles frequently show disagreeable looking spots; these articles sometimes have hollows into which the cleansing apparatus cannot enter, and they will subse-

quently look dull and unsightly. In order to correct this, let the gold plater procure a revolving drum, into which are to be placed from six to nine pounds of very small brass or copper grains of about the size of half a pin head; into this is to be poured the necessary quantity of soap or licorice root solution, and next a corresponding quantity of articles, after which the drum is revolved either by hand or mechanical power. After revolving it for from 1½ to 2 hours, the articles are polished, and the plater will at first sight be satisfied that this is a far more satisfactory way of working than by scratch brushing. The friction of the small grains polishes the hollows as brightly as the outside, and beside this, a large saving of time is effected.

As is well known, the articles require a very thorough cleansing before they are galvanized, and it must therefore never be omitted to boil them in a potash or soda solution, and then dip them in a pickle or cooking salt and nitric acid, until certain that no filth of any kind adheres to them.

## Relations of Train to Balance.

THE relation of escapement to balance is a subject which is engaging the attention of thinking watchmakers. That the relation of train and escapement to balance and balance pin are important factors in isochronal adjustments, but few who have had any experience will deny. No one, except a novice, would hold that a balance spring perfectly isochronal in a chronometer escapement would be such in a lever, using precisely the same balance; it would never give a close rate. I mean by this, to illustrate: Suppose we had a balance, and mounted on the staff were double rollers,—one adapted for a chronometer escapement, the other for a detached lever,—and we had two movements for which the balance was equally well adapted, and the balance spring was interchangeable; in fact, the conditions were as nearly alike as could be, except in one movement there was a chronometer escapement and in the other a lever. No experienced adjuster, as stated before, would ever expect the same results, to say nothing of the isochronal adjustment.

**CROUCH & FITZGERALD,**  
Jewelry Trunks  
and Cases.  
161 Broadway  
Bet. Cortlandt and  
Liberty Sts.,  
688 B'way,  
701 6th Ave.,  
NEW YORK



Sold by all wholesale dealers at manufacturer's price.

**A. N. CLARK,**  
PLAINVILLE,  
CONN.

Manufacturer of the Celebrated  
**LOOP WATCH KEY.**

The Best for the Price in the World.  
CROSBY'S JEWELING TOOLS IMPROVED.

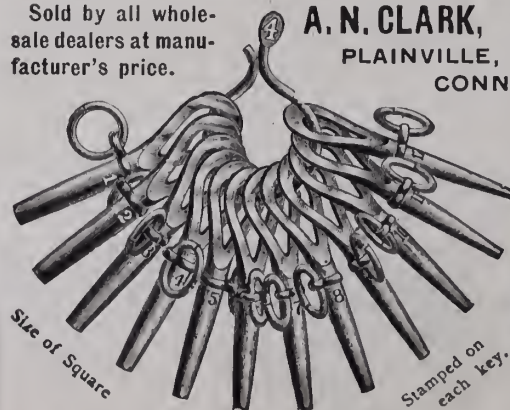

Size of Square

Stamped on each key.



Will quote royalty or price for the manufacturing of articles of real worth.

**Workshop Notes.**

**To Make a Screw.**—The first necessity for making a screw in an ordinary screw plate is good steel—steel that is soft and close grained or tough. Without such, success is almost impossible, and even with such, it is quite a knack to make a nice screw; beginners are generally apt to use too much strength when cutting the thread. If the spindle has been turned too large for the hole in the screw plate, there is danger of breaking the latter, which is necessarily very hard, and pieces will chip off. Again, the piece to be tapped is apt to break and stop up the hole in the plate, thereby entailing the tedious job of drilling the piece out and cleaning the thread.

**Correcting Pallet Depths.**—In light pallet depths the wheel has only to be moved back in the locking a mere trifle, but in very deep depths or long run to the bankings, the wheel has to be moved back a good bit. It is the moving back of the wheel to get the locking out from under the tooth that causes the principal resistance to the force of the balance, for if there were no motion backward of the wheel the unlocking would only be frictional resistance, as in a regulator clock; but this is impossible in watches, for there must be a detachment by draught inward sharp enough to force the guard pin without any hesitation, or else there is danger that the vibration of the balance is frequently interfered with, which, in some cases, will stop the watch.

**Pallet Action.**—All pallets that make equipoise by the two workings have, and must have, the deepest hold of the outside locking. Suppose the depth hold to be such that each of the pallets makes an arc of 3° in the unlocking, it is easily seen that 3° of the larger outer circle which the pallets describe is a greater space than 3° of the smaller inner circle, and the piece of stone which must enter the wheel is the greatest on the outside locking—and if the pallets were made to draw off equally, that depth at which they would do so must be planted precisely, or they would be unequal in the draw off. As a rule, it will be found that if the wheel just catches a trifling hold of the outside locking, and just slips the inside locking, when tried in a depthing tool before closing the tool to the depth, the unlocking will draw off pretty nearly equal when in at the depth, provided the depth is not very deep.

**SUGGESTIONS FOR WINDOW AND STORE DECORATION.**

Members of the trade who think they have an attractive window are invited to send us a photograph, or a pen and ink or pencil sketch of the same, which will be published if we consider the window contains any originality or lesson.

IDEA XLIX.

A HIGHLY characteristic and attractive arrangement of souvenir spoons was recently seen in the window of Penrose Myers, Gettysburgh, Pa., on the occasion of the G. A. R. encampment in that town.

star with High Water Mark on them. The devices were arranged on boards covered with plush. To carry out further the military suggestion of the occasion, at the bottom of the window were arranged jeweled

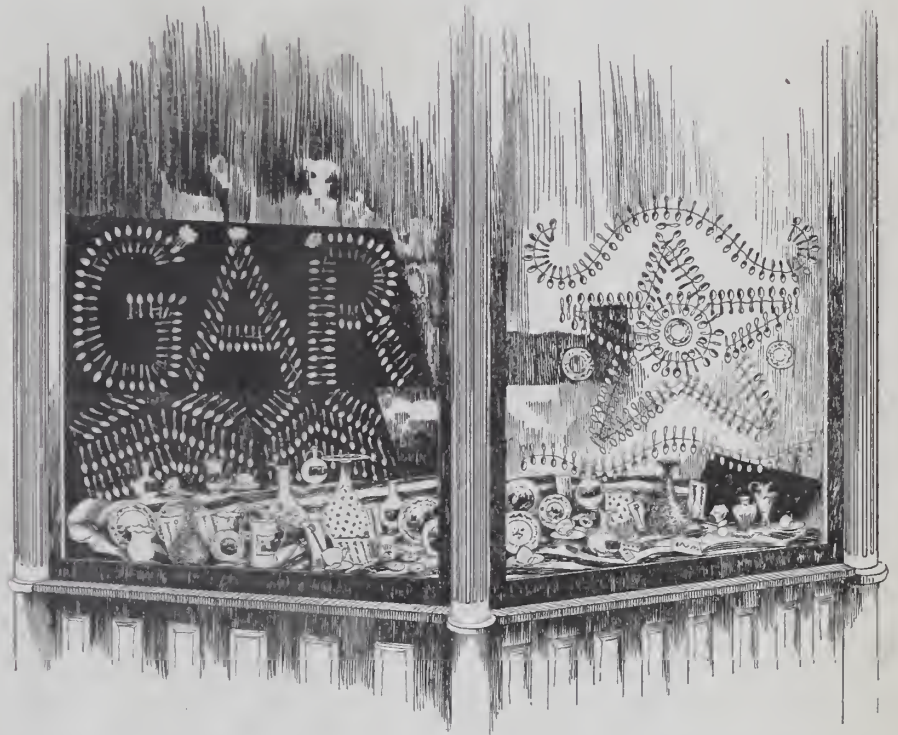

A CHARACTERISTIC ARRANGEMENT OF SOUVENIR SPOONS.

As may be seen in the illustration, at the back of the window were formed with Gettysburgh souvenir spoons the letters G. A. R. At the end of the window souvenir spoons formed a star, above and below which were a wavy scroll of spoons, while plaques were arranged around the

sword pins, etc., and china decorated with views of High Water Mark and the National Cemetery. The floor of the window was laid with Dennison crape paper with red, white and blue colors. Altogether this ingenious and appropriate window decoration was worthy the attention it received.

**VACHERON & CONSTANTIN,  
GENEVA, SWITZERLAND.**

FINEST QUALITY OF WATCH MOVEMENTS, FITTING  
ALL SIZES OF AMERICAN CASES.



**CHAS. LEO ABRY,**

Agent for the United States and Canada.

41 and 43 Maiden Lane. - - - NEW YORK.



# FERDINAND BING & Co.,

106 GRAND ST., N. Y.

SPECIALTIES IN IMPORTED CLOCKS,

MARBLE STATUARY AND BRIC-A-BRAC

FOR THE JEWELRY TRADE.

ENAMELED AND TRANSPARENT SPOONS FROM ALL PARTS OF THE WORLD

THE "ELITE" CHINA EXHIBIT AT THE WORLD'S FAIR, OF

**BAWO & DOTTER,** 28, 30 & 32 BARCLAY STREET,  
NEW YORK.

From THE JEWELERS' CIRCULAR, August 30, '93.

PASSING from the great bronze room in the French section of Manufactures building to the court containing those wonderful works of French ceramic art, the first exhibit to attract attention is the "Elite" china exhibit of Bawo & Dotter, 28 30, 32 Barclay St., New York. A goodly representation of the products of their factories at Limoges is here made, showing in extensive lines their well-known fine quality of French china in all articles for the table and in many new patterns. The Turgot shape comes in dinner, fish, game, tête-à-tête and oyster sets.

It is a neat and attractive pattern consisting of a rococo rim with double clouded decoration, and is brightened by flowering vines with blossoms of brilliant colorings.

A dinner set of 125 pieces is shown in Marie Antoinette pattern. In this the rim of the plates is decorated with six aprons of very pale chocolate, widest at the edge and extending to a rounded point below the drop. There are festoons of gilt connecting the points of the aprons, a small gilt floral design in the center of each piece, and other tasteful gilt decorations. Berry sets, ice cream sets and tête-à-tête sets are also shown in this pattern, the first in light green, the last in bright yellow. Chocolates and coffees, cups and saucers, teas and after dinners are in Bengaline style, which is a slightly torse pattern, wide grooves running spirally from bottom to top, with single cloud decoration, solid gold handles and floral ornamentation.

The Trocadero is shown in coffee pots, chocolates, teas, coffees and salads. It is a handsome pattern with the lower half of upright pieces and the centers of plates in solid color, a deep, bright rose, overlaid with a narrow band each of pink, white,

pale green and gold. The upper parts of standing pieces and the rims of plates have panels of pink and lavender bearing odd gilt representations of bird life. The pattern is an oddity which breaks away from conventionalism, and is quite an attractive addition to decorative effects.

A very pretty shape is the Russia, shown in cups and saucers, teas and chocolates. The pattern narrows just above the center and then flares slightly outward, with a double cloud effect. In color the articles shown are a melted blue. A rare pattern,

ers with wine colored felt covering, are shown the various beautiful wares, of which the above described are but a small part. The factory and its products are well named "Elite," referring to the quality, and not to shapes. In the cities of greatest culture these wares have obtained a foothold not excelled by any French factory producing china, and they well deserve the meed of praise they have won. But a few of the many patterns shown have been mentioned, but those described will serve the purpose of calling attention to the high grade of designing in these wares.

The "Elite" is also sold in all shapes in white china, for decoration, this white line being the largest in America.

At the right and left of the main entrance to the exhibit are two remarkable vases four feet in height, the pair requiring an expenditure of \$4,000 by the purchaser. They have artistic bases of French gold, with high lights in gilt, and a stand of white Limoges ware enriched with heavy gilt decoration. A gold cap receives

the white Limoges body, which is handsomely embellished with hand paintings. The vase to the right pictures the arrival of a French marquise; that on the left a reception given by Louis XVI. The reverse of each shows a garden scene from the Tuileries. Each vase is a magnificent specimen of French ceramic art.

"Quality and price speak louder than words" is the motto on the wall of the Chicago sample room of the firm, 75-77 Lake St., where Paul Fueslein, in charge, will be pleased to show the visiting trade the largest line in the country, replete with new wares direct from Bawo & Dotter's factories in Limoges, France, and Carlsbad and Steinschoenau, Bohemia.—Adv.

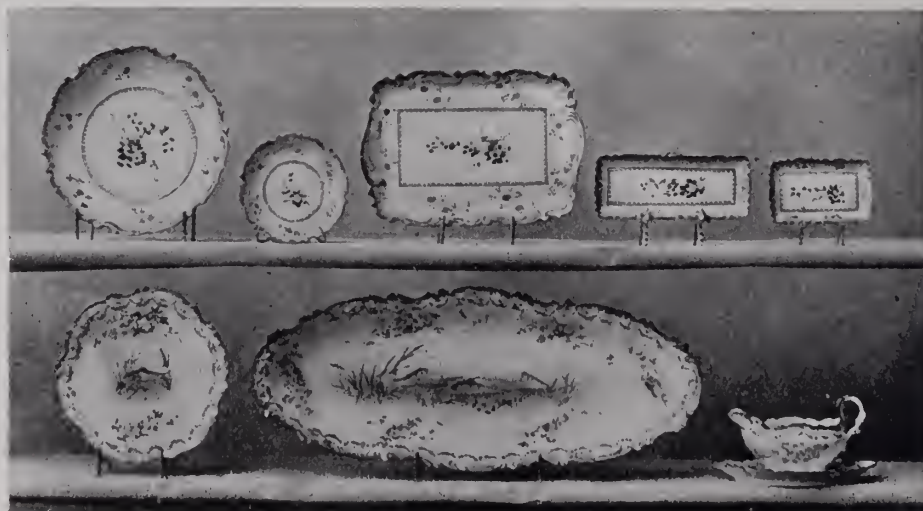

the odette, is in teas, chocolates, after dinners and tête-à-tête sets on china trays. Handsome fish sets are shown in Turgot and Watteau shapes. The latter pattern is also shown in a game set, and is pretty and effective, with a deep gilt, perforated rim. The artistic excellence of workmanship shown in the representations of fish and bird life is remarkable in all these pieces.

About the walls are decorated plates in a wide range of patterns and decorations. The center of the north wall is given to a Watteau fish set, which is flanked on either side by plaques in velvet mats. Gilt framed single plates are shown nearby, with raised ornamentation of bird and fish life, each valued at \$40. Around the court, on count-



## ARTISTIC BRONZES AT THE WORLD'S FAIR.

IN treating descriptively the exhibit of bronzes at the World's Fair, it is impossible, of course, to do more than speak generally, and specific mention cannot be made even of some of the most meritorious pieces among this pre-eminently artistic collection. One pavilion appears like the continuation of another, and distinct lines of attractiveness and merit could only with the utmost difficulty be drawn. From the real bronzes to the imitation one passes with no sense of diminished interest and no lack of appreciation of the taste and designs or the skill which produces the many beautiful objects which are seen on every hand, no matter what may be their classification in the sense of values. THE CIRCULAR has already fully described and illustrated the Dore vase, "La Vigne," undoubtedly the most famous bronze in the great Exposition.

### RUSSIAN BRONZES.

How thoroughly characteristic bronzes may be made of the country of their origin can be best appreciated in the Russian section. Here are a score or two of examples of the work of the late Eugene Lanceray, whose bronzes excited so much attention at the Centennial Exhibition, and here may be seen the latest achievements of men like Prof. Bach, Ober, Gratscheff and other academicians who are the exponents of the bronze art of Russia to-day. The late Prof. Lieberich was the author of the familiar but ever delightful "Bear," of which the Metropolitan Club in Washington, has a fine copy, and "The Wolf Chase," shown here, is a vigorous specimen of his work. Equally characteristic of the Russian conception of art in bronze is Ober's figure of the Cossack Dmitri Peschkoff mounted on his horse "Gray," after he had done his memorable six months' ride of 5,483 miles through Siberia.

The golden age of Russian art in bronze may belong to the past, but her sculptors succeed at least in preserving a distinctly National mode of expression, and in interpreting to the rest of the world the picturesque side of out-door life in Russia in forms that will not die. To find anything equally characteristic in the plastic art of the United States we must go to the familiar casts of John Rogers which appear here

done into bronze and leave an impression in that form which is more curious than pleasing.

### FRENCH BRONZES.

One of the most attractive of the pavilions in the French department, by reason of the elaborate character of the display as well as the high quality of exhibits presented, is that of the Barbediennes, of Paris, manufacturers of artistic and furniture bronzes, enamels, bronze ware for electric and gas lighting etc. At one corner of the pavilion stands an immense figure of Cæsar Augustus, and at another one of La Zingari of corresponding size. Here, too, is exhibited a bronze figure, life size, of Charles V., being a reproduction of the original now in the Museum of Madrid. It is a work of extreme fineness of execution. A peculiarity of this piece which is not generally known to the public is that the armor can be wholly removed, revealing a perfectly modeled body underneath. This little device in the line of transformation is by no means a new one, but it is one with which very few of the visitors to the Fair are familiar.

In the exhibit of Barbediennes we are shown a jewel case of rare beauty and remarkable in the quality of its execution. It is designed for a wedding present. In front are a series of six panels, each containing a beautifully enameled picture. The wood is ebony, and it is finished in fine gold bronze. It is a piece of handmade work entirely, and the price is \$20,000.

There are many fine specimens of original work in this collection, Constance Sevin being the designer of a majority of the more complex and striking pieces. One of these is an aquarium composed of gilt bronze and glass, the metallic legs supporting the glass being bronze models of salamanders. This piece is mounted and filled with gold fish and is one of the many attractions of the pavilion. Another piece by Constance Sevin is a cabinet of Renaissance style. This also is of ebony and gilt bronze. The price of it in its plain state is \$10,000. It is furnished, however, with jewel cases and silver pieces, and as it stands before the observer it is valued at \$25,000. One piece that attracts much attention from visitors represents Theseus

fighting the centaur. It is by Barye, and is valued at \$2,000.

An indication of how important an element bronzes are in the art and manufactures of France may be gathered from an inspection of the list of the principal works executed by Thiébaud Frères. These include some 250 public monuments erected in every continent of the world, of two dozen equestrian statues of equally wide distribution, 13 great public fountains, 38 animal groups, some life size and some larger; 180 statues, chiefly ideal subjects of "natural" size, and subjects innumerable of smaller artistic and of purely commercial bronzes. The works produced by this firm bear the names of more than a hundred sculptors of established fame, in this generation and the last, and their subjects illustrate very clearly the traditions and tendency of French art in bronze.

(To be continued.)

### Bodley's New Goods.

E. E. BODLEY & CO. have produced a pleasing variety of china teas, biscuits, cruets, sardines, dessert sets, trinket sets, etc. There are several quite new shapes and a number of attractive patterns. There are several good and cheap tea sets in new decorations. One of the prettiest novelties shown is the "Princess May" pattern teas. There is something very original about the tea-pot, sugar, cream, etc. They are in shape something like a heart. The bowl of the pot is nearly heart shaped, with the point for the front and back slightly indented, forming a convenient position for the handle. This applies to the other pieces also, the plates and saucers being heart shaped as well. There are some fine decorations on samples of this "Princess May" shape, some in very delicate shades of blue with gold.

Another new shape is the "Rococo"—a very pretty cup, slightly tapering and with scalloped edge turned very slightly outwards. There are several painted and gilt dessert sets and tea sets of rich patterns and others neatly printed, with and without gold.

## The Connoisseur.

(Continued from page 45.)

### The Rambler's Notes.

WHAT THE RAMBLER SAW AND HEARD AMONG THE DEALERS IN ART POTTERY, CUT GLASS, BRONZES, ETC.

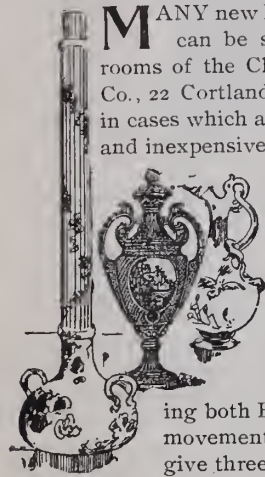

MANY new English hall clocks can be seen in the ware-rooms of the Chas. Jacques Clock Co., 22 Cortlandt St., New York, in cases which are both handsome and inexpensive. The line of hall and mantel clocks carried by this company is one of the largest in the United States, and now numbers over fifty different varieties including both Elliott's and Evans' movements, some of which give three chimes, the Westminster, the Whittington and the St. Michael.

Bawo & Dotter, 30 Barclay St., New York, are showing a handsome line of Saxon china lamps in banquet and boudoir sizes. In decoration they are similar to the Dresden styles but are more delicate in tint and have more color on the body of the lamp.

Among the most beautiful pieces in this line are those with the apple green and heliotrope decorations and those which have Cupids and other figures upon the stem of the lamp.

The line of Bodenbach vases, pitchers, baskets, ewers, flower holders, pedestals, etc., to be seen at Hinrich & Co.'s, 31 Park Place, New York, is among the largest, most striking, and at the same time one of the most inexpensive of the new lines which they show. The ware is a Bohemian faience made in the style of Hungarian faience, and is remarkable for the grotesque forms, the odd but attractive colors and the large size of many of the pieces, some of which, with their pedestals, stand over seven feet high.

Of the many beautiful lines just imported by Chas. Ahrenfeldt & Son, 50 Murray St., New York, one whose sales will be principally through the jewelry trade, is an assortment of Limoges plates and novelties, which as far as artistic coloring and decoration are concerned have never been surpassed. Each piece is decorated with a beautifully executed portrait of some woman prominent in French history, as Marie Antoinette, Mlle. La Valliere, Marquese De Pompadour, Princess De Lamballe, Duches de Dourgogne, etc. In addition to the complete dinner sets shown in this ware may be briefly mentioned vases, ewers, and flower holders of numerous shapes and sizes; plates, cups and saucers, sugar and cream

sets, tête-à-tête sets, ice cream sets, bonbonnieres, after dinner coffee sets, pin trays, jewel trays and various small novelties. Among the other new lines which will interest the jewelry trade, are the delicately tinted Royal Bonn vases, with rococo gold and flower decorations, and the attractive baskets and vases of Austrian faience.

THE RAMBLER.



MRS. NEWRICH.—Don't you see my new vawz, Mrs. Plainspeke?

MRS. PLAIN SPEKE.—Yes; and what a beautiful bawz it has!

—Puck.

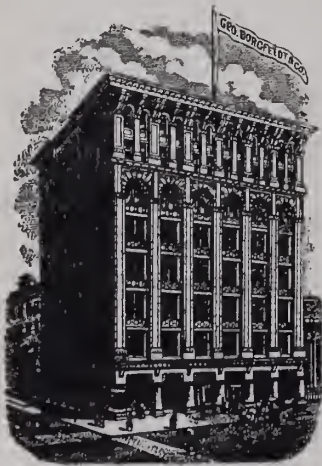

## Exceptional Opportunity

FOR

## Bric-a-Brac Buyers!

OUR entire collection of IMPORT SAMPLES comprising \$100,000 worth of HIGH ART NOVELTIES, specially imported for the Jewelry

Trade, are now on exhibition and will be sold on and after Sept. 1st, at Big Reductions to make room for new importations of Fine Pottery, Art Furniture, Marbles, Exclusive Art Productions, &c.

## GEO. BORGFELDT & CO.,

18, 20, 22 WASHINGTON PLACE, cor. Greene Street, NEW YORK.

# ANNOUNCEMENT



## FALL, 1893.

Our Importations for the coming season are now arriving and we have on exhibition at our ware-rooms a complete assortment of exclusive

# Novelties and Specialties

SELECTED FOR THE JEWELRY TRADE.

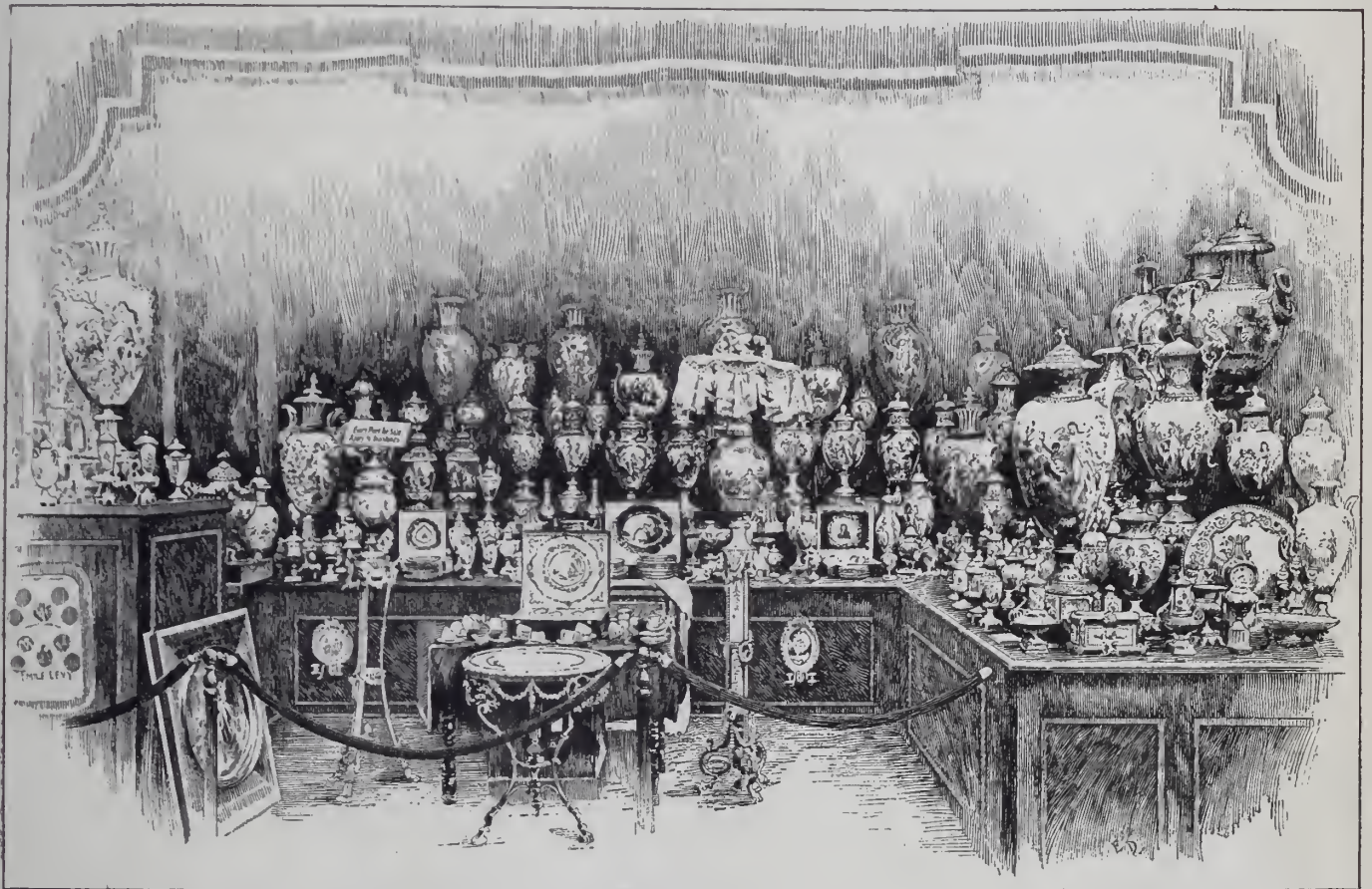

PAVILION CONTAINING THE KERAMIC EXHIBIT OF LEON J. GLAENZER & CO., AT THE WORLD'S FAIR.

Clocks, Bronzes, Sevres Vases, Fine Decorated Porcelains, Cups and Saucers, Tea Sets, Lamps and gilt and silver plated filigree Photo Frames in endless variety.

# LEON. J. GLAENZER & CO.,

35 Boulevard de Strasburg, Paris.

80 & 82 CHAMBERS ST., N. Y.

**FINE**

**Small Brilliants.**

**M. D. ROTHSCHILD,**

NEW YORK: 41 & 43 MAIDEN LANE

LONDON: 15 HOLBORN VIADUCT

PARIS: 58 RUE LAFFITTE.

**CHAS. S. PLATT,**

1837. Successor to Geo. W. Platt, 1881.

GOLD AND SILVER

REFINER, ASSAYER

AND SWEEP SMELTER.

29 & 31 Gold St., Near John St. New York.

Platers' and Electro-Platers' Silver  
Platinum and Aluminum.

FRENCH

WRITE FOR CATALOGUE.

ENGLISH

# CLOCKS

AND CLOCK MATERIALS.

CHAS. JACQUES CLOCK CO.,

22 CORTLANDT ST., N. Y.

**L. LELONG & BRO.,**  
GOLD AND SILVER

Refiners, Assayers AND Sweep Smelters,

◁ SOUTHWEST CORNER HALSEY AND MARSHALL STREETS, ▷

**NEWARK, N. J.**

SWEEPINGS A SPECIALTY.

**S. P. HOWARD,**  
Gold and Silver Assayer.

Refiner and Sweep Smelter,

33 MAIDEN LANE, NEW YORK.

Smelting and Refining Works,

28 & 30 Cumberland Street, Brooklyn, N. Y.

Specialties: Sweepings, Gold, Silver and Platinum



THE SECURIUS.

Porcelain, Onyx, Gilt and Enamel Clocks and Clock Sets.

Popular Goods at Popular Prices.

SPECIAL DESIGNS CONTROLLED BY US IN

**CLOCKS, ART POTTERY, ETC.,**

Fancy Glassware, Vienna Vases, Tete-a-tete Sets,

MARBLE STATUARY

in Carrara and Castellana, Etc., Etc.

**LEVY, DREYFUS & CO.,**

9 and 11 Maiden Lane, New York City.

**WHY**

S. F. MYERS & CO.  
sell more goods than any  
other Wholesale Jewelry  
House.

**BECAUSE**

various publications and illustrated catalogues.

They are the only firm in the Metropolis who carry  
in stock a full line of everything a jeweler requires.  
They give the utmost values and endeavor to  
please their trade in every respect. Refer to their

MYERS BUILDINGS, 48 & 50 Maiden Lane, NEW YORK.

**ALBERT LORSCH & CO.**

37 MAIDEN LANE, NEW YORK.

Branch, 167 Broad Street, Providence, R. I.

—\*IMPORTERS OF DIAMONDS,\*—

Rose Diamonds, Rubies, Sapphires, Emeralds, Opals, Moonstones, Fancy and

IMITATION STONES, NOVELTIES.

SOLE OWNERS AND IMPORTERS OF

*The Sumatra Gem.*  
REG'D.

**IT PAYS**

TO KEEP IN TOUCH WITH TRADE AFFAIRS.

THE JEWELERS CIRCULAR,

For 4c. a Week will do it. **Subscribe.**

WOLFF & UNZBURGER, Importers of DIAMONDS, (Fulton Building), NEW YORK.

L. & M. KAHN & CO., Importers of DIAMONDS, Cor. Maiden Lane, NEW YORK.



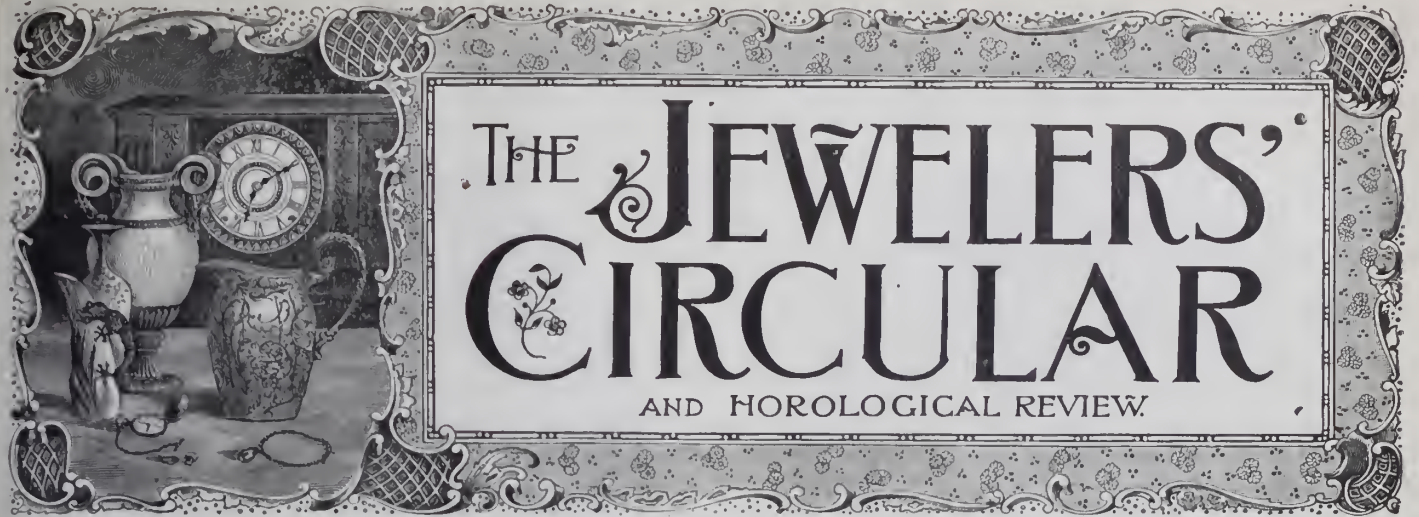

Copyright, by THE JEWELERS' CIRCULAR PUB. CO.

189 Broadway, New York.

Entered at the Post Office in N. Y. as second-class matter.

VOL. XXVII.

NEW YORK, WEDNESDAY, SEPTEMBER 13, 1893.

No. 7

A THOROUGHLY AMERICAN WORK IN SILVER.

At no period of its history has the grand sport of yachting aroused so universal enthusiasm as exists at the present moment. Aside from the trial races of the four yachts built to retain the America Cup in this country, the arrival of the *Valkyrie*, and the international contests soon to come off, the regattas of the prominent clubs excite no small measure of interest.

racer, but a work of true art in silver, to commemorate its achievement.

The trophy is in the shape of a bowl, 22 inches from tip to tip of handles, by 11 inches in height. The oval of the bowl is 16x13 inches, while the capacity is twenty-eight pints. The piece is thoroughly original in design, characteristically American in its every detail, and perfectly artistic in treat-

bottom of the bowl is seen a fine detail in a water movement, while at the sides of the prows is discovered a totem surrounded with feathers, from which start and extend around the broad side of the bowl a representation of wampum serving as an admirable decorative feature. All these details are effective, but the striking features of the piece are the Indian heads that form the two



THE LARCHMONT CUP FOR SCHOONERS, 1893.—MADE BY THE WHITING MFG. CO.

To all yachtsmen and lovers of the sport is especially interesting the schooner race, Sept. 16th, for the Larchmont Cup of 1893, to compete for which yachts of all the large clubs of the east are invited. The trophy, manufactured by the Whiting Mfg. Co., New York, and illustrated here, is thoroughly worthy the event, and the victor will win not only a high reputation as a

ment and execution. In its ensemble it is forceful and noble, while the elements of its design excite admiration as they are individually considered.

The handles represent canoe prows ornamented with a necklace of beads and feathers, while the dimensions and general outlines of the piece suggest a canoe. Under the prows and gradually diminishing to the

large middle feet. They are counterparts. The conception of the face is idealic, strength of character being depicted in every lineament, in the piercing and steady eye, the firm mouth and chin, the cadaverous cheeks and broad bony nose. The modeling is marvelous in its truth to nature. In the engraving the face is fore-shortened owing

(Continued on page 11.)

MARJORIE.

INITIAL.



ILLUSTRATING DESIGNS OF  
 EBONY AND SILVER

COMBINATIONS

— IN —

TOILET SETS.

DEITSCH BROS.,

ORIGINATORS OF NOVELTIES

— IN —

— Leather and Silver Combinations. —

7 EAST 17TH STREET NEW YORK CITY.

THE BEST QUALITY

# ELECTRO SILVER PLATE

IS STAMPED

★ ROGERS & BRO., A. I.

THE  
Original, Genuine  
and  
Celebrated

# STAR ★ BRAND

WHICH  
HAS STOOD THE  
TEST FOR 50 YEARS.

MADE ONLY BY

## ROGERS & BROTHER,

WATERBURY, CONN.

16 CORTLANDT ST., NEW YORK.

MAKERS OF THE FOLLOWING LEADING PATTERNS:

"COLUMBIA," "SAVOY," "TUXEDO" AND "ASSYRIAN."

NEW ILLUSTRATED CATALOGUE NOW READY

"COLUMBIA."



"SAVOY."

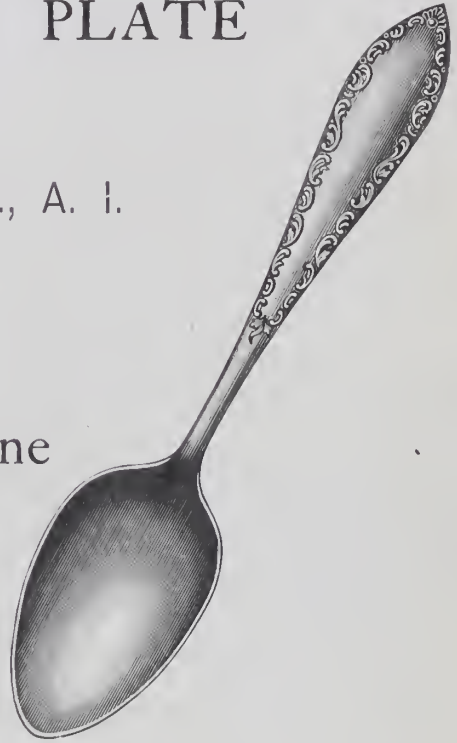

"TUXEDO."



"ASSYRIAN."



“DO YOU KNOW?”

THAT GOODS FREE FROM SOLDER ARE THE BEST?

THAT GOODS MADE FROM SEAMLESS WIRE ARE SUPERIOR IN FINISH ON THIS ACCOUNT?

THAT SEAMLESS WIRE MAKES THE BEST FILLED CHAINS?

THAT WE ARE THE MAKERS OF THE ORIGINAL AND CELEBRATED

SEAMLESS GOLD FILLED CHAINS?



Do not fail to visit our beautiful and artistic display at the World's Fair. The finest of its kind at the Exposition.



Northeast Corner of Manufactures Building, Department O.  
Right on the corner. See Official Catalogue.

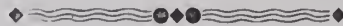

**Kent & Stanley Co.,**

BRANCH OFFICES:

NEW YORK : 17 MAIDEN LANE.      SAN FRANCISCO : PHELAN BUILDING.  
BOSTON, 58 WINTER STREET,      MONTREAL, TEMPLE BUILDING.

MAIN OFFICE AND WORKS:

**PROVIDENCE, R. I.**

**AIKIN, LAMBERT & CO.**

19 Maiden Lane, NEW YORK.

Branch, 42 & 44 East Madison St., CHICAGO, ILL.

Manufacturers and Exporters of

Gold Pens, Holders, Picks, Pencils,

Fountain Pens, etc.

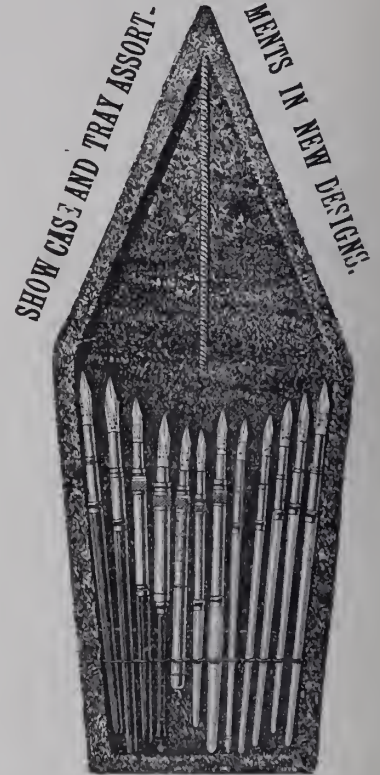

11 x 5 1/2 inches.

PLUSH TRAY WITH EASEL BACK.

1 Doz. 16 K. Pens and Assorted Holders, List, \$30

1 Doz. 10 K. Pens and Assorted Holders, List, \$24

Send for Trade Discount.

**OPTICIANS' SUPPLIES**  
Jobbing and Prescription Work.

The "Graduate" Trial Cases, 180 light, net, \$30.00; 220 lens net, \$37.50. The "Standard" Trial Case, 220 lens net, \$65.00. All with lens. Loring Ophthalmoscope, \$9.00. Artificial Eyes, for selection, \$1.00 each, \$30.00 for hundred. Ophthalmometers, \$50.00 to \$70.00. Queen's Standard Perimeter, \$18.50. Queen's Lens Grinding Outfit, \$30.00. Steel Frames, 15 to 20 cents each. Spherical Lenses, 25 cents per pair. Cylinders, 5 cents per pair. Lenticular Bifocals, 8 cents per pair, (all beveled). Nose pieces, Gold or Shell, German Silver, \$1.00 per dozen pairs. Gold, \$2.00 per dozen pairs.

**QUEEN & CO.** Opticians and  
Catalogue free, 1010 Chestnut St., Phila., Pa.

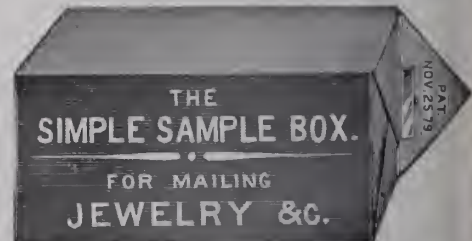

AMERICAN RAILWAY SUPPLY CO.  
24 Park Place, NEW YORK.

For **BADGES AND MEDALS.**

Flag Pins, Class Pins, Class Rings  
and Special Work of all Descriptions.

SEND TO **E. R. STOCKWELL**, MANUF.  
19 John Street, New York.

# The "Pairpoint" MFG. COMPANY.

....New Bedford, Mass.

## SUPERIOR SILVER PLATE.

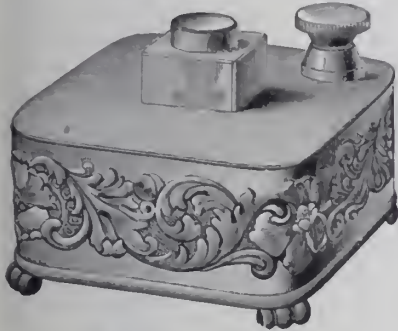

No. 5402, Ink.

**Do Not Fail** to see our Exhibit at Columbian Exposition, Section N, Manufactures Building, and our Store, 224 Wabash Avenue, Chicago.

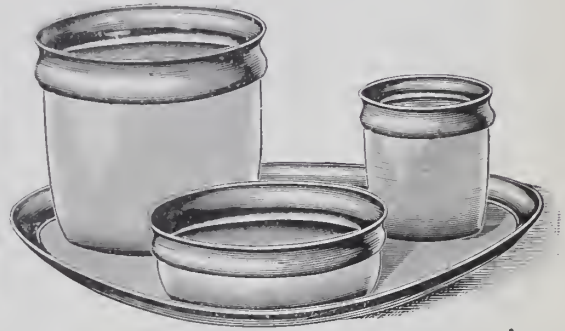

No. 4903, Smoking Set.

### SALESROOMS :

NEW YORK,  
20 Maiden Lane.

CHICAGO,  
224 Wabash Ave.

SAN FRANCISCO,  
220 Sutter Street

## CHAS. L. UHRY & Co.

N. Y. OFFICE,  
189 BROADWAY.

- SCARF PINS,
- BROOCHES,
- CHARMS,
- FOBS.
- HAT PINS,
- HAIR PINS,
- CHATELAINES.

336 Mulberry St., Newark, N. J.

## CHAS. L. UHRY & Co.

### Brunor Plating and Jewelry Rep. Co.

Jewelry Matched and Repaired, Engraving, Chasing and Enameling, Setting, Polishing and Lapping, Battery Gilding and Roman Coloring, Watch Cases Repaired, Polished and Gilded.  
32 Maiden Lane, New York.

We sell to the legitimate Jewelry and Stationery trade only.



NEW YORK CITY, U.S.A

## CHOICE PAPERS

MAKERS OF

## FINE STATIONERY

For Correspondence, Wedding and Business Use, handsomely boxed, specially suited to the Jewelry Trade.

18 MURRAY STREET, NEW YORK.

# WORLD'S FAIR SOUVENIRS.

\* STERLING SILVER. \*



THE COLUMBUS.



REVERSE SIDE OF HANDLE.



REVERSE SIDE OF HANDLE.



THE DISCOVERER.



REVERSE SIDE OF HANDLE.



THE AMERICAN.



No. 2. BAGGAGE CHECK.



MATCH BOX.

## R. WALLACE & SONS MFG. CO.,

SILVERSMITHS,

WALLINGFORD, CONN.

NEW YORK:  
3 PARK PLACE.

CHICAGO:  
86 WABASH AVENUE.

**Treasury Department Decisions of Real Interest to Jewelers.**

WASHINGTON, D. C., Sept. 8.—The following decisions of the Board of Appraisers of the Treasury Department will prove of interest to the jewelry trade. One is in the matter of the protest of W. F. Carver against the decision of the surveyor of customs at Denver, Col., as to the rate and amount of duties chargeable on certain jewelry imported by that individual. The text of the opinion reads:

The merchandise here consists of old jewelry assessed for duty at 50 per cent. ad valorem under paragraph 452, but claimed to be entitled to free entry as medals and trophies under paragraph 648. At the hearing of the case it was submitted on the record. The only evidence offered is an affidavit of appellant, in which it is set forth that the jewelry in question consists of "a gold design set with diamonds, being and representing the features of the Prince of Wales, it being a present from the Prince of Wales; also a diamond ring, which appellant took with him to Europe and brought back again with him." The affidavit also certifies to the truth of a letter of appellant, in the record, which states that both said articles were taken from "this side;" that the ring was purchased in Kansas City, and that the gold design set with diamonds (pin) was given him by the Prince of Wales; that he brought it home with him in the winter of 1882, and wore it back to Europe in 1886.

The statute under which claim of free entry is made here is as follows: (648) "Medals of gold, silver, or copper, such as trophies or prizes." The lexicographical meaning of the word "trophy" is "Anything taken and preserved as a memorial of victory;" and the meaning of the word "prize" is substantially the same as that of trophy, namely: "That which is obtained against the competition of others; anything carried off as the result or award of a contest; the thing striven for; and hence, anything offered to be competed for, or as the inducement to or reward of effort." The evidence does not bring the articles in question within these definitions or any of them. \* \* \*

We find as facts: (1) That the articles subject of protest were imported under the provisions of the act of October 1, 1890; (2) That they consist of jewelry; (3) That they are not trophies or prizes. We therefore hold that the protest is untenable. It is accordingly overruled, and the decision of the collector is affirmed.

Another case is that of C. L. Tiffany, who protested against the decision of the New York collector of customs as to the rate and amount of duties chargeable on a silver urn imported by Mr. Tiffany. The appraisers overruled the protest and said the merchandise is a silver urn, produced prior to the year 1700 A. D., and claimed to be exempt from duties, under paragraph 524, N. T. The Circuit Court of Appeals, in the Marquand case, of the term "collections," as used in the paragraph named, must be construed literally and is not applicable to a single article.

Another case is that of the protest of H. H. Tammen against the decision of the surveyor of customs at Denver, Col., regarding rate and amount of duties on agate stones. The general appraisers find:

That Mr. H. H. Tammen imported into the port of Denver, November 25, 1892, certain merchandise, upon which duty was assessed at twenty per cent. ad valorem as manufactures of agate under section 4, N. T. (2) That the same consisted of perforated, faceted beads, cut from crude agates, known as chain stones, and designated to be set or incorporated into jew-

**BIPPART & CO.**  
 MANUFACTURERS OF  
**DIAMOND JEWELRY**  
 NEWARK · N · J.

BROOCHES, SCARF PINS, HAT PINS, HAIR PINS, EARRINGS,	LINK BUTTONS, CUFF PINS, BRACELETS, NECKLACES, RINGS.
--	---

**NEW YORK OFFICE 19 MAIDEN LANE**

## THE BOWDEN SEAMLESS RING

IS MADE ONLY BY

**J. B. BOWDEN & Co.,**  
 Makers of Finger Rings of every Description.  
**COR. BROADWAY & JOHN STREET,**  
**NEW YORK.**

## J. B. & S. M. KNOWLES CO.,

MAKERS OF

Sterling



Silverware.

FACTORY,  
 Providence, R. I.

SALESROOM,  
 860 Broadway, N. Y.

**O. W. BULLOCK & CO.,**  
 SPRINGFIELD, MASS.  
**Makers of Watch and Jewelry Tools,**  
 NEW CATALOGUE NOW READY.

Sent on Application. Please Mention this Paper.

**JACOT & SON**  
 IMPORTERS AND MANUFACTURERS  
 OF

MUSICAL

BOXES

298  
 BROADWAY  
 NEW YORK



**ARTISTIC  
METAL  
GOODS.**  
NEW DESIGNS,  
NEW FINISHES.

Our line of Pitchers, Vases, Tables, Candlesticks, Five O'Clock Teas, Etc., cannot be equaled.

**THE  
CELEBRATED  
"B & H" LAMP.**



BEAUTIFUL DESIGNS,  
particularly adapted to the Jewelry Trade.  
SEE OUR LINE OF  
TABLE, BANQUET AND PIANO LAMPS  
before placing your orders. Send for our Little Book.

**BRADLEY & HUBBARD MFG. CO.**  
NEW YORK, BOSTON, CHICAGO,  
21 BARCLAY ST., 160 CONGRESS ST. 88 WABASH AVE.  
26 PARK PLACE. Factories, MERIDEN, CT.

**"THE BEST BUTTON MADE."**

IN GOLD FROM **KREMENTZ & CO.** IN ROLLED PLATE FROM **ALL JOBBERS.**

ONE PIECE

**COLLAR BUTTON.**  
IS THE ORIGINAL ONE PIECE BUTTON.  
IS STILL THE BEST AND STILL UNSURPASSED.



**PLAIN SOLID GOLD RINGS.**  
**HILDRETH MFG. CO.,**  
53 MAIDEN LANE, NEW YORK.

ely ; (3) That the same are precious stones cut, but not set ; the importer claims said stones to be dutiable at ten per cent. ad valorem under paragraph 454, N. T. Upon the foregoing findings the protest is sustained.

In the matter of protest of Albert Sersel & Co. against the collector at the port of New York, on duty imposed on imitation precious stones for sleeve buttons, the protest was sustained. In the matter of duty on mounted shirt studs, protest overruled.

In the matter of protest of Bausch & Lomb Optical Co., Rochester, N. Y., against the decision of the collector at Rochester for duty on coquill glasses, the protest was sustained.

**The Death of Richard Squires.**

BINGHAMTON, N. Y., Sept. 4. — Richard Squires died at his home on Main St., West End, on the evening of Aug. 31, of old age. He was one of the old residents of the city, having lived here over fifty-three years. He was a jeweler by trade, and opened an establishment in 1840, being one of the first the city ever had.

Deceased was seventy-three years old, and was born in Geneva, N. Y. A wife, one daughter and three sons survive him. The funeral took place to-day.

**Jeweler Collins, Made Lead Dollars.**

CHICAGO, Ill., Sept. 1.—Captain Porter, of the secret service, last night arrested Alexander Collins, 81 Kendall St., for coining lead dollars and locked him up at the Des-plaines St. station. Collins is a jeweler and has been out of work for some time.

Collins admitted his guilt. He said he was out of work and forced to get a living in some way. All of the tools for counterfeiting silver dollars were found and taken as evidence.

**She Kept the Rings Too Long for Jeweler Edwards' Peace of Mind.**

PITTSFIELD, Mass., Sept. 4.—The police here have arrested a woman who is supposed to be a professional crook, for obtaining jewelry under false pretenses from Edwards' jewelry store. The woman, who said she was the wife of Joseph Beller, of Philadelphia, went to the store on May 1st, and looked at some rings, saying that her wedding anniversary came the 18th and that she would like to take two diamond rings, which she selected, to show to her husband who was to be in town in a few days.

She took the rings and kept them so long that the jeweler became alarmed and fearing that the woman would leave town he had her arrested. She protested innocence of any wrong intent and said that she had expressed the jewelry to Philadelphia for her husband's approval.

The woman was held in \$200 bonds, however, until the diamonds were returned from Philadelphia. With the return of the jewelry the prosecution rested its case.



# RICE & HOCHSTER'S,

Nos. 483 & 485 BROADWAY,  
NEW YORK.

ARTISTIC DISPLAY OF TORTOISE SHELL WORK AT THE WORLD'S FAIR.

THE perfection reached by workers in tortoise shell will be amply exemplified at the World's Columbian Exposition by the display of Rice & Hochster, New York. The exhibit is in the Manufactures building, Gallery F and Pillar No. 83. The articles are displayed within a case, upon a pyramid. Surmounting this pyramid are shown the marvelous ornamental work in tortoise shell illustrated on this page, and represents an arch, upon which are groups of figures typifying agriculture, commerce, machinery, electricity, the press, iron work, chemistry, sculpture, painting

*motto palmam qui meruit ferat* (let him bear the palm who merits it).

The workmanship is as fine and perfect as

ing. In the working of the shell, the amber colored portions have been made to represent the flesh, while the brown parts, the draperies.

The exhibit contains two figures of Washington and Columbus, made of solid shell. On one panel of the pyramid are cut in relief cameos of the twenty-three presidents of the United States. Prominent also are three large combs, one foot square, representing the landing of Columbus, the four Seasons and the five Continents. A great many styles of hair ornaments and lorgnettes made from select shell are in the exhibit. Five

WRITE FOR  
Selection  
Packages of  
Tortoise Shell  
Hair Ornaments  
and Lorgnettes.

Repairing of  
Tortoise Shell  
Goods Equal  
to New.

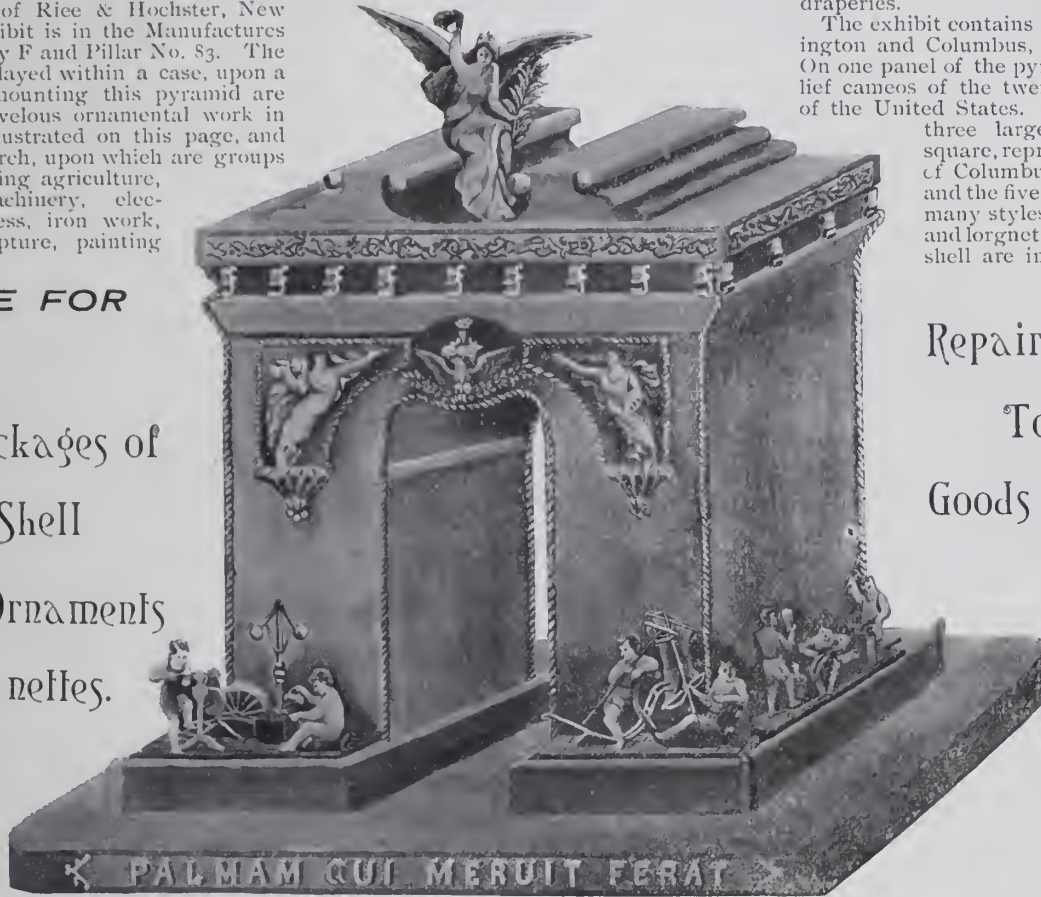

ORNAMENTAL PIECE IN TORTOISE SHELL, EMBLEMATIC OF THE TRIUMPH OF INVENTION AND ART.

and other arts. The angel which surmounts the piece is a faithful miniature of the figure which tops one of the buildings of the World's Fair. In relief, on the base, is the

the conception of the piece is artistic. In the manipulation of the miniature figures the ingenuity of the artisans has been taxed to its utmost and has not been found want-

stuffed tortoises surmount the case which is of white and gold; the letters of the name of the firm are in tortoise shell. *From THE JEWELERS' CIRCULAR, May 3d, '93.*



## THE QUESTION ?

WILL IT TARNISH ? Need  
not be asked if your Tissue Paper bears  
this label.

MANUFACTURED BY

# C. H. Dexter & Sons,

WINDSOR LOCKS, CONN.

**BE SURE YOU GET THIS BRAND.**

It has been adopted and is now used by the leading manufacturers of this country.

**Enterprising Jewelers Catch On!**

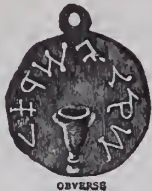

OBVERSE



REVERSE



BACK

**Jewish Sheckel, Masonic Mark or Pocket Piece.**

THE LATEST AND BEST SELLING NOVELTY.

The mark is struck in coin silver; by using either the obverse or reverse of the coin, the back being the same in either case, and permitting of the purchaser's name, blue lodge, chapter and individual mark, with date of same being engraved thereon, as shown in cut above.

Price, without engraving, ONE DOLLAR. Engraved Mark, Dates, etc., 75c. EXTRA.

Liberal Discount to the Trade.

**CHAS. G. WILLSON, MANUFACTURING JEWELER, READING PA.**

**ALUMINUM SOLDER \$2.00 PER POUND.**

Instructions for using given gratis.

Practical Processes for Soldering, Dipping, Enameling, Etching, &c., of Aluminum

**C. DE REDON, 43 WEST 21ST ST., NEW YORK.**

**A. J. LOGAN,**

MANUFACTURER OF WATCH TOOLS, HAIR SPRINGS AND WATCH MATERIALS.

New Catalogue just issued, Sent on Application. WALTHAM, MASS.

**VICTOR. ⊗ ⊗**

SIMPLEST FEED. ALWAYS THE SAME. GUARANTEED FOR ONE YEAR.

**THE VICTOR FOUNTAIN PEN**

(Pat. Feb. 4, 1890.)

THE BOSTON PEN CO.,

N. C. Whitaker & Co., Proprietors.

363 Washington Street, - Boston, Mass., Manufacturers of finest quality

TORTOISE : SHELL : AND : HORN : GOODS in every variety. Also Aluminum Hair Pins. Send for Illustrated Pen Price List No. 1.

**HENRY GOLL & CO.,**

17 JOHN ST., NEW YORK.

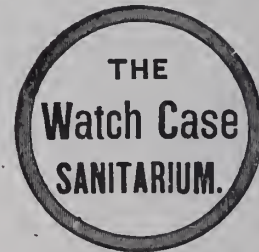

SPECIAL CASES MADE TO ORDER AND REPAIRING IN ALL ITS BRANCHES.

ESTABLISHED 1837.

**GEO. O. STREET & SONS,**

MAKERS OF

Fine Rings, Lockets, Seals, Sleeve Buttons and Links,

15 John Street, NEW YORK.

**CLEAN JEWELRY SELLS QUICK.**

Quarters' Cleaning Solution removes dirt and tarnish in an instant, makes stock like new and brings up diamond and stone work to a beautiful lustre. Solution can be used over and over. Highly commended by all who use it. Send at once \$1.50 for half gallon with full directions. References.

**W. F. QUARTERS ELECTROPLATER, 139 EDDY STREET, PROVIDENCE, R.**

**"TIME IS MONEY"**  
SEND YOUR PRESCRIPTIONS AND REPAIR WORK WHERE IT IS DONE ACCURATELY WITHOUT DELAY.  
**E. KIRSTEIN'S SONS CO.**  
SEND FOR CATALOGUE. ROCHESTER, N.Y.

Lenticular Bifocals Set in Frames, 55c. per pair.



**The Warren Eye Protector**

(Patented Jan. 12, 1892, Feb. 21, 1893.)

Saves the Eyes From

Dust, Wind, or Glaring Light.

Folds in a Compact Case, is

Comfortable, Durable, Water and Dust Proof.

Its large field does not obstruct the sight. No brittle substance to endanger face under sudden blows.

Oculists and Physicians Recommend it.

Travelers, Cyclists, Railroadmen, Horsemen, Motormen, Quarrymen, Pronounce it Indispensable for Man or Woman.

Ask your Dealer for it.

Colors, Clear, Smoke, Blue or Green. Black frames, 50c. Silver, 75c. Sent by mail on receipt of price. Manufactured solely by

**The Nous Verrons Company**  
P. O. Box 3273, Boston, Mass.

**C. SYDNEY SMITH,**

HAS REMOVED TO 191 BROADWAY, New York.

FACTORY: PROVIDENCE, R. I.

Manufacturer of GOLD CHAINS, LOCKETS AND CHARMS.

**Aikin Lambert Jewelry Co.**  
Importers of **Diamonds**  
Jobbers in **WATCHES**  
Jewelry Chains etc.  
19 Maiden Lane, New York.  
SAM'L B. MANN, Treas.  
FRED. D. ILGEN, Sec'y

JAMES C. AIKIN, Pres.  
JOHN B. SHEA, V.-Pres.

## A Thoroughly American Work in Silver.

(Continued from page 1.)

to the curvature of the bowl, which must be tilted to permit a parallel prospective view of the face. The details surrounding the face such as the plaits of hair disappearing beneath the bowl, the necklet of claws and the oriole of feathers diminishing in relief and combining with the bowl portion of the piece, are remarkable in their conception and treatment. The end feet display feather ornamented shields as their decorations. The relief portions of the piece are light oxidized, producing an effect of massiveness, and admirably bringing out all the details of the decorative features.

Altogether we may say this trophy breathes of the Indian and his life and as a characteristic American art production in silver it stands unique.

### Shook, Patterson & Co. Succeeded by the Omaha Diamond & Watch Co.

OMAHA, Neb., Sept. 11.—The Omaha Diamond and Watch Co., of this city, has been incorporated with a capital stock of \$6,000, in single shares of \$100, "to manufacture jewelry, buy and sell watches and diamonds, gold and silver."

The incorporators are Charles L. Shook, John A. Patterson and Finley L. Combs.

### An Arrest That Recalls Jeweler John Godwin's Death.

TORONTO, Ont., Sept. 9.—The case of John Godwin, the one-armed jeweler, who was found dead in a room behind his store in Queen St., W., is once more brought before the public by the arrest of Joe Maroney.

It will be remembered that a short time before Godwin's death he was robbed of \$300 in a cab. Two of the parties implicated are now doing time. Maroney is supposed to have been in the case, too, and the police have been looking for him ever since.

### A Tale of Two Mules and a Jewelry Store.

KANSAS CITY, Mo., Sept. 6.—Two small mules that haul a delivery wagon about town for a firm at 1024 Main St., while hitched in the rear of the store, Sunday, became restless and backed down a fifteen-foot embankment, wagon, mules and all, in the rear of C. E. Russell's jewelry store at No. 1028. After the mules had fallen in a problem presented itself to their driver, for they were confronted by a fifteen foot bank on three sides and the rear of Russell's jewelry store on the fourth.

A derrick was suggested, but it was taken for granted that a mule would not submit to such a humiliating experience as being hauled helplessly up out of a hole by a block and tackle. Finally it was suggested by some bright man that the mules be taken through the jewelry store, and accordingly Mr. Russell was sent for to take down the

bars at the rear of his store and let the mules pass through. A heavy rug was placed on the floor, and the two mules were led in at the rear of the store and out at the front door on Main St. without any trouble at all. People crowded about the place wondering what Jeweler Russell was doing with mules in his store.

### Imports and Exports for July, 1893, and the Preceding Seven Months.

WASHINGTON, D. C., Sept. 8.—The summary statement of imports and exports for the month ending July 31, 1893, and for the seven months ending the same date, compared with the corresponding periods of 1892, has been issued and contains the following figures relative to the jewelry trade:

IMPORTS.—Diamonds and other precious stones, rough or uncut, including glaziers' and engravers' diamonds, not set, and jewels to be used in the manufacture of watches: Month of July, 1893, \$23,393 against \$60,300 same month of 1892, and \$71,388 in June; clocks and parts of, July, 1893, \$11,948 against \$17,544 same month of 1892, and \$17,157 in June; watches and parts of, and watch materials and movements, July, 1893, \$130,791 against \$114,612 same month of 1892, and \$148,272 in June; jewelry and manufactures of gold and silver, July, 1893, \$60,848 against \$39,374 same month last year, and \$28,873 in June; precious stones and imitations of, not set, July, 1893, \$561,692 against \$1,306,671 same month last year, and \$1,016,047 in June; platinum, unmanufactured, July, 1893, \$12,766 against \$45,686 same month last year, and \$65,874 in June.

EXPORTS OF DOMESTIC MERCHANDISE.—Clocks and parts of, July, 1893, \$65,904 against \$58,228 same month last year, and \$100,436 in June; watches and parts of, July, 1893, \$34,373 against \$14,200 same month last year, and \$49,832 in June; jewelry and manufactures of gold and silver, July, 1893, \$96,336 against \$58,624 same month last year, and \$103,484 in June; plated ware, July, 1893, \$32,739 against \$19,860 same month last year, and \$31,650 in June.

IMPORTS, for seven months ending July 31, 1893.—Diamonds and other precious stones, rough and uncut, etc., \$589,091 against \$592,281 in 1892; clocks and parts of, etc., \$91,470 against \$72,673 in 1892; watches and parts of, etc., \$943,709 against \$809,589 in 1892; jewelry and manufactures of gold and silver, \$450,663 against \$227,257 in 1892; precious stones and imitations of, not set, \$8,619,367 against \$7,623,374 in 1892; platinum, unmanufactured, \$387,099 against \$345,393 in 1892.

EXPORTS OF DOMESTIC MERCHANDISE, for seven months ending July 31.—Clocks and parts of, \$529,157 against \$507,674 in 1892; watches and parts of, \$186,483 against \$92,494 in 1892; jewelry and manufactures of gold and silver, \$627,488 against \$394,450 in 1892; plated ware, \$199,242 against \$180,751 in 1892.

EXPORTS OF FOREIGN MERCHANDISE.—Diamonds and other precious stones, etc., July, 1893, nothing against nothing and \$355 against nothing for seven months; clocks and parts of, July, 1893, \$76 against nothing in July, 1892, and \$595 against nothing for seven months; watches and parts of, etc., July, 1893, \$115 against \$22 in July, 1892, and \$180 against \$22 in seven months; jewelry and manufactures of gold and silver July, 1893, \$1,256 against \$7,326 and \$6,580 against \$56,654 for seven months; precious stones, etc., July, 1893, \$823 against nothing in July, 1892, and \$823 against \$4,395 for seven months.

The imports during the seven months ending July 31, 1893, as compared with the average of the same period of the five preceding years, shows the following: clocks and watches and parts of, increase \$5,053; jewelry and manufactures of gold and silver and precious stones, increase \$1,238,257. In exports, clocks and watches, decrease \$94,170.

### Commissioner Louis P. White Makes an Assignment.

PHILADELPHIA, Pa., Sept. 7.—Louis P. White, 706 Chestnut St., has made an assignment for the benefit of his creditors, with Joseph H. Watson, his bookkeeper, as assignee. Joshua R. Morgan has been retained for the assignee's interests. There are no preferred creditors, although members of Mr. White's family have claims against him. Attorney Hyneman represents the New York creditors.

Mr. White says his embarrassment is owing entirely to bad debts induced by business depression. He estimates the liabilities at \$16,000, but believes, in case there is no undue shrinkage, that the stock will be sufficient to meet them.

A committee of creditors are now making an appraisement, and will be ready to report some time next week. Mr. White acted as commissioner for the National Retail Jewelers' Association.

### The Jewelers' Security Alliance.

The regular monthly meeting of the executive committee of the Jewelers' Security Alliance was held at the Alliance office on the 8th inst. There were present H. H. Butts, chairman, A. K. Sloan, president, Bernard Karsch, treasurer, and Messrs. White and Abbott.

The following applicants were admitted to membership: Bippart & Co., 19 Maiden Lane, New York; Friedman & Ascheim, 51 & 53 Maiden Lane, New York; Francis Schneider, 68 Bowery, New York; Roseman & Levy, 105 W. Water St., Elmira, N. Y.; Riker Bros., 42 Hill and 42 Court Sts., Newark, N. J.; Corey & Osmun, 27 Marshall St., Newark, N. J.; M. V. B. Elson, Freeport, Ill.; Fred'k M. Herron, 4 E. Washington St., Indianapolis, Ind.; Leon Hirsch, 155 State St., Chicago, Ill.; A. C. Raefle, 1180 Fulton St., Brooklyn, N. Y.; John H. Reid, 118 Fairfield Ave., Bridgeport, Conn.

# THE "KENSINGTON,"

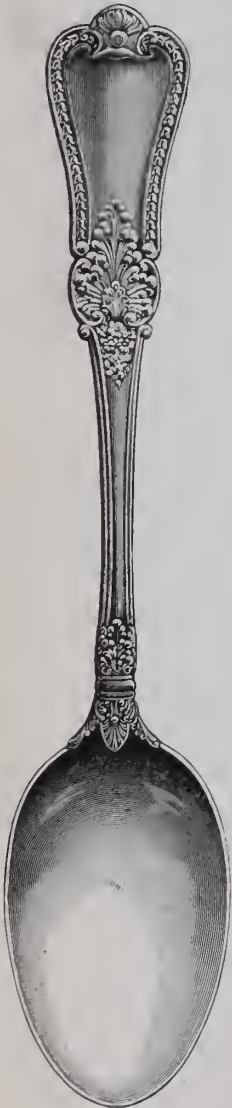

8, 10, 12 oz.



15, 18 oz.

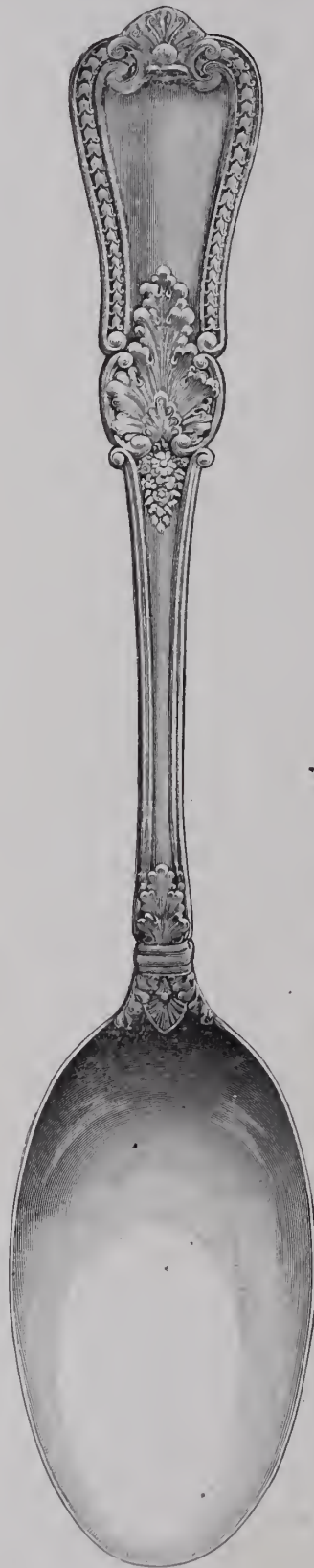

22, 28 oz.



20, 25 oz.



15, 18 oz.

GORHAM MFG. CO., SILVERSMITHS.

# GORHAM SOLID SILVER.

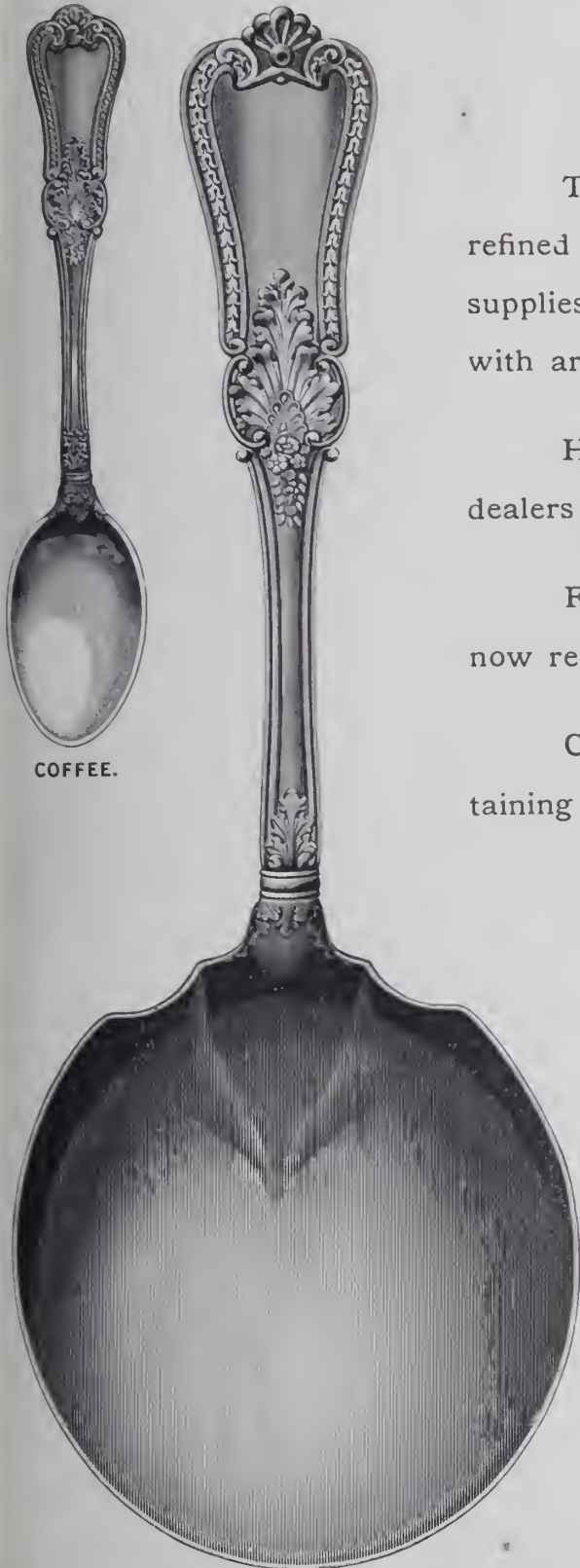

COFFEE.

BERRY.

This pattern is in perfect keeping with the most refined and advanced taste in Artistic Silverware. It supplies the demand for a plain, bright finished design, with artistic relief in the border.

Has already been largely ordered by the class of dealers having a critical and discriminating trade.

Fancy Pieces as well as Spoons and Forks are now ready.

Combination Chests of all sizes up to 303 pieces containing this pattern can be delivered in October.



NEW YORK:  
BROADWAY AND 19TH STREET,  
23 MAIDEN LANE.

CHICAGO:  
137 AND 139 STATE STREET.  
PARIS, FRANCE: 36 AVE DE L'OPERA

SAN FRANCISCO:  
118 AND 120 SUTTER STREET.  
WORKS: PROVIDENCE, R. I.

# Bouguereau's Great Masterpieces in Silver.

NYMPHS AND SATYR.



MATCH BOX



COURT PLASTER.

PSYCHE AND LOVE.



MATCH BOX.

THE highest art has been attained in modeling the subjects of those great paintings in *bas relief* on Silver and Gold. The success we have made, has elicited the highest expressions of approval from the famous painter **Bouguereau**, the recognized leader of the nude school, as may be seen in the following letter.

PARIS, 22 Juni, 1893.

WM. B. KERR &amp; Co.,

MESSIEURS: Je viens vous remercier des deux boîtes en argent que vous avez bien voulu m'offrir.

J'ai pu constater par les bas reliefs, qui les ornent et qui sont faite d'après deux de mes tableaux "Nymphes et Satyre" et "Psyché et l'Amour," tous le soin que vous apportez à l'exécution de vos travaux ainsi que la recherche artistique que vous y mettez.

Je ne puis que vous encourager, Messieurs, à poursuivre dans cette voie me permettant cepedant de vous faire observer qu'a mon avis vous devez, avant de faire executer des œuvres d'art, obtenir la permission de l'Auteur.

Veillez agréer, Messieurs, l'expression de mes sentiments très distingués.

PARIS, June 22, 1893.

WM. B. KERR &amp; Co.,

GENTLEMEN: I desire to thank you for the two silver boxes, which you have so kindly presented me with.

From the *bas reliefs* which ornament them, and which are reproductions of my two paintings "Satyr and Nymphs" and "Psyche and Love," I can certify with pleasure the great care shown in the execution of the work of reproduction, also the highest artistic sentiment.

I desire to encourage you gentlemen in pursuing such a path, allowing me to suggest that in so doing, that permission be obtained from the authors.

Kindly accept gentlemen the expression of my most sincere consideration.

## WILLIAM B. KERR & CO.,

Manufacturers of ARTISTIC JEWELRY IN GOLD AND SILVER,

FACTORY:  
NEWARK, N. J.

860 BROADWAY, N. Y.

# The Jewelers' Circular

AND  
HOROLOGICAL REVIEW.

PUBLISHED EVERY WEDNESDAY BY

THE JEWELERS' CIRCULAR PUB'G CO.,  
189 BROADWAY, NEW YORK CITY.

A JOURNAL DEVOTED TO THE INTERESTS OF JEWELERS, WATCHMAKERS, SILVERSMITHS, ELECTRO-PLATE MANUFACTURERS, AND ALL ENGAGED IN KINDRED BRANCHES OF INDUSTRY.

Our Editorial columns will contain our own opinions only, and we shall present in other columns only what we consider of interest or value to our readers. Advertising matter will not be printed as news.

Advertising rates in THE CIRCULAR are lower, considering the number of tradesmen reached by its large circulation, than in any other jewelry journal.

Notices of changes in standing advertisements must be received one week in advance; new matter can be received up to Monday.

## INFORMATION FOR SUBSCRIBERS.

### Terms of Subscription, Postage Prepaid.

	PER ANNUM
United States and Canada, - - -	\$2.00
Foreign Countries in Postal Union, - -	4.00
Single Copies, - - - - -	.10

New subscribers can commence at any time. Payments for THE CIRCULAR, when sent by mail, should be made in a Post-Office Money Order, Bank Check or Draft, or an Express Money Order or Registered Letter. All postmasters are required to register letters whenever requested to do so.

Pay money only to authorized collectors having proper credentials. Returning your paper will not enable us to discontinue it, as we cannot find your name on our books unless your address is given.

In changing address always give the old as well as new one. Your name cannot be found on our books unless this is done.

We will continue to send papers until there is a specific order to stop, in connection with which all arrearages must be paid, but such an order can be given at any time, to take effect at the expiration of the subscription. All such orders will be promptly acknowledged by mail.

The Courts have decided that all subscribers to journals are responsible until arrearages are paid in full and an order to discontinue has been received by the publisher.

Member of the American Trade Press Association.

Vol. XXVII. Sept. 13, 1893, No. 7.

## WINDOW DESIGN CONTESTS, NO. 1.

A Prize of \$10.00 is offered by THE JEWELERS' CIRCULAR for the best design for dressing a jeweler's window. The contest is open to all members of the trade, to the clerks, salesmen and others, as well as to the dealers. Following are the conditions:

1. The design is to be submitted as a pencil or other sketch or photograph, from which a finished engraving may be made. The design may be an original conception or a copy of a window already dressed.
2. A brief description is to accompany the design.
3. The design must be appropriate for the Fall and holiday season.
4. Designs for Contest No. 1 must reach us no later than Oct. 1.

**A** CLEVER swindling enterprise, in which World's Fair exhibitors were "elected" as victims, has been unearthed, and its *modus operandi* was fully exposed in the last issue of THE CIRCULAR. In view of the many schemes that are likely to be set on foot by swindlers during the closing months of the Exposition, it is proper to caution all exhibitors to be conservative in dealing with parties not known to them.

**Exhibits which** **I**T is a matter of congratulation that so large a number of the firms of the trade exhibiting at the World's Columbian Exposition has received recognition in the way of awards, as indicated in the despatch from Chicago published in another portion of this issue. While to some it will appear that the medals have been given out too lavishly, these persons should remember that every exhibit receiving an award must possess some points of excellence. However, the diploma will be eagerly looked for as it formulates the specific points of excellence presented by the exhibit receiving the award. The reader conversant with the different jewelry trade displays at the Fair will note, in perusing the list as published, that some of the most striking and worthy exhibits are not mentioned. He should not infer that they have not received awards, but should bear in mind that all the reports had not yet been handed in by the judges, at the time the list, incomplete and unofficial as it is, was prepared, so that the respective committees have not been able to accept or reject them. The list may be relied upon as being accurate as far as it goes. It is THE CIRCULAR'S hope to supplement it with the names of other worthy exhibits as soon as they are obtainable.

**Have Received Awards.**

**The Brightening** **T**HE effect of the enormous majority in the House for the repeal of the Silver Purchase Act was felt immediately in an improvement in business throughout the country. The improvement has extended from the banks to the mills, the condition of the great industries having distinctly mended. All the factories in the lines of jewelry, watches, clocks, silverware, etc., with but a comparatively few exceptions, are now running during at least three days a week, while many are making preparations for full time, and some for overtime. In Providence, the Attleboros and Plainville, the jewelry business has taken on a new lease of life. The salesmen who went west a few days ago are now sending in orders. Firms in these localities now say that the Fall trade looks quite encouraging, though it will be after Christmas before the shops will have their full complement of hands. Increased cheerfulness is noticed among the jobbers of New York, Chicago, Cincinnati, St. Louis and other centers. During the

past week there has been a general exodus of travelers from their home cities, as may be concluded from a perusal of the Our Traveling Representatives page of this issue, and as the retailers have, during the past two months depleted their stocks without making purchases, it is reasonable to presume that the genial knights of the gripsack will receive numerous orders. Altogether, the clouds over the horizon of the Fall season of the jewelry trade are dissolving, and the anxiety of yesterday has changed into hope of to-day for joy of to-morrow.

## The Week in Brief.

**A** NUMBER of the awards to firms in the jewelry and kindred lines exhibiting at the World's Fair were made known—The trunks of C. W. Angevine, traveler for Benj. Allen & Co., Chicago, who disappeared, were recovered—L. M. Braham & Son, Cincinnati, O., were cited to appear in court—The trial of "Gold Dust" Swindler Levi has been fixed at Hamilton, Ont.—Phillip McDevitt was committed in Philadelphia, Pa., charged with robbing the store of John F. Bates—The plant of the Lancaster Silver Plating Co., Lancaster, Pa., was destroyed by fire—Several interesting tariff decisions were handed down by the board of general appraisers—The death of Richard Squires, Binghamton, N. Y., was reported—The Omaha Diamond & Watch Co., Omaha, Neb., was incorporated—The Treasury Department issued its monthly statement of imports and exports for July, 1893—L. P. White, Philadelphia, Pa., assigned—The store of R. Leubusher & Co., Milwaukee, Wis., was seized by the sheriff—H. A. Gurinan, Holdrege, Neb., was adjudged to be mildly insane—M. Mondragon, Santa Fé, N. M., absconded—The optical goods store of Ferdinand Wagner, Cincinnati, O., was robbed by burglars—Henry Ives, Boston, Mass., wants to settle with his ereditors—The store of Moses Smith, Wilmington, Del., was robbed—The store of Geo. A. Brockenshaw, Elgin, Ore., was damaged by fire—W. H. Breen, St. Paul, Minn., assigned—The death occurred of S. Maier, of S. Maier & Co., Atlanta, Ga.—Julius Jensen, Provo City, Utah, assigned—The store of Geo. C. Mosher, Chattanooga, Tenn., was attached—On the application of the New York Jewelers' Board of Trade, a receiver for the Bailey & Esser Co., Milwaukee, Wis., will be appointed—The replevin suit of Leroy W. Fairchild Co., New York, against the assignee of Edward F. Sanford & Co., New York, was discontinued—S. Lyons & Son, New York, made an assignment—An attempt will be made in the courts of Brooklyn, N. Y., to have Eugene and Jennie Leroux indicted for smuggling.

Andrew E. Warner, Baltimore, Md., has made an assignment.

### New York Notes.

R. A. Breidenbach has entered a judgment for \$320.21 against William Folkart.

The annual ball given by the Jewelers' Union, is announced to take on Saturday, Sept. 23d.

The Germania Bank has entered a judgment against Morris Baruth for \$712.91, due on a promissory note.

Henry Abbott removed last week from the Havemeyer building to the third floor of the building at 2 Maiden Lane.

The effects of John Keller, Jr., manufacturing jeweler, 81 Nassau St., were sold by the sheriff, Thursday morning, about \$600 being realized.

George Carlton Comstock has entered a judgment in this city for \$253.63 against Calvin J. Wells, Utica, N. Y., in favor of Cross & Beguelin.

Edward Zellenka, of Phillip Zellenka & Son, was married Sept. 5th to Miss Esther Scheff. The ceremony was performed by the Rev. Dr. Silverman.

Ernest F. Tyler, jeweler, of Muncie, Ind., accompanied by his wife, came to this city last week on their bridal trip. Mr. Tyler was married last Wednesday to Miss Florence Groves, at the bride's home in Georgia, N. Y.

John Fleischman, of 220 Franklin St., Brooklyn, was arrested last week on the charge of stealing three watches from the jewelry store of Jennie C. Viemeister, 303 Manhattan Ave., Brooklyn. He was held for trial.

William O'Brien, with R., L. & M. Friedlander, has met with a sad bereavement lately in the death of a brother. Frank Davis, order clerk for Messrs. Friedlander, has been spending the past two weeks at Stamford, Conn.

Edward B. La Fetra, assignee of Charles Seale & Co., is advertising for the creditors of the insolvent firm to present their claims, duly verified, at the office of Blumensteil & Hirsch, 320 Broadway, New York, on or before Nov. 20, 1893.

Albert Huguenin, the watch manufacturer of Chaux-de-Fonds, Switzerland, was in New York the past week and made his headquarters with R., L. & M. Friedlander, 65-67 Nassau St. He will visit the World's Fair and will return home on Oct. 1st.

The annual contribution of the jewelry trade toward the Floating Hospital and Seaside Hospital Fund of St. John's Guild, which was collected by the New York Jewelers' Board of Trade, was remitted to the Guild on Friday. The amount subscribed was \$235.50. E. J. Scofield, president of the Jewelers' Board of Trade, received a letter from the general agent of St. John's Guild, acknowledging the receipt of the contribution, and expressing to the Board and those who joined in their effort the sincere thanks and appreciation of the trustees of the Guild.

About forty New York jewelry firms have signed a petition asking for the appointment of Howard Tully, a former jeweler of Fort Worth, Tex., as postmaster of that city. The paper, which was circulated by Geo. H. Hodenpyl, of Hodenpyl & Sons, contains the names of some of the most prominent firms in the jewelry trade.

The marriage of Marie Louise Durbrow to Frederick William Barthman, Jr., son of William Barthman, will take place next Tuesday evening at St. George's Church, Marcy and Gates Aves., Brooklyn. Mr. Barthman left Saturday for Chicago, where he will spend a week. He and his bride will sail for Europe Thursday, Sept. 21st, on the *Fuerst Bismarck*.

At a session of the Goldbeaters' Convention held last week at 189 Bowery, it was resolved to fix the price of a "ribbon" at \$6.20, and the hours are to be reduced from ten to eight per day. At Wednesday's session a committee was appointed with instructions to recommend to the Committee on Ways and Means of the House of Representatives that the duty upon imported gold leaf be not reduced.

The replevin suit commenced by the Leroy W. Fairchild Co. against Wm. C. Demarest, as assignee of Edw. F. Sanford & Co., was discontinued Friday on consent of counsel, by Judge Ingraham of the Supreme Court. By the order, the requisition to replevin is withdrawn, the sureties on the plaintiff's undertaking released from all liability, and all matters pertaining to the action are canceled.

Sophia Friedlander, mother of the three members of R., L. & M. Friedlander, 65 Nassau St., died at her residence early Monday morning. Mrs. Friedlander was born in Breslau, sixty-seven years ago. Among the various societies of which she was a member are: The Sisterhood of Dr. Kohut's Church, Queen Esther's Society, and the Ladies' Health Protection Association of New York city.

Judge Ingraham of the Supreme Court, last week appointed, Samuel W. Milbank receiver of the A. D. Reisthal Co., importers of china, art pottery, glass ware, etc., at 55 Murray St., in proceedings for the dissolution of the company, brought by Heinrich Becker, a creditor. It is claimed that the business has been mismanaged and is insolvent. The sheriff had previously taken charge of the store on two executions, aggregating \$9,209, as mentioned in *THE CIRCULAR* last week.

The motion made by the Dueber Watch Case Mfg. Co., in their suit in the New York Supreme Court against the Co-operating Manufacturers, asking for a commission to take the testimony of certain persons in Pittsburgh, Pa., came up before Judge Ingraham Thursday. The motion was argued and briefs submitted. The plaintiffs ask, in taking this testimony, for permission to put questions to the witnesses orally instead of making the usual written interrogatories. Decision was reserved.

Many of the jobbers in the vicinity of 21 Maiden Lane, had an opportunity Saturday of seeing an enormous muscalonge which was shown in N. H. White & Co.'s office in the Hays building. The fish, which was caught by D. S. Mason while on a fishing trip in Canada, weighed when received in New York, about twenty-three pounds, and excited the admiration of the many enthusiastic fishermen who viewed it.

John S. Grey who, as told in *THE CIRCULAR* last week, was held for examination in Mount Vernon, N. Y., on a charge of black-mail, preferred by John A. Fletcher, of the Fletcher Watch & Jewelry Co., of this city, failed to appear at the hearing which was set down for last Wednesday, and Judge Appell, of the Mount Vernon City Court, issued a bench warrant for his arrest. The Fletcher Watch & Jewelry Co. claim that Grey tried to compel them to pay him money under threats of publishing certain transactions in the newspapers which would damage their business.

Two middle-aged men, fairly well dressed, entered the down-town store of the Gorham Mfg. Co., at 23 Maiden Lane, about 9.30 o'clock Saturday morning and asked to be shown some flatware. The porter of the store noticed one of the men attempting to conceal some goods and attracted the attention of Chas. Siegman, an employe. Mr. Siegman grabbed the man and took from him two silver ladles which he had attempted to steal. The man claimed that his friend was about to pay for the two articles. As the goods were recovered the men were not arrested.

As stated in *THE CIRCULAR* last week, the affairs of Edward F. Sanford & Co. have been settled. It is stated on good authority that the clients of Franklin Bien received one hundred cents on the dollar, including interest on their claims. The other creditors received twenty-seven per cent. cash, under the composition. A *CIRCULAR* reporter called on Mr. Bien at his office, 320 Broadway, who admitted the foregoing to be correct, but stated that he assigned his judgments to William Ziegler, of Brooklyn, as Mr. Sanford could not personally pay the money in view of his composition.

Some time ago The New York Jewelers' Board of Trade commenced an action for the appointment of a receiver for Bailey & Esser Co., Milwaukee, Wis., on a claim of Albert Lorsch & Co., of this city, amounting to about \$1,000. Secretary H. M. Condit received a letter Monday from Miller, Noyes & Miller, the Board's attorneys at Milwaukee, stating that, after considerable delay, the court had ordered the appointment of a receiver, and also ordered that Knight & Co., to whom the debtors had assigned all their accounts, must turn over to the receiver all such accounts and all moneys collected thereon. The receiver has not yet been named.

Frederick Storm has been appointed trustee of Kuhn, Doerflinger & Co., 18 John St., until such time as this firm can realize suffi-



cient money to reimburse him for the sum which he put himself under obligation to pay in their behalf, in order to enable them to make their recent settlement with their creditors. Meantime they will continue their business as heretofore, with Mr. Storm's name associated as trustee.

Louis Tas, the well-known Amsterdam diamond dealer, who has been visiting New York and Chicago, sailed for Europe Thursday, on the *Augusta Victoria*.

F. L. Smith, of the Green-Smith Watch & Diamond Co., Denver, Col., is in this city seeing the New York creditors of the company. He is making his headquarters with Henry Dreyfus & Co., 4 Maiden Lane.

Pursuant to an order signed by Judge Daly, of the Court of Common Pleas, Wm. C. Demarest, assignee of Edw. F. Sanford & Co., is advertising for the creditors of that firm to present their claims to him on or before Nov. 21, 1893, at the office of Norwood & Coggeshall, 140 Nassau St., New York.

**Salesman Angevine Disappears, but his Trunks are Recovered.**

CHICAGO, Ill., Sept. 9.—C. W. Angevine started on a northwestern trip in July, as traveler for Benj. Allen & Co. Toward the latter part of August the Chicago firm received a letter from the chief of police at Butte City, Idaho, inclosing a clipping from a local newspaper, which stated that Angevine had had a row with a woman in a house of ill repute.

Benj. Allen & Co. wired the traveler to come in, and Aug. 21st received a telegram from Angevine at Boise City saying he would be here Aug. 23d. He failed to arrive at the time designated, and on the 25th the matter was placed in the hands of the Pinkerton Detective Agency. After a long search the detectives located the trunks in the baggage room at Pocatello, Idaho, and they are now on the way to this city. Angevine has not been heard from since his dispatch of Aug. 21st, and the Pinkertons have been unable so far to find him.

Why the trunks were shipped to Pocatello is one of the mysteries of the case, and when so shipped why were the checks not forwarded to the firm, are questions the house is unable to answer. Angevine was highly recommended by his uncle, Mr. Marsh, of Marsh & Bigney, and always appeared to be a steady man while at the Chicago house. He had been in the employ of the house for about a year.

F. L. Dunham, Greeley, Col., has failed.

E. A. Bliss, Meriden, Conn., with his wife and daughters, left Sept. 8th for the World's Fair.

M. Mondragon, of M. Mondragon & Bro., Santa Fé, N. M., has absconded, taking part of stock with him. He is city and school treasurer and defaulter as such for about \$5,000. It is said that attachments are about to be issued against the business.

**Partial List of World's Fair Awards in the Jewelry and Kindred Lines.**

CHICAGO, Ill., Sept. 8.—The work of the judges on awards is fast drawing to a close. The following list of the awards made in the lines represented by THE CIRCULAR is unofficial and incomplete. It should be borne in mind that all the reports have not yet been handed in by the judges, so that the respective committees have not been able to accept or reject them. The firms below specified have been awarded medals by the judges in the Department of Artistic Manufactures:

UNITED STATES.

*New York*—Brown Amber Manufacturing Co., Bell & Barber, Leon Favre, L. Straus & Sons, Tiffany Glass and Decorating Co. (5), S. Klaber & Co., Tiffany & Co., B. & W. B. Smith, Dennison Mfg. Co.

*Providence, R. I.*—F. T. Pearce & Co., Gorham Manufacturing Co. (several), O. C. Devereux & Co., R. L. Griffith & Son, S. & B. Lederer, Reynolds Jewelry Co., J. H. Fanning & Co., New England Manufacturers, Arnold & Steere, Payton & Kelley, W. E. Webster & Co., Kent & Stanley Co., Ostley & Barton, Wm. K. Potter.

*Toledo*—Libbey Glass Co.,

*Lyons, N. Y.*—Manhattan Silver Plate Co.

*Meriden, Conn.*—Meriden Britannia Co.

*Newark, N. J.*—Whitehead & Hoag, Wymble Mfg. Co.

*Freeport, Ill.*—Dirksen Silver Filigree Co.

*Hartford, Ct.*—Wm. Rogers Mfg. Co., (3).

*Attleboro, Mass.*—R. F. Simmons & Co., W. & S. Blackinton.

*Bridgeport, Conn.*—Holmes & Edwards Silver Co.

*New Bedford, Mass.*—Pairpoint Mfg. Co.

*Washington, D. C.*—Mary and Emily Healy.

*Pawtucket, R. I.*—G. H. Fuller & Sons.

AUSTRIA.

*Vienna*—Lazarus & Rosenfeld.

*Teplitz*—B. Hellerst & Son.

*Carlsbad*—Philip Fischer.

*Altrohon*—Victoria China Works.

CANADA.

*Ottawa*—P. Wilmot & Co.

GERMANY.

*Berlin*—Court Jeweler Schafer, Cour Jeweler Telge.

*Hanau*—Art Work Union of Hanau, B. Meresheimer & Son, Ochs & Bonn, J. D. Schleissner & Son, Ott & Co., P. T. W. Schlesinger, C. Hertel & Son, F. Kreuter & Co., Ottmar Zicher, E. G. Zimmerman, Villeroy & Bach, Ch. Kissling, F. Kreuter & Co., Kurr, Schüttner, B. Meresheimer, Ochs & Bonn, Fred Schutz.

*Pforzheim*—Paul Suedes, C. Weiblar, Oscar Ostermeyer, A. Pantlen, G. Roessels, Wild & Co., F. Zerremmer, Levin Bros., Emil Ernst Katz, August Kiehule, Louis Keppenheim, Laur & Binder, F. Mahla, A. Pant & Co., Adolph Regan, Fiesler, Louis & Co., Ganss Bros., F. Mahla, W. Stoffler, Albert Wittum.

# LE BOUTILLIER & Co.,

860 BROADWAY,

N. E. cor. of 17th St., - NEW YORK,

Invite an Inspection of their  
Novelties in

ROYAL WORCESTER,

WEDGWOOD,

CROWN DERBY,

COALPORT,

PÂTE SUR PÂTE,

BISQUE.

Prices are very low this season, and dealers will find many exclusive styles in our stock.

*Mainz.*—Martin Mayer (2).

GREAT BRITAIN.

*London.*—Goldsmiths' and Silversmiths' Co.; Doulton & Co.

SWEDEN.

*Stockholm.*—Goldsmiths' Co., limited.

### Philadelphia.

P. L. Ness, of Queen & Co., has returned from his vacation.

G. Gilson will soon begin alterations to his Columbia Ave. store.

J. Albert Caldwell has returned from a visit to the World's Fair.

George W. Scherr started Saturday for a three weeks' visit to Chicago.

It is expected that H. Muhr's Sons' Broad St. factory will resume operations on Monday next.

The style of Mead & Robbins Co., Limited has been changed to Sackett & Co., Limited.

With the beginning of September most of the leading jewelry houses have resumed the regular closing hours.

Jacob Muhr is one of the delegates of the Young Men's Democratic Association to the general assembly of Democratic clubs.

Joseph H. Brazier and James Riley, of J. E. Caldwell & Co., have been spending most of the Summer together at Atlantic City.

John S. Allen, of the jewelry firm of John S. Allen & Co., Minneapolis, was in Philadelphia last week attending the funeral of his mother.

After spending six weeks in a hospital, a victim of inflammatory rheumatism, C. A. Frazier, of Hancock, Becker & Co., revisited the trade in this city last week.

Phillip McDevitt was committed to prison on Friday by Magistrate Clement charged with being implicated in robbing the jew-

elry store of John F. Bates, 3402 Market St., last month.

Among the traveling men in Philadelphia last week were: Clifford Booth; Charles Brinck, Crescent Watch Case Co.; Eugene Kingman, G. A. Dean & Co.; Robt. L. Moorhead, R. L. Moorhead & Co., and Wm. Mount, T. Quayle & Co.

Wm. B. Peck, a colored man of Beverly, N. J., was brought from Washington last week, and held for court by Magistrate Pole, on the charge of larceny as bailee of three watches valued at \$205, the property of W. A. Satterfield, 1802 Addison St.

Richard Robinson, of T. G. Frothingham & Co., was here last week. He told his friends that arrangements were now completed for the beginning of business of the new firm of Robinson, Richardson (Harry) & Gardner (Thomas), gold goods, at Providence, R. I., and that the New Year would usher in the new house. Mr. Robinson will be the firm's representative on the road.

### Canada and the Provinces.

The stock of S. Nash, Barrie, Ont., has been advertised to be sold by auction on 11th inst.

The wife of Alfred Eaves, Montreal, presented him with a son at Saranac Lake, N. Y., on Sept. 6th.

F. Percy Webster, jeweler and clock maker, has placed an electric clock over the delivery window of the postoffice at Windsor, N. S. This clock is set in a frame, and is connected with a regulator in the window of Mr. Webster's establishment.

There is a probability of trouble over the financial affairs of D. L. Gordon, a jeweler of Toronto, who recently assigned. Sheriff Mowat is endeavoring to follow certain portions of the estate now in the possession of outsiders, who claim a right to them.

Samuel Levi, the "gold dust" operator, accused of defrauding A. Rosenthal, of Toronto, out of \$2,000, was brought before Judge Muir, in Hamilton, Ont., last week to elect and he elected to be tried by His Honor without a jury. The trial was fixed for Levi.

### The Attleboros.

T. G. Frothingham and F. D. Heffron have been touring the State on bicycles.

M. W. Steer, who has been doing business on a small scale, has closed his shop and gone to Chicago.

H. U. Wilson has gone to New York where he will assume charge of the business of the Plainville Stock Co.

H. F. Barrows' suit against the Old Colony Railroad for land damages came up last Wednesday. It was continued for two weeks.

John M. Fisher, James W. Luther and W. H. Briggs were delegates at the Massachusetts State Prohibition meeting, at Worcester last week.

Charles P. Young, of Young & Stern, is having a large greenhouse erected at the rear of his residence. He will enter the retail florist business when the social season is on.

Joseph F. Lynch has purchased the interest of F. M. Merck in the firm known as the North Attleboro Enameling Co. Mr. Merck has again started in business in the Hopkins building.

Charles E. Sandland, formerly of Sandland, Palmer & Co., has opened a shop in the Totten building. His specialty will be enameling. There seems to be an abundance of enameling firms of late. A year ago there were only four.

Anna L. Tweedy, Harriet T. Richards and E. Ira Richards have presented to the town of North Attleboro a large lot of land on the corner of Grove and Washington Sts. for a public library site. The three donors will also erect a suitable building there to be used as a library.

The arrangements for the coming celebration of the 400th anniversary of the town of Attleboro are being completed. E. S. Horton is chairman of the general committee. At a special meeting of the citizens of North Attleboro, Wednesday night, it was voted not to participate in the celebration. North Attleboro claims to be the original Attleboro, and the vote has caused much ill feeling. One of the plans of the committee is to have a grand exhibit of manufactured jewelry, one that will exceed anything attempted by local manufacturers at any previous time.



ESTABLISHED 1870.

**J. L. CLARK,**

**SWEEP SMELTER AND REFINER OF GOLD AND SILVER.**

Buys every kind of Gold and Silverware, Jewelry, Watches and Platinum. Full market value paid.

**No. 724 Filbert Street, Philadelphia, Pa.**

SEND BY EXPRESS or Registered Mail. If my price is not satisfactory, I will return all articles.

**J. H. DEDERICK, JR.,**

—DEALER IN—

**Roll Plate Jewelry and Chains,**

Optical Goods and Jewelers' Supplies, &

**16 MAIDEN LANE, NEW YORK.**

JET GOODS A SPECIALTY.



### Jules Jürgensen

OF COPENHAGEN.

The reputation these watches have maintained for Fifty Years has never been equalled, being made on strictly scientific principles and no expense spared to give the Best results in mechanism and timekeeping qualities.

SOLE AGENTS,

John C. Hyde's Sons,  
NO. 22 MAIDEN LANE.

### WM. BIRMINGHAM & CO.,

MANUFACTURERS OF

All Kinds of Leather Spectacle and Eye Glass  
**CASES,**

728 Arch Street, PHILADELPHIA, PA

No jeweler or watch repairer should be without a copy of "WORKSHOP NOTES," a new and very useful book for the workshop. Send for circular containing a complete index of the book, and judge of its merits for yourself.

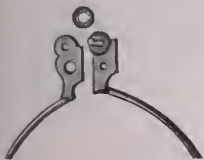

Racine Jewelry Mfg.  
CO.,  
SPECTACLE TEMPLE  
WASHERS,  
Gross in a Bottle, 25c.  
For Sale by Dealers in Job-  
bing Materials

# BLANCARD & CO.,

LATEST ROCOCO DESIGN IN GALLERY.



DIAMOND SETTINGS. GALLERIES. HOLLOW BALLS, ETC.

SEND FOR OUR CATALOGUE.

45 & 47 John St., New York.

## WALTHAM REPEATERS

STRIKING HOURS AND MINUTES.

TO THE TRADE:—

Having purchased the entire remaining stock of WALTHAM REPEATING MOVEMENTS from the American Waltham Watch Co., and cased them in 20 year 14k. Cases, I am prepared to sell them at prices 30 per cent. less than they have ever been offered before.

Artistic Special Catalogue Free.

Send for Prices and Terms.

## JOHN B. YATES,

21 & 23 MAIDEN LANE, NEW YORK.

S. C. JACKSON, 180 BROADWAY, NEW YORK.

MANUFACTURER OF

Fine \* Cases \* for \* Jewelry, \* Silverware, \* Etc.

ALSO SHOW CASE TRAYS AND FANCY HARD WOOD WORK.

Samples sent on application. Estimates furnished.

# MATHEY BROS., MATHEZ & CO.

21 & 23 MAIDEN LANE, N. Y., and BRASSUS, SWITZERLAND.

MANUFACTURERS AND IMPORTERS OF

Plain and Non-Magnetic Movements.

Complicated Watches a Specialty.

A FULL LINE OF 10 and 16 SIZE

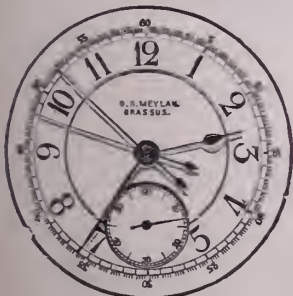

SIZE 10.

# SPLITS



10 SIZE.

# Geneva Optical Company.

Our new catalogue giving new prices, new goods and a full line of Optical Outfits, Trial Cases, Lens Measures, Prism Measures and all kinds of Optical Goods now ready, and sent at request.

WE ILLUSTRATE BELOW A FEW OF OUR NEW SPECIALTIES.



### COMPLETE SET TRIAL LENSES.

No. 995. Contains 32 pairs+(convex) spherical, .25 to .20D; 32 pairs (concave) spherical .25 to .20D; 20 pairs+(convex) cylinders, .25 to .6.50D; 20 pairs-(concave) cylinder .25 to .6.50D; 10 prisms; 4 pairs, plain colored lens; 1 white glass; 1 half-ground disc; 2 stenoptics; 1 solid and 2 discs with small hole; discs of hard rubber.

Rims on all the lenses, nicked on the convex, gilded on concave.

Graduated trial frame No. 915. Plain trial frame No. 919. All in well made morocco case, lined with velvet.

This case for accuracy, we are willing to have compared with any either of foreign or American manufacture.

The exceptionally low price, must not be taken to indicate its quality, as that must be judged by the case itself. Price \$59.00.

**Special offer 10 and 6 off, net Cash \$50.00.**

### OUR PRESCRIPTION WORK

is now the most accurately and promptly done. Try a month and see.

### DIRECTIONS TO USE THE PRISM MEASURE AND LENS CENTERING INSTRUMENT.

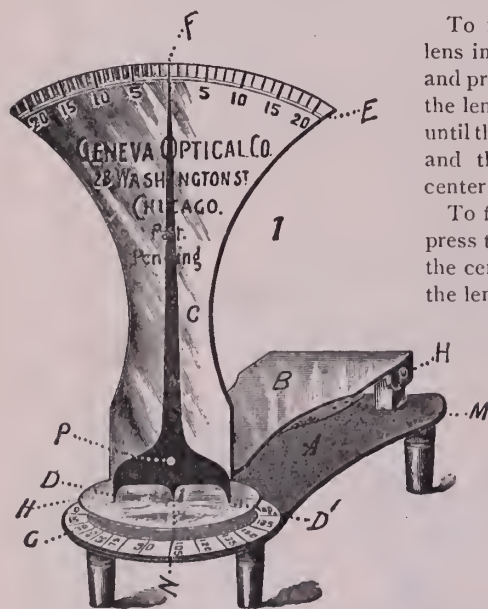

To find the center of a lens, put the lens in as shown in illustration at "H," and press the points "DD" down firmly on the lens, sliding it across the instrument until the index finger "F" points to "O" and the center point will be over the center of the lens.

To find the amount of prism in a lens, press the points "DD" firmly down with the center point "N" over the center of the lens. The index finger will point to the degree indicating strength of prism either plain or in combination with spherical or cylindrical surfaces.

To cut a spherical or cylindrical lens to get any required degree of prism, find the points in the lens, where the index finger will indicate the degree of prism required, and cut the lens with its center at the point

under the center points of index finger. Price \$5.00.



### THE GENEVA LENS MEASURE IMPROVED.

"You press the lens, it tells the focus."

For full description see catalogue.

Price \$10.00.

67 & 69 Washington Street, Chicago, Ill.

# WORLD'S FAIR and WESTERN SUPPLEMENT of THE JEWELERS' CIRCULAR

CHICAGO OFFICE: ROOM 308, INTER-OCEAN BUILDING.

VOL. XXVII.

CHICAGO, WEDNESDAY, SEPTEMBER 13, 1893.

NO. 7

## OPTICAL PRODUCTIONS AT THE WORLD'S FAIR.

PART II.—GENEVA OPTICAL CO.

THE exhibit described in the last CIRCULAR, of the Geneva Optical Co., in the gallery of Liberal Arts, was notable for instruments showing the advances recently made in optical science; the manufacturing plant of the company in the extreme northwest of Machinery hall simplifies to the average mind the processes of manufacture of lenses. The liberal arts display teaches the methods and instruments used in locating the errors of eyesight and determining the prescription for their correction; the factory in Machinery hall supplements this and gives an insight into the mechanical operations from the written prescription to the completed spectacles. The combined exhibits constitute a valuable lesson in optics.

It is usually necessary in optical factories to secure a permit to enter the secret portals, and few even among those who

sell the product, avail themselves of the restricted opportunities for examination. There is no secrecy at the World's Fair factory of the Geneva Co., and the operations are shown *in extenso*.

The factory occupies 12 x 15 feet between columns S 46 and 47. Two sides are given to oak framed show cases wherein are

shown frames and lenses of spectacles in large numbers, eye-glasses and eye-glass chains, tortoise shell eye-glass holders, spectacles with silver chains and ornamentation, lenses, prisms and masses of rough quartz. At the corner of the avenues are test types in a brass box frame

same cut and polished on one side, the slab in the process of slitting, the rough slab, slab polished on one side, and the finished pebble as used.

Running lengthwise of the factory is an optician's bench with tools and machinery for doing everything in the manufacture of

spectacle lenses. It is interesting to follow the process. The square slab of glass is fastened to an iron plate, which is placed on a revolving disc in an emery pan and held in position by a swinging lever. Emery is placed on the disc, and the grinding is continued until the necessary curvature and fine finish is obtained, when the lens passes to another disc on which a cloth sprinkled with rouge is fastened, and the lens is polished by friction. It is then removed from the plate and the other side is treated in a similar manner.

Some 150 discs are required for the

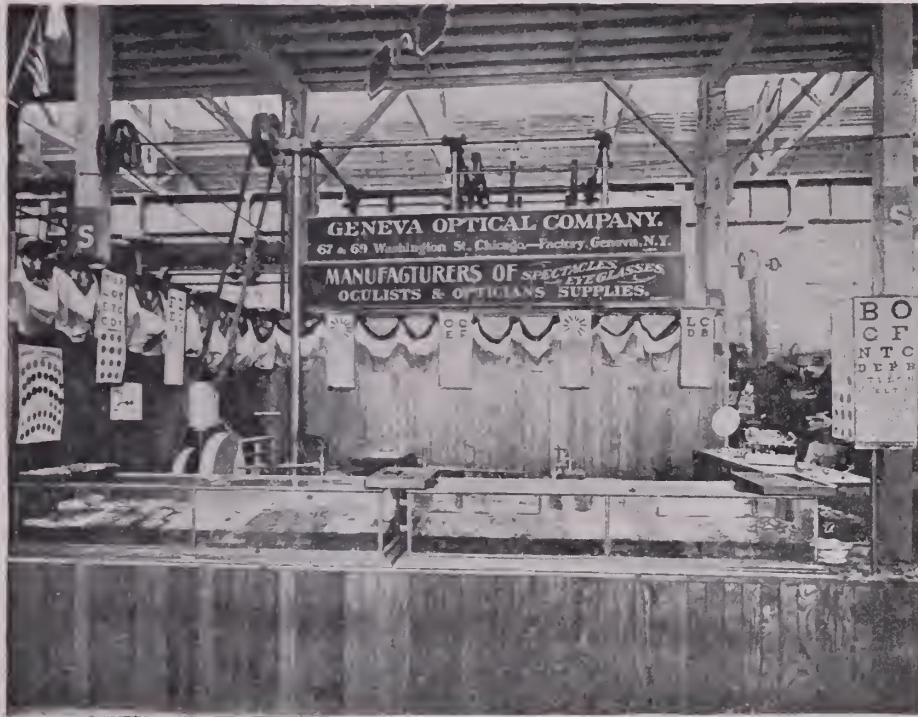

EXHIBIT OF THE GENEVA OPTICAL CO. IN MACHINERY HALL.

supported by a brass rod, while reading glasses and trial cases have a position on the cases. Walls 8 feet high take up the rear sides to the south and east, and display the various charts of the profession, cards of colored lenses, and a card showing the process of manufacture of pebble lenses including the rough stone as imported, the

many necessary curvatures and three or four grades of emery to secure the requisite finish. The square polished lens is then taken to a lens cutting machine of the company's own make and patent, and cut into the shape required. Thence it passes to a grinder, who abrades the edge to fit the frame. The factory is a scene of great ac-

**THE PLANCHAMP & BECKER CO.**  
Makers and Repairers of  
**WATCH CASES,**  
Gold and Silver Plating —  
— of Watch Cases a Specialty.  
UNEXCELLED FACILITIES.

63 and 65 East Washington St., Chicago.

**PARSONS & SCHOOL**  
— FOR —  
**WATCHMAKERS,**  
PEORIA, - - - ILL.

Send for Circular and Terms.  
**PARSONS & CO.**

**CHICAGO WATCH TOOL CO.**  
SPECIAL MANUFACTURERS OF  
JEWELERS MACHINERY,  
WATCHMAKERS and  
JEWELERS TOOLS  
ETC.  
52 MADISON STREET  
CHICAGO  
TOOLS MADE TO ORDER

tivity and is one of the most interesting sights in Machinery hall. There is a large attendance and the corps of assistants is always busy giving practical illustrations of the work by testing the eyes of visitors.

The men employed by the company for this purpose are skilful opticians, who have given the subject close attention. Thousands of visitors have given orders to their local opticians, and knew the glasses were made elsewhere; but before seeing the Geneva factory at the Fair, they little realized the magnitude the prescription trade

had reached. The Geneva Optical Co., by the excellence of their work, have built up this branch of the trade till it has largely exceeded in magnitude the hopes of the management who state business in this line the past month was the most extensive in the history of the house. The test room, 15x20 feet, is fitted for practical use.

A. I. Agnew, in charge of the Machinery hall exhibit, with eight assistants, reports a steady growth of business, that of the past week being the largest since the opening of the Fair.

*(Series to be continued.)*

**An Historical Diamond Set.**

IN a north case of the Geneva pavilion of the Swiss section has been placed on exhibition a magnificent \$30,000 diamond set, consisting of necklace, two lace pins and a pair of earrings, set in platinum on a gold base. The necklace has for a center stone a four karat stone of great beauty. To the right and left are a five-pointed leaf, incrustated, and diamonds in pairs alternating with leaves.

The lace pins have a branch bearing two five-leaved flowers incrustated with large stones. Diamonds in threes spring upward from the branch and a cascade of large gems on ten gold jointed platinum wires extend three inches below the branch.

In the earrings three stones of between one and a half and two karats on a perpendicular wire, surmount three incrustated leaves with serrated edges, and from these depend two magnificent diamonds, one round and the other pear shaped. The entire earring is some two inches in length. All settings are in solid beveled bands of platinum on gold.

This magnificent set of jewels was inherited from the Russian general, de Mansoureff, the diamonds are from ancient decorations, and presents made by the Czars, and came from the diamond mines in the Ural Mountains. It is a well-known fact that these mines, now extinct, belonged to the Russian Crown and that the quality and beauty of the stones surpassed even the famous Indian brilliants. The Crown of Russia preserved for its personal use and for its presents only the very finest of the stones, and this explains the presence in the set of only perfect stones of the very finest water.

The set must have been mounted in Paris according to the drawings of Froment Meurice, by Tottin, the king's jeweler, whose name to this day exists on the morocco case. The brilliants, one or two of which were re-cut in Geneva, are of extraordinary hardness. The work was executed by most skilled workmen, who at the same time cleaned and remounted the whole of this wonderful work of art.

O. H. Hull, assistant manager for the Pairpoint Mfg. Co.'s Chicago house is on his Colorado trip.

**JEWELERS.**

We guarantee to sell you Sterling Silver Flat Ware at a less price than any other manufacturer, and give you newer designs. We will increase your profits if you will let us. Is it not worth trying?

**OVAITT & WARNER, Silversmiths,**  
PORTLAND, OREGON.

**DALE CHUCKS.** Dale Chucks are used for mounting watch movements.

Manufactured by  
**HOROLOGICAL TOOL CO.,**  
86 N. CLARK STREET,  
CHICAGO.  
For Sale by all Jobbers.

**IRONS & RUSSELL,**

(SUCCESSORS TO CHARLES F. IRONS.)  
MANUFACTURERS OF

**SOLID GOLD EMBLEMS ROLL PLATE**  
PINS, CHARMS AND SOLID GOLD RINGS.

102 Friendship Street, - - Providence, R. I.



**HENRY J. ROHRBACH,** 94-96 State Street, (Room 524.) CHICAGO.  
SILVERSMITH AND MANUFACTURING JEWELER.

**COLD, SILVER AND NICKEL PLATER.**  
Silver and Silver-Plated Ware of all kinds Repaired, Replished and Polished at Low Prices.  
SEND FOR PRICE LIST.

ALL KINDS OF BRONZES REPAIRED AND REBRONZED.  
Full facilities for manufacturing and repairing all classes of Jewelry for the Trade.  
Remember—Room 524.

QUALITY IS THE STANDARD OF VALUE.

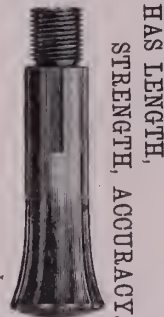
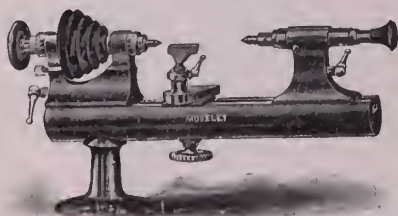

ONE OF THE BEST OF THE VERY BEST.

HAS LENGTH, STRENGTH, ACCURACY.

MEN INTERESTED WRITE YOUR JOBBER OR

**MOSELEY & CO., - - ELCIN, ILL.**



**GIBSON HOUSE,**

CINCINNATI, OHIO.  
ABSOLUTELY FIRST-CLASS AMERICAN PLAN HOTEL. \$3.00 PER DAY

Extra Charge for Parlors and Rooms with Bath attached. The unequalled advantages in central location, liberal management, modern appointments, experienced service and perfect cuisine, have permanently established the Gibson House as **The Most Popular First-Class Hotel in Cincinnati.**

AMPLE VAULTS FOR THE PROTECTION OF VALUABLES

**THE GIBSON HOUSE CO.,**

H. B. DUNBAR.

President and Manager



# ARE YOU GOING TO THE WORLD'S FAIR?

If You Are Let Us Give You A Pointer.

Collect all the Old Gold, Silver, Plated Scraps, Bench Sweeps, bring same with you, call and see us, we will value your Gold, etc. accurately, and pay you for same while you wait. In this way you can pay a portion or perhaps all your expenses to the World's Fair. If you are not coming, or have more Gold, etc. than you wish to hold, would be pleased to have you ship same to us. Immediately on receipt we will remit by cash or draft. If our offer should not prove satisfactory we will return consignment intact and pay all charges.

Make us a trial shipment and you will ship again. Our Guide to Chicago and the World's Fair, mailed free on application.

**GOLDSMITH BROS.,**  
Gold and Silver Refiners and Assayers,  
63 & 65 Washington St.,

Near State,

CHICAGO, ILL.

MENTION THIS PAPER.

HOROLOGY AT THE WORLD'S FAIR.

PART XIII.—A REMARKABLE NARDIN WATCH.—THE BENJAMIN WATCH.

THE richly chased double cased watch in the exhibit of Paul D. Nardin, successor to Ulysse Nardin, Locle, is a beautiful specimen of case work and merits and receives the close attention of workers in precious metals. The inside case is of solid gold surrounded by an outer case and frame of oxidized silver. The rich effect of perspective is finely brought out in the metal chasing on the obverse and reverse of the case.

The obverse represents labor. A man sits on a low bench with a sledge in his left hand and the right resting on a geared wheel; at his feet is a vise, and in the distance retorts and factory smokestacks. An angel holds above his head a laurel wreath and near by are the Latin words, *Gloria labori*. The reverse represents the industrial arts. In the top center, a bust of Minerva stands on an Ionic pedestal. On the right is a branch of oak leaves, and on the left a laurel branch. About the pedestal, in the lower half of the case, are various implements used in the arts, prominent among which are a painter's easel, with landscape, painter's palette and brushes, a triangle, square, dividers and scroll of parchment. To the left of the pedestal rise two towers in the distance.

About the two chased plates is a deep bezel of gold and about the case a frame of oxidized silver with gold points at bottom and each side. A leaf scroll extending onehalf inch from the case ornaments the bottom and scrolls with foliage are at either side. The side scrolls are surmounted with a tiger's head and above these, with feet resting on the tiger heads are two infant boys, the one holding a laurel branch, the other a chain. The stem is urn shaped with simple decoration in relief, and the winding crown and bow are of solid gold.

The chasing of this case required six months of time by the most expert chaser in the Nardin factory. The entire piece from the ornament at the bottom to the top of ring measures 4 inches, and is 3 inches

exhibited in a red morocco chamois lined case following in shape the outline of the watch frame, and occupies the position of honor in Nardin's exhibit facing Columbia Ave., at the north end of the Swiss section, in the Neuchatel pavilion. Through the courtesy of Jules Jeanneret, in charge of the Neuchatel pavilion, THE CIRCULAR is enabled to illustrate this art work.

THE BENJAMIN WATCH.

The Benjamin watch, recently mentioned in THE CIRCULAR, is exhibited in the New South Wales pavilion, British section, Manufactures building. The principle embodied has been the life study of the inventor, Marcus Benjamin, of Sydney, and has aroused much interest among the judges of horology and those versed in watchmaking. It is an independent, dead-beat, center seconds stop watch, with one movement, and is unusually simple in construction. To get a full second with one beat, a watch of this kind was formerly made with two movements. By this improvement the mechanism for the center-second movement is reduced by seventy-five per cent., and the full beat second is recorded with the same movement. All the wheels and the setting of the jewels are in gold, and also the mounting of the case. It is patented in New South Wales, Victoria, United States, Great Britain, France, Germany and Switzerland.

Jurors Rouge and Tissot devoted two hours to an official examination of the watch, and Dr. Carpenter said he would have been very sorry had he missed seeing it. The watch can be manufactured at a low price, but it would upset established plants to undertake it.

(Series to be Continued.)



THE REMARKABLE DOUBLE CASED NARDIN WATCH.—OBVERSE VIEW.

across. The movement is a 20-line repeater and chronograph as well as a timepiece of very high class, and has secured a first-class certificate from the Neuchatel Observatory. It has also a minute register. As a work of art the movement as well as the case stands high. The watch is valued at \$2,000. It is

THE FINEST OILS EXTANT:



\$1000 CHALLENGE FOR THEIR EQUAL.



**Colonial Relics at the World's Fair.**

THE exhibit of the Colonial Board of Lady Managers in the rotunda of the United States Government building is particularly rich in historical treasures, in which watches, jewelry and silver articles of the Revolutionary period fill an important place. The antique watches scattered throughout the exhibit are viewed with interest rather for their historical associations with the early makers of American history than for their value in showing the great strides the watchmaking industry has made in the past hundred years, the display of antiques by the American Waltham Watch Co., the Keystone Watch Case Co. and Patek, Philippe & Co., being of far greater value from an educational point of view.

There is a great similitude in the outer appearance of watches of Revolutionary days, all with a single exception being open faced and cased in gold and silver. The exception is a medium sized gold hunting case watch presented by Chief Justice John Jay to his niece, Jane Livingston, on his return from his mission to Spain in 1784. The case has an engraved scroll center and hand turned engraving with lines quite widely separated. A long, slim stem with large bow gives the piece an odd appearance.

On a single cushion are five watches that attract much attention. The battle of Rocky Brook, near Lake George, is recalled by the watch taken from General Dieskau, on that occasion (1755), by General Seth Pomeroy. Dr. Mather Byles timed his sermons and witticisms with a leather cased watch which had descended to him as an heirloom. An enameled gold watch belonging to Mrs. John Adams was purchased for her in Paris in 1783, and gold opened faced watches were carried by John Adams

and John Quincy Adams, the latter having attached a heavy gold seal. The peculiarity of all these lies in their unusual thickness, all being nearly an inch thick, the long, slender stems terminating in small bows.

A silver cased, open faced watch, fully three inches in diameter, lay upon the table on which the Declaration of Independence was signed at the time of signing; it has a seconds dial, and the hours are marked with Arabic figures. The dial is broken, a piece being missing, and the time-piece has evidently been *hors concours* for many years. Mrs. Lydia Darrah, on the morning of Dec. 3, 1777, timed her departure from Philadelphia by an open faced silver watch, and warned Washington's army at White Marsh, in time to frustrate Howe's attack the following day.

As showing how watches were regarded as heirlooms in those days is instanced an open faced silver watch with silver dial bought by Peregrine White in 1655. The watch remained in the White family till 1808 and then by reason of there being no male issue, it passed to the May family, who loaned it to the Colonial Board. On the white dial of an open faced, silver center seconds watch belonging to Joshua Huntington, a commander in the Revolutionary war, are three circles of figures. The outer, 5, 10, 15, etc., in Arabic figures, marks the minutes; next come Roman numerals for the hours, and the inner circle has each of the sixty seconds marked in Arabic figures. A watch with double circles for hours and minutes was owned by James Lloyd, of Wye, Md., in 1691. It is an open faced gold case an inch thick and has steel hands.

The gold watch given by Mrs. Washington to Mrs. Curtis was open faced with white dial, gold hands, and engraved bezel. Large gold watches were carried by John

Trumbull, the painter, and John Cotton Smith, the last charter Governor of Connecticut. Count Rochambeau, in his Rhode Island conference with General Lafayette, during the Revolution frequently drew from his pocket a medium sized gold bullseye. A curiosity in the clock line is shown in the Forest County, Pennsylvania, colonial exhibit. The white four-inch dial is set into a black board 8x9 inches in size. Between the dial and each corner are four brass decorations and a wreath of brass encircles the dial. This clock was brought to Forest County by the family of Gilbert Jameson, of Ayr, Scotland, and is alleged by them to be over 200 years old.

*(To be continued.)*

**Artistic Coral Work at the Fair.**

THE coral exhibited at the Fair is confined almost exclusively to the displays of Giacinto Melillo, Michele Piscione and Rocco Morabito, in the Italian section. Rare pieces are shown in all these cases, and the opportunity is here given lovers of coral to feast their eyes to their heart's content.

A fine set in the case of Giacinto Melillo is diamond ornamented, and consists of brooch, bracelet, ring and earrings, valued at \$1,300. Necklaces in this exhibit reach as high as \$1,000, and quite a number approach that sum in value. The majority are of the ball pattern, graduated in size from the centre ball. Melillo is *fournisseur* of the courts of Italy and Greece, and won gold medals at Paris, London and Amsterdam, besides orders and diplomas of honor. Sig. Melillo was member of the jury at Milan, 1881, and at Liverpool, 1886.

The exhibit includes cameos, carved shells, and work in Vesuvian lava, in copies of Pompeian originals, and of those in the principal museums of Europe.

**The Wadsworth Watch Case Co.**



Filled



Cases.



General Offices,  
NEWPORT, KY.

Chicago Office,  
COLUMBUS BUILDING.

# BAUME & CO.,

21 HATTON GARDEN, LONDON, ENGLAND,  
AND SWITZERLAND.

EXHIBITORS AT CHICAGO OF

## TOURBILLION CHRONOMETER WATCH,

WHICH HOLDS THE RECORD AT ROYAL OBSERVATORY KEW.

HIGH CLASS SWISS WATCHES, PLAIN AND COMPLICATED.

PATENTEES FOR SPLIT SECONDS CHRONOGRAPHS (Treble Action.)

AGENT FOR U. S., GEO. E. WILKINS, SYRACUSE, N. Y.

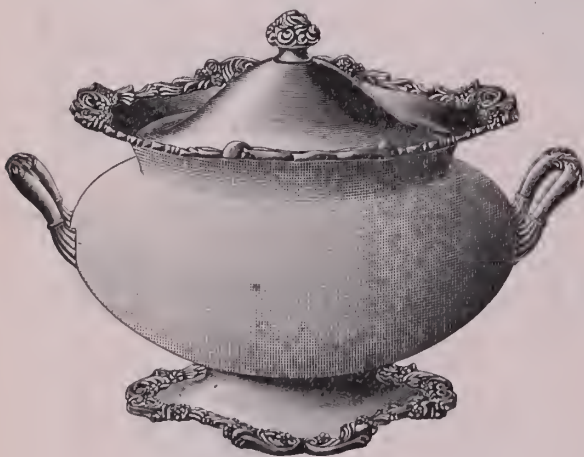

249.—SOUP TUREEN.

As Regards

SILVER PLATE

WE BELIEVE

THAT an Honest article at an Honest price goes further toward making sales than all the advertising in Christendom,

AND WE WORK ACCORDINGLY.

MAKING and SELLING a BETTER Article for the SAME MONEY, or an EQUAL Article for LESS Money than any other concern, is the principal cause of our fast increasing business.

## HOMAN & COMPANY,

CINCINNATI.

Visitors to the Columbian Exposition, Remember our Complete Line is displayed at  
155 STATE STREET, CHICAGO.

**Chicago.**

Buyers and visitors in Chicago and at the World's Fair last week included :

T. B. Shaffer & Co., Wyoming, Ill.; A. K. Jobe, Jackson, Tenn.; S. Kronholtz, Stamford, Conn.; A. Bromley, Ailsa Craig, Ont.; Bonney Metzger, Kansas City, Mo.; H. Wilbur Hardie, Allegan, Mich.; T. A. Simonds, St. Thomas, Ont.; Wm. B. Peters, Bloomville, N. V.; S. C. Burnham, Janesville, Wis.; Alex. Beckman, Ottawa, O.; Charles H. Judson, Rochester, N. Y.; C. F. Fisher, Cleveland, O.; D. D. Williams, Emporia, Kan.; H. L. Stark, Bethany, Mo.; Pappmeier & Sons, Beardstown, Ill.; M. J. Quinn, Auer's Jewelry Establishment, Albany, N. Y.; W. S. Tussing, Columbus, O.; M. Meckes, Cleveland, O.; E. H. Drinkwater, Toledo, O.; F. H. Bidgood, Grand Rapids, Mich.; R. D. Carstens, Grand Rapids, Mich.; D. & R. Jacobs, Cincinnati, O.; H. Lange, Cincinnati, O.; William L. Van Alstyne, Troy, N. Y.; Edward P. Sundberg, Fargo, N. D.; Irvin H. Park, Big Springs, Tex.; L. Cornelius, Prairie du Chien, Wis.; E. S. Saunders, Wyoming, Ia.; M. Forhan, Owen Sound, Ont.; Elias L. Glouskin, New Haven, Conn.; W. P. Dolle, Columbus, O.; A. G. Frank, St. Joseph, Mo.; Walter A. Buck, Jackson, Miss.; Frank Darrenouge, Reedsburg, Wis.; Downs & Gunther, Bellevue, O.; J. H. Bihl, Fremont, O.; Wight Bros., Hawarden, Ia.; F. E. Ladd, Springfield, Mass.; B. T. Schmauk, New York; Bassett & Fairbank, Jacksonville, Ill.; Bauer Bros., Zanesville, O.; W. L. F. Rosenblatt, Greenville, Tenn.; H. N. Clark, Oberlin, O.; Wm. Andrews, St. Mary's, Ont.; Francis J. Steibel, Baltimore, Md.; Siegel Bros., West Superior, Wis.; R. A. Davison, Rock Falls, Ill.; E. Stall, Bryan, O.; A. Beinhorn, Winona, Minn.; R. A. Buckmaster, Argyle, Wis.; Geo. Logemann & Sons, Milwaukee, Wis.; F. W. Wolff, San Jose, Cal.; John F. Kohler, Richmond, Va.; S. W. Percy and wife, Ogdensburg, N. Y.; Hoffman & Robinson, Newark and Lyons, N. Y.; S. C. Parrott, Trenton, N. J.; Chas. W. Smith, Elyria, O.; Saml. B. Mann, New York; Chas. E. Axt, Odell, Ill.; E. G. Alber, Kansas City, Mo.; Geo. A. Barron, Boston, Mass.; Chas. A. Dreiss, Ontonagon, Mich.; Henry Mehmert, Olney, Ill.; N. J. Battersheld, Heyworth, Ill.; Chas. E. Hamer, Philadelphia, Pa.; Mrs. W. C. Ritter, Sioux City, Ia.; John A. Black, Tucson, A. T.; Theodore A. Grothe, Montreal, Can.; Chas. Schwartz, Philadelphia, Pa.; N. H. Jepson, Washington, Ind.; Brauns Bros., Upper Sandusky, O.; C. S. Sherwood, Portsmouth, Va.; Simper Bros., Cincinnati, O.; W. O. Sanders, Manley, Ia.; M. F. Kohler, Parsons, Kan.; M. F. Warren, Colorado Springs, Col.; S. C. Binkley, Hamilton, Ont.; G. O. Warren, Sycamore, Ill.; Th. Kuehl, Berlin, Germany; E. H. Wilson, Markham, Ont.; F. A. Bishop, Allen, Mich.; E. Keller, Allentown, Pa.; H. M. Longhead, Marinette, Wis.; G. Scherzinger, Fond du Lac; Fred Claringbowl, Hamilton, Ont.; D. H. Strouse, Peru, Ind.; Chas. W. Smith, Elyria, O.; W. De Graff, New Buffalo, Mich.; E. R. Albaugh, Homer, Mich.; T. J. Ellis, Jonesboro, Ark.; O. B. Blackley, Cedar Rapids, Ia.; J. Wilson, Williamsport, Pa.; Jesse M. Poe, Rushville, Ind.; W. C. Sherman, Orlando, Fla.; J. H. Heiman, Cleveland, O.; Wm. Kline, New Orleans, La.; L. W. Kurten and wife, New Orleans, La.; C. C. Breese, Murfreesboro, Tenn.; J. Wolf, Rochester, N. Y.; Alphonse Judis, San Francisco, Cal.; E. F. Starks, New Point, Ind.; T. K. Bolton, Ashland, Ore.; M. Sherman, Woodstock, Ill.; W. F. Zietz, Helena, Mont.; F. A. Parsons, Odebolt, Ia.; Geo. P. Coggsell, Detroit, Mich.; M. Morris, St. Louis, Mo.; S. W. Percy, Ogdensburg, N. Y.; James A. Smyth, Renovo, Pa.; F. Mink, Philadelphia, Pa.; Henry Deck, Philadelphia, Pa.; John Whitman, Petersburg, Ind.; Chas. F. Gordon, Milwaukee, Wis.; Frank W. Boucher, Ackley, O.; Max Lowy & Co., Louisville, Ky.; Ellen M. Lee, Ogdensburg, N. Y.; Mrs. J. L. Shepherd, Brooklyn, N. Y.; Will S. Pitt and wife, Oelwein, Ia.; H. E. Porter, Wamego, Kan.; A. K. Jobe and wife, Jackson, Tenn.; Wm. C. Ward, Winchester, Ky.; L. H. Fuller, Waterville, Minn.; Thos. A. Craig, Macon, Mo.; H. E. Jordan, Massena, N. Y.; R. Deschauer, Maryville, Mo.; M. Karst, Racine, Wis.; Jacob Adler, New York; Millard Veit, New York; Hugo Carlman, Mobile, Ala.; Olin V. Neal, Parkersburg, W. Va.; C. F. Fischer, Cleveland, O.; Chas. Reineman, Allegheny, Pa.; Chas. G. Beekman,

**OTTO YOUNG & CO.****WHOLESALE ONLY.****Diamonds, Watches, Jewelry, Silverware, Tools and Material,**◁ **OPTICAL GOODS, ETC.** ▷**149, 151 & 153 STATE ST., CHICAGO, ILL.**

WE will soon issue our new Illustrated Catalogue. It will be sent by Express or mail, prepaid, to all legitimate Jewelers, in territory tributary to Chicago. It will contain a full line of all staples and novelties required by Watchmakers and Jewelers. The goods are right and the prices uniformly low, and we trust to receive frequent orders from you for goods selected from its pages.

**IF YOU DO NOT RECEIVE A COPY OF SAME, ADVISE US.**

In addition to our regular stock, we have a large line of discontinued American made watch movements, in 18, 16 and 6 size, which we offer at greatly reduced prices and we will be pleased to write you fully regarding same, upon application.

**RECEIVER'S SALE.**

ENTIRE Stock of **Giles, Bro. & Co.** Fourth Floor Masonic Temple, consisting of Diamonds, American and Swiss Watches, Jewelry, Silver and Plated Ware, Tools, Materials, etc. will be sold in lots to suit the purchasers, at large reduction from original cost price.

An unusual chance for live Jewelers to obtain bargains.

W. H. GLEASON, Receiver.

July 14th, 1893.

Kendallville, Ind.; Boston Wilson, Oklahoma City, O. T.; H. Oberdorfer, Baltimore, Md.; Gus Levy, Henderson, Ky.; Frank E. Fee, Hartley, Ia.; Ben Martin, Logansport, Ind.; A. A. Wessel, Albany, Wis.; S. L. McKee, Wilmington, Del.; W. W. Pearce, Wichita, Kan.; Peter Lindenstruth, Pensacola, Fla.; G. E. Capron, Frankfort, Mich.; Gardner L. Conley, Albany, N. Y.; Harry C. Slingerland, Albany, N. Y.; John W. Poe, St. Louis, Mo.; Leo & Kiefer, Kansas City, Mo.; F. A. Fiedler, Milton, Pa.; Israel De Roy, Pittsburgh, Pa.; S. T. Hammond, Buffalo, N. Y.; John E. Lane, Washington, D. C.; Morgan Lewis, Syracuse, N. Y.; T. G. Burkhardt, Jefferson City, Mo.; J. P. Ernst, Sunbury, Pa.; Wm. H. Oldach, Springfield, Ill.; Fred A. Merritt, Dimondale, Mich.; Ben Bergfield, New York; Martin Burk, Detroit, Mich.; W. S. Orth, Dunkirk, O.; J. A. Shomaker, York, Pa.; D. D. Doolittle, Sabetha, Kan.; R. M. Munsch, South Bend, Ind.; J. W. Mahan, Brandenburg, Ky.; Jas. A. Schultz, Greensburg, Pa.; M. C. Alford, Huron, S. D.; Albert J. Seare, Salt Lake City, Utah; Wm. Reher, Pana, Ill.; Willard F. Davis, Wilmington, Del.; Frank B. Fon Dersmith, Lancaster, Pa.; Elias Gross, Kansas City, Mo.; M. Gans, Evansville, Ind.; Charles Wyman, St. Albans, Vt.; H. W. Matalene, St. Louis, Mo.; Glen A. Port, Vinton, Ia.; Max Huss, New York; J. P. Matson, Buffalo, N. Y.; L. Kranz, Providence, R. I.; A. M. Bigelow, Marquette, Mich.; A. R. Knights, Dubuque, Ia.; A. W. Thoma, Kaukauna, Wis.; C. J. Peterson, Morris, Ill.; J. W. Spence, Racine, Wis.; J. G. Higgins, Chattanooga, Tenn.; H. Spahr, Orangeburg, S. C.; G. J. Ruegly, Trenton, Mo.; Martin & Karst, Racine, Wis.; N. R. Gilchrist, Wakonda, S. D.; G. H. Higgins, Lawler, Iowa; T. K. Mork, Wheaton, Minn.; C. Speidel and wife, Richard Center, Wis.; E. L. Osborn, Rose, N. Y.; Muta U. Swiger, Shoneston, W. Va.; Wm. Phillips and wife, Stockton, Ills.; J. M. Dikob, Charleston, Ill.; N. B. Nye, Kalispell, Mont.; J. E. Bunday, Lebanon, O.; P. B. Morehouse, North Adams, Mich.; M. F. Pearce, Milford, Ill.; L. W. Mowry, Slayton, Minn.; O. Bildstad and wife, Cambridge, Wis.; F. E. Hart, Wolcott, Ind.; Duer Bros., New Martinsville, W. Va.; A. C. Hailey, Harrison, Ark.; M. Weinzeal and wife, Ely, Minn.; G. F. Hahnemann, Buffalo, N. Y.; A. E. Oyster, Alliance, O.; W. S. Elgin, Hopkinsville, Ky.; Milton C. Alford, Huron, S. D.; J. O. Torgerson, Stoughton, Wis.; F. H. Hanson, of Holih & Hanson, New Rockford, N. D.; W. H. Murphy, Fox Lake, Wis.; Alvin Clark, Dallas, Tex.; Irvin H. Park, Big Springs, Tex.; J. E. Gilleland, New Cambria, Mo.; D. B. Holton, Genoa Junction, Ills.; C. P. Washburn, Chadron, Neb.; B. P. Richmond, wife and son, Lansing, Mich.

The following jewelers and their friends visited the rooms of the Chicago Jewelers' Association last week:

M. S. Lovell, Brooklyn, N. Y.; H. Lange & Son, Cincinnati, O.; J. A. Shomaker, York, Pa.; James Robinson, Melbourne, Australia; Rathstein Lippman

Bros., Bradford, Pa.; H. Strouse, McGregor, Ia.; A. B. Conant, Boston, Mass.; E. E. Greenwood, Cambridge, Mass.; G. D. Greenwood, New York; Alfred Moses, Richmond, Va.; F. Pieper, Covington, Ky.; Glenn Hilton, Huntington, W. Va.; Sigismund Kronholtz, Stamford, Conn.; J. W. Schrimpf, Spirit Lake, Ia.; John A. Black, Tucson, A. T.; T. G. Burkhardt, Jefferson City, Mo.; Bernhard Rydberg, Billings, Mont.; L. Cornelius, Prairie du Chien, Wis.; H. N. Clark, Oberton, O.; W. G. Hamburg, Detroit, Mich.; F. Wm. Volckmann, Appleton, Wis.; G. M. Geer, Providence, R. I.; Peter Liedenstruth, Pensacola, Fla.; H. M. Ryman, New York; I. F. Kohler, Richmond, Va.; C. Fred Kohler, Richmond, Va.; E. Bixby, Ironton, O.; D. Skutch, New York; A. K. Jobe, Jackson, Tenn.; Edward H. Bonnet, Zanesville, O.; A. W. Thoma, So. Kaukauna, Wis.; Louis Hoefler, Kearney, Neb.; B. S. Freeman, Attleboro, Mass.; B. Romback and wife, Paris, Tex.; J. P. Ernst, Sunbury, Pa.; W. A. Buehl, Sycamore, Ill.; Wm. J. Benn, Philadelphia; J. J. Hoffman, Reynoldsville, Pa.; H. Lammel, Newark, N. J.; A. Mueller, Baltimore, Md.; B. W. Percy and wife, Ogdensburgh, N. Y.; R. Cowles, New York; Hugo Carlman, Mobile, Ala.; H. H. Jackson, New York; W. Sproessor Watertown, N. Y.; Fred H. Taber, Grand Ledge, Mich.; S. K. Fraser, Lincoln, Pa.; Johnson Ater, Water Valley, Miss.; R. M. Walker, Monroe City, Mo.; Robt. J. Jessup, New York; Thos. A. Ladson, Washington, D. C.; N. B. Nye, Kalispell, Mont.; Wm. Schmidt, Milwaukee, Wis.; C. E. Sawyer, Boston, Mass.; F. E. Pope, Boston, Mass.; E. Jacobson, New York; E. Glouskin, New Haven, Conn.; M. D. Jacobs, Washington, D. C.; Wm. N. Brandt, Berlin, Germany.

M. A. Mead is expected to return from his Colorado visit in a few days.

C. A. Dreiss and wife, of Ontonagon, Mich., are in Chicago on a bridal trip.

Mr. Russell, of Irons & Russell, spent the past week in the city on business.

W. T. Coffin has removed from room 501, Venetian building, to room 512, on the same floor.

Leopold Stern of Stern Bros. & Co., New York, and wife, are stopping at the Auditorium.

Manager Hudson, of the Roy Watch Case Co., left Monday for a whirl around the western circle.

A bouncing baby boy—ten pounds—causes smiles to wreath the face of J. M. Becker, of Planchamp & Becker Co.

Samuel B. Mann, treasurer of the Aikin-Lambert Jewelry Co., New York, was an interested visitor at the Fair last week.

Saturday week A. E. Bentley, western manager for the United States Watch Co., returned from a two months' visit at the factory.

Simon Muhr, of H. Muhr's Sons, accompanied Governor Pattison and staff on their World's Fair trip, making the exhibit of the firm his headquarters, the past week.

John Bliss, of John Bliss & Co., New York, has been examining many watch movements and instruments of precision during his stay at the Fair—Sept. 1 to 15.

Dr. Chas. F. Carpenter completed his work on the jury on horology with an examination of the Patek, Philippe & Co. exhibit, and returned to Louisville the latter part of the week.

At the regular monthly meeting of the Chicago Jewelers' Association, held Sept. 5, an informal discussion was had on the subject of early closing Saturday afternoons during September. It was decided to discontinue the early closing and hereafter the wholesale houses will be open during regular business hours.

"Abreast of the times; nothing old foggy about them" is the verdict of the public on the business management of Goldsmith Bros., refiners and smelters at 63-65 Washington St. Their latest offer, detailed on page 23, should interest every jeweler. The firm's World's Fair handbook, sent free on application, is a convenient reference work.

Louis Tas, of Amsterdam, Holland, M. J. Lasar, New York, and Monroe Engelsman, of Peabody & Engelsman, New York, related many pleasing stories while whirling from the eastern to the western metropolis, but the Fair struck them speechless. Messrs. Tas and Lasar returned Wednesday. Mr. Engelsman assumes charge of the Chicago office of the firm, 801 Columbus Memorial building, during the week's absence of Mr. Peabody in the east.

**DIAMONDS** **WATCHES** **BHA TRADE MARK** **JEWELRY** **MANUFACTURING**

**LAPP AND FLERSHEM** Chicago, Ill.  
92, 94, 96 & 98 STATE ST. COR. WASHINGTON.

**THE LARGEST SUPPLY DEPOT**

*For everything needed by Jewelers*

ILLUSTRATED CATALOGUES FURNISHED JEWELERS  
SPECIAL FACILITIES FOR FILLING ORDERS NO RETAILING!

**STERLING & SILVER PLATE** **BHA** **OPTICAL** **GOODS**

**CLOCK** **CANE** **BHA** **STOOLS & SEWING MACHINES** **BHA**

Mr. Metcalf, of the Meriden Britannia Co.'s New York store, is among the World's Fair visitors.

W. H. Gaines, secretary of the Rogers & Hamilton Co., is visiting the Chicago office and the Fair with his family.

A. L. Sercomb, manager for the Meriden Britannia Co. in this city, left Friday for the factory to arrange for Fall goods.

D. Scutch, representing the New York office of the Waterbury Watch Co. in Ohio and Pennsylvania, is visiting the Fair.

I. E. Richmond, formerly of New York, takes a pardonable pride in the cut-glass department of the Pairpoint Mfg. Co., of which he has charge.

J. B. Kendrick, auditor for Simpson, Hall, Miller & Co., is in Chicago on his semi-annual trip to the various branch houses of the firm.

F. R. Grimes & Co. are out of business. Mr. Grimes was unable to make money in the business, and concluded it best to wind up the affairs of the company. It is understood that arrangements have been made with creditors through Horton, Angell & Co., Attleboro. Mr. Grimes is temporarily absent from the city.

**Cincinnati.**

Wm. Oskamp went to Washington last week.

The house of Will Videll, of Jonas, Dorst & Co., was entered by burglars last week, and completely sacked of all its valuables.

Arnberg & Co. are offering a reward of \$25 for the return of a dark red Irish setter that answers to the name of Brian. He was lost in Lexington, Ky.

Gustave Fox & Co. are sending out their Columbian Diamond Catalogue. It is pronounced by many the finest and most artistic ever produced.

Homan & Co. have kept their factory going the entire Summer. They will be running full time in another week, and by Oct. 1 will be running over time. Orders are now accumulating for holiday trade.

Cincinnati jewelers at the World's Fair last week were: Alf. Hellebush, Henry Hahn and wife, A. G. Schwab and wife, Miss Blindel, of Jonas, Dorst & Co., and Jos. Gosling, of Jos. Noterman & Co.

J. Henchberg, A. G. Schwab & Bro.'s poet salesman, will start on a four weeks' trip through the northwest. Louis Lange, son of Herman Lange, the Vine St. jeweler, has connected himself with A. G. Schwab & Bro., and is on the road this week.

W. S. P. Oskamp, Henry Michie and W. A. Tenny are the Chamber of Commerce committee on silver that is to go to Washington to attend the business men's meeting, convened to discuss the silver question.

B. S. Newman, of Frohman, Wise & Newman, met with an accident last week at Owensboro, Ky. His trunk in being taken from the boat slipped into the water. The firm anticipate no great damage as the goods were immediately taken out and put in order.

**REED & BARTON,**  
**SILVERSMITHS,**  
 MANUFACTURERS OF  
**STERLING and SILVER PLATED**  
**SILVER and WARE.**

SALESROOMS:

**37 Union Square, New York.**

34-36 WASHINGTON STREET,

**Venetian Building, Chicago.**

FACTORIES, CAUNTON, MASS.

**DÜRRSTEIN & CO.,** Watch Manufacturers,  
**DRESDEN and GLASHÜTTE,**  
**GERMANY.**



**SPECIALTIES:** Repeaters, self-striking minute and quarter repeaters, chronographs, chronometers, finest Glashütte anchor watch (patent union) in sizes for ladies and gents, in plain cases and in cases richly chased, engraved, enameled and diamond set.

PRODUCTS OF FACTORY FOR SALE BY LEADING JEWELERS.

REPRESENTED BY

**Richard Horstmann,**

BERLIN, S. W.

ORAMENSTRASSE 101, 102.

World's Fair, German Court of Honor.

MANUFACTURES BUILDING.

ESTABLISHED 1879.

**G. W. HOOK,**

**MANUFACTURING JEWELER,**

149 and 151 State Street,

Chicago, Ill.

INSPECTION BY THE VISITING TRADE INVITED.

### Pittsburgh.

I. Ollendorf has returned from a six weeks' trip to Europe.

A. Frank has opened a jewelry store at 186 Wylie Ave.

H. S. Johnston, a Pittsburgh buyer from Apollo, Pa., came to the city on his wheel.

Henry A. Barrett, of G. B. Barrett & Co., and Mrs. Barrett are on an extended western trip.

M. Bonn and family have returned to the city after a two months' sojourn in their Summer cottage.

E. Van Baalen, with E. De Roy for the past seven years, will go into the jewelry business in Smithfield St.

Mr. and Mrs. B. E. Arons celebrated the twelfth anniversary of their marriage last week with a reception.

Witzel & Pafenbach have finished taking stock. Their store is open every evening until 8, and on Saturdays till 10 o'clock.

James Brown, traveler for G. B. Barrett & Co., will become a benedict in October, the pretty bride-elect being Miss Sadie Reed, of this city.

Among the out-of-town buyers here last week were: H. C. Morrison, Mt. Pleasant, Pa.; F. H. Hayes and Geo. V. Brady, Washington, Pa.; H. H. Weylman, Kittanning, Pa., and J. W. Caler, Beaver, Pa.

Local jewelers are taking little interest in the exposition which opened Sept. 6th, J. C. Grogan and J. M. Roberts being the only ones having booths. However, the magnificence of their displays is compensation for the absence of other exhibits.

The new granite front establishment of M. Bonn & Co. is rapidly nearing completion, and the building will be ready for occupancy Jan. 1st. The entire first floor and

basement will be utilized by the firm, and an exceptionally attractive store is the general expectation.

The base ball game last Tuesday between the wholesale and retail dealers resulted in a score of 11 to 10 in favor of the wholesalers. Umpire R. M. B. Jantzen was presented with a League season ticket by the retail dealers for the wildness of his decisions.

### Kansas City.

J. A. McKeon, of Jaccard's is visiting the World's Fair.

A burning awning called the fire department to C. H. Harsch's store, 18 E. 11th St. The damage was small.

F. G. Altman has moved his business from 725 Main St. to the store formerly occupied by his brother, J. C. Altman, 707 Main St.

Alice G. Edwards, the young daughter of George H. Edwards, of the Edwards & Sloane Jewelry Co., died last week of typhoid fever.

Miss Emma Russell, daughter of jeweler C. E. Russell, has returned from Minneapolis, where for five months she has been studying music.

The Missouri and Kansas Inter-State Fair, in this city will open Sept. 25th. Hitherto the jewelers have made the prettiest and most costly displays in the Exposition building. This year the Jaccard Watch and Jewelry Co. will have no exhibit, while Cady & Olmstead are as yet undecided.

A patrolman, a few days ago, discovered that some thief attempted to cut a window pane with a diamond glass cutter in the window of jeweler P. J. Chick, 548 Minnesota Ave., Kansas City, Kan. The

cut was made about 2x3 inches, right over a gold watch and a tray of gold charms with diamond settings. For some reason the thief failed to knock out the glass. The police think he was frightened away before he had time to complete the job.

### Indianapolis.

W. S. Orwin, Rushville, Ind., and A. Bitterman and Charles F. Artes, Evansville, Ind., have returned from the World's Fair.

Traveling men in Indianapolis, last week were: Frank W. Trewin, Keystone Watch Case Co.; E. W. Fenger, the Natchaug Silk Co.; F. W. Hall, Barker Mfg. Co., Geo. H. Herrick & Co. and Coddling Bros. & Heilborn; and Mr. Kroll, H. Kroll & Co.

### Indianapolis Jewelers Take Part in the G. A. R. Encampment.

INDIANAPOLIS, Ind., Sept. 11. — From Sept. 4th to the 9th Indianapolis was entirely given up to the survivors of the armies of the Union. The local jewelers took an active part in entertaining the old soldiers during the National G. A. R. encampment. Silas Baldwin served on the committee on halls; E. C. Miller was active on the committee on music; H. A. Comstock was kept busy on the committee of street decoration; Julius C. Walk had his hands full with the war pageantry, and J. C. Sipe and Carl F. Walk served on the grand stands committee. The sale of souvenir spoons was immense.

The jewelers decorated their windows handsomely. Julius C. Walk & Son showed a large shield composed of red, white and blue electric lights, on the top of which was mounted the American eagle. At night this window was most gorgeous. H. A. Comstock had a fine representation of the Brooklyn bridge in white velvet and white silk cords for the cables. Red, white and blue electric lights shone from the top of the towers and threw a brilliant light on the collection of watches, jewelry and gems tastefully arranged in the window.

Wm. T. Marcy's window contained the Soldiers' Monument in white silk plush. Wm. J. Eisle had the word "Watches" suspended in the center of his show window. The letters were of royal purple velvet, on which was hung a beautiful assortment of ladies' watches. Jas. N. Mayhew, optician, had a very large G. A. R. badge in bronze in his window.

The monogram book for jewelers and engravers, published by Wm. H. Dietz, 117 Dearborn St., Chicago, has reached its third edition. The price, which was originally \$2.50, has been reduced to \$1. Nothing has been taken from the original work. The book is indexed, and any monogram of the 2,200 showing 6,000 combinations, can be found in ten seconds. It is a practical and useful volume.



HE HAD A  
HANG-DOG LOOK,

BECAUSE HE BOUGHT HIS  
Gold, Silver; Steel and Nickel  
Spectacles and Eyeglasses:

Gold, Silver, Aluminum and German Silver

THIMBLES,

—: AND —

SEAMLESS, GOLD FILLED,  
SPECTACLES AND EYEGLASSES,  
BEFORE SEEING OUR LINE.

THE WINSTED OPTICAL CO.,

MANUFACTURERS OF

The BURBANK Patent Eyeglass, SEAMLESS Gold Filled Spectacles and Eyeglasses. And all other goods enumerated above. WRITE US!

WEST WINSTED, CT.

**Minneapolis and St. Paul.**

B. Pavian, St. Paul, has given a chattel mortgage for \$250.

M. A. Streeter, Minneapolis, has given a chattel mortgage for \$275.

F. A. Defiel, St. Paul, has gone to Chicago to "do" the World's Fair.

Arthur Fritz, Minneapolis, returned from a visit to the World's Fair, last week.

M. C. Working, Northfield, Minn., was in the Twin Cities on business the past week.

Charles Trout, traveler for S. H. Clansin & Co., Minneapolis, started out on his Pacific Coast trip on the 4th inst.

All the Twin Cities jobbers who closed their stores at 1 o'clock on Saturdays during the Summer months, have returned to the old routine.

Ed. Lowery, recently watchmaker for the Reed & de Mars Jewelry Mfg. Co., Minneapolis, has accepted a similar position with J. W. Dupont, East Minneapolis.

The jewelry store of F. V. De Coster, Litchfield, Minn., was broken into by burglars on the 1st inst., and a number of watches and other jewelry stolen.

The firm of Pomerleau & Munns, both members of which were formerly in the employ of J. W. Dupont, Minneapolis, have started in business for themselves on Central Ave., East Minneapolis.

**Lancaster, Pa.**

Frank B. Fon Dersmith is spending several weeks at the World's Fair.

Charles Frantz will open a jewelry store at 109 E. King St., about Oct. 1st.

W. Kurtz Zook has succeeded Walter C. Herr, in the proprietorship of the jewelry store at the corner of N. Queen and Orange Sts.

The extensive plant of the Lancaster Silver Plating Co. (M. W. Fraim and A. H. Rosenstein, proprietors), on W. Mifflin St., was completely destroyed by fire at an early hour Thursday morning. The firm had a large stock of finished goods on hand, valued at \$25,000, which was totally destroyed. They carry an insurance of \$17,000. The building was owned by Chas. H. Socher. The origin of the fire is a mystery.

**Detroit.**

T. J. Commerford, manager and secretary of the United States Optical Co., was last week confined to his house by sickness.

Hodgson & Howard's store was recently broken into and a gold watch stolen. George Jefferson was arrested, tried and convicted of the offense and sentenced to eighteen months in prison.

Frank Malthauer, traveling representative of Kennedy & Koester, is in Chicago. George L. Lowe, another traveler, left last Monday for an extended trip through the Upper Peninsula.

**A NOVELTY FOR  
BICYCLE AND DASHBOARD.**

PRACTICAL.

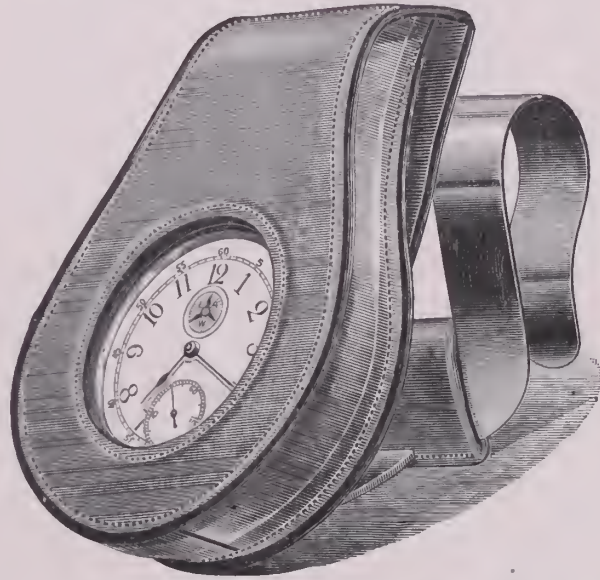

RELIABLE.

**A. WITTAUER,**

Manufacturer and Importer,

**19 MAIDEN LANE,**

**NEW YORK.**

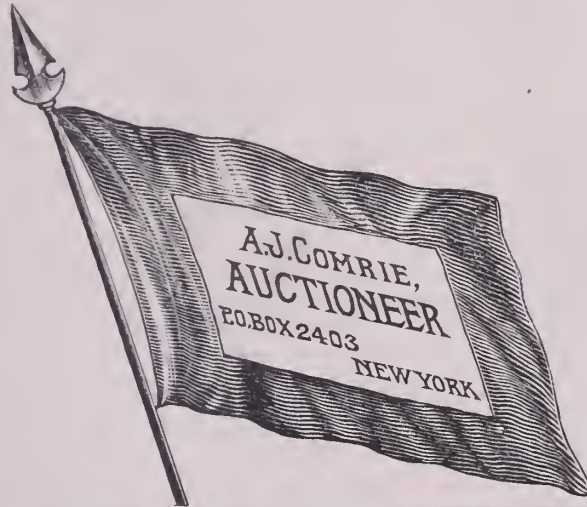

SPECIAL SALESMAN OF

**WATCHES, DIAMONDS,**

Bric-a-Brac

and Art Goods

FOR

**Established Jewelers.**

WRITE FOR PARTICULARS.

Communications Strictly Confidential.

References given in all parts of the United States from Retailers and Jobbers.

**THE IMPROVED RIVAL FOUNTAIN PEN.**

MOST RELIABLE AND GUARANTEED TO GIVE PERFECT SATISFACTION. OVER 75,000 IN USE.

Send for Price List.

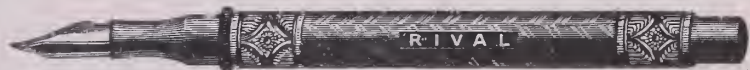

Liberal Discounts to the Trade.

**D. W. BEAUMEL,**

Inventor and Manufacturer, REPAIRING A SPECIALTY, 17 John St., New York.

**WATERMAN & LEHMANN,**

MANUFACTURERS OF

**DIAMOND JEWELRY**

AND DEALERS IN

**DIAMONDS,**

No. 37 MAIDEN LANE,

NEW YORK.

R. J. F. Roehm & Son were given the contract for furnishing the souvenir badges for the Sigma Phi convention, held at Chicago last week.

F. G. Smith, Sons & Co. have manufactured a diamond keystone Masonic charm and a diamond studded Mystic Shrine pin, which were last week presented to ex-officers of these societies.

McDonald, Rich & Co., dealers in glassware, silverware, cutlery and bric-à-brac, have asked the Circuit Court to appoint a receiver for the property of Daniel De Vannie, 28 Monroe Ave., whom they established in business.

Eddie Mines and David Burke, the alleged diamond robbers mentioned in last week's CIRCULAR, were allowed to go because of the slowness of the Lansing authorities in identifying them. It now transpires that Mines was shortly afterward robbed of \$600 worth of stones which are thought to be part of the stolen plunder. The officers are looking for the men, but they have disappeared.

There is a perceptible improvement in the jobbing trade in Detroit; mails are heavier, and orders larger. The following Michigan country jewelers purchased goods here last week: W. H. Baxter, Birmingham; A. W. Kludt, Richmond; L. A.

**NEW ! IMPROVED NEW !**  
Adjustable "Eclipse" Eye Glasses.

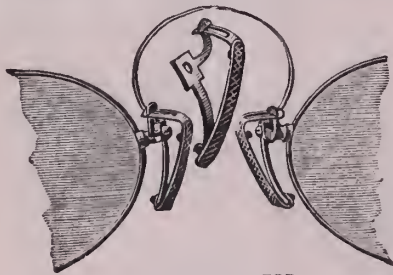

PATENT APPLIED FOR.

We claim this invention to be the only one which combines the advantages of both the adjustable and offset guards. We will furnish these frames or guards by Sept. 1st, in either Zylonite or Cork.

WRITE FOR CIRCULAR.

JOHN SCHEIDIG & CO., SOLE AGENTS  
43 MAIDEN LANE, NEW YORK.

Steele, Linden; W. H. Ambler, Northville; W. D. Walton, Armada; William Parks, Reese; N. C. Potts, Forrestville; C. D. Louis, Memphis, and William Walters, Wyandotte.

### St. Louis.

John Pierik, Springfield, Ill., is in town buying jewelry.

August Zacher, of E. H. Kortkamp & Co., is back from Chicago.

Gerhard Eckhardt, 1242 S. Broadway, has returned from his second visit to the World's Fair.

Julius G. Friton, of Friton Bros., 326 Market St., was married Wednesday evening, Sept. 6th, to Miss Anna Castlehuhn.

The assignee's sale at the Providence Jewelry Co.'s headquarters, 412 N. Broadway, is progressing satisfactorily. About half the stock has been sold.

M. Eisenstadt and Joe Freide, of the M. Eisenstadt Jewelry Co., will leave in a few days for a northern trip, during which they will stop at the World's Fair.

Hess & Culbertson, at present at 218 N. 6th St., are making extensive arrangements to move into their new and much more commodious quarters on the northeast corner of 6th and Locust Sts. in a few days.

S. Barbour, Hartford, Conn., has been here on a visit to the Hartford Silver Co.'s establishment on 4th St. The local concern is a branch of the Hartford Silver Co., of Hartford, which was recently purchased by the Barbour Silver Co., of the same place, and Mr. Barbour's visit was for the purpose of straightening out matters in connection with the transfer.

### Connecticut.

W. A. Ingraham, of Bristol, returned from Cottage City last Tuesday.

The E. Ingraham Co., Bristol, continues to run power and employ such help as is necessary, as they have been doing.

K. V. R. Albert, the Meriden Britannia Co.'s Australian agent is in Meriden for a short time, after a three years' absence.

D. J. Gale, an expert in clock making,

and inventor of Gale's perpetual calendar, has removed from New Haven to Bristol.

Porter & Dyson, New Britain, have just completed the equipment of their factory and have also remodeled and beautified their office headquarters.

In Bridgeport the Holmes & Edwards Silver Co. have increased their force to forty men, and hope in a month to have their shop working full time with the entire former force.

The New Haven Clock Co. started up their engines Sept. 5th, and owing to the receipt of many new orders will, it is expected, start up the entire works in a few days, with the full force of 700 hands.

Owing to an increasing demand for goods, Simpson, Hall, Miller & Co. will speedily increase their working time to five days a week. The company are busy now with a World's Fair order for sixty-eight prize cups of different sizes.

The Waterbury Watch Co. reopened their works last Monday morning. The Waterbury Clock Co. had already opened and given work to 1,200 persons, after a two weeks' rest. Business in the brass foundries is good and looking brighter every day.

Traveling Salesman Phelps, for several years with the New Haven Clock Co., and for six months past with G. S. Lovell Clock Co., Philadelphia, arrived home Wednesday from a three weeks' vacation and left Sept. 11th on a three months' trip in his territory, Pennsylvania, Ohio, and as far west as Detroit.

Ezra F. Bowman & Co., Lancaster, Pa., are about to bring out a dial foot tool for putting posts on dials and replacing broken ones, or putting dials on movements other than those for which they were intended. It is also useful for holding the bits of single and double sunk dials during the process of soldering or cementing. The first order, for future delivery, was received from Belgium. It is one of the handiest tools offered in recent years and is the invention of a practical watch man, Urban W. Frink, of Chicago. Ezra F. Bowman & Co. have sole control of the invention.

## No File Equals the "GLARDON" File

is the universal verdict  
of the trade.



LARGEST ASSORTMENT IN  
THE UNITED STATES.

## F. W. GESSWEIN, 39 John Street, New York.

SOLE AGENT FOR UNITED STATES AND CANADA.



## Insects as Jewels.\*

SEVERAL foreign nations, more especially those in tropical countries, have the custom of using insects for ornaments. In France, however, coarse imitations made of precious materials are preferred; we must acknowledge that many of our women seem to prefer expensive ornaments to artistic ornaments. For insects with their elegance of shape and coloring are much more beautiful than the copies sold by jewelers. Insects merit a much more important place in dress than is now awarded to them; the trouble is our fashion makers know so little about their beauty. In order to comprehend in some measure the addition these insects would be to dress, we commence by glancing rapidly at the entomological personal decorations of the South American savages.

The golden green Chrysophores are magnificent coleoptera whose beautiful metallic color cannot be described. It has been said that "Nature has clothed them with resplendent armor, before which pales the sumptuousness of Asia in a sultan's day of triumph," and certainly this does not seem exaggerated. The Indians of Rio Napo, allured by the brilliancy of their colors, utilize them for ornaments of different kinds. They make a drop to adorn their hats; it is composed of bones, seeds, monkey's teeth and the elytra or winged sheaths of the Chrysophores. These insects are provided with enormous thighs; the Indians detach them, string them like pearls and make necklaces of them; if not very pretty, they have at least the merit of being original.

Sometimes the Indians value too much their taste for natural objects. The Roucouyennes use for earrings objects whose success with us we do not fear. To a feather passing through the lobe of the ear is fastened a squirrel's tail, ornamented with black, white, pale blue and red feathers, and to which is suspended a kind of light drop covered with the winged sheaths of the great metallic Buprestis. There is a kind of cuff or bracelet which is a favorite with the natives of Rio Napo. It is made of a row of little bones of birds, strung like pearls, and from them hangs a drop or tassel of numerous winged sheaths (elytra) of Buprestis, which beside their beautiful brilliancy produce a delightful jingling. These same Indians admire insects so much that they adorn their idols with them, as we place lilies on the altar before the Virgin. For this they often use the egg capsules of the Mantis, or a butterfly's cocoon.

The love of insects is found as intense in other places; recently a collar was brought from Melanania made of the thorax of insects, probably Scarabees. At Havana and the neighboring countries the Creole women use for ornament a singular luminous insect, the Pyrophorus. It is a large, elongated coleoptera, with the property of shining, with unequalled brilliancy, like our fire-

fly, but with much greater intensity. In the countries where they abound the Indians use them for lanterns to guide them through forests. One alone, placed in a room, gives light enough to read a book.

The Creole ladies use them for living jewels; they are besides prettier and more brilliant than diamonds, and how much more original! They must be alive to shine, so they place them in muslin bags or fasten them on delicately. "Often," relates Maurice Girard, "they place them in the folds of their white muslin dresses, which then seem to reflect the silvery rays of the moon, or else they place them in their beautiful black hair." This original coiffure has a magic brilliancy, which harmonizes perfectly with the style of beauty of these pale Spanish brunettes. But a few hours quite fatigues the poor insects, which is shown by the diminution or transient disappearance of their light. They shake them and tease them to restore them.

A general fact with phosphorescent animals is that the secretion of combustible matter is united to the same causes which produce muscular contraction. Therefore the ladies of Havana take great care of their pretty jewels. On their return from a ball, with tired bodies and heads giddy with music, before they themselves rest they make their Cocujos take a good bath, an indispensable operation, then they put them in little cages, where to revive themselves they suck bits of sugar cane. Surely they have earned it.

In France we cannot think of any acclimatization of the Pyrophorus. But we have fire-flies and Luciola which might easily replace them. What lover is there who walking through the meadow in the evening has not scattered Lampyris in the hair of his sweetheart? In the south it seems almost classical to capture Luciola for ornament.

In Brazil, and in fact through the whole of South America, a multitude of magnificent insects are found from which various jewels are made. A few are imported to Europe, but up to the present time they have not had all the success they merit. The coleoptera which are designated by the name of Buprestis are especially used. The shape of their bodies may not be very elegant, but their color surpasses all that can be imagined; their common name of "rich men" comes from their shining appearance. Some are wholly of a brilliant metallic green, others are more dull, with longitudinal gilded stripes, others have on their winged sheaths fawn-colored spots, irregular patterns, purplish, azure, golden reflections, how can I describe them?

Their consistency permits them to be mounted in the form of brooches, bracelets, earrings, etc. The species most used belongs to the genus Curculio; it is very common in its own country, where in its abundance it even sometimes weighs down the branches of the mimosas. They are frequently sent to Paris. Earrings are made entirely from Curculio; the claws and

belly are of gold. On the surface of the Lystras are seen longitudinal rows of very sharp points or dots. Each point is filled with little green scales, which shine like emeralds. One earring that I have seen was made of an insect dressed all in green, a clear green, set off in several places on the surface by blackish dots surrounded by a golden crown. It was rather large, and would look better in a brooch than in an ear pendant.

Scarf pins manufactured from these insects are very serviceable. I own one mounted in gold, the claws and under side of the same material, and two hooks for the head and tail. The insect is solidly fastened. It is a pretty kind of blue and green metallic color, with perfectly regular black tracing which contrasts finely with the clear tint of the whole. There is one Brazilian coleoptera often used because of its very great hardness, which allows it to be cut as though it were metal; it is of an odd shape, flattened, metallic, and covered with dots sunken in; it is not especially pretty.

The foreign coleoptera which can be used for ornament are very numerous. The oddest shapes that can be imagined are met with, and the most beautiful tints that can be desired. For instance, one of bamboo color with greenish reflections, a surprisingly singular mingling of colors; another, mother-of-pearl with most beautiful golden bands; still another, sky-blue of a wonderful softness with pretty black bands. One of the most curious is of a golden red, of a red fire which reminds us of a fire-brand. They are sometimes of an ultra-marine blue, or yellow with brownish tracery. One has green winged sheaths and blue corselet; this last one is shining, red, metallic, greenish; it is so brilliant that it makes the finest rubies seem pale.

In France, besides the Brazilian jewels that are sent to us, there are hardly more than one or two insects ever used, and these even in a very timid manner. It appears that in the good old times, Latreille tells us this, the women set off the beauty of their hair by wearing thighs of insects which were common in cow dung—the Geotrupes. Among our insects the Hoplic cerulea is certainly, if not the most brilliant, at least one of the most delicate in the freshness and purity of its azure sky-blue tint. This color is produced by fine scales like those on butterflyflies; and the Hoplia is also a fragile insect and is on that account now rejected for the fabrication of necklaces, brooches and different ornaments.

I have had the curiosity to look through my collection of coleoptera for those that could be employed in ornament, and I have been surprised by the multitude of kinds, and those the most common, which might be tried. It is impossible to enumerate them all. Let us mention, at random, the Cetonia, green, bronzed, streaked, reddish brown, which look very well placed on an artificial rose; the Trichodes, quite velvety, yellow with black spots; the Rhynchites, these terrible enemies of the vineyard,

\* From the French of Henri Coupin.

**S. F. MERRITT,**  
 Patentee and Manufacturer of  
**EYE GLASS HOLDERS AND CHAINS,**  
 181 MAIN ST., SPRINGFIELD, MASS.

Mr. Editor: - I would like to say a few words to the trade in general and my customers in particular. I know that it has been a dull summer and money has been tight, but there is a better time coming and I believe I shall sell enough this fall to even up with last year. You see these are Staple Goods that have a steadily increasing sale, and I do not believe they have reached their limit yet. The Eyeglass Holder has become as much a necessity as the Eyeglass itself, the people have got to have them and we shall sell them. You had better send in your orders early as possible, because when business takes a start it will go with a rush, now you remember what I say and see if I am not right.

S. F. MERRITT.

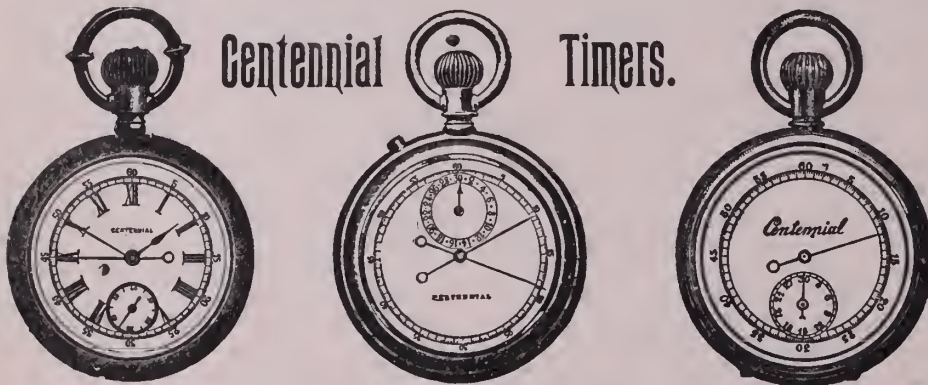

These Watches are one-third larger than above cuts.

**CROSS & BEGUELIN,**  
 Manufacturers, Importers and Jobbers of  
**Watches, Diamonds, Jewelry, Watch Materials, etc.,**  
 17 MAIDEN LANE, NEW YORK.

**THE BONNER COMBINATION**  
 RING, SCARF PIN AND STUD.  
 The Best Combination ever made.

MANUFACTURED BY  
**BONNER, RICH & Co.,**  
 Makers of DIAMOND MOUNTINGS  
 RINGS A SPECIALTY.

To the Jobbing Trade Only. 41 MAIDEN LANE, NEW YORK.  
 Factory, 44, 46 and 48 Hill St., Newark, N. J.

**"Old English"**  
 Coffee Spoon.



**Towle Mfg. Co.,**  
 MANUFACTURERS OF  
**STERLING SILVERWARE.**  
 NEWBURYPORT: No. 214 Merrimack St. CHICAGO: Nos. 149 & 151 State St.

**Correspondence.**

Anonymous communications will not receive any consideration whatever. A correspondent may employ a *nom de plume*, but must furnish his real name as an evidence of good faith.

The following letter was received in response to questions submitted to the presidents of the various commercial organizations in the trade, as specified in the last issue of THE CIRCULAR:

Green Mountain Falls, Col., Sept. 1, 1893.

*Editor of THE JEWELERS' CIRCULAR*

Yours of the 28th ult. at hand today, having been forwarded to me from Chicago. While I do not see why my personal views should have any special interest from the accident of my present position in the Chicago Jewelers' Association, I still feel that in courtesy, you are entitled to receive an answer from me.

That "the present financial conditions have affected the jewelry and kindred lines" very severely I think, can scarcely be denied by any one, nor is it strange that a trade, largely made up of articles strictly to be defined as in the line of luxuries, should feel a condition which has even limited the consumption of goods usually classed as necessities. As a trade, however, it seems to me that we are holding up remarkably well, everything considered, and that courage, patience and mutual help, properly exercised, will bring us out of the clouds and into the sunlight again, with as small a percentage of disasters as any trade.

As to the "prospects for Fall trade in our lines," it seems to me all we can reasonably hope for is a very moderate movement of goods, with improvement in collections and a gradual reduction of stocks, and an equal reduction of debts all around, in this way laying the foundation for the renewed period of activity, which will surely come in the not far distant future.

With kindest consideration,

Yours truly, M. A. MEAD,  
 President, Chicago Jewelers' Association.

**THE BURNING OF DIAMONDS.**

MUSKOGON, MICH., Aug. 25, 1893.

*Editor of THE JEWELERS' CIRCULAR:*

In your issue of Aug. 16, I note that in the account, of the slight blaze in G. W. Fairchild's jewelry store of Bridgeport, Conn., it is stated:

"As it was the fire burned a number of unset diamonds and rendered them practically useless." I am at a loss to know how so slight a fire could materially damage the diamonds, unless, perchance, the heat was so sudden and fierce as to break them. Will you kindly explain, and oblige

C. E. TRUE

ANSWER: The Bridgeport correspondent of this journal reported the incident of the fire faithfully. The word "burned" was not used in a Pickwickian sense, but in its true meaning. Referring to any dictionary, we find that the word "burn" means "to subject to the action of fire." The diamonds were subjected to the action of fire and rendered practically useless, as reported. The subject, Mr. True, does not admit of a technical dissertation at this late day.

**The Bull in a China Shop Out-Done.**

CATSKILL, N. Y., Sept. 8.—About fifty of a flock of sheep coming down Main St. this afternoon made a break and dashed into Fred. A. Bach's jewelry store. Probably the proverbial bull in a china shop did less mischief than this rampant half hundred, for they upset a big show case, a lot of clocks, and other articles before they were driven out.

**Ferdinand Wagner's Optical Goods Store Looted.**

CINCINNATI, O., Sept. 6.—Ferdinand Wagner's optical goods store at 53 W. 5th St. was visited by burglars some time between Saturday night and Sunday afternoon and \$2,000 worth of goods carried away. The store is in the Johnston building, and, like all the storerooms in that block, has a one-story building in the rear used as an office, and given light by skylights of heavy glass.

The thieves got into a rear court of the building, and climbing on the skylight, carefully removed the putty and lifting out the glass, let themselves into the store. They evidently used a rope as no ladder or anything else was found. They went to a showcase containing the full stock of eye-glasses, and removing the covering took all that was in the place. They left the trays, and evidently packed the goods in bags and left the way they came. A clerk visited the place Sunday afternoon and discovered the theft.

The strangest part of the whole burglary is that the thieves didn't touch valuable opera glasses and surgical instruments which were in adjoining cases. The job was the work of crack professionals. The case was put into the hands of chief of police.

**S. Lyons & Son Pushed to the Wall by Their Creditors.**

Samuel Lyons and Theodore L. Lyons, of 242 W. 153d St., New York, who compose the firm of S. Lyons & Son, dealers in precious stones, 1 Maiden Lane, made an assignment Saturday to Louis Engel, an employe of Joseph Frankel's Sons, giving preferences amounting to \$7,555.98. The preferred creditors are Joseph Frankel's Sons, \$7,105.98 due on merchandise, money loaned and notes indorsed, and Leon Hirsch \$450, due for rent.

Mr Lyons was formerly for many years a broker in precious stones, and started in business on his own account about four years ago. His son, Theodore, was admitted as a partner in October, 1892. To a CIRCULAR reporter Mr. Lyons senior stated that his assignment was caused by the present hard times and difficulty in collecting accounts. Simon Frankel, of Jos. Frankel's Sons, to whom Mr. Lyons referred the reporter for information, stated that the liabilities of the embarrassed firm will aggregate about \$20,000, and that the assets are between two and three times that amount.

The firm, he said, was not insolvent, but was pushed by one or two creditors, and

made the assignment which would merely act as an extension of time. He believed that all the creditors would be paid in full. A meeting of the creditors will be held today at the office of Jos. Frankel's Sons, 1 Maiden Lane.

**L. M. Braham & Son Called Into Court.**

CINCINNATI, O., Sept. 9.—L. M. Braham & Son, the assigned jewelers, have been cited to appear in court and testify as to their business.

The assets of the firm amount to only \$6,587.06, while the liabilities will reach \$23,423.28.

**The Leroux May Now be Indicted for Smuggling.**

BROOKLYN, N. Y., Sept. 9.—When the United States Grand Jury meets here this week an attempt will be made to have Eugene and Jennie Leroux indicted for smuggling. The couple were arrested last May on suspicion of having stolen a large quantity of jewelry found in their possession. There being no evidence to prove the charge they were dismissed from custody, but were immediately re-arrested by the United States authorities on the charge of smuggling. After a hearing they were released on their own recognizance.

If they are indicted for smuggling they will be tried before Judge Benedict late in October or early in November. Early in October Judge Benedict will preside at a jury trial of the diamonds. The diamonds will be accused of being smuggled, and the jury will decide whether the evidence supports the charge or not.

The authorities are positive that the jewels were smuggled in, and if it is proved that Leroux or anybody else smuggled them the duties will have to be paid or the gems will be regularly seized and sold. Friday a motion to turn over the property to Collector Kilbreth was made in the United States Court, this city, and the hearing was adjourned for one week.

**Details of Geo. K. Foltz's Assignment.**

CLEVELAND, O., Sept. 6.—The name of Geo. K. Foltz, 48th Arcade, is affixed to a deed of assignment filed a few days ago. The assignee is Frank E. Dellenbaugh, Esq. He gave the assets of the assignor as \$11,000 and the liabilities as \$11,350.28. The assignment was caused by a falling off of trade, the patronage of the store coming largely from workmen.

Possession of the stock was taken by Ira Goddard on a chattel mortgage for \$2,000, and Mr. Foltz thereupon decided to transfer his assets by a general deed. Judge White fixed the bond of the assignee at \$25,000 and granted an order authorizing the assignee to enter into an agreement with the mortgagee as to possession of the store.

Mr. Foltz's creditors number about fifty, and are located mostly in New York and Providence, R. I.

**Last Week's Arrivals.**

*THE CIRCULAR has perfected arrangements for obtaining the names and hotel addresses of all the latest buyers visiting New York, and each day posts in its office, 189 Broadway, a bulletin which every member of the trade is cordially invited to copy.*

The following out-of-town dealers were registered in New York during the past week: E. O. Zadek, Mobile, Ala., Imperial II.; Chas. Rochat, buyer for Smith & Murray, Springfield, Mass., Imperial II.; S. D. Cook, Denver, Col., Continental II.; E. A. Bliss, Meriden, Conn., Imperial II.; J. P. Rule, buyer for D. McCarthy & Sons, Syracuse, N. Y., Imperial II.; F. T. Christie, buyer for J. G. Myers, Albany, N. Y., Grand II.; M. Koch, Baltimore, Md., Cosmopolitan II.; W. J. Hoggson, New Haven, Conn., Park Ave. II.; A. Oppenheimer, Philadelphia, Pa., Imperial II.; J. M. Buchanan, Petersburg, Va., Astor II.; J. C. Fennell, buyer for Bullene, Moore, Emery & Co., Kansas City, Mo., St. Denis H.; H. J. Martin, Lancaster, Pa., Astor H.; J. Van Valkenburg, Albany, N. Y., Murray Hill II.; W. E. Franklin, Philadelphia, Pa., Albemarle H.; F. A. Robbins, San Francisco, Cal., Astor H.; J. W. Podmore, Jones & Podmore, Troy, N. Y., Astor H.; J. C. Gardiner, buyer of art novelties, etc., Chicago, Ill., Astor H.; A. L. Sercomb, Chicago, Ill., Grand Union H.; Miss N. Donohue, buyer for A. Lisner, Washington, D. C., Belvedere H.; J. Newman, San Francisco Cal., Imperial H.; G. H. Richards, Boston, Mass., Waldorf H.; F. J. Stilson, Atlanta, Ga.; J. W. Montgomery, Newberry, S. C.; A. Winters, Erie, Pa., St. Stephen H.; F. F. Bonnet, Columbus, O., Imperial H.

# KOBEL & MEYER,

Berthoud, Switzerland,

Manufacturers of Fine

## WATCH JEWELS,

All grades and sizes, principally for Regulators, Clocks, Telegraphic Instruments, Compasses, Music Boxes, Mechanical Movements, Physical and Mathematical Instruments.

### ... JEWELS ...

Top Jewels for Marine Clocks, and Large Center Stones for Chronometers and Fine Watches.

Exportation to all Countries.

We buy and sell White and Black Diamonds, Garnets, Rubies and Sapphires for making Watch Jewels.



## Our Traveling Representatives

Traveling representatives may consider these columns open for the publication of any news or items of interest regarding themselves or their conferees.



**W**M. H. CREVELING, representing the Reed & de Mars Jewelry Mfg. Co., Minneapolis, throughout the northwest, started out on his regular Fall trip last week.

Among the traveling men in St. Louis, Mo., last week were: C. M. Davis, New Haven Clock Co.; Charley Hiller, Heintz Bros.; Frank Hodgins, Rogers & Bro.; W. D. Elcox, Larter, Elcox & Co., and Henry J. Freund, Max Freund & Co.

Among the traveling men in Lancaster, Pa., the past week were: A. J. Lasher, Whiting Mfg. Co.; W. J. Barber, Simpson, Hall, Miller & Co.; Rodney Pierce, Julius King Optical Co.; T. A. Brennan, with J. J. Cohn; Fred L. Baker, Hayden W. Wheeler & Co.; H. G. Bailey, C. G. Malliet & Co.; Mr. Hall, Wilcox Silver Plate Co.

W. F. Baker in eastern New York and western Connecticut, and E. H. Baker in the New England States are doing a good trade in the interests of the Winsted Optical Co., West Winsted, Conn. A. W. Pierce looks after the company's interests in the middle west and H. D. Pierce in the central west.

Eastern jobbers and manufacturers represented in the Twin Cities during the past week were: Albert Berger & Co. by H. Somborn; D. S. Spaulding; A. Jandorf; E. G. Webster & Son by W. S. Pond; J. E. Miller by I. B. Miller; Carter, Sloan & Co. by Frank Horton; Lapp & Flershem by E. E. Spaulding; G. H. Fuller & Son by Mr. Stephens; Trier Bros. and the Wm. L. Gilbert Clock Co. by Max Wolf; Meriden Britannia Co. by W. C. Wood, and H. Z. & H. Oppenheimer, and R. Wallace & Sons Mfg. Co.

The following traveling salesmen passed through Detroit, Mich., last week: Mr. Varian, Dennison Mfg. Co.; L. B. Eaton, D. Wilcox & Co.; Mr. Tudor, Tudor Optical Co.; Mr. Sinnock, Ehrlich & Sinnock; Ben Clemens, B. L. Strasburger & Co.; M. D. Rothschild; Luther Hyde, Reed & Barton; H. A. Bliss, Kremenetz & Co.; H. Manning, Smith & Knapp; C. B. Burgess, F. M. Whiting & Co.; Mr. Carter, Carter, Sloan & Co.; A. W. Goodrich, Leon J. Glaenger & Co.; R. M. Wilcox, Rogers, Smith & Co.; W. F. Corey, Corey & Osmon; G. F. Kaiser, Enos Richardson & Co.; H. J. Fink, Keller, Ettinger & Fink; I. W. Friedman; N. D. Prentiss, Alling & Co.; Mr. Rogers, Parks Bros. & Rogers; Walter Shute, Day & Clark; and a representative of H. D. Merritt & Co.

George D. and M. D. Munson, with the Wm. Rogers Mfg. Co., Hartford, Conn., report fair trade.

Traveling salesmen visiting Syracuse, N. Y., the past week were: H. C. Barnum, Shafer & Douglas; J. D. Beacham, Carter, Sloan & Co.; D. Schwab, Henry Froehlich & Co.; Clarence M. Murray, for Henry Carter; E. L. Mumford, Waite, Thresher Co.; M. Adler; C. S. Griswold, Middletown Plate Co.; E. Horton, J. B. Bowden & Co.; E. L. Coggeshall, Rogers, Smith & Co.; Wm. D. Elcox, Larter, Elcox & Co.; George S. Pollitz, Rice & Hochster; S. Glenn Walmsley, Tenner & Baum; Benj. Hano; Theo. Yankauer, Rees & Yankauer; John Davison, Davison Bros.; S. Harris; H. C. Schwartz, Kremenetz & Co.; Wm. Peacock, French & Franklin Mfg. Co.; Mr. Scofield, Lincoln, Bacon & Co.

Travelers are beginning to find their way towards Pittsburgh, Pa. Among those there last week were: Mr. Cross, Columbus Watch Co.; Frank Trewin, Keystone Watch Case Co.; Mr. Scutch, Waterbury Clock Co.; Mr. Mason, Dennison Mfg. Co.; E. T. Hopkins, Meriden Silver Plate Co.; Jos. Beach, Wilcox Silver Plate Co.; Henry Osborne, Whiting Mfg. Co.; Mr. Woods, Dominick & Haff; Tom Davis, Middletown Plate Co., W. H. Gregory, Strobell & Crane; Mr. Pettit, Hayden Mfg. Co.; J. H. Granbery, Reeves & Sillocks; M. Gattle, Falkenau, Oppenheimer & Co.; E. Untermeyer, Keller & Untermeyer Mfg. Co.; A. A. Gillett; Heintz Bros.; Mr. Braillard, Braillard & Pfingsten; E. H. Smith, Holmes & Edwards Silver Co.; M. Manning, Smith & Knapp; Lawrence H. Smith, Bippart & Co.; C. J. Leise, American Morocco Case Co.; Luther Hyde, Reed & Barton; C. J. Suplee, Beknap, Johnson & Powell; Mr. Steele, J. B. Bowden & Co.

Activity is noted among travelers of Chicago houses and the commercial angels who are still home are busy packing their trunks preparatory to leaving for their respective territories.

All of Simpson, Hall, Miller & Co.'s men will be sent out the present week: W. F. Adams, west; H. E. Vincent, Illinois and Indiana; H. L. Sherman, Wisconsin, Michigan and part of Minnesota; L. G. Call, St. Louis and part of Indiana and Ohio and Pittsburgh.

Otto Young & Co.'s travelers are all on the road. C. P. Smith has Illinois, Michigan and Indiana; V. G. Cuthbert looks after Kansas and Missouri; G. W. Cook handles Wisconsin and part of Illinois; H. Rohrback patrols Iowa and Nebraska and B. F. Simpson stands guard over Minnesota and the Dakotas. All are reported as doing well.

For the Towle Mfg. Co., C. E. Pattison is finding good business in Illinois; O. R. Ryan is doing well in Minnesota; P. H. R. Pearson is succeeding well in Ohio, and Geo. D. Lunt finds things quiet in Rocky

Mountain regions but, expects better things west of the mountains.

Not a traveler greets the eye at the salesrooms of the Meriden Britannia Co. W. C. Wood is in Dakota, Minnesota or Nebraska; C. A. Barnum travels over Illinois, Indiana and Iowa; J. A. McHenry has Colorado, Utah, New Mexico and Arkansas; E. T. Powers hovers over Michigan and Wisconsin, and E. Spencer and Mr. Wells visit the smaller towns in the west.

The first of the month all of B. F. Norris, Alister & Co.'s travelers departed; R. I. Hendershott to Michigan; W. H. Squire to north Michigan and Wisconsin; D. W. Robinson to Iowa, Minnesota and the Dakotas; H. P. Cutter to Illinois, Indiana and Ohio; F. P. Roby to north Iowa, and Z. E. Chambers to south Iowa, Nebraska, Kansas and north Missouri.

Geneva Optical Co.'s travelers are just starting out with remodeled territories. George R. Rouse is assigned to the south and southwest, T. R. Wall to the northwest, Ed McKee to the east, and W. L. Nason to the northeast and northwest.

The Ansonia Clock Co. have out Edward Bellows in the northwest, and W. C. Sisco in the east and southwest, and both are doing well. E. A. Tyler finds fair business in the large cities.

The Waterbury Clock Co. are represented in the far west by J. H. McCormick; L. A. Pettie is doing well in Wisconsin and the larger towns, and T. W. Agnew finds things quiet in his sections of Wisconsin, Illinois and Michigan. T. R. Wall has just started for Minnesota and the Dakotas.

E. O. Baumgarten visits the west and southwest in the interest of the Pairpoint Mfg. Co.; C. F. Coutts left Sunday for St. Paul, Minneapolis and northwestern points, and C. W. Miller and E. B. Frank are making preparations for western trips.

H. M. Tenney guards Lapp & Flershem's interests in Illinois, Indiana, and western Ohio; J. C. Moreland will greet his many friends in N. Iowa, S. Minnesota and S. Dakota; E. E. Spaulding will look after Minnesota, N. Dakota, Montana and Washington, and the irrepressible Paul R. Shordiche will make pertinent speeches in Michigan and Wisconsin. Tenney, Moreland and Spaulding are out and Shordiche will leave shortly.

Fred Boergershauser will reap orders for F. M. Sproehnle & Co. in Illinois, Iowa and Michigan, and F. Willman will perform the same service in Wisconsin, Minnesota and the Dakotas. Both are out.

All of Stein & Ellbogen's men are in their respective territories. George Fincke left Thursday for the west and southwest; Max Noel takes in Michigan, Indiana and Ohio; Frank Shadbolt has Minnesota and Dakota and M. Zuckerberg is in Illinois and S. Wisconsin. B. F. Kramer looks after the city trade.

C. A. Garlick is on the road in the west and R. W. Barlow left for the south the past week for C. H. Knights & Co.

# THE FIVE MOST DESIRABLE PATTERNS IN THE MARKET.



TRIANON.—Pierced.

LOUIS XIV.

MAZARIN.

ROCOCCO.

CUPID.

**Dominick & Haff,** Makers of Wares in Sterling Silver,  
Broadway and Seventeenth St., Union Square, N. Y.

ESTABLISHED 1821.

# CLASSIFIED INDEX TO ADVERTISEMENTS.

All Advertisements are entitled to one insertion under proper heading. Extra insertions, \$6.00 per annum. Extra Headings, \$12.00 per annum.

	Page.
<b>Aluminum Solder.</b>	
De Redon, C., 43 W. 21st St., N. Y. . . . .	10
<b>Art Pottery, Bric-a-brac, Etc.</b>	
Ahrenfeldt & Son, 56 Murray St., N. Y. . . . .	50
Bing, Ferdinand & Co., 106 Grand St., N. Y. . . . .	46
Borgfeldt, Geo. & Co., 18, 20 & 22 Washington Place, New York. . . . .	48
Bradley & Hubbard Mfg. Co., Meriden, Conn	8
Buning, F. W. & Co., 58 Murray St., N. Y. . . . .	51
Levy, Dreyfus & Co., 9 & 11 Maiden Lane, N.Y	52
Gleanzer Leon, J. & Co., 80 & 82 Chambers St., N. Y. . . . .	49
Hayiland & Abbott, 26 Barclay St., N. Y. . . . .	51
Hinrichs & Co., 29 & 31 Park Place, N. Y. . . . .	51
Le Boutilier & Co., 860 Broadway, N. Y. . . . .	17
<b>Auctioneers.</b>	
Comrie, A. J., P. O. Box 2403, New York. . . . .	31
Firuski, S. & Son, 85 Bowery, N. Y. . . . .	41
<b>Assayers &amp; Refiners.</b>	
Clark, J. L., Philadelphia, Pa. . . . .	18
Goldsmith Bros., Chicago, Ill. . . . .	23
Howard, S. P., 8 John St., N. Y. . . . .	52
<b>Badges, Medals, Etc.</b>	
Irons & Russell, Providence, R. I. . . . .	22
Schlechter, G. A., Reading, Pa. . . . .	52
Stockwell, E. R., 19 John St., N. Y. . . . .	4
Wilson, Chas. G., Reading, Pa. . . . .	10
<b>Chains, Seamless.</b>	
Kent & Stanley Co., Providence, R. I. . . . .	4
<b>Diamond Cutters.</b>	
Humphrey, J. B., Boston, Mass. . . . .	51
<b>Diamond &amp; Precious Stone Importers.</b>	
Disselkoen, John N., 19 E. 16th St., N. Y. . . . .	45
Falkenau, Oppenheimer & Co., 40 Maiden Lane, N. Y. . . . .	52
Hedges, Wm. S. & Co., 170 Broadway, N. Y. . . . .	44
Hahn, Rud. C., 194 Broadway, N. Y. . . . .	51
Kahn, L. & M. & Co., 10 Maiden Lane, N. Y. . . . .	52
Kipling, R. A., Hays Bldg., N. Y. . . . .	44
Kling, H. M. & Co., 11 John St., N. Y. . . . .	52
Lurdeke & Power, 23 John St., N. Y. . . . .	44
Nissen, Ludwig & Co., 18 John St., N. Y. . . . .	44
Randel, Baremore & Billings, 29 Maiden Lane,	45
Smith, Alfred H. & Co., 182 Broadway, N. Y. . . . .	44
Wolff & Gunzburger, 87 Nassau St. N. Y. . . . .	52
<b>Diamond Jewelry.</b>	
Bonner, Rich & Co., 41 Maiden Lane, N. Y. . . . .	34
Waterman & Lehman, 37 Maiden Lane, N. Y. . . . .	31
<b>Eye Glass Holders and Chains.</b>	
Merritt, S. F., Springfield, Mass. . . . .	34
<b>Fine Stationery.</b>	
Parsons, Green & Co., 18 Murray St., N. Y. . . . .	5
<b>Fountain Pens.</b>	
The Boston Pen Co., Boston, Mass. . . . .	10
<b>Cleaning Solution.</b>	
Quarters, W. F., Providence, R. I. . . . .	10

	Page.
<b>Gold and Silver Plating.</b>	
Brunor Plating and Jewelry Repairing Co. . . . .	5
Maiden Lane, N. Y. . . . .	5
<b>Gold Jewelry.</b>	
Bippart & Co., Newark, N. J. . . . .	7
Carter, Sloan & Co., 15 Maiden Lane, N. Y. . . . .	45
Hook, G. W., Chicago, Ill. . . . .	29
Kerr, Wm. B. & Co., 860 Broadway, N. Y. . . . .	14
Krementz & Co., 182 Broadway, N. Y. . . . .	8
Racine Jewelry Mfg. Co., Racine, Wis. . . . .	19
Smith, C. Sydney, 191 Broadway, N. Y. . . . .	10
Uhry, Chas. L. & Co., Newark, N. J. . . . .	5
Street, Geo. O. & Sons, 15 John St., N. Y. . . . .	10
<b>Horological Schools.</b>	
Parson's School for Watchmakers, Peoria, Ill. . . . .	22
<b>Hotels.</b>	
Gibson House, Cincinnati, O. . . . .	22
<b>Imported Clocks, Bronzes, Etc.</b>	
Jacques Chas., Clock Co., 22 Cortlandt St., N. Y. . . . .	52
<b>Jewelry Mailing Boxes.</b>	
Am. Railway Supply Co., 24 Park Place, N. Y. . . . .	4
<b>Jewelry, Silverware and Optical Cases.</b>	
Birmingham, Wm. & Co., 728 Arch St., Phila. . . . .	19
Troeschler, A. & Co., 69 Nassau St., N. Y. . . . .	44
Wiggers & Froelick, 60 Nassau St., N. Y. . . . .	44
Jackson, S. C., 180 Broadway. . . . .	19
<b>Jobbers, Watches, Diamonds, Etc.</b>	
Aikin-Lambert Jewelry Co., 19 Maiden Lane. . . . .	10
Bowman, Ezra F. & Co., Lancaster, Pa. . . . .	51
Cross & Beguelin, 17 Maiden Lane, N. Y. . . . .	34
Giles Bros. & Co., W. H. Gleason, receiver, Chicago, Ill. . . . .	27
Young, Otto & Co. Chicago, Ill. . . . .	27
Lapp & Flershem, Chicago, Ill. . . . .	28
Myers, S. F. & Co., 48 Maiden Lane, N. Y. . . . .	52
Yates, John B., Hays Building, Maiden Lane, N. Y. . . . .	19
<b>Musical Boxes.</b>	
Jacot & Son, 298 Broadway, N. Y. . . . .	7
Wolff, A., 194 Broadway, N. Y. . . . .	19
<b>Optical Goods.</b>	
Geneva Optical Co., Chicago, Ill. . . . .	20
Kirstein, E., Sons Co., Rochester, N. Y. . . . .	10
Winsted Optical Co., Winsted, Ct. . . . .	30
Queen & Co., Philadelphia, Pa. . . . .	4
Laurenot, Jules, 49 Maiden Lane, N. Y. . . . .	51
Scheidig, John & Co., 43 Maiden Lane, N. Y. . . . .	32
The Nous Verrons Co., Boston, Mass. . . . .	10
<b>Pens, Pencil Cases, Etc.</b>	
Aikin, Lambert & Co., 19 Maiden Lane, N. Y. . . . .	4
Beamel, D. W., 17 John St., N. Y. . . . .	31
<b>Patents.</b>	
Cox & Sons, 11 Park Row, N. Y. . . . .	41
<b>Ring Makers.</b>	
Bowden, J. B. & Co., 192 Broadway, N. Y. . . . .	7
Hildreth Mfg. Co., 51 Maiden Lane, N. Y. . . . .	8
<b>Sample Trunks.</b>	
Crouch & Fitzgerald, 161 Broadway, N. Y. . . . .	43
<b>Settings and Galleries.</b>	
Blancard & Co., 76 John St., N. Y. . . . .	19

	Page.
<b>Show Cases.</b>	
Smith, B. & W. B., 220 W. 29th St., N. Y. . . . .	52
<b>Silver Mounted Ebony Goods.</b>	
Deutsch Bros., 7 E. 17th St., N. Y. . . . .	2
<b>Silver Plated Ware.</b>	
Homan & Co., Cincinnati, O. . . . .	26
Pairpoint Mfg. Co., New Bedford, Mass. . . . .	5
Rogers & Bro., 16 Courtlandt St., N. Y. . . . .	3
<b>Silversmith.</b>	
Rohrbach, Henry J., 94-96 State St., Chicago, 22	22
<b>Sterling Silverware.</b>	
Campbell-Metcalf Silver Co., Providence, R. I. . . . .	44
Dominick & Haff, 860 Broadway, N. Y. . . . .	37
Gorham Mfg. Co., Broadway & 19th St., N. Y. 12-13	12-13
Knowles, J. B. & S. M., Co., Silversmiths' Hall, Union Square, N. Y. . . . .	7
Ovatt & Warner, Portland, Oregon. . . . .	22
Reed & Barton, 37 Union Sq., N. Y. . . . .	29
Shiebler, Geo. W., Co., 179 Broadway, N. Y. . . . .	18
Towle Mfg. Co., Newburyport, Mass. . . . .	34
Wallace, R. & Sons Mfg. Co., 3 Park Place, N. Y. . . . .	6
Wood & Hughes, 10 John St., N. Y. . . . .	44
<b>Stem Winding Attachments.</b>	
Abbott, Henry, 2 Maiden Lane, N. Y. . . . .	41
<b>Rolled Plate Jewelry.</b>	
Dederick, J. H., 16 Maiden Lane, N. Y. . . . .	18
<b>Tool Manufacturers and Dealers.</b>	
Bullock, O. W., Springfield, Mass. . . . .	7
Chicago Watch Tool Co., Chicago, Ill. . . . .	22
Gesswein, F. W., 39 John St., N. Y. . . . .	32
Horological Tool Co., Chicago, Ill. . . . .	22
Logan, A. J., Waltham, Mass. . . . .	10
Mosely & Co., Elgin, Ill. . . . .	22
<b>Tissue Paper.</b>	
Dexter, C. H., Sons, Windsor Locks, Conn. . . . .	9
<b>Tortoise Shell Goods,</b>	
Rice & Hochster, 483 & 485 Broadway, N. Y. . . . .	9
<b>Trunks and Traveling Bags.</b>	
Crouch & Fitzgerald, 161 Broadway, N. Y. . . . .	43
<b>Watch Case Manufacturers.</b>	
Goll, Henry, 17 John St., N. Y. . . . .	10
The Planchamp & Becker Co., Chicago, Ill. . . . .	22
The Wadsworth Watch Case Co., Newport, Ky. . . . .	25
<b>Watch and Clock Oils.</b>	
Nye, Wm. F., New Bedford, Mass. . . . .	24
<b>Watchman's Clocks.</b>	
Hausburg, O. E., 41 Maiden Lane, N. Y. . . . .	41
<b>Watch Importers.</b>	
Hyde's, J. E., Sons., 22 Maiden Lane, N. Y. . . . .	19
Mathey Bros. & Mathez Co., 21 & 23 Maiden Lane, N. Y. . . . .	19
Wittnauer, 19 Maiden Lane, N. Y. . . . .	31
<b>Watch Keys.</b>	
Clark, A. N., Plainville, Conn. . . . .	43
<b>Watch Manufacturers.</b>	
Baume & Co., London, England, and Syracuse, N. Y. . . . .	26
Durrstein & Co., World's Fair, Chicago. . . . .	29

## Special Notices.

Rates 75c. per insertion for notices not exceeding 3 lines (25 words), additional words 2 cents each. If answers are to be forwarded, postage stamps must be enclosed. Two insertions, 15 per cent. off; three insertions, 20 per cent. off; four insertions or more, 25 per cent. off. Payable strictly in advance. Display cards on this page will be charged at \$2.00 per inch for first insertion, subject to same discount as above for subsequent insertions.

Under the heading of **Situations Wanted** on this page advertisements will be inserted for **One Cent a Word**. This offer refers to **Situations Wanted only**. Payable strictly in advance. If answers are to be forwarded, postage must be enclosed.

## Situations Wanted.

Notices under this heading **ONLY** are charged at one cent a word, payable strictly in advance. If answer are to be forwarded, postage must be enclosed.

**POSITION** as salesman, retail jewelry or silver-ware. Experienced. References. Address "F," care, **JEWELERS' CIRCULAR**.

**SITUATION WANTED**.—An experienced traveler wishes a position in a first-class house. Many years on the road and well acquainted in all sections east of Omaha. Diamond house preferred. Address E. D., **JEWELERS' CIRCULAR**.

A **YOUNG MAN**, twenty-one, desires position with jewelry house; seven years' experience; good reference. Jos. Marks, care **CIRCULAR**.

**SITUATION WANTED** by a boy fifteen years old in a wholesale jewelry establishment, is at present in a retail jewelry store, therefore has some knowledge of the same and able to give good reference. Address M. R., care, **JEWELERS' CIRCULAR**.

**SITUATION WANTED** by an experienced and good workman as watch and clock jobber. Good references. Address M. J., care of **JEWELERS' CIRCULAR**.

**SITUATION** wanted as watchmaker and plain engraver by young man, twenty years of age. Good set of tools and references. Speaks German and English. Address A. A. M., care **JEWELERS' CIRCULAR**.

**SITUATION** wanted as watchmaker, clock and jewelry repairer, by a single man, twenty-seven years of age. Address Ed. S., Dresden, Ohio.

**WATCHMAKER AND JEWELER** with seven years' experience and tools wants position by October 1st; best references. Address Fred Farwell, Mt. Sterling, Iowa.

**BOOKKEEPER**.—Young man (25), experienced double entry and general office man, one acquainted in jewelry trade, desires position. A 1 reference. E., **JEWELERS' CIRCULAR**.

**WANTED** at once a position to finish the watch trade. Have had several years' experience as clock repairer and jewelry jobber. Best of references. Address Geo. C. Pouter, Walden, Orange Co., N. Y.

**WANTED**, A **POSITION** in a diamond, jewelry or fancy goods house. Have a thorough knowledge of the goods and a fair trade acquaintance. Satisfactory references. Address D. J. F., care of **JEWELERS' CIRCULAR**.

A **FIRST-CLASS** watchmaker wants position as good salesman. Has full set of tools. Address Waltham, care **JEWELERS' CIRCULAR**.

**WATCHMAKER AND OPTICIAN**, experienced, wants position about Oct. 10. Am a thorough man. References. None but good houses need reply. Address T. B., care **JEWELERS' CIRCULAR**.

**WANTED**.—Position as traveler for responsible house; 30 years a traveler and well known to Western trade. J. N. Lebold, 2072 West Lexington Ave., Chicago.

**POSITION WANTED** in wholesale jewelry house by a young lady thoroughly adapted for any inside position. Can furnish highest references. Address G. R. A., care **JEWELERS' CIRCULAR**.

**OPTICIAN**.—Situation wanted by a young man. A good refractionist. Capable of taking charge. Best references. Address O. T. A., care of **JEWELERS' CIRCULAR**.

A **BOY**, 14 years of age, desires a situation in wholesale jewelry house. At present employed in retail store. Can give good reference. Address M. R., care **JEWELERS' CIRCULAR**.

**SITUATION WANTED**.—By a first-class jeweler and watchmaker; five years' experience at fine watches, clocks and jewelry repairing; A1 references. State wages in first letter. Address P. M. A., care **JEWELERS' CIRCULAR**.

**JEWELER**.—Experienced in manufacture of jewelry; have had business of my own; wish a position as foreman or at the bench, or jobbing in store; also cut hubs and make tools; turn hand to anything. Address G. A. S., 102 Monmouth St., Newark, N. J.

## Help Wanted.

**WANTED** at once, in New York State, a good watchmaker, who can wait on the trade and take in work. A permanent position and good wages to right party. Address, giving nationality, references, experience, &c., Mead, care of **JEWELERS' CIRCULAR**.

**WANTED, MECHANICAL SUPERINTENDENT**.—A man possessing experience and ability—to take mechanical and business management of well equipped factory for the manufacture of small, well finished articles in optical and scientific instruments, &c. One who could invest some capital preferred, as the present owners have other business and wish a responsible manager. A. L. Smith, 69 Washington St., Chicago.

**FOR LOS ANGELES, CAL.**—Engraver to commence in the Fall; must be an expert workman on monograms and general letter work; no other will do; if a watchmaker, a jeweler, or able to repair fine French clocks, or even a good salesman, it would add to the value of his services; sample of engraving must accompany application. State wages, and if you write before Sept. 9 address Geo. A. Montgomery (of Montgomery Brothers), care of Gorham Mfg. Company, Nineteenth Street and Broadway, New York. After Sept. 9, write to Los Angeles.

## For Sale.

**FOR SALE**.—On account of death of owner, Hopkin's Lathe, with all attachments; Universal Lathe, Pivoting Lathe, and a complete watchmaker's outfit at less than one-third of original cost. Address Mrs. J. R. Abbott, care F. C. Gesswein, 133 E. 125th St., N. Y. City.

**FOR SALE**.—\$500 for \$300 cash. Jewelry, News Depot and furnished rooms for two. Rent \$8. Store pays profit; bench work for one. Address Cyrus Condit, 2344 Bellevue Avenue, Kansas City, Mo.

**FOR SALE**.—\$1,500 buys stock and fixtures of jewelry store in town of 4,000 inhabitants. Good run of work. Address W. F. Dudley, Hammonton, New Jersey.

## Miscellaneous.

I **BUY JEWELRY STOCKS**—Manufacturers, jobbers and retailers desiring to dispose of surplus or entire stocks of diamonds, watches and jewelry can find quick cash buyer by addressing Stephen S. Harmon, 134 East 96th St., New York city.

**TO MANUFACTURERS**—Wanted, an agency in Philadelphia for jewelry, watches or diamonds, by a person well known to the trade, in Philadelphia, Baltimore and Washington, D. C. Commission if desired. Address D. H. C., **JEWELERS' CIRCULAR**.

## DEMAGNETIZING.

**PERFECT WORK**—Watch repairing in all its branches; all work warranted. Winslow & Penney, 603 Masonic Temple, Chicago.

**WANTED** A second-hand Transit, if it can be warranted to be correct for watchmaker's use. Dealers and makers of transits will please send catalogues and lowest cash prices. Address, John Wagner, 116 Sunset Ave., Utica, N. Y.

**ONE CUSHION TIRE SAFETY BICYCLE**; high grade; to trade for jeweler's safe, at once. Address P. O. Box 426, Cherokee, Iowa.

**MR. ALBERT GULDENSTERNE** is no longer in the employ of Samuel Lawson, 11 Maiden Lane, New York.

**FOUND**.—On our showcase, in June a paper of mounted diamond jewelry, supposed to have been left by some traveling salesman; has been advertised in Boston Herald; owner will please call, prove property, pay expenses and take the goods. M. S. Page & Co., No. 1 Salem Street, Boston, Mass.

## To Let.

**TO LET** for business purposes; Broadway store near Post Office, half store and entire show-window. Junior, 2 Astor House.

**Headquarters**  
FOR  
**ELECTRIC & PORTABLE**  
Watchman's Clocks



Price, Complete \$10.00

Lowest Prices.  
Latest Improvements,  
Patents 1886-1893.  
Send for Circular.

**E. O. HAUSBURG,**  
41 Maiden Lane, New York. THE "ALERT."

**SOLICITORS OF**  
FOR **DESIGNS** **AMERICAN & FOREIGN**  
**INVENTIONS** **PATENTS** **SEARCHES MADE & INFRINGEMENTS PROSECUTED OR DEFENDED**  
TRADE MARKS  
TRADE WILL BE PROTECTED BY HAVING THEIR PATENTS TAKEN BY  
SAVE TIME AND MONEY

**COX & SONS 11 PARK ROW, N.Y.**

## PAWNBROKERS' SALES

BY

**S. FIRUSKI & SON,**

**AUCTIONEERS,**

85 Bowery, New York,

AT 11 A. M.

See N. Y. Herald for full particulars of Sales.

The Trade is Respectfully Solicited to Attend.

## HENRY ABBOTT,

MANUFACTURER OF

Stem-Winding Attachments

FOR WATCHES,

No. 2 Maiden Lane, NEW YORK.

**SPECIAL** **NOTICES**  
IN  
THE **JEWELERS' CIRCULAR**  
CIRCULAR  
Produce the results desired.

### News Gleanings.

O. M. Campbell, Vail, Ia., has sold out.

J. A. Knickerbocker, Aspen, Col., has sold out.

W. H. Breen, St. Paul, Minn., has made an assignment.

L. W. Lewis has opened a jewelry store in Antioch, Ill.

Frederick Lambert, Albia, Ia., has given a bill of sale for \$2,223.

F. G. E. Dufresne, Lima, O., has given a chattel mortgage for \$150.

Alexander McMichael, New Castle, Col., has discontinued business.

Abraham Johnson, Portland, Me., has given a bill of sale on stock.

E. B. Fanske, Vail, Ia., has given a chattel mortgage for \$1,100.

The death occurred last week of E. P. Maloney, Little Rock, Ark.

Julius Jensen, Provo City, Utah, has assigned, having preferred \$790.

A. L. Downard, Marengo, Ia., has given a real estate mortgage for \$300.

The store of George C. Mosher, Chattanooga, Tenn., has been attached.

A. C. Ruthstrom, Hancock, Mich., has given a chattel mortgage for \$450.

Hendrik Wykhuisen, Holland, Mich., has given a chattel mortgage for \$1,000.

J. P. Johnston, La Porte, Ind., is advertising his business for sale or exchange.

John Baxter, West Dennis, Mass., has given a bill of sale on merchandise, etc.

R. J. Philpot has removed from Red Lodge, Mon., to Livingston, same State.

E. L. Lilley, Milford, Mass., has added an optical department to his jewelry store.

The estate of Paul Paille, Griffin, Ga., has been succeeded by Charles Paille & Bro.

The store of C. H. Bartlett, Trinidad, Col., has been closed under a chattel mortgage.

A judgment for \$168 has been entered against Charles Bickelman, Schenectady, N. Y.

Mr. Blashill, of Imlay City, Mich., has opened a new jewelry store in Oxford, Mich.

In a fire in Elgin, Ore., the store of Geo. A. Brockenshaw was damaged to the extent of \$1,400.

The store of L. V. Kelley, Worcester, N. Y., has been closed under a chattel mortgage.

The death occurred last week of S. Maier, of S. Maier & Co., wholesale jewelers, Atlanta, Ga.

F. D. Day and wife, Duluth, Minn., have returned from a few weeks' stay at the World's Fair.

The store of J. C. Harrie, Morris, Ill., was damaged by fire to the extent of \$1,000 a few days ago.

Ed. B. Fanske, formerly with W. H. Miles, Belle Plain, Ia., has purchased a jewelry store in Vail, Ia.

The building in which is located the store of F. W. Sim & Co., Troy, N. Y., is to have a new front constructed.

Frank L. Nuse, jeweler, Titusville, Pa., was married Sept. 5th to Miss Lola G. Brown, of the same town.

George Wills, jeweler, Auburn, Me., was married a few days ago to Miss Sophia Benson Sumner, of Leeds, Me.

L. Schwab, Birmingham, Ala., will open a new jewelry store at the corner of Canal and Wabash Sts., Wabash, Ind.

A stranger entered the jewelry store of Moses Smith, Wilmington, Del., Thursday, and stole a dozen watches.

J. H. Crosby, of Greenleaf & Crosby, Jacksonville, Fla., is building a handsome residence on Ashley St., that city.

D. P. Lynch, of Waycross, Ga., has opened a jewelry and repair shop in the store of A. B. Weaver, Ft. White, Fla.

E. T. Jeannot, Youngstown, O., was bereaved last week in the death of his daughter, Mary C., at the age of nineteen years.

Charles K. Morgan has enlarged his jewelry store in Titusville, Fla., and is also preparing to settle down in the town as a householder.

Mr. Decker, who has been a watch repairer for C. H. Ankeny & Co., Lafayette, Ind., has accepted a position with a Cincinnati, O., house.

A. F. Froeb & Co., Terre Haute, Ind., have removed from 506 Wabash Ave. to No. 525 of the same thoroughfare, where they have twice the floor space as before.

P. H. Kreitz, an old and trusted employe of the late firm of Andrew Jackson, Duluth, Minn., has accepted a position as repairer and salesman with Jos. M. Geist, same city.

Robert Zanker, Marietta, Pa., is engaged in erecting a house on the river hills opposite Round Top. It is the intention to make a park and Summer resort at this beautiful spot.

E. A. Maxwell, Lafayette, Ind., has sold his jewelry stock to his cousin, J. C. Maxwell, of Robinson, Ill., and it was moved to that place last week. Mr. Maxwell has left for Indianapolis.

The jewelry store of R. Leubusher & Co., occupying rooms 66 and 67 in the Loan and Trust building, Milwaukee, Wis., has been seized by the sheriff on a claim of \$1,530, held by C. F. Alcott & Co.

W. H. Ludwig, who was chief clerk for George W. Ludwig, Chambersburg, Pa., and who is now with Oskamp, Nolting & Co., Cincinnati, O., has been succeeded by Reuben Naugle, a skilled jeweler.

H. A. Gurinian, Holdrege, Neb., was taken before the board of insanity a few days ago. He was found to be suffering from a mild form of insanity. It is thought a change of scene will cure him.

O. E. Armstrong, Coudersport, Pa., and his wife, have returned from their sojourn abroad. Mr. Armstrong had been gone for nearly a year in quest of better health. A great improvement in this respect is noted.

R. M. York, Gouverneur, N. Y., recently attended the golden wedding of his parents at Peru, N. Y. Five generations were represented—the fifth, Marshall Long, of Indiana, by photograph. There were four generations present.

### Springfield, Mass.

The police court case against Doty & Fitzgerald for running a lottery, which was to have been tried last week, has been put over to this week.

The awarding of the order for \$3,000 worth of diamonds to be given at the bicycle tournament to Jeweler Hubbard caused somewhat of a commotion among the other competing jewelers. There were three other competitors, Eldridge & Penny and J. C. Manning, of this city, and David Mayer, of Hartford, and each of these firms submitted \$4,000 worth of stones while Mr. Hubbard exhibited double that amount. By the conditions of the contest it was required that all stones should be mounted; thus the unsuccessful ones are out some \$90 each. The gems were selected by a committee, including one jeweler, and were chosen for their merit, as no names were attached.

### Syracuse, N. Y.

E. J. Hermans has returned from a three weeks' successful trip for the Green Novelty Mfg. Co.

On Monday Calvin S. Ball opened an optical department in connection with his jewelry store. The department is in charge of Herbert C. Watts, M. O., ophthalmic optician. Mr. Watts is a graduate under Dr. F. Carrow, professor of ophthalmology, University of Michigan, and was formerly with J. C. Watts & Co., Saginaw, Mich.

During the past week Baldwin, Miller & Co., Indianapolis, Ind., were visited by the following out-of-town jewelers: H. L. Jones, Laurel, Ind.; M. L. Michael, Milton, Ind.; Wm. Beatly, West Lebanon, Ind.; Louis F. Ott, Vredersburg, Ind.; Ike. Booth, Tifton, Ind.; T. W. Hayward, Fairfield, Ind.; Bly & Thornburg, Farmland, Ind.; Roger Bros., Bowling Green, Ind.; C. E. Barnes, Princeton, Ind.; Mr. Wilson, Neoga, Ill.; J. A. Spanier, Rushville, Ind.; C. R. Kluger, Huntingburg, Ind.; John Conzet, Greenup, Ill.; S. J. Bradshaw, Paris, Ill.; W. N. Rainboldt, Mitchell, Ind.; E. L. Jimison, Cowden, Ill.; Woodruff & McShane, Ninevah, Ind.; D. L. Ward, Lawrenceville, Ill.; W. T. Kathran, Poland, Ind.; H. Rider, Crothersville, Ind.; E. T. Jordan, Harmony, Ind.; T. J. Johnson, Shoals, Ind.; S. F. Cahill, Spencer, Ind., and E. M. Wilhite, Danville, Ind.



### Trade Gossip.

The Wadsworth Watch Case Co., Newport, Ky., are running steadily, and have kept their trade pretty well throughout the dull times. They gain new customers weekly.

Four-fifths of all the jewelers in the United States could visit the great World's Fair by taking advantage of the liberal offer on page 23, by Goldsmith Bros., Chicago. Send for their book giving valuable information.

Martin Mayer, the well-known manufacturing jeweler of Mainz, Germany, is now represented in New York by L. Mainz, at 523 Broadway, where can be seen the various products of the factories in Mainz, Pforzheim and Florence. Among the goods shown are silver bric-a-brac, in every style, souvenir spoons, silver filigree, coral goods, garnets, pearls, and other kinds of jewelry, together with a fine line of the firm's celebrated cut silver articles.

In a small four page pamphlet, entitled "Historical Notes on the Manufacture of Watch Jewels," Ls. E. Junod, of Lucens, Switzerland, sets forth a concise history of the use of jewels in watch movements, together with a detailed account of his own experience in the production of perfect watch jewels. He also describes the four qualities of jewels he produces for ordinary watches and the superior quality, of a different shape, which he makes for pocket and marine chronometers. Mr. Junod employs over 1,000 people in the manufacture of watch jewels of every description for movements, compasses, telegraphs, water gauges, etc. His sole agents for the United States and Canada are Ezra F. Bowman & Co., Lancaster, Pa.

Bougereau's two masterpieces, Nymphs and Satyr, and Psyche and Love, have been reproduced in miniature bas-relief on silver and gold match and plaster boxes, by Wm. B. Kerr & Co., 860 Broadway, New York, in such a delicate and artistic manner as to call for a letter of thanks and praise from the great painter. They show, as he says, "the greatest care in the work of reproduction, as well as the highest artistic taste," and are in thorough harmony with the high art work produced by this firm. On another page will be found three illustrations of the work, with the letter from M. Bougereau.

Half holidays and quiet afternoons are a thing of the past with the Spencer Optical Mfg. Co. and their large force of salesmen, as they are now busy from morning till night. There is no more talk of slow business, or no more little knots of clerks debating the silver question at 15 Maiden Lane. "This is my busy day" is written on every face. John S. Spencer, the genial treasurer, who is now at the helm, has regained his old-time smile which plainly says, "we are busy now." Such good reports from a house having so wide a circle of customers in every State of the Union is indeed gratifying.

John Scheidig & Co., 41 Maiden Lane, New York, are calling attention to a new improvement in the Dengler patent "Eclipse" eye-glass guards. These guards are gaining in popularity from day to day and are pronounced by leading opticians throughout the country to be one of the most easily adjusted and most adaptable offset guards in the market. The slotted post perfectly locks the guard and prevents it becoming loose, without the aid of an extra lock as required by other patterns. The adjustable "Eclipse" guard is the only one of its kind in the market and its large and increasing sales are a criterion of its position in popular favor.

The increase in cycling is causing a constant demand for the bicycle watch lately introduced by A. Wittnauer, 19 Maiden Lane, New York. This successful novelty which is as applicable to the dashboard as to the bicycle, consists of a perfectly adjusted watch, the product of the Longines Watch Co., fitted in a neat leather case on which is a metal spring by which the case is attached to the handle-bar of the bicycle. Being both a practical and reliable addition to the improvements which contribute to the comfort of the wheelman, this watch has already had a large sale, and jewelers will find it an article that, to paraphrase Pope, "to be sold, needs but to be shown."

Time was when to own a repeater, striking hours and minutes, was the privilege of none but the very wealthy, and therefore the general demand for these watches was so small that it hardly paid the retail jeweler to purchase them except on order. Now, however, when the Waltham repeating movements, cased in twenty year, 14.k cases can be purchased at the low price offered by John B. Yates, 21 Maiden Lane, New York, they become one of the best selling and most profitable lines which the retailer handles. Mr. Yates, who recently purchased from the American Waltham Watch Co. their entire remaining stock of Waltham repeating movements, is selling them at prices 30 per cent. less than they have ever been offered at before.

The new catalogue issued by R., L. & M. Friedlander, 65 Nassau St., New York, which is known as the Monarch Catalogue No. 50, is now ready for distribution. This book contains illustrations of their newest and most desirable goods. Over 100 pages are set apart for watches exclusively, 27 pages for diamond jewelry, 50 pages for gold emblems and medals, and over 300 pages for a general line of jewelry. It is an up-to-date catalogue and should be in the hands of every jeweler. In writing, dealers should send their business cards. This firm also issue a watch material, tool and optical catalogue, known as the Monarch Catalogue No. 27, and another called the Pocket Watch Price List, a novelty of its kind, inasmuch as all prices therein are doubled, thus preventing outsiders from becoming too familiar with the wholesale prices of the goods.

### Boston.

Henry Ives, optician, 16 Bromfield St., offers his creditors 25 per cent.

D. C. Percival, Jr., and the family of D. C. Percival are at the World's Fair.

The Boston jewelers have decided to continue their early closing Summer arrangement until Sept. 20th.

An injunction has been issued at the instance of Morrill Bros. & Co., restraining the Commonwealth Jewelry Co. and W. F. Joy from disposing of certain stocks of jewelry etc., held by the defendants.

Harry H. Vaughan is so far recovered that he was able to be out and visit his friends in the trade a few days ago. He will resume his duties at Smith & Patterson's next month.

Wilson Bros. decorated their windows handsomely on Labor Day with flags and bunting, profusely ornamented with silver and gold from their stock. The facade of the building was also trimmed with bunting and mottoes were displayed.

Traveling men in Boston last week were: W. B. Durgin, Concord, N. H.; R. C. Hamilton and T. F. Fessenden, Providence; T. B. Wilcox; H. W. Dunham; Mr. Whiting, S. E. Fisher & Co.; C. E. Munn, Meriden; H. F. Barrows, Jr., North Attleboro.

Mechanical Superintendent Marsh has been appointed assistant superintendent of the American Waltham Watch Co's factory vice G. H. Shirley, resigned. Master Watchmaker Church was promoted to the place made vacant by the promotion of Mr. Marsh.

### Providence.

Grover & Gleason have removed from 227 to 183 Eddy St.

John B. Wren, with the Jewelers' Mercantile Agency, starts this week for the World's Fair.

Irons & Russell have been awarded the contract for furnishing the official medals for the 73d annual fair of the Rhode Island State Fair Association, to be held at Narragansett Park, Sept. 18-23.

Among those who registered at the Rhode Island State Building at the World's Columbian Exposition the past week were: Mr. and Mrs. Henry A. Kirby, Mr. and Mrs. Oscar Kempf.

There is a better feeling among the local manufacturers, many of whom are increasing their force of employes and the number of working hours. It is expected that if no drawback is experienced, that business will be moving regularly with full complement of help within a fortnight.

O. E. Bell & Co., Cincinnati, O., are pushing their new catalogue to completion. It will be a valuable reference book to the trade, as a price list of combination and anti-combination watches, and jewelry, &c. The cover will be handsomely embossed.

The Latest Patents.

ISSUE OF AUGUST 22, 1893.

**503,600. WATCHCASE - DIE.** ADOLPH W. HOFMANN, Brooklyn, N. Y. Filed May 19, 1893. Serial No. 474,786. (No model.)

In a die for manufacturing watch case backs, etc., the combination with the block having the concavity in the top for the reception of the watch case back, and

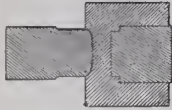

the recess in the bottom extending up into proximity to the concavity in the top of the hardened plug fitting in said recess and adapted to support the bottom of the concavity.

**503,612. SILVER CLEANING AND POLISHING COMPOUND.** GEORGE R. MEITZLER, Cincinnati, Ohio. Filed June 13, 1892. Serial No. 436,544. (No specimens.)

A compound of the kind described containing precipitated whiting, powdered soap bark, oil of sassafras and carmine, when combined with an ingredient possessing saponifying properties and being of lower degree of volatility than alcoholic substances, like ammonia, for instance, which remains moist a sufficient length of time to act upon incrustated impurities before the applied compound becomes dry, all parts in proportions stated.

**503,673. ATTACHING HANDLES TO VESSELS.** EDWARD M. PEACOCK, Brooklyn, N. Y. Filed Dec. 7, 1891. Renewed Jan. 23, 1893. Serial No. 459,448. (No model.)

**503,674. ATTACHING HANDLES TO VESSELS.** EDWARD M. PEACOCK, Brooklyn, N. Y. Filed Dec. 7, 1891. Renewed Jan. 23, 1893. Serial No. 459,449. (No model.)

**503,711. WATCHCASE-PENDANT.** OTTO W. BUERGER, Quincy, Ill. Filed Jan. 31, 1893. Serial No. 460,322. (No model.)

In a device of the character set forth, the combination of the arbor having a tooth thereon, and a sleeve loosely



fitted over said arbor and having an opening extending lengthwise thereof with a larger opening at one end of the same, said opening being engaged by the said tooth on the arbor.

**503,763. FOUNTAIN-PEN.** MARVIN M. FENNER, Wanpau, Wis., assignor of one-half to James

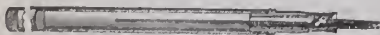

B. Shea, same place. Filed Feb. 24, 1893. Serial No. 463,554. (No model.)

**503,803. SPECTACLES.** SUSETTE ORTH, Philadelphia, Pa. Filed May 5, 1893. Serial No. 473,063. (No model.)

The combination in spectacles, of the frame with

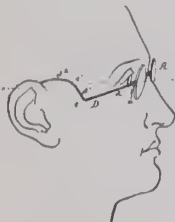

temples connected thereto, each temple having between the frame and the curved rear end a bent por-

tion extending below a line drawn from the center of the eye to the top of the ear, to rest upon the face between the ear and the eye.

**DESIGN 22,716. BADGE.** HARRISON BRUNER, Sundance, Wyo. Filed July 5, 1893. Serial No. 479,660. Term of patent 14 years.

**DESIGN 22,717. SPOON.** DAMON GREENLEAF,



and JOSEPH H. CROSBY, JR., Jacksonville, Fla. Filed July 20, 1893. Serial No. 481,058. Term of patent 7 years.

**DESIGN 22,718. SPOON.** GEORGE T. JACOBS, Washington, D. C., assignor of one-half to Daniel



Williams, same place. Filed July 14, 1893. Serial No. 480,537. Term of patent 3 1/2 years.

**DESIGN 22,719. HANDLE FOR SPOON, &C.** CHARLES C. WIENEGE, Providence, R. I. Filed

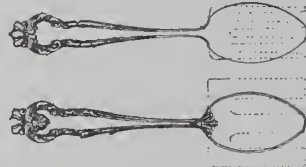

July 28, 1893. Serial No. 481,773. Term of patent 7 years.

**DESIGN 22,720. CANE OR UMBRELLA HANDLE.** CHARLES W. KENNARD, Balti-



more, Md. Filed Apr. 6, 1893. Serial No. 469,361. Term of patent 3 1/2 years.

**DESIGN 22,721. CANE OR UMBRELLA HANDLE.** CHARLES W. KENNARD, Balti-

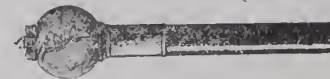

more, Md. Filed Apr. 6, 1893. Serial No. 479,362. Term of patent 3 1/2 years.

**DESIGN 22,722. CANE OR UMBRELLA HANDLE.** CHARLES W. KENNARD, Balti-



more, Md. Filed Apr. 6, 1893. Serial No. 469,863. Term of patent 3 1/2 years.

**DESIGN 22,725. BOX-COVER.** WILLIAM O. TOLMAN, New Bedford, Mass. Assignor of the Pairpoint Manufacturing Company, same place.

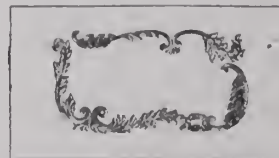

Filed Mar. 31, 1893. Serial No. 468,615. Term of patent 7 years.

**DESIGN 22,727. TEA OR COFFEE POT.** AUS-

TIN F. JACKSON, Taunton, Mass., assignor to the Reed & Barton Corporation, same place. Filed



June 23, 1893. Serial No. 478,663. Term of patent 14 years.

**DESIGN 22,733. METALLIC ROSETTE.** FREDERIC L. THOMPSON, New Bedford, Mass., assign-



or to the Pairpoint Manufacturing Company, same place. Filed Jan. 18, 1893. Serial No. 458,805. Term of patent 7 years.

**DESIGN 22,734. METALLIC PATTERN-STRIP.** FREDERIC L. THOMPSON, New Bedford, Mass., assignor to the Pairpoint Manufacturing Company, same place. Filed Jan. 18, 1893. Serial No. 458,803. Term of patent 7 years.

**DESIGN 22,735. METALLIC PATTERN-STRIP.** FREDERIC L. THOMPSON, New Bedford, Mass.,



assignor to the Pairpoint Manufacturing Company, same place. Filed Jan. 18, 1893. Serial No. 458,864. Term of patent 7 years.

THE COMMERCIAL TRAVELER.

FIRST in the crowded car to offer—  
 This traveling man, unhonored and unsung—  
 The seat he's paid for he is first to proffer  
 To some lady old and wrinkled, or some woman  
 fresh and young.  
 Something, a trifle from his sample may be,  
 To please the fancy of a crying baby.  
 He lifts the window or he drops the curtain.  
 For the unaccustomed hands. He lends his case—  
 For a bolster for a child, not certain  
 But the mamma will frown him in the face—  
 So anxiously some women seek for danger  
 In every courteous act of every stranger.  
 Well versed is he in all those ways conducive  
 To comfort where least comfort can be found.  
 He turns the seat unasked, yet unobtrusive;  
 His little deeds of thoughtfulness abound;  
 Is glad to please you, or have you please him,  
 Yet he takes it very calmly if you freeze him.  
 He smooths the Jove-like frown of the official,  
 By paying the fare of one who cannot pay.  
 True modesty he knows from artificial,  
 Will flirt, of course, if you are inclined that way.  
 And if you are, be sure that he detects you.  
 And if you are not, be sure that he respects you.  
 The sorrows of the moving world distress him;  
 He never fails to lend what aid he can.  
 A thousand hearts to-day have cause to bless him,  
 'This much abused, misused "commercial man."  
 I do not seek to cast a halo round him,  
 But speak of him precisely as I've found him.

Filla Wheeler Wilcox

### The Balance and its Several Auxiliaries.

BY T. C. SCOTCFORTH.

AS may be seen by the diagram, fig. 1, the mode of connecting the balance and roller with the lever and pallets is by planting the pieces sufficiently close together, so that the jewel pin of the roller is linked into the lever notch, by which contrivance the lever and roller can turn each other alternately, as will be shown in the following, first remarking that the vi-

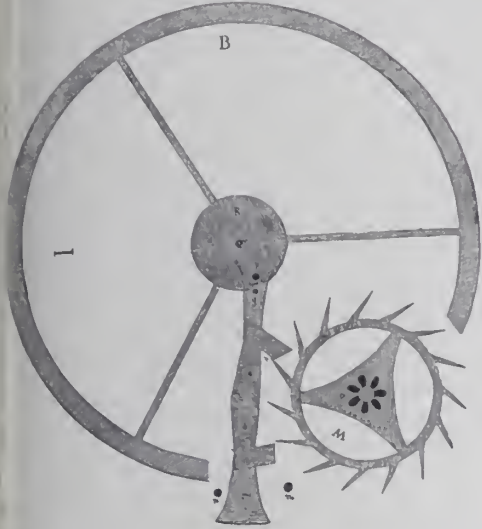

FIG. 1.

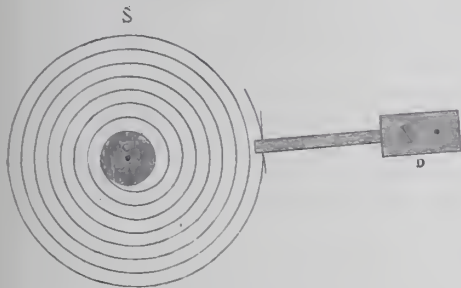

FIG. 2.

brations of a watch balance is a reciprocating circular motion, the motion being reciprocated by a spiral spring, S, fig. 2, usually called the balance spring, one end of it being fastened to a collet, C, placed on the balance axis, and the other end to a stud, D.

Each of the two pallets is shaped for the double purpose of impulse and locking, P P being the two impulse planes, and K K the

two lockings; by turning the escape wheel forward, a tooth of the wheel passes over one of the impulse planes and thereby turns the pallets and lever together through a small arc of perhaps about 9°; and as the roller and balance are linked to the lever by the pin and notch, the balance also is simultaneously turned through an arc, the arc of the balance always being much greater than that of the lever, according to the ratio existing between the radii of the small roller and the longer lever. At the extreme end of the pallet plane the impulse action ceases, and another tooth of the escape wheel drops on to one end of the opposite lockings, k, just like it is shown in the diagram, where the wheel tooth is resting on a locking, stopping all the machinery of the watch, except the balance and roller, for at the instant of the drop of the escape wheel the roller jewel pin passes out of or away from, the open notch of the lever, and the balance and roller revolve by themselves, perfectly detached from the rest of the mechanism of the watch.

The force of the mass of the balance in revolving winds up the reciprocating spring, S, and as soon as this spring has secreted all the force of the balance, the motion is reciprocated by the uncoiling of the spring. Arrived at the place of the escapement arc (where the lever is lying at the proper angle against one of the banking pins), the roller jewel pin enters the lever notch, and the reciprocated force of the balance, by the aid of the roller pin, now moves round the lever and pallets sufficiently far to draw the locking, k out from under the tooth of the escape wheel, and all the mechanism then being set free, the escape wheel moves forward again over the impulse plane of the opposite pallet, giving another impulse to the pieces, and again another tooth of the wheel drops on to the opposite side locking, the wheel resting there and stopping all the machinery, while the roller and balance vibrate freely as before.

The foregoing is a description of the action of this escapement, but we have yet to explain that the complete or full vibration of the balance is a motion begotten by several additions of the impulsive force, the excursion of the balance emanating from the first impulse, frequently being about

120° by measure on the balance circle, while the vibration at the end of the additional impulses is perhaps 200°; this doubled for both sides of vibration makes 400° so that the impulses as we see them at the full vibration, are given when the balance is already in motion, and no mechanical power ever operates with its full energy when the impelled body is already in motion, and in this case the force of pressure of the escape wheel and lever gradually decreases as the crank of the balance or roller recedes faster from these impulse agents. It is only at the first impulse that the energy of the main power is fully effective in impelling the balance, all the after impulses gradually decrease in intensity up to the full vibration.

The reason why these additional impulses to generate the full vibration exist is because the second and subsequent impulses continue to add more velocity and, consequently, force, to the balance than was lost between the discharge of the balance from the impulse arc until the return of the impulse again. Let us suppose that the balance started at a velocity (V) and the force of the mass wound up the spring to 120° on the balance arc; on returning from this excursion let the diminished velocity be exactly replenished by the second impulse; the balance would in this case be discharged from the opposite side of the escapement arc at the same velocity (V) with which it was discharged at the initial impulse, and would rise to precisely the same height of 120° on the other side of the vibrating arc, so there would only be these two impulses to generate the full vibration, and similar reasoning applies to three or four or any other number of additional impulses, for impulses will continue adding velocity and force to the balance until they cease to increase the velocity at the discharge from the impulse arc, and when this obtains there will be an end to the additional impulses, the after impulses of the same intensity being maintained only.

"Miss G— is a little passéé, but what a beautiful necklace she has!"

"Yes, it reminds one of a lantern on a wreck."  
—New York Recorder.

**CROUCH & FITZGERALD,**  
Jewelry Trunks and Cases.  
161 Broadway  
Bet. Cortlandt and Liberty Sts.,  
688 B'way,  
701 6th Ave.,  
NEW YORK

Sold by all wholesale dealers at manufacturer's price.

**A. N. CLARK,**  
PLAINVILLE,  
CONN.

Manufacturer of the Celebrated  
**LOOP WATCH KEY.**

The Best for the Price in the World.  
CROSBY'S JEWELING TOOLS IMPROVED.

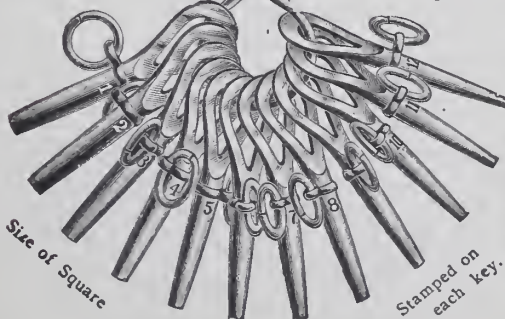

Size of Square

Stamped on each key.



Will quote royalty or price for the manufacturing of articles of real worth.

**DIAMONDS.**

**Wm. S. Hedges & Co.,**

**Importers of Diamonds,**

And Manufacturers of DIAMOND JEWELRY.

170 Broadway, New York.

27 Holdorn Viaduct, London.



18 JOHN ST. NEW YORK

**Alfred H. Smith & Co.,**

IMPORTERS

**DIAMONDS**

AND

PRECIOUS STONES,

182 BROADWAY, COR. JOHN STREET,

NEW YORK.

33 Holborn Viaduct, London, E. C.

**CAMPBELL-METCALF SILVER CO.**



176 Broadway, N. Y., Room 14. 66 Stewart St., Prov., R. I.  
Mills Bldg., San Francisco, 8th Floor, Room 1.



Patent applied for

Victoria Novelties, many fancy shapes.  
Celluloid Top, Sides, Bottom and Cushions  
**A. TROESCHER & CO., 69 Nassau St., N. Y.**

**R. A. KIPLING,**

Importer of

**PRECIOUS STONES,**

21 & 23 Maiden Lane,

19, RUE DROUOT,  
PARIS.

New York.

**LUDEKE & POWER,**

IMPORTERS OF DIAMONDS

AND OTHER PRECIOUS STONES,

ADOLPH LUDEKE,  
CHAS. L. POWER.

23 JOHN STREET, N. Y.

**WOOD & HUGHES,**  
**STERLING SILVERWARE MANUFACTURERS**

New York Agents for the Derby Silver Co.'s  
FINE QUADRUPLE PLATED WARE,  
NO. 16 JOHN STREET, NEW YORK  
206 Kearney St., San Francisco, Cal.  
HASKELL & MUEGGE, Agents.

**WIGGERS & FROELICK,**  
60 NASSAU ST., NEW YORK.

**Sample Cases and Trays**  
For Watches, Jewelry, Optical Goods, Etc.

**WE STRIVE TO MAKE THE BEST.**

**Workshop Notes.**

**Cutting a Screw Thread.**—A good way is to cut a thread in a hole that is too large, and then turn down the steel gradually to the proper size. It is natural that a certain force must be employed, but the liberal use of oil and careful practice will soon enable any one of ordinary mechanical ability to make a successful job. Screws with threads above a certain diameter should never be made in an ordinary screw plate, and the appliances used in our watch factories might easily be introduced by material dealers.

**Adjustment.**—A badly conditioned watch of any kind or quality cannot be adjusted at all, but a well conditioned piece is already adjusted, with the exception of regulation for temperature, isochronism, and poise of balance spring. It is clear, then, that certain conditions must be conformed to before any attempt is made in the three adjustments. Escapement, pivoting, jewel-ing, shape of balance jewel holes, balance, size, shape, and ends of balance pivots, equalizing the frictions, etc. are a few of the many conditions referred to.

**The Lead Bath for Tempering, etc.**—A lead bath is a convenient little arrangement rarely seen in a watchmaker's shop as yet, but its value is so great that it ought to be used everywhere and doubtless would be were it better known. It is a vessel of melted lead, in which articles are immersed to be heated instead of being put into a fire or flame. The advantages are that all parts of the article are equally and evenly heated, whether they are thick or thin, and whatever their shape may be, the objects are protected from the air while being heated, and there is no danger of overheating or burning. In a coal fire or flame the thin parts get heated through before the thick ones, and by the time the latter are heated up the thin parts are overheated or burned.

**To Fix a Balance Spring to Its Collet.**

A COMMON way of doing this, says Claudius Saunier, is to place the collet on a wire or broach which is held in one hand, while the other presents the inner end of the spring held in tweezers to the hole in the collet, subsequently fixing it with a pin. The following is a more convenient method:

At the middle of a brass plate is a boss tapped through a vertical hole in its center to receive a small screw with flat head. When the collet is fixed by this screw passing through it, the operation of setting the spring in position and pinning it will be much facilitated and the plate will at the same time afford a means of testing its parallelism. Two or three screws with heads of various sizes should be provided and in order that they may be always available they should be screwed into holes at a corner of the plate.

**Fashions in Jewelry and Silver-Ware.**

A LADY'S RAMBLES AMONG THE JEWELERS.

Rococo ornamentation prevails in jewelry.

The enameled battle axe is putting in claims.

There is a vast improvement in the stoppers of crystal bottles.

Gold tipped shoe lacings and gold tipped corset laces are announced.

Round bodied vases have heavily twisted necks expanding into round heads.

The spool holders of silver each week seem prettier and more ingenious.

Rococo forms, with gold interlacings are found in every sort of ornament that women wear.

Brooches consisting of a sword and scabbard crossed, with frequently a military hat added to the trappings, are new.

The wreath has not inappropriately followed in the path of the sword. Frequently the two are combined. These are the prettiest devices in wreaths.

Crystal buttons in rims of silver might be worth the consideration of jewelers. These would be used on the cavalier jackets of velvet and brocade, and on the double breasted Eton jackets now worn.

Silver was never more attractively used than to-day, in numberless forms. Tiny vases, with flower shaped mouths, have appliques of vines and flowers clinging to their sides, modeled as freely as in nature.

Crystal bonbon boxes are most desired by women. They have metal tops, but since confectionery has become so ornamental it shows prettily through the glass, and can even be made to harmonize with the costume.

The sword will remain the most popular device for brooches, and lace, stick and scarf pins. There is nothing too costly wherewith to enrich them. An enterprising firm has had General Grant's sword in the Metropolitan Museum photographed, and has reproduced miniature swords in gold, enamel and jewels from it. The scabbard is quite essential to sword pins, the hilt being a little top heavy for the blade, and liable to come out unless carefully put in. The scabbard and chain, of course, obviate this danger.

ELSIE BEE.

Mrs. Crawford, in London *Truth*, relates how a woman made her toilet in the train with the conveniences that hung to her chatelaine. These were of silver and comprised even a water jug, basin and sponge. There were, of course, receptacles in which were stored soap, comb, manicure implements, rouge, powder, powder puff and cosmetic for the eyebrows. When the owner had finished with these she looked as fresh and fair and rosy as if she had just stepped from her dressing room.

ESTABLISHED 50 YEARS.

**RANDEL, BAREMORE & BILLINGS,**

IMPORTERS OF

**DIAMONDS,**

AND OTHER PRECIOUS STONES.

**FINE PEARLS A SPECIALTY.**

MANUFACTURERS OF

**DIAMOND JEWELRY,**

IN THE LATEST DESIGNS.

Diamonds Recut in Modern Styles or Repaired on Premises.

58 Nassau Street,  
29 Maiden Lane  
NEW YORK.

1 Tulp Straat,  
AMSTERDAM.

1 St. Andrews St.,  
Holborn Circus,  
LONDON, E. C.



TRADE MARK.

ESTABLISHED 1841.

**CARTER, SLOAN & CO.,**

**MANUFACTURERS OF GOLD JEWELRY,**

No. 15 MAIDEN LANE,

NEW YORK.

A. CARTER, JR.  
A. K. SLOAN.  
C. E. HASTINGS.

GEO. R. HOWE.  
WM. T. CARTER.  
WM. T. GOUGH.

FACTORY, NEWARK, N. J.



**JOHN N. DISSELKOEN,**  
Cutter and Importer of  
**DIAMONDS**  
FACTORY,  
76 LANGEBLEEKERSPAD,  
AMSTERDAM.

19 East 16th St.,  
NEW YORK.



# Grand STREET Exhibition!

To the Jewelers.....

You have visited the World's Fair, now come and see us.

You will find in our Warerooms more ARTISTIC NOVELTIES than you have seen at Jackson Park

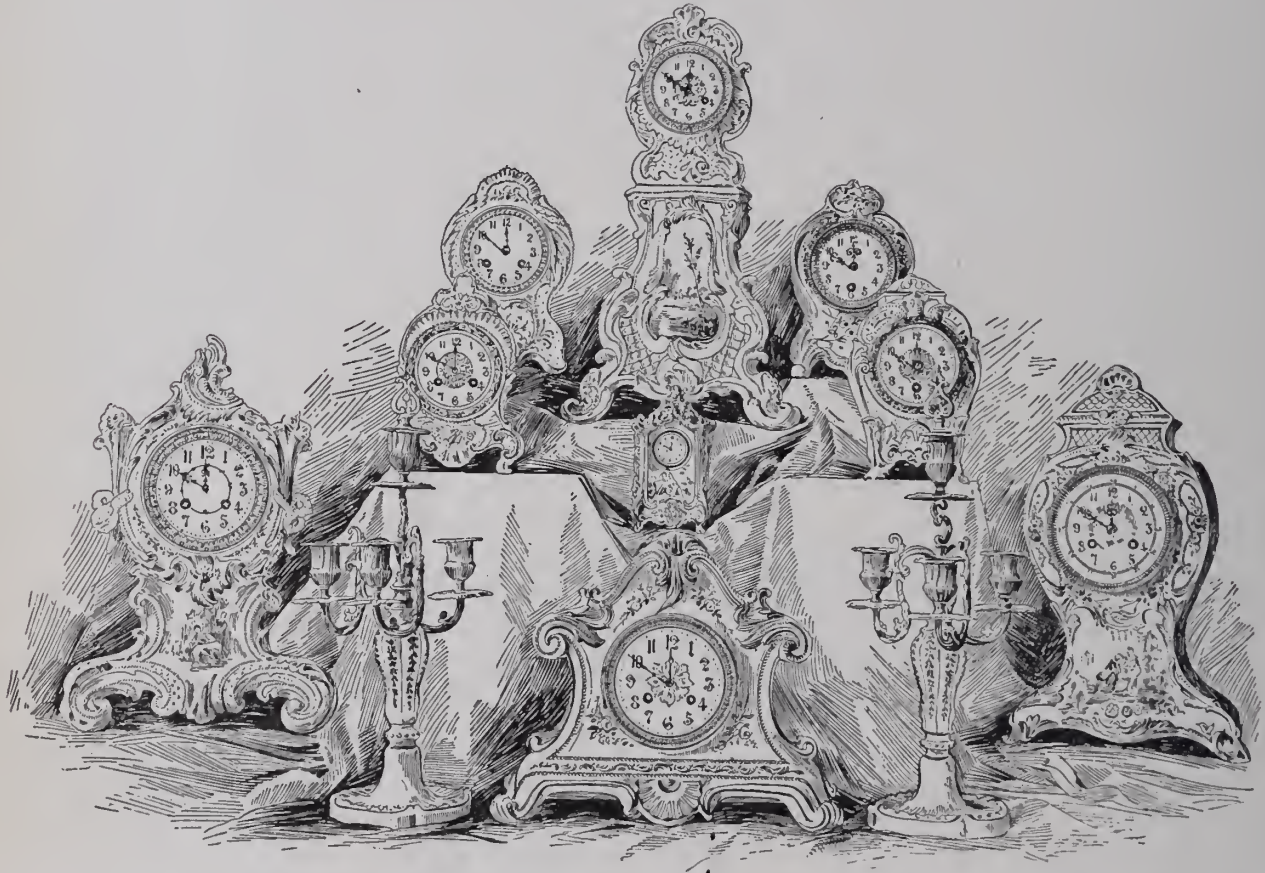

France==BRONZES, CLOCKS OF ALL DESCRIPTIONS, SEVRES VASES, LAMPS, PORCELAINS, FINE FURNITURE.

Germany==ROYAL BERLIN, ROYAL BONN, NURNBERG MAJOLICA, DRESDEN VASES, DRESDEN LAMPS IN ENDLESS VARIETY, DRESDEN FURNITURE, IVORIES.

Austria==DECORATED GLASS, OLD VIENNA WARE, TEPLITZ GOODS, FAYENCE STATUARY, BRONZES.

Italy==SUPERB LINE OF CARRARA AND CASTELLINA MARBLES, NOVE AND BASSANO FAYENCE, CARVED FURNITURE.

England==ROYAL WORCESTER, COALPORT, TULIP GLASS, ENGLISH CHIMING HALL CLOCKS.

## Ferdinand Bing & Co.,

74 Rue d'Hauteville,  
PARIS.

106 Grand Street,  
NEW YORK.

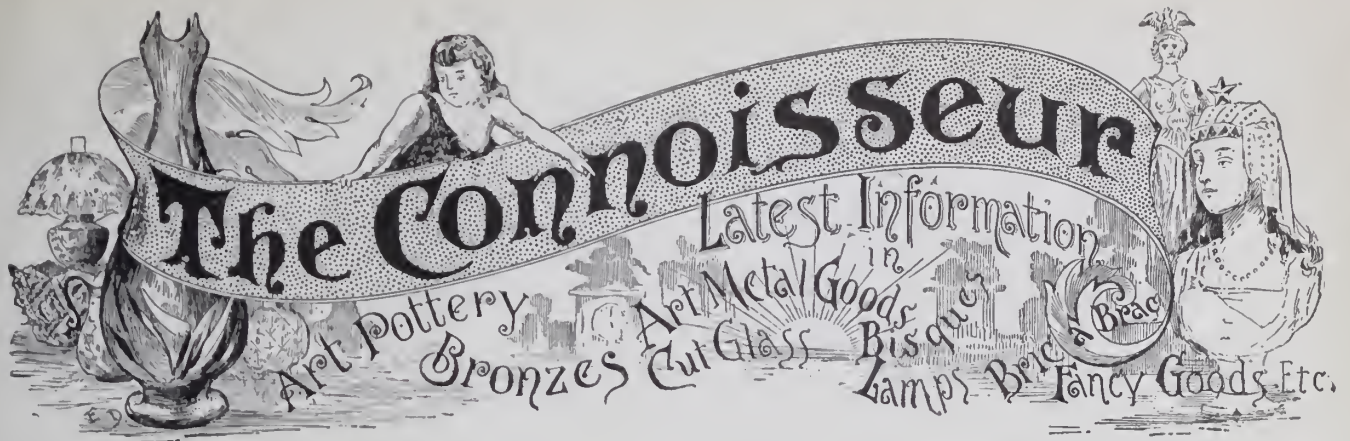

## ARTISTIC BRONZES AT THE WORLD'S FAIR.

PART II. CONCLUSION.

PASSING from one pavilion to another in the French department of real bronzes at the World's Fair, one is surprised at the different forms and shapes to which figures can be applied for the purposes of the modern system of electric lighting. Indeed the mind of the French artist seems to have been extremely active in the development of this species of ornamentation coupled with usefulness.

In one of the principal pavilions in the real bronze department stand two life-size female figures, with arms upraised, holding torches aloft, in the bowls of which are concentrated many different designs for the emission of the light. This pair is intended for electric lighting in a spacious hallway, and is valued at \$10,000. The composition bronzes are utilized for the same purpose, and the manufacturers producing them receive a large patronage because of the cheapness of the pieces and their adaptation to less expensive establishments than those of the more wealthy. And yet in the line of composition bronzes the imitations are so perfect that only an expert could detect the real from the imitation. In the latter class are many small figures which are sought by people of slender means as souvenirs.

### OLD AND NEW ITALIAN ART.

The Italian bronzes are divided between dignified and serious reproductions of statues and busts from the Vatican and other collections, and rather frivolous groups copied from modern pictures. The French keep the "bronze de fantaisie" in strict subordination; the Italians fairly run riot in it and detract still further from the essential dignity of bronze by the free use of silver and gilt on its surface. Opinions may differ about the true "patronage" of bronze, but there can be no dispute that it is alien to gold or silver. Nor can there be any serious controversy that the playful side of fictile art finds most fitting expression in bisque or china. Among the innumerable small pieces in bronze which the Italians show there are a number of decorative articles modeled on the work of Benvenuto Cellini and his school. But these, like other Italian exhibits in the

sphere of art merely intend to emphasize the fact that the craft and spirit of the Renaissance is as dead in Italy to-day as are those of the classical antiquity from which they drew their inspiration.

### JAPANESE BRONZES.

Japan makes a lavish display of those elaborately pierced and chiseled productions in which the skill and patience of the artificer are easier to discern than the genius of the artist. But there is a vivid imagination in the grotesqueness of the legendary heroes, demigods and dragons, and a conscientious study of nature in the elaborately executed bird pieces that command admiration, and there is about the tone of some of even the most commonplace pieces a richness of half lustrous color that is the despair of imitators.

The Japanese treat bronze almost as if it were a ductile metal—carve on it, ornament it with inlays, and, generally speaking, make the casting a basis for the work of the tool. Where they have yielded to the influence of French art, it has been to the detriment of the characteristic excellence of their work; where they maintain their antique traditions, they occupy a place and an eminence all their own.

The commercial bronzes of Germany bear but little of the stamp of art, while its artistic bronzes do not commend themselves to commercial distribution. One might covet a reduced copy of Max Kruse's "Messenger from Marathon," of Brutt's fisherman carrying in his arms the girl rescued from drowning, or of Herter's study of the other fisherman who has caught "a fish rarely to be met with"—a mermaid, to wit—but the work of German sculptors does not, on the whole, lend itself readily to reduction, and, therefore, not to diffusion. It is more conspicuous for strength than delicacy, for originality of conception than for felicity of treatment. It marks, however, a long advance since 1876, when the German bronzes at the Centennial were quoted as warnings rather than examples.

Among the French bronzes is a liberal display of French clocks. Many, and indeed the majority of these, are the reproduc-

tions of ancient timepieces. An interesting collection of reproductions of the antique is found in the pavilion of G. Lamaille & Co., and the prices range from \$10 to \$500. On the walls of this pavilion is an exact copy, one-tenth size, of the clock which hangs in the tower of the old law courts of Paris. It bears upon its face, beneath the dial, the motto: "Machina quae bis sex tam justa dividit horas justitiam servare monet leges que tuer." A crude translation of the above would mean that a machine which so exactly divides the hours should instruct the people and judges to promote justice and correctly apply the law.

### Bradley & Hubbard's Fine Offices.

THE Bradley & Hubbard Mfg. Co. have made a number of improvements in their offices in Meriden, Conn., during the last three months, which make them among the most elaborate in the city.

The woodwork is of oak elegantly polished. As one enters, the first office is that of the paymaster where the clerks of the payroll are working. To the right of the entrance is a corridor with offices on each side. On the left are three apartments. The first one is occupied as mentioned before by the paymaster, the second enclosure is that of the invoice clerk. The last office is for the book-keepers. Each apartment is well lighted and ventilated, with glass partitions and a window the height of the room. Over each door is a transom. On the right passage way is the head book-keeper's office, taking up all the space on that side with the exception of the office boys' department.

The main office has been enlarged about fifteen feet at the south end, making the room more spacious and better ventilated.

The silver wine bottle handles are now made with an attention to their graceful lines.

Bottles for crème de menthe and char- treuse, the favorite cordials, have a place on many convenient tables.

## The Connoisseur.

(Continued from page 47.)

### The Rambler's Notes.

WHAT THE RAMBLER SAW AND HEARD AMONG THE DEALERS IN ART POTTERY, CUT GLASS, BRONZES, ETC.

CRAIGHEAD & WILCOX, 33 Barclay St., New York, are showing many new and beautiful patterns in banquet lamps. One of the handsomest in their gilt and silver line has for the stem a female figure representing "Roses." Another handsome piece has the body of dark green enamel, decorated with a gilt Cupid. The lamps which have the appearance of wrought iron open work are particularly attractive. In these the cylinders and founts are in red or yellow enamel, contrasting well with the black unpolished appearance of the metal frame work. This firm have reproduced in miniature their Love's Victory lamp, which attained such marked success last year. The reproduction, which is about half the size of the original, makes one of the handsomest banquet lamps ever placed on the market.

\*

In their open stock of Wedgwood Jasper Maddock & Co., 20 Barclay street, New York, show some vases of a new shape, which are exceedingly attractive. They

are also showing a large assortment of small novelties in this ware, among which is the oval pin tray here illustrated, which can be had in any of the following colors: dark blue, light blue, sage, heliotrope or black. During the Fall many new pieces will be added to the line of Wedgwood novelties exclusively controlled by this firm.



\*

Among the new goods at the warerooms of A. Klingenberg, 35 Park Place, New York, is a line of very pretty Carlsbad vases, flower holders and trays. These are in dark green and cream white, and heliotrope and cream white, the darker color being at the bottom of the piece and gradually shading into the white. Artistic floral decorations enhance the beauty of all the pieces.

\*

Lazarus, Rosenfeld & Lehman have opened a fine assortment of Hungarian ware, which they are now showing at their ware rooms, 60-62 Murray St., New York. The line includes everything in the way of fruit holders, baskets, vases, jardinieres, compots, etc., in both the deep colored decorations with Cupid and figured panels, and the multi-colored open work. In the former many large, handsome vases and new shaped fruit holders are shown, while the latter are best seen in the baskets and magnificent jardinieres. Of the smaller pieces, such as

flower holders, pitchers, ewers, etc., many are in shapes odd and grotesque, with striking decorations. An extensive variety of these goods is shown.

THE RAMBLER.

### New Productions in Leeds Ware.

THE Leeds Art Pottery Co. have produced a large assortment of new goods. The company make many patterns of what are known as art flower pots—ornamental pots for holding the common flower pots in which plants are usually grown. The latest novelties are in "Rococco," "Cameo" and "Baroque" decoration. These and other new decorations are shown in all the well-known shapes of the company and also on several that are quite new.

The Cameo pots are a pleasing change from the ordinary run of these goods. They have pretty embossed ornamentations from the bottom and again at top. In some the body of the pots was a deep chocolate, while the embossed work was in light colors ranging from light yellow at the bottom to terracotta color at the edge. The effect of this was to make the embossed patterns stand out cameo-like from the ground color. The finest specimens are shown in their pedestals and vases, umbrella stands and tall grass vases. The rococco style of decoration is applied to these large pieces with



## Exceptional Opportunity

FOR

## Bric-a-Brac Buyers!

OUR entire collection of IMPORT SAMPLES comprising \$100,000 worth of HIGH ART NOVELTIES, specially imported for the Jewelry

Trade, are now on exhibition and will be sold on and after Sept. 1st, at **Big Reductions** to make room for new importations of Fine Pottery, Art Furniture, Marbles, Exclusive Art Productions, &c.

## GEO. BORGFELDT & CO.,

18, 20, 22 WASHINGTON PLACE, cor. Greene Street, NEW YORK.



# ANNOUNCEMENT



**FALL, 1893.**

Our Importations for the coming season are now arriving and we have on exhibition at our ware-rooms a complete assortment of exclusive

## Novelties and Specialties

SELECTED FOR THE JEWELRY TRADE.

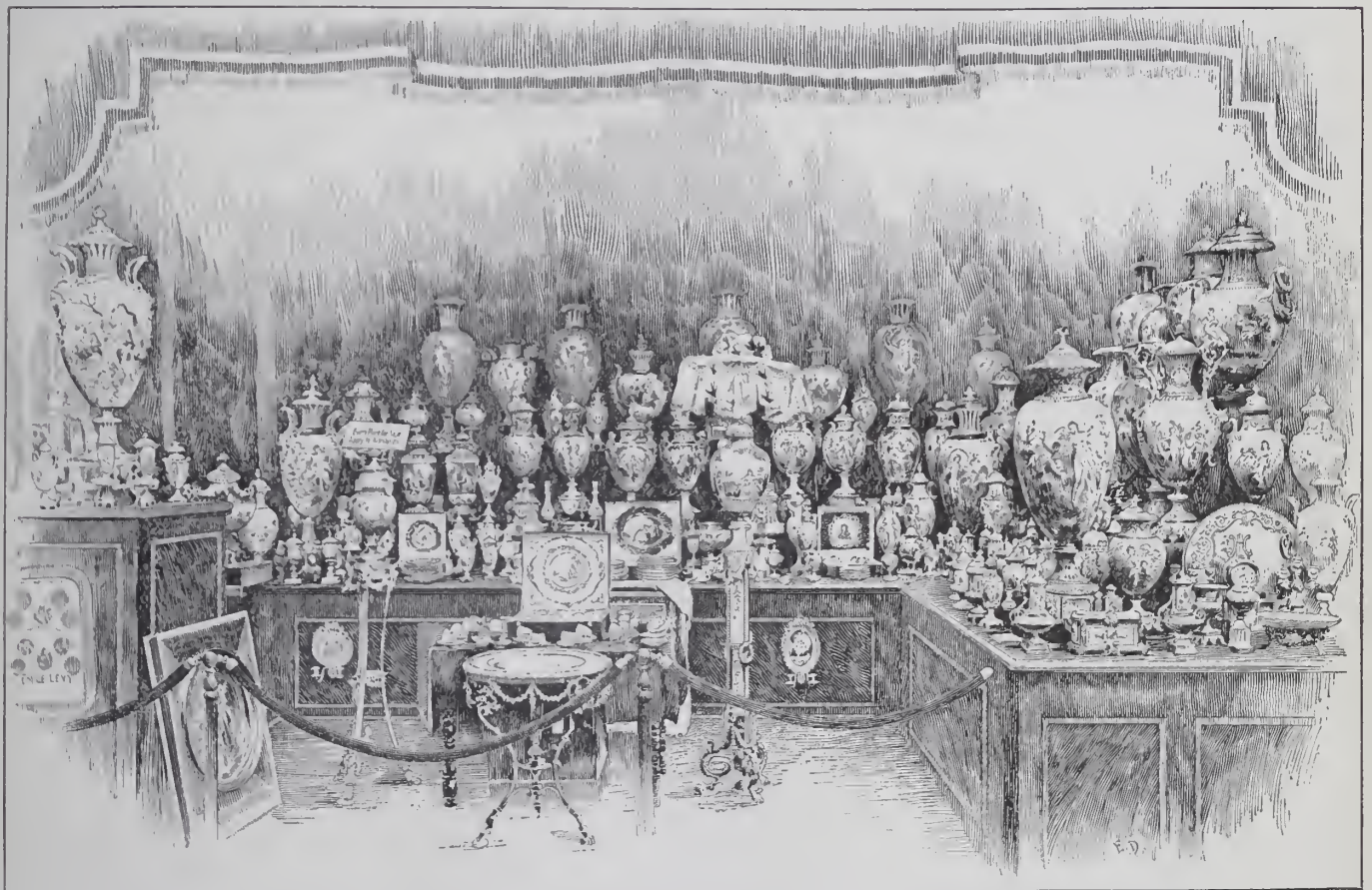

PAVILION CONTAINING THE KERAMIC EXHIBIT OF LEON J. GLAENZER & CO., AT THE WORLD'S FAIR.

Clocks, Bronzes, Sevres Vases, Fine Decorated Porcelains, Cups and Saucers, Tea Sets, Lamps and gilt and silver plated filigree Photo Frames in endless variety.

# LEON. J. GLAENZER & CO.,

35 Boulevard de Strasburg, Paris,

80 & 82 CHAMBERS ST., N. Y.

most pleasing results, and is indeed seen to greater advantage on them than on smaller pieces. The colors and shadings are much darker than those we have been accustomed to, and where painted floral subjects and views are introduced in panels the darker character of the ornamentation by which they are surrounded has a warm and pleasing effect.

In all the articles named there are several new shapes, and with decorations in quite new outlines the results are highly satisfactory. The variety of umbrella stands includes several departures from conventional lines, one of the most noticeable being a stand with the top edge turned inwards, instead of outwards as usual. Some shell and shell shaped vases are nicely modeled. They possess one useful feature that has hitherto been absent from shell vases—they are made to take a flower pot. As these shell vases are made in all sizes, they are adapted for any size pots. Some tall grass vases are finely modeled and beautifully painted. The dark decorations to which we have referred are shown in seven or eight colors, and on several shapes of pedestals and vases. In some of the art shapes shown these goods make very appropriate additions to the furniture of a room. A pair, properly filled with ferns or flowers, would be found sufficient decoration for any window recess. In addition to good art shapes, pleasingly decorated, they are giving a very good body in their ware.

### The Other Side of Life.

#### ONE WAY.

"This beautiful teapot was made from silver dollars contributed by the bride's classmates."

"Well! That's one way to made a pot of money, isn't it?"—*Indianapolis Journal*.

#### ALWAYS VALUABLE.

"You can talk as much as you please against silver coin," he said in an oracular tone, "but it'll always be good for something."

"What makes you think so?"

"I was out fishin' the other day and forgot some of my tackle. I don't know what I'd a done if I hadn't thought to tie a silver dollar to my line. It makes a first-rate sinker."—*Washington Star*.

DEALER—This ring for three dollars is plated, but it is warranted for five years.

FOXY SUMMERS (off on his outing)—Hav'n't got one, have you, for fifty cents, warranted for, say, three weeks?—*Puck*.

WATCHMAKER—My friend, I suspect you've been putting kerosene oil in this watch.

GEORGE BOND—That I have. When a watch goes in soak so often something must

be done to counteract rust.—*Kate Field's Washington*.

#### THANKS TO THE OYSTER.

She—O, Tom, here's a pearl in this oyster!

He (excitedly)—Grace, may—may I have it set in an engagement ring?

—*Judge*.



#### HERESY IN COLORADO.

DEACON DEADSHOT, ELDER BOWIE AND BROTHER BLUDSOE.—We've come to tell ye, Parson, that we don't like yer doctrine. Ye've got to quit chinnin' 'bout heaven bein' built o' gold an' paved with gold, an' 'bout golden rules an' golden stairs. Them things is silver out in this claim! Ye'll hev to shet that gold-bug yawp an' come down to Orthodoxy. You hear us! —*Puck*.

**WE** beg to notify our friends that our stock is now complete with all the latest productions. You will find goods especially adapted to the Jewellery Trade, such as

**Royal Worcester,**

**Sevres,**

**Doulton,**

**Crown Derby,**

**Crown Vienna,**

**Royal Bonn,**

**M. Redon,**

**Carlsbad,**

**AND OTHER CHOICE AND DESIRABLE LINES.**

Give us an early call as it will be to your interest to do so.

**CHARLES AHRENFELDT & SON,**

50, 52 and 54 Murray St.,

New York.

PARIS,

LIMOGES,

DRESDEN,

CARLSBAD.

# FRENCH CHINA SPECIALTIES FOR JEWELERS.

BRUSH & COMB TRAYS,  
CARD TRAYS,  
MANICURE TRAYS,  
PEN TRAYS,

PHOTOGRAPH FRAMES,  
FRUIT PLATES,  
ODD CUPS AND  
SAUCERS, ETC.

◁ SEND \* ORDER \* FOR \* SAMPLE \* ASSORTMENT. ▷

## F. W. BUNING & CO.,

58 MURRAY STREET,

NEW YORK.

ESTABLISHED 1801.



# HINRICHS & CO.,

29 & 31 PARK PLACE,  
Cor. Church Street, NEW YORK.

## Art Pottery and Bric-a-Brac, CUT GLASS, FANCY GLASS, CHINA, LAMPS.

THE LARGEST ASSORTMENT OF SPECIALTIES FOR THE JEWELRY TRADE, AT LOWEST PRICES.

SOMETHING ABSOLUTELY NEW IN CERAMICS, FURNACE FIRE COLORS.



THE EXHIBIT of THE at WORLD'S FAIR, Chicago.

### CH. FIELD HAVILAND LIMOGES CHINA.

FABRIQUE FONDEE EN 1797.

### E. GERARD, DUFRAISSEIX & CIE.,

SUCESSEURS:

WHITE WARE.  
CFH  
GDM  
FRANCE  
TRADE MARK.



## HAVILAND & ABBOT,

AGENTS FOR THE U. S.,  
29 BARCLAY STREET, NEW YORK.

## THE BEST PIVOT DRILLS IN THE WORLD.

One Gross without charge for proof  
that this is not so.

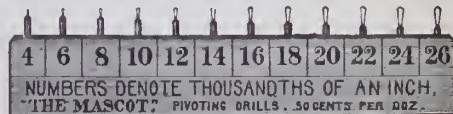

### The Mascot, 50 Cents per doz.

By all Jobbers, or sent post-paid  
on receipt of price.

### Ezra F. Bowman & Co., LANCASTER, PA.

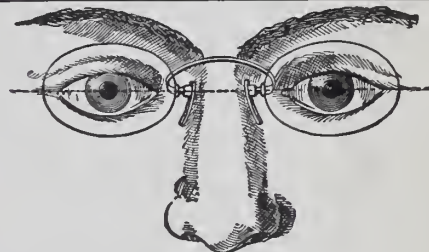
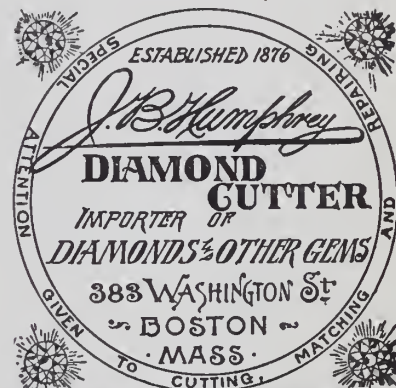

Patented Feb. 9, 1892.

### THE W. B. & E.

Marvel Tilting Spring Eyeglass in Gold,  
Steel, and Frameless.

### JULES LAURENCOT & CO., 49 MAIDEN LANE, NEW YORK.

Sole Agents in the United States and Canada.

PEARLS.  
RUD. C. HAHN,  
194 BROADWAY, NEW YORK.  
GARNETS.

**FALKENAU, OPPENHEIMER & Co.**  **DIAMONDS**  
40 MAIDEN LANE NEW YORK

87 NASSAU ST.,  
(Fulton Building), NEW YORK.

WOLFF & GUNZBURGER, Importers of DIAMONDS,

L. & M. KAHN & CO., Importers of DIAMONDS, Cor. Maiden Lane, NEW YORK.

**B. & W. B. SMITH,**  
220 WEST 29TH ST., NEW YORK CITY.

AT THE  
**WORLD'S FAIR, CHICAGO,**  
OUR EXHIBIT IS IN THE  
Manufactures and Liberal Arts Building, Section A, Block One.  
CALL AND SEE US AT OUR OFFICE IN NEW YORK.

**PORCELAIN, ONYX, GILT AND ENAMEL CLOCKS.**

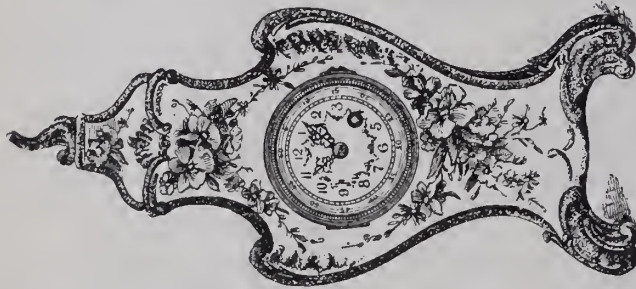

POPULAR GOODS AT POPULAR PRICES.  
SPECIAL DESIGNS CONTROLLED BY US IN  
**ART POTTERY.**  
Fancy Glassware, Vienna Vases, Tete-a-Tete Sets,  
**MARBLE STATUARY**  
in Carrara and Castellana, Etc., Etc.

LEVY, DREYFUS & CO.. 9 and 11 Maiden Lane, N. Y.

**WHY**

S. F. MYERS & CO.  
sell more goods than any  
other Wholesale Jewelry  
House.

**BECAUSE**

They are the only firm in the Metropolis who carry  
in stock a full line of everything a jeweler requires.  
They give the utmost values and endeavor to  
please their trade in every respect. Refer to their  
various publications and illustrated catalogues.  
**MYERS BUILDINGS, 48 & 50 Maiden Lane, NEW YORK.**

**LATEST AND BEST  
ELK'S TOOTH BADGE.**



CAN BE USED AS A  
CHARM BY  
SIMPLY DETACHING  
BAR FROM TOOTH.

Reverse shows the sym-  
bolic flower of the Ben-  
evolent and Protective  
Order of Elks, the forget-  
me-not, beautifully ename-  
led in colors; also the  
letters B. P. O. E.

MANUFACTURED BY  
**G. A. SCHLECHTER,**  
READING, PA.

**S. P. HOWARD,**  
Gold and Silver Assayer.  
**Refiner and Sweep Smelter,**  
33 MAIDEN LANE, NEW YORK.  
Smelting and Refining Works,  
28 & 30 Cumberland Street, Brooklyn, N. Y.  
Specialties: Sweepings, Gold, Silver and Platinum



**Chas. Jacques Clock Co.,**

22 CORTLANDT STREET, - NEW YORK.

Importers and Manufacturers

**SWISS REGULATORS, ELLIOTT'S CHIMING  
CLOCKS, FRENCH AND ENGLISH MOVE-  
MENTS, HALL CLOCKS, TRAVELING  
CLOCKS, GILT REGULATORS,  
FAIENCE & GILT CLOCKS & SETS, ETC.**

Complete line of English and French  
Clock Materials.

Pinions and Wheels Cut on Premises.



**M. H. KLING, \* IMPORTER OF \***  
**DIAMONDS,**

11 JOHN STREET, - NEW YORK.

**IT PAYS** TO KEEP IN TOUCH WITH TRADE AFFAIRS.  
THE JEWELERS CIRCULAR, For 4c. a Week will do it. **Subscribe.**

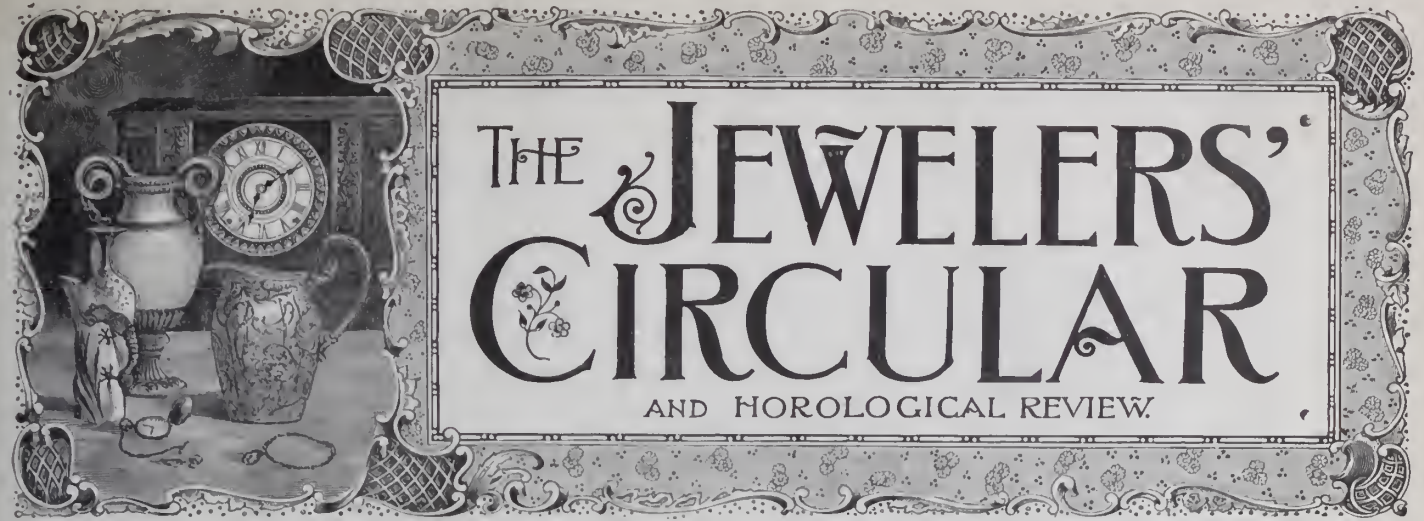

# THE JEWELERS' CIRCULAR

AND HOROLOGICAL REVIEW

Copyright, by THE JEWELERS' CIRCULAR PUB. CO.

189 Broadway, New York.

Entered at the Post Office in N. Y. as second-class matter.

VOL. XXVII.

NEW YORK, WEDNESDAY, SEPTEMBER 20, 1893.

NO. 8

## GRECIAN ART IN SILVERSMITHING.

THE approaching contest for the America cup, the late races for the Brenton Reef cup and the Cape May cup, not to speak of the lesser races recently held in England, and the great preliminary races in which the *Vigilant* so gallantly won the title of cup defender, make the subject of yachting trophies not only timely, but of particular interest to every one. Especially true is this in relation to the beautiful Larchmont cup here depicted, which was made to be competed for by all the first-class American sloops, it being the donor's intention that the *Vigilant*, *Colonia*, *Jubilee* and *Pilgrim* be among the contestants.

This beautiful companion piece to the bowl illustrated on this page last week, is not only a departure from the usual style of yacht prizes, but like each of its predecessors turned out by the Whiting Mfg. Co., is seemingly superior to all that have gone before. Even a photograph can give no adequate idea of the wonderful workmanship which the piece shows, exemplifying as it does all the processes used in the artistic decoration of silverware. But enough can be seen to convey a fair comprehension of the delicate grace and beauty of the outlines and the appropriateness of the ornamentation throughout the whole piece.

The pitcher stands 26 inches high, exclusive of the ebony base on which it rests. The general form is Greek though the curves are of the Louis XV. style. Upon the obverse side standing upon a primitive sailboat, is represented the hero of the Odyssey, Ulysses, the first sailor of history. After leaving the island of Cgygia, the abode of the nymph Calypso, with whom he dwelt eight years, Homer tells how Poseidon persecuted Ulysses with a storm, and finally cast him in a forlorn condition upon the island of Scheria. This is probably the adventure illustrated, as underneath is the quotation from the epic: "What raging winds, what roaring waters sound." The figure, which is in bas-relief, is a magnificent specimen of the applied work which predominates in the decoration

of the piece. From this the surrounding work gradually merges into repoussé chasing

running thence into etching and to the plain silver. It is by reason of its displaying these various styles of decoration that the cup should be carefully examined to be fully appreciated. Taking the oar as an example, we see that the portion from the right hand to the shoulder of the figure is applied, from the thigh to the left hand is chased, while beyond that is etched; but so gradual are the changes that the different processes are to be detected only by the closest observation.

The graceful neck, which shows the bright finish, is fluted, and is separated from the body by a narrow but beautiful border. Around the bottom an entirely new movement is shown in an artistic scroll of applied work, whose every curve suggests water in motion, between which is a series of network appropriately resembling ropes and rigging. On the reverse side of the bowl is etched the inscription, together with the seal of the Larchmont Yacht Club. But among other details, it is in the handle and in its manner of being joined to the pitcher that the superior work of the Whiting Mfg. Co. discloses itself. These have always been a principal feature in the many beautiful prize cups for which this company are famed, but in this pitcher particularly the work has reached apparent perfection. The handle which is suggestive of a dolphin, widens and thickens as it approaches the extremities until at the bottom it becomes three times as broad as at the center and it combines with the body of the pitcher and the decorations upon the neck and stem as though the whole cup was a continuous piece of silver.



THE LARCHMONT CUP FOR SLOOPS, 1893.  
MADE BY THE WHITING MFG. CO.

The finest as distinguished from the biggest diamond that has ever yet been found in South Africa is the "Porter-Rhodes," which was picked up some years ago in a claim of the Kimberley Mine. It was a blue-white gem of 150 karats and of literally dazzling lustre. The owner of the claim was Mr. Porter but Mr. Rhodes; acquired an interest in the valuable find.

# These Leathers are made up in the Following Articles :

Card Cases,  
Pocket  
Books,  
Photo.  
Frames,  
Calendars,  
Folios,  
Purses,  
Combination  
Books,

Desk Pads,  
Cigar Cases,  
Prayer  
Books and  
Hymnals,  
Stamp Cases,  
Watch Card  
Cases,  
Marriage  
Registers,

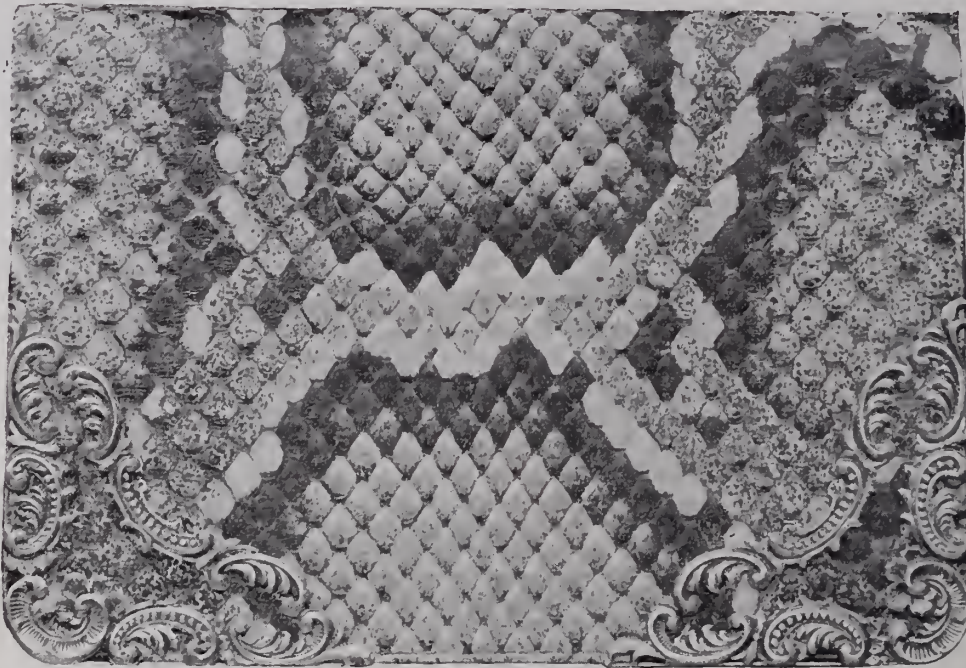

NATURAL SNAKE CARD CASE—STERLING CORNERS—"ROCOCCO."

Spectacle  
Cases,  
Memo.  
Books,  
Check  
Blotters,  
Address  
Books,  
Visiting  
Books,  
Bill Folds,  
Cigarette  
Cases,  
Engagement  
Pads,  
Eye Glass  
Cases,  
Finger  
Prayer  
Books,  
Telegraph  
Pads,  
Chatelaine  
Bags,  
Pen Wipers.

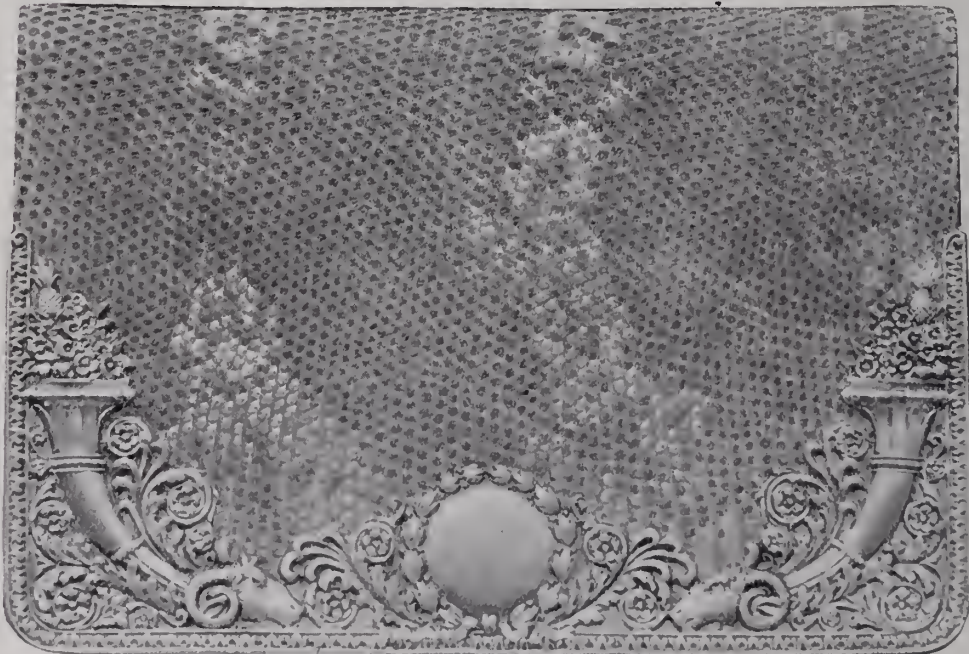

NATURAL LIZARD COMBINATION—STERLING FRONT—"EMPIRE."

**DEITSCH BROS.,** ♦ ♦ ♦ MAKERS, ♦ ♦ ♦  
7 East 17th St., New York.

ORIGINATORS OF NOVELTIES IN LEATHER AND STERLING SILVER COMBINATIONS.

**"EBONY."**

# Craighead & Wilcox,

NO. 33 BARCLAY STREET, }  
 NO. 38 PARK PLACE, }

NEW YORK CITY.



## REPRESENTING

CRAIGHEAD & KINTZ CO., Makers of Lamps and Metal Fancy Goods.

WALTER S. BERG, Maker of Silk Lamp Shades.

HARTFORD SILVER CO., Makers of Silver Plated Goods.

ALFRED HACHE & CO., Successors to HACHE, JULLIEN & CO.,

Vierzon, France, Makers of French China.

---

THE COMPLETE NEW LINES ARE NOW ON EXHIBITION AT OUR SALESROOM.

“DO YOU KNOW?”

THAT GOODS FREE FROM SOLDER ARE THE BEST?

THAT GOODS MADE FROM SEAMLESS WIRE ARE SUPERIOR IN FINISH ON THIS ACCOUNT?

THAT SEAMLESS WIRE MAKES THE BEST FILLED CHAINS?

THAT WE ARE THE MAKERS OF THE ORIGINAL AND CELEBRATED:

SEAMLESS GOLD FILLED CHAINS?



Do not fail to visit our beautiful and artistic display at the World's Fair. The finest of its kind at the Exposition.



Northeast Corner of Manufactures Building, Department O.  
Right on the corner. See Official Catalogue.



**Kent & Stanley Co.,**

BRANCH OFFICES:

NEW YORK : 17 MAIDEN LANE.      SAN FRANCISCO : PHELAN BUILDING.  
BOSTON, 58 WINTER STREET,      MONTREAL, TEMPLE BUILDING.

MAIN OFFICE AND WORKS:

**PROVIDENCE, R. I.**

**AIKIN, LAMBERT & CO.**

19 Maiden Lane, NEW YORK.

Branch, 42 & 44 East Madison St, CHICAGO, ILL.

Manufacturers and Exporters of

Gold Pens, Holders, Picks, Pencils,  
Fountain Pens, etc.

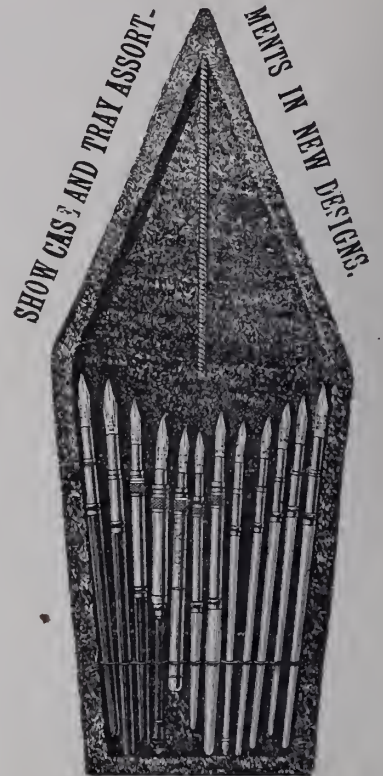

11 x 5 1/2 inches.

PLUSH TRAY WITH EASEL BACK.

1 Doz. 16 K. Pens and Assorted Holders, List, \$90  
1 Doz. 10 K. Pens and Assorted Holders, List, \$24

Send for Trade Discount.

**OPTICIANS' SUPPLIES**  
Jobbing and Prescription Work.

The "Graduate" Trial Cases, 180 1/2 set, \$30.00; 220 lens set, \$37.50. The "Standard" Trial Cases, 220 lens set, \$65.00. All with lenses. Loring Ophthalmoscope, \$9.00. Artificial Eyes, for selection, \$1.00 each, \$50.00 per hundred. Ophthalmometer, \$30.00 to \$70.00. Queen's Standard Perimeter, \$18.50. Queen's Lens Grinding Outfit, \$3.00. Steel Frames, 15 to 30 cents each. Spherical Lenses, 25 cents per pair. Cylinders, 33 cents per pair. Lenticular Bifocals, 8 cents per pair, (all best). Nose pieces, German or Shell. German Silver, \$1.00 per dozen pairs. Gold, \$2.00 per dozen pairs.

**QUEEN & CO.** Opticians and  
Catalogue free. 1010 Chestnut St., Phila., Pa.



AMERICAN RAILWAY SUPPLY CO.  
24 Park Place, NEW YORK.

For **BADGES AND MEDALS.**

Flag Pins, Class Pins, Class Rings  
and Special Work of all Descriptions,  
SEND TO **E. R. STOCKWELL**, MANUF'R.  
19 John Street, New York.



The  
 "Pairpoint" MFG. COMPANY  
 .... New Bedford, Mass.

SUPERIOR SILVER PLATE.



No. 5402, Ink.

**Do Not Fail** to see our  
 Exhibit at Columbian Exposition,  
 Section N, Manufactures Building,  
 and our Store, 224 Wabash  
 Avenue, Chicago.



No. 4903, Smoking Set.

SALESROOMS:

NEW YORK,  
 20 Maiden Lane.

CHICAGO,  
 224 Wabash Ave.

SAN FRANCISCO,  
 220 Sutter Street.



61 Hanover Street, Boston, Mass.

Sales made for Jewelers only in their  
 established places of business. Can give  
 best references of any auctioneers in  
 America.

*All communications strictly  
 confidential.*

**Brunor Plating and Jewelry Rep. Co.**

Jewelry Matched and Repaired, Engraving,  
 Chasing and Enameling, Setting, Polishing and  
 Lapping, Battery Gilding and Roman Coloring,  
 Watch Cases Repaired, Polished and Gilded.

132 Maiden Lane, New York.

We sell to the legitimate Jewelry and Stationery  
 trade only.



CHOICE PAPERS

MAKERS OF

FINE STATIONERY

For Correspondence, Wedding and Business Use, handsomely  
 boxed, specially suited to the Jewelry Trade.

18 MURRAY STREET, NEW YORK.

# WORLD'S FAIR SOUVENIRS.

\* STERLING SILVER. \*



THE COLUMBUS.



REVERSE SIDE OF HANDLE.



REVERSE SIDE OF HANDLE.



THE DISCOVERER.



REVERSE SIDE OF HANDLE.



THE AMERICAN.

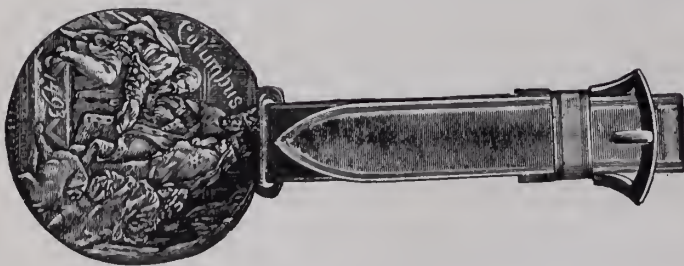

No. 2. BAGGAGE CHECK.



MATCH BOX.

## R. WALLACE & SONS MFG. CO.,

SILVERSMITHS,

WALLINGFORD, CONN.

NEW YORK:  
3 PARK PLACE.

CHICAGO:  
86 WABASH AVENUE.

**Details of the Failure of Andrew E. Warner.**

BALTIMORE, Md., Sept. 14.—Andrew E. Warner, one of the oldest and best known jewelers and silverware dealers in this city, whose failure was recorded in last week's CIRCULAR, made a deed of trust for the benefit of creditors to James E. Carr, Jr., trustee. Mr. Carr says that it is impossible to estimate the liabilities as yet, though they will probably not exceed the assets, which, according to the bond filed, will be about \$7,500.

The trustee says that the failure was occasioned by the inability to collect outstanding indebtedness, the stringency of the money market, depression in business, and the fact that people are not buying jewelry at a time when money is so tight.

The assignor is an old man, nearly eighty years of age, and well known in the city. In 1811 his father, Andrew E. Warner, Sr., started the business in this city, and is said to have been the pioneer of the jewelry trade in Baltimore. Mr. Warner made an assignment in 1886, but paid all his indebtedness, with interest, in a year.

**One Burglar Less Now at Large.**

ROCHESTER, N. Y., Sept. 15.—Matthew Hollenbeck, indicted for burglary in the third degree, and grand larceny in the second degree, in breaking into Austin & Prescott's jewelry store, Batavia, in December, 1891, was arraigned in the Court of Sessions this week and pleaded guilty. He asked to be sentenced to Erie County Penitentiary, but instead Judge North sentenced him to five years at Auburn Prison. Hollenbeck said that he was thirty-six years of age and a native of Syracuse.

**Injunction Issued Against the World's Fair Authorities.**

CHICAGO, Ill., Sept. 14.—Franz Borkert of Schegel, Germany, and Philip Huoy, who have exhibits of set jewelry on the World's Fair grounds this week filed bills in the Superior Court asking for an injunction to restrain the World's Columbian Exposition authorities from closing up their exhibits.

The complainants assert that they have brought their goods to the Exposition, paid \$3,000 duties, and made arrangements with the German Commissioner for space in the German section of the Mining building. Recently Dr. M. Richter came into charge of the German affairs, and ordered Borkert & Houy to close up their exhibit. Master-in-Chancery Barber recommended that an injunction should issue.

**HENRY FERA,**  
**IMPORTER OF DIAMONDS**  
 AND DIAMOND BORTZ.  
 Diamond Cutting and Polishing Establishment.  
 10 Maiden Lane, NEW YORK.

**BIPPART & CO.**  
 MANUFACTURERS OF  
**DIAMOND JEWELRY**  
 NEWARK · N · J ·

BROOCHES.	LINK BUTTONS,
SCARF PINS.	CUFF PINS.
HAT PINS.	BRACELETS,
HAIR PINS.	NECKLACES,
EARRINGS.	RINGS.

NEW YORK OFFICE 19 MAIDEN LANE ·

**THE BOWDEN SEAMLESS RING**

IS MADE ONLY BY

**J. B. BOWDEN & Co.,**  
 Makers of Finger Rings of every Description  
 COR. BROADWAY & JOHN STREET,  
 NEW YORK.

**J. B. & S. M. KNOWLES CO.,**

MAKERS OF

Sterling



Silverware.

FACTORY,  
 Providence, R. I.

SALESROOM,  
 860 Broadway, N. Y.

**O. W. BULLOCK & CO.,**  
 SPRINGFIELD, MASS.  
 Makers of Watch and Jewelry Tools,  
 NEW CATALOGUE NOW READY.  
 Sent on Application. Please Mention this Paper.

**JACOT & SON**  
 IMPORTERS AND MANUFACTURERS OF  
**MUSICAL BOXES**  
 298 BROADWAY.  
 NEW YORK



# ARTISTIC METAL GOODS.

NEW DESIGNS,  
NEW FINISHES.

Our line of Pitchers, Vases, Tables, Candlesticks, Five O'Clock Teas, Etc., cannot be equaled.

## THE CELEBRATED "B & H" LAMP.



BEAUTIFUL DESIGNS,  
particularly adapted to the Jewelry Trade.  
SEE OUR LINE OF  
TABLE, BANQUET AND PIANO LAMPS  
before placing your orders. Send for our Little Book.

**BRADLEY & HUBBARD MFG. CO.**  
NEW YORK, BOSTON, CHICAGO,  
21 BARCLAY ST., 160 CONGRESS ST. 88 WABASH AVE.  
26 PARK PLACE Factories, MERIDEN, CT.

# THE BEST BUTTON MADE.

IN GOLD FROM **KREMENTZ & CO.** ONE PIECE FROM **KREMENTZ & CO.** IN ROLLED PLATE ALL JOBBERS.

**COLLAR BUTTON.**  
IS THE ORIGINAL ONE PIECE BUTTON.  
IS STILL THE BEST AND STILL UNSURPASSED.

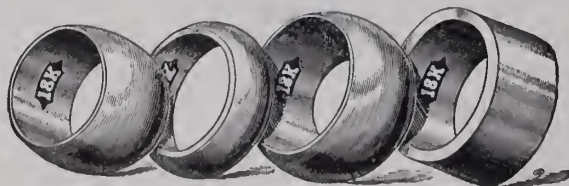

**PLAIN SOLID GOLD RINGS.**  
**HILDRETH MFG. CO.,**  
53 MAIDEN LANE, NEW YORK.

### Meriden's Industries Enter upon a Promising Boom.

MERIDEN, Conn., Sept. 12.—The manufacturing industries of Meriden are booming. The first pleasant news was that the Meriden Britannia Co's. factory, which has been running but three days a week (thirty hours) would run four days (forty hours) this week with the outlook favorable for a resumption of full time in the near future.

The Wilcox Silver Plate Co. ran three days (twenty-four hours) last week. This week they will run four days, or thirty-two hours.

The Meriden Silver Plate Co. have been running three days a week, and it is probable they will run four days, or forty hours this week.

The J. D. Bergen Co's. factory has commenced running three days a week, on a ten hour basis.

C. Rogers & Bros. are running five full days a week, and expect soon to make six.

The E. A. Bliss Co. have been doing very little for weeks past; this week they will resume work on full time.

E. Miller & Co. were running on half time until last week, when they ran four and one-half days. This week they will run five days.

The Bradley & Hubbard Mfg. Co. have been running about one-half time, and Superintendent Lindsley says they will increase their time as business demands.

The Charles Parker Co., who have been doing very little, will run half time.

The Meriden Bronze Co., who had been running three days a week, now run five days, and will soon run six.

### Diamond Prospecting on Busy Broadway.

Thursday afternoon a diamond ring dropped down into Broadway from a window of the office of T. B. Bynner, jeweler, on the third floor of 177 Broadway, New York, where a clerk was examining it.

The clerk immediately ran down stairs followed by other clerks, and a search was commenced. Pedestrians stopped to see what was the matter, and many of them helped in the search. Every nook and crevice was examined, but without success. The ring was valued at \$150.

### The Town of Mystic, Conn., Wants a Watch Manufactory.

NEW LONDON, Conn., Sept. 15.—The residents of Mystic are negotiating for a watch manufacturing concern to locate in that village. It is said that the industry will furnish employment for two hundred men.

A committee of four, J. K. Bucklyn, Geo. E. Tripp, T. E. Packer and E. B. Noyes, will do all in their power to secure the location of the proposed manufacturing plant.

# RICE & HOCHSTER'S,

Nos. 483 & 485 BROADWAY,  
NEW YORK.

ARTISTIC DISPLAY OF TORTOISE SHELL WORK AT THE WORLD'S FAIR.

THE perfection reached by workers in tortoise shell will be amply exemplified at the World's Columbian Exposition by the display of Rice & Hochster, New York. The exhibit is in the Manufactures building, Gallery F and Pillar No. 83. The articles are displayed within a case, upon a pyramid. Surmounting this pyramid are shown the marvelous ornamental work in tortoise shell illustrated on this page, and represents an arch, upon which are groups of figures typifying agriculture, commerce, machinery, electricity, the press, iron work, chemistry, sculpture, painting

motto *palmam qui meruit ferat* (let him bear the palm who merits it).

The workmanship is as fine and perfect as

ing. In the working of the shell, the amber colored portions have been made to represent the flesh, while the brown parts, the draperies.

The exhibit contains two figures of Washington and Columbus, made of solid shell. On one panel of the pyramid are cut in relief cameos of the twenty-three presidents of the United States. Prominent also are three large combs, one foot square, representing the landing of Columbus, the four Seasons and the five Continents. A great many styles of hair ornaments and lorgnettes made from select shell are in the exhibit. Five

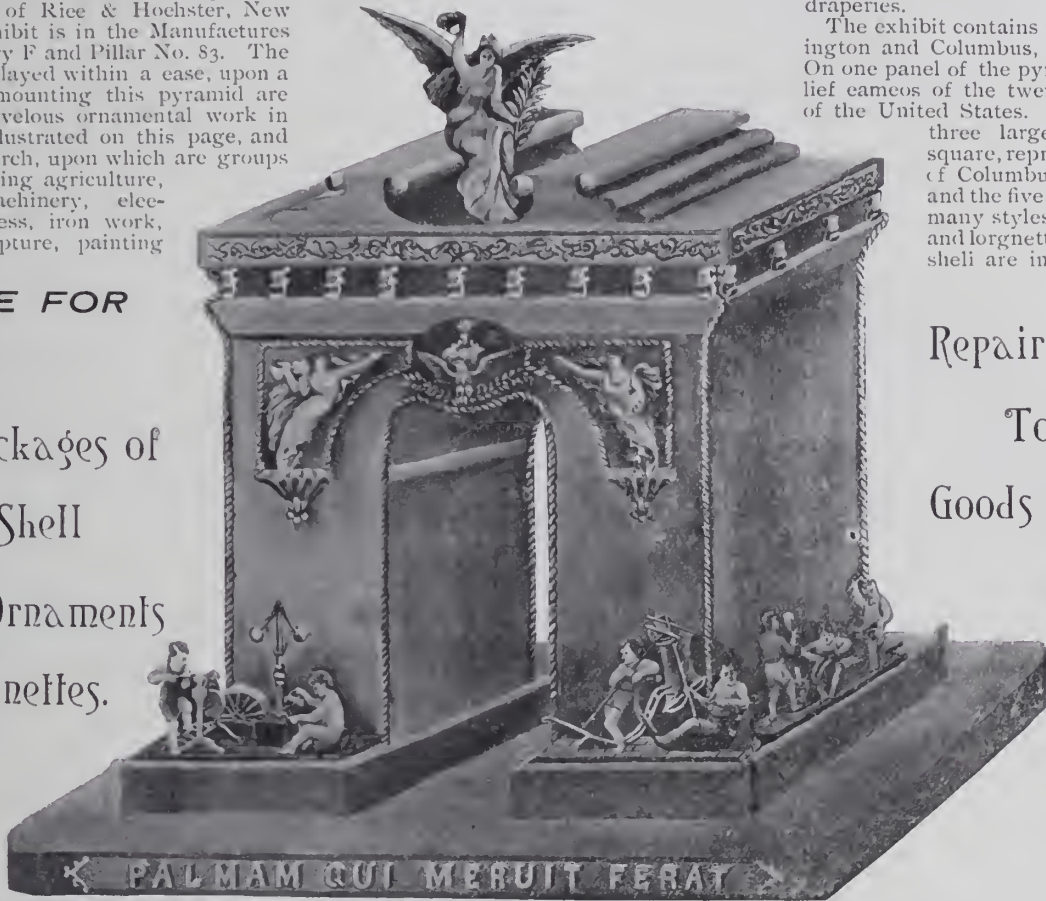

**WRITE FOR**  
Selection  
Packages of  
Tortoise Shell  
Hair Ornaments  
and Lorgnettes.

Repairing of  
Tortoise Shell  
Goods Equal  
to New.

ORNAMENTAL PIECE IN TORTOISE SHELL, EMBLEMATIC OF THE TRIUMPH OF INVENTION AND ART.

and other arts. The angel which surmounts the piece is a faithful miniature of the figure which tops one of the buildings of the World's Fair. In relief, on the base, is the

conception of the piece is artistic. In the manipulation of the miniature figures the ingenuity of the artisans has been taxed to its utmost and has not been found want-

stuffed tortoises surmount the case which is of white and gold; the letters of the name of the firm are in tortoise shell. *From THE JEWELERS' CIRCULAR, May 3d, '93.*

## "Old English"

Coffee Spoon.

\*\*\*



Towle Mfg. Co.,  
MANUFACTURERS OF  
**STERLING SILVERWARE.**  
NEWBURYPORT: No. 214 Merrimack St. CHICAGO: Nos. 149 & 151 State St.

**WM. BIRMINGHAM & CO.,**  
MANUFACTURERS OF  
All Kinds of Leather Spectacle and Eye Glass  
**CASES,**  
728 Arch Street. PHILADELPHIA, PA.



## BIG RETURNS MADE FOR OLD GOLD AND SILVER.

Check Forwarded 24 Hours After Receipt of Consignment.

**RATHBONE & SMITH,**  
GOLD AND SILVER REFINERS, ASSAYERS AND SWEEPSMEITERS.  
Nos. 1 to 9 Matthewson St., Cor. Cove, Providence, R. I.

**Enterprising Jewelers Catch On!**



OBVERSE



REVERSE



BACK

**Jewish Shekel, Masonic Mark or Pocket Piece.**

THE LATEST AND BEST SELLING NOVELTY.

The mark is struck in coin silver, by using either the obverse or reverse of the coin, the back being the same in either case, and permitting of the purchaser's name, blue lodge, chapter and individual mark, with date of same being engraved thereon, as shown in cut above.

Price, without engraving, ONE DOLLAR. Engraved Mark, Dates, etc., 75c. EXTRA.

Liberal Discount to the Trade.

**CHAS. G. WILLSON, MANUFACTURING JEWELER, READING PA.**

**Jules Jürgensen**

OF COPENHAGEN

The reputation these watches have maintained for Fifty Years has never been equalled, being made on strictly scientific principles and no expense spared to give the Best results in mechanism and timekeeping qualities.

SOLE AGENTS.

**John C. Hyde's Sons,**  
NO. 22 MAIDEN LANE.

**A. J. LOGAN,**

MANUFACTURER OF  
WATCH TOOLS, HAIR SPRINGS AND  
**WATCH MATERIALS.**

◁ New Catalogue just issued, Sent on Application. ▷  
**WALTHAM, MASS.**

**VICTOR. ⊗ ⊗**

SIMPLEST FEED. ALWAYS THE SAME.  
GUARANTEED FOR ONE YEAR.

**THE VICTOR  
FOUNTAIN PEN**

(Pat. Feb. 4, 1890.)

**THE BOSTON PEN CO.,**

N. C. Whitaker & Co., Proprietors.

363 Washington Street, - Boston, Mass.,

Manufacturers of finest quality

TORTOISE : SHELL : AND : HORN : GOODS  
in every variety. Also Aluminum Hair Pins.

Send for illustrated Pen Price List No. 1.

**HENRY GOLL & CO.,**

17 JOHN ST., NEW YORK.



SPECIAL CASES  
MADE TO  
ORDER  
AND  
REPAIRING IN  
ALL ITS  
BRANCHES.

ESTABLISHED 1837.

**GEO. O. STREET & SONS,**

MAKERS OF

Fine Rings, Locketts, Seals,

Sleeve Buttons and Links,

15 John Street, NEW YORK.

**CLEAN JEWELRY SELLS QUICK.**

Quarters' Cleaning Solution removes dirt and tarnish in an instant, makes stock like new and brings up diamond and stone work to a beautiful lustre. Solution can be used over and over. Highly commended by all who use it. Send at once \$1.50 for half gallon with full directions. References.

**W. F. QUARTERS ELECTROPLATER,**  
139 EDDY STREET. PROVIDENCE, R.

**"TIME IS MONEY"**

SEND YOUR PRESCRIPTIONS  
AND REPAIR WORK WHERE  
IT IS DONE ACCURATELY WITH-  
OUT DELAY.

**E. KIRSTEIN'S SONS CO.**  
SEND FOR CATALOGUE. ROCHESTER, N.Y.

Lenticular Bifocals Set in Frames, 55c. per pair.



**The Warren  
Eye Protector**

(Patented Jan. 12, 1892, Feb. 21, 1893.,

Saves the Eyes From

**Dust, Wind, or Glaring Light.**

Folds in a Compact Case, is

Comfortable, Durable,  
Water and Dust Proof.

Its large field does not obstruct the sight. No brittle substance to endanger face under sudden blows.

Oculists and Physicians Recommend it.

Travelers, Cyclists, Railroadmen,  
Horsemen, Motormen, Quarrymen,  
Pronounce it Indispensable for Man or Woman.

Ask your Dealer for it.

Colors, Clear, Smoke, Blue or Green. Black frames, 50c. Silver, 75c. Sent by mail on receipt of price. Manufactured solely by

**The Nous Verrons Company**

P. O. Box 3273, Boston, Mass.

**C. SYDNEY SMITH,**

HAS REMOVED TO

191 BROADWAY,

New York.

FACTORY:  
PROVIDENCE, R. I.

Manufacturer of

**GOLD CHAINS,  
LOCKETS AND CHARMS.**

**Aikin Lambert Jewelry Co.**

Importers of  
**Diamonds,**  
Jobbers in **WATCHES,**  
Jewelry, Chains etc.

19 Maiden Lane.  
*New York,*

SAM'L B. MANN. Treas.  
FRED D. ILGEN, Sec'y

JAMES C. AIKIN, Pres.  
JOHN B. SHEA, V.-Pres.

**S. Lyons & Son Want to Settle at 100 Per Cent.**

In response to the call of the assignee, about twenty creditors of S. Lyons & Son, New York, met in the office of Jos. Frankel's Sons, 1 Maiden Lane, Wednesday afternoon. The assignee presented a statement of the assets and liabilities of the embarrassed firm which showed the assets to consist of stock on hand, nominal value \$45,000, actual value estimated at \$30,522.08; real estate and stocks amounting to between \$5,000 and \$6,000; and outstanding accounts and bills receivable amounting to \$6,809, making a total of actual accounts about \$41,060. The total liabilities amounted to \$24,034.36, of which \$12,164.28 was for merchandise, while \$6,009.32 constituted contingent liabilities on trade paper indorsed by the firm.

Mr. Lyons made an offer to pay 100 per cent. on all claims in equal instalments in six, nine, twelve, fifteen and eighteen months. Those present representing \$19,589 of the liabilities unanimously signified their willingness to accept this offer. It was afterward agreed that the smaller creditors, those having claims under \$100, should be paid in less time.

Leon Lewin, the attorney for the assignee, told a CIRCULAR reporter that there was no doubt of Mr. Lyon's ability to pay all his creditors in full, if he was given the extension asked. Mr. Lewin said that the firm have no cash, but the stock is excellent, and all they need is time to realize upon it without sacrificing it.

The attorney also stated that the preferred creditors had signified their willingness to be paid on the same basis as the other creditors, and to grant this extension provided Mr. Lyon's proposition was accepted by all the creditors.

David McClure, receiver for the National Bank of Deposit, has entered three judgments against S. Lyons & Son aggregating \$2,989.08.

**A Desperate Jewelry Store Burglar Come to Book.**

BIRMINGHAM, Ala., Sept. 14.—William Johnson, a noted negro burglar, who is wanted here for alleged complicity in several jewelry robberies is in jail at Opelika, Ala. He burglarized a jewelry store in that place three days ago and was run down by the officers.

When caught he had two pistols and several valuable articles of jewelry on his person. The police searched Johnson's house in this city and recovered a large lot of stolen plunder among which were a dozen or more watches, several diamonds and a profusion of cheap jewelry which he had stolen from stores here.

**The Case of Albert M. Rich Settled Out of Court.**

TROY, N. Y., Sept. 15.—Albert M. Rich, accused of stealing \$500 worth of jewelry

from the J. R. White Jewelry Co., for which he was a salesman, in police court yesterday waived examination for the grand jury. Rich was bailed for \$1,000, Dr. L. A. Kenny becoming his surety.

A settlement of the case had been agreed upon, Rich's wife having raised sufficient money to redeem the jewelry he had pawned. The pawnbrokers had agreed to surrender the goods for the money they had advanced without interest, the sheriff had agreed to remit his fees and everyone was assisting in making the settlement as easy as possible for the wife.

**The Retail Jewelers' Association of Alabama Meets Oct. 2.**

BIRMINGHAM, Ala., Sept. 14.—The Retail Jewelers' Association of Alabama has issued the following call to its members:

ATTENTION, MEMBERS OF R. J. A. OF ALABAMA.

The annual meeting of the Retail Jewelers' Association of Alabama is hereby called to meet in Birmingham, Ala., on Monday, October 2, 1893.

Reduced rates will be given on all railroads in the State on account of Confederate Reunion on above date.

Your presence is needed, and as the time and place is suitable every member should be present. Make this an important meeting.

Fraternally,

WM. ROSENSTHIL,

Secretary.

J. L. SCHWEIZER,

President.

**A Receiver Asked for the business of Edward Ducas.**

INDIANAPOLIS, Ind. Sept. 18.—Silas Baldwin, Enrique C. Miller and William Linder, comprising the wholesale jewelry firm of Baldwin, Miller & Co., have filed suit in the Circuit Court against Edward Ducas, the W. Washington St. jeweler. They also ask for the appointment of a receiver for Ducas business.

The defendants charge that Ducas is indebted to them in the sum of \$1,090.60, a balance due on account for goods sold him; that his only property is in his stock, which is worth \$6,000 and that within a short time he covered it with a mortgage for \$3,000 to his wife and one for the same amount to Louis Manhemier, Chicago.

**A Pretty Couple of Burglars in the Police Toils.**

DANBURY, Conn., Sept. 18.—The Danbury police have succeeded in capturing two clever burglars whom they have been after for a month or more. They are husband and wife, both colored; their names are Eli and Annie Carpenter and they were brought from Newark, N. J., on requisition papers.

Some time during the night of Aug. 13th the jewelry and clothing store of Solomon Meyers, 46 White St., this city, was entered by burglars and property to the value of \$270 taken. The thieves had rigged themselves out in the best clothes in the place and taken along all the jewelry they could put their hands up.

**LE BOUTILLIER & Co.,**

**860 BROADWAY,**

**N. E. cor. of 17th St., - NEW YORK,**

Invite an Inspection of their  
Novelties in

**ROYAL WORCESTER,**

**WEDGWOOD,**

**CROWN DERBY,**

**COALPORT,**

**PÂTE SUR PÂTE,**

**BISQUE.**

Prices are very low this season, and dealers will find many exclusive styles in our stock.

# THE "KENSINGTON,"

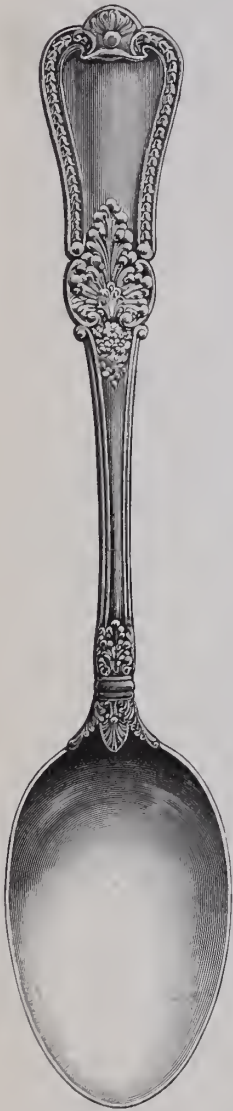

8, 10, 12 oz.



15, 18 oz.



22, 28 oz.



20, 25 oz.



15, 18 oz.

GORHAM MFG. CO., SILVERSMITHS.



# GORHAM SOLID SILVER.

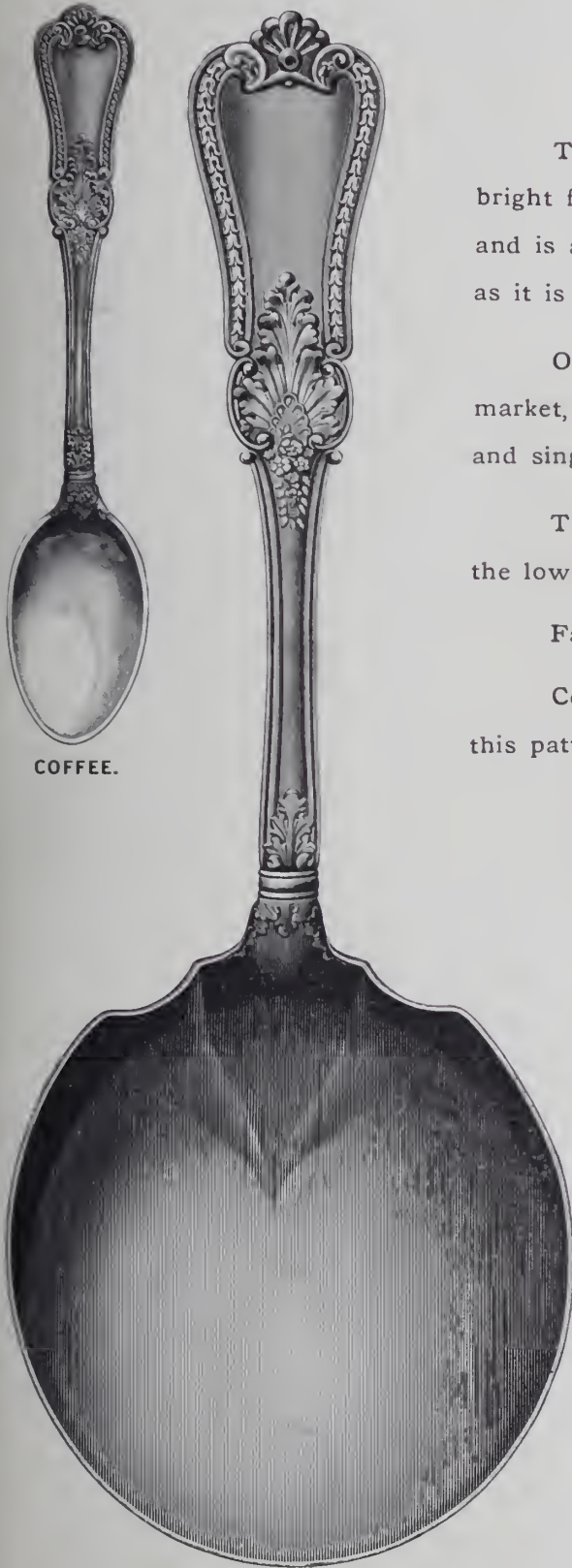

COFFEE.

BERRY.

THE KENSINGTON fully meets the demand for a plain, bright finished design of simple, yet artistic decoration and outline, and is also perfectly suited to the trade, requiring inexpensive silver, as it is made in light and medium as well as heavy weights.

Our "crêpe" case, the newest and most successful in the market, is particularly adapted for this pattern, in all combinations and single pieces.

The fancy pieces are beyond question and without exception the lowest in price ever offered.

Fancy Pieces as well as Spoons and Forks are now ready.

Combination Chests of all sizes up to 303 pieces, containing this pattern, can be delivered in October.



NEW YORK:  
BROADWAY AND 19TH STREET  
23 MAIDEN LANE.

CHICAGO:  
137 AND 139 STATE STREET.  
PARIS, FRANCE: 36 AVE DE L'OPERA

SAN FRANCISCO:  
118 AND 120 SUTTER STREET.  
WORKS: PROVIDENCE, R. I.

### Awards for Glass and Glassware Officially Announced.

CHICAGO, Ill., Sept. 17.—John Boyd Thacher yesterday officially announced the winners of diplomas and medals in Group 94 of Manufactures, including glass and glassware for almost all purposes. United States exhibitors fared well, and next to them the greatest number of medals were carried away by Austria. Following is the list interesting to members of the jewelry and kindred trades:

#### UNITED STATES.

- John Hoare & Co., Corning, N. Y., for glassware, rock crystal cutlery, cut glass, engraved glass.
- Libbey Glass Co., Toledo, O., for cut glassware, ornamental and table.
- George A. Macbeth & Co., Pittsburgh, Pa., for optical glass.
- L. Straus & Sons, New York, for artistic display, collective display, candelabra 12 feet high, Columbus punch set, large drug bottle, epergnes.
- Tiffany Glass and Decorating Co., New York, for reredos panel, lectern, mosaics in glass, picture panel, altar, pulpit, reredos, padelle.

#### FOREIGN COUNTRIES.

*Great Britain*—A. B. Daniel & Sons, St. Helens, England, for sculptured glass.

*Germany*—Berger, Walter & Co., Götzenbruck, for watch crystals and spectacle lenses, New York house, Albert Berger & Co.; Rheinische Glashütte, Coln, glass in antique style; Otto Vittali, Offenburg, glass etching.

*Austria*—Johann Zeckert & Son, Meislerdorf, fancy glassware; Franz Wagner, Ulrichsthal, fancy glassware; H. Ulrich & Son, Wilhelmsthal, fancy glassware; Tschermich & Co., Haida, fancy glassware; Schimmel & Kraemer, Steinschönau, fancy glassware; Ras Clemens & Sons, Ulrichsthal, decorated glassware; Bachman Bros.; Haida, fancy glassware; Ludwig Moser, Karlsbad, Bohemian glassware; Hermann Muller, Ulrichsthal, Bohemian glassware; Johann Loetz Witwe, Klostermühle, decorated glassware; Lazarus & Rosenfeld, Steinschönau, decorated glassware; Erlauchet Graf Harrach, glass factory, Neuwelt, decorated glassware; Carl Goldberg, Warnsdorf, decorated glassware.

*Japan*—K. Abira, Tokio, crystal ornament; Mayoechi Shumeda, Osaka, glass flower vases.

*Sweden*—Reymgre Glass Works, Reymgre, table glassware, fancy glassware, exhibition cups and fancy glassware.

*Argentine Republic*—Samuel Gambay, Buenos Ayres, cut glass.

*Italy*—A. Saluati & Co., Venice, fancy glassware; the Venice and Murano Co., Venice, fancy glass.

#### THE HOLMES & EDWARDS SILVER CO. AWARD.

BRIDGEPORT, Conn., Sept. 16.—The Holmes & Edwards Silver Co. say they are in re-

ceipt of information from Chicago that their exhibit at the World's Columbian Exposition has been awarded the first prize, covering the manufacture of silver plated spoons and forks.

### Julius Bernstein, Unable to Meet His Debts, Assigns.

Julius Bernstein who carried on business as an importer of diamonds, at 48 Maiden Lane, New York, assigned Thursday to Frederick Goldsmith, of Herzog, Goldsmith & Frank, with preferences to the Importers' and Traders' Bank and the Butchers' and Drovers' Bank, for any notes of the assignor which they may have discounted.

Mr. Bernstein has been in business in New York about six years. He had been previously for twenty years in the jewelry business in Chicago. To a CIRCULAR reporter, Mr. Bernstein stated that his assignment was due to the dulness of business and the impossibility of making collections. He estimates his liabilities at about \$50,000 and his assets at about the same amount.

He has not, he said, bought any goods within the last three or four months and in that time has paid about \$30,000 of his indebtedness. "I paid," said he, "until I could pay no longer, until my cash ran out. I want to pay my creditors 100 cents on the dollar and I hope to be able to do so."

### The Assets and Liabilities of Jas. Dixon.

The schedules of Jas. Dixon, lately doing business as James Dixon & Co., at 323 8th Ave., New York, and who assigned on Aug. 18th, to Ralph E. Prime, Jr., were filed Monday. They show the liabilities to be \$12,105.53 and the nominal assets \$13,321.30, the actual value of which is \$4,420.43.

In the affidavit accompanying the schedules the assignee's explanation of the discrepancy between the nominal and actual values of the assets, states that the retail selling price of the stock is taken as its nominal value and the cost price as its actual value. The assets also include certain debts owing to the assignor, most of which are old and of doubtful value, some being amounts due for job work which has never been called for. Included in the assets there is also stock the nominal value of which is put at \$2,861, which has been pledged by Dixon to certain persons as collateral to secure loans and advances amounting to \$1,367. The value of the amounts owing to the assignor is given nominally at \$1,039.94 and actually at \$951.84.

The principal creditors are Hugh Dixon, of Minneapolis and the Rev. John Dixon, Trenton, N. J. Among the others are Terant & Gesmond, Krentz & Co., L. & J. Adler & Co., Hodenpyl & Sons, Bioren Bros., Bassett Jewelry Co., Reeves & Sillocks, C. Sydney Smith, Jules Racine & Co., M. C. Corlon, Mrs. Diggins, Mrs. Heart and Henry Silfke. The last four are for money loaned and for money due for rent.

### Last Week's Arrivals.

**THE CIRCULAR has perfected arrangements for obtaining the names and hotel addresses of all the latest buyers visiting New York, and each day posts in its office, 189 Broadway, a bulletin which every member of the trade is cordially invited to copy.**

The following out-of-town dealers were registered in New York during the past week: G. H. Richards, Boston, Mass., Waldorf H.; F. J. Stilson, Atlanta, Ga., Astor H.; S. Lebach, buyer for J. Lebach, York, Pa., Broadway Central H.; T. B. Ryder, buyer for Sibley, Lindsay & Carr, Rochester, N. Y., 120 Franklin St.; H. M. Eliassof, Albany, N. Y., Astor H.; G. L. Parker, Boston, Mass., Astor H.; C. A. Judge, buyer for F. M. Brown & Co., New Haven, Conn., 108 Worth St.; H. E. Hall, buyer for Forbes & Wallace, Springfield, Mass., Murray Hill H.; E. J. Leonhard, buyer for J. Leonhard & Son, New Orleans, La., 90 Walker St.; W. A. Blumenthal, Boston, Mass., International; H. Tilden, Providence, R. I., Murray Hill H.; M. Timpane, Troy, N. Y., Grand Union H.; I. Kaufman, Richmond, Va., Imperial H.; G. F. Leighton, Providence Jewelry Co., St. Louis, Mo., Murray Hill H.; C. H. Mason, Washington, D. C., Park Ave. H.; A. L. Sercomb, Chicago, Ill., Grand Union H.; H. B. Michie, Cincinnati, O., Oriental H.; I. J. Frank, Akron, O., Broadway Central H.; F. C. Richard, Bellefonte, Pa., Astor H.; J. Nelson, Dunkirk, N. Y., St. Denis H.; W. H. Durfee, Providence, R. I., Imperial H.; C. E. Wigginton, buyer for Woodward & Lathrop, Washington, D. C., St. Denis H.; J. Karr, Washington, D. C., Gilsey H.; J. Scooler, New Orleans, La., St. Denis H.; W. B. Musser, Lancaster, Pa., Sturtevant H.; E. Rosenthal, Charleston, S. C., Astor H.; A. Oskamp, Cincinnati, O., St. Denis H.; G. F. Durgin, Concord, N. H., Hoffman H.; M. Baginsky, New Orleans, La., Broadway Central H.; G. Beninghauser, Seattle, Wash., Marlborough H.; M. A. Stupp, Rochester, N. Y., Grand H.; C. Die-singer, Philadelphia, Pa.; R. Harris, Washington, D. C., St. Denis H.; J. W. Kuapp, Cross River, N. Y.

### An Employee of Kirby, Mowry & Co. Steals Gold Systematically.

PROVIDENCE, R. I., Sept. 14.—Detective Parker yesterday afternoon arrested Robert Tipping and his cousin, Charles R. Tipping, as being implicated in the stealing of gold wire from the manufactory of Kirby, Mowry & Co. The amount stolen represents something like \$500 and not until after Detective Parker arrested Robert Tipping at the shop of Kirby, Mowry & Co., did the latter know that they had lost any valuable stock. While making a visit to a pawn shop in this city, the officer saw Tipping attempt to hide something under his coat. He was at once arrested on suspicion and taken to the city hall when, upon a search being made, the gold wire was found.

# The Jewelers' Circular AND HOROLOGICAL REVIEW.

PUBLISHED EVERY WEDNESDAY BY  
**THE JEWELERS' CIRCULAR PUB'G CO.,**  
189 BROADWAY, NEW YORK CITY.

A JOURNAL DEVOTED TO THE INTERESTS OF  
JEWELERS, WATCHMAKERS, SILVERSMITHS,  
ELECTRO-PLATE MANUFACTURERS, AND ALL  
ENGAGED IN KINDRED BRANCHES OF INDUSTRY.

Our Editorial columns will contain our own opinions  
only, and we shall present in other columns only what  
we consider of interest or value to our readers. Adver-  
tising matter will not be printed as news.

Advertising rates in THE CIRCULAR are lower,  
considering the number of tradesmen reached by its  
large circulation, than in any other jewelry journal.

Notices of changes in standing advertisements  
must be received one week in advance; new matter  
can be received up to Monday.

### INFORMATION FOR SUBSCRIBERS.

#### Terms of Subscription, Postage Prepaid.

	PER ANNUM
United States and Canada, . . . . .	\$2.00
Foreign Countries in Postal Union, . . . . .	4.00
Single Copies, . . . . .	.10

New subscribers can commence at any time.

Payments for THE CIRCULAR, when sent by mail, should be made  
in a Post-Office Money Order, Bank Check or Draft, or an Express  
Money Order or Registered Letter. All postmasters are required to  
register letters whenever requested to do so.

Pay money only to authorized collectors having proper credentials.  
Returning your paper will not enable us to discontinue it, as we  
cannot find your name on our books unless your address is given.

In changing address always give the old as well as new one.  
Your name cannot be found on our books unless this is done.

We will continue to send papers until there is a specific order to  
stop, in connection with which all arrearages must be paid; but such  
an order can be given at any time, to take effect at the expiration of  
the subscription. All such orders will be promptly acknowledged by  
mail.

The Courts have decided that all subscribers to journals are  
responsible until arrearages are paid in full and an order to discon-  
tinue has been received by the publisher.

Member of the American Trade Press Association.

Vol. XXVII. Sept. 20, 1893, No. 3.

## WINDOW DESIGN CONTESTS, NO. 1.

A Prize of \$10.00 is offered by THE  
JEWELERS' CIRCULAR for the best  
design for dressing a jeweler's window.  
The contest is open to all members of  
the trade, to the clerks, salesmen and  
others, as well as to the dealers. Fol-  
lowing are the conditions:

1. The design is to be submitted as a pencil or other sketch or photograph, from which a finished engraving may be made. The design may be an original conception or a copy of a window already dressed.
2. A brief description is to accompany the design.
3. The design must be appropriate for the Fall and holiday season.
4. Designs for Contest No. 1 must reach us no later than Oct. 1.

THE last issue of THE CIRCULAR showed a volume of advertising 70 per cent. greater than that in any other jewelry publication. Each member of the trade can make his own deduction from this statement, as to the superiority of THE JEWELERS' CIRCULAR over its contemporaries.

IN the manufacture of glass and glassware America has proved her supremacy over all other nations as may be seen in the official reports of the awards in Group 94, at the World's Columbian Exposition. This official list as far as it interests the jewelry and kindred trades is given in another column of this issue of THE CIRCULAR.

**Edison as an Alchemist.** WIZARD EDISON is once more a bugaboo before the public. He declares that if he were disposed he could cause a

panic among the dealers in precious stones. The artificial production of precious stones he regards as a mere scientific child's play, a scientific game of "tag" as it were. He, therefore, has no intention of bearing the market, though he can, according to his statement, manufacture fine sapphires for next to nothing, and produce rubies superior to the natural stone for \$5 a pound. There is a superlative tincture in Edison's ideas, and we would not be surprised if in a little while he were able to shunt silver into gold, so that everybody would be a monometallist. The Wizard should reconsider his decision. People have a particular love for rubies and sapphires and the utilization of his secret would revolutionize the entire condition of human affairs. If Bridget could only buy a peck of rubies, etc., as good as those her mistress wears she would be more content with her lot, while the beauty of policemen would be enhanced by bright buttons of ruby instead of ones of brass. At length, with the natural progress and perfection of the process, rubies and sapphires would become so cheap that boys would play marbles with them, while large ones would be used for hitching blocks. Maiden Lane could be paved with pigeon blood rubies instead of noise-generating granite blocks, till by the end of the century the New York Legislature would pass a bill for the construction of a new aqueduct lined with the purest of sapphires. Truly the era of culmination of the alchemist's dream is upon us.

**Before Anything Else, the Repeal Bill.** R ETURNS from every part of the country to the commercial agencies, show decided improvement. Hopeful feeling prevails, money grows abundant at speculative centres, and somewhat easier for commercial purposes. Weekly failures have declined about half in number and more than half in amount of liabilities. However, the developments in Congress during the past week have been the reverse of encouraging to the vast body of people throughout the

country. In the Senate time is being consumed by long and unilluminating speeches upon a question that has been gone over so often that not only no new arguments can be discerned, but not even new points of view from which to treat the old ones are apparent. This is to be regretted, not only because of the temptation to seek a way out by means of some compromise measure, but until the silver purchase clause is repealed the confidence so necessary to the complete restoration of prosperity cannot be fully regained. In the House the leaders of the majority are complicating matters by decrying Federal supervision of elections. A wise policy would admonish them to bridle their activity for the present, or at least to confine their efforts to the enactment of legislation not likely to arouse partisan excitement. The Senate should hasten toward a vote on the Repeal Bill, and put the important piece of business legislation now before it upon the statute book.

### The Week in Brief.

THE store of Chris. Anderson, Moorhead, Minn., was robbed, and thief caught—Details of the failure of Andrew E. Warner, Baltimore, Md., were made known—Matthew Hollenbeck was sentenced for burglarizing the store of Austin & Prescott, Batavia, N. Y.—The town of Mystic, Conn., is negotiating for the establishing of a watch factory there—S. Lyons & Son, New York, offered 100 per cent. in settlement at a meeting of their creditors—The annual meeting of the Retail Jewelers' Association of Alabama has been called—Robert Jurgensen, Windsor Locks, Conn., left town under peculiar circumstances—Baldwin, Miller & Co., Indianapolis, Ind., filed suit for the appointment of a receiver for the business of Edward Ducas, of the same city—A man and his wife were arrested charged with burglarizing the store of Solomon Meyers, Danbury, Conn.—S. Lubin, Philadelphia, Pa., settled with the insurance companies—Wm. G. Hopkins was appointed administrator of the estate of Walter E. White, Providence, R. I.—The Providence creditors of Strauss & Stern, Cincinnati, O., accepted 25 per cent. in settlement—The Associated Press report announcing the drowning of Walter Franklin, son of E. I. Franklin, North Attleboro, Mass., was erroneous—Julius Bernstein, New York, made an assignment—The schedules of James Dixon, New York, were filed—The death of Gottlieb Dessauer, New York, occurred—The store of A. J. Bockus, Baldwin, Wis., was burned out—The death of John G. Bosch, Menasha, Wis., was reported—The store of J. M. Logan, Cutler, Ind., was destroyed by fire—The death occurred of William E. Coddington, Norfolk, Mass.—C. Vuille, Paxton, Ill., assigned—The store of George Darden, Wilmington, N. C., was burned out—The creditors of Joshua Lothrop & Co., Providence, R. I., held a meeting.

### New York Notes.

Alois Kohn & Co. have obtained a judgment for \$490.59 against Meyer Isenberg.

John B. Yates is visiting the World's Fair. He returns the early part of next week.

H. Allsopp & Co. have obtained a judgment for \$142.29 against Moritz Moos.

R. A. Breidenbach has entered a judgment for \$945.31 against Morris Ginsburg.

A judgment for \$274.62 has been entered against Elias Pilzer in favor of Lewisohn & Co.

A. Frankfield, of A. Frankfield & Co., New York, arrived from Europe Sunday on the *Etruria*.

Frederick H. Schultz has been admitted as a member of the firm of Pachtmann & Moelich, 363 Canal St.

Sam Stern, of Sam Stern & Co., left Sunday for Chicago on a two weeks' visit to the World's Fair.

C. E. Tissot, member of the jury on horology of the World's Columbian Exposition, sailed for Europe from New York Saturday on *La Gascogne*.

Reed & Barton have commenced an action in the City Court against Leon Cottentin to recover \$1,635.53 for goods sold and delivered.

The New York Jewelers' Board of Trade have obtained a judgment for \$505.79 in favor of the Brooklyn Watch Case Co., against Tobias & Wolf.

W. H. Shipman, 4 Maiden Lane, left this week for Chicago by the Columbian Express of the Pennsylvania R. R., for a short visit to the World's Fair.

Sigmund Hirschberg has obtained a judgment for \$434.87 against Geo. C. Taylor, lately doing business as Taylor & Brother. H. B. King and others have also entered a judgment against him for \$310.62.

The following judgments have been entered against Taylor Bros., pawnbrokers and jewelers, 96 Hester St.: One by Henry Fera for \$1,413.54 and one by Vve. L. B. Citroen & Co. for \$4,539.98.

On *La Touraine* which arrived Sunday, were the following members of the trade: H. Demmert, with S. Dessau, New York; Albert H. Potter, Geneva, Switzerland; M. Thurnauer, New York, and Chas. L. Uhry, Newark, N. J.

Samuel W. Millbank, the temporary receiver of the A. De Riesthal Co., importers of china, art pottery, ornaments, etc., was appointed permanent receiver of that company by Judge Ingraham of the Supreme Court last week.

The factory of the Alvin Mfg. Co., at Irvington, N. J., has resumed work on full time. Orders from Chicago necessitate a large output of the official World's Fair souvenir spoons which this company manufacture.

Isaac Rapoport, 41 Maiden Lane, who

has been endeavoring to compromise with his creditors at 33 $\frac{1}{2}$  per cent., stated to a CIRCULAR reporter, Monday, that the settlement had been effected with all his creditors, and that he would continue business as heretofore.

Reed & Barton have obtained three judgments aggregating \$5,029.23 against Leon Cottentin.

Ludwig Hirsch has started in business as a diamond dealer with a temporary office at 24 Maiden Lane. He was formerly for many years manager of the diamond department of Koch, Dreyfus & Co.

The following judgments were entered against Jos. D. Lynch last week: One for \$287.88 by L. Mann & Co., one for \$235.86 by F. Slurmwind, one for \$344.79 by L. Langer, and one for \$274.33 by E. C. Mertz & Co.

The H. B. Claffin Co. have appealed to the Court of Common Pleas from the decision of the General Term of the City Court, which on May 15th awarded the New York Standard Watch Co. \$92.20 costs, and also affirmed the judgment for \$2,672.02 which they had previously recovered against the H. B. Claffin Co.

Michael Moriarty, alias "Mick the Dude," who, as reported in THE CIRCULAR some weeks ago, was arrested on the charge of having drugged and robbed Aaron Wollander, a jewelry peddler, three years ago, but who was released later because no complainant appeared against him, is now wanted by the police. His victim is a patient in Bellevue Hospital.

Kiva Ralter, of 421 E. 82d St., was a prisoner before Police Justice Meade in the Tombs Police Court, Saturday, on the complaint of R. H. Breidenbach, 57 Maiden Lane, who said that some months ago Ralter obtained from him a diamond stud which he promised to return if he did not succeed in selling it. As he did neither Mr. Breidenbach caused his arrest and he was held for trial in \$2,500 bail.

The New York Standard Watch Co., which two weeks ago resumed work at their factory in Jersey City with about one-fifth of their former force, have been constantly adding to this number until now about one-third of the number of employes has been reinstated. The treasurer of the company, who was seen by a CIRCULAR reporter at the New York office, stated that the number of hands will be gradually increased until the full force is employed.

#### Jewelers Petition to Have Maiden Lane Asphalted.

The following petition has received the signatures of over one hundred and thirty property owners and tenants on Maiden Lane, between Broadway and William Sts., New York.

"HON. MICHAEL T. DALY:

Commissioner of Public Works,

31 Chambers St., New York.

SIR: The undersigned jewelers and merchants doing business in Maiden Lane and

adjoined streets respectfully petition that Maiden Lane be included in the streets to be paved with asphalt. The constant heavy traffic on that thoroughfare causes considerable damage to wares by reason of dust and grit, while the diminished noise resulting from an asphalted pavement would add materially to our comfort and prove an advantage in business transactions."

The petition was signed at once by those interested, wherever presented, and is now in the hands of Commissioner Daly.

#### The Death of Gottlieb Dessauer.

Gottlieb Dessauer, a widely known dealer in novelties in jewelry, diamonds and silverware, 456 Broadway, New York, died Saturday from a complication of asthma and hay fever. He had been suffering from the former for about a year.

Mr. Dessauer was born in Stuttgart, Germany, March 12, 1843. Having received his education and learned the trade of watchmaking, he came to America in 1866. For a short time he worked as a clerk in Buffalo, N. Y., and later traveled through the country selling watches. In 1874, he commenced as a dealer in novelties in jewelry and fancy goods, which he continued until the time of his death.

In 1871 Mr. Dessauer married Miss Hannah Goldsmith, who together with two sons, survive him. Mr. Dessauer who was one of the leading merchants in his line, numbered many friends throughout all branches of the jewelry trade. He was a member of the Jewelers' League and of the Empire City Lodge, F. & A. M.

The funeral took place Monday morning from Temple Emanu El, 43d St. and 5th Ave. The interment was in the Temple grounds at Cypress Hills cemetery. The business will be continued by his son, Simon G. Dessauer.

#### Meeting of the Creditors of Green-Smith Watch and Diamond Co.

A meeting of the creditors of the Green-Smith Watch & Diamond Co., Denver, Col., which was called by F. L. Smith, of that company, was held in the rooms of the New York Jewelers' Board of Trade, New York, on Monday afternoon. David N. Smith, of William Smith & Co., acted as chairman.

The statement presented by F. L. Smith of the liabilities and assets of his firm, showed the former to consist of borrowed money to the amount of \$178,000, and a merchandise indebtedness of \$75,000, making the total liabilities \$253,000.

The total assets amounted to \$190,000. In this the fixtures were valued at \$2,000 and the book accounts at \$10,000, but Mr. Smith said that the latter might realize \$40,000 or \$50,000.

The offer of settlement made to the creditors was that they take ten year bonds in the concern which shall draw interest at 6 per cent., beginning Jan. 1st. Definite action will probably be taken during the coming week.

Solid Silver  
Exclusively.



WHITING M'F'G Co.

SILVERSMITHS,

Broadway & 18th Street,

NEW YORK.

WORKS--AT FOURTH ST. AND LAFAYETTE PLACE.

**Boston.**

Marcus Greenberg has formed a limited partnership, with a special capital of \$2,000, to Sept. 1, 1894.

Fred and Harry Harwood, employes of Harwood Bros., left this city last Saturday for Chicago where they will spend a couple of weeks "doing" the Fair.

Among the buyers in town last week were: J. P. Fogg, Woburn, Mass.; H. B. Howland, New Bedford, Mass.; T. A. Morgan, Lebanon, N. H.; R. D. Currier & Co., Brockton, Mass.; A. M. Mossman, Hudson, Mass., and N. C. Nelson, Concord, N. H.

Horatio Williams, for five years a valued employe of Smith & Patterson, severed his connection with that concern last Saturday and will soon depart for Denver, Col., where he expects to permanently locate. His fellow employe, as a mark of their esteem and consideration, presented him with a 14 karat gold chain and diamond charm, inscribed "From Friends at 52 Summer Street." On his way to Denver, Mr. Williams will take in the World's Fair.

The report sent out by a local news bureau to the effect that the foremen of the American Waltham Watch Co. had been ordered to increase their force by one hundred men, is substantiated by Mr. Harndon, at the office of the company in this city. The factories have been running during the dull Summer season with one-half their usual number of workmen or about fifteen

hundred hands. How soon the force will be further increased will depend on the rapidity with which the orders come in. The one hundred hands taken back last week were all former workmen of the company.

President Charles F. Morrill, of the Boston Jewelers' Club, who has many times entertained the members of that organization, has just issued invitations announcing arrangements for a reception and sail in honor of "Our Home Partners," which of course means the wives and lady friends of the members. Mr. Morrill is commodore of the South Boston Yacht Club and owner of the dainty steam launch *Navarch*, the flagship of the club. This Wednesday, Sept. 20th, is the day set for the sail and if all arrangements are carried out the party will leave the pier of the South Boston Yacht Club about 2 o'clock for an afternoon cruise in the waters of Boston harbor, returning to the club house at 5 o'clock.

**Philadelphia.**

George F. Springman has opened a repair shop on Sansom St.

Charles E. Hamer has returned from a visit to the World's Fair.

A visitor who made purchases here last week was Arthur Winters, of Erie.

Sharpless Bros. have added a jewelry and silverware department to their establishment.

Wm. B. Beck, a salesman employed by W. A. Satterfield, was acquitted last week of the charge of embezzling a quantity of jewelry.

Extensive alterations are being made on the third floor of Queen & Co.'s establishment, 1010 Chestnut St., so as to provide additional space for the art department.

Michael Zineman, senior member of M. Zineman & Bro., left on Saturday last for a tour of the west. He will spend two weeks at the World's Fair and then go to Yellowstone Park and other points of interest in the far west.

Optician S. Lubin has been paid \$4,000 by the insurance companies. It was shown that the late fire in his workshop was caused by an imperfect gas burner. The detectives have also recovered for Mr. Lubin a large quantity of the articles stolen from the store just before the fire.

The jewelry and optical establishment of Thomas J. Murray, 1811 E. York St., was entered by a thief on the afternoon of the 9th inst., while Mr. Murray was in the rear of the store. The thief secured the key of the show case and managed to get away with three watches.

The following traveling men circled among Philadelphia houses last week: John Lamb, E. L. Logee & Co.; Reuben Thompson, for Henry Glorieux; Wm. C. Parks, Parks Bros. & Rogers; Ira Burrows; Charles Whiting, Wade, Davis & Co., and G. Clifford Booth, Hutchison & Huestis.

BUY THE OLD AND RELIABLE

**STAR ★ BRAND**

Electro Silver Plated Flatware,

STAMPED

★ **ROGERS & BRO., A. I.**

Which has stood the test for fifty years.....

.....For sale by all first-class jobbers.

MANUFACTURED ONLY BY

**ROGERS & BROTHER,**

**Waterbury, Conn.,**

**16 Cortlandt St., N. Y.**

SEND FOR NEW CATALOGUE, NOW READY.

# EBONY AND SILVER TOILET ARTICLES.

IN NEW AND ELEGANT  
COMBINATIONS.



AS this combination is to be very fashionable this season, we have produced the most elaborate line on the market in Ladies' and Gentlemen's Toilet and Manicure Articles. These goods are mounted with pierced Sterling Silver, and decorated by the most artistic hand engraving.

A full line of these goods will make a beautiful window display. Send for samples.



**MADE IN**

- |                         |                        |
|-------------------------|------------------------|
| HAIR BRUSHES.           | SHOE AND BUTTON HOOKS. |
| MILITARY BRUSHES.       | NAIL POLISHERS.        |
| CLOTH BRUSHES.          | POWDER AND PUFF BOXES. |
| HAT BRUSHES.            | NAIL POWDER BOXES.     |
| BONNET BRUSHES.         | SHOE HORNS.            |
| GENTLEMEN'S COMBS.      | NAPKIN RINGS.          |
| LADIES' COMBS.          | PAPER CUTTERS.         |
| ROUND AND OVAL MIRRORS. | HAND BLOTTERS.         |
| WHISK BROOMS.           | NAIL FILES.            |
| PIN TRAYS.              | CORN KNIVES, etc.      |

**J. N. PROVENZANO,**

GOLD AND SILVERSMITH,

No. 39 UNION SQUARE.

NEW YORK CITY.

# Geneva Optical Company.

Our new catalogue giving new prices, new goods and a full line of Optical Outfits, Trial Cases, Lens Measures, Prism Measures and all kinds of Optical Goods now ready, and sent at request.

WE ILLUSTRATE BELOW A FEW OF OUR NEW SPECIALTIES.



## COMPLETE SET TRIAL LENSES.

No. 995. Contains 32 pairs+(convex) spherical, .25 to .20D; 32 pairs (concave) spherical .25 to .20D; 20 pairs+(convex) cylinders, .25 to .6.50D; 20 pairs-(concave) cylinder .25 to .6.50D; 10 prisms; 4 pairs, plain colored lens; 1 white glass; 1 half-ground disc; 2 stenoptics; 1 solid and 2 discs with small hole; discs of hard rubber.

Rims on all the lenses, nicked on the convex, gilded on concave.

Graduated trial frame No. 915. Plain trial frame No. 919. All in well made morocco case, lined with velvet.

This case for accuracy, we are willing to have compared with any either of foreign or American manufacture.

The exceptionally low price, must not be taken to indicate its quality, as that must be judged by the case itself. Price \$59.00.

**Special offer 10 and 6 off, net Cash \$50.00.**

## OUR PRESCRIPTION WORK

is now the most accurately and promptly done. Try a month and see.

## DIRECTIONS TO USE THE PRISM MEASURE AND LENS CENTERING INSTRUMENT.

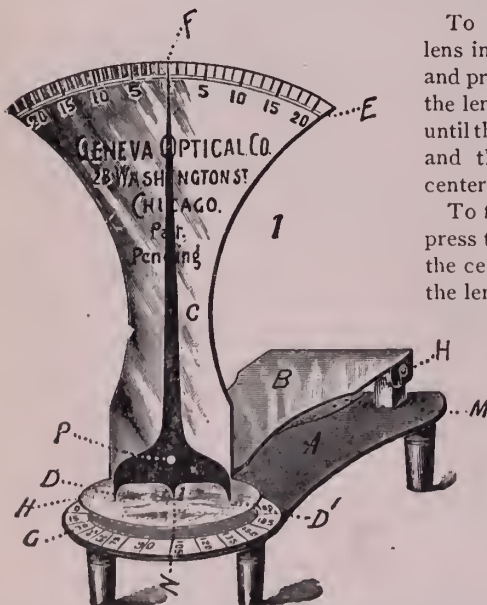

To find the center of a lens, put the lens in as shown in illustration at "H," and press the points "DD" down firmly on the lens, sliding it across the instrument until the index finger "F" points to "O" and the center point will be over the center of the lens.

To find the amount of prism in a lens, press the points "DD" firmly down with the center point "N" over the center of the lens. The index finger will point to the degree indicating strength of prism either plain or in combination with spherical or cylindrical surfaces.

To cut a spherical or cylindrical lens to get any required degree of prism, find the points in the lens, where the index finger will indicate the degree of prism required, and cut the lens with its center at the point

under the center points of index finger. Price \$5.00.



## THE GENEVA LENS MEASURE IMPROVED.

"You press the lens, it tells the focus."

For full description see catalogue.

Price \$10.00.

67 & 69 Washington Street, Chicago, Ill.



# WORLD'S FAIR and WESTERN SUPPLEMENT of THE JEWELERS' CIRCULAR

CHICAGO OFFICE: ROOM 308, INTER-OCEAN BUILDING.

VOL. XXVII.

CHICAGO, WEDNESDAY, SEPTEMBER 20, 1893.

NO. 8

## OPTICAL PRODUCTIONS AT THE WORLD'S FAIR.

PART III.—THE EXHIBITS OF ROSS & CO., IVAN WERLEIN, E. LACOMBE, PICARD, H. ROUSSEL & L. BERTEAU.

THE exhibit of Ross & Co., London, for whom the Geneva Optical Co. are American agents, has a fine position in the northwest corner of the British section of the gallery of Liberal Arts. In a large wall case at the rear, and a counter case at front are displayed a fine line of the celebrated Ross photographic lenses, photographic outfits, military, tourist, naval and astronomical telescopes, patent microscopes, object glasses, microscopic apparatus, and race, field, opera, marine and night glasses.

The Ross patent concentric lenses have special advantages for landscape, architectural or copying work in that they give uniformly perfect definition with equal illumination over an absolutely flat field of a circle of about 75°, the extreme oblique rays coming to a focus with the same remarkable sharpness as the central pencils; and, therefore, these lenses will cover a larger plate when desired than those specified. The concentric defines perfectly with its full aperture, and does not require the use of stops to obtain marginal definition as in other lenses; the stops, therefore, need only be used to regulate the time of exposure and the depth of focus.

The rapid symmetrical lenses, being ap-

lanatic, work with full aperture and are perhaps the most useful for general purposes. There is shown also a lens of special Jena glass that works with double the rapidity of the rapid symmetrical. This is known as the Ross Universal Symmetrical and is a new series of extra rapid specially adapted

both stand and hand work is the Ross New Portable Divided Camera. The Ross instruments are in use by the principal professional and amateur photographers throughout the world, and have obtained gold medals and highest awards: London, 1851; Paris, 1867; London, 1862; Philadelphia, 1876; Paris, 1878; Antwerp, 1878; Inventions Exhibition, 1885; Sydney, 1879; Grand Prix and Gold Medal, Paris Exposition Universelle, 1889; Kingston, Jamaica, 1891.

The following high praise is from the pen of C. D. Arnold.

CHICAGO,  
June 29, 1892.

"MESSRS. ROSS & CO.,  
London;

"Gentlemen—It affords me very great pleasure to inform you that the entire photographic record of construction of this Exposition is being made with your lenses.

"They were selected for the work purely on their merits, they having proved themselves, to my entire satisfaction, to be superior to any other lens in all that goes to make a perfect photographic objective.

"Very sincerely,  
C. D. ARNOLD,

"Official Photographer, World's Columbian Exposition, Chicago."

The field glasses and telescopes of the firm were pronounced by the judges at the Fair the finest ever seen.

Ross & Co. have the model for and will shortly place on the market a biological stand for medical students and college



THE EXHIBIT OF ROSS & CO., LONDON, ENG., AT THE WORLD'S FAIR.

for studio work. When stopped down they are suitable for all kinds of outdoor work, copying and enlarging.

The Zeiss patent anastigmatic lenses, manufactured by Ross & Co., combine rapidity with depth of focus, which is a desideratum with photographers.

In cameras one specially recommended for

laboratory use patterned on the continental stand with several improvements suggested by the demands of American laboratories. The advantages will be in giving a better base, larger stage and generally better proportions than the German stand at the same price. It is designed to meet the great demand for a simple microscope.

A series of microscopic objectives that are semi-apochromatic are shown in the exhibit. The definition is exceptionally fine and there is great depth of focus. They are said to

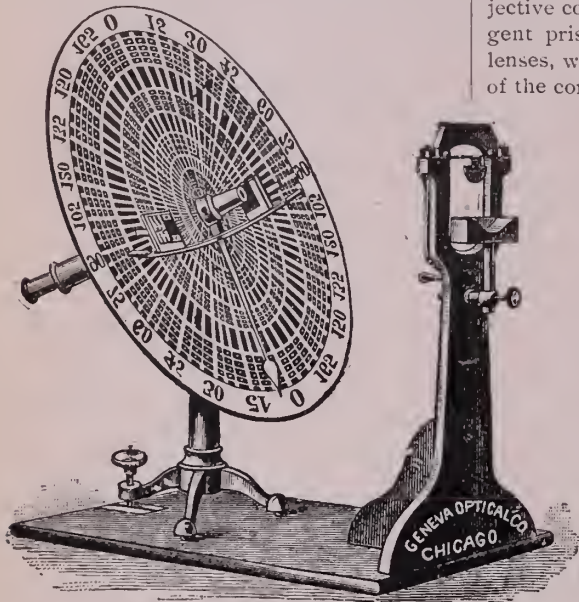

JAVAL AND SCHIOTZ OPHTHALMOMETER.

work with nearly the same brilliancy as the apochromatic of Zeiss, and are considerably less in price. They are perfectly permanent, no glass being used that has not stood the test of the atmosphere. Prof. Bristol is in charge of the exhibit.

The Javal and Schiotz ophthalmometer, which is manufactured by A. Goubeaux, of 216 Boulevard, Saint Germain, Paris, is exhibited in the Exposition in the Ethnological building, in charge of the Geneva Optical Co., Chicago. In brief the essential

principle of the instrument consists in reflecting upon the cornea of the patient's eye certain rectangular figures that can be moved in other positions to any portion of the field, and reflected from any part of the corneal surface. This reflection is then viewed through the telescope by the observer, and the irregularity of reflection can be determined by the relative position of these angular sliding figures, as they apparently come in contact with each other.

The barrel of the instrument has an objective composed of a Wollaston bi-refrangent prism placed between two bi-convex lenses, with foci at the center of curvature of the cornea, and at the proximal end of the barrel, where there is also a crossed spider's web and an ocular. Having the patient placed the ocular is adjusted to the spider's web and the instrument moved until a distinct image of the disc and movable slides is seen on the cornea. The movable image in the center, the extraordinary image is on the right. If there is astigmatism it will be noted by an overlapping or separating of the movable slides as the are is rotated. Astigmatism may also be measured by the size of the image. Markers show the axis of the astigmatism in hyperopia and myopia. This instrument is a very valu-

able aid to the eye specialist, as it is simple in construction and easy of manipulation, reaching desired results in very short time and with exactitude.

Other interesting apparatus for examining the eye are here shown which will interest the oculist and optician.

In the French section of the Gallery of Liberal Arts are the exhibits of Ivan Werlein, E. Lacombe, Picard and H. Roussel & L. Berteau, all of which firms are represented in America by the Geneva Op-

tical Co. Werlein's exhibit is highly scientific and consists of polarizing instruments for showing the different refractions of rays of light. These are accompanied with polyhedrons in many forms, sphericals and cylindricals, made of island spar, fluor spar and quartz. Many of the crystals here displayed come from South Africa and inaccessible regions and are almost impossible of duplication. Here are shown refractometers for determining the refraction of liquids and solids of different densities, and an improved saccharometer which transmits polarized light through a saccharine solution and indicates the proportion of sugar by the relative deviation of the plane of polarization.

A large microscope for polarizing light parallels and convergent rays took the grand prize at the Paris Exposition, and is the only one of its kind.

The Picard exhibit is of opera, field and marine glasses, all showing a fine finish and mostly decorated with pearl.

A large line of opera and field glasses and binocular telescopes is shown by E. Lacombe, of Paris, from the smallest sized opera glass to the large telescope. These are mounted in pearl, morocco, aluminum and tortoise shell, many with hand painted decorations.

H. Roussel & L. Berteau display photographic lenses, stops and shutters, focusing glasses for photographers, a fine line of opera glasses, mostly in leather, and binocular telescopes.

Taken all in all, with their two exhibits in the Liberal Arts gallery and Machinery hall and their other scientific optical exhibits, Ross (English) and Werlein, Goubeaux, Lacombe, Picard and H. Roussel & L. Berteau (French), the Geneva Optical Co., at the World's Fair, completely cover the field of advanced optical science.

D. La Beuff is opening up a new store in Harrisville, Mich., and purchased his initial stock in Chicago the past week.

DIAMONDS
WATCHES
BHA TRADE MARK
JEWELRY
MANUFACTURING

L APP AND FLERSHEM

Chicago, Ill.

92, 94, 96 & 98 STATE ST. COR WASHINGTON

THE LARGEST SUPPLY DEPOT

For everything needed by Jewelers.

ILLUSTRATED CATALOGUES FURNISHED JEWELERS.

SPECIAL FACILITIES FOR FILLING ORDERS NO RETAILING

STERLING &
SILVER PLATE
BHA
OPTICAL
GOODS

HOROLOGY AT THE WORLD'S FAIR.

PART XIV.—THE INVENTIONS OF CLEMENS RIEFLER.

CLEMENS RIEFLER, manufacturer of mathematical instruments of Munich, Bavaria, exhibits in the east gallery of the Electricity building of the World's Fair, the absolutely free pendulum escapement with impelling action in the axis of oscillation, covered by German Imperial patent No. 50,739; the escapement was fully described and illustrated in a former number of THE CIRCULAR when it was in its monthly form; next, the mercurial compensation pendulum, also illustrated and described under the heading of "New Mercurial Pendulum," in v. xxv., No. 23, p. 36 of this journal; also, an astronomical clock furnished with the escapement and pendulum. THE CIRCULAR consequently omits the technical descriptions and illustrations of the first two.

As the readers of THE CIRCULAR were informed, the uniformity of rate of this timepiece depends principally upon two conditions: the accuracy of the escapement and the perfect compensation of the pendulum. The principle of the escapement has also been applied to watches and tower clocks, and consists in the manner in which the absolutely free pendulum is impelled, which is not effected by the fork but by the pendulum spring. The impulse is, moreover,

given nearly at the moment when the pendulum passes the position of rest, and the supplementary arc of the pendulum is three or four times as large as the arc of elevation.

The advantages resulting from the whole arrangement are: Changes in the magnitude of the transmitted force and the resistance of the pallet action, both of which, however, have no practical influence upon the uniformity of the rate, while the timepiece is in a high degree insensible to outside disturbances.

The rod of the mercurial compensating pendulum is a steel tube, of 16 millimeters bore and 1 mm. in thickness. Nearly two-thirds of the tube are filled with mercury, and in consequence of this distribution of a small quantity of mercury over a great length, inequalities of the temperature of the upper and lower strata of air, and also sudden changes of temperature, have only a slight influence upon the pendulum and its rate. Mr. Riefler informed the representative of THE CIRCULAR that every pendulum is warranted to have in no case an error of compensation exceeding  $\pm 0.005$  per day and per  $\pm 1^\circ$  C.

With the astronomical clocks constructed by him, the warranted degree of accuracy is

1 second per week, and with timepieces intended for use as standard clocks for private establishments, etc., the warranted accuracy is 2 seconds per week. The Munich Observatory rated Mr. Riefler's No. 1 astronomical timepiece to have a coefficient of compensation of the pendulum for  $1^\circ$  C. = 0.0008 second per day, and a mean error of rate of 1 second per month.

The following certificate from the Royal chief post office at Munich is exhibited, which states that J. Neher Sons, of Munich, constructed in June, 1892, a large electric standard clock with the Riefler escapement and pendulum, and a train with minute contact for intermittent current, for the Royal central telegraph station in that city. This clock drives a double electric dial train with two dials in the office hall and office, and an electric dial train with a transparent dial over the main entrance of the telegraph building, and, further, on the third floor, five dials in the telegraph instrument rooms.

The very accurate rate of the clock fully answers the purpose of an extremely accurate indication of time; the list of rates scarcely show any perceptible deviations.

As an example it may be stated that the

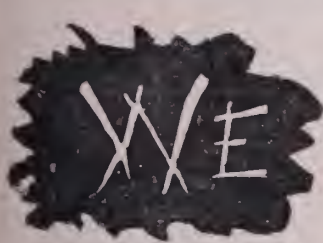

# GERMANY

SEEKS

AMERICAN TRADE,



And for the purpose of securing it has for several years **STUDIED AMERICAN WANTS**. The German exhibit at the World's Fair contains a full line of jewelry, specially **SUITED TO YOUR NEEDS** and expressly made with a view to furthering the jewelry and silverware trade between the two countries. Mr. Richard Horstmann, under whose supervision and through whose efforts the consolidated German exhibits were secured to the Fair, represents the following lines:

**WATCHES.** { The celebrated patent watches of **DURRSTEIN & CO.'S UNION WORKS AT GLASHUTTE**. Among them movements held by bolts, and not by springs, insuring thinnest cases, split seconds, Chronometers, etc.

**JEWELRY.** { Representative manufacturers of Pforzheim, Hanau and Gmeund. These cities are known worldwide for taste in designs and beauty of gold colorings and enamel work in all branches of the jewelry trade.

**SILVERWARE.** { Reproductions of the best old German, Dutch and Rococo designs.

We can serve your best interests if you will but let us know your wants. Correspondence invited.

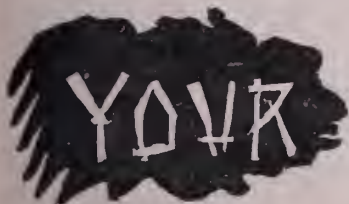

## RICHARD HORSTMANN,

VIENNA.

Seigmundgasse 15. Tel.-Adr.: PARATUS WIEN.

BERLIN, S. W.

Oranienstrasse 101 102. Tel.-Adr.: PARATUS BERLIN.

LONDON, E. C.

13 Charterhouse Street. Tel.-Adr.: WELLROOM LONDON



CHICAGO.—German Jewelry Exhibit, Manufactures Building, World's Fair.

GERMAN COURT OF HONOR.

time compared with the Royal observatory showed in the weeks from :

April 15—22	- - - - -	+ 1 second
" 22—29	- - - - -	- ½ "
April 29 to May 6	- - - - -	± 0 "
May 6—13	- - - - -	- 1 "
" 13—20	- - - - -	+ 0 "
" 20—27	- - - - -	+ 1 "
May 27 to June 3	- - - - -	+ ½ "

The time of this clock is by telegraph transmitted twice per day from the Royal central telegraph station to all public offices in Bavaria. Above rates are certified to by

wheels, aggregating 40 horse-power. It has received first prizes at ten international and eleven national exhibitions (1892 highest award at Paris, viz., the *Diplome d'honneur*).

(Series to be continued.)

**Meriden Prize Cups at the Fair.**

ONE of the many features of the exhibit of the Meriden Britannia Co., in Section N, Manufactures building, is the display of gold and silver plate prize cups,



PRIZE CUP IN WORLD'S FAIR EXHIBIT OF MERIDEN BRITANNIA CO.

Zimmermann and C. Beringer, of the Royal chief post office at Munich, under date of June 3, 1893. A paper on the rate of this escapement and pendulum was read by Dr. Leman, professor of the German Imperial Institution, Berlin, before the Astronomical Congress, which convened in Chicago on Aug. 21st.

Mr. Riefler informed the representative of THE CIRCULAR that the firm was established in 1841, and possesses four establishments worked by two turbines and two water-

two specimens of which are illustrated herewith. The cup shown on this page is gold inlaid and gold lined, and can be furnished emblematical of any event. It stands 14 inches in height and its price is \$250. The trophy depicted on the opposite page is 22½ inches in height, and is gold inlaid and gold lined. Its price is \$375.

These cups are prepared for every class of sport, yachting, rowing, bicycling, tennis, hunting, baseball, horse racing, archery, etc., and range in prices from \$400 to \$6.

**Colonial Relics at the World's Fair.**

(Continued from page 25, Sept. 13)

AMONG the antiques in jewelry displayed in the cases of the Colonial Board of Lady Managers, in the rotunda of the United States Government building, probably the most attention is given to an amethyst necklace of stones of uniform size, each ½ x ¾ inch, set in gold. A necklace similarly set with ¾ x 1 inch stones, with star pendant, has earrings to match formed of two stones, the lower pear shaped. Both were worn by Miss Ann Owen, granddaughter of Colonel Cresap.

A gold fob chain a foot long and an inch wide, with a medallion at each end and one in the center connected by a four-strand chain, is exhibited with articles that once belonged to Peter Francisco, the celebrated giant, who killed singlehanded and alone, eight of Tarleton's cavalry after the battle of Guilford Court House, N. C. Mrs. Luke Barbour in 1660 wore bracelets two inches wide, of floral design in yellow gold and set with topaz. A moss agate ring in heavy gold setting over two hundred years ago graced the finger of Betty Martin, grandmother of Wm. Paca, Governor of Maryland and a signer of the Declaration of Independence. The seal of the Summerville family was a heavy, richly chased gold fob charm of a lyre standing on a heavy gold base. John Carvan hands down through generations a stone ring encircled with small pastes. Two hundred years old is a glass faced gold locket containing a flower design made of hair.

Specially valuable from an historical standpoint is a gold wire ring of unusual size worn by John Hancock when he signed the Declaration of Independence. The ring is a single, small gold wire twisted at intervals of ¼ inch. Silver oval link buttons, one engraved W, the other G, were worn by Colonel Gibbons during the Revolutionary war. A small silver vinaigrette, also belonging to Colonel Gibbons, is 150 years old. A pearl ring in heavy gold setting was presented to Martha Washington in 1783. It has a small pearl in a gold setting on a small circle of blue enamel; around the enamel is a polished gold circle and outside of this a circle of sixteen small pearls. Rev.

ONE OF THE BEST OF THE VERY BEST.

QUALITY IS THE STANDARD OF VALUE.

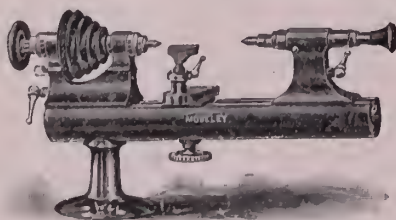

MEN INTERESTED WRITE YOUR JOBBER OR

MOSELEY & CO., - - - ELCIN, ILL.



HAS LENGTH, STRENGTH, ACCURACY.

**THE PLANCHAMP & BECKER CO.**

Makers and Repairers of

**WATCH CASES,**

Gold and Silver Plating —

— of Watch Cases a Specialty.

UNEXCELLED FACILITIES.

63 and 65 East Washington St., Chicago.

**PARSONS : SCHOOL**

— FOR —

**WATCHMAKERS,**

PEORIA, - - - ILL.

Send for Circular and Terms.

PARSONS & CO.

George Duffield, chaplain of the Continental Congress, faced that august body wearing on his breast a gold badge two inches square—an American eagle on a mount of gold.

The Charter Oak contributes a huge breast-

In connection with these antiques it is interesting to note a quaint old English double cased verge that lies on the desk of Dan Stevens, he of good old colonial stock, who represents in Chicago, the Bay State Watch Case Co., Columbus building. This

is known as a Hancock watch and is especially valuable for being accompanied by a manuscript letter of date May 9, 1729. Mr. Hancock, it may be said, was a great uncle of Governor John Hancock, of Revolutionary fame, who was president of the Continental Congress and the first signer of the Declaration of Independence, July 4, 1776. The timepiece is over one hundred and sixty-four years old, and is of peculiar structure, with silver dial, and is nearly as thick as wide. Two circles on the dial mark the minutes and hours, the former being indicated on the outer circle in Arabic figures, and the hours on the inner in Roman numerals. In the center of the dial above and below the hand

post are engraved scrolls with the words "Smith" and "London." The hands are of hammered iron. With the watch came some written directions of which the following is a copy:

"Some directions to keepe a watch viz: observe to wind it up once in 24 ours viz: keep a Sertin our and keep the our limmeted and if thou should find in any Time that it has gained or lost time thou may turn the hands Either Back or forward till wright viz: thou Must Put the key on the Squair the hands Goses on, and turn them they will both Go by turning the Squair and if it should go to fast observe in the movement and thou willt see an index with a squair in the middle Put the key on that and turn it against the sun makes it Go slower but if to slow turn it with the sun makes it Go faster but obsearve to turn it but a littell at a time for one degree alters it considerable so hoping thy watch will answer thy End I conclude thy Friend—

"ELIJAH COLLINS."

On the back of the foregoing directions is the following note, viz:

"Received This watch By my Brother Solomon Hancock the 9 May 1729. He and my Honoured Mother coming To the Vineyard—Pretium £16 : : d 00 : : s 00."

Thus it appears the watch originally cost nearly \$80 and that it came from a Quaker dealer in watches in London, where it was made by James Smith over one hundred and sixty-four years ago. Attached to the watch is a silver chain and brass key, both very peculiar. Mr. Stevens secured the watch about eighteen years ago from a lineal descendant of the Hancocks in exchange for a \$30 modern timekeeper.



PRIZE CUP IN WORLD'S FAIR EXHIBIT OF MERIDEN BRITANNIA CO.

pin carved from its wood. A wedding suit in 1770 was buttoned with oval discs of solid silver, 1x1½ inches in size, engraved I. S. A pretty little snuff box of tortoise shell with hexagonal ends has an engraved pearl top with the letters M. B. in plain medallion in the center. It once belonged to Mme. Pulling, of Boston, whose husband, Major Pulling, hung out the lantern for Paul Revere in 1775. A chagreen case contains a pair of heavy silver bowed spectacles owned by Wm. Ellery, signer of the Declaration of Independence. The glasses are circular and the hinged temples terminate in rings an inch in diameter. Another pair of spectacles over 160 years old have glass of a greenish tint with flat surface, circular in form, set in very heavy iron frames with hinged temples.

Several pairs of paste shoe, knee and waist buckles are displayed which formerly adorned the persons of George Washington, Pierre Van Cortlandt, Nathaniel Davis and Oliver Wolcott. A simple steel balance with brass plates suspended by cords was used during the Revolution for weighing gold. The box is made of fish skin.

**JEWELERS.**

We guarantee to sell you Sterling Silver Flat Ware at a less price than any other manufacturer, and give you never designs. We will increase your profits if you will let us. Is it not worth trying?

**OVAITT & WARNER, Silversmiths, PORTLAND, OREGON.**

**DALE**

**CHUCKS.**



Manufactured by

**HOROLOGICAL TOOL CO.,**

**86 N. CLARK STREET,**

For Sale by all Jobbers

**CHICAGO.**

**IRONS & RUSSELL,**

(SUCCESSORS TO CHARLES F. IRONS.)

MANUFACTURERS OF

**SOLID GOLD EMBLEMS ROLL PLATE**

PINS, CHARMS AND SOLID GOLD RINGS.



102 Friendship Street, - - Providence, R. I.



**GIBSON HOUSE,**

**CINCINNATI, OHIO.**

**ABSOLUTELY FIRST-CLASS AMERICAN PLAN HOTEL. \$3.00 PER DAY.**

Extra Charge for Parlors and Rooms with Bath attached. The unequalled advantages in central location, liberal management, modern appointments, experienced service and perfect cuisine, have permanently established the Gibson House as **The Most Popular First-Class Hotel in Cincinnati.**

AMPLE VAULTS FOR THE PROTECTION OF VALUABLES.

**THE GIBSON HOUSE CO.,**

**H. B. DUNBAR,**

President and Manager.

**Emperor William's Gold Casket.**

**E**XHIBITED in the pavilion of the Goldsmiths' and Silversmiths' Co., of

the Guildhall, July 10, 1891. The work was illustrated and described in the issue of THE CIRCULAR of July 29, 1891, but is worthy of being treated once more in connection with the World's Fair.



THE GERMAN EMPEROR'S GOLD CASKET, IN THE EXHIBIT OF MAPPIN BROS.

London, in the English section of Manufactures building, is the gold casket containing the address of welcome presented by the corporation of the city of London to His Imperial Majesty, the German Emperor, at

This specimen of contemporary goldsmiths' fine art work is one of the most instructive examples at the Columbian Exposition, and should receive careful examination from every student of art work in the

precious metals. With its variety of enameling, its delicate and intricate chasing and jewels, this casket presents one of the richest art metal achievements of the nineteenth century. The casket is of 18 karat Hallmarked gold, and its design embodies many features illustrative of the cordial relations existing between the German Empire and Great Britain. The cover consists of a framework of gold in which are set finely executed enamels in colors, of important views of the city of London—St. Paul's Cathedral, London Bridge, the Guildhall and the Tower of London being the most prominent. Cresting the cover is a beautiful figure representing the city, while at intervals around it are the Imperial German eagles executed in black oxidized gold. Under the center canopy, in the body of the casket, appear the Imperial arms, crown, motto and supporters of the German Empire, finely chased and enameled, the crown being set with diamonds. The subjects occupying the end panels are the marriage of Queen Victoria with the Prince Consort, and that of the German Emperor Frederick with the Princess Royal of Great Britain; and the shields surrounding the base bear the coat of arms of the different German principalities.

The casket was designed and manufactured for the corporation by Mappin Bros., a member of the Goldsmiths' and Silversmiths' Co., and was loaned by the German Emperor for exhibition at the Fair. Every visiting jeweler at the Fair, should examine this work.

# BAUME & CO.,

21 HATTON GARDEN, LONDON, ENGLAND,  
AND SWITZERLAND.

EXHIBITORS AT CHICAGO OF

## TOURBILLION CHRONOMETER WATCH,

WHICH HOLDS THE RECORD AT ROYAL OBSERVATORY KEW.

HIGH CLASS SWISS WATCHES, PLAIN AND COMPLICATED.

PATENTEES FOR SPLIT SECONDS CHRONOGRAPHS (Treble Action.)

AGENT FOR U. S., GEO. E. WILKINS, SYRACUSE, N. Y.

## Chicago.

Visitors at the rooms of the Chicago Jewelers' Association last week showed a large proportionate number from the west and south. The list follows:

Richard Miller, McPherson, Kan.; J. T. Brennan, Canton, O.; Will J. Hamilton, Franklin, Pa.; James Robinson, Helena, Mont.; Harry Yoste, Vicksburg, Miss.; Jas. S. Johnston, Kingston, Ont.; H. C. Pickrell, Mechanicsburg, Ill.; Edw. Reinel, Streator, Ill.; Chas. Holyland, Pittsburgh, Pa.; E. D. Goodrich, San Francisco, Cal.; A. Snavely, Harrisburg, Pa.; A. A. Pancake, Harrisburg, Pa.; J. O. Comstock, Clinton, Ia.; H. A. Hulett, Marshall, Mich.; H. C. Held, Grand Island, Neb.; B. Rombach, Paris, Tex.; Charles Otero, Pueblo, Col.; Jean Tack, Newark, N. J.; Paul Hohlfeldt, Escanaba, Mich.; Francis B. Falkner, Germantown, Pa.; F. Mink, Philadelphia, Pa.; John C. Joss, New Philadelphia, O.; J. J. Hoffman, St. James, Minn.; Thos. A. Ladson, Washington, D. C.; A. K. Jobe, Jackson, Tenn.; W. H. Gaines, Waterbury, Conn.; H. E. Morris, St. Louis, Mo.; Geo. W. Scherr, Philadelphia, Pa.; K. Smit, Pittsburgh, Pa.; M. Streng, Pittsburgh, Pa.; I. S. Harris, Pittsburgh, Pa.; F. D. Mears, Greenfield, Ia.; Samuel Kreidle, Mt. Morris, Ill.; L. Megede, Jr., Richmond, Mo.; J. F. Mielach, Beaver Dam, Wis.; J. P. Jackson, Owensville, Ind.; Will G. Smith, Cincinnati, O.; H. M. Stillson, Delhi, N. Y.; Henry Ford, Lafayette, Ala.; Jos. F. Reitz, Evansville, Ind.; Hermann Mayer, San Antonio, Texas; E. H. Bonnet, Zanesville, O.; F. H. Taber, Grand Lodge, Mich.; Wm. Sproesser, Watertown, Wis.; W. H. McCaw, Port Perry, Can.; E. A. Coddling, No. Attleboro, Mass.; Robt. D. Worrell, Mexico, Mo.; M. Dorenfield, Corsicana, Tex.; J. J. Hoffmann, Reynoldsville, Pa.; W. H. Knowles, Humboldt, Ia.; Chas. Kausch, Bath, N. V.; A. W. Smith, Hastings, Minn.; Mrs. M. C. Duhme, Cincinnati, O.; Miss Duhme, Cincinnati, O.; J. L. Ackerman, Monon, Ind.; S. W. Percy and wife, Ogdensburg, N. Y.; C. H. Ladd, New Richmond, Wis.; F. H. Bidgood, Grand Rapids, Mich.; Chas. Hutchinson, Indianapolis, Ind.; J. Wm. Tratt, Beverly, Mass.; Chas. W. Troughton, New York; M. L. Lindquist, Red Wing, Minn.; John C. Lowry, Philadelphia, Pa.; Joseph Harz, New Orleans, La.; Thomas Lawrence, Cleburne, Tex.; M. E. Miller, Newcastle, Wyo.; W. O. Sanders, Manly, Ia.; J. A. Maurer, Pilot Point, Tex.; J. F. Kiser, Fostoria, O.; J. H. Booth, Alton, Ill.; O. Ellwood, London, Ont.; A. Bernhardt, Mexico, Mo.; Geo. M. Geer, Providence, R. I.; Peter Lindenstruth, Pensacola, Fla.; D. A. Oberholtzer, Lorain, O.; L. A. Mahler, Raleigh, N. C.; P. W. Mahler, Raleigh, N. C.; A. B. Willson, Georgetown, Ont.; A. B. Kurtz, Confluence, Pa.; Edward Zoeller, Louisville, Ky.; J. W. Schrimp, Spirit Lake, Ia.; H. I. Oppenheimer, New York; Wm. Rosenberger, New York; D. J. Cole, Denver, Col.; E. B. Warren, New Haven, Conn.; S. R. Bishop, New Haven, Conn.; E. Untermyer, New York.

Visitors at the Fair are more numerous and buyers more plentiful. A general activity in jobbing houses, and at the Fair was participated in by

Geo. W. Harlow, Worcester, Mass.; J. H. Booth, Alton, Ill.; Geo. C. Hasslinger, Jackson, Mo.; John M. Hall, Liberty, N. Y.; L. A. Mahler, Raleigh, N. C.; F. Pieper, Covington, Ky.; Henry J. Cogswell, Hartford, Conn.; Geo. R. Cook, Madison, Wis.; H. C. Pickrell, Mechanicsburg, Ill.; A. Millbright, Ounalaska, Wis.; P. J. Jackson, Owensville, Ind.; Will G. Curley, Geneseo, Ill.; Will E. Mowrey, East Tawas, Mich.; E. M. Cox & Son, Seneca Falls, N. Y.; L. H. Fuller, Waterville, Minn.; C. B. Geer, Union City, Pa.; Alfred G. Wilber, New Bedford, Mass.; H. C. Hulett & Son, Marshall, Mich.; M. Wollman, Council Bluff, Ia.; J. T. C. Bronaugh, New Ross, Ind.; A. C. Johnston & Bro., Kingston, Ont.; Charles L. Paasch, Utica, N. Y.; Geo. W. Hickox, Santa Fe, N. M.; W. W. Bostwick, Demison, Tex.; L. E. Arnel, Holton, Kan.; W. F. Staley, Pittston, Pa.; B. H. Rounds & Sons, Owensboro, Ky.; Geo. H. Hewitt, Hartford, Mich.; R. H. Lee, Grand Rapids, Mich.; Richard Miller, McPherson, Kan.; L. B. Shoop, Streator, Ill.; S. E. Eichen-

laub, So. Chicago, Ill.; E. Culver, Mason, Mich.; Frank Bigelow Kennard, Boston, Mass.; John F. Carter Fort Dodge, Ia.; F. E. Schoenfeld, Sauk City, Wis.; A. A. Burbank, Rochelle, Ill.; J. C. Meyer, Jr., New Orleans, La.; J. C. McAnarney, Rockford, Ill.; Ben S. Dickman, Cincinnati, O.; F. H. Shearer & Co., Bay City, Mich.; Jos. E. Smith, Lockland, O.; D. A. Oberholtzer, Lorain, O.; R. L. Brown, Florence, Ala.; Louis Yoight, Jr., Roanoke, Va.; M. H. Douglass, Russiaville, Ind.; Powell Bros., Ft. Scott, Kan.; N. H. Knowles, Humboldt, Ia.; A. D. Ernie & Co., Cleveland, O.; David Bedell, El Dorado, Kan.; A. Backer, Syracuse, N. Y.; Frank Kind, Philadelphia, Pa.; C. A. Sterner, Allentown, Pa.; J. D. Daniels, Albion, N. Y.; F. W. Butler, Albion, N. Y.; M. Blumenstock, Luddington, Mich.; F. E. Penno, Mentone, Ind.; B. Garretson, Kenton, O.; Lavey & Son, No. Manchester, Ind.; J. A. Norton & Son, Kansas City, Mo.; J. Will Kirk, Adrian, Mich.; H. R. Groce, Washington, D. C.; E. A. Clark, Burlington, Ia.; H. N. Squire & Son, New York; Chas. B. Wilkins, Syracuse, N. Y.; J. L. Davidson, Mason City, Ill.; H. L. Carpenter, Minneapolis, Minn.; M. Eastland & Son, San Angelo, Tex.; Frank J. Marvin, Findlay, O.; E. J. Spall, Pittsfield, Mass.; Henry Metzger, Kansas City, Mo.; J. W. Battershall, Yankton, S. D.; O. P. Yager, Riceville, Ia.; Henry Peetz, with J. C. Woelfle, Peoria, Ill.; Charles Gumbiner, Elmwood, Ill.; John R. Hamer, Philadelphia, Pa.; C. H. Rodig, Cleveland, O.; C. W. Oviatt, Rochester, N. Y.; E. H. Goulding, Alton, Ill.; J. A. Schermer, E. Saginaw, Mich.; Harry Morris, St. Louis, Mo.; John H. Booth, wife and daughter, Alton, Ill.; C. S. Raymond and family, Omaha, Neb.; D. Goodin, McKinney, Tex.; O. K. Straight, Walla Walla, Wash.; Frank Le Bron, Keokuk, Ia.; T. H. Gill, Marengo, Ill.; John Stuart, England; John F. Sheets, Moffatt's Creek, W. Va.; Jos. Coleman, Massillon, O.; D. La Bent, Harrisville, Mich.; G. E. Rhodes, Kansas City, Mo.; E. R. Wight, Hewarden, Ia.; R. C. Hamilton, Keota, Ia.; Fred L. Steiner, St. Louis, Mo.; George McElwain, Englewood, Ill.; B. P. Richmond, Lansing, Mich.; Robert S. Milner, Philadelphia, Pa.; Geo. J. Nieberg, Akron, O.; J. L. Orendorff, Delevan, Ill.; J. H. Bade & Co., Arworth, Ga.; Otto J. Pfeiffer, Oxford, O.; Edw. F. Hirsch, Cincinnati, O.; H. Rogers & Son, Lake Geneva, Wis.; Will C. Klein, Connersville, Ind.; H. W. Hardie, Fennville, Mich.; H. F. Doan & Co., Blissfield, Mich.; J. G. Ruefly, Trenton, Mo.; A. C. Smith, Urbana, O.; R. G. Porter, Woodbury, N. J.; J. H. Cartwright, Dodgeville, Wis.; James Bourquin, Columbus, O.; J. W. Sparks, Sabina, O.; John W. Mahan, Brandenburg, Ky.; L. A. Van Ess, Milwaukee, Wis.; A. F. Hellebush, Cincinnati, O.; M. D. Kelly, Hopkinsville, Ky.; A. J. Clark, Dayton, Tenn.; L. M. Sinclair, St. Paul, Minn.; G. S. Bauder, Elburn, Ill.; H. Stouthamer, Milwaukee, Wis.; H. Snowden, Baltimore, Md.; Fred S. Bates, Baltimore, Md.; H. A. Dodt and wife, Cincinnati, O.; Mrs. J. Ronnebaum, Cincinnati, O.; Alex. Patterson, Philadelphia, Pa.; Hubert Zimmer, Poughkeepsie, N. Y.; L. M. Knepfly, Dallas, Tex.; T. R. Mundy, Dodge-

ville, Wis.; J. C. Andress, New York; H. A. Barrett, Pittsburgh, Pa.; G. M. C. Bartness, Clinton, Ind.; C. A. Eckert, Pittsburgh, Pa.; Wm. F. Meyer, Reading, Pa.; T. W. Clark, St. Cloud, Minn.; E. Maish, Grinnell, Iowa; Frank L. King, Goshen, Indiana; M. E. Oertel, Oskosh, Wis.; S. E. Elbe, Bloomington, Ill.; C. M. Braison, Lincoln, Neb.; J. A. Bills, Yinton, Ia.; W. O. Sanders, Manly, Ia.; R. T. Ferguson, Philadelphia, Pa.; J. Henry Yeager, Jr., Philadelphia, Pa.; D. J. Copeland, Marshall, Tex.; E. Fry, Belleville, Kan.; Mrs. F. J. Owen, Lincoln, Neb.; D. Goodin, McKinney, Tex.; F. A. Defield, St. Paul, Minn.; C. H. Ludlow, Dunkirk, N. V.; J. H. Kiser, Fostoria, O.; B. B. Hall, Baltimore, Md.; S. K. Fraser, Lincoln, Pa.; Ed. Sommerfield, Milwaukee, Wis.; Louis Wegener, St. Louis, Mo.; R. H. Perkins, Bridgewater, Me.; Geo. W. Scherr, Philadelphia, Pa.; Fred Studer, Coleman, Tex.; F. H. W. Bailey, Marquette, Tex.; O. Bechtel, Akron, O.; G. W. Clemmer, Akron, O.; Jos. Liberman, Philadelphia, Pa.; Louis Russell, Grand Rapids, Mich.; W. H. Hoyle, Sidney, O.; M. S. Darling, Trenton, Mo.; W. H. Snyder, Jr., Niles, Mich.; Walter A. Buck, Jackson, Miss.; F. E. Dumas, Mentano, Ind.; Bruce Blackburn, Hunnewell, Mo.; Robt. S. Heaton, Indianapolis, Ind.; Chas. M. Newbold, Belleville, Ill.; Fred. G. Hayner, Colorado Springs, Col.; A. C. Parno, Greene, Ia.; Z. K. Straight, Walla Walla, Wash.; Geo. L. Newton, Memphis, Tenn.; E. G. Weather Champaign, Ill.; Milton Kohler, Hagerstown, Md.; H. Hammersmith, Milwaukee, Wis.; M. P. Hurlbut and wife, Detroit, Mich.; Harry J. Levi, Cincinnati, O.; E. C. Woodruff, Nineveh, Ind.; Ike Manheimer, Cincinnati, O.; H. H. Schellberg, Kansas City, Mo.; E. A. Ludwig, Lexington, Mo.; St. Clair Fechner, Washington, D. C.; John M. Stinson, Camden, Ark.; E. W. Stone, Boston, Mass.; P. S. Wise, St. Charles, Ia.; H. L. Rost, Columbus, Ind.; E. J. Potter, Sherwood, O.; C. Osterle, Joliet, Ill.; Fred L. Webb, East Boston, Mass.; A. W. Golder, Rochester, N. Y.; F. J. Bischof, Detroit, Mich.; Geo. Essig, Plattsburg, Mo.; L. Megede, Jr.; Richmond, Mo.; Bert Barborka, Iowa City, Ia.; A. L. Lokperch, Tremont, Ia.; E. J. Cain, Lodi, Wis.; O. N. Ridgeway, Sheridan, Ind.; Will H. Rickaby, Belding, Mich.; J. M. Henry, Leamington, Ont.; C. D. Rutledge, St. Joseph, Mich.; D. A. Oberholtzer, Lorain, O.; Wm. Shibley, Wooster, O.; C. E. Pickens, Cloverdale, Ind.; H. C. Pickrell, Mechanicsburg, Ill.; John Brann, Two Rivers, Wis.; Henry J. Rosenstihl, Union Springs, Ala.; Dr. C. C. Hill, Meadville, Pa.; C. J. Williams, Columbus, O.; J. R. Jewel and daughter, Wauseon, O.; Geo. Young, Jr., Bellevue, Ia.; Kirby & Co., New Haven, Conn.; W. H. Wallace, Wingham, Ont.; R. M. Eisenlohr, San Antonio, Tex.; F. P. Fisk, Epping, N. H.; S. T. Parsons, Odebolt, Ia.; A. D. Miller, Braidwood, Ill.; Albert Wolf, Louisville, Ky.; Geo. S. Spaulding, Alexandria, Minn.; C. A. Seivers, York, Pa.; M. L. Kreamer, West Union, Ia.; I. S. Richter, New York; W. H. Bradshaw, Paris, Ill.; R. Heuldebrand & Son, Nashville, Tenn.; A. Patterson, Omaha.

## MARTIN MAYER, Manufacturing Jeweler, (MAINZ, Germany.)

FACTORIES: MAINZ, PFORZHEIM, FLORENCE, (ITALY).

Original Manufacturer of the well-known Cut Silver Articles.

*Silver Filigree, Coral Goods, Garnets, Turquoise, Pearl, and all other kinds of Jewelry. Silver Bric-a-Brac in Every Style, Silver Fancy Clocks, Souvenir Spoons.*

FIRST HAND FOR EUROPEAN NOVELTIES IN THE JEWELRY LINE.

SPECIAL EXHIBIT AT WORLD'S FAIR, CHICAGO.

New York Office, with L. Mainz, 523 Broadway, New York.

# OTTO YOUNG & CO.

WHOLESALE ONLY.

Diamonds, Watches, Jewelry, Silverware, Tools and Material,

◁ OPTICAL GOODS, ETC. ▷

149, 151 & 153 STATE ST., CHICAGO, ILL.

WE will soon issue our new Illustrated Catalogue. It will be sent by Express or mail, prepaid, to all legitimate Jewelers, in territory tributary to Chicago. It will contain a full line of all staples and novelties required by Watchmakers and Jewelers. The goods are right and the prices uniformly low, and we trust to receive frequent orders from you for goods selected from its pages.

**IF YOU DO NOT RECEIVE A COPY OF SAME, ADVISE US.**

In addition to our regular stock, we have a large line of discontinued American made watch movements, in 18, 16 and 6 size, which we offer at greatly reduced prices and we will be pleased to write you fully regarding same, upon application.

## REED & BARTON,

**SILVERSMITHS,**

MANUFACTURERS OF

STERLING *and* SILVER PLATED  
SILVER *and* WARE.

SALESROOMS:

37 Union Square, New York.

34-36 WASHINGTON STREET,

**Venetian Building, Chicago.**

FACTORIES, CAUNTON, MASS.

ESTABLISHED 1879.

G. W. HOOK,

MANUFACTURING JEWELER,

149 and 151 State Street, Chicago, Ill.

INSPECTION BY THE VISITING TRADE INVITED.

Sightseeing for ten days was the avowed object of a visit to the city by Frank H. La Pierre, New York.

Sunday week E. B. Warren and S. R. Bishop, of the New Haven Clock Co.'s home office, arrived here for a two weeks' outing at the Fair.

Manager Paul Fueslein, of Bawo & Dotter's Chicago show rooms, 75-77 Lake St., reports trade picking up and prospects better than for some time past.

President O. F. Thomas, of the Manhattan Silver Plate Co., left Chicago early last week after spending a week at the Chicago office of the company and at the Fair.

A. G. Clark, 481 W. Madison St., has discontinued his store at that number, and removed the wares to his place of business on Lake St., which he will run with enlarged stock.

Mr. Seidl, the celebrated German manufacturing optician, has notified his American agents that he is on his way to this country and is expected in Chicago the present week.

S. K. Huston, Chicago manager for the Columbus Watch Co., smiles over the arrival at his home of a twelve pound boy. The father is doing well, likewise the mother and child.

J. H. Nightingale has recovered from the effects of a severe cold which at one time threatened serious results, and resumes his duties as a partner in the H. B. Bolstad Plating Co., 170 Madison St.

Chicago Spectacle Co., of Chicago, have incorporated with a capital stock of \$10,000 for the manufacture of optical goods. Incorporators: H. W. Duncanson, Andrew Christianson and D. A. Avery.

Charles Emile Tissot, member of the jury on horology, on his departure was met at the depot by the Swiss Mannerchor of Chicago, who sung their farewells. M. Tissot was much affected by this testimonial of friendship.

When a political party wins, the organs of the party display headlines of roosters. B. & W. B. Smith, in commemoration of their signal victory at the World's Fair, in competition with the world, have placed on their invisible joint show cases the same insignia of conquest.

H. P. Keller, of L. H. Keller & Co., New York, spent a week at the Fair and returned via Niagara Falls. L. H. Keller & Co. are general American agents for the Patek, Philippe & Co. watches, and Mr. Keller was an interested visitor at the pavilion of the firm in Manufactures building.

A. G. Schwab & Bro., Cincinnati, were last week represented socially in this city by Will G. Smith, who returned Thursday to continue his trip in Kentucky, Tennessee and Georgia, and Jas. W. Baker, who returned home despairing of completing the Fair, after three days spent in the effort.



Mr. Sillocks, of Reeves & Sillocks, New York, and wife, spent the past week at the Fair.

Mr. Hennege, of Hennege, Bates & Co., Baltimore, Md., is in the city accompanied by his wife.

George W. Scherr, of L. A. Scherr & Co., Philadelphia, wife and son, are stopping at the Hotel Lafayette.

Manager G. A. Jewett, of the Chicago branch of New Haven Clock Co., returned last week from a short business trip to St. Louis.

F. H. Chapman, of the Hartford office, and wife succeed Fred J. Hall and wife in charge of the World's Fair exhibit of the Wm. Rogers Mfg. Co.

Dials for the Illinois Central depot tower clock have been placed and the clock will be running in a few days. It is of Seth Thomas make, a Denison double three-legged gravity escapement and compensating pendulum, and is one of the finest turned out by the factory. Walter J. Buckley, the tower clock man of the Seth Thomas western office, is superintending the work.

An attractive piece of work in clock architecture was received the past week at the Chicago salesrooms of the New Haven Clock Co., 211-213 Wabash Ave. The piece was shipped from the factory July 3d, and was lost two months in transit. The clock is a representation of the Administration building at the World's Fair, 22 inches square at the base and 28 inches in height to the top of the staff surmounting the dome, and is correct in all its details. It is in antique oak finished with gilded dome and corner cupolas. The sides of the visitors' gallery are of glass and show the movement within. The movement is one of the company's finest, and Canterbury chimes are struck on eight bells. It has a silver dial, which is placed in the center of the second story on the front of the building.

#### Detroit.

Henry Koester, of Kennedy & Koester, spent last week at the Flats.

Burt & Hurlbut Co. expect to shortly resume work in their plush box manufactory, with full force.

T. J. Commerford, manager and secretary of the United States Optical Co., is confined to his room by illness.

Charlie Morrison, buyer for F. G. Smith, Sons & Co., is in Chicago for a two weeks' stay. Henry Binder, J. Teichner and Martin Burk, with the same firm, returned from Chicago last week.

Charles A. Piella, of Lansing, writes THE CIRCULAR correspondent that all hopes of recovering the \$1,600 worth of diamonds recently stolen, has been given up. The reward of \$300 has been withdrawn.

Dispatches to Detroit papers from Grand Rapids, state that pearls of very good

quality have been found in Grand River between that city and Grand Haven. Hundreds of people are searching the river bed.

Business with the jobbers last week increased steadily over the previous period. Mail orders were uniformly good. The following Michigan country buyers were in the city: William Walthers, Wyandotte; William H. Ambler, Northville; A. W. Kludt, Lennox, and J. W. Tucker, Delray.

#### Cincinnati.

Jos. Goesling is in Michigan on a fishing trip.

Jos. Mehmert is taking in the World's Fair this week.

Ed Daum, of D. Schroder & Co., will soon join the ranks of the benedicts.

Ben Lambrecht, Clarksburgh, W. Va., stopped in Cincinnati on his way home from the World's Fair, and bought some goods for Fall trade.

A rumor that W. S. P. Oskamp is to retire from Oskamp, Nolting & Co. is untrue. Mr. Oskamp has grown up from a boy in the jewelry business, and says he would not feel as though he were existing if he were out of that.

Homan & Co. have been unusually busy the past week working full time and in two departments over-time. They have increased their force and will keep on putting on men as the season advances. Orders are rapidly increasing.

The firm of Clemens Oskamp has reorganized and W. H. Miller, a former insurance man, has been elected vice-president of the new company. It is understood that the concern will form itself into a stock corporation the first of the year.

It is reported from Lexington, Ky., that Alexander Prather, a negro wanted at Junction City for burglarizing a jewelry store there, has been arrested with a lot of goods in his possession. Prather has a partner in Richard Bryant, who it seems has been doing the selling for Prather. He has also been locked up.

Messrs. Oskamp and Michie, who represent the Board of Trade of Cincinnati, at the Washington Business Men's Convention last week have returned, confident that the meeting accomplished something. They report that it was the most representative gathering of leading commercial interests of the United States that ever convened, the attendance numbering two hundred among whom were many of the ablest speakers on finance.

A pivot adjusting tool said to be one of the best ever manufactured, is offered the trade by A. J. Logan, Waltham, Mass. By its use the removal of the hairspring from the balance is unnecessary, and the pivot is polished perfectly. Mr. Logan's new catalogue will be sent to any jeweler upon application.

## RECEIVER'S SALE.



ENTIRE Stock of **Giles, Bro. & Co.** Fourth Floor Masonic Temple, consisting of Diamonds, American and Swiss Watches, Jewelry, Silver and Plated Ware, Tools, Materials, etc. will be sold in lots to suit the purchasers, at large reduction from original cost price.

An unusual chance for live Jewelers to obtain bargains.

W. H. GLEASON, Receiver.

July 14th, 1893.



**KETCHAM & McDOUGAL,**  
MANUFACTURERS  
GOLD & SILVER THIMBLES,  
GOLD COLLAR BUTTONS,  
AUTOMATIC EYE-GLASS HOLDERS,  
198 BROADWAY<sup>1</sup> N. Y.

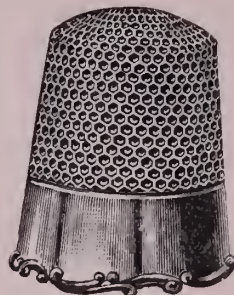

**Minneapolis and St. Paul.**

J. R. Elliott, Minneapolis, is having a 33 1/3 per cent. discount clearance sale.

Mark Streicher, of M. Streicher & Co., Chicago, was in Minneapolis on business last week.

E. I. Rogers, of Parks Bros. & Rogers, Providence, called on the Twin Cities' jobbers the past week.

B. B. Marshall & Son, Minneapolis, are still conducting their daily auction sales and contemplate continuing the same until their entire stock is sold.

E. A. Hall, representing the Manhattan Silver Plate Co., and the Holmes & Edwards Silver Co., called on the Twin Cities' retail jewelers the past week.

The cloth in the show window of Benjamin & Co.'s store, Minneapolis, was set on fire by the heat of the sun last Tuesday and the blaze did considerable damage before it was extinguished.

William H. Breen, 377 Wabasha St., who made an assignment last week to William L. Kelley, Jr., as reported in THE CIRCULAR, has assets estimated at \$1,600 and liabilities estimated at \$2,600.

F. O. Fisk & Co., Minneapolis, are conducting the jewelry display stands at the Minneapolis Industrial Exposition which opened on the 6th inst. and which will close Oct. 7th. They have two fine stands, well stocked and report sales fair.

A dispatch has been received from Moorhead, this State, that Chris. Anderson's jewelry store was robbed of \$150 worth of jewelry by James Irwin, who knocked in a glass pane in the front door. An officer noticed that the light was out and went in and found Irwin hiding behind the stove. The officer held him until Anderson came, when he was placed in jail. Irwin was released from Stillwater two years ago on a life sentence for murder.

**Omaha.**

J. C. Stanley, of the Meriden Silver Plate Co., was in this city last week.

W. A. Mandelberg has opened his new store corner 15th and Farnam Sts., and reports more business than he expected. Having been twelve years with Max Meyer & Bro. Co., he has gained many friends.

J. E. Ponder, who has been all Summer at the World's Fair in charge of optical displays there, has returned to Omaha and taken charge of the optical business started by him and which he left in charge of an agent during his absence.

A tiny wooden box in the window of A. B. Hubermann bears the revenue stamps for \$15,000 worth of precious stones which Mr. Hubermann has just sent over from Hamburg, and the stones are carelessly strewn about the box for westerners to feast their eyes on.



**Centennial Timers.**



These Watches are one-third larger than above cuts.

**CROSS & BEGUELIN,**  
Manufacturers, Importers and Jobbers of  
Watches, Diamonds, Jewelry, Watch Materials, etc.,  
17 MAIDEN LANE, NEW YORK.

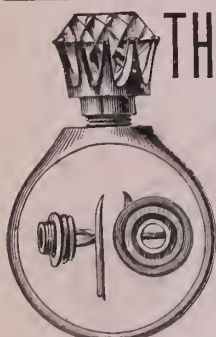

**THE BONNER COMBINATION**  
RING, SCARF PIN AND STUD.

The Best Combination ever made.

MANUFACTURED BY

**BONNER, RICH & Co.,**  
Makers of DIAMOND MOUNTINGS  
RINGS A SPECIALTY.

To the Jobbing Trade Only.

41 MAIDEN LANE, NEW YORK.  
Factory, 44, 46 and 48 Hill St., Newark, N. J.



**Paul Jeanne,** EIGHTEENTH STREET and 4<sup>TH</sup> AVE., N. Y.  
(Bradley Building.)

MANUFACTURER OF

≡ FINE ⊗ DIAMOND ⊗ JEWELRY. ≡

**MUELLER'S ARTIFICIAL EYES.**

\$75 per hundred; smaller lots, \$10 per dozen; \$2 each. A large assortment of eyes will be sent to any dealer to enable him to make selection, upon receipt of satisfactory references. We carry the largest stock in America.

ONLY MANUFACTURERS OF THE "DIAMANTA" SPECTACLES AND EYE-GLASSES.  
Oculists' prescriptions promptly and accurately filled. Catalogue, price lists, test cards, etc., on application.

M. ZINEMAN & BRO., American Agents, 130 South Ninth St., Philadelphia.



**Regarding the Sale of Goods by Foreigners at the World's Fair.**

CHICAGO, Ill., Sept. 16.—The Federal Courts have been called on by the attorney for the Exposition to decide on the sales of goods by foreigners at the Fair. Judge Dunn issued an injunction restraining the Exposition company from interfering with the sale of articles manufactured by the French tradesmen.

The order was made on a bill filed in the Circuit Court by J. P. Victor Hunolt and Jean Truson in behalf of all the French exhibitors, numbering 250, whose property is worth \$5,000,000. The complainants assert that the Exposition company is insolvent and that their grievances cannot be remedied by judgment.

The Exposition management has declared that the exhibitors have no right to sell the articles manufactured by them, without paying for the privilege. If this is not paid for, the bill recites, the Exposition officials propose to confiscate the goods. Attorney Edwin Walker, counsel for the Exposition, in order to get the matter before the United States Circuit Court for the purpose of having the restraining order set aside, filed an intervening petition in behalf of three non-resident defendants. A transcript of the Circuit Court proceedings will be taken to the Federal Court, and the case will come up in a few days.

On the 12th inst. Rudolph Vincent and J. P. Victor Hunolt, parties in the above case, filed a bill for trespass in the Superior Court, laying damages at \$15,000.

**The Business of F. E. Morse & Son Discontinued.**

CHICAGO, Ill., Sept. 18.—Lewis, Kaiser & Luthy, New York, in a County Court bill requested that the order for continuance of the business of F. E. Morse & Son and Morse, Mitchell & Williams be rescinded, that the premises be vacated, help discharged, fixtures disposed of and assets deposited in a safety deposit vault.

In pursuance of an order from the court, Assignee Gary has discontinued the business of F. E. Morse & Son. Morse, Mitchell & Williams continue as formerly under the assignee.

**An Alleged Jewelry Store Burglar Comes to Grief.**

BALTIMORE, Md., Sept. 13.—Early this morning William C. Guerth, jeweler, 609 E. Baltimore St., discovered that his show window had been smashed and a lot of jewelry valued at \$85 stolen.

The police received information that some of the stolen jewelry had been sold at Harrison St. and Marsh Market space. Two

officers detailed on the case came up later with a tough looking young man on Pratt St., offering more of the valuables for sale. The individual was arrested, and locked up for a hearing. He gave his name as George Ensor.

**This Thief Used His Cane as a Hook to Catch Jewelry.**

JERSEY CITY, N. J., Sept. 14.—Richard Schaller, jeweler, at 211 Bergen Line Ave., Union Hill, was robbed yesterday afternoon of a solid gold chain worth \$75. Two well dressed young men entered his store at 3.30 o'clock. One of them produced a watch which he handed to Mr. Schaller, with a re-

quest that he fit it with a crystal. To reach the tray containing watch crystals the jeweler was obliged to stoop so that his head passed below the counter. His eyes were off the young men only an instant. Mr. Schaller quickly replaced the broken crystal and the young men paid him and left the store.

Soon after their departure the jeweler discovered that a heavy gold watch chain, which he had placed on his repair table at the rear of the counter was missing. The thief must have hooked it out with a cane, there being no other way for him to reach it, as a tall wire grating guarded the counter at that point.

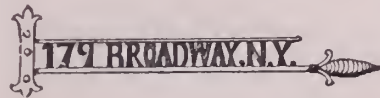
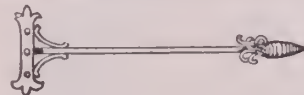

**Larter, Elcox & Co.**  
Manufacturers of Fine Gold Jewelry  
21 & 23 Maiden Lane, New York.



— WE ARE READY FOR THE FALL TRADE. —

**Rings, : Seals, : Spring : Back : Studs.**

GENTLEMEN'S WHITE ONYX BUTTONS AND STUDS.

**J. H. DEDERICK, JR.,**  
— DEALER IN —  
**Roll Plate Jewelry and Chains,**  
Optical Goods and Jewelers' Supplies,  
**16 MAIDEN LANE, NEW YORK.**  
JET GOODS A SPECIALTY.

**SOLICITORS OF AMERICAN & FOREIGN PATENTS**  
FOR DESIGNS, INVENTIONS, TRADE MARKS, SEARCHES MADE & INFRINGEMENT PROSECUTED OR DEFENDED.  
THE TRADE WILL SAVE TIME AND MONEY BY HAVING THEIR PATENTS TAKEN BY  
**COX & SONS 11 PARK ROW, N.Y.**

**We Have Removed to**  
**57 MAIDEN LANE.**  
**LEONHARDT & CURRAN,**  
MANUFACTURERS OF DIAMOND MOUNTINGS.

**ETCHING TAUGHT FOR \$10.**

Having received numerous requests for our formulas in silver etching, we have decided to give individual instruction to those desiring to do their own work and save delay and shipping expenses. Jewelers can take advantage of this offer while visiting the Fair. Printed formulae and practical instruction in their use will be given where time is limited. Refer to any jewelry firm in Chicago. All kinds of etching done for the trade.

**LYMAN & CO.,** ETCHERS AND ENGRAVERS, 96 State Street, Chicago.

H. B. BOLSTAD, J. H. NIGHTINGALE,  
WATCH CASE MAKERS AND REPAIRERS,  
**H. B. Bolstad Plating Co.**  
GOLD AND SILVER PLATERS.  
DESIGNING AND ENGRAVING.  
170 Madison Street, CHICAGO.

**Connecticut.**

The New Haven Clock Co.'s main factory is running again in all departments.

Wm. S. Ingraham, Bristol, returned from the World's Fair feeling ill and is threatened with fever.

The stock in William Lambert's jewelry store, in Birmingham, which he recently sold, has been removed and Mr. Lambert has retired from the business.

The Holmes & Edwards Silver Co.'s factory, Bridgeport, began last Monday to run six days a week with a full force of between 300 and 400 employes. The company have a large number of orders on hand.

L. S. Knoek, pawnbroker of Hartford, has bought out the stock and fixtures of Herman Gerwich, watchmaker, clock dealer and jeweler, at 342 Main St., that city, and will conduct a similar business at the same stand.

Peter Kier, employed by Blair & Coxeter, Hartford, has been missing since two weeks ago last Sunday. There is a suspicion that he was drowned. Kier is a single man, about twenty-six years old. He has been working for Blair & Coxeter for two years.

Col. Leavenworth, of the R. Wallace & Sons Mfg. Co., Wallingford, and his wife left for the World's Fair Sept. 13th. Mr. and Mrs. George M. Curtis and Mrs. George R. Curtis, of Meriden, left for the Fair Sept. 12th. Henry Kohn and wife, and Albert M. Kohn and wife, all of Hartford, left for the Fair Sept. 12th, and C. W. Goodwin, late a jewelry merchant of Torrington, has also gone to the Fair. Jeweler C. H. Case, wife and daughter, of Hartford, left for the World's Fair Sept. 13th. Gen. Geo. H. Ford and wife, New Haven, have returned from the Fair and an extended trip in the west.

**Louisville.**

Mr. and Mrs. W. C. Kendrick are in Chicago.

S. S. Lieberman has returned from a visit to the World's Fair.

Traveling salesmen in Louisville, recently were J. M. Cohen, Levy, Dreyfus & Co.; Mr. Stanborough, Carter, Sloan & Co.; Joe Beach, Wilcox Silver Plate Co.; Mr. Marx, Falkenau, Oppenheimer & Co.; Mr. Ashton, Kent & Stanley Co.

**Springfield, Mass.**

Mr. and Mrs. F. A. Hubbard have gone to the World's Fair.

E. J. Spall, manager of the Edwards jewelry store, Pittsfield, has left for the World's Fair.

David Mayer, of Hartford, presented a \$50 diamond to the Bicycle Club to serve as a prize.

L. B. Coe and F. A. Hubbard have been admitted to membership in the Board of Trade.

W. J. Brecknell, of this city, lectured in Holyoke one evening last week on the "History and Antiquity of Engraving."

In Judge Bosworth's ruling in the watch club cases of Thomas C. Daly and Thomas J. Fitzgerald, each was fined \$100, last week, but they appealed and furnished bail of \$200 each.

George P. Horne, once a Springfield jeweler, later an absconder from Nashua, N. H., and more recently an inmate of the county jail at Anamosa, Ia., was released from that institution last Thursday.

**WALTHAM REPEATERS**  
STRIKING HOURS AND MINUTES.

TO THE TRADE:—

Having purchased the entire remaining stock of WALTHAM REPEATING MOVEMENTS from the American Waltham Watch Co., and cased them in 20 year 14k. Cases, I am prepared to sell them at prices 30 per cent. less than they have ever been offered before.

Artistic Special Catalogue Free. Send for Prices and Terms.  
**JOHN B. YATES,**  
21 & 23 MAIDEN LANE, NEW YORK.

**BLANCARD & CO.,**

LATEST ROCOCO DESIGN IN GALLERY.



DIAMOND SETTINGS. GALLERIES. HOLLOW BALLS, ETC.

SEND FOR OUR CATALOGUE.

45 & 47 John St., New York.

EST. 1870. **DR. PETER HENRY,** SPECIALIST IN WATCH • CASE • DISEASES

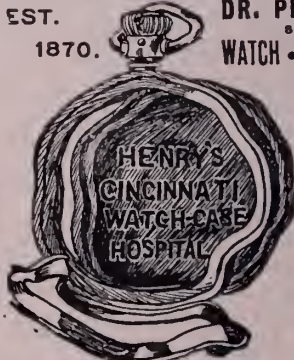

Key Winders - changed to Stem Winders.  
Hunting Cases changed to O. F.  
English Cases changed to fit American movements  
Can be cured at 53 • Longworth St., Cincinnati, Ohio.

NEW! IMPROVED NEW!  
Adjustable "Eclipse" Eye Glasses.

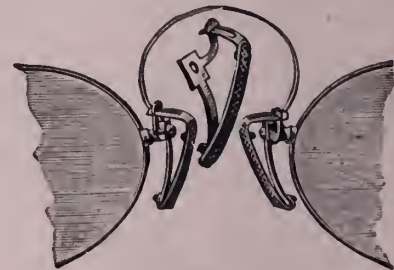

PATENT APPLIED FOR.

We claim this invention to be the only one which combines the advantages of both the adjustable and offset guards. We will furnish these frames or guards by Sept. 1st, in either Zylonite or Cork.

WRITE FOR CIRCULAR.  
**JOHN SCHEIDIG & CO., SOLE AGENTS**  
43 MAIDEN LANE, NEW YORK.

No jeweler or watch repairer should be without a copy of "WORKSHOP NOTES," a new and very useful book for the workshop. Send for circular containing a complete index of the book, and judge of its merits for yourself.

**Points of Law.**

**RIGHTS OF RECEIVER.**

A receiver appointed by a court of record of another State to take charge of the business of a partnership there and wind up its affairs may take charge of the property of the firm in this State, but in such case there is a mere substitution of parties, and the receiver has no greater rights in such property than the parties themselves.

*Ogden v. Warren, Supreme Court of Nebraska.*

**AGREEMENT TO RELEASE MORTGAGE.**

An agreement by a mortgagee to release his mortgage whenever it should appear that the one personally liable on the mortgage debt would suffer loss unless the same were released does not entitle the latter to a release because the mortgage is about to be foreclosed, since he could not be said to suffer a loss by a foreclosure.

*Irvine v. Brown, Supreme Court of Illinois.*

**PARTNERSHIP AGREEMENT TO PAY INTEREST.**

A provision in a contract between partners whereby an adjustment of past accounts should be had, in order to make a rest in the affairs of the firm to furnish a basis for future accountings, is no consideration for another provision in the contract whereby each agrees to pay the other interest on his monthly balances from the time they first engaged in business up to date of such contract.

*Smith v. Knight, Supreme Court of Iowa.*

**REDEMPTION OF MORTGAGE.**

Where the mortgagee pledges the note and mortgage to secure a loan, and the pledgee forecloses the mortgage, making the mortgagee a party defendant, and obtains a decree foreclosing the rights of all the defendants, and the pledgee buys the property at foreclosure sale, and obtains a deed therefor, he holds title free from any right of redemption on the part of the mortgagee.

*Anderson v. Olin, Supreme Court of Illinois.*

**LIABILITY OF SELLER FOR FREIGHT CHARGES.**

When the vendor of goods delivers them to the railroad company to be carried to the purchaser, though the title may pass to the purchaser by such delivery, and the name and address of the consignee, who is the purchaser, may be known to the company, the vendor is presumed to make the contract for transportation on his own behalf, and is liable for the freight; but such presumption may be rebutted by evidence showing that it was understood that the consignee should pay the freight.

*Union Freight Ry. v. Winkley, Supreme Court of Mass.*

**A NOVELTY FOR  
BICYCLE AND DASHBOARD.**

PRACTICAL.

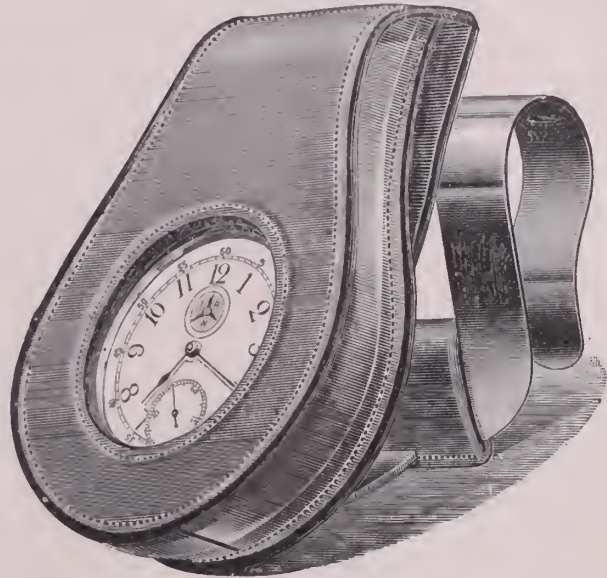

RELIABLE.

**A. WITTAUER,**

Manufacturer and Importer,

**19 MAIDEN LANE,**

**NEW YORK.**

**THE PERFECT COLLAR BUTTON,  
"THE BENEDICT."**

PATENTED AUGUST 17TH, 1886.

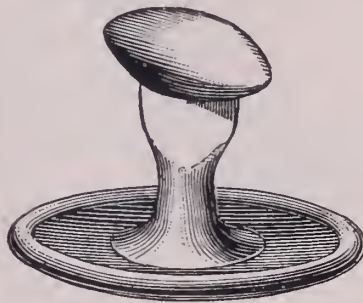

Having secured the sole right to manufacture the above buttons, they are now offered to the trade in

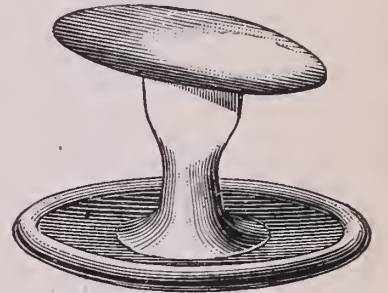

14 Kt. Gold, 10 Kt. Gold, Sterling Silver and Rolled Plate.

**ENOS RICHARDSON & Co.**

23 MAIDEN LANE, NEW YORK.

**THE IMPROVED RIVAL FOUNTAIN PEN.**

**MOST RELIABLE AND GUARANTEED TO GIVE PERFECT SATISFACTION. OVER 75,000 IN USE.**

Send for Price List.



Liberal Discounts to the Trade.

**D. W. BEAUMEL,**

Inventor and Manufacturer, REPAIRING A SPECIALTY, 17 John St., New York.

**WATERMAN & LEHMANN,**

MANUFACTURERS OF

**DIAMOND JEWELRY**

AND DEALERS IN

**DIAMONDS,**

No. 37 MAIDEN LANE,

NEW YORK.

**What is Parity?**

THE following signed "Dreamer" appeared in the Brooklyn *Eagle* of a recent date in the form of a communication. We suspect that Dreamer is known very intimately to W. W. Stewart, with Mabie, Todd & Bard:

Many citizens of Brooklyn when closing their residences for the Summer provide a home for their dogs, but abandon their cats. The poor animals are at first astounded, then alarmed, and finally become hardened and diabolic, to the disgust of those who must remain in town. My sleep being disturbed by a series of yells changing from the plaintive wail of an infant to the shriek of a Comanche, I dreamt that I was in Washington listening to a debate on the question of repealing the following bill:

A bill for the increase of domestic pets.  
*Whereas*, a great number of our people are poor and cannot afford dogs, while cats are more numerous.

*Resolved*, That we will make cats appear as valuable as dogs by act of congress, and it is established that the Secretary of the Treasury buy 3,000 cats a month and pay for them in orders which shall be payable in dogs or cats at the option of the Secretary;

but if dogs are called for and cats are refused, dogs must be purchased and paid out, otherwise a parity in the value of dogs and cats will not be maintained.

Member from the east—What's a parity? It seems all dog to me.

Member from the south—Where is Parity?

Another member—Parity is only suspected, not convicted. He will be here later.

Member from the west—Mr. Speaker, President Cleveland was well liked by the people; for this reason we chose him as a standard bearer for the parity banner, and if he goes back on parity we will go back on him.

Member from the west—What's the matter with the cats?

Member from the south—The cats are all right, but who wants them?

Member from the east—Don't buy any more and go home. The city will fill up after this month and the cats will take care of themselves.

This command or advice seemed to quiet the parityites and there was a calm, when all of a sudden my dream changed, and I was in the emporium of a silversmith. There were large stocks of solid silver forks and

spoons, beautiful ornaments and articles in cases, which, I was informed, were for wedding or birthday presents and the like. The silversmith explained that on account of its comparative cheapness, as contrasted with gold, people of moderate means could afford solid silver table ware and other articles of comfort and beauty of design, and the manufacturer kept up a parity between gold and silver by demanding gold or its equivalent in payment for his wares.

"Why would it not do to make silver into money?" I asked.

"It is now made into money," he answered, "but fortunately for the people the speculators cannot force up the price, if they did it would disappear, both as money and as silverware, as the one would be represented by paper notes, and the other would be too expensive for the people; consequently, less of it would be used."

"Why could not lots of small or subsidiary coins be made so the small towns and villages could have plenty of it?" said I. "If gold coins and notes were restricted to values not less than \$5, and this subsidiary coin made legal tender for \$4.99, then a great deal of it might be used, but the parity between gold and silver could not be maintained."

"What is a parity?"

"Parity and perfection are two words often quoted, but seldom realized. Where two persons, places or things are compared one of them has an advantage over the other in something."

"But," continued the silversmith, musingly, "why does not the poor man's friend begin at the beginning and coin mills? Ten mills make one cent, we are taught, and why are we taught it? Moneys make character. Republics must guard against the improvidence and discouragement of its citizens. One would hesitate about spending 50 mills where 5 cents is freely given, and 100 mills would cause a man to reflect where 10 cents does not. He would be more saving and would in time be one of my customers, and would thus keep up a demand for silver and cultivate a refined taste."

This idea so impressed me that I awoke.

**PROGRESSIVE PROSPERITY** is indicated when a Jeweler carries a full line of **HOLMES & EDWARDS, SILVER : PLATED : FLAT : WARE.**

STERLING SILVER INLAID.

XIV Extra Plate - - fancy pieces with gilt, engraved, or gilt engraved bowls and blades.

BEAUTIFUL EFFECTS ARE PRODUCED.

Salesrooms: New York, Chicago, St. Louis.

THE HOLMES & EDWARDS SILVER CO., BRIDGEPORT, CONN.

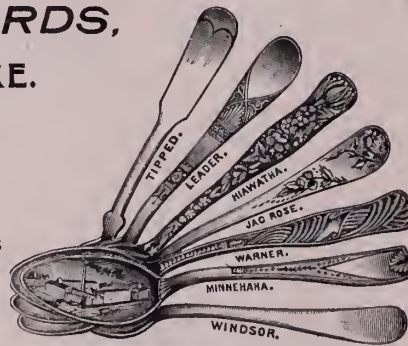

**R., L. & M. Friedlander,**



IMPORTERS OF  
**DIAMONDS.**

WHOLESALE  
**JEWELERS.**

JOBBER IN  
**American Watches.**

Tools, Materials, and Optical Goods.

Send for Catalogue.

65 & 67 Nassau Street, New York.

**Providence.**

James Smith, of Smith Bros., is visiting the World's Fair.

The Nicholson File Co. started up the past week with a full complement of men, after a brief shut down.

William Loeb returned the past week from an extended western trip, in which he was very successful.

Walter E. White, whose death occurred recently in this city, was buried at Woodlawn, Mass., at 12 o'clock last Monday.

Frederick V. Kennon started last week on a prolonged trip to the west, taking with him a new line of samples produced by J. T. Mauran.

Samuel Moore is spending a short vacation in New Brunswick. He will return by way of Chicago so as to make another visit to the World's Fair.

J. J. Luther, for many years with the Tilden-Thurber Co., has severed his connection with that company to engage in business for himself.

There will be numerous jewelry exhibits at the State Fair at Narragansett Park. Irons & Russell are making the official medals and souvenirs.

Bride, Revens & Co., 143 Summer St., have dissolved, Garrett Revens retiring. It is reported that the concern will be re-organized on an entirely new basis.

Jacob Shapiro, formerly a dealer in watches and jewelry at 303 N. Main St., has removed to Kansas City, Mo., where he has started in a similar line of business at 622 Walnut St.

The Providence creditors of Strauss & Stern, Cincinnati, O., through their attorney in that city, have accepted the 25 per cent. proposition, half cash upon acceptance, and balance Jan. 1st. The first payment is now being made.

Thursday the 21st inst. will be jewelers' day at the State Fair, and in observance of the occasion a large majority of the manufacturing concerns in this vicinity will close down and give their employes an opportunity of visiting it.

There is a probability that the large silver statue of Christopher Columbus which was cast by the Gorham Mfg. Co. and which forms a conspicuous attraction in their Columbian exhibit will ultimately be located in the Capitol at Washington, D. C.

William G. Hopkins has been appointed by the Municipal Court as the administrator of the estate of the late Walter E. White; bond, \$30,000. The sureties are Dutee Wilcox and Ellen E. White. The appraisers are George L. Vose, Samuel A. Baldwin and Barton A. Ballou.

Ira D. Goff, with O. C. Devereux & Co., and Frederick H. Carpenter, of Boston, leave this city on the morning of the 21st inst. for Des Moines, Ia., to attend the forty-eighth annual session of the National Council of the

Order of United American Mechanics, as representatives from this State.

Thomas W. Lind, who has been suffering from brain derangement for several weeks past, is still under the doctor's care with slight hopes of his recovery. His brother Philip was recently appointed by the Municipal Court to assume charge of the business during the former's illness.

Richard Robinson, for several years market representative of T. G. Frothingham & Co., North Attleboro, P. H. Richards and Thomas J. Gardiner, formerly of T. J. Gardiner & Co., will form a copartnership Jan. 1 next for the manufacture of gold jewelry, at 227 Eddy St., this city. At present they are engaged in getting out a line of new samples and preparing for their opening.

**The Attleboros.**

W. E. Hayward, of Hayward & Sweet, has mortgaged real estate for \$6,900.

Thomas B. Sadler, of Sadler Bros., has gone into the florist business as a side line.

S. E. Fisher, of S. E. Fisher & Co., is suggested for the Republican nomination for Representative.

Clara, wife of W. E. Lull, was found dead early one morning last week. The funeral took place Wednesday.

James Madison Cummings, father of John M. Cummings, celebrated his eightieth birthday anniversary last Wednesday.

At the annual meeting of the Y. M. C. A., E. W. Thresher was elected president; S. W. Gould and H. T. Regnell, directors.

Among the cases to come up before the Superior Court, at Taunton early next month, are: Ernest G. L. Hemple *vs.* Joseph E. Draper; C. L. Barnes *vs.* John N. Hugo; H. H. Curtis *vs.* Oscar M. Draper.

An association has been organized in North Attleboro for the purpose of establishing kindergarten schools. E. R. Price is the president. Charles H. Clark, traveler for G. W. Cheever & Co., and E. L. Hixon are among the trustees.

Jewelers who have gone to the World's Fair during the past week are: G. A. Dean, E. S. Capron, Fred A. Newell and D. A. White. Among those who have returned are: J. F. Sturdy, A. F. Dears, W. B. Ballou, H. K. Sturdy, R. Blackinton and Elton Riley.

The lot and building to be given to the town of North Attleboro for a public library, of which mention was made in last week's CIRCULAR, have been accepted, and an engrossed vote of thanks from the selectmen has been presented Anna L. Tweedy, Harriet I. Richards and E. Ira Richards, the donors.

The jewelry shop which W. H. Wilmarth & Co. have built on School St. is now completed, and will be occupied this week. The building is 230 feet long by 40 wide, besides an L 50x27. It contains 10,000 feet of space

on each of the four floors and is large enough for 300 hands. It is the largest jewelry factory in the Attleboros.

Early last week the representative of the Associated Press in this district sent out a despatch stating that Walter Franklin, only son of E. I. Franklin, had been drowned in Lake Pearl, Wrentham. Telegrams of condolence were received by the father of the young man. The report was a mistake. The Walter Franklin that was drowned was a hermit who lived near the lake.

**Indianapolis.**

Wm. J. Eisele and family are spending a week at the World's Fair.

F. M. Herron is having the interior of his store room handsomely redecorated.

Gus. Craft, of Craft & Koehler, made a business trip to Columbus, Ind., last week.

G. J. Daum has moved his jewelry business from Port Clinton, O., to South Bend, Ind.

The following buyers were in the city last week: C. M. Eaton, Trafalgar, Ind.; L. C. Phillips, Carbon, Ind.; J. Sherry Jones, Clayton, Ind.; L. J. Small, Carmel, Ind.; Geo. A. Fletcher, Carthage, Ind., and J. W. Hudson, Fortville, Ind.



SEND TO  
**J. T. Scott & Co.**  
 4 MAIDEN LANE,  
 NEW YORK.

## News Gleanings.

Louis Rochat has opened a repair shop in Pasadena, Cal.

E. D. Bean, Fort Collins, Col., will discontinue business.

C. Vuiele, Paxton, Ill., has made an assignment.

The death occurred last week of Wm. E. Coddling, Norfolk, Mass.

L. W. Lewis has opened a store in Antioch, Ill.

S. W. Cushing will conduct a jewelry business in Vergennes, Vt.

Yrecka, Cal., has a new jewelry store, conducted by F. Chapell.

Mr. Owen will engage in the jewelry business in Adams, Neb.

N. C. Natterman has opened a jewelry shop in Galena, Ill.

Martin C. Conley, Saginaw, Mich., has been sued for \$1,000.

H. G. Haines, Shellsburgh, Ia., has given a chattel mortgage for \$679.

O. E. Hattnedt, Callender, Ia., has sold his stock of jewelry, drugs, etc.

Geo. Hay and wife, Attica, Ind., have given a real estate mortgage for \$1,000.

J. C. Watts & Co., Saginaw, Mich., have been succeeded by W. W. Scott.

F. C. Brodie, Goldendale, Wash., has given a mortgage for \$415.

Thomas Gaskell, St. Paul, Minn., has made an assignment.

The store of George Darden, Wilmington, N. C., was burned out last week.

Adolph Gerger has purchased the jewelry stock of Fred Kendle, Fairview, Kan.

In a fire in Cutler, Ind., the jewelry store of J. M. Logan was completely destroyed.

Wm. H. Merrell, Pen Argyl, Pa., has been succeeded by E. H. Faunce & Son.

A judgment for \$74 has been entered against Ernst F. O. Klein, Buffalo, N. Y.

A judgment for \$1,000 has been entered against D. L. Cleeland, Butler, Pa.

George Jordan, San Bernardino, Cal., is making extensive improvements to his premises.

V. Swanson, of Post & Swanson, Rapid City, S. Dak., has given a chattel mortgage for \$350.

Anderton, Eberhardt & Co., Dayton, O., have removed from 6 W. 3d St. to 18 N. Main St.

R. B. Henneman has removed from Greenwood, S. C., to Spartanburg, same State.

In a fire in Baldwin, Wis., the jewelry and stationery stock of A. J. Backus was destroyed.

The stock of J. M. Galloup & Son, Battle Creek, Mich., has been taken under a chattel mortgage.

Henry Bard and William Leavitt have

formed a partnership in Brazil, Ind., to conduct a jewelry business.

The retrial of Robert J. Knox, accused of robbing a jeweler of the City of Mexico, has been postponed until Oct. 11.

M. Stoinert, Fair Haven, Vt., will occupy the first floor of the new Root building in that town.

Edward S. Green, Danville, Pa., has sold out to an employe, Harry Rempe. Mr. Green and wife have left for Roanoke, Va.

A judgment for \$167 has been entered against Carpenter & Christopherson, Buffalo, N. Y., and one for \$198 against Mr. Christopherson individually.

Burglars last week entered the store of H. A. Barnes, Lumberton, Miss., and stole four watches and a quantity of jewelry from a show case.

Frank B. Decker, watchmaker for C. H. Ankeny & Co., Lafayette, Ind., went to Cincinnati last week, where he has secured a position in Awalt & Co's jewelry house.

T. J. Fitzsimmons, watchmaker, Pittston, Pa., has in his show window a model of the Ferris wheel at the World's Fair, operated by water power.

John G. Bosch, for many years a leading jeweler of Menasha, Wis., died a few days ago of consumption, at the age of thirty-four years. He leaves a wife and one son.

Harry Wade, of Lafayette, Ind., is in Chicago selecting a jewelry stock, with which he will open out in part of the Singer sewing machine room, under the Perrin National Bank, Lafayette.

Fred H. Cole, 435 7th St. S. W., Washington, D. C., last Monday filed a bill of sale of all his stock, goods, fixtures and tools to Lamont E. Cole for \$3,000. The latter will continue the business.

C. H. Bartlett, Trinidad, Col., has failed and his stock of goods is now in the hands of the First National bank, of that city. The jeweler claims to owe about \$7,000, and if he can realize reasonably on assets, creditors, he says, will be paid in full.

Early's jewelry store, Wilber, Neb., was broken into a few evenings ago, entrance being effected by cutting the screen door and unfastening the same. Watches and canes to the value of \$50 or more were taken. There is no clue to the thief.

F. W. Sim & Co., Troy, N. Y., have just made extensive alterations to their store. They have put in a new double window plate glass front and newly and elaborately decorated the interior, so that they now have one of the most beautiful and attractive stores in their section of the State.

E. A. Massey, Woodstown, N. J., has sold his jewelry store to Tyson Ogden, a young man of Salem. Mr. Ogden learned his trade with Wm. Patterson, who has long been engaged in the business, and is a competent workman. Mr. Massey contemplates an extensive trip west, taking in the World's Fair.

J. W. Knapp, Cross River, N. Y., will leave on the morning of Sept. 21st for Chicago, where he will devote a week visiting the World's Fair. Thence he goes to Riverside, Cal., to which place his wife has preceded him. Mr. Knapp will remain between two and three months among friends in that California town, spending a well earned respite from business cares.

### Creditors of Joshua Lothrop & Co. Hold a Meeting.

PROVIDENCE, R. I., Sept. 13.—About fifteen of the merchandise creditors of Joshua Lothrop & Co. met in the rooms of the Manufacturing Jewelers' Board of Trade at 2 o'clock yesterday afternoon. The meeting was called to order by the assignee, E. A. Potter, of E. A. Potter & Co., and the following statement of the affairs of the defunct concern presented:

Total liabilities, including a mortgage of \$2,000 on stock, tools, fixtures, machinery, etc., \$9,124; the assets are estimated at about \$8,000, consisting of accounts, \$4,000; stock, finished and unfinished, \$3,000; tools, machinery, etc., \$1,000. All of these estimates had been made on a liberal basis, but if forced to sell out under assignee's sale at public auction, they would probably shrink very materially. Mr. Potter made an offer of 25 per cent. in liquidation of claims, to be settled on a basis of equal payments on Nov. 1st and Jan. 1st.

There was a general feeling in favor of acceptance and already many of the creditors have signed the agreement. Mr. Lothrop states that if he is successful in obtaining a settlement as above, he will start again.

### A Lively Chase and Capture of a Bold Window Smasher.

PHILADELPHIA, Pa., Sept. 16.—Last night John Williamson, who says he comes from Chicago, smashed the window of Samuel Baernkopf's store, 257 N. 9th St., with a brick. He grabbed up about \$400 worth of jewelry and started to run. Mr. Baernkopf, Jacob Baernkopf, his nephew, and his son, Samuel, were in the store at the time, and they went in pursuit. Jacob overtook the thief at 9th and Vine Sts., and succeeded in pinioning him until a policeman came to his assistance.

When searched at the Central Station two gold lockets, four diamond rings and a gold thimble were taken from the thief, and were identified by Mr. Baernkopf. This morning Williamson had a hearing before Magistrate Clement, and was held in \$2,000 bail for court.

Williamson is about twenty-five of age, and the detectives think he is the same man who did work of like character in Cincinnati last Winter. His description answers that of the Cincinnati thief, who escaped with several thousand dollars worth of diamond rings. A heavy rain storm was prevailing in Cincinnati at the time, and last night a furious gale with a heavy down-pour of rain contributed to the similarity of conditions here.



## Our Traveling Representatives



Traveling representatives may consider these columns open for the publication of any news or items of interest regarding themselves or their confreres.

**J. C. HUTESON**, of Hamilton & Hamilton, Jr., and Tom J. Huteson, of Julius King Optical Co., are in the far northwest showing their respective lines. Both report that business is improving and that dealers anticipate a good Fall trade.

Travelers who sell to Chicago's fine retail trade are having successful trips.

H. B. Bliss, Gorham Mfg. Co., has returned from a six weeks' trip.

Charles Green, traveler in Ontario for Simpson, Hall, Miller & Co.'s Montreal branch is spending a week at the World's Fair.

M. S. McGowan, Jr., Boston Mass., and H. B. Peters, 37 Maiden Lane, New York, have just returned from a two weeks' vacation to the Thousand Islands and Adirondacks.

Fred Zwicker, traveling salesman for Fred H. Schmidt & Co., Indianapolis, Ind., has just recovered from a peculiar accident. In a kicking contest Mr. Zwicker burst a blood vessel and was confined to his home for many days.

Sept. 11th John Gardner started for southern Indiana in the interests of Nichols, Pee & Co., Indianapolis, Ind., and David J. Reagan, for Illinois and Chas. W. Lauer, for central Indiana, in the interests of Baldwin, Miller & Co., same city.

Traveling men in Boston last week were: H. B. Beach, Meriden, Conn.; H. W. Durham, Meriden, Conn.; Mr. Baemy, Middletown, Conn.; C. Morgan, Waterbury, Conn.; Col. Stevens, New York, and S. A. Clark, No. Brookfield, Mass.

None of the New Haven Clock Co.'s travelers have yet left Chicago. The house is represented this season by C. M. Davis, who goes west to the coast, Tom Wilkinson in Iowa, Nebraska and Wisconsin, C. R. Downs in Michigan and Indiana, and Geo. C. Kofer in the south and southwest.

Sept. 10th W. F. Adams, representing Simpson, Hall, Miller & Co., left Chicago for a two months' western trip; H. E. Vincent left the day following for five or six weeks in Illinois and Indiana, and on Sept. 12th, H. R. Sherman departed for a two months' visit among Wisconsin and Minnesota dealers.

Traveling salesmen who were in Indianapolis, Ind., last week were: Mr. Blair, Blair's Fountain Pen Co.; J. Hayes, L. H. Keller & Co.; Thos. Davis, Middletown Plate Co.; W. S. Strauss, Jacob Strauss & Sons; Louis Lassner, Goodfriend Bros. &

Lassner; Richard Robinson, T. G. Frothingham & Co., and A. Peabody, Peabody & Engelsman.

The following traveling salesmen passed through Detroit, Mich., last week; Louis P. Cook, J. F. Fradley & Co.; W. H. Gregory, Strobell & Crane; Matthias Stratton, Jr., Jno. W. Reddall & Co.; George F. Merry, Julius King Optical Co.; F. A. Frey, Downing, Keller & Co.; Mr. Hopkins, Meriden Silver Plate Co.; C. I. Smith, Smith Bros.; Luther Hyde, Reed & Barton; H. J. Fink, Keller, Ettinger & Fink; I. W. Friedman and Ben Clemens, B. L. Strasburger & Co.

Travelers in Pittsburgh, Pa., last week were: Richard Robinson, T. G. Frothingham & Co.; Charles Ketcham, Riker Bros.; Thos. Rogers, Hayes Bros.; Frank Trewin, Keystone Watch Case Co.; W. C. Greene, W. C. Greene & Co.; W. H. Bryant, T. G. Hawkes & Co.; F. W. Francke, Wood & Hughes; R. G. Ledig; Matthias Stratton, Jr., John W. Reddall & Co.; C. A. Cuppia, Ludwig, Redlich & Co.; D. W. Granberg; C. L. Joralemon, A. Joralemon & Co.; W. S. Davis, H. Muhr's Sons; B. Hyman, Low, Weinberg & Heman; Mr. Schwab, New Haven Clock Co.

Wideawake representatives of various

firms were in Chicago the past week in the persons of C. C. Darling and wife, L. W. Pierce & Co.; Walter R. Shute, Day & Clark; Bob Block, Block & Bergfels; W. C. Tappan, D. F. Briggs Co.; W. F. Leeder, Leeder & Bernkopf; E. Untermeyer, Keller & Untermeyer Mfg. Co.; C. A. Fraser, Hancock, Becker & Co.; Richard Robinson, T. G. Frothingham & Co.; Fred J. Foster; Geo. W. Scherr, wife and son, L. A. Scherr & Co.; Mr. Hennege and wife, Hennege, Bates & Co.; Mr. Kaiser, Enos Richardson & Co.; E. I. Rogers, Parks Bros. & Rogers; H. B. Kennion, H. D. Merritt & Co.; L. H. Bosworth, Potter & Buffinton; George B. Champlin, S. B. Champlin & Son; Mr. Marsh and son, Marsh & Bigney; Sumner Blackinton, W. & S. Blackinton; Mr. Mason, Mason Jewelry Co.; Harry Osborn, Whiting Mfg. Co.; Mr. Russell, Irons & Russell; H. A. Bliss, Krementz & Co.; Mr. Sherrill, Sinnock & Sherrill; Mr. Mason, E. D. Gilmore & Co., E. T. Stanley; Charles H. Oakes; J. J. Sullivan, M. W. Carr & Co.; J. A. Granbery, Reeves & Sillocks; Mr. Roth, L. & M. Kahn & Co.; Lou E. Fay, Kirby, Mowry & Co.; Nat. D. Prentiss, Alling & Co.; E. P. Tiffany, F. H. Sadler & Co.; Mr. Fry, B. A. Ballou & Co.



ESTABLISHED 1801.

# HINRICHS & CO.,

29 & 31 PARK PLACE,

Cor. Church Street,

NEW YORK.

Art Pottery and Bric-a-Brac,  
CUT GLASS, FANCY GLASS, CHINA.

Large Assortment of

Fine Dresden China Lamps, Glass and  
other Fancy Lamps.

THE LARGEST ASSORTMENT OF SPECIALTIES FOR THE JEWELRY TRADE, AT LOWEST PRICES.

CATALOGUE ON APPLICATION.

## FRENCH CHINA SPECIALTIES FOR JEWELERS.

BRUSH & COMB TRAYS,  
CARD TRAYS,  
MANICURE TRAYS,  
PEN TRAYS,

PHOTOGRAPH FRAMES,  
FRUIT PLATES,  
ODD CUPS AND  
SAUCERS, ETC.

◁ SEND \* ORDER \* FOR \* SAMPLE \* ASSORTMENT. ▷

# F. W. BUNING & CO.,

58 MURRAY STREET,

NEW YORK.

# CLASSIFIED INDEX TO ADVERTISEMENTS.

All Advertisements are entitled to one insertion under proper heading. Extra insertions, \$6.00 per annum. Extra Headings, \$12.00 per annum.

	Page.		Page.		Page
<b>Art Pottery, Bric-a-brac, Etc.</b>		<b>Gold and Silver Plating.</b>		<b>Sample Trunks.</b>	
Ahrenfeldt & Son, 56 Murray St., N. Y.....	50	Brunor Plating and Jewelry Repairing Co....		Crouch & Fitzgerald, 161 Broadway, N. Y....	44
Bing, Ferdinand & Co., 106 Grand St., N. Y....	46	Maiden Lane, N. Y.....	5	<b>Settings and Galleries.</b>	
Borgfeldt, Geo. & Co., 18, 20 & 22 Washington		H. B., Bolstad, Plating Co., Chicago Ill.....	31	Blancard & Co., 46 John St., N. Y.....	32
Place, New York.....	48	<b>Gold Jewelry.</b>		<b>Silver Mounted Ebony Goods.</b>	
Bradley & Hubbard Mfg. Co., Meriden, Conn	8	Bippart & Co., Newark, N. J.....	7	Provenzano, J. N., 39 Union Square, N. Y....	19
Buning, F. W. & Co., 58 Murray St., N. Y....	37	Carter, Sloan & Co., 15 Maiden Lane, N. Y....	43	<b>Silver Plated Ware.</b>	
Craighead & Wilcox, 33 Barclay St., 38 Park		Hook, G. W., Chicago, Ill.....	28	Holmes & Edwards Silver Co., Bridgeport,	
Place, N. Y.....	3	Horstman, Richard, World's Fair Grounds,	23	Conn.....	34
Gleanzer Leon, J. & Co., 80 & 82 Chambers		Kremenz & Co., 182 Broadway, N. Y....	8	Pairpoint Mfg. Co., New Bedford, Mass.....	5
St., N.Y. ....	49	Larter, Elcox & Co., 21 & 23 Maiden Lane,		Rogers & Bro., 16 Courtlandt St., N. Y.....	18
Hinrichs & Co., 29 & 31 Park Place, N. Y....	37	N. Y.....	31	<b>Sterling Silverware.</b>	
Le Boutillier & Co., 860 Broadway, N. Y.....	11	Mayer, Martin, Mainz, Germany.....	26	Campbell-Metcalf Silver Co., Providence, R. I.	42
Levy, Dreyfus & Co., 9 & 11 Maiden Lane, N.Y	51	Racine Jewelry Mfg. Co., Racine, Wis..	39	Gorham Mfg. Co., Broadway & 19th St., N.Y. 12-13	
<b>Auctioneers.</b>		Richardson, Enos & Co., 23 Maiden Lane, N.Y	33	Knowles, J. B. & S. M., Co., Silversmiths'	
Firuski, S. & Son, 85 Bowery, N. Y.....	39	Smith, C. Sydney, 191 Broadway, N. Y. ....	10	Hall, Union Square, N. Y.....	7
French, J. H., P. O. Box 2775, New York.....	39	Street, Geo. O. & Sons, 15 John St., N. Y.....	10	Ovatt & Warner, Portland, Oregon.....	25
Rich, H. M. & Co., Boston, Mass.....	5	<b>Horological Schools.</b>		Reed & Barton, 37 Union Sq., N. Y.....	28
<b>Assayers &amp; Refiners.</b>		Parson's School for Watchmakers, Peoria, Ill.	24	Shiebler, Geo. W., Co., 179 Broadway, N. Y....	31
Clark, J. L., Philadelphia, Pa.....	51	<b>Hotels.</b>		Towle Mfg. Co., Newburyport, Mass.....	9
Howard, S. P., 8 John St., N. Y.....	52	Gibson House, Cincinnati, O.....	25	Wallace, R. & Sons Mfg. Co., 3 Park Place,	
Le Long, L. & Bro., Newark, N. J.....	52	<b>Imported Clocks, Bronzes, Etc.</b>		N. Y.....	6
Platt, Chas. S., 29-31 Gold St., N. Y.....	52	Jacques Chas., Clock Co., 22 Cortlandt St., N.Y.	52	Wood & Hughes, 10 John St., N. Y.....	42
Rathbone & Smith, Providence, R. I.....	9	<b>Jewelry Mailing Boxes.</b>		Whiting Mfg. Co., Broadway and 18th St., N. Y.	17
<b>Badges, Medals, Etc.</b>		Am. Railway Supply Co., 24 Park Place, N. Y.	4	<b>Stem Winding Attachments.</b>	
Irons & Russell, Providence, R. I.....	25	<b>Jewelry, Silverware and Optical Cases.</b>		Abbott, Henry, 2 Maiden Lane, N. Y.....	52
Schlechter, G. A., Reading, Pa.....	51	Birmingham, Wm. & Co., 728 Arch St., Phila.	9	<b>Sterling Silver Novelties.</b>	
Stockwell, E. R., 19 John St., N. Y.....	4	Troesch, A. & Co., 69 Nassau St., N. Y.....	42	Bachrach & Freedman, 183 Union Sq., N. Y..	41
Wilson, Chas. G., Reading, Pa.....	10	Wiggers & Froelick, 60 Nassau St., N. Y.....	42	<b>Thimbles.</b>	
<b>Chains, Seamless.</b>		<b>Jobbers, Watches, Diamonds, Etc.</b>		Ketcham & McDougall, 198 Broadway, N. Y.	30
Kent & Stanley Co., Providence, R. I.....	4	Aikin-Lambert Jewelry Co., 19 Maiden Lane..	10	<b>Tool Manufacturers and Dealers.</b>	
<b>Cut Glass.</b>		Bowman, Ezra F. & Co., Lancaster, Pa.....	45	Bullock, O. W., Springfield, Mass.....	7
Mt. Washington Glass Co., New Bedford, 51		Cross & Beguelin, 17 Maiden Lane, N. Y.....	30	Gesswein, F. W., 39 John St., N. Y.....	45
<b>Diamond Cutters.</b>		Friedlander, R. L. & M., 65 Nassau St., N. Y.	34	Horological Tool Co., Chicago, Ill.....	25
Humphrey, J. B., Boston, Mass.....	51	Giles Bros. & Co., W. H. Gleason, receiver,		Logan, A. J., Waltham, Mass.....	10
<b>Diamond &amp; Precious Stone Importers.</b>		Chicago, Ill.....	29	Mosely & Co., Elgin, Ill.....	24
Disselkoen, John N., 19 E. 16th St., N. Y....	43	Young, Otto & Co. Chicago, Ill.....	28	<b>Tortoise Shell Goods,</b>	
Falkenau, Oppenheimer & Co., 40 Maiden		Lapp & Flershem, Chicago, Ill.....	22	Rice & Hochster, 483 & 485 Broadway, N. Y..	9
Lane, N. Y.....	52	Myers, S. F. & Co., 48 Maiden Lane, N. Y....	52	<b>Trunks and Traveling Bags.</b>	
Fera, Henry, 10 Maiden Lane, N. Y. ....	7	Yates, John B., Hays Building, Maiden Lane,		Crouch & Fitzgerald, 161 Broadway, N. Y....	43
Hedges, Wm. S. & Co., 170 Broadway, N. Y..	42	N. Y.....	32	<b>Watch Case Manufacturers.</b>	
Jeane, Paul, Bradley Bldg., N. Y.....	30	<b>Leather and Silver Goods.</b>		Goll, Henry, 17 John St., N. Y.....	10
Kahn, L. & M. & Co., 10 Maiden Lane, N. Y.	52	Deutsch Bros., 7 E. 17th St., N. Y.....	2	The Planchamp & Becker Co., Chicago, Ill... 24	
Kipling, R. A., Hays Bldg., N. Y.....	42	<b>Musical Boxes.</b>		<b>Watchman's Clocks.</b>	
Klug, H. M. & Co., 11 John St., N. Y.....	52	Jacot & Son, 298 Broadway, N. Y.....	7	Hausburg, O. E., 41 Maiden Lane, N. Y.....	39
Leonhardt & Curran, 44 1/2 Maiden Lane, N. Y.	31	Wolff, A., 194 Broadway, N. Y.....	9	<b>Watch Importers.</b>	
Lorsch, Albert & Co., 37 Maiden Lane, N. Y.	52	<b>Optical Goods.</b>		Hyde's, J. E., Sons., 22 Maiden Lane, N. Y..	10
Ludeke & Power, 23 John St., N. Y. ....	42	Geneva Optical Co., Chicago, Ill.....	20	Wittnauer, A. 19 Maiden Lane, N. Y.....	33
Nissen, Ludwig & Co., 18 John St., N. Y....	42	Kirstein, E., Sons Co., Rochester, N. Y.....	10	<b>Watch Keys.</b>	
Randel, Baremore & Billings, 29 Maiden Lane,	43	Queen & Co., Philadelphia, Pa.....	4	Clark, A. N., Plainville, Conn.....	44
Rothschild, M. D., 41 & 43 Maiden Lane, N. Y.	52	Scheidig, John & Co., 43 Maiden Lane, N. Y..	32	<b>Watch Manufacturers.</b>	
Scott, J. T. & Co., 4 Maiden Lane, N. Y.....	35	The Nous Verrons Co., Boston, Mass.....	10	Baume & Co., London, England, and Syracuse,	
Smith, Alfred H. & Co., 182 Broadway, N. Y.	42	Zineman, M. & Bro., Philadelphia, Pa.....	30	N. Y.....	26
Wolff & Gunzburger, 87 Nassau St. N. Y.....	52	<b>Pens, Pencil Cases, Etc.</b>		<b>Watch Jewels.</b>	
<b>Diamond Jewelry.</b>		Aikin, Lambert & Co., 19 Maiden Lane, N. Y.	4	Kobel & Meyer, Berthoud, Switzerland.....	45
Bonner, Rich & Co., 41 Maiden Lane, N. Y....	30	Beaume, D. W., 17 John St., N. Y.....	33	<b>Watch Repairers.</b>	
Waterman & Lehman, 37 Maiden Lane, N. Y.	33	<b>Patents.</b>		Henry, Peter, Cincinnati, O.....	32
<b>Etching School.</b>		Cox & Sons, 11 Park Row, N. Y.....	31	<b>Ring Makers.</b>	
Lyman & Co., Chicago, Ill.....	31	Bryant, M. B. & Co., 10 Maiden Lane, N. Y..	52	Bowden, J. B. & Co., 192 Broadway, N. Y....	7
<b>Fine Stationery.</b>		Hildred Mfg. Co., 51 Maiden Lane, N. Y....	8	<b>Rolled Plate Jewelry.</b>	
Parsons, Green & Co., 18 Murray St., N. Y....	5	<b>Roller Plate Jewelry.</b>		Dederick, J. H., 16 Maiden Lane, N. Y.....	31
<b>Fountain Pens.</b>					
The Boston Pen Co., Boston, Mass.....	10				
<b>Cleaning Solution.</b>					
Quarters, W. F., Providence, R. I.....	ro				

## Special Notices.

Rates 75c. per insertion for notices not exceeding 3 lines (25 words); additional words 2 cents each. If answers are to be forwarded, postage stamps must be enclosed. Two insertions, 15 per cent. off; three insertions, 20 per cent. off; four insertions or more, 25 per cent. off. Payable strictly in advance. Display cards on this page will be charged at \$2.00 per inch for first insertion, subject to same discount as above for subsequent insertions.

Under the heading of **Situations Wanted** on this page advertisements will be inserted for **One Cent a Word**. This offer refers to **Situations Wanted only**. Payable strictly in advance. If answers are to be forwarded, postage must be enclosed.

## Situations Wanted.

Notices under this heading **ONLY** are charged at one cent a word, payable strictly in advance. If answer are to be forwarded, postage must be enclosed.

**POSITION** as salesman, retail jewelry or silverware. Experienced. References. Address, "F," care, JEWELERS' CIRCULAR.

**SITUATION WANTED.**—An experienced traveler wishes a position in a first-class house. Many years on the road and well acquainted in all sections east of Omaha. Diamond house preferred. Address E. D., JEWELERS' CIRCULAR.

**TO JEWELRY NOVELTY MANUFACTURERS.**—Young man, who has traveled with a line of fancy metal articles, is open for an engagement. Would like to cover New England, and nearby States for a jewelry or fancy goods house. Highest references. Address B. E. C., care JEWELERS' CIRCULAR.

**SITUATION WANTED** by a boy fifteen years old in a wholesale jewelry establishment, is at present in a retail jewelry store, therefore has some knowledge of the same and able to give good reference. Address M. R., care JEWELERS' CIRCULAR.

**SITUATION** wanted as watchmaker, clock and jewelry repairer, by a single man, twenty-seven years of age. Address Ed. S., Dresden, Ohio.

**WATCHMAKER AND JEWELER** with seven years' experience and tools wants position by October 1st; best references. Address Fred Farwell, Mt. Sterling, Iowa.

**BOOKKEEPER.**—Young man (25), experienced double entry and general office man, one acquainted in jewelry trade, desires position. A 1 reference. E., care JEWELERS' CIRCULAR.

**WANTED** at once a position to finish the watch trade. Have had several years' experience as clock repairer and jewelry jobber. Best of references. Address Geo. C. Pouter, Walden, Orange Co., N. Y.

**WANTED, A POSITION** in a diamond, jewelry or fancy goods house. Have a thorough knowledge of the goods and a fair trade acquaintance. Satisfactory references. Address D. J. F., care of JEWELERS' CIRCULAR.

**A FIRST-CLASS** watchmaker wants position as good salesman. Has full set of tools. Address Waltham, care JEWELERS' CIRCULAR.

**A YOUNG** experienced traveling jewelry salesman open for engagement. Highest references. Hustler, care of JEWELERS' CIRCULAR.

**WANTED.**—A position as jeweler and diamond setter; 15 years' experience; best of references. Address L. W., care JEWELERS' CIRCULAR.

**WANTED.**—Position by competent lady stenographer and typewriter; has her own machine; will assist on books or office work. Address S. M. W., care JEWELERS' CIRCULAR.

**POSITION WANTED.**—By young Swede, as watchmaker and clock repairer; three years' experience; speaks English; own tools; best references. Address D. C., JEWELERS' CIRCULAR.

**BY YOUNG MAN.**—Single, 6 years' experience at bench; own tools; no bad habits; best of references; south preferred. Address W. K. Heartsfield, High Point, N. C.

**POSITION WANTED** in wholesale jewelry house by a young lady thoroughly adapted for any inside position. Can furnish highest references. Address G. R. A., care JEWELERS' CIRCULAR.

**A JOB BY WATCHMAKER** or assistant by Nov. 15th or Dec. 1st. Do jewelry work and some little script engraving; also fair salesman; married. Address W. F. S., Marietta, Ga., care of J. H. Bate & Co.

**WANTED.**—Situation as watchmaker; good workman; have my own tools; first-class references; Massachusetts, Connecticut or eastern New York preferred. Address B. S., care JEWELERS' CIRCULAR.

## Help Wanted.

**WANTED** at once, in New York State, a good watchmaker, who can wait on the trade and take in work. A permanent position and good wages to right party. Address, giving nationality, references, experience, &c., Mead, care of JEWELERS' CIRCULAR.

**WANTED, MECHANICAL SUPERINTENDENT.**—A man possessing experience and ability—to take mechanical and business management of well equipped factory for the manufacture of small, well finished articles in optical and scientific instruments, &c. One who could invest some capital preferred, as the present owners have other business and wish a responsible manager. A. L. Smith, 69 Washington St., Chicago.

**FOR LOS ANGELES, CAL.**—Engraver to commence in the Fall; must be an expert workman on monograms and general letter work; no one else will do; if a watchmaker, a jeweler, or able to repair fine French clocks, or even a good salesman, it would add to the value of his services; sample of engraving must accompany application. State wages, and if you write before Sept. 9 address Geo. A. Montgomery (of Montgomery Brothers), care of Gorham Mfg. Company, Nineteenth Street and Broadway, New York. After Sept. 9, write to Los Angeles.

**WANTED**—Experienced traveling salesman to carry a leading and well-known line of spectacles and eye-glasses; samples easily carried; liberal commission. Address Optics, care JEWELERS' CIRCULAR.

**WANTED.**—Experienced watchmaker and engraver. Must be single and temperate. A good all around man. Salary \$12 a week and board. Address Otto Salzman, 309 Main St., Danville, Ia.

**WANTED.**—A first-class watchmaker for railroad watch work; must be thoroughly competent; one who can engrave and repair jewelry, and is a good salesman, preferred; a permanent job; state age; send sample of engraving and reference; salary \$20 per week. Address F. A. Boerner, Fort Worth, Texas.

## For Sale.

**FOR SALE.**—On account of death of owner, Hopkin's Lathe, with all attachments; Universal Lathe, Pivoting Lathe, and a complete watchmaker's outfit at less than one-third of original cost. Address Mrs. J. R. Abbott, care F. C. Gleason, 133 E. 125th St., N. Y. City.

**FOR SALE.**—\$500 for \$300 cash. Jewelry, News Depot and furnished rooms for two. Rent \$8. Store pays profit; bench work for one. Address Cyrus Condit, 2344 Bellevue Avenue, Kansas City, Mo.

**FOR SALE.**—\$1,500 buys stock and fixtures of jewelry store in town of 4,000 inhabitants. Good run of work. Address W. F. Dudley, Hammonton, New Jersey.

**FOR SALE.**—A spectacle and thimble plant long established. Good set of machinery and tools, with power, all in fair condition. Price \$3,000, with liberal discount for cash. Continued ill health the reason for selling. For particulars inquire of Gustave Walters, 33 Maiden Lane, New York.

## Miscellaneous.

### DEMAGNETIZING.

**PERFECT WORK.**—Watch repairing in all its branches; all work warranted. Winslow & Penney, 608 Masonic Temple, Chicago.

**I BUY JEWELRY STOCKS.**—Manufacturers, jobbers and retailers desiring to dispose of surplus or entire stocks of diamonds, watches and jewelry can find quick cash buyer by addressing Stephen S. Harmon, 134 East 96th St., New York city.

**FOUND.**—On our showcase, in June a paper of mounted diamond jewelry, supposed to have been left by some traveling salesman; has been advertised in Boston Herald; owner will please call, prove property, pay expenses and take the goods. M. S. Page & Co., No. 1 Salem Street, Boston, Mass.

## To Let.

**TO LET** for business purposes; Broadway store near Post Office, half store and entire show-window. Junior, 2 Astor House.

## Headquarters

FOR ELECTRIC & PORTABLE Watchman's Clocks

Lowest Prices. Latest Improvements, Patents 1886-1893. Send for Circular.

E. O. HAUSBURG,

41 Maiden Lane, New York.

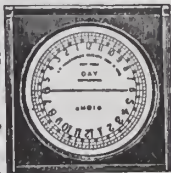

Price, Complete \$10.00

THE "ALERT."

## PAWNBROKERS' SALES

BY

## S. FIRUSKI & SON,

AUCTIONEERS,

85 Bowery, New York,

AT 11 A. M.

See N. Y. Herald for full particulars of Sales.

The Trade is Respectfully Solicited to Attend.

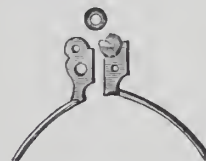

Racine Jewelry Mfg. Co.,

SPECTACLE TEMPLE WASHERS.

Gross in a Bottle, 25c.

For Sale by Dealers in Jobbing Materials

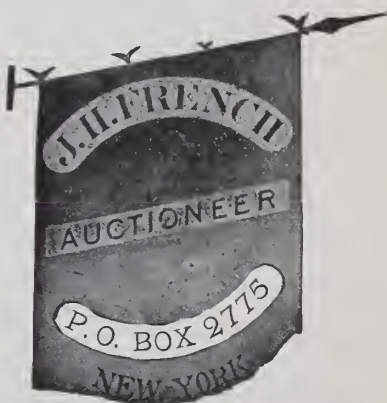

SPECIALTY: SALES OF

## JEWELRY, BRIC-À-BRAC

AND

ARTICLES OF VERTU

The Latest Patents.

ISSUE OF AUGUST 29, 1893.

**503,953. CYCLOMETER.** CHARLES F. FERNALD, Boston, Mass., assignor of one-half to Aloysius J. Ochs, same place.—Filed Mar. 23, 1893. Serial No. 467,341. (No model.)

The combination with a velocipede of a cyclometer provided with means of attachment thereto, and with means for actuating its registering mechanism as a

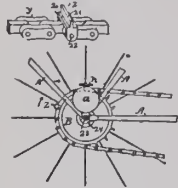

lever or star wheel; of an intermittent striker located upon the chain which conveys motion from the treadles to the working wheel.

**503,983. PLATED STOCK FOR MANUFACTURE OF JEWELRY.** JOHN S. PALMER, Providence, R. I.—Filed Dec. 26, 1888. Serial No. 294,630. (No model.)

As a new article of manufacture for making plated

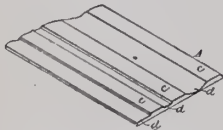

jewelry, an ingot of precious metal having a surface of pre-determined longitudinal ribs and depressions as set forth.

**504,046. CHRONOMETER-ESCAPEMENT.** JAMES G. McALPINE, Hartford, Conn.—Filed Oct. 15, 1892. Serial No. 448,980. (No model.)

In combination with the balance and scape wheels of a time piece, an oscillating locking lever bearing a

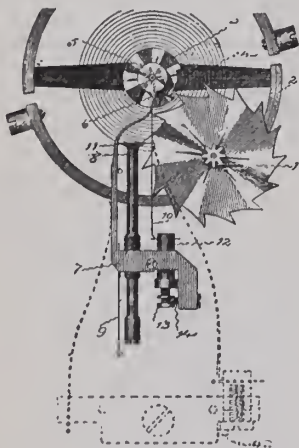

longitudinally screw adjustable locking detent having a circular head, a discharge spring held by a longitudinally screw adjustable support, and an adjustable locking spring.

**504,095. ELECTRIC CLOCK.** EMIL SCHWEIZER, Sumiswald, Switzerland.—Filed July 16, 1892. Serial No. 440,198. (No model.) Patented in Switzerland Apr. 21, 1890, No. 2,115; in England Apr. 28, 1890, No. 6,490; in Belgium Apr. 30, 1890, No. 90,374; in Austria-Hungary Sept. 18, 1890, No. 19,771 and No. 38,430, and in France May 5, 1891, No. 213,243.

In an electric clock, the combination with an electromagnet, its armature mounted on the shorter arm of the armature lever, the said lever having its longer

arm weighted, the wheels which operate the clock hands, mechanism intermediate the weighted arm of the armature lever and said clock wheels, whereby the descent of said lever rotates said wheels, and a circuit breaker and closer, of the escapement K, the verge

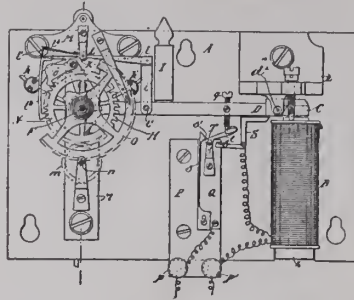

wheel H, bearing a pawl *h*, the scroll disk G, loosely mounted concentric with the wheel H and engaged by the pawl *h*, the pinion *f*, connected to the disk G, and the rack *d* on the armature lever in gear with said pinion.

**504,167. JEWELER'S RING-TRAY.** REINHOLD KRUEGER, New York, N. Y. Filed June 3, 1892. Serial No. 435,385. (No model.)

A ring-tray for jewelers, the frame of which is provided with longitudinal strips and slots, and with transversely guided and spring-actuated slide-pieces below

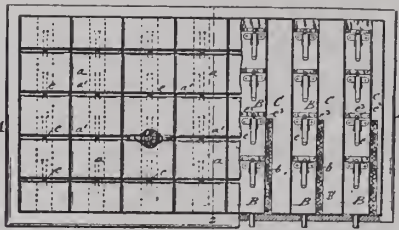

said strips, said slide pieces being provided with fulcrumed and spring-actuated fingers transversely to the slots, so as to automatically lock the rings to the tray on inserting the same into the slot.

**504,223. TIMEPIECE-ESCAPEMENT.** JOHN H. LANGHORST, Jackson, Cal. Filed Apr. 4, 1893. Serial No. 469,017. (No model.)

An anchor for a lever-escapement for time pieces in which the acting line for impulse on the lifting face

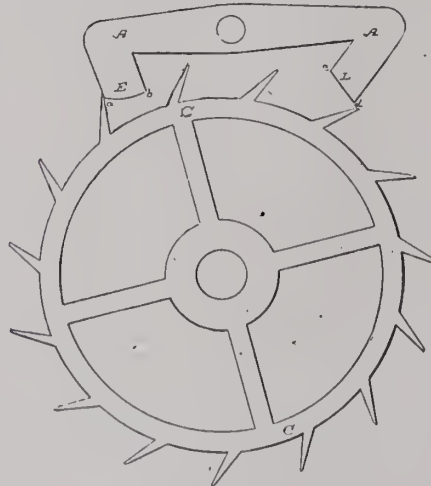

of the receiving or entering pallet is a convex curve, and the acting line for impulse on the leaving pallet is a straight line, whereby the lifting power transmitted by the escape wheel is approximately the same on the entering or receiving pallet and on the leaving pallet.

**DESIGN 22,744. BADGE.** FRANCIS L. PALMER,



Chicago, Ill. Filed May 31, 1892. Serial No. 435,071. Term of patent 3 1/2 years.

**DESIGN 22,745. BADGE.** WILLIAM SHAW, Bal-



lard Vale, Mass. Filed Jan. 12, 1893. Serial No. 458,187. Term of patent 14 years.

**DESIGN 22,746. HANDLE FOR SPOONS, &c** WILBUR H. GAINES, Waterbury, Conn., assignor



to the Rogers & Hamilton Company, same place. Filed July 26, 1893. Serial No. 481,556. Term of patent 14 years.

**DESIGN 22,747. HANDLE FOR SPOONS, &c.** FREDERICK E. PRETAT, Waterbury, Conn., as-



signor to the Rogers & Hamilton Company, same place. Filed July 26, 1893. Serial No. 481,555. Term of patent 14 years.

**DESIGN 22,748. HANDLE FOR SPOONS, &c.** GEORGE WILKINSON, Providence, R. I. Filed



July 5, 1893. Serial No. 479,659. Term of patent 7 years.

**DESIGN 22,749. HANDLE FOR SPOONS, &c.** GEORGE WILKINSON, Providence, R. I. Filed



July 28, 1893. Serial No. 481,774. Term of patent 7 years.

**DESIGN 22,750. HANDLE FOR CANES, &c.** ANDREW KROUSE, Bridgeport, Conn. Filed May



12, 1893. Serial No. 474,026. Term of patent 3 1/4 years.

**DESIGN 22,752. BOWL.** CHARLES C. WIENIGF,



Providence, R. I. Filed July 28, 1893. Serial No. 481,772. Term of patent 7 years.

ISSUE OF SEPTEMBER 5, 1893.

**504,127. TIME-LOCK.** IRA G. BLAKE, Worcester, Mass.—Filed Apr. 17, 1893. Serial No. 470,758. (No model.)

**501,432. CALENDAR-CLOCK.** HULDA GRUNBERG, Biel, Switzerland.—Filed Mar. 9, 1893. Serial No. 465,366. (No model.) Patented in Switzerland Sept. 5, 1892, No. 5,356.

A regulator for calendar mechanisms of watches provided with an external operating arm, with a spring arm always tending to force it to its central or neutral position and with two pawl arms, one adapted when



the operating arm is moved in one direction to rotate the number wheel and the other adapted when the operating arm is moved in the other direction to rotate the name wheel in each case the space of one tooth from the position previously occupied.

**501,531. LETTER-SCALE.** CHARLES A. MILLER, Meriden, Conn., assignor to the Wilcox Silver Plate Company, same place.—Filed Feb. 27, 1893. Serial No. 463,806. (No model.)

In a letter scale, the combination with the case thereof, of a rack suspended therein and furnished at its upper end with a pan, a yoke suspended in the said

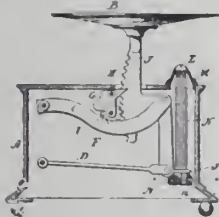

case near the top thereof, and having its upper end adapted to take a bearing against the same, whereby its swinging movement toward the rack is limited, a shaft journaled in the said yoke, and a pinion and an indicator attached to the said shaft, the former taking into the said rack and the latter standing in front of a scale on the case.

**501,580. CHATELAINE.** JENNIE C. HAYDEN, Chicago, Ill.—Filed Mar. 6, 1893. Serial No. 464,661. (No model.)

The combination, in a chatelaine, with an ornamental head provided with means for attachment to

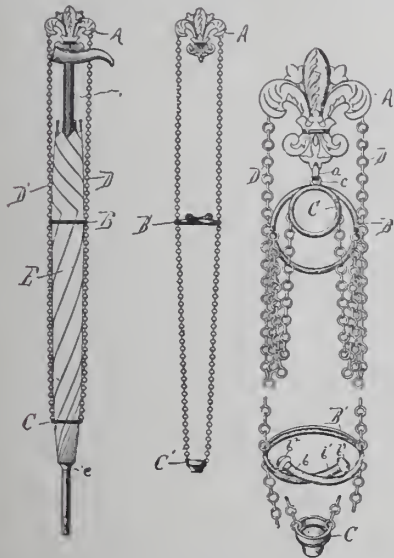

the clothing, of a series of rings suspended therefrom, the lower of which is fitted to receive the small portion of an umbrella at the end opposite the handle, but is not large enough to allow the larger portion to pass

through, and the upper of which is of sufficient size to receive the larger portion of the umbrella and at a sufficient distance from the lower to support the umbrella securely upon the latter.

**TRADEMARK 23,572. BRONZES AND SILVER AND PLATED WARE.** TIFFANY & COMPANY, New York, N. Y.—Filed July 29, 1893.

TIFFANY & CO.

*Essential feature.*—The word, character and abbreviation "TIFFANY & Co" Used since 1868.

**TRADEMARK 23,573. JEWELRY AND WATCHES.** TIFFANY & COMPANY, New York, N. Y.—Filed July 29, 1893.

TIFFANY & CO.

*Essential feature.*—The words "TIFFANY & Co" Used since 1868.

**Pittsburgh.**

Since Sept. 15th, the stores have resumed closing at 6 o'clock.

J. Harvey Wattles is in Chicago, with headquarters at the Royal Berlin exhibit.

Biggart & Wolfe have added a jobbing department to their store, and will engage in this branch in a small way.

R. K. Kirkpatrick, Renfrew, Pa., and F. H. Hayes, Washington, Pa., were in town last week investing in Fall stock.

M. Kingsbacher has returned from his business trip in the west. Mr. Koppel, with A. Kingsbacher & Bro., is in for a few days.

B. E. Arons has been appointed official scorer at the Alleghany Century Club meet, Sept. 26th, at which Zimmerman and other fast bicyclists will race.

Robert Wolfe, of Biggart & Wolfe, will leave this week for Ohio, where in a month's rest, he will endeavor to regain his seriously impaired health.

Campbell Douglass, with E. P. Roberts & Sons, will marry Miss Sadie Whitaker, Oct. 4th. The wedding will be of social interest, owing to the prominence of both parties.

**St. Louis.**

F. W. Huguin has removed his jewelry store from 724 Olive St. to 918 Olive St., the old stand being torn down to make room for a large new building.

Sol. Fischel, agent of the French Quartz Diamond Co., of Brooklyn, N. Y., has fitted up a pretty display of his company's goods at the St. Louis Exposition.

The Mermod & Jaccard Jewelry Co. have been awarded the contract for furnishing the fifteen elegant gold medals for the Pastime Athletic Club's games on Sept. 19th.

Among the traveling men in St. Louis last week were: H. A. Bliss, Kremetz & Co.; Arthur Pinover, A. Pinover & Co.; L. Seligsberger, Adelphi Silver Plate Co.; Harry Osborne, Whiting Mfg. Co.; and Mr. Kingsland, Keer & Kingsland.

Samuel Barbour has made several changes in the management of the local Hartford Plate Co. The principal one is the appointment of John W. Milford, to succeed manager C. P. Lindley. Mr. Lindley has associated himself with the Holmes & Edwards Silver Co.

**Joseph D. Lynch Claims His Credit Was Injured by the Bank.**

Joseph D. Lynch, jeweler, 1,123 Broadway, New York, has commenced an action for \$2,000 damages in the City Court against the Sherman Bank, at 18th St. and Broadway. The complaint alleges Mr. Lynch has been a depositor in the Sherman Bank since May 26th, and that on Aug. 21st he deposited in the bank a \$100 check, drawn to his order by the Alexandrine Co. on the Citizens' National Bank, of Saratoga, N. Y. This check was duly credited in his bank book.

He states that after this he drew three small checks for \$15, \$20, \$22, which the bank refused to pay. Then, Mr. Lynch says he deposited a twenty-five dollar check drawn to his order by the Alexandrine Company on the Citizens' National Bank of Saratoga on Aug. 23. He left his bank book to be balanced on the same day. It was returned to him with the entry on the credit side in red ink, "Balance \$115.38."

After this another check for \$25 was dishonored.

The bank officials state that they had no intention of injuring Mr. Lynch's credit, but withheld payment as a matter of precaution, as checks came back from Saratoga because the endorsements purporting to be by his mother, Mrs. T. Lynch, were not in her handwriting.

John Brodie, London, Ont., has made an assignment.

Isaac Benjamin, jeweler, Queen St. W., Toronto, Ont., wishes to compromise with his creditors.

J. D. Didier, Three Rivers, Que., has made abandonment of his estate, and owes something over \$4,000, \$1,800 being due to one Montreal house.

**ESPECIALLY ATTRACTIVE LINES OF**

**RICHLY CUT Glass Novelties,**

**HANDSOMELY MOUNTED WITH STERLING SILVER.**

**ORNAMENTS FOR THE DINING ROOM, LIBRARY, BEDROOM AND DRESSING TABLE.**



**BACHRACH & FREEDMAN,**

**1 & 3 Union Square,**

**NEW YORK.**

**DIAMONDS.**

**Wm. S. Hedges & Co.,**

**Importers of Diamonds,**

And Manufacturers of **DIAMOND JEWELRY.**

**170 Broadway, New York.**

27 Holdorn Viaduct, London.



**R. A. KIPLING,**

Importer of

**PRECIOUS STONES,**

**21 & 23 Maiden Lane,**

19, RUE DROUOT,  
PARIS.

New York.

**Alfred H. Smith & Co.,**

IMPORTERS

**DIAMONDS**

AND

PRECIOUS STONES,

182 BROADWAY, COR. JOHN STREET,

NEW YORK.

33 Holborn Viaduct, London, E. C.

**CAMPBELL-METCALF SILVER CO.**



176 Broadway, N. Y., Room 14. 66 Stewart St., Prov., R. I.  
Mills Bldg., San Francisco, 8th Floor, Room 1.



Patent applied for.

Victoria Novelties, many fancy shapes.  
Celluloid Top, Sides, Bottom and Cushions  
**A. TROESCHER & CO., 69 Nassau St., N. Y.**

**LUDEKE & POWER,**

IMPORTERS OF DIAMONDS

AND OTHER PRECIOUS STONES,

ADOLPH LUDEKE,  
CHAS. L. POWER.

23 JOHN STREET, N. Y.

**WOOD & HUGHES.**

**STERLING SILVERWARE MANUFACTURERS**

New York Agents for the Derby Silver Co.'s  
FINE QUADRUPLE PLATED WARE.

NO. 16 JOHN STREET, NEW YORK  
206 Kearney St., San Francisco, Cal.

HASKELL & MUEGGE, Agents.

**WIGGERS & FROELICK,**

60 NASSAU ST., NEW YORK.

**Sample Cases and Trays**

For Watches, Jewelry, Optical Goods, Etc.

**WE STRIVE TO MAKE THE BEST.**

**Trade Gossip.**

Peter Henry, 53 Longworth St., Cincinnati, O., says order work is brisk, and that his men are all at work.

Have you tried the jewelry cleaning solution offered by W. F. Quarters, 139 Eddy St., Providence, R. I.? Users commend it highly.

The J. B. & S. M. Knowles Co., Providence, R. I., are running full time with good prospects for Fall and Spring trade. The popular "Argo" pattern made by this house has proved an excellent seller even in dull times. Additions are constantly being made to the various lines, particularly to the fancy flatware. A new line of toilet brushes, of a novel and artistic pattern, has proved very popular.

The collar button as a cause of profanity has for years been a staple article with the professional humorist; but now he must seek new fields for fun, as Enos Richardson & Co., 21 Maiden Lane, New York, announce that they have secured the right to manufacture the "Benedict" button which they claim to be a perfect collar button. This article the firm offer to the trade in 14 karat and 10 karat gold, sterling silver and rolled plate.

Albert Oppenheimer, head of the diamond department of R., L. & M. Friedlander, 65-67 Nassau St., New York, says that he is well satisfied with the amount of business done during the past eight months. The firm are showing at present a beautiful and original line of diamond jewelry, among which is a new diamond brooch pin known as the "Princess Eulalie" brooch, containing 120 small diamonds. It is pronounced by connoisseurs to be one of the handsomest brooches brought out this season.

For chasteness and beauty of design no pattern in flat ware, within the compass of our knowledge, is superior to "The Kensington," which is in keeping with the most refined and advanced taste in artistic silverware. It is the latest production of the Gorham Mfg. Co. and fully meets the demand for a plain, bright finished design of simple yet artistic decoration and outline, besides being perfectly suited to that portion of the trade requiring inexpensive silver, as it is made in light and medium as well as heavy weights. Though but just placed on the market, "The Kensington" has already been extensively ordered by the class of dealers having a critical and discriminating trade. All dealers should examine the pattern, for such a proceeding would redound to their advantage. The Gorham Mfg. Co.'s newest and one of the most successful cases, the "crêpe," is particularly adapted to this pattern in all the combinations and single pieces. Fancy pieces as well as spoons and forks are now ready, while combination chests of all sizes up to 303 pieces, containing "The Kensington" can be delivered in October.

**Among the South African Diamond Fields.**

REPORT OF THE DISCOVERY OF A SAPPHIRE MINE AT RUSTENBURG.—GOOD FINDS AT THE SMALLER MINES.—A PERIOD OF BIG FINDS.—PROSPECTING FOR MORE DIAMOND FIELDS.

KIMBERLEY, Aug. 14, 1893 —Interest has been aroused here by the intelligence that a rich sapphire mine has been discovered at Rustenberg, in the Transvaal. Some rough stones of rare brilliancy from the mine are being shown here. Steps are being taken to fully develop the property.

Good finds continue to be made at Klipdam, the Monastery mine, Koffyfountain and the other newer and smaller diamond digging and mining centres. The Monastery diamonds, though small, are of excellent quality and realize 30 shillings per karat. A real bluish-white beauty of 17½ karats found last week has been sold for £350.

This seems a period of big diamond finds. Last week at the DeBeers mine a well shaped but off colored gem of 410¼ karats was found. It had been in the possession of a native laborer for several hours before it was declared to the overseer and might have got beyond the compound and into the hands of some I. D. B. but for the jealousy of another native who had observed the finder pick it up. The cute "nig" had secreted the gem in his hair. Some of these natives no doubt take away diamonds to their homes in the far interior of the Continent and not infrequently they smuggle them away for the purpose of making presents to their chiefs. I have often been told by missionaries, traders and travelers that some of these chiefs make the stipulation to their followers that a certain number of diamonds must be brought back by them when they return from their period of labor at the diamond fields. In this matter, there is nevertheless, much to be learned as the natives are not easily drawn; but it is an indisputable fact that many petty African potentates are in possession of valuable collections of diamonds.

At the present moment considerable attention is being paid to farms in the neighborhood of Heilbron Road on to Ventersburg and thence to Winburg Road. All along this line of about sixty miles there are claimed to be diamondiferous deposits. In several instances these farms are about to be prospected, while some have been taken over by large capitalists. J. B. Robinson, the South African gold king has acquired a farm near Winburg, on which diamonds have been found. A farm called Spaarveld, near Heilbron, also shows promising indications.

ST. GEORGE.

S. E. Ledman, Louisville, Ky., had recently quite an attractive window. The main feature was a large crystal about a foot in height literally covered with brownies. The crystal was from Hot Springs, Ark.

ESTABLISHED 50 YEARS.

**RANDEL, BAREMORE & BILLINGS,**

IMPORTERS OF

**DIAMONDS,**

AND OTHER PRECIOUS STONES.

**FINE PEARLS A SPECIALTY.**

MANUFACTURERS OF

**DIAMOND JEWELRY,**

IN THE LATEST DESIGNS.

Diamonds Recut in Modern Styles or Repaired on Premises.

58 Nassau Street,  
29 Maiden Lane  
NEW YORK.

1 Tulp Straat,  
AMSTERDAM.

1 St. Andrews St.,  
Holborn Circus,  
LONDON, E. C.



TRADE MARK.

ESTABLISHED 1841.

**CARTER, SLOAN & CO.,**

**MANUFACTURERS OF GOLD JEWELRY,**

No 15 MAIDEN LANE.

NEW YORK.

A. CARTER, JR.  
A. K. SLOAN.  
C. E. HASTINGS.

GEO. R. HOWE.  
WM. T. CARTER.  
WM. T. GOUGH

FACTORY, NEWARK, N. J.



**JOHN N. DISSELKOEN,**  
Cutter and Importer of  
**DIAMONDS**

FACTORY,  
76 LANGEBLEEKERSPAD,  
AMSTERDAM.

19 East 16th St.,  
NEW YORK.



## Influence of Magnetism upon a Chronometer's Rate.

AN issue of the *Annalen der Hydrographie, &c.*, contains an interesting article on this subject.

The problem whether any, and if so, which, influence is exerted upon a chronometer by magnetism, has not, by any means, been decided. The observations made hitherto only showed a noticeable influence, cases of which were mentioned at proper occasions. Airy found among hundreds of chronometers examined by him only one that showed a pronounced deviation, although of various others observed in the Kiel Observatory, a few exhibited an influence of magnetism upon their rate, still the change produced amounted to not more than a second. Nothing was said specially about the metal of the several parts of the chronometers examined. More weight is attached to the observations established by the French lieutenant of marines, Le Goarant de Tromelin, which he discussed in an article published in the *Revue Maritime et Coloniale*, and in which he arrives at the conclusion that the influence of magnetism upon the rate of a chronometer depends simply upon the metals of which the two parts of the balance are composed, and to a lesser degree, upon the metal of the balance spring. It may be interesting to the readers of THE CIRCULAR to debate upon a few of the observations and discussions, and to mention their most salient points.

Isochronism, amplitude, and duration of vibrations, and consequently, also the rate of the chronometer, all depend essentially upon the balance spring and balance, and it may, therefore, also be assumed *a priori*, that when an influence of magnetism upon the rate is suspected, it must first be looked for in the last mentioned parts. Observations confirm this in such a manner that a stronger influence of magnetism could be found only in those chronometers, the last mentioned parts of which consisted of metals with a tendency to be influenced. Specially interesting in this regard are the observations of Arnold and Dent, who used chronometers, the balances and springs of which were of steel, as well as other material, and the following observations were made:

A chronometer with balance spring of steel only, simply showed trifling altera-

tions of a few seconds, while chronometers, the balance spring and balance, or the balance only of which was of steel, showed very great deviations up to thirty-seven minutes. The magnetic influence upon a chronometer, the balance of which together with its spring contained no iron, was nil.

Mr. Fischer, who also experimented in the same manner, placed a strongly magnetic rod at a distance of two inches from his timekeeper; he noticed with all chronometers an acceleration of 8 to 9 seconds. It is to be regretted that nothing regarding the structure of the balance and its spring is mentioned in the dissertation of Mr. Tromelin.

Messrs. Delamarche and Ploix instituted analogous experiments by approximately placing the chronometers on land under analogous conditions to which they are exposed on board ship—that is, they placed a magnetic rod at such a distance from the chronometers in which it is able to deviate an ordinary magnetic needle from 15° to 40°. After having finished this experiment these engineers came to the conclusion that the magnetic condition of the ship exerts no noticeable influence upon the rate of the chronometer, and that the rate deviations generally experienced in the transport from land to aboard ship, and *vice versa*, must be ascribed to other causes. The latter remark is perhaps made because sea captains were for a time inclined to ascribe these deviations to magnetic influence due to the transport of the chronometer from land to on board; this erroneous opinion, however, was proved to be fallacious long ago. The experimenters, Delamarche and Ploix forgot to state, however, of what material the balance and spring were composed, and for this reason the results found are of a limited value only, in view of the above remarks concerning the composition of these parts.

Mr. Tromelin accidentally experienced another occurrence with his own watch which stopped while he experimented with strong electro-magnets. This phenomenon caused him to institute further investigations concerning the influence of magnetism upon watches and chronometers. The balance arm of his watch was of steel, as is generally the case in a good watch with compensated balance, and, as he expressed it,

changed the watch into a compass, which indicated not the time, but the magnetic meridian.

In order to explain the action of magnetism upon the balance spring, let us imagine a circular steel hoop that vibrates near a magnet lying in its plane. The magnet will exert no influence upon the vibrations as long as it is in the plane of the hoop; but if this is not the case, then the hoop will endeavor to vibrate in the direction of the magnet. This explains the phenomenon why the experiments instituted by Arnold and Dent produced barely noticeable alterations in chronometers, only the balance spring of which consisted of steel, because this spring may be regarded as composed of a number of such hoops. A deformation of the spring is produced only, and it is known that such a one has almost no influence upon the rate of a chronometer. But it is otherwise with a balance containing steel parts; if it is placed to one side of a magnet it will seek to accommodate itself with its steel arms until it has assumed an equipoise. During its vibrations it is constantly subjected to a magnetic attraction, and the regular motion produced by the balance spring changes into a pendulum motion, due to the attractive force of the magnet. When the arm is permanently charged with magnetism, the terrestrial magnetic elements also influence it, and even after it is no longer exposed to further magnetic influences, the motion of the balance spring must then combine with the terrestrial magnetism. The magnetism acts upon the arched parts of the balance in about the same manner as upon the balance spring.

If from the preceding it appears established, on the one hand, that by the operation of magnetic forces upon the balance and balance spring, if of steel, the isochronism of their vibrations can be impaired, they may on the other hand, occur also of such strength as to cause a noticeable alteration of the rate. When in a thunderstorm, after strong flashes of lightning, a sudden simultaneous jump is observed in six chronometers, there can no longer exist a doubt but that the cause is due to magnetic influences. The only lesson to be drawn from this, is that the use of iron or steel is to be avoided as much as possible in the construction of

## CROUCH & FITZGERALD,

Jewelry Trunks  
and Cases.

161 Broadway

Bet. Cortlandt and  
Liberty Sts.,

688 B'way,

701 6th Ave.,

NEW YORK



Sold by all wholesale dealers at manufacturer's price.

A. N. CLARK,  
PLAINVILLE,  
CONN.

Manufacturer of the Celebrated  
**LOOP WATCH KEY.**

The Best for the Price in the World.  
CROSBY'S JEWELING TOOLS IMPROVED.

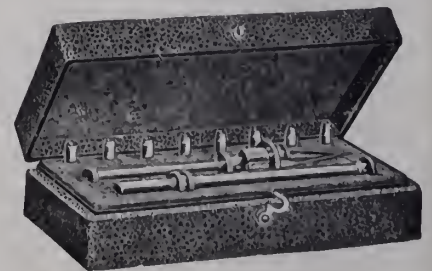
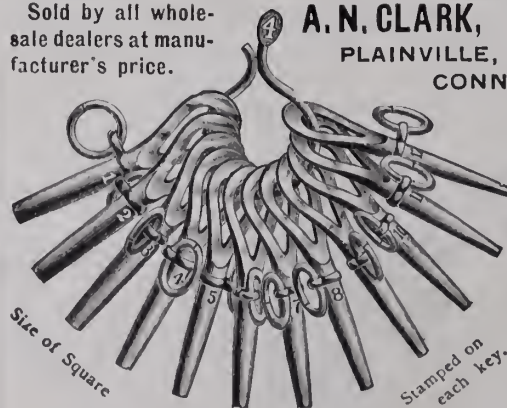

Will quote royalty or price for the manufacturing of articles of real worth.



chronometers, but more especially in the balance and its spring. Before everything else, the captain should know the composition of his chronometer, not only for correctly judging incidental changes observed in the timepiece, but also for employing precautions by a judicious placement, to guard against all disturbing influences if his chronometer contains steel parts.

To be correctly informed about the faulty condition of the location where the chronometer is to be placed, Lieutenant Tromelin proposes to employ a small quickly-moving hanging magnetic needle. To show how easily alterations in the magnetic character are produced by trifling causes he mentions a very interesting case which happened on board the *Tonnère*. The steering compass, enclosed in a compass house entirely of sheet iron, showed noticeable and very irregular differences of from 5° to 15° in the deviation of the compass, both day and night. It was at first believed that this phenomenon was due to the heating of the compass house and ship by day and the subsequent cooling at night; but the insufficiency of this assumption was quickly seen, because this thermic difference could not produce these large magnetic deviations. The compass house was overhauled thoroughly with the small magnetic needle, and it was found that there were in it a few movable parts of a strongly pronounced magnetic polarity, to wit, the doors and windows, which were opened in day time on account of the heat, and closed at night. They were replaced by others of brass, after which the occurrence ceased.

In order to protect the chronometers having steel balance arms against the magnetic influences induced by the alterations of the course of the ship, Tromelin proposes to enclose them in their iron receptacles. Other propositions made for the placement of a chronometer on board and remote from all iron parts, especially the vertical, are doubtless known and do not require elucidation.

Flower brooches of natural onyx are worn. These have a translucent brownish tinge. They are tipped with gold, and sprinkled appropriately with tiny diamonds.

**Workshop Notes.**

**Artificial Safety Lamp.**—The use of the ordinary lamp or of matches should never be permitted in dangerous places for obvious reasons, and the watchmen of the city of Paris have resorted to the following contrivance, which is at once very convenient and quite safe. A small piece of phosphorus of about the size of a pea is put into a very clear glass bottle, which is then filled about one-third with boiling olive oil, after which it is corked tightly. When the light is to be used, uncork the bottle for an instant, then recork tightly, and a light equal to that furnished by a lamp will issue from the bottle. When it becomes dim, uncork the bottle for a short time so as to admit fresh air.

**Bronzing Brass.**—Sannier recommends the following fluids: Copper turnings are to be dissolved in nitric acid until they are completely saturated, and in this fluid immerse the brass objects to be bronzed after they have been cleaned, smoothed with water-of-Ayrestone, and heated to such a degree as the hand can just support; on being placed over a charcoal fire, they will assume a green color; rub them over with rags, repeat the immersion and heating over charcoal until the required tint is obtained. The shade may be improved by oiling the finished surfaces. It is asserted that by immersing copper articles in molten sulphur containing lampblack in suspension, they assume the appearance of bronze, and that they may even be polished without losing their color.

**To Polish Jewel Settings.**—A very good way to polish jewel settings for American watches, on brass or gold, is as follows: First turn the setting to the right thickness, or nearly so, and then grind down to a gray on a ground glass slab with rotten stone and oil; then clear off the oily rotten stone and polish on a boxwood lap with diamantine and oil, which gives a nice gloss. It will also give a nice gloss on steel, only use oilstone to gray steel with, instead of rotten stone. The operator should be particular to clean off all the gray-ing powder in each case before using the boxwood lap, and be sure to keep the lap in

a place free from grit or dust when not in use; brass watch wheels can be finished in the same way as the jewel settings by the same process.

**THE BEST PIVOT DRILLS IN THE WORLD.**

One Gross without charge for proof that this is not so.

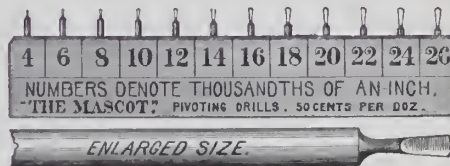

**The Mascot, 50 Cents per doz.**

By all Jobbers, or sent post-paid on receipt of price.

**Ezra F. Bowman & Co.,**  
LANCASTER, PA.

**KOBEL & MEYER,**

Berthoud, Switzerland,

Manufacturers of Fine

**WATCH JEWELS,**

All grades and sizes, principally for Regulators, Clocks, Telegraphic Instruments, Compasses, Music Boxes, Mechanical Movements, Physical and Mathematical Instruments.

**...JEWELS...**

Top Jewels for Marine Clocks, and Large Center Stones for Chronometers and Fine Watches.

**Exportation to all Countries.**

We buy and sell White and Black Diamonds, Garnets, Rubies and Sapphires for making Watch Jewels.

**No File Equals the "GLARDON" File**

is the universal verdict of the trade.



LARGEST ASSORTMENT IN THE UNITED STATES.

**F. W. GESSWEIN, 39 John Street, New York.**

SOLE AGENT FOR UNITED STATES AND CANADA.

# Grand STREET Exhibition!

To the Jewelers.....

You have visited the World's Fair, now come and see us.  
You will find in our Warerooms more ARTISTIC NOVELTIES than you have seen at Jackson Park

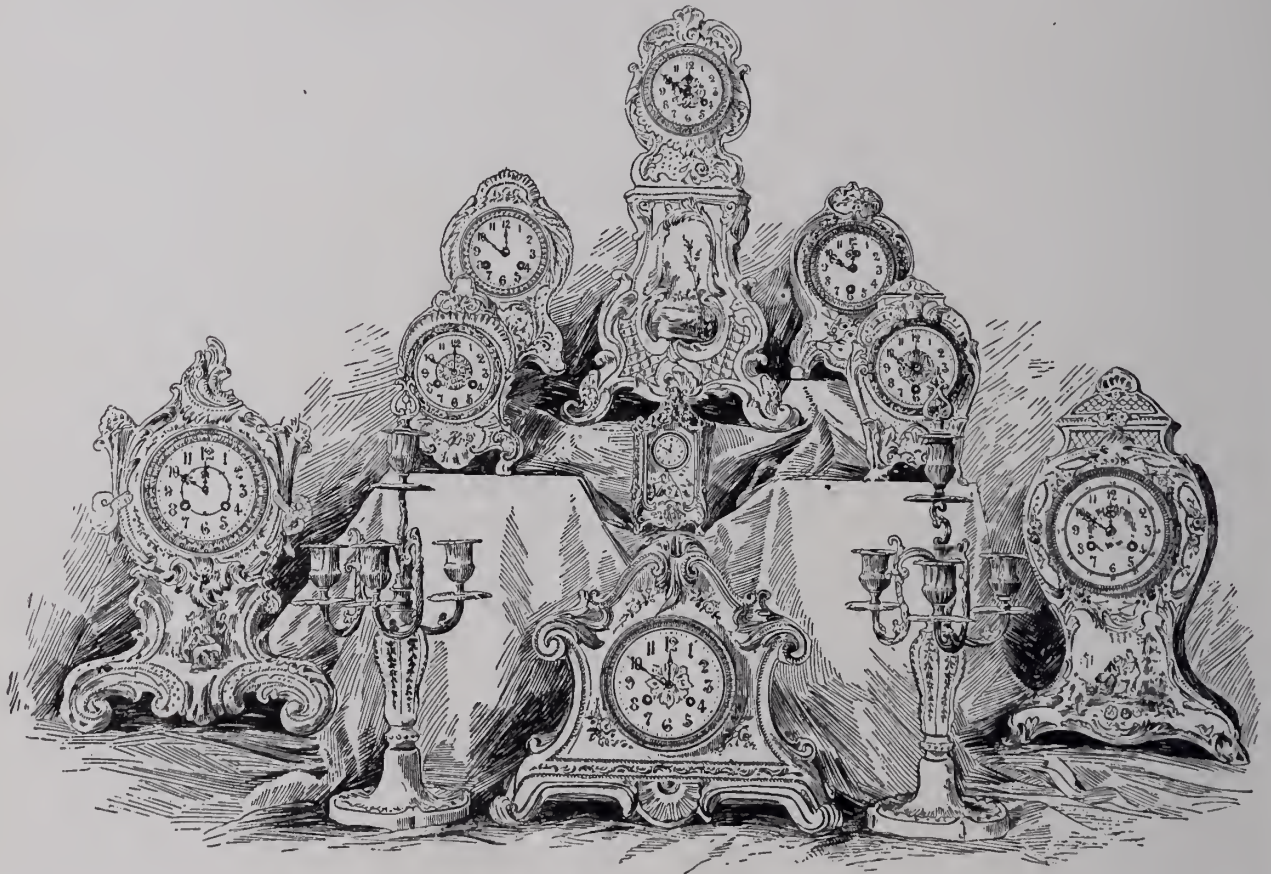

**France**==BRONZES, CLOCKS OF ALL DESCRIPTIONS, SEVRES VASES, LAMPS, PORCELAINS, FINE FURNITURE.

**Germany**==ROYAL BERLIN, ROYAL BONN, NURNBERG MAJOLICA, DRESDEN VASES, DRESDEN LAMPS IN ENDLESS VARIETY, DRESDEN FURNITURE, IVORIES.

**Austria**==DECORATED GLASS, OLD VIENNA WARE, TEPLITZ GOODS, FAYENCE STATUARY, BRONZES.

**Italy**==SUPERB LINE OF CARRARA AND CASTELLINA MARBLES, NOVE AND BASSANO FAYENCE, CARVED FURNITURE.

**England**==ROYAL WORCESTER, COALPORT, TULIP GLASS, ENGLISH CHIMING HALL CLOCKS.

## Ferdinand Bing & Co.,

74 Rue d'Hauteville,  
PARIS.

106 Grand Street,  
NEW YORK.



**Fine New Lines of Leon J. Glaenzer & Co.**

A FEW of the new lines which on every side surround the visitor to the ware-

rooms of Leon J. Glaenzer & Co., 80 Chambers St., New York, are represented in the group depicted in the illustration herewith. The main feature, the clock, is of solid mahogany, with real bronze trimmings. The style is that of the First Empire. It is fitted with an Elliot movement striking the Whittington and Westminster chimes. The piece is a fair example of the superior line of these clocks now carried by this firm.

The bric-à-brac cabinet, which is of pure Louis XVI. style, contains a choice assortment of Sèvres bonbonnières and a few patterns of the latest Louis XV. and Louis XVI. porcelain boudoir clocks, with their exquisite Watteau decorations.

The bronze-gilt and ornamented clock set is a beautiful specimen of the latest style of dainty mantel clocks, which from

present appearances bid fair to equal and even excel in popularity its predecessor, the porcelain clocks.

The beauty of the tea set, with its ground color of turquoise blue, is augmented by

specimens of the Boucher and combination of Boucher and Watteau styles of decorations.

The manufacture of porcelain in Japan,

and we ought also to add in China, is as old as any art probably in the country; her ceramic colors, as well as her want of perspective, are amongst the oldest of her successes and her failures. If time were talent, China and Japan would head the world, for industry seems innate in them; indeed, from what we see of their work, and what we hear of those who have visited them, they seem to make work into a penal infliction.

Imagine one work in metal taking years to accomplish, and in some few cases a life has been spent in one work; it seems a transportation to art, and if this infliction means anything, it means insanity or self-imprisonment. That

art without industry must fail we admit, but industry has its limits, and is not the *summum bonum* of art.

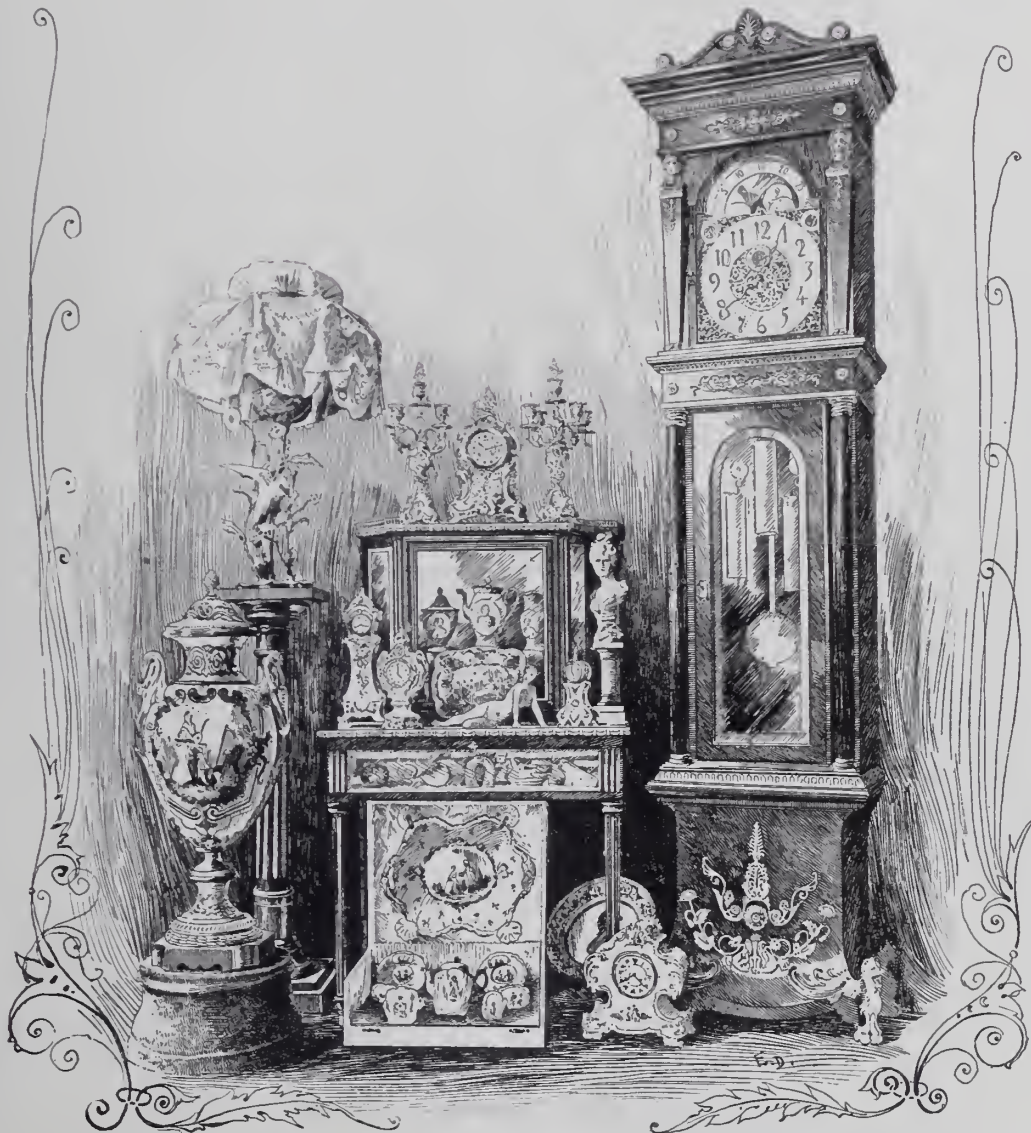

SPECIMENS OF FALL LINES IMPORTED BY LEON J. GLAENZER & CO.

the Watteau decorations which ornament it. This set is a fitting representative of its line, in which may also be seen exquisite

## The Connoisseur.

(Continued from page 47.)

### The Rambler's Notes.

WHAT THE RAMBLER SAW AND HEARD AMONG THE DEALERS IN ART POTTERY, CUT GLASS, BRONZES, ETC.

JEWELERS who anticipate putting in a bric-à-brac department, and buyers in general in this line, will find an exceptional opportunity in the offer of George Borgfeldt & Co., 18 Washington Place, New York, who are disposing of their entire collection of import samples of high art novelties specially imported for the jewelry trade, in order to make room for new importations of fine pottery, art furniture, marbles, etc. Dealers who are about to carry these goods for the first time can obtain for \$500 a varied assortment of bric-à-brac from the finest art potteries of the world. These pieces are all samples imported last Spring and are sold at prices below the cost of importation.

\*

L. Straus & Sons, 42 Warren St. New York, are now exhibiting their complete line of marble statues, groups, busts, etc., which is pronounced by all who have seen it to be one of the most beautiful ever shown on this side of the Atlantic. The variety is so great as to entirely fill the

large new store which faces on 116 Chambers St. At the front of the store are two colossal busts in Castellina marble, representing Apollo and Diana. These are the largest and most beautiful marbles ever shown by this firm. Behind them is a well executed figure in Cararra marble, called "Surprised," representing a woman *en deshabillé*. Among other beautiful pieces in Cararra are, "Psyche," "Ariadne on the Panther," shown also in Castellina, and beautiful busts of Hebe, Mercury, Venus of Milo, Venus of Medici, and others. Among the principal groups in Castellina may be mentioned "Romeo and Juliet," shown in many sizes, and the companion pieces, "First Kiss" and "First Quarrel."

\*

Levy, Dreyfus & Co., 11 Maiden Lane, New York, have opened up a line of modern Sèvres which they alone control. The line is especially adapted to the jewelry trade and consists of articles for table decoration, ornamental pieces for mantels and cabinets, as well as a fine assortment of pieces particularly suitable as wedding and holiday presents. The pieces have entirely new gilt decorations, and are very rich and quite inexpensive as compared with similar goods imported heretofore.

THE RAMBLER.

The new chocolate cups are very high and narrow, a shape suitable for keeping the chocolate hot.

## Fashions, Fads and Fancies.

ELSIE BEE'S RAMBLES AMONG THE IMPORTERS AND DEALERS OF ART POTTERY, BRIC-A-BRAC, ETC.

Wall vases of china are shaped like orchids. The calytra is the principal model.

German porcelain with Dresden designs and raised work has been brought out in fancy forms of all sorts.

The colors of the fashionable world are repeated in the newest imported glass. These are mauve and green.

A new glass brought out in shell forms is intended to suggest Egyptian wares that were found at Pompeii. It is odd and the shapes are marine in their suggestion.

The white and ornamental glass vases with gold tracery as seen in the new importations are further enriched by jewelery. Italian interlaced lines are conspicuous set with raised enamels. Turquoise and ruby are the prominent tints.

The tall vases of green glass reach colossal heights. One seen was seven feet high. It was tall, ribbed and flaringly mouthed. These glasses are intended for a few stalks only, and the stems and foliage seen through the glass are its special feature. From this size these green flower vases descend to half a foot in height.

Wall cabinets, Japanese in form and black in color are supported on twisted faience pillars. These have Dresden designs and raised work. Underneath the pillars is a



## Exceptional Opportunity

FOR

## Bric-a-Brac Buyers!

OUR entire collection of IMPORT SAMPLES of HIGH ART NOVELTIES, specially imported for the Jewelry

Trade, are now on exhibition and will be sold on and after Sept. 1st, at Big Reductions to make room for new importations of Fine Pottery, Art Furniture, Marbles, Exclusive Art Productions, &c.

## GEO. BORGFELDT & CO.,

18, 20, 22 WASHINGTON PLACE, cor. Greene Street, NEW YORK.

# ANNOUNCEMENT



**FALL, 1893.**

Our Importations for the coming season are now arriving and we have on exhibition at our ware-rooms a complete assortment of exclusive

## Novelties and Specialties

SELECTED FOR THE JEWELRY TRADE.

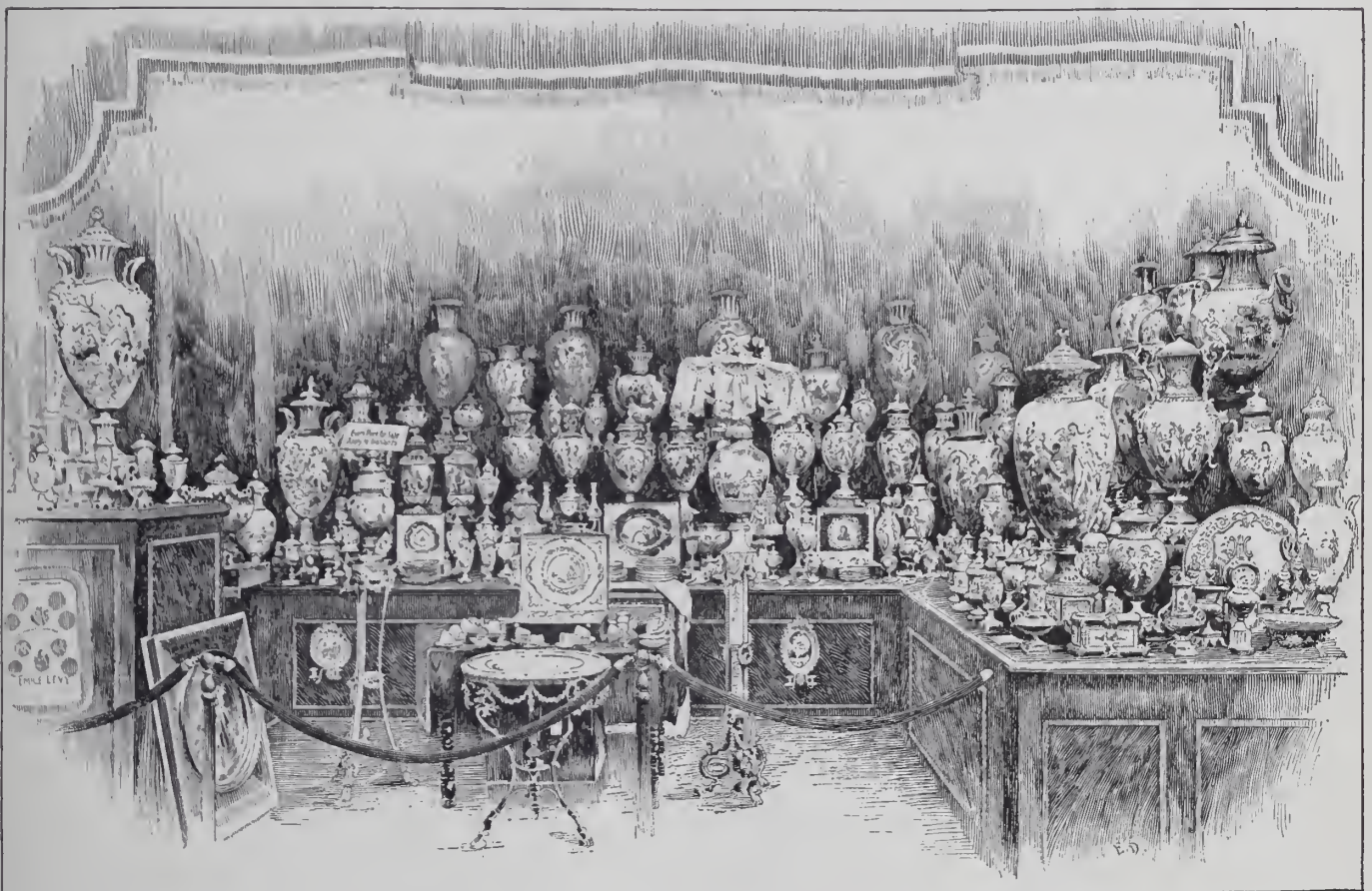

PAVILION CONTAINING THE KERAMIC EXHIBIT OF LEON J. GLAENZER & CO., AT THE WORLD'S FAIR.

Clocks, Bronzes, Sevres Vases, Fine Decorated Porcelains, Cups and Saucers, Tea Sets, Lamps and gilt and silver plated filigree Photo Frames in endless variety.

# LEON J. GLAENZER & CO.,

35 Boulevard de Strasburg, Paris,

80 & 82 CHAMBERS ST., N. Y.

sprawling Cupid on whose back the shelf apparently rests, and the supports are crowned by tiny figures. These are novel and pretty.

Perforated china is among the prevailing styles.

Faience clocks are shown with reference to room decoration.

The tall branching candlesticks in German faience are sumptuous.

Cabinets of inlaid woods, brass mounted, are lavishly adorned with faience plaques.

Broken edged dishes rimmed in gilt follow silver designs. Dull gold shading unevenly inwards is a favorite decoration.

Candlesticks in white ware, in the form of fluted columns, are intended for special decoration, according to the colors of the room in which they are to be placed.

Banjoes, mandolins, guitars, fiddles and tambourines in white ware for china decoration are in such profusion as to indicate a busy Winter among the china painters.

A new glass is called aquarelle, because it has decorations in broad water color effects. The body of the glass is fle-h tinted and appears in vases and flower bowls.

There is a good deal of modern design and subjects in decorative china. Some of the handsomest plates for the table have each as a design a modern woman in Paris clothes.

ELSIE BEE.

### New Productions in Adderley.

**A**DDERLEY & CO., manufacturers of a class of art pottery that is becoming more and more in demand among jewelers, have produced some fine china goods, their dessert services being especially attractive. The "Osborne" shape is an effective one and is shown with a great variety of decoration. The "Sèvres" dessert set is nicely modeled with embossed scroll edges, and is pleasing in quite a number of painted and gilt patterns. Some with dull gold ornamentation are very rich. The oval dishes to this set are highly ornamental in the shape, apart from the painting and gilding. In tea sets Messrs. Adderley show some pretty and new goods. These include tasteful fluted cups and saucers of various kinds. The "Nero" is a spiral fluted and quite new registered design.

A new pattern after the Queen Anne style is shown in both tall and low cups. It is a well shaped set, sharply modeled, and looks handsome in plain white, with solid gold handles. There are also some rich decorations on the same shape.

Geo. Jordan, Redlands, Cal., has on exhibition in his window a number of mounted rattlesnake skins with the rattles on. Mr. Jordan dresses the skins and mounts them for belts. They make an attractive as well as an expensive belt, and are quite fashionable in that town.

### The Other Side of Life.

The child who was born with a silver spoon is now beginning to look down in the mouth.—*Puck*.

#### THE TIME O' DAY.

SALLIE MORRIS (hearing the clock strike)—What time is that, mece?

NIECE (meekly)—Five o'clock, aunt.

SALLIE MORRIS (fretfully)—Five o'clock! What is it so late as that for at this time of day?—*Judge*.

#### THE COLLECTING FAD.

CLARA—And are you having a nice time this Summer?

LOUISE—Perfectly lovely! I don't want to boast, dear, but when I return to Syracuse I'll have the finest collection of souvenir engagement rings that you ever saw.—*Judge*.

#### HIS CUFFS WERE COMME IL FAUT.

Algernon De Fizzleworth's prospects were wrecked. He was going where so many young men of financial ambition go—to jail.

"There is only one comfort," he sighed as he glanced at his well-cared-for hands.

"What is that?" asked the friend who was bidding him good-by.

"I see that the officer has been so considerate as to have my handcuffs fastened with links."—*Judge*.

**WE** beg to notify our friends that our stock is now complete with all the latest productions. You will find goods especially adapted to the Jewellery Trade, such as

**Royal Worcester,**

**Sevres,**

**Doulton,**

**Crown Derby,**

**Crown Vienna,**

**Royal Bonn,**

**M. Redon,**

**Carlsbad,**

**AND OTHER CHOICE AND DESIRABLE LINES.**

Give us an early call as it will be to your interest to do so.

**CHARLES AHRENFELDT & SON,**

50, 52 and 54 Murray St.,

New York.

PARIS.

LIMOGES.

DRESDEN.

CARLSBAD.

New York, Sept., 1893.



# An Open Letter.....

TO THE JEWELERS ;

DEAR SIRs:—Every jeweler should be interested in seeing our new stock from the Art Centers of Europe, suitable for wedding presents and for the holidays. It is conceded to be the finest and best selected line ever brought to this country.

Many are anticipating a scarcity of new and choice goods later on, as importers generally have not ordered sufficiently for their usual wants; we however are not speculating in that direction and will offer inducements in the way of low prices to our customers and for new trade. We wish to encourage everybody to make their purchases from us by our course adopted as stated above.

Dealers visiting New York will find us in the neighborhood of the largest wholesale, importers of other lines of goods which only jewelers use.

Yours Respectfully,

**LEVY, DREYFUS & CO.,**

PURVEYORS TO THE JEWELRY TRADE,

ART DEPARTMENT, 9 MAIDEN LANE, N. Y.

P. S.—We are offering a lot of import samples at less than 50 per cent. on the original cost. These special goods however are not quite perfect, they having been used for import orders.

## Rich Cut Glass

AND

### DECORATED ART WARES.



Mt. Washington Glass Co.,

New Bedford, Mass.

RICH DISPLAY OF GOODS AT

New York Store: 46 Murray St.

When you visit Chicago do not fail to inspect our full line of goods at the new store of Pairpoint Mfg. Co., 224 Wabash Avenue.

ESTABLISHED 1870.

### J. L. CLARK,

**SWEEP SMELTER AND REFINER OF GOLD AND SILVER.**

Buy every kind of Gold and Silverware, Jewelry, Watches and Platinum. Full market value paid.

**No. 724 Filbert Street, Philadelphia, Pa.**

SEND BY EXPRESS or Registered Mail. If my price is not satisfactory, I will return all articles.

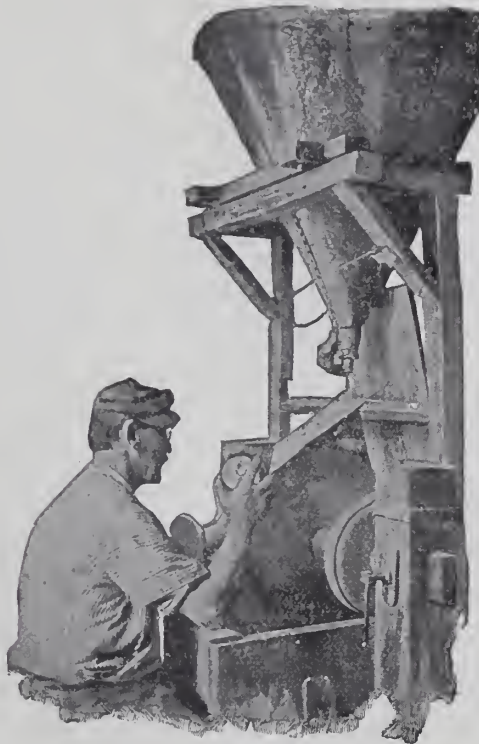

GLASS CUTTER AT WORK.

## LATEST AND BEST ELK'S TOOTH BADGE.



CAN BE USED AS A CHARM BY SIMPLY DETACHING BAR FROM TOOTH.

Reverse shows the symbolic flower of the Benevolent and Protective Order of Elks, the forget-me-not, beautifully enamelled in colors; also the letters B. P. O. E.

MANUFACTURED BY

**G. A. SCHLECHTER,**  
READING, PA.

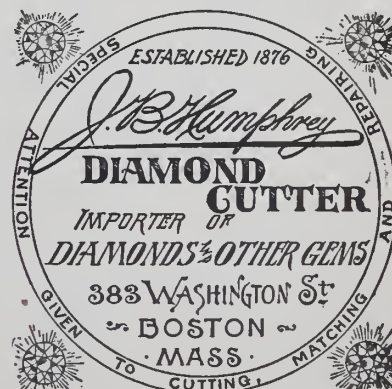

WOLFF & GUNZBURGER, Importers of DIAMONDS, NEW YORK.

**FALKENAU, OPPENHEIMER & Co. DIAMONDS**  
40 MAIDEN LANE NEW YORK

**FINE OPALS.**

**M. D. ROTHSCHILD,**  
NEW YORK: 41 & 43 MAIDEN LANE  
LONDON: 15 HOLBORN VIADUCT  
PARIS: 58 RUE LAFFITTE.

**CHAS. S. PLATT,**  
1837. Successor to Geo. W. Platt, 1881  
GOLD AND SILVER  
REFINER, ASSAYER

AND SWEEP SMELTER.  
29 & 31 Gold St., Near John St. New York.  
Platers and Electro-Platers' Silver  
Platinum and Aluminum.

FRENCH WRITE FOR CATALOGUE. ENGLISH  
**CLOCKS**

AND CLOCK MATERIALS.  
CHAS. JACQUES CLOCK CO., 22 CORTLANDT ST., N. Y.

**L. LELONG & BRO.,**  
GOLD AND SILVER  
Refiners, Assayers AND Sweep Smelters,  
SOUTHWEST CORNER HALSEY AND MARSHALL STREETS,  
**NEWARK, N. J.**  
SWEEPINGS A SPECIALTY.

**S. P. HOWARD,**  
Gold and Silver Assayer.  
Refiner and Sweep Smelter,  
33 MAIDEN LANE, NEW YORK.  
Smelting and Refining Works,  
28 & 30 Cumberland Street, Brooklyn, N. Y.  
Specialties: Sweepings, Gold, Silver and Platinum

**HENRY ABBOTT,**  
MANUFACTURER OF  
Stem-Winding Attachments  
FOR WATCHES,  
No. 2 Maiden Lane, NEW YORK.



have in 45 years earned the reputation of being the standard in quality, style, finish and durability. They are made of solid gold, in great variety, for men, women and children.

**ASK YOUR JEWELER FOR THEM.**

If he don't keep them and won't send for them, send us your money and we will deliver them through the nearest reliable jeweler.

**OUR INITIAL AND RAILROAD BROTHERHOOD RINGS**

With or without diamonds, are the handsomest made.



**M. B. BRYANT & CO.,** No. 10 Maiden Lane, New York.  
OLDEST RING MAKERS IN AMERICA.

**The Bryant Rings**

Are extensively advertised in the leading magazines, Family, Religious and Fashion papers for the benefit of the Retail Jeweler.

The adjoining advertisement will appear for a year in the great R. R. BROTHERHOOD Journals.

PRICES of our INTERCHANGEABLE Rings either with emblems with six diamonds, or without diamonds will be sent to Jewelers only application.

**WHY** S. F. MYERS & CO. sell more goods than any other Wholesale Jewelry House. **BECAUSE** They are the only firm in the Metropolis who carry in stock a full line of everything a jeweler requires. They give the utmost values and endeavor to please their trade in every respect. Refer to their various publications and Illustrated catalogues.  
**MYERS BUILDINGS, 48 & 50 Maiden Lane, NEW YORK.**

**ALBERT LORSCH & CO.**

37 MAIDEN LANE, NEW YORK.

Branch, 167 Broad Street, Providence, R. I.

— IMPORTERS OF DIAMONDS, —

Rose Diamonds, Rubies, Sapphires, Emeralds, Opals, Moonstones, Fancy and IMITATION STONES, NOVELTIES.

SOLE OWNERS AND IMPORTERS OF

*The Sumatra Gem.*  
REG'D.

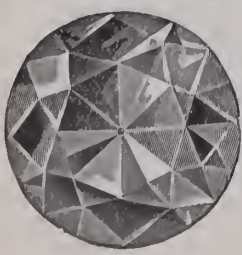



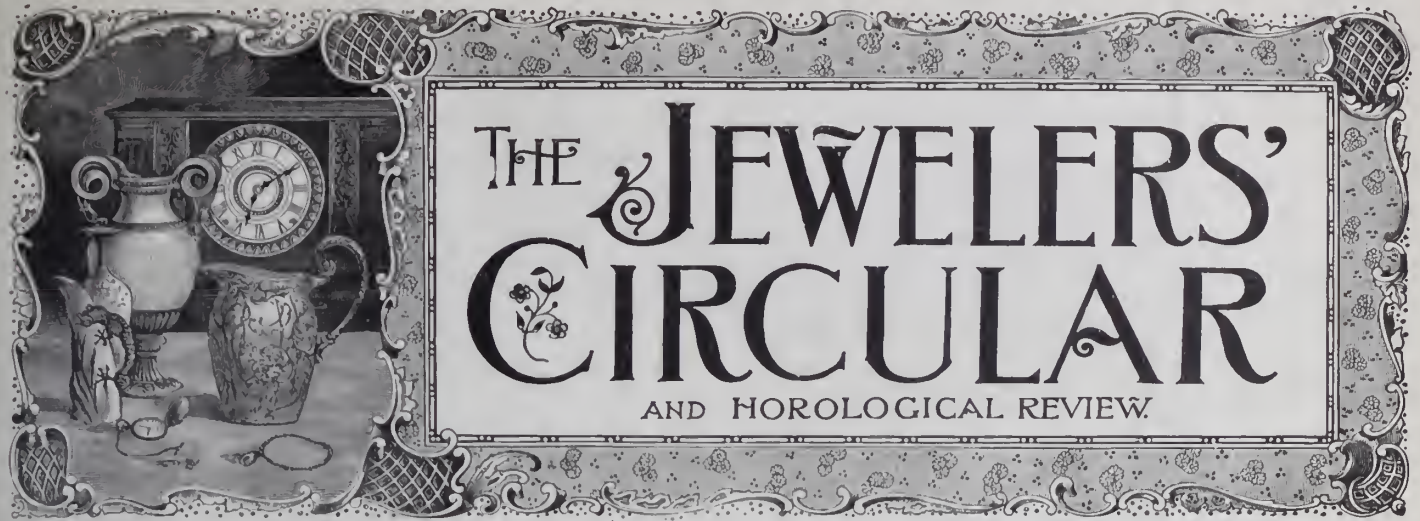

Copyright, by THE JEWELERS' CIRCULAR PUB. CO.

189 Broadway, New York.

Entered at the Post Office in N. Y. as second-class matter.

VOL. XXVII.

NEW YORK, WEDNESDAY, SEPTEMBER 27, 1893.

NO. 9.

A WORK IN SILVER WORTH WINNING.

BESIDES the *America's Cup*, which is known so well, and must always be regarded among lovers of the fine sport of yacht racing, as the supreme trophy, there are three other cups for international racing—the Brenton Reef and Cape May challenge cups, and the Royal Victoria Yacht Club International Challenge Cup. All have been brought before the yachting world with particular prominence by the presence of the American yacht *Navahoe* in British water. Since *Genesta* carried both the Cape May and Brenton Reef cups over to England in 1885, there has been no American challenger until Royal Phelps Carroll this year determined to have a try at winning them back, and no American yacht has ever sailed for the Victoria Cup, which was offered for the first time two years ago. Both the American cups, Cape May and Brenton Reef, were given to the New York Yacht Club in 1872 by James Gordon Bennett, at that time Commodore of the club, as perpetual challenge trophies. It is a matter of congratulation that the gallant owner of the *Navahoe* has succeeded in regaining one of the cups, the Brenton Reef. THE CIRCULAR has previously illustrated and described the *America's cup*, and the Royal Victoria cup, and now takes occasion to bring before its readers a picture of the Brenton Reef cup, a fine work in silver, now more interesting than ever to the general public, as a regained trophy.

Twenty years ago the cup was considered very elaborate, and was at that time among Tiffany & Co.'s best productions.

"The Karat." Mr. Kunz showed that there are fifteen different standards in the world

the last twenty years, which has amounted to \$60,000,000, there is a great necessity for an international standard by which to determine the weight of precious stones.



THE BRENTON REEF CUP.

Diamonds in Borneo.

IT is stated that discoveries of diamonds have been made in the Landak district of Borneo, and a company has been formed to work the mines. Sir Stamford Raffles, for some years Lieutenant-Governor of Java and founder of Singapore, wrote in 1819 of the great and rich displays of diamonds then made by the ladies of Batavia, the only mart then open for the products of the Bornean mines. Diamonds are said to be in the possession of native rajahs weighing 10, 14, 18, up to 60 karats. Landak has produced one of the largest diamonds of the world, weighing no less than 367 karats (uncut).

The district of Landak is situated a few miles to the east-northeast of Pontinak, the capital of Dutch Borneo, and consists of a narrow strip of land, through which the river of the same name flows. Foreign attention has been specially attracted to three localities within the district, but the diamondiferous fields extend more widely from north to south than from east to west; and while the actual area already worked over is considerable, its size as compared to the gem bearing district, as a whole is inconsiderable. Landak is about three days steam from Singapore.

A number of the diamonds already found have been taken from the beds of the streams. Under normal circumstances the gravel containing the precious particles has to be brought up by divers. But every few years an abnormally dry season occurs.

One of the most interesting papers read at Chicago, was that of George F. Kunz, specialist on precious stones for Tiffany & Co. His paper was entitled

in relation to the karat. In view of the great amount of business done in gems during

up by divers. But every few years an abnormally dry season occurs.

# THESE LEATHERS ARE MADE IN THE FOLLOWING ARTICLES:

- Card Cases,
- Pocket Books,
- Photo. Frames,
- Calendars,
- Folios,
- Purses,
- Combination Books,
- Desk Pads,
- Cigar Cases,
- Prayer Books and Hymnals,
- Stamp Cases,
- Watch Card Cases,
- Marriage Registers,

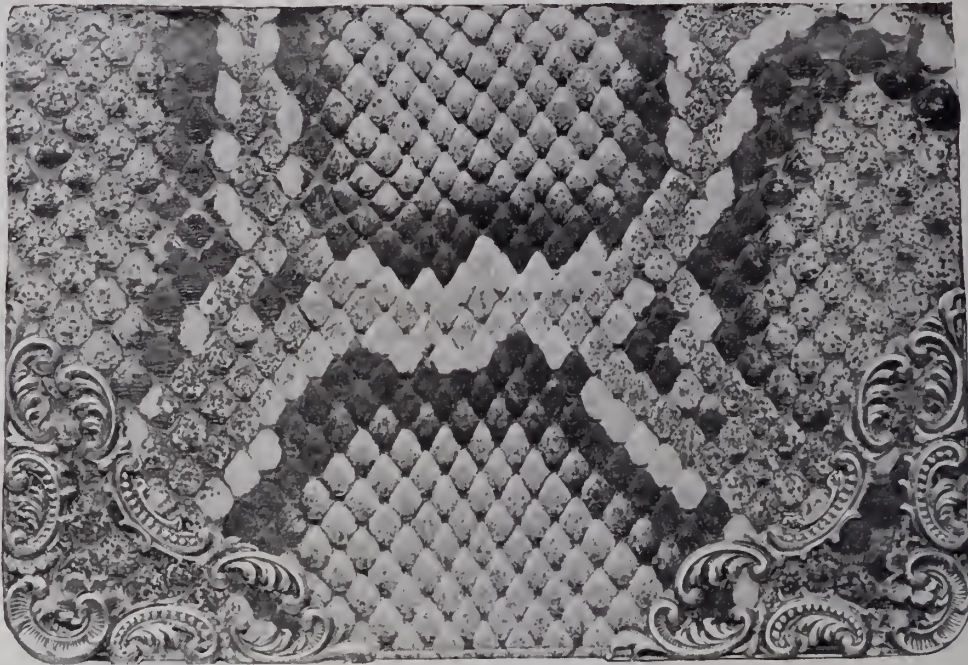

NATURAL SNAKE CARD CASE—STERLING CORNERS—"ROCOCCO."

- Spectacle Cases,
- Memo. Books,
- Check Blotters,
- Address Books,
- Visiting Books,
- Bill Folds,
- Cigarette Cases,
- Engagement Pads,
- Eye Glass Cases,
- Finger Prayer Books,
- Telegraph Pads,
- Chatelaine Bags,
- Pen Wipers.

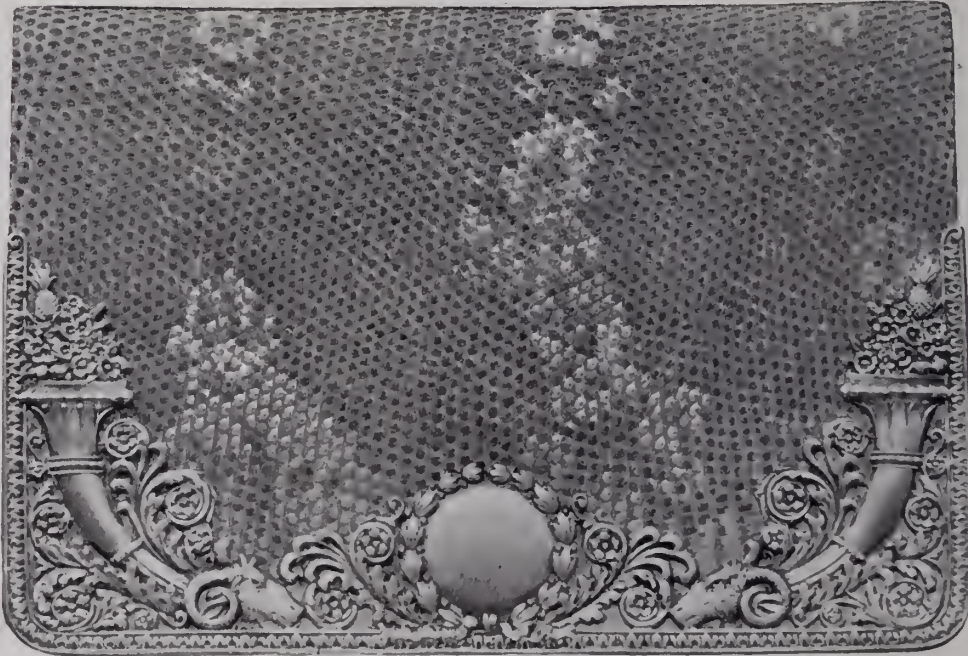

NATURAL LIZARD COMBINATION—STERLING FRONT—"EMPIRE."

# DEITSCH BROS., MAKERS,

7 EAST 17th STREET, NEW YORK.

ORIGINATORS OF NOVELTIES IN LEATHER AND STERLING SILVER COMBINATIONS.

MARJORIE.



INITIAL.



ILLUSTRATING DESIGNS OF  
 EBONY AND SILVER

COMBINATIONS

—IN—

TOILET SETS.

DEITSCH BROS.,

—ORIGINATORS OF NOVELTIES—

—IN—

—Ebony and Silver Combinations.—

7 EAST 17TH STREET, NEW YORK CITY.

“DO YOU KNOW?”

THAT GOODS FREE FROM SOLDER ARE THE BEST?

THAT GOODS MADE FROM SEAMLESS WIRE ARE SUPERIOR IN FINISH ON THIS ACCOUNT?

THAT SEAMLESS WIRE MAKES THE BEST FILLED CHAINS?

THAT WE ARE THE MAKERS OF THE ORIGINAL AND CELEBRATED

SEAMLESS GOLD FILLED CHAINS?



Do not fail to visit our beautiful and artistic display at the World's Fair. The finest of its kind at the Exposition.



Northeast Corner of Manufactures Building, Department O.  
Right on the corner. See Official Catalogue.



**Kent & Stanley Co.,**

BRANCH OFFICES:

NEW YORK: 17 MAIDEN LANE. SAN FRANCISCO: PHELAN BUILDING.  
BOSTON, 58 WINTER STREET, MONTREAL, TEMPLE BUILDING.

MAIN OFFICE AND WORKS:

**PROVIDENCE, R. I.**

**AIKIN, LAMBERT & CO.**

19 Maiden Lane, NEW YORK.

Branch, 42 & 44 East Madison St, CHICAGO, ILL.

Manufacturers and Exporters of

Gold Pens, Holders, Picks, Pencils,

Fountain Pens, etc.

SHOW CASE AND TRAY ASSORTMENTS IN NEW DESIGNS.

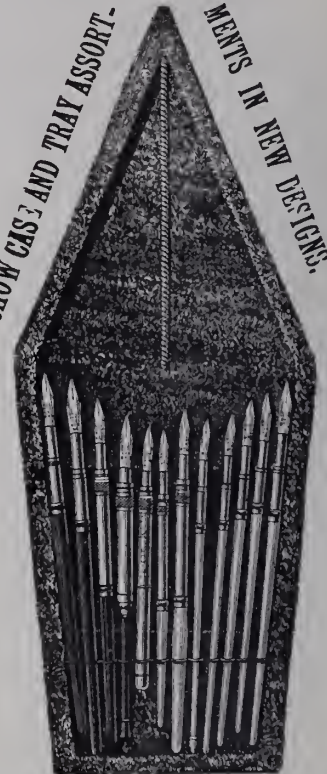

11 x 5 1/2 inches.

PLUSH TRAY WITH EASEL BACK.

1 Doz. 16 K. Pens and Assorted Holders, List, \$3.

1 Doz. 10 K. Pens and Assorted Holders, List, \$24

Send for Trade Discount.

**OPTICIANS' SUPPLIES**

Jobbing and Prescription Work.

The "Graduate" Trial Cases, 180 1/2 set, \$30.00; 220 lens set, \$37.50. The "Standard" Trial Case, 220 lens set, \$85.00. All with rings. Loring Ophthalmoscope, \$9.00. Artificial Eyes, for selection, \$1.00 each, \$50.00 for hundred. Ophthalmometers, \$50.00 to \$70.00. Queen's Standard Perimeter, \$18.50. Queen's Lens Grinding Outfit, \$1.00. Steel Frames, 15 1/2 cents each. Spherical Lenses, 25 cents per pair. Cylinders, 35 cents per pair. Lenticular Bifocals, 8 cents per pair, (all beveled). Nose pieces, for Shell German Silver, \$1.00 per dozen pairs. Gold, \$2.00 per dozen pairs.

**QUEEN & CO.** Opticians and

Catalogue free, 1010 Chestnut St., Phila., Pa.

THE SIMPLE SAMPLE BOX.

FOR MAILING JEWELRY & C.

AMERICAN RAILWAY SUPPLY CO  
24 Park Place, NEW YORK.

For **BADGES AND MEDALS.**

Flag Pins, Class Pins, Class Rings  
and Special Work of all Descriptions

SEND TO **E. R. STOCKWELL**, MANUF'G.  
19 John Street, New York

# The "Pairpoint" MFG. COMPANY

....New Bedford, Mass.

## SUPERIOR SILVER PLATE.



No. 5402, Ink.

**Do Not Fail** to see our Exhibit at Columbian Exposition, Section N, Manufactures Building, and our Store, 224 Wabash Avenue, Chicago.



No. 4903, Smoking Set.

### SALESROOMS:

NEW YORK,  
20 Maiden Lane.

CHICAGO,  
224 Wabash Ave.

SAN FRANCISCO,  
220 Sutter Street.

## CHAS. L. UHRY & Co.

N. Y. OFFICE,

189 BROADWAY.

- SCARF PINS,
- BROOCHES,
- CHARMS,
- FOBS.
- HAT PINS,
- HAIR PINS,
- CHATELAINES.

336 Mulberry St., Newark, N. J.

## CHAS. L. UHRY & Co.

### Bruner Plating and Jewelry Rep. Co.

Jewelry Matched and Repaired, Engraving, Chasing and Enameling, Setting, Polishing and Lapping, Battery Gilding and Roman Coloring, Watch Cases Repaired, Polished and Gilded.

32 Maiden Lane, New York.

We sell to the legitimate Jewelry and Stationery trade only.



NEW YORK

CITY. U.S.A

## CHOICE PAPERS

MAKERS OF

## FINE STATIONERY

For Correspondence, Wedding and Business Use, handsomely boxed, specially suited to the Jewelry Trade.

18 MURRAY STREET, NEW YORK.

# WORLD'S FAIR SOUVENIRS.

\* STERLING SILVER. \*



THE COLUMBUS.



REVERSE SIDE OF HANDLE.



REVERSE SIDE OF HANDLE.



THE DISCOVERER.



REVERSE SIDE OF HANDLE.



THE AMERICAN.

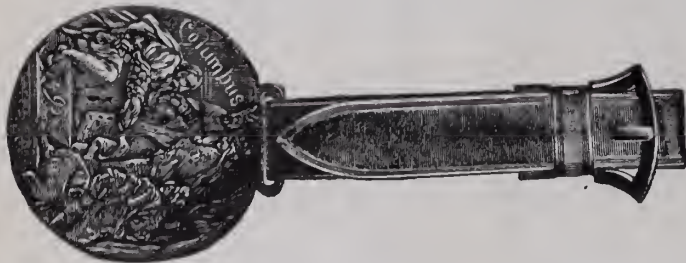

No. 2. BAGGAGE CHECK.



MATCH BOX.

## R. WALLACE & SONS MFG. CO.,

SILVERSMITHS,

WALLINGFORD, CONN.

NEW YORK:  
3 PARK PLACE.

CHICAGO:  
86 WABASH AVENUE.

**Proceedings of the American Horological Society.**

CHICAGO, Ill., Sept. 20.—The regular monthly meeting of the American Horological Society was held Sept. 11th. The applications of P. P. Camp, Mukwonago, Wis.; J. H. Hales, Little Rock, Ark., and G. J. M. Ashby, Chicago, Ill., were reported upon and they were unanimously elected to membership.

The committee on nomenclature, which has been at work for over six months reported that all the names and definitions have been decided upon and the drawings nearly completed, and that at an early date the completed work can be submitted to the Society with a full report. The committee on emblem reported with six different designs, five in the shape of sketches in colors and one a gold plated pin. Five of the designs consisted of a compensation balance, enclosing the letters A. H. S. The two other designs were sun dials. After discussion G. D. Parsons offered the following resolution, which was carried:

*Resolved,* That this society offer a cash prize of \$10.00 for a design for an emblem for the society, which shall be appropriate for use on its stationery, or as a scarf pin, or button and that the society reserves the right to reject any or all designs submitted.

Upon a resolution offered by J. H. Purdy the membership dues have been made one dollar a year, and initiation fees have been done away with. The committee on prize essays, consisting of G. D. Parsons, Chas. Bieling and A. Fischer, reported that the essay of "Souvenir," P. W. Eigner, Kent, O., is entitled to first prize, but that the other essays are all too faulty to warrant any prize. The names of the unsuccessful competitors were not revealed, as they were in sealed envelopes.

Mr. Eigner's essay was then read and criticised by the members. The criticism was lengthy and will be continued at the next meeting.

**Movement to Establish a Silver Manufacturing Plant in Haverhill.**

HAVERHILL, Mass., Sept. 19.—A movement is being rapidly developed to establish a silver manufacturing plant in this town. The projectors propose to manufacture solid silverware, with plated goods as a secondary line. They will produce cutlery, hollow ware and flat ware.

Among the goods, it is proposed to make finer grades of pearl and ivory and embossed and engraved handles. The concern will open a wholesale and retail establishment in Boston and sell only to retailers direct or customers. The factory will give employment to three hundred skilled workmen. The capital to be invested is \$300,000, and the yearly product is estimated at \$1,000,000.

A number of local capitalists have interested themselves in the project, and the Board of Trade has taken the matter up. Levi L. H. Taylor and C. W. Arnold are the prime movers.

**BIPPART & CO.**  
 MANUFACTURERS OF  
**DIAMOND JEWELRY**  
 NEWARK · N. J.

BROOCHES. LINK BUTTONS.  
 SCARF PINS. CUFF PINS.  
 HAT PINS. BRACELETS,  
 HAIR PINS. NECKLACES,  
 EARRINGS. RINGS.

NEW YORK OFFICE 19 MAIDEN LANE

**THE BOWDEN SEAMLESS RING**  
 IS MADE ONLY BY  
**J. B. BOWDEN & Co.,**  
 Makers of Finger Rings of every Description.  
 COR. BROADWAY & JOHN STREET,  
 NEW YORK.

**J. B. & S. M. KNOWLES CO.,**  
 MAKERS OF

Sterling  Silverware.

FACTORY, Providence, R. I. SALESROOM, 860 Broadway, N. Y.

**O. W. BULLOCK & CO.,**  
 SPRINGFIELD, MASS.  
 Makers of Watch and Jewelry Tools,  
 NEW CATALOGUE NOW READY.  
 Sent on Application. Please Mention this Paper.

**JACOT & SON**  
 IMPORTERS AND MANUFACTURERS OF  
 MUSICAL BOXES  
 298 BROADWAY  
 NEW YORK



**ARTISTIC  
METAL  
GOODS.**  
NEW DESIGNS,  
NEW FINISHES.

Our line of Pitchers, Vases, Tables, Candlesticks, Five O'Clock Teas, Etc., cannot be equaled.

**THE  
CELEBRATED  
"B & H" LAMP.**



BEAUTIFUL DESIGNS,

particularly adapted to the Jewelry Trade.

SEE OUR LINE OF

TABLE, BANQUET AND PIANO LAMPS

before placing your orders. Send for our Little Book.

**BRADLEY & HUBBARD MFG. CO.**

NEW YORK, BOSTON, CHICAGO,  
21 BARCLAY ST., 160 CONGRESS ST. 88 WABASH AVE.  
26 PARK PLACE' Factories, MERIDEN, CT.

**"THE BEST BUTTON MADE."**

THE KREMENTZ

IN GOLD

FROM

**KREMENTZ & CO.**

And all Jobbers.



ONE PIECE

IN ROLLED PLATE

FROM

ALL JOBBERS.

**COLLAR BUTTON.**

IS THE ORIGINAL ONE PIECE BUTTON.

IS STILL THE BEST AND STILL UNSURPASSED.

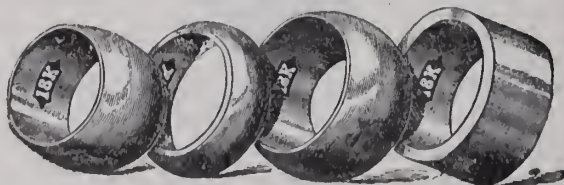

**PLAIN SOLID GOLD RINGS.**

**HILDRETH MFG. CO.,**

53 MAIDEN LANE,

NEW YORK.

**Providence Has Local Standard Time.**

PROVIDENCE, R. I., Sept. 23.—Hereafter the Ladd Observatory time will be the standard for Providence, and this city will not be dependent on Washington or Cambridge as formerly. Professor Winslow Upton, astronomer of Brown University, is in charge and takes the time from the sun at the observatory. At 3 o'clock last Wednesday afternoon all the electric clocks in the city were set by this standard which varied but a small part of a second from that of the Cambridge Observatory.

The Providence Electric Protective Co., who have charge of the electric clocks, will also have the tickers used by the watchmakers and large jewelry firms, and as soon as the new circuits can be completed the standard time will be ticked from the city. The Western Union Telegraph Co. have heretofore had charge of this system, but it will in future be controled by the local company.

**The Sheriff will Have to Pay the Rent.**

LOS ANGELES, Cal., Sept. 20.—Henry Susskind, who, it is alleged, has been acting as a dummy for L. M. Wagner, in the matter of the latter's failure, appeared as a plaintiff in a suit against the sheriff of Los Angeles County last week to recover \$300 rent of the premises occupied by the jewelry store and which the sheriff had held for twenty-one days under an attachment against the stock alleged to belong to Wagner but claimed by Susskind.

The court held that there was nothing to show that Susskind was not the real tenant, that the court could not upon this occasion inquire into the relations of him and Wagner except as regards the rent. Judgment was therefore given Susskind for \$140 at the rate of \$200 per month. An appeal was taken.

**"Kid" McCoy Found Guilty of Robbing Salesman W. G. Pollack.**

LOGAN, Ia., Sept. 21.—The jury in the great Pollack diamond robbery case yesterday found Frank Shercliff, alias "Kid" McCoy guilty, and he was remanded to jail to await sentence, which will be pronounced on Friday. There is great satisfaction here over the conviction.

Shortly after McCoy's arrest Frank Bruce, a former Omaha crook, was arrested in Terre Haute, Ind., on the charge of committing burglary. Here was the chance for McCoy's friends. A great effort has been made to fasten the crime on Frank. Because the police at one time had a suspicion that the Pollack robbery had been committed by Bruce, friends of McCoy have been endeavoring to carry out this theory. Chief Seavey, who has been looking up Bruce's history, finds that at the time the Pollack robbery took place Bruce was serving a term in a southern penitentiary.

There have been many peculiar developments in this case since the robbery. The detectives who are working on the case are inclined to the belief that other people are



# RICE & HOCHSTER'S, Nos. 483 & 485 BROADWAY, NEW YORK.

ARTISTIC DISPLAY OF TORTOISE SHELL WORK AT THE WORLD'S FAIR.

THE perfection reached by workers in tortoise shell will be amply exemplified at the World's Columbian Exposition by the display of Rice & Hochster, New York. The exhibit is in the Manufactures building, Gallery F and Pillar No. 83. The articles are displayed within a case, upon a pyramid. Surmounting this pyramid are shown the marvelous ornamental work in tortoise shell illustrated on this page, and represents an arch, upon which are groups of figures typifying agriculture, commerce, machinery, electricity, the press, iron work, chemistry, sculpture, painting

motto *palmam qui meruit ferat* (let him bear the palm who merits it).  
The workmanship is as fine and perfect as

ing. In the working of the shell, the amber colored portions have been made to represent the flesh, while the brown parts, the draperies.

The exhibit contains two figures of Washington and Columbus, made of solid shell. On one panel of the pyramid are cut in relief cameos of the twenty-three presidents of the United States. Prominent also are three large combs, one foot square, representing the landing of Columbus, the four Seasons and the five Continents. A great many styles of hair ornaments and lorgnettes made from select shell are in the exhibit. Five

WRITE FOR  
Selection  
Packages of  
Tortoise Shell  
Hair Ornaments  
and Lorgnettes.

Repairing of  
Tortoise Shell  
Goods Equal  
to New.

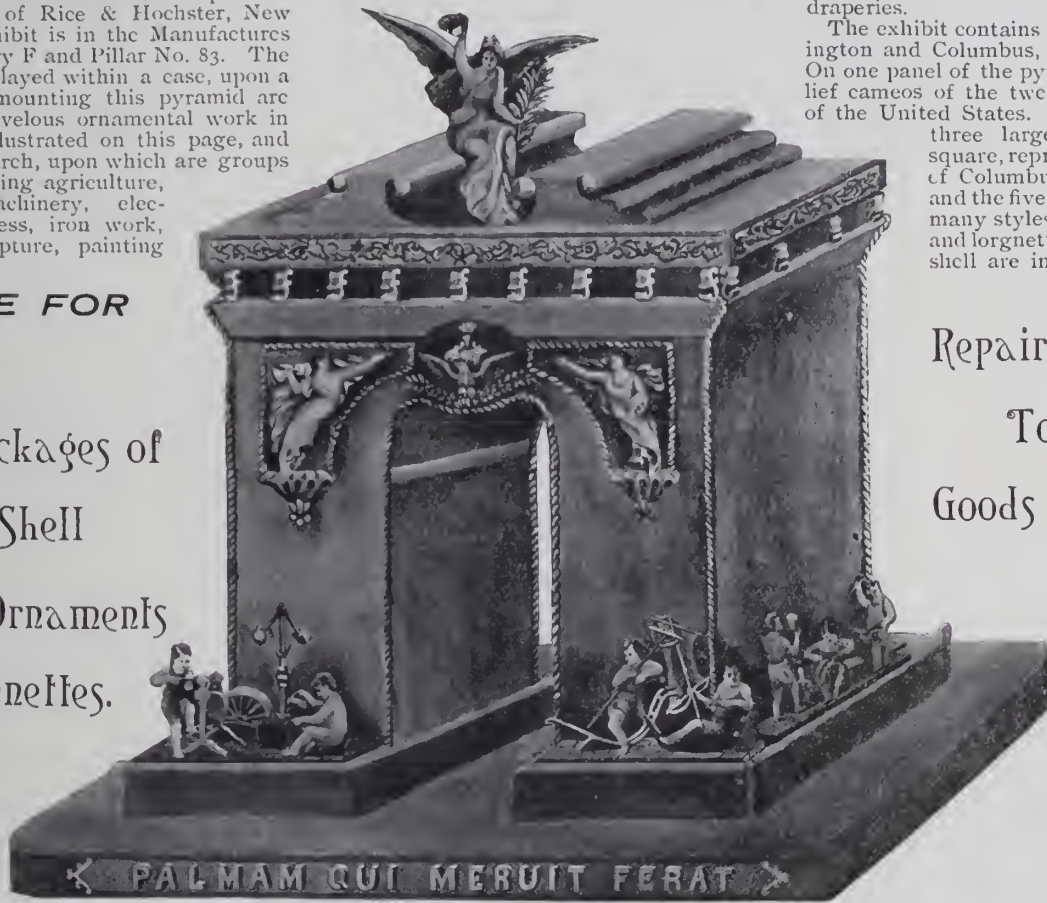

ORNAMENTAL PIECE IN TORTOISE SHELL, EMBLEMATIC OF THE TRIUMPH OF INVENTION AND ART.

and other arts. The angel which surmounts the piece is a faithful miniature of the figure which tops one of the buildings of the World's Fair. In relief, on the base, is the

the conception of the piece is artistic. In the manipulation of the miniature figures the ingenuity of the artisans has been taxed to its utmost and has not been found want-

stuffed tortoises surmount the case which is of white and gold; the letters of the name of the firm are in tortoise shell. From THE JEWELERS' CIRCULAR, May 3d, '93.

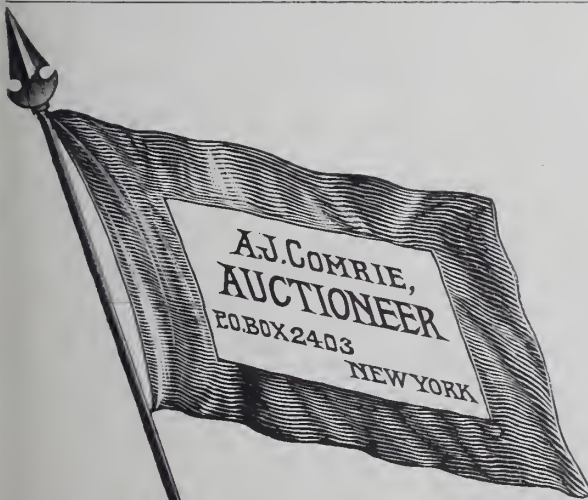

SPECIAL SALESMAN OF

WATCHES, DIAMONDS,  
Bric-a-Brac  
and Art Goods

FOR

Established Jewelers.

WRITE FOR PARTICULARS.

Communications Strictly Confidential.

References given in all parts of the United States from Retailers and Jobbers

WM. BIRMINGHAM & CO.,

MANUFACTURERS OF

All Kinds of Leather Spectacle and Eye Glass  
**CASES,**

728 Arch Street, PHILADELPHIA, PA.



S. C. JACKSON, 180 BROADWAY, NEW YORK.

MANUFACTURER OF

Fine \* Cases \* for \* Jewelry, \* Silverware, \* Etc.

ALSO SHOW CASE TRAYS AND FANCY HARD WOOD WORK.

Samples sent on application. Estimates furnished.

**Aikin Lambert Jewelry Co.**  
 Importers of  
**Diamonds**  
 Jobbers in **WATCHES,**  
 Jewelry, Chains etc.  
 19 Maiden Lane.  
**New York.**

SAM'L B. MANN, Treas.  
 FRED. D. ILGEN, Sec'y

JAMES C. AIKIN, Pres.  
 JOHN B. SHEA, V.-Pres.

**C. SYDNEY SMITH,**

HAS REMOVED TO 191 BROADWAY,  
 New York.

FACTORY:  
 PROVIDENCE, R. I.

Manufacturer of { **GOLD CHAINS,  
 LOCKETS AND CHARMS.**



**The Warren**  
**Eye Protector**

(Patented Jan. 12, 1892, Feb. 21, 1893.)

Saves the Eyes From

**Dust, Wind, or Glaring Light.**

Folds in a Compact Case, is

**Comfortable, Durable,  
 Water and Dust Proof.**

Its large field does not obstruct the sight. No brittle substance to endanger face under sudden blows.

Oculists and Physicians Recommend it.

Travelers, Cyclists, Railroadmen,  
 Horsemen, Motormen, Quarrymen,  
 Pronounce it Indispensable for Man or Woman.

Ask your Dealer for it.

Colors, Clear, Smoke, Blue or Green. Black frames, 50c. Silver, 75c. Sent by mail on receipt of price. Manufactured solely by

**The Nous Verrons Company**  
 P. O. Box 3273, Boston, Mass.

interested in the robbery, and the police think that these people must stand by McCoy or else be implicated. The officers allege that McCoy has been the tool of a bold and well organized gang who conspired to rob Pollack, and that they secured the plunder and have distributed the gems among accomplices in different parts of the country, so that it will be almost impossible to recover them.

The Jewelers' Protective Union will spare no expense to convict everybody implicated in the robbery.

**Jeweler Wittkowsky Shot in a Fight Regarding a Woman.**

CAMDEN, S. C., Sept. 19.—J. C. Mann and H. A. Wittkowsky last week had a difficulty in the store of H. S. Watkins about a woman. Three shots were fired, two by Mann and one by Wittkowsky.

The latter was shot in the right hip, sustaining a serious wound. Mann is a successful merchant, Wittkowsky a jeweler.

**A Pair of Thieves Find Rest in a Reformatory.**

PHILADELPHIA, Pa., Sept. 23.—Thomas McArdle and Joseph Sabey, who pleaded guilty to the larceny of twenty-nine watches from the bulk window of the store of William L. Clark, 1227 Chestnut St., and optical goods valued at \$143, from the store of H. R. Saunders 133 S. 13th St., were arraigned before Judge Hare this week for sentence. Full details of the robberies were published in THE CIRCULAR at the time they were committed.

Judge Hare, after commenting on the seriousness of the crime they had been guilty of, committed them both to the Huntingdon Reformatory. Charles Curry, who was convicted of receiving one of the watches, knowing it to have been stolen, was also sent to the reformatory.

**CLEAN JEWELRY SELLS QUICK.**

Quarters' Cleaning Solution removes dirt and tarnish in an instant, makes stock like new and brings up diamond and stone work to a beautiful lustre. Solution can be used over and over. Highly commended by all who use it. Send at once \$1.50 for half gallon with full directions. References.

**W. F. QUARTERS ELECTROPLATER,**  
 139 EDDY STREET. PROVIDENCE, R.

**No File Equals the "GLARDON" File**

is the universal verdict  
 of the trade.



LARGEST ASSORTMENT IN  
 THE UNITED STATES.

**F. W. GESSWEIN, 39 John Street, New York.**

SOLE AGENT FOR UNITED STATES AND CANADA.

# THE FIVE MOST DESIRABLE PATTERNS



TRIANON.—Pierced.

LOUIS XIV.

MAZARIN.

ROCOCO.

CUPID.

**Dominick & Haff,** Makers of Wares in Sterling Silver,  
 Broadway and Seventeenth St., Union Square, N. Y.

ESTABLISHED 1821.

IN THE MARKET.



HE HAD A  
 ~△ HANG-DOG LOOK, △~

BECAUSE HE BOUGHT HIS  
 Gold, Silver, Steel and Nickel  
 Spectacles and Eyeglasses.

Gold, Silver, Aluminum and German Silver

THIMBLES

—: AND :—

SEAMLESS, GOLD FILLED,  
 SPECTACLES AND EYEGASSES,

BEFORE SEEING OUR LINE.

THE WINSTED OPTICAL CO.,

MANUFACTURERS OF

The BURBANK Patent Eyeglass, SEAMLESS Gold Filled Spectacles and Eyeglasses. And all other goods enumerated above. WRITE US! WEST WINSTED, CT.

Hair Pin and Eye Glass Chain  
 COMBINED.



This illustrates the Hair Pin and Eye Glass Chain Combined. It is one of the most dressy as well as the most comfortable ways of securing the Eye Glass ever put on the market, and it is justly becoming very popular.

S. F. MERRITT, Manufacturer,

N. Y. Office, 194 Broadway.

SPRINGFIELD, MASS.

VICTOR. ⊗ ⊗  
 SIMPLEST FEED. ALWAYS THE SAME.  
 GUARANTEED FOR ONE YEAR.  
 THE VICTOR  
 FOUNTAIN PEN  
 (Pat. Feb. 4, 1890.)

THE BOSTON PEN CO.,  
 N. C. Whitaker & Co., Proprietors.  
 363 Washington Street, - Boston, Mass.,  
 Manufacturers of finest quality  
 TORTOISE : SHELL : AND : HORN : GOODS  
 in every variety. Also Aluminum Hair Pins.  
 \*Send for Illustrated Pen Price List No. 1.

Jules Jürgensen

OF COPENHAGEN.

The reputation these watches have maintained for Fifty Years has never been equalled, being made on strictly scientific principles and no expense spared to give the Best results in mechanism and timekeeping qualities.

SOLE AGENTS,

John C. Hyde's Sons,  
 No. 22 MAIDEN LANE.

LLOYD PATENT.

In Good LLOYD CASE you want a send for

H. E. KIRSTEIN & CO.,  
 MANUFACTURERS,  
 Rochester, N. Y.

MATHEY BROS., MATHEZ & CO.

21 & 23 MAIDEN LANE, N. Y., and BRASSUS, SWITZERLAND.

MANUFACTURERS AND IMPORTERS OF

Plain and Non-Magnetic Movements.

Complicated Watches a Specialty.

A FULL LINE OF 10 and 16 SIZE

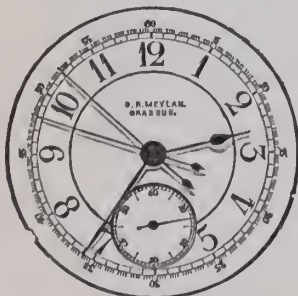

SIZE 10.

SPLITS

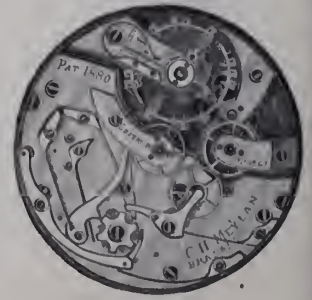

10 SIZE

**World's Fair Awards of Interest, in the Fisheries Department.**

CHICAGO, Ill., Sept. 23. — The official awards of medals and diplomas in the Fisheries Department, so far as they relate to jewelry lines, are as follows:

- G. F. Kunz and Tiffany & Co., literature on pearls; report on pearls of North America.
- Mrs. M. Gardner, Memphis, Tenn., fish scale jewelry.
- Thomas Tipping, Chicago, fish scale jewelry.
- Wm. F. Nye, New Bedford, Mass., watch, clock and chronometer oils.
- Ezra Kelley, fish oil for watches and small machines.
- Tiffany & Co., Oriental and American pearl collection.

**Consolidation of Two Watch Case Companies.**

A proposition has been made to consolidate the Crescent Watch Case Co. and the Bay State Watch Case Co., by the former absorbing the latter. At the New York office of the Crescent Watch Case Co., 21 Maiden Lane, a CIRCULAR reporter learned from Irving Smith that the proposition had been made by the Crescent Watch Case Co. and had been under consideration by the Bay State Watch Case Co., but no action of a definite nature had yet been taken by the latter.

At an informal meeting, which took place on the 19th at the Parker House, in Boston, the largest stockholders who hold a majority of the stock of the Bay State Watch Case Co., signified their willingness to accept the proposition.

A dispatch to THE CIRCULAR from Boston states that the Bay State Watch Case Co. go out of existence and that the holders of shares in that company exchange them for stock of the Crescent Watch Case Co. The finer machinery of the absorbed company will probably be transferred to the Crescent factory in Rosedale, N. J.

**Providence.**

Mr. Mowry, of Kirby, Mowry & Co., has started on an extended western trip during which he will visit San Francisco.

B. F. Crossin has returned from a two months' business trip in the west, that has been productive of a large number of orders.

Nearly all of the eastern creditors of Giles, Bro. & Co., Chicago, have accepted their proposition of settlement on a basis of twenty-five cents on a dollar, C. K. Giles having personally visited the manufacturers in this vicinity.

The co-partnership of Rathbone & Smith, gold and silver refiners, has been dissolved by the disappearance of William A. Smith, of the firm, with a considerable portion of the funds of the concern. Mr. Rathbone, who is a man of means, has assumed the indebtedness of the firm and will continue the business.

**The Death of Leroy B. Haff.**

The jewelry trade was shocked last week at the news of the death of Leroy B. Haff, of Dominick & Haff, New York, which occurred Sept. 18th at Paul Smith's, in the Adirondacks, where Mr. Haff who had been suffering with pleurisy, had gone for the benefit of his health.

Mr. Haff was born in Peru, N. Y., fifty-



THE LATE LEROY B. HAFF.

two years ago. He had been connected with the silverware business since 1867, when he entered as book keeper, the retail department of William Gale, manufacturing silversmith, whose retail business was then under the Metropolitan Hotel, New York. In 1869, Mr. Gale closed out his retail department and Mr. Haff was transferred to the wholesale department of Gale & Corning, at Broome and Mercer Sts. The next year he became a member of the firm, the name of which was changed to Gale, Dominick & Haff. Mr. Gale took no active interest in the firm, but his name remained until 1872, when the firm took its present name of Dominick & Haff.

Two years later they removed to the first Waltham building, at 1, 3 and 5 Bond St., but when this structure was destroyed by fire in 1877, they changed their quarters to 7 and 9 Bond St. When the present building at Nos. 1, 3 and 5 was rebuilt, they moved back into it and remained there until 1884, when they again changed their quarters to the building in which they are now located at 860 Broadway. In 1888, when the firm was organized into a joint stock company, Mr. Haff became vice-president and treasurer, and his partner, H. B. Dominick, president of the concern.

For many years Mr. Haff had lived at Englewood, N. J., where he became a conspicuous figure in public affairs and charitable enterprises. He was a director of the Bergen County Gas Co., one of the promotors and a governor of the Englewood Club, and a

member of the Player's, Reform, and Grolier clubs, of New York. At the time of his death Mr. Haff held the position of senior warden of the Protestant Episcopal Church of Englewood.

Mr. Haff was known as a man of modest and retiring disposition, yet aggressive when necessary. He was well liked and respected by all with whom he came in contact, and was universally regarded as a thoroughly honest, upright, and sagacious business man. While his death will be a severe blow to his relations and friends throughout the country, the loss will be most deeply felt by the concern of Dominick & Haff. To Mr. Dominick particularly is the death of Mr. Haff a keen blow, as between himself and the deceased, there existed for the past twenty-five years, the closest relations, both in business and private life. The portrait herewith is from the last photograph of Mr. Haff, which was taken eighteen years ago. Mr. Haff never married.

The funeral services took place Thursday afternoon, in Peru, N. Y.

**Jas. M. Chappel & Co. Make an Assignment.**

RICHMOND, Va., Sept. 20.—J. M. Chappel & Co. made an assignment Monday afternoon. Judge Edmund Waddill was made trustee. The liabilities are about \$5,600, and the assets are unknown. The failure is alleged to be due to the general financial depression. The firm preferred all of their Richmond creditors.

The deed first provides for the payment of all rents, taxes, trustees, commissions, etc., then local claims and then Ernest Adler, \$110; the Gorham Mfg. Co., \$110; Reed & Barton, \$30, which debts are evidenced by notes. All other creditors are embraced in the fifth clause.

**A Syndicate of Creditors Get the Stock of Shook, Patterson & Co.**

OMAHA, Neb., Sept. 21.—Walter Sams, representing S. Jonasen, who bid in the jewelry stock of Shook, Patterson & Co., at sheriff's sale, on Aug. 15th, says that Mr. Jonasen has been treated unfairly in the matter and that he is entitled to possession of the stock. He claims that after it was learned that the attorneys in the case had agreed that the stock must bring at least \$5,000 or should not be sold, and when Mr. Jonasen found that the eastern creditors were willing to give the amount stated for the goods, in order to protect himself he went to the sheriff and offered him \$5,000, cash in hand for the stock, the price at which it was originally bid in having been \$4,450. This offer, Mr. Sams says, Sheriff Bennett had no authority to accept, and did not accept, but upon the order of Judge Scott this week he turned the stock over to the syndicate of eastern creditors, represented, it is claimed, by the members of the defunct firm.

Mr. Sams further states that the stock in question is worth \$20,000 at manufacturers' prices.

# Bouguereau's Great Masterpieces in Silver.

NYMPHS AND SATYR.



MATCH BOX.



COURT PLASTER.

PSYCHE AND LOVE.



MATCH BOX.

THE highest art has been attained in modeling the subjects of those great paintings in *bas relief* on Silver and Gold. The success we have made, has elicited the highest expressions of approval from the famous painter **Bouguereau**, the recognized leader of the nude school, as may be seen in the following letter.

PARIS, 22 Juni, 1893.  
WM. B. KERR & Co.,

MESSIEURS: Je viens vous remercier des deux boîtes en argent que vous avez bien voulu m'offrir.

J'ai pu constater par les bas reliefs, qui les ornent et qui sont faite d'après deux de mes tableaux "Nymphes et Satyre" et "Psyhé et l'Amour," tous le soin que vous apportez à l'exécution de vos travaux ainsi que la recherche artistique que vous y mettez.

Je ne puis que vous encourager, Messieurs, à poursuivre dans cette voie me permettant cepedant de vous faire observer qu'a mon avis vous devez, avant de faire executer des œuvres d'art, obtenir la permission de l'Auteur.

Veuillez agréer, Messieurs, l'expression de mes sentiments très distingués.

PARIS, June 22, 1893.  
WM. B. KERR & Co.,

GENTLEMEN: I desire to thank you for the two silver boxes, which you have so kindly presented me with.

From the *bas reliefs* which ornament them, and which are reproductions of my two paintings "Satyr and Nymphs" and "Psyche and Love," I can certify with pleasure the great care shown in the execution of the work of reproduction, also the highest artistic sentiment.

I desire to encourage you gentlemen in pursuing such a path, allowing me to suggest that in so doing, that permission be obtained from the authors.

Kindly accept gentlemen the expression of my most sincere consideration.

## WILLIAM B. KERR & CO.,

Manufacturers of ARTISTIC JEWELRY IN GOLD AND SILVER,

FACTORY:  
NEWARK, N. J.

860 BROADWAY, N. Y.

# The Jewelers' Circular

AND  
HOROLOGICAL REVIEW.

PUBLISHED EVERY WEDNESDAY BY

THE JEWELERS' CIRCULAR PUB'G CO.,  
189 BROADWAY, NEW YORK CITY.

A JOURNAL DEVOTED TO THE INTERESTS OF JEWELERS, WATCHMAKERS, SILVERSMITHS, ELECTRO-PLATE MANUFACTURERS, AND ALL ENGAGED IN KINDRED BRANCHES OF INDUSTRY.

Our Editorial columns will contain our own opinions only, and we shall present in other columns only what we consider of interest or value to our readers. Advertising matter will not be printed as news.

Advertising rates in THE CIRCULAR are lower, considering the number of tradesmen reached by its large circulation, than in any other jewelry journal.

Notices of changes in standing advertisements must be received one week in advance; new matter can be received up to Monday.

## INFORMATION FOR SUBSCRIBERS.

### Terms of Subscription, Postage Prepaid.

	PER ANNUM
United States and Canada, - - -	\$2.00
Foreign Countries in Postal Union, - - -	4.00
Single Copies, - - - - -	.10

New subscribers can commence at any time.

Payments for THE CIRCULAR, when sent by mail, should be made in a Post Office Money Order, Bank Check or Draft, or an Express Money Order or Registered Letter. All postmasters are required to register letters whenever requested to do so.

Pay money only to authorized collectors having proper credentials. Returning your paper will not enable us to discontinue it, as we cannot find your name on our books unless your address is given.

In changing address always give the old as well as new one. Your name cannot be found on our books unless this is done.

We will continue to send papers until there is a specific order to stop, in connection with which all arrearages must be paid; but such an order can be given at any time, to take effect at the expiration of the subscription. All such orders will be promptly acknowledged by mail.

The Courts have decided that all subscribers to journals are responsible until arrearages are paid in full and an order to discontinue has been received by the publisher.

Member of the American Trade Press Association.

VOL. XXVII. Sept. 27, 1893, No. 9.

## WINDOW DESIGN CONTESTS, NO. 1.

A Prize of \$10.00 is offered by THE JEWELERS' CIRCULAR for the best design for dressing a jeweler's window. The contest is open to all members of the trade, to the clerks, salesmen and others, as well as to the dealers. Following are the conditions:

1. The design is to be submitted as a pencil or other sketch or photograph, from which a finished engraving may be made. The design may be an original conception or a copy of a window already dressed.
2. A brief description is to accompany the design.
3. The design must be appropriate for the Fall and holiday season.
4. Designs for Contest No. 1 must reach us no later than Oct. 1.

Men are never so likely to settle a question rightly as when they discuss it freely.—*Macaulay.*

**L**ORD Macaulay philosophized thus before the bill for the repeal of the purchasing clause of the Sherman Silver Law was passed by the House of Representatives and sent to the Senate of the United States. The House acted on the bill with little delay, but the Senate still talks, much to the disgust of a very great majority of the people. The time for argument and discussion has gone by and action is needed.

**T**HE question is often asked why do women not adopt watchmaking as a vocation. Women are naturally dexterous, say these querists, and have delicate touch. We are inclined to doubt the truth of this assertion, at least, so far as woman's prestidigitation capacity is concerned. Last week a young woman in one store substituted a spurious article for a diamond ring, while in another store, another young woman secreted valuable jewelry in her gloves. Both these cases would have proven to be admirable tricks of legerdemain, had not the young women been detected in their acts. However, jewelers should not altogether rely upon woman's inability to rival Professor Herrmann.

**A Chance to Co-operate.** **L**EGITIMATE jewelers will be pleased to read of the conviction of a so-called watch and jewelry company in Chicago for misrepresenting trashy articles of jewelry as being of solid gold and selling them as such. Such swindlers doubtless rely upon the reluctance of their victims to prosecute, the average man who has been operated upon preferring to swallow his loss of a few dollars rather than waste time in prosecuting a case in court. However, even the shrewdest scholar of human nature among these sharpers may overreach himself, for occasionally a victim appears and the courts mete out a small dose of much-needed reform, as in the case reported from Chicago, in which the manager of the "jewelry company" was fined \$100 and costs, the limit of the law. This limit is not far enough off. It should extend to Joliet penitentiary. Square dealing jewelers should co-operate with the victims in eliminating these swindling enterprises from the face of the business world, as the schemes which these establishments practice reflect upon the trade in general, and bring into question among the public, the integrity of honorable jewelers.

**The Era of Train Robbing.** **A**T the present moment when train robbing seems to be as common a crime as stage-coach pillaging was in times gone by, it is a matter of satisfaction that one less desperate character will be at large, in the person of "Kid" McCoy, found guilty last week in Logan, Ia., of robbing and assaulting W. G. Pollack, traveler for W. L. Pollack & Co.,

New York. Shercliff or McCoy is doubtless but one of a powerful gang, as the methods employed in the Pollack outrage as well as in its successors, together with the influences brought to bear to free the criminal after his arrest, show skill, intelligence and fertility of resource beyond the capacity of one man. Traveling salesmen carrying valuable lines are especially interested in the nature of these robberies and their developments. They should not, however, exaggerate in their own minds the frequency of the crime, though they should always be alert for the occurrence and courageous at the moment of attack. The consensus of opinion regarding train robbing is that the uncertainty of each passenger as to what the others will do paralyzes all, 2-o'clock-in-the-morning courage being no more common now than it was when Napoleon pronounced it scarce.

## The Week in Brief.

**T**HE death occurred of Leroy B. Haff, of The Dominick & Haff, New York—The Morrill Bros. Co., Boston, Mass., incorporated—The death occurred of Chandler E. Edgcomb, Waltham, Mass.—Jewelers of Boston, Mass., and their ladies enjoyed a yachting trip—The Hershfield Watch and Jewelry Co., Kansas City, Mo., incorporated—A young man, calling himself Simon Jacobs has been getting goods fraudulently on memorandum from New York wholesalers—Charlotte Henry was arrested in Jersey City, N. J., charged with robbing Adolph Walter—The store of J. B. Lorge, Kiel, Wis., was ransacked—Charles Veicht, Milwaukee, Wis., was arrested, charged with leasing property for immoral purposes—Ernest H. Miller, Albany, N. Y., attempted suicide—Jas. M. Chappel & Co., Richmond, Va., assigned—A silverware factory is projected for Haverhill, Mass.—Frank Shercliff, alias "Kid McCoy," was convicted in Logan, Ia., of robbing W. G. Pollack, New York—Providence, R. I., has adopted local standard time—Thomas McArdle and Joseph Sabey, window thieves, were sentenced in Philadelphia, Pa.—Walter Hayman, watchmaker, Philadelphia, Pa., was arrested, charged with selling customers' watches—A settlement is likely to be effected in the affairs of L. P. White, Philadelphia, Pa.—The jewelry and watches taken from Eugene and Jeanne Leroux were turned over to Collector Kilbreth, of New York—Ida Grinspan, New York, failed—An order was signed in the suit of the Dueber Watch Case Mfg. Co. vs. the Co-operating Manufacturers—W. W. Didier, Three Rivers, Que., was arrested on a *capias*—The American Watch Case Co., Toronto, Can., brought suit against W. F. Doll, Winnipeg, Man.—Otto Baehr, St. Louis, Mo., assigned—Alexander Davidoff, New York, made an assignment—A syndicate of creditors of Shook, Patterson & Co., Omaha, Neb., bought the old stock.

### New York Notes.

John B. Yates returned Friday from his trip to the World's Fair.

B. H. Davis & Co. have obtained a judgment for \$142.32 against Jos. D. Lynch.

Alois Kohn & Co. have entered a judgment amounting to \$562.85 against Guste Grinspan.

Wm. Smith & Co. have applied for membership in the New York Jewelers' Association.

Aug. Shafer, of Amsterdam, Holland, arrived in New York on *La Campagne*, Saturday.

Frederick L. Martin, of Eichberg & Co., returned from Europe, Sept. 16th, on the *Etruria*, after an absence of five months.

Max Freund, of Max Freund & Co., left for Chicago Saturday. He intends to "do" the Fair thoroughly and will return about Oct. 3d.

J. D. Yerrington has been appointed by John Boyd Thacher, a member of the World's Columbian Exposition jury of awards on precious stones.

Freeman & Green have entered a judgment for \$208.32 against Isaac Harrison, of this city, in favor of Hancock, Becker & Co., Providence, R. I.

The suspension of Ida Grinspan, 384 Grand St., which occurred early last week, is said to be due to the failure of Weinberger, the East Side banker.

Ludwig Nissen, of Ludwig Nissen & Co., has just recovered from a severe attack of typhoid fever, which confined him to his home for the past seven weeks.

S. Lorsch, of Sussfeld, Lorsch & Co., New York, and Mr. Nordman, of Nordman Bros., San Francisco, arrived in New York, from Europe, Sunday on *La Bourgogne*.

R., L. & M. Friedlander, 65-67 Nassau St., desire those firms interested in R. Jurgensen, West Winsted, Conn., to write them as they have something of interest to communicate.

Judge McAdam, of the Superior Court, last week appointed Wm. A. Gans receiver for Taylor Bros., pawnbrokers and jewelers, 94 Hester St., in supplementary proceedings in the suit brought against them by Vve L. B. Citroen & Co.

The examination of Leon Cottentin in supplementary proceedings on judgments held by Reed & Barton commenced yesterday. The examination takes place at the office of Geo. Carlton Comstock, the plaintiffs' attorney, 55 Liberty St.

Pursuant to orders of Judge Pryor, of the Court of Common Pleas, Frederick Beltz, assignee of Kuhn, Doerflinger & Co., and Theo. H. Shultz, assignee of M. Fox & Co., are advertising for creditors of these firms to present their claims duly verified on or before Dec. 9th, at Room 134, 111 Broadway.

Commissioner Daly, of the Department of Public Works, to whom a petition has been sent, as reported in last week's CIRCULAR, asking that Maiden Lane be asphalted, has announced that he will consider the question

when making out another list of streets for pavement.

Judge Freedman, of the Superior Court, handed down an order Saturday denying the motion of the plaintiff in the suit of Allan C. Dalzell vs. Fahys Watch Case Co., for permission to inspect the books of the defendant company. The motion was made early in August.

On Thursday a young woman was charged by Bloomingdale Bros., 59th St. and 3d Ave., with shoplifting. When searched a quantity of diamond jewelry was found hidden in her gloves. In the Yorkville Police Court she gave her name as Lizzie Lansing.

Wm. H. Ball & Co., 15 John St., lately introduced a new bracelet which they called the "Esther," in honor of President Cleveland's baby daughter. Last week they sent one to Mrs. Cleveland and received from the White House a gracious note of thanks, stating that as an evidence of thoughtfulness and consideration, the courtesy was highly appreciated.

George P. Treiss, a jeweler well known to the trade of New York, died on Wednesday at his home at 308 Atlantic Ave., Brooklyn. He was a native of Oberstein, Germany, and lived in Brooklyn for more than half a century. For twenty-five years he had a jewelry store at the place where he died. He leaves four grown-up children. The funeral services were held Sunday.

At a meeting of the creditors of Charles Seale, held last week in the office of Blumenstiel & Hirsch, 320 Broadway, a proposition was made to settle with the creditors at 15 per cent. unsecured. A committee consisting of Chas. Kuhn, Jr., M. D. Rothschild, and J. R. Keim was appointed to investigate in behalf of the creditors. The committee will probably submit their statement the latter part of this week.

Judge Ingraham on Friday signed an order in the suit of the Ducber Watch Case Mfg. Co., against the Co-operating Manufacturers, by which a commission is to issue to Wm. H. Wishart, Pittsburgh, Pa., who is appointed to examine on written interrogatories certain witnesses whose evidence the plaintiffs require in this suit. The plaintiffs also asked that the interrogatories be conducted orally, but this was denied.

A meeting of the manufacturers of watch cases and movements, who are the defendants in the suits brought by the Ducber Watch Case Mfg. Co., took place shortly after THE CIRCULAR went to press, at the office of Jas. H. Noyes, 192 Broadway. The meeting was called to allow the defendant companies to consult on a proposition to make one firm of lawyers act for all the defendants together, instead of each conducting the action separately.

As before announced in THE CIRCULAR, David McClure, receiver of the National Bank of Deposit, has declared a second disbursement to depositors, amounting to 25 per cent., to be paid by Sept. 30th. Last week it was decided to increase this disbursement to 35 per cent. and checks are now being made out for that amount and will be paid as soon

as signed by Comptroller Eckels. This will make the amount returned to depositors 75 per cent. in all and it is confidently expected that the remainder will be paid within a reasonably short time.

Frederick William Barthman, Jr., a son of William Barthman, was married last Tuesday evening to Miss Maria Louise Durbrow, only daughter of James W. Durbrow, in St. George's Episcopal Church, on Gates Ave., Brooklyn. The Rev. N. R. Harris assisted by the Rev. J. D. Bacchus, officiated. The wedding was one of the most brilliant of the season.

Miss Aggie Green, for a number of years an employe of S. F. Myers & Co., has taken upon herself the duties of married life. When she left the house, she carried with her the best wishes of her employers and their check for \$500. The employe "chipped in," from 50 cents to \$10 each, aggregating nearly \$200 of this amount, the firm contributing the balance, and now Miss Green writes to the firm: "Words do not do justice to the feelings of my heart, but it made me feel very happy indeed. Your treatment has always been so kind to all in your employ."

Alexander Davidoff, manufacturer of diamond mountings, 85 Nassau St., made an assignment Monday to Samuel Cohn, a lawyer at 245 Broadway, giving one preference for \$830.30, to Anna Davidoff, for money loaned. Mr. Davidoff has been in business since July, 1888. He was formerly with M. J. Lasar. He says his failure is due to hard times, and to losses he sustained in recent failures. Assignee Cohn said that he had just taken charge of the affairs, so could not yet give any estimate of the liabilities and assets. His statement will be ready in a few days.

Robert H. Ingersoll & Bro., in a bill in the Chicago courts, say they have an exhibit valued at \$10,000, and have sold large quantities of goods since the Fair opened. Not to violate the rules, they furnished customers with due-bills which would be made good at their branch house. Some time ago an Exposition official saw one of the complainants give a watch to a friend, and, thinking it was being sold contrary to the rules, he notified them that their passes would be revoked and the business closed up. The firm ask the Court to grant an injunction restraining such action.

The question as to the custody of the jewelry and watches that were taken from Eugene Leroux and his wife, Jeanne, by the Brooklyn police at the time of their arrest in April, and which were subsequently turned over to the United States marshal in Brooklyn, was decided by Judge Benedict, of the United States Circuit Court last week, who ordered the property turned over to Collector Kilbreth. The jewels are now in the seizure room of the Custom House in this city. The question as to whether the jewels were really smuggled or not is not yet settled. The trial of the goods will take place Oct. 25th, and if it is decided that they



were smuggled they will be confiscated. The trial of the Leroux, who were released in July on their own recognizance, upon the charge of smuggling is set down for Oct. 21st before Judge Benedict.

**Last Week's Arrivals.**

*THE CIRCULAR has perfected arrangements for obtaining the names and hotel addresses of all the latest buyers visiting New York, and each day posts in its office, 189 Broadway, a bulletin which every member of the trade is cordially invited to copy.*

The following out-of-town dealers were registered in New York during the past week: A. O. Russell, Cincinnati, O., Astor H.; J. E. Hill, Boston, Mass., Hoffman H.; J. Knight, Boston, Mass., Grand Union H.; M. A. Stupp, Rochester, N. Y., Grand H.; Chas. Diesinger, Philadelphia, Pa.; R. Harris, Washington, D. C., St. Denis H.; J. D. Ryan, Middletown, Conn., Sturtevant H.; Mr. Bonestall, San Francisco, Cal., St. James H.; G. A. Montgomery, Los Angeles, Cal., Everett H.; W. C. Hodgson, Montreal, Que., St. Denis H.; H. Rylie, Toronto, Ont., Astor H.; T. E. Pahl, Troy, N. Y., Colonnade H.; H. Eisenburg, buyer for Dives, Pomeroy & Stewart, Reading, Pa., 120 Franklin St.; G. W. Muntgomery, buyer for "The Fair," Chicago, Ill., Broadway Central H.; B. Peck, buyer for the B. Peck D. G. Co., Lewiston, Me., Everett H.; W. S. Wilkinson, Chicago, Ill., Continental H.; G. Fon Dersmith, Lancaster, Pa., Imperial H.; Chas. May, Boston, Mass., St. Denis H.; A. J. Wallis, Columbus, O., Astor H.; J. Allan, Charleston, S. C.; E. Zahm, Lancaster, Pa., Ashland H.; J. S. Mac Donald, Baltimore, Md., Plaza H.; E. M. Stern, Philadelphia, Pa., Astor H.; J. B. Humphrey, Boston, Mass., Imperial H.; Mr. Critzer, San Antonio, Tex., Union Square H.; J. F. Rand, Portland, Me., Astor H.; M. Goldsmith, Cincinnati, O., Belvedere H.; F. L. Brown, Chicago, Ill., Astor H.; L. E. Burns, Memphis, Tenn., Fifth Ave. H.; J. Joseph, San Francisco, Cal., Marlborough H.; E. C. Lathrop, Syracuse, N. Y., Continental H.; J. W. Podmore, Troy, N. Y., Astor H.; G. E. Gregory, Washington, D. C., Imperial H.

**Syracuse, N. Y.**

Miss Louise Friend, of Geo. E. Wilkins', returned on Friday from a two weeks' vacation spent at Saratoga, Lake George and Albany.

J. W. Pierce, formerly with Jos. Seymour Sons & Co., now with G. Armeny, New York, called on friends here Thursday and Friday.

Simon Lesser, A. Lesser's Sons, returned last Tuesday from the World's Fair, and S. Harry Lesser left Wednesday for a visit to the great exhibition.

Eugene B. McClelland last Tuesday received a telegram from John Boyd Thacher, World's Fair Commissioner from New York State, and head of the department of

awards, notifying him of his appointment as a judge of jewelry and precious stones from the island of Ceylon. Mr. McClelland has gone to Chicago to undertake his duties. The Ceylon exhibit of precious stones has been the astonishment of every visitor to the World's Fair. Mr. McClelland's skill as a lapidist is acknowledged so generally in the trade that his appointment as a World's Fair judge will create no surprise.

**A Swindler Represents Himself as a Chicago Jeweler.**

A young man who gave his name as Albert H. Williams was a prisoner in the Tombs Police Court, New York, Saturday, on the charge of swindling Headley & Farmer Co., dealers in leather goods, 180 Broadway, out of eleven dollars worth of goods, by representing himself a member of the firm of Reiger & Williams, diamond dealers, Chicago, Ill. He obtained the goods on an order which had the printed heading of "Reiger & Williams, Madison & Dearborn Sts., Chicago, Ill., and 42d St. and Madison Ave., N. Y. City."

An investigation proved there was no such firm at 42d St. and Madison Ave., and when the young man went again into Headley & Farmer's store Saturday morning they had him arrested. It was then learned that he had in a similar manner obtained goods from the Dennison Mfg. Co., and attempted to obtain diamonds on memorandum from L. Strasburger's Son & Co. and other diamond dealers, but without success. Rieger & Williams, Chicago, have no New York branch, and the name Rieger is not spelled the same as on the cards and bill heads, which this man, A. H. Williams, presented. He was held for examination.

**War Between Brothers in Partnership.**

St. Louis, Mo., Sept. 23. — There is trouble in the firm of Otto Baehr & Co., 511 Franklin Ave. The firm comprises Otto Baehr and his brother Max. In March 1892, they started in business. All went lovely till a short time ago when the brothers began to quarrel and as a result Max wanted to withdraw from the partnership. To this arrangement, the story goes, Otto objected but Max decided that he would have his way anyhow and last Saturday afternoon, while Otto was at the dentist's, Max went through the showcases and, abstracting \$1,300 worth of diamonds therefrom, departed.

When Otto returned he immediately informed the police and Max was arrested. The latter denied that he had done anything to warrant his arrest, saying that as a partner in the firm he had an interest in every piece of jewelry in the house and was privileged to carry off whatever he chose. The police looked at the matter the same way and Max was released.

OTTO BAEHR ASSIGNS, AS A SEQUEL.

St. Louis, Mo., Sept. 25.— Otto Baehr assigned Saturday naming John H. Bohle,

trustee for the creditors. The assets are \$4,100.

**Silver Mounted Reptile Skins.**

THE latest craze in leather goods is for articles made of reptile skins. No handsomer or more striking goods in this line have yet been shown than the natural snake skin and lizard skin cases, books, photo-frames, calendars, purses, pads, etc., introduced by Deitch Bros., 7 E. 17th St., New York. The beautiful markings of the boa constrictor's skin, with its large black and white scales, combined with the artistic sterling silver corners, make one of the most strikingly handsome leather combinations ever put on the market. A feature which will cause these articles to be particularly popular this Fall is that the natural color of the skin is in harmony with the prevailing styles of black and white combinations in all articles of dress. Both lizard and snake skins are famous for their toughness and durability, which are other reasons why these articles are bound to attain great popularity. Besides being shown in the natural colors of the snake and lizard skin, which are retained by a special process in tanning, the goods are shown in all the fashionable tints of green, brown and tan.

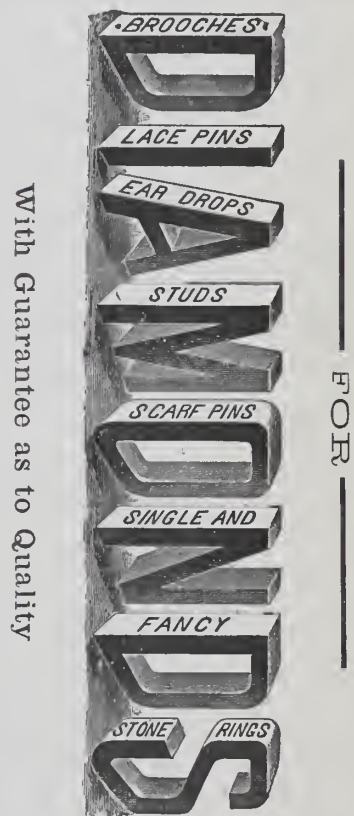

SEND TO

**J.T. Scott & Co.**

**4 MAIDEN LANE,  
NEW YORK.**

**Boston.**

George E. Newton has bought out the store of D. Cutter, at Union Square, Somerville.

Charles May and son are taking a vacation outing which includes a trip up the Hudson river.

J. Edward Wilson, senior partner of Wilson Bros., has just returned from a two weeks' visit to Chicago. He was accompanied by his wife and daughter.

Buyers in town last week included: C. B. Duckworth, Pawtucket, R. I.; Mr. Safford, Safford & Lunt, Newburyport, Mass.; J. G. Olin, Lynn, Mass.; Harry F. Howe, Littleton, N. H.

Chandler E. Edgecomb died Wednesday night at Waltham, aged forty-two. He had worked for the American Waltham Watch Co. a number of years, and when the United States Watch Co.'s factory started he became clerk of the company, a position he held for a long time.

Morrill Bros. Co. is the style of the corporation that succeeds the firm of Morrill Bros. & Co. The concern is capitalized with a paid up stock of \$100,000, and has purchased the goods and fixtures of the old firm. The officers are: Charles F. Morrill, president; Alvin T. Morrill, treasurer, and Oakes A. Drinkwater, secretary.

A yachting trip complimentary to the ladies of members of the Boston Jewelers' Club was enjoyed by a merry party last Wednesday in President Morrill's yacht

*Navarch.* Among the participants were Mr. and Mrs. Charles F. Morrill, Mr. and Mrs. O. A. Drinkwater, Mr. and Mrs. A. T. Sylvester and Miss Sylvester, Mr. and Mrs. William H. N. Pratt and M. A. Pratt. Mr. and Mrs. C. N. Allen, Irving Smith, Miss May Crawford, Mrs. H. W. Patterson, Mrs. W. H. Wood, Mr. and Mrs. Eugene H. Richards, and L. S. Stowe, of Springfield. A reception followed on their return.

**The Attleboros.**

H. F. Barrows has gone to the World's Fair, and will incidentally call on Chicago firms with whom he has dealings.

During the past week W. & S. Blackinton have given employment to a large number of extra hands, which means that business is about to boom here.

W. F. Barden, who has been with Wade, Davis & Co., Plainville, as bookkeeper, for the past five years, has resigned his position to accept a situation with Barden, Blake & Co.

The Attleboro Democrats have selected these delegates for the various conventions that are to be held soon: State, G. A. Sweeney, J. L. Sweet, P. E. Brady, M. W. Potter; county and senatorial, J. W. Cody and J. L. Sweet; councillor, H. E. Carpenter, P. J. Cummings and M. B. Short.

The annual fair of the Attleboro Agricultural Association will be held next week. S. O. Bigney is president and Geo. Randall, secretary. Mr. Bigney has devoted himself

particularly to the jewelry trade. On the first day of the fair there will be a trades procession, and every firm is expected to make a showing. Mr. Bigney thinks the jewelry exhibit will be larger than in past years.

Thursday night the Republicans of Attleboro met and chose delegates as follows: State, J. S. Richards, E. S. Horton, A. I. Wales and W. L. King; councillor, C. H. Wheeler, F. W. Weaver; senatorial and county, M. O. Wheaton, George Randall and L. M. Stanley; representative, E. S. Horton, A. W. Sturdy, Henry Wexel, A. I. Wales, H. A. Streeter and Charles Wethrell.

**Kansas City.**

F. G. Altman, 725 Main St., contemplates selling out his business.

The Hershfield Watch and Jewelry Co., of this city, have incorporated to do a wholesale and retail jewelry business. The capital stock is \$2,000 in single shares of \$20, and the promoters are: R. M. Hershfield, S. Hershfield, and W. S. Teitlebaum, all of this city.

The Edwards & Sloane Jewelry Co. sent a messenger with a box containing \$50 worth of jewelry for A. Patrorie, 1004 Union Ave. Patrorie was away, so the boy left the box with John Graves, a saloon keeper in the same building. Graves did not give it to Patrorie, and when questioned the next day denied having received it. He was arrested and committed to jail to await a hearing.

# "CROMWELL"

Is the name of the new Spoon and Fork Pattern W. B. DURGIN is placing on the market this Fall.

This house produced the ORIGINAL "LOUIS XV." and "WATTEAU." Everybody in the trade knows of THEIR success. CROMWELL is pronounced the peer of anything the CONCORD FACTORY has done.

It is good taste, the die work is perfection, the finish is simply what the trade has grown to expect in "DURGIN'S GOODS."

CROMWELL will be illustrated in these pages shortly. The FANCY PIECES, HOLLOWWARE and NOVELTIES made by W. B. DURGIN are as saleable as his Famous Spoons. PRICES ARE RIGHT.

CHICAGO:

COLUMBUS MEMORIAL  
BUILDING.

W. B. Durgin,

Concord,

New Hampshire.

The Meyer Jewelry Co. are now in their new quarters, 1018 Main St.

A fire broke out on the night of the 17th in the stairway to the building adjoining F. W. Meyer & Co.'s store, and did \$100 damage to them.

**Philadelphia.**

Herman Diesinger, of Hamilton & Diesinger, Geo. W. Scherr and Wm. H. Earle, have all returned from the World's Fair. Frank Kind departed last week for a visit to the Fair.

Jacob Froelich contemplates suing the Pennsylvania Railroad Co. for damages. His fingers were badly crushed and lacerated by a swinging door while on his way home from Chicago.

J. Philip Trau, 1029 Market St., has begun suit against Charles Hewlett for the recovery of two diamond rings and a stud given him to dispose of. On Saturday bail was fixed in Common Pleas Court at \$500.

Walter Hayman, watchmaker, 4509 Land St., was held in \$1,000 bail by Magistrate Ladner on Wednesday, charged with the theft of watches from Rev. William E. Staub, Lewis Miller and others. The watches were given him to repair, and he sold them. Eighteen pawntickets for watches were found in his possession.

It is stated in trade circles that the embarrassment of L. P. White will not have any lasting effect, and that he will resume business as soon as the present entangled affairs are straightened out. Assignee Watson says a statement will be ready probably the latter part of this week, and that Mr. White will pay dollar for dollar, inasmuch as the assets are expected to largely exceed the liabilities. Among the local creditors there is no apprehension. The Retail Jewelers' Association has asked Mr. White to resume operations.

**Pittsburgh.**

G. B. Barrett left Thursday last for New York.

E. Bielman, McKeesport, Pa., has sold out his entire stock to Reineman Bros.

August Loch, Allegheny, is engaged in a kind of Fall cleaning, which will result in a handsome store.

Charles Roberts, of E. P. Roberts & Sons, and Mrs. Roberts left, Saturday, for a lengthy visit to Chicago.

Robert Hardy, for a long time salesman with Heeren Bros. & Co., started out last week as their traveling representative.

Alex. Heyl, after a three years' absence in the west, has returned and is again in business. His rooms are in the Eisner building.

The following jewelers have donated very handsome prizes to the coming bicycle races: E. P. Roberts & Sons, Mr. Arnheim, H. Terheyden, C. S. Hauser and B. E. Arons.

Buyers here last week were: J. Linnenbrink, Rochester, Pa.; B. Neville, Dawson,

Pa.; Henry Grieb, Butler, Pa.; L. C. Brehm, West Newton, Pa., and H. H. Weylman, Kittanning, Pa.

The wholesalers and retailers again enjoyed a game of base ball on the Wilkinsburg Athletic grounds, with the ubiquitous R. M. H. Jantzen as umpire. The score resulted in 4 to 1 in favor of the wholesalers.

**Cincinnati.**

Is. Schroder has returned from a trip west.

Lee Kaufman starts out on the road this week.

Chas. Rauch, Strauss & Stern, is home for a short season.

The Braham Jewelry Co. have opened a store at 212 W. 4th St.

Herman Keck sails for Europe on Oct. 1st. He will be absent three months.

O. E. Bell has purchased a job printing office in Blanchester, O., and will now do all his own circular and card work.

Harry Wadsworth, of the Wadsworth Watch Case Co., is receiving congratulations on the arrival of a new heir at his home.

Chas. Lemmon, formerly with W. H. Miller & Co., insurance agents, will form one of the incorporators of the Oskamp Jewelry Co.

The many friends of Anthony Herschede are urging him to be a candidate for County Commissioner subject to the Democratic Convention. Thus far, however, he has declined to accept.

A number of clock men were here last week, among them being: Messrs. Harris, of the Ansonia; Schwab, of the New Haven; and Miller, of the Seth Thomas. There is a noticeable scarcity of eastern men in Cincinnati this season.

Homan & Co. are opening the season with considerable activity. In some of their departments they are working nights. Orders are coming in with unexpected frequency, and those that were booked for October delivery are being required at once.

**Philip Silverthau Comes in Contact With a Connecticut Law.**

NEW HAVEN, Conn., Sept. 25. — What promises to be an interesting case was the arrest last week of Philip Silverthau, of S. Silverthau & Sons, charged with violation of the license law. Mr. Silverthau has been drumming the valley towns for years, selling diamonds, watches, etc. It is said that he carries at times from \$10,000 to \$15,000 worth of stock and that he has done a flourishing business for years.

On Thursday Detective Egan arrested him in Waterbury for peddling without a license. The jeweler was highly indignant, but was conducted to police headquarters. He declares that the law is unconstitutional as applied to him and says that he will carry the case to the Supreme Court if necessary. Prosecuting Attorney O'Neill states that he has plenty of evidence and that he is ready to accompany Silverthau to the Supreme Court or any where else.

**LE BOUTILLIER & Co.,**

**860 BROADWAY,**

**N. E. cor. of 17th St., - NEW YORK,**

Invite an Inspection of their  
Novelties in

**ROYAL WORCESTER,**

**WEDGWOOD,**

**CROWN DERBY,**

**COALPORT,**

**PÂTE SUR PÂTE,**

**BISQUE.**

Prices are very low this season, and dealers will find many exclusive styles in our stock.

THE BEST QUALITY  
**ELECTRO SILVER PLATE**  
 IS STAMPED

★ **ROGERS & BRO., A. I**

THE  
**Original, Genuine**  
 and  
**Celebrated**

Oyster

Forks

**STAR**



**BRAND**

Twenty-Five

WHICH  
 HAS STOOD THE  
 TEST FOR 50 YEARS.

Patterns.

MADE ONLY BY

**ROGERS & BROTHER,**

WATERBURY, CONN.

16 CORTLANDT ST., NEW YORK.

MAKERS OF THE FOLLOWING LEADING PATTERNS:

"COLUMBIA," "SAVOY," "TUXEDO" AND "ASSYRIAN."

NEW ILLUSTRATED CATALOGUE NOW READY.



As Regards

SILVER PLATE

WE BELIEVE

THAT an Honest article at an Honest price goes further toward making sales than all the advertising in Christendom,

AND WE WORK ACCORDINGLY.

MAKING and SELLING a BETTER Article for the SAME MONEY, or an EQUAL Article for LESS Money than any other concern, is the principal cause of our fast increasing business.



53.—TRAY.

HOMAN & COMPANY,

CINCINNATI.

---

 Visitors to the Columbian Exposition, Remember our Complete Line is displayed at  
155 STATE STREET, CHICAGO.

---

**BAUME & CO.,** 

21 HATTON GARDEN, LONDON, ENGLAND,  
AND SWITZERLAND.

EXHIBITORS AT CHICAGO OF

**TOURBILLION CHRONOMETER WATCH,**

WHICH HOLDS THE RECORD AT ROYAL OBSERVATORY KEW.

---

HIGH CLASS SWISS WATCHES, PLAIN AND COMPLICATED.

PATENTEES FOR SPLIT SECONDS CHRONOGRAPHS (Treble Action.)

---

AGENT FOR U. S., GEO. E. WILKINS, SYRACUSE, N. Y.

# Geneva Optical Company.

Our new catalogue giving new prices, new goods and a full line of Optical Outfits, Trial Cases, Lens Measures, Prism Measures and all kinds of Optical Goods now ready, and sent at request.

WE ILLUSTRATE BELOW A FEW OF OUR NEW SPECIALTIES.



### COMPLETE SET TRIAL LENSES.

No. 995. Contains 32 pairs+(convex) spherical, .25 to .20D; 32 pairs (concave) spherical .25 to .20D; 20 pairs+(convex) cylinders, .25 to .650D; 20 pairs-(concave) cylinder .25 to .650D; 10 prisms; 4 pairs, plain colored lens; 1 white glass; 1 half-ground disc; 2 stenoptics; 1 solid and 2 discs with small hole; discs of hard rubber.

Rims on all the lenses, nicked on the convex, gilded on concave.

Graduated trial frame No. 915. Plain trial frame No. 919. All in well made morocco case, lined with velvet.

This case for accuracy, we are willing to have compared with any either of foreign or American manufacture.

The exceptionally low price, must not be taken to indicate its quality, as that must be judged by the case itself. Price \$59.00.

Special offer 10 and 6 off, net Cash \$50.00.

### OUR PRESCRIPTION WORK

is now the most accurately and promptly done. Try a month and see.

### DIRECTIONS TO USE THE PRISM MEASURE AND LENS CENTERING INSTRUMENT.

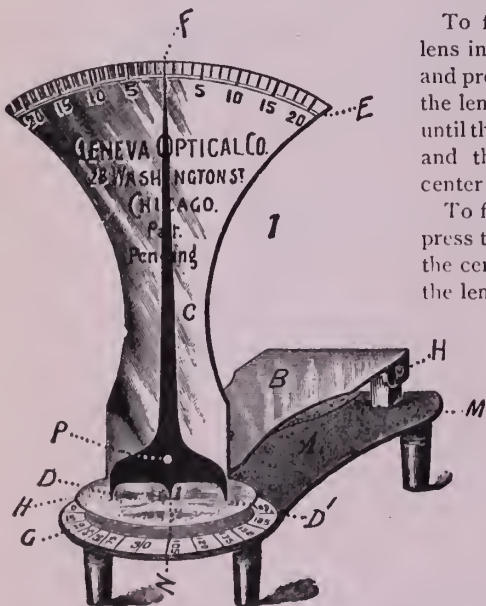

To find the center of a lens, put the lens in as shown in illustration at "H," and press the points "DD" down firmly on the lens, sliding it across the instrument until the index finger "F" points to "O" and the center point will be over the center of the lens.

To find the amount of prism in a lens, press the points "DD" firmly down with the center point "N" over the center of the lens. The index finger will point to the degree indicating strength of prism either plain or in combination with spherical or cylindrical surfaces.

To cut a spherical or cylindrical lens to get any required degree of prism, find the points in the lens, where the index finger will indicate the degree of prism required, and cut the lens with its center at the point

under the center points of index finger. Price \$5.00.



### THE GENEVA LENS MEASURE IMPROVED.

"You press the lens, it tells the focus."

For full description see catalogue.

Price \$10.00.

67 & 69 Washington Street, Chicago, Ill.

# WORLD'S FAIR and WESTERN SUPPLEMENT of THE JEWELERS' CIRCULAR

CHICAGO OFFICE: ROOM 308, INTER-OCEAN BUILDING.

VOL. XXVII.

CHICAGO, WEDNESDAY, SEPTEMBER 27, 1893.

NO. 9.

## ROY WATCH CASE CO.'S PRETTY EXHIBIT.

ALTHOUGH one of the smaller exhibits in the American section of the Manufacturers building, the display made by the Roy Watch Case Co., 17 Maiden Lane, New York, is both interesting and instructive. The pavilion, illustrated herewith, which occupies a space 8x10 feet, is of mahogany, artistically trimmed with brass. Within the pavilion is a small mahogany table, on which rests a showcase containing various specimens of the product of this company.

The exhibit consists mainly of watch cases and examples of the company's process of photo-miniature work upon the inside of cases and watch case caps. Their selection of richly decorated watch cases with raised gold subjects, though not extensive, is important because it shows a distinctly American style of watch case decoration. This bold-subject style, as it is called, was introduced by this company, and, it is safe to say that nothing like it is to be seen in any other exhibit either domestic or foreign. The specimens of photo-miniature work show both heads and family groups of many well-known people, among them being President and Mrs. Cleveland. In many instances the photograph and its reproduction on the cap are shown side by side, in order that the accuracy of the work may be clearly seen. Even in the minute picture of Della Fox, the actress,

in the engraving, the portrait is distinguishable.

Although this company's photo-miniature

It must be remembered that this exhibit is not intended to display the full line of goods manufactured by the Roy Watch Case Co., but is principally to show the perfection to which their photo-miniature process has attained.



THE WORLD'S FAIR PAVILION OF THE ROY WATCH CASE CO.

### A Delicate Carving.

WHAT is probably the most delicate carving in the world is zealously guarded in the private room of the Japanese section, Manufacturers building. Through the courtesy of A. Koidzumi, in charge, one is shown a branch of rice kernels, six in number, attached to the parent stem. The four lower kernels are enveloped in a husk, but from the upper two the husk has been removed. Both are much smaller than the ordinary grain of rice, and no carving is noticeable with the naked eye. Placed under a magnifier there is seen, in exquisite microscopic carved work, on one kernel, the god of wealth, on the other the god of happiness. The detail in each, even to features, is simply marvelous, when it is considered that the point of the finest cambric needle if touched to the work would make an ungainly blotch.

work has now been on the market for over ten years they have had the remarkable experience of never having filled a single order which has not given entire satisfaction.

Mr. Barton, father of Nathan Barton of Ostby & Barton, is in Chicago and expects to cover both city and Fair within four weeks.

## American Silversmithing at the Fair.

IN saying that America has unquestionably the undisputed position of pre-eminence in silversmithing over all other countries, the *New York Times* but echoes an opinion that *THE CIRCULAR* has expressed in different ways from time to time. The following description of the Gorham Mfg. Co.'s exhibit at the World's Columbian Exposition is gleaned from an article in the *Times* of Sept. 20th.

The Gorham Manufacturing Co.'s display at Chicago, says the article referred to, is undoubtedly representative of American achievement in silversmithing. Its comprehensive character is apparent from an inspection, if it be but casual. It is not confined to products of one or of several varieties, and it is thus illustrative of American versatility. Into lines upon which no American silversmith has heretofore embarked, it has turned native adaptability and the skilful handiwork characteristic of the American artisan, with the result that the finer products of Europe have been equaled and in many cases exceeded.

Perhaps the best illustration of this, and one which justifies the claim that America has nothing to fear any longer from the silversmiths of Europe, is the exhibit which the Gorham Co. makes of enamels. No American silversmiths before the Gorham Manufacturing Co. had the temerity to even attempt the production of champ levé, cloisonné, and translucents. They have successfully made an exhibit which occupies three arches, and that this ware is the equal, if not the superior, of any product in enamel on a silver surface made by the best enamel workers in Europe is freely conceded by the

best authorities. It is a further evidence that Prof. Lessing of the Royal Museum of Berlin has purchased several pieces for the museum as representative of the highest proficiency in this art. The collection also gives additional illustration of the high art progress in America, in Limoges enamels of rare beauty and chasteness. As to variety of design, I am informed that this collection original in this country with the Gorham Co., is the most varied ever shown.

Another important fact demonstrated at this Exposition, so far as silver is concerned, is that oxidized effects are imperative to show the full beauty, delicacy and perfection of repoussé work. A number of very beautiful examples of light oxidizing are in the Gorham display. Connoisseurs know that light oxidizing metamorphoses a rich and elaborate chasing, and that the difference between the effect of repoussé in light oxidization and in the highly burnished surface of silver is the difference between a fine oil painting and an engraving.

There is a dinner set of sixty-four pieces exhibited in the Gorham display which is a complete justification of light oxidization, if that were needed. It is known as the Rose dinner service, is entirely original in design, and the repoussé work is a conscientious study of the rose in all its different varieties. Sense of proportions and artistic effect are speakingly illustrated, and it is doubtful whether a finer service, so far as the silversmithing goes, could be made. The almost interminable detail cannot be estimated, even when it is known that it required two years and a half to complete it. Many other illustrations of light oxidized work are to be found, and their beauty and the prominence of the chasing both go to the point of American superiority, for light oxidization is distinctive in the Gorham exhibit.

The *Times* then proceeds to describe and find encomiums for the various features of the exhibit which have been fully described and handsomely illustrated in *THE CIRCULAR*.

Perhaps the most venturesome thing the Gorham Co. has done, continues the article, is found in a display of glass expanded in silver. This is remarkable not in idea so much as in execution, as glass has been successfully blown into composition. It remained for the Gorham Co., to make it successful in solid silver and to at the same time add one more very beautiful combination to the wide field of silver goods. The silver vessel subjected to this process is first made and pierced in filigree, and the glass, in its plastic condition, is then blown in and blended with the metal. Silver is naturally a cold metal, and the greatest care is necessary to prevent the glass from chilling or the silver from burning.

In still another respect the Gorham Co. is representative of high art in silver products. This is in silver casting. It exhibits a statue of Columbus which it produced here as a piece of enterprise, much as it produced the elaborate century vase at Philadelphia in 1876, which by the way, is also in the display at Chicago as a historical exhibit. The statue of Columbus, while not a sample of silversmithing, is entitled to high encomium as a leading example of perfection in casting and modeling in silver. It is in its way as remarkable as any silversmithing can be, because it is the largest successful casting in the world, being composed of 30,000 ounces of the precious metal.

In citing special objects worthy of note I do not mean to convey the impression that there are not many more products in the Gorham exhibit worthy of as full mention, but such as I have specially noted I regard as particularly representative. As a matter of fact, the Gorham display presents a bewildering and seemingly endless array of beautiful specimens of silversmithing, and I understand it is intended after the exposition closes to place it in their retail store at Broadway and 19th St., New York, the exhibit having been so designed that it will fill one entire floor of their establishment. In many lines of endeavor germane to the silversmith's art other than those noted we find high examples in the Gorham display. Its exhibit of bronze ecclesiastical ornaments and furnishings and bronze portrait busts is distinctive of high proficiency.

Indeed, the Gorham exhibit is remarkable not less for the excellence of individual products than for its wide range of objects. It is, therefore, a matter for congratulation that it will be seen in New York, because it is a most instructive object lesson. Such an event as the World's Fair calls out the highest effort, and it invariably has a positive and distinctive influence. In the case of American silversmithing, an exhibit such as that made by the Gorham Co. exercises this influence in a marked degree and in a manner so effective as to be permanent.

## IRONS & RUSSELL,

(SUCCESSORS TO CHARLES F. IRONS.)

MANUFACTURERS OF

**SOLID GOLD EMBLEMS ROLL PLATE**  
PINS, CHARMS AND SOLID GOLD RINGS.

102 Friendship Street, - - Providence, R. I.



ESTABLISHED 1879.

G. W. HOOK,

MANUFACTURING JEWELER,

149 and 151 State Street,

Chicago, Ill.

INSPECTION BY THE VISITING TRADE INVITED.

## GIBSON HOUSE,

CINCINNATI, OHIO.

ABSOLUTELY FIRST-CLASS AMERICAN PLAN HOTEL. \$3.00 PER DAY.

Extra Charge for Parlors and Rooms with Bath attached. The unequalled advantages in central location, liberal management, modern appointments, experienced service and perfect cuisine, have permanently established the Gibson House as **The Most Popular First-Class Hotel in Cincinnati.**

AMPLE VAULTS FOR THE PROTECTION OF VALUABLES.

THE GIBSON HOUSE CO.,

M. B. DUNBAR,

President and Manager





THE EXHIBIT OF THE MANHATTAN SILVER PLATE CO.

SILVER and gold form a most attractive combination and in no exhibit at the World's Columbian Exposition is this better exemplified than in the display of the Manhattan Silver Plate Co. This exhibit is situated near the center of the Manufactures building and is surrounded by broad avenues

roof rises an octagonal cupola surmounted by a staff bearing aloft a star and crescent, the trademark of the company. Huge lights of heavy French plate glass take up the entire sides and smaller plates fill the octagon ends. Through the center at a height of three feet runs a glass shelf 9x4

ship formed of a hand painted plaque with a heavy wide rococo silver and gold border, the corners being engraved with floral designs. The subject is a marine view with a light house, off the coast of Maine, surrounded by a border of sea weed painted from the original sea mosses gathered by the artist.



THE WORLD'S FAIR DISPLAY OF THE MANHATTAN SILVER PLATE CO.

on every side. The settings are worthy of mention as well as the display of silverware. The case is made of natural selected light curly birch and is graceful in all its lines. A panel base rises sheer two feet in height, and eight elegantly carved columns support a decorative roof. From either end of the

feet, of ground glass, supported by three polished gold standards. On the base four raised dais are covered with silk crepe, the centerpiece being in pink and the other decorations being in light blue.

Facing the wide avenue to the east is a ceramic fish platter of exquisite workman-

Rays flash out from the light house athwart the waves and moonbeams passing through storm clouds glint the waves as they dash upon the rocky coast. The dais against which this platter rests supports a masterpiece of silver and gold in a massive punch bowl with one dozen embossed loving cup

resting on a huge salver. The pieces stand upon round discs, satin finished. Between the discs are ornamental floral scrolls in gold; leaf festoons of gilt decorate the border, an inch below the edge which is of gilt in rococo pattern. The graceful cups are gold lined, and have polished silver handles, while the bodies are decorated with gilt chrysanthemum leaves. The bowl has a base 15 inches in diameter, which narrows to a neck 3 inches wide; the bowl is 20 inches in diameter.

As a background, resting against a brass standard, is a carved plaque. On an irregular gilt oval in the center surrounded by a polished band, a rococo gilt border, and a second oval band of gilt, are engraved the trade marks of the firm, and in fancy lettering, the name and location of the company. Around this oval and filling the plaque, with the exception of a polished inch border next the rim, are fine examples of repoussé work in gilt on a chased silver background. At the bottom is a large spotted tiger lily; at the sides a huge rose with leaves peeping from behind; above this a thistle and various American flowers till the top is reached, where an eagle with spread wings rests upon an American shield from which a stand of the national colors extends on either side. In the upper right and left hand corners are the figures 1492-1892. The rim curves but slightly outward and has a gilt edge in rococo design. The modeling throughout is a remarkably fine bit of work and the piece reflects credit upon the designer and engraver.

One of two centerpieces is a silver nut bowl with narrow deep body and ends curving upward and inward. Rustic oak branches form its support and twine about its upper edge with foliage and acorns. At

the curved ends sits gold squirrels with acorns in their paws, very true to nature. The outside of the bowl has engraved oak branches at the sides and ends, and the gold lined interior has similar designs in silver. The other centerpiece is a berry set consisting of two bowls of decorated bisque at the ends of heavy plateaux, while in the center on a pedestal stands in graceful pose an Oriental beauty in silver with gilt drapery. The base rests on eight cubiform feet.

A tea set of ten pieces with scalloped rims and with a gilt rose and roseleaf repoussé pattern on the bodies is prominently placed at the west end of the case and to the rear of this, is a tray with polished center surrounded by chrysanthemum and rose designs in gilt, the same designs being carved around the rim which has a rococo edge. A handsome fruit bowl is engraved in ananas designs on the deep base, then come polished surfaces and conventional designs till the outer top is reached where branches of various fruits form a pleasing deep border. The gold lined interior is rich in fruit designs in silver. A gold rope borders the scalloped edge and a wreath of cherry branches crowns the rope border. The effect of coloring in the ripening cherries is realistically carried out and the piece is well conceived and finely executed.

A unique piece is presented in a scalloped porcelain salad bowl hand decorated with sea weed, resting upon a gilt lobster swimming in a sea of polished silver. The modeling is fine, and the idea is a pleasing one. A tea set of eight pieces, with the exception of a polished silver band on the covers of the pieces and polished handles, is solidly covered with gilt chrysanthemum leaves on a chased gilt background.

On the plate glass shelf above, forming a

glittering array of gilt, silver and glass, is a tea set of twelve pieces in raised, chased gilt on polished silver; two vases 24 inches high in hand engraved gilt Japanese designs; a water pitcher with star and crescent engraving; an epergne with shaded bisque bowls and cut glass flower vase; shaving mugs, gravy boats, silver and cut glass lamps, nut bowls, berry dishes, coffee urns, smoking sets, swinging kettles, soup tureens, candelabra and baking dishes. On the base are shown many of these articles in various patterns and finishes, and also rose stands with cut glass bowls, bread, spoon, pin, bonbon and card trays, water sets, cake baskets, nut and salad bowls, bonbon boxes, fruit plates, napkin rings, individual and tête-à-tête sets, child's mugs, chocolate and after dinner coffee sets, salad dishes, cups and saucers, communion sets, crumb trays and scrapers, hair pin boxes and manicure sets, and in fact everything in hollow ware that could be desired by the most fastidious.

The study in designs and perfect harmony of lines make the articles of this old established firm of the very best order of workmanship and finish. Manager T. H. Purple, of the Chicago office, 67-69 Washington St., will be pleased at all times to show to the visiting trade the full lines of the factory.

Handsome work in enameled miniature portraits is exhibited by the Esmail Enamel Co., 77 Farringdon Road, London, E. C., in the gallery of Liberal Arts, British Section, column B 51. The portraits are painted on enamel and then fired. High class work is shown in the execution by the artists and the portraits are highly desirable for lockets, brooches and similar articles of jewelry. Being vitrified on enamel they are permanent whether in monochrome or painted.

# JUERGENS & ANDERSEN COMPANY,

## DIAMONDS AND MOUNTINGS,

Order Work a Specialty.

125-127 State St., Chicago.

ONE OF THE BEST OF THE VERY BEST.

QUALITY IS THE STANDARD OF VALUE.

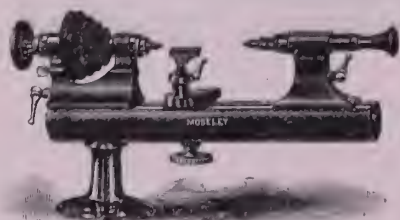

MEN INTERESTED WRITE YOUR JOBBER OR

MOSELEY & CO., - - ELGIN, ILL.



HAS LENGTH, STRENGTH, ACCURACY.

THE PLANCHAMP & BECKER CO.

Makers and Repairers of

WATCH CASES,

Gold and Silver Plating —

— of Watch Cases a Specialty.

UNEXCELLED FACILITIES.

63 and 65 East Washington St., Chicago.

PARSONS : SCHOOL

— FOR —

WATCHMAKERS,

PEORIA, - - - ILL.

Send for Circular and Terms.

PARSONS & CO.

## Chicago.

Visitors to the rooms of the Chicago Jewelers' Association last week were:

J. P. Jackson, Owensville, Ind.; W. H. Hoyle, Sidney, O.; Bert Barborka, Iowa City, Ia.; G. W. Sherman, Hobart, Ind.; J. H. O. Daniel, Gloucester, O.; F. J. Toffley, Cape Girardeau, Mo.; B. L. Gates, St. James, Minn.; C. E. Ritcher, Middleville, Mich.; H. F. Doan, Blissfield, Mich.; Geo. H. Casperke, Brandenburg, Ky.; Geo. C. Hasslinger and wife, Jackson, Mo.; A. K. Jobe, Jackson, Tenn.; Jos. Washle, Louisville, Ky.; Ralph G. Carruthers, E. Boston, Mass.; M. Dorenfeld, Corsicana, Tex.; H. Rohne, St. Louis, Mo.; L. Voigt, Jr., Roanoke, Va.; Geo. C. Mosher, Chattanooga, Tenn.; J. A. Mamer, Pilot Point, Tex.; Henry Foral, Lafayette, Ala.; J. A. Hitchcock, Liverpool, Eng.; C. J. Adams, Bowling Green, Ky.; Jas. S. Johnston, Kingston, Can.; The Misses Crothers, Kingston, Can.; Fred H. Taber, Grand Lodge, Mich.; Will H. Ricaby, Belding, Mich.; Will G. Curley, Geneseo, Ill.; Geo. F. Merry, Dayton, O.; Joseph Mirlach, Beaver Dam, Wis.; J. F. Mirlach and wife, Beaver Dam, Wis.; C. L. Merry, Kansas City, Mo.; P. W. Horgan, Beaver Dam, Wis.; Wm. N. Shaffner, Philadelphia, Pa.; E. J. Peck, Braidwood, Ill.; William Priest, West Chester, Pa.; E. Fry, Belleville, Kan.; Geo. M. Geer, Providence, R. I.; H. A. Barmer, St. Louis, Mo.; F. D. Smith, M. D., Cooperville, Mich.; W. H. Hoyle and wife, Sidney, O.; J. E. Fairbank, Jacksonville, Ill.; A. W. Kirk, Red Bluff, Cal.; Rud. C. Hahn, New York; D. S. Hewitt, Toulon, Ill.; J. R. Kocher, San Jose, Cal.; G. Hottmann, Lebanon, Ill.; H. H. Dobson, Mexico, N. Y.; H. Kirgasser, Mobile, Ala.; H. M. Stevenson, Escanaba, Mich.; C. M. Wright, Lexington, Ky.; F. A. Perry, Lewiston, Me.; W. L. Jobe, Columbus, Miss.; Az. Megede, Norbourne, Mo.; John McBride, Fort Worth, Tex.; Mrs. J. McBride, Fort Worth, Tex.; Robert Goldstein, Washington, D. C.; C. E. Abbott, Herington, Kan.; F. Kocekenitz, Muscatine, Ia.; E. A. Muller, Omaha, Neb.; Charles Maschik, Ottumwa, Ia.; Ed. L. Howard, Eldon, Ia.; Chas. F. Reynolds, Beatrice, Neb.; H. N. Tuohy, Goodland, Kan.; H. F. Steck, Washington, Ia.; G. Anderson, Taylorville, Ill.; C. H. Wilson, Savannah, Mo.; W. R. Weld, Waterloo, Ia.; J. G. Holman, Prince Albert, Ont.; D. L. Bowles, Martinsville, Va.; T. H. Self, Martinsville, Va.; G. T. Marsh, Atlantic, Ia.; A. Gluck, Dodge City, Kan.; C. S. Durfee, Davenport, Ia.; Fred Woltman, Rock Island, Ill.; C. H. Manly, Belleville, Kan.; W. J. Davison, Topeka, Kan.; W. J. Davison, Topeka, Kan.; Chas. P. Waldron, Valley Junction, Ia.; Aug. Wetteroth, St. Joseph, Mo.; H. E. Boughton, Brooklyn, Ia.; Frank Le Bron, Keokuk, Ia.; J. L. Bliss, Atchison, Kan.; W. A. Kirkham, Leavenworth, Kan.; H. P. Holmes, Des Moines, Ia.; O. K. Butler, Indianola, Ia.; S. W. Carroll, Sanilac Center, Mich.; P. G. Lindblom, Minneapolis, Minn.; D. L. Bowles, Martinsville, Va.; Wm. B. Noble, Petrolia, Ont.; Joseph Harz, New Orleans, La.; Duane G. Berry, Carthage, Ill.; H. T. Crane, Maryville, Mo.; Henry Hotthoff, St. Louis, Mo.; R. J. Satterthwait, Charleston, W. Va.; F. H. Pardon, Owensboro, Ky.; John McKenney, East Liverpool, O.; Manie McKenney, East Liverpool, O.; W. P. Morgan, San Francisco, Cal.

Visitors to Chicago and the Fair show a large proportionate number from Ohio and Pennsylvania. The list follows:

R. Waldin, Quincy, Ill.; Mr. Mirlach, Beaver Dam, Wis.; Bob Thrasher, Hot Springs, Ark.; P. S. Wise, St. Charles, Ia.; C. H. Wilson, Blockton, Ia.; Mr. Glasgow, Cherokee, Ia.; Talbot W. Jenkins, Baltimore, Md.; Mr. Smith, Harvard, Ill.; Mr. Parsons, Menominee, Mich.; W. C. Sherman, Orlando, Fla.; A. K. Jobe, Jackson, Tenn.; D. F. Sullivan, Rockford, Ill.; J. H. Booth, Alton, Ill.; L. Schwab, Birmingham, Ala.; Cray Bros., Hancock, N. Y.; I. S. Adler, New York; J. M. Engel, Philadelphia, Pa.; F. E. Brand, Findlay, O.; Wm. H. Moore, Philadelphia, Pa.; S. A. Dodge, Millbury, Mass.; L. M. Sachs, New York; D. H. Mitchell, Philadelphia, Pa.; Thomas Lees, Hamilton, Ont.; P. Schierenbeck, Brooklyn, N. Y.; Sylvester Mussina, Williamsport, Pa.; Geo. E. Jones, Osceola Mills, Pa.; R. E. Fate, Lena, Ill.; L. Lindenborn, New York; Milton Kohler, Hagerstown, Md.; Henry H. Schellberg, Kansas City, Mo.; C. F. Lauterbach, Petersburg, Va.; O'Neil & Gardner, Lincoln, Neb.;

Philip McCracken, Cleveland, O.; W. H. McCaw, Port Perry, Can.; Bernard Plaut, Cincinnati, O.; Fred Rice, Fitchburg, Mass.; Geo. H. Cook, Ravenna, O.; W. J. McKinney, East Liverpool, O.; John M. Stinson, Camden, Ark.; W. L. Kelley, Helena, Ark.; Greenberg & Herskovitz, Great Falls, Mont.; J. B. Ferguson, Princeville, Ill.; E. W. Whitlock, Madrid, Ia.; Fitzsimmons & Foster, Fostoria, O.; I. N. Williams, Kansas City, Mo.; F. E. Van Patton, Meadville, Pa.; Lee Oberdofer, Henderson, Ky.; C. E. Russell, Kansas City, Mo.; Noyes & Huber, Paris, Tex.; F. H. Shearer, Bay City, Mich.; H. C. Morrison, Mt. Pleasant, Pa.; John A. Crisp, Jefferson, O.; Wm. F. Kapp, Toledo, O.; A. C. Johnston & Bro., Kingston, Ont.; John Spencer and daughter, Edgerton, Wis.; Jean Tack, Newark, N. J.; Geo. Windhurst & Son, Baltimore, Md.; T. L. Combs, Omaha, Neb.; Bernard Karsch, New York; A. Schemel, Cincinnati, O.; Thos. Rohner & Son, Clarksville, Tenn.; R. J. Gabriel, Poughkeepsie, N. Y.; G. H. Wilson, Griggsville, Ill.; Ralph P. Parmenter, Newton, Ia.; N. J. Provsgaard, Manti, Utah; John F. Kohler, Richmond, Va.; A. F. Jahnke, Richmond, Va.; L. G. Jahnke, Lexington, Va.; C. H. Case & Co., Hartford, Conn.; Thos. J. Brough, Baltimore, Md.; C. A. Ludwig, Lexington, Mo.; C. H. Bush, Los Angeles, Cal.; D. B. Ward, Kansas City, Mo.; C. Jacobs, Rochester, N. Y.; Geo. W. Chase, Kansas City, Mo.; John A. Walker, Steubenville, O.; W. H. Hopper, Cobourg, Ont.; C. W. Mosher, Holly, Mich.; H. P. Holmes, Des Moines, Ia.; W. H. O'Connell, Audubon, Ia.; Joseph Mehmert, Cincinnati, O.; C. H. Haney, Belleville, Kansas; F. J. Edgar, Eldora, Ia.; Cramton Bros., Warren, O.; D. F. Wetzel, Spokane, Wash.; Chas. D. Smith, Bridgeport, O.; E. C. Eldredge, Springfield, Mass.; W. J. Lukens, Wheeling, W. Va.; C. F. Maskall, Knoxville, Tenn.; L. W. Betts, Cambridge, Md.; Wm. E. Mickle, Jr., Mobile, Ala.; N. A. Strong, Eaton Rapids, Mich.; J. C. Joss, New Philadelphia, O.; Geo. Fisher, Lambton, Ont.; Joseph A. Chaxil, Queens, N. Y.; E. D. Wilcox, Uxbridge, Ont.; F. Bernet, Louisville, Ky.; Wm. J. Miller, Baltimore, Md.; E. J. Camm, Monmouth, Ill.; E. Lines Co., Mt. Pleasant, Ia.; Wm. H. Shipman,

New York; C. W. Teetzel, Benton Harbor, Mich.; Chas. B. Wickens, Syracuse, N. Y.; Jas. E. Harper, Delhi, N. Y.; M. S. Darling, Trenton, Mo.; Instalment Watch Co., Detroit, Mich.; Andrew P. Nahmens, New York; G. W. Sherman, Denver, Col.; John B. Yates, New York; Grant W. Shuman, Hobart, Ind.; F. H. Kuhns, Sharpsburg, Pa.; H. Gerlach, Philadelphia, Pa.; Geo. Baney, Fayetteville, N. Y.; J. H. O'Daniell, Gloucester, O.; Max M. Maas, Kansas City, Mo.; R. D. Warrel, Mexico, Mo.; McAllister & Hambruch Bros., Rochester, N. Y.; E. P. Battley, Sarnia, Ont.; F. W. Butler, Albion, N. Y.; Fred S. Dickinson, Conneaut, O.; Geo. A. Disque, Erie, Pa.; H. C. Reine-man, Pittsburgh, Pa.; Lynch & Gaither, Commerce, Mo.; John Brenner, Youngstown, O.; H. P. Buckley, New Orleans, La.; J. C. Armstrong, Ottawa, Kan.; John A. T. Schanter, Cambridge, Md.; Harry M. Eliassof, Albany, N. Y.; Geo. W. Danner & Co., Manheim, Pa.; J. S. Butner, Cleburne, Tex.; J. M. Mittenmyer, St. Elmo, Cal.; Sears & Bro., Brooklyn, N. Y.; J. Crocker, Marva, Ill.; J. H. Durando, Warsaw, Ind.; C. H. Nerbourg, St. Charles, Minn.; A. G. Robb, Jr., Seymour, Ia.; John Brenner, Youngstown, O.; Ed. Baumgart, Brenham, Tex.; John C. Meyer, Jr., New Orleans, La.; H. E. Barth, No. Vernon, Ind.; W. R. Amidon, Hartford, Wis.; W. A. Arnold, Bellefontaine, O.; Z. S. Kennedy, Kansas City, Mo.; Henry Hahn, Cincinnati, O.; Heibenthal & Priess, Scribner, Neb.; John A. Crisp and wife, Jefferson, O.; John F. Carter, Ft. Dodge, Ia.; Henry Kohn and wife, Hartford, Conn.; W. B. Shackelford, St. Joseph, Mo.; Wm. F. Wilmes, Kansas City, Mo.; E. J. Taylor, Litchfield, Minn.; Frank J. Marvin, Findlay, O.; G. W. Sherman, Denver City, Col.; O. M. Campbell, Petaluma, Cal.; R. B. Luse, Hopkins, Mo.; A. Backer, Syracuse, N. Y.; Will G. Curley, Geneseo, Ill.; H. T. Pixley, Barrington, Ill.; C. H. Ludlow, Dunkirk, N. Y.; M. Newfield, New York; M. L. Kramer, West Union, Ia.; F. P. Fisk, Epping, N. H.; R. G. Hall, Gray, Me.; E. W. Cook, Plattsmouth, Neb.; W. W. Fox, Lewistown, Ill.; H. A. Barmer and wife, St. Louis, Mo.; Miss Lettie Fritch, St. Louis, Mo.; Chas. H. Simpkins, Fairbury, Neb.; N. Sinner, Cleveland, O.; T. S.

## RECEIVER'S SALE.



ENTIRE Stock of Giles, Bro. & Co. Fourth Floor Masonic Temple, consisting of Diamonds, American and Swiss Watches, Jewelry, Silver and Plated Ware, Tools, Materials, etc. will be sold in lots to suit the purchasers, at large reduction from original cost price.

An unusual chance for live Jewelers to obtain bargains.

W. H. GLEASON, Receiver.

July 14th, 1893

Keller, Charlottesville, Va.; G. A. Yancey, Kansas City, Mo.; J. N. Williams, Kansas City, Mo.; W. B. Reed, Hastings, Minn.; O. K. Butler, Indianola, Ia.; W. H. Hobbs, Buffalo, N. Y.; Frank Le Bron, Keokuk, Ia.; E. M. Cox & Son, Seneca Falls, N. Y.; A. L. Deming, Rootstown, O.; J. Halp, Montpelier, O.; O. A. Watson, Watseka, Ill.; Bernard Berens, M. D., Philadelphia, Pa.; D. B. Ward, Kansas City, Mo.; G. T. Marsh, Atlantic, Ia.; G. Grove, Tipton, Ind.; C. O. Binderman, St. Louis, Mo.; O. H. Snyder, Plattsburgh, Neb.; G. Hoffmann, Lebanon, Neb.; E. A. Polley, Seward, Neb.; Geo. E. Sherwood, Waterloo, N. Y.; J. E. Fairbank, Jacksonville, Ill.; Theo. L. Rogg, Des Moines, Ia.; Chas. E. Hart, Sharon, Pa.; E. F. Bucher, Allegan, Mich.; C. N. Hetzner, Peru, Ind.; H. H. Brainard, Medina, O.; J. S. Throp, Greensburg, Ind.; Paul Hohfeldt, Escanaba, Mich.

F. A. Hubbard and wife, Springfield, Mass., passed a week at the Fair.

Henry Barmeier, credit man for L. Baum Jewelry Co., St. Louis, is in the city.

Joseph Keith, formerly in business in Omaha, Neb., is engaged in the repair de-

partment of Montgomery Ward & Co., this city.

Mr. and Mrs. Marx, of the Kossuth Marx Jewelry Co., New York, arrived here a week since for a two weeks' visit.

James G. Woodruff, secretary of the Wm. L. Gilbert Clock Co., will be in Chicago the coming week to attend the Fair.

Mr. Hart, of E. G. Webster & Son, Brooklyn, N. Y., was last week called to Morrison, Ill., by the death of his mother.

R. W. Adams, of T. W. Adams & Co., made his present World's Fair trip profitable by calling at the principal cities on his way west.

Mr. Tatsch, of Tatsch & Wild, has left for New York, and will make his headquarters with Koch, Dreyfus & Co. while in that city.

Manager A. L. Sercomb, of the Chicago

house of the Meriden Britannia Co., returned Saturday week from a visit to the factory.

J. A. Hudson, Chicago manager for the Roy Watch Case Co., left Thursday for a short period of rest and pleasure at the northern lakes.

The Auditorium has had as a guest the past ten days, Daniel F. Appleton, of Robbins & Appleton, who is examining the World's Fair exhibits.

G. A. Webster returned Sunday night from the factory, having made a circuitous trip on his way east and stopped at principal western cities on his return.

Willard E. Aikman representing Haviland & Abbot, New York, at the Fair for the past month, returned Wednesday and is succeeded by W. P. Miller.

S. N. Jenkins, representing Aikin, Lambert & Co., returned to the Chicago office, 42-44 Madison St., from a week in Chicago territory and reports a first class business.

William Gibson, founder and proprietor of the Goldsmiths' & Silversmiths' Co., of London, owner of the business of Mappin Bros. and William Gibson & Co., Belfast, arrived Wednesday to remain during the continuance of the Fair.

Royal E. Robbins, treasurer of the American Waltham Watch Co., arrived in Chicago Monday week and is stopping at the Chicago Beach Hotel. Mr. Robbins will return to Boston the present week after ten days at the Fair.

# REED & BARTON,

## SILVERSMITHS,

MANUFACTURERS OF

STERLING SILVER *and* SILVER PLATED WARE.

SALESROOMS:

37 Union Square, New York.

34-36 WASHINGTON STREET,

Venetian Building, Chicago.

FACTORIES, TAUNTON, MASS.

# HENRY J. ROHRBACH,

94-96 State Street, (Room 524,) CHICAGO.

SILVERSMITH AND MANUFACTURING JEWELER.

COLD, SILVER AND NICKEL PLATER.

Silver and Silver-Plated Ware of all kinds Repaired, Refinished and Polished at Low Prices.

SEND FOR PRICE LIST.

ALL KINDS OF BRONZES REPAIRED AND REBRONZED.

Full facilities for manufacturing and repairing all classes of Jewelry for the Trade.

Remember—Room 524.

## JEWELERS.

We guarantee to sell you Sterling Silver Flat Ware at a less price than any other manufacturer, and give you newer designs.

We will increase your profits if you will let us. Is it not worth trying?

OVAITT & WARNER, Silversmiths, PORTLAND, OREGON.

DALE CHUCKS.



Manufactured by

HOROLOGICAL TOOL CO., 86 N. CLARK STREET,

For Sale by all Jobbers CHICAGO.



Racine Jewelry Mfg. CO.,

SPECTACLE TEMPLE WASHERS,

Gross in a Bottle, 25c.

For Sale by Dealers in Jobbing Materials

# ALBERT H. BONNET,

ONLY EXCLUSIVE WHOLESALE JEWELRY HOUSE IN OHIO.

COLUMBUS, WALTHAM, ELGIN, HOWARD AND STANDARD WATCHES, GOLD AND FILLED CASES, JEWELRY, CHAINS, CLOCKS.

FULL LINE OF TOOLS AND MATERIALS.

No. 24 E. SPRING STREET,

COLUMBUS, OHIO.

H. C. Walton, secretary of the Wadsworth Watch Case Co., spent a day at the Chicago office, 611-613 Columbus building.

Wm. H. Thurber, of Tilden, Thurber Co., Providence, is making his headquarters with the Gorham Mfg. Co., while in the city, on a World's Fair visit.

The Grand Jewelry Co., of Chicago, have incorporated with a capital stock of \$25,000; incorporators, Maximilian Mergenthal, Joseph H. Bourland and Mengo L. Mergenthal.

Frederick W. Smith, once head salesman for George H. Ford, New Haven, Conn., is under arrest in this city as a fire-bug. It is alleged he is concerned in a wholesale conspiracy to burn houses to get the insurance.

Z. K. Straight, Walla Walla, Wash., left for home Thursday. On his return Mr. Straight will spend a day at Rochester, Minn., with E. Damon, his partner of thirty years ago.

S. Goldsmith, a younger brother of the Goldsmith Bros., is engaged to be married to Miss Julia Nussbaum, of Plymouth, Ind. No cards have yet been issued. Mr. Goldsmith is rusticating at Plymouth.

Geo. F. Lyman, of Lyman & Co., etchers and engravers, 96 State St., is making a canvass of the Fair for new things. Mr. Lyman will show his etching classes the benefits derived from his World's Fair observations.

Wallingford, Conn., is well represented in the city. C. H. Tibbetts, from the office of Simpson, Hall, Miller & Co., accompanies Miss Bessie Hull. Herbert Atkinson, designer of hollow ware, and wife, and John Clulee, flat ware designer, both with Simpson, Hall, Miller & Co., and Frank Talbot, with R. Wallace & Sons Mfg. Co., are interested in silver lines at the Fair.

Justice Prindville's courtroom was filled one morning a few days ago with victims of the Elgin Watch and Jewelry Co. F. Kline, one of the patrons of the concern, was the complainant in a civil suit against the company, which was represented by E. Milton Lane, one of the partners. Kline purchased a ring for eleven dollars which was supposed to be solid gold. A file developed the fact that its exterior only was gold, while the interior was filling of the cheapest nature. He had Lane arrested and tried before Judge Clifford, who fined him \$100 and expressed regret that he could not send him to the penitentiary.

**Louisville.**

Mr. and Mrs. W. C. Kendrick have returned from Chicago.

D. Klass, the wholesale jeweler at 7th and Main Sts., is advertising his business for sale.

M. Lorch has moved into his new store at 236 W. Market St., and is having it fitted up with electric lights.

Phil. Hagen, of Hagen & Hetsch, has returned after a trip to the G. A. R. encampment at Indianapolis, and a visit to the World's Fair.

**Indianapolis.**

Wm. J. Eisele has returned from his World's Fair trip.

Samuel S. Goldsberg has resumed his old place as watchmaker for Jas. N. Mayhew.

Robt. L. Moorhead, of R. L. Moorhead & Co., spent a day or two last week at the home of his brother, Thos. Moorhead, the wholesale jeweler.

The case of Baldwin, Miller & Co. against Edward Ducas was taken out of the courts, the application for a receiver being denied, and compromised.

Buyers in town last week included: S. M. Royer, Patricksburgh, Ind.; D. S. Whitaker, Lebanon, Ind.; Chas. Jenkins, Charleston, Ill.; A. Hawkins, Noblesville, Ind.; L. J. Hernley, Alexandria, Ind.; and E. P. Searles, Summitville, Ind.

Sept. 18th, burglars blew open the safe in E. F. Stark's jewelry store, at New Point, Ind., and got away with \$1,000 worth of watches and jewelry. No trace of the thieves was discovered, but it is supposed that they were injured in the explosion as a trail of blood was found on the floor in front of the safe.

**A Daring Jewelry Thief at Length Found by the Police.**

CHICAGO, Ill., Sept. 21. Detectives White-man and O'Day, of Boston, reached Chicago a few days ago to look for James O'Brien, alias Bruno, alias Moore, who is in the Bridewell on a twelve months' sentence for pocket picking. On the evening of Feb. 19, 1892, O'Brien and James Murdock entered Joseph Waxman's jewelry store, 807 Washington St., Boston. Mr. Waxman had gone to supper, and only one clerk remained in the store. Murdock engaged the clerk in the rear part of the store while O'Brien opened a showcase and stole four trays containing diamond rings valued at \$2,486 and darted out of the store followed by Murdock. The clerk gave chase, and shouted for the police, but the men made their escape.

The next heard concerning the thieves was a few months later, when they turned a similar trick in Philadelphia, when Murdock was caught and sent to the penitentiary for five years, but O'Brien made his escape. The Boston police have been looking for O'Brien since the night of the robbery, and will to-morrow take him from the Bridewell to Boston for trial.

# The Wadsworth Watch Case Co.



General Offices,  
NEWPORT, KY.

Filled



Cases.



Chicago Office,  
COLUMBUS BUILDING.

**Pacific Coast Notes.**

W. W. Martin, Salem, Ore., has given a mortgage for \$4,097.

W. W. Houghton, Seattle, Wash., has removed to 704 Front St.

E. C. Brigham, Portland, Ore., has given a chattel mortgage for \$200.

Wolsky & Greenblatt, Seattle, Wash., has given a chattel mortgage for \$1,500.

John F. Goldback, Medical Lake, Wash., has moved his jewelry stock into Moss & Barnes' store.

Mrs. Adolphine Voight has entered suit against Jeweler Herman F. Voight to set aside a decree of absolute divorce granted by the Los Angeles Court several years ago,

to recover about \$1,500 alimony now due, and to secure which an attachment has been laid on a certain Los Angeles mortgage alleged to be owned by Voight, but which rests in the name of a sister, residing in Philadelphia.

C. H. Bush has entered suit against Mrs. Jennie E. Swan to recover \$500 money loaned, which debt was contracted while Mrs. Swan was clerking in his store. a year or more ago.

Elmer Mayberry has been bound over in the sum of \$500 in Seattle, Wash., for stealing \$400 worth of diamonds owned by Rumpf & Mayer, wholesale jewelers, of that city. Mayberry obtained the diamonds in the following manner. Chas. Reichart, a

former employe of J. K. Bayse, took a pair of diamond set earrings and two large diamond finger rings to sell on commission. Reichart fell in with Mayberry who thought he had a customer for the goods, and offered to sell them for a certain share of the commission. The diamonds were turned over to Mayberry, who at once fled to Tacoma and thence to Portland, where he was arrested some days ago. He had pawned the jewels for \$250.

**Minneapolis and St. Paul.**

C. Nelson, St. Paul, has gone to the World's Fair.

F. A. Defiel, St. Paul, has returned from a protracted visit to Chicago.

Mr. Sinclair, watchmaker for Henry Bockstruck, St. Paul, is on the sick list.

A judgment for \$201 has been entered against Mrs. Mary Stapf, Dunkirk, N. Y.

Peter Larson, Zumbrota, Minn., is visiting in Minneapolis, where he will remain several weeks.

W. C. Leber, Minneapolis, is selling off all of his old stock and is advertising an assignee's clearance sale. He will continue in the jewelry business.

The Reed & de Mars Jewelry Mfg. Co., Minneapolis, are sending out to the trade of the northwest, a new illustrated circular and price list of clocks and silverware.

Out-of-town jewelers visiting the Twin Cities the past week were: Albert Asleson, Sacred Heart, Minn.; M. N. Berg, Cloquet, Minn.; E. S. Mills, Pipestone, Minn.; I. O. Brown, Ortonville, Minn.; Mr. Eckberg, Fergus Falls, Minn.; A. Pearlman, Bayfield, Wis.; Lucien Diacon, Chaska, Minn.

Eastern jobbers and manufacturers represented in the Twin Cities the past week were: Derby Silver Co., by Mr. Miller; Harvey & Otis, by Mr. Harvey; L. W. Pierce & Co., by Mr. Darling; Manhattan Silver Plate Co. and Holmes & Edwards Silver Co., by A. E. Hall; M. C. Eppenstein & Co., by Ernest Eppenstein.

**Connecticut.**

H. R. Woodward, Norwich, will start on the 25th for a fortnight's outing in the wilds of Maine.

Christopher Strobel, of Lake, Strobel & Co., Waterbury, announces that pressure of business forces him to decline to run for the office of city councilman.

Eli Carpenter, the colored burglar who was taken to Bridgeport from New Jersey on a requisition, pleaded guilty to the charge of burglarizing the store of Solomon Meyers. Judge Wheeler said that he thought there were extenuating circumstances and instead of sending the accused to State prison let him off with a jail sentence of one year. The case against Carpenter's wife was nolle.

George E. Hill and T. L. Bartholomew, commissioners on the insolvent estate of J.

*Our Catalogue No 4 of Diamond Ring Mountings is ready - it is useful, send for it  
Waterman & Lehmann 37 Maiden Lane New York*

**THE IMPROVED RIVAL FOUNTAIN PEN. MOST RELIABLE AND GUARANTEED TO GIVE PERFECT SATISFACTION. OVER 75,000 IN USE.**



**D. W. BEAUMEL,** Inventor and Manufacturer, REPAIRING A SPECIALTY. 17 John St., New York.

**HENRY GOLL & CO.,**  
17 JOHN ST., NEW YORK.



SPECIAL CASES MADE TO ORDER AND REPAIRING IN ALL ITS BRANCHES.

**PEARLS.**  
**RUD. C. HAHN,**  
194 BROADWAY, NEW YORK.  
**GARNETS.**

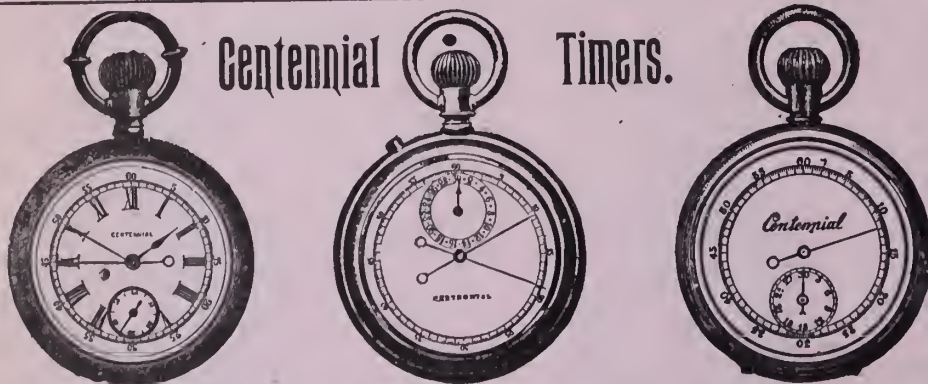

These Watches are one-third larger than above sets.

**CROSS & BEGUELIN,**  
Manufacturers, Importers and Jobbers of  
Watches, Diamonds, Jewelry, Watch Materials, etc.,  
17 MAIDEN LANE, NEW YORK.

B. Capron, the insolvent Bridgeport jeweler, have reported claims to be \$19,015.58.

The New Haven Clock Co., who have been running three days per week, started up Sept. 18th to run six days a week, full time.

The J. D. Bergen Co., Meriden, who have been running their factory on half time will hereafter run on full time, which is fifty-five hours a week.

The Middletown Plate Co. have sent out three traveling salesmen. The company's shops have resumed running full time, six days of ten hours each.

Julius Knell, foreman for C. C. Schunack, manufacturer of silverware cases and paper boxes, in Meriden, is preparing to start in the same line of business for himself.

Henry Kohn & Sons, Hartford, have completed fitting up the second floor of their building as a fine arts room. The firm will have a formal opening of this floor later in the month.

The Wm. Rogers Mfg. Co. and the Barbour Silver Plate Co., Hartford, started their works on full time Sept. 18th. They have been gradually increasing the working hours since they had their shut down.

The Holmes & Edwards Silver Co., Bridgeport, now work nine hours a day and five days a week, and during that time they employ almost the whole number of their usual force. Their secretary reports business as improving.

At the Silver Plate Cutlery Co.'s works in Shelton a number of alterations and improvements are being made. The etching department is to be enlarged by the addition of another story and a number of repairs made in other departments.

Maltby, Stevens & Curtiss Co., Wallingford, have received a large order for blanks from the Wm. Rogers Mfg. Co., Hartford, and are again running their works on full time. The Winsted clock shops have started up again on nearly full time. The Derby Silver Co. expect a large Christmas trade and will probably cease running on reduced time (four days a week) soon.

Off to the great Fair: Mr. and Mrs. W. F. Rockwell, of Meriden, Sept. 20; Superintendent Henry L. Beach, of the E. Ingraham Co., jeweler R. S. Gardner and wife, Birmingham, and a party of friends, Sept. 18th, to be absent two weeks; C. H. Tibbits, of Simpson, Hall, Miller & Co., and wife and Miss Bessie Hull, Sept. 18th, to be gone ten days. W. F. Rogers, of C. Rogers & Bros., and family have returned from the G. A. R. encampment, Indianapolis, and from the World's Fair; C. D. Warner, Ansonia, is home from the big show and R. N. Johnston, Ansonia, has just sailed from New York on a trip to Norfolk, Va.

The *Weekly Herald*, of Pottsville, Pa., recently contained a lengthy biographical sketch of W. H. Mortimer, the well known jeweler of that town. The *Herald* claims that "in point of intelligence and business tact, Mr. Mortimer has no successful rival" in his community.

# A NOVELTY FOR BICYCLE AND DASHBOARD.

PRACTICAL.

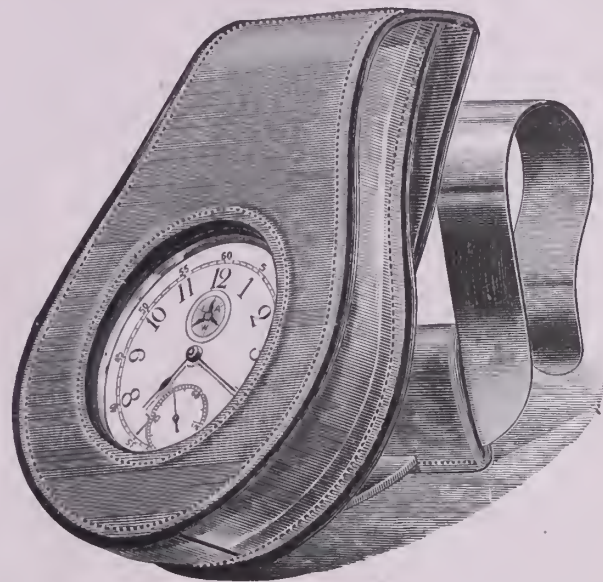

RELIABLE.

**A. WITTNAUER,**

Manufacturer and Importer,

19 MAIDEN LANE,

NEW YORK.

JEWELRY - CASES,  
TRAYS.

Jewelers' Findings.  
Chamois Bags.

SILVERWARE - CASES.

**S. & A. BORGZINNER,**

82 & 84 Nassau Street,

NEW YORK.

WE HAVE IMPORTED FOR THIS SEASON AN EXTRA LINE OF

**Fine Silk Velvet Cases.** Our prices are so low that you can buy them in place of Plush Cases.

Write us for Prices.

Samples Mailed Free.

**Detroit.**

M. S. Smith, 2d, is attending to the wants of traveling men while the firm's regular buyer, Charles Morrison, is visiting the World's Fair.

Fire last week destroyed the business section of Manistique, Mich. Duncan C. Currie's jewelry store and stock were burned. Loss not yet known.

J. W. Tucker, a jeweler of Delray, Mich., was in Detroit last week. He intends shortly to sell his stock and engage in business at some point in Colorado.

A. Kaiser, jeweler, 59 Monroe Ave., reported to the police that some one stole a diamond pin worth \$75, one night last week from his store.

It is reported that Matt Delker and several other workingmen recently employed by the United States Optical Co., will start a factory and general repair shop at 5 E. Fort St.

John Finkberner's jewelry store at Hersey, Mich., was entered one night last week and goods to the amount of \$75 stolen. Thomas Dechere has been arrested for the burglary

while he was trying to dispose of some of the jewelry.

The Hercules Specialty Co. have been organized in this city. R. J. F. Roehm is trustee and a large stockholder. The capital stock is \$35,000, with \$23,000 paid in. The concern will manufacture all kinds of novelties in hard woods, silver, brass, etc.

A general picking up in trade is noticeable. Mails are decidedly more satisfactory. The following country jewelers were in the city last week: C. E. Montford, Utica, Mich.; A. T. Brown, Kingsville, Ont.; W. H. McEvoy, Amherstbury, Ont.; N. C. Potts, Forestville, Mich.; W. F. Hittig, Dundee, Mich.; William Gribben, Carsonville, Mich.; George Chambers, Mt. Clemens, Mich.; J. S. McGlaughlin, Wyandotte, Mich.; E. E. Parks, Essex Center, Ont.; Louis Winkelmann, Manistee, Mich., and E. V. Allison, Pontiac, Mich.

# Larter, Elcox & Co.

Manufacturers of Fine Gold Jewelry  
21 & 23 Maiden Lane, New York.



— WE ARE READY FOR THE FALL TRADE. —

## Rings, : Seals, : Spring : Back : Studs.

GENTLEMEN'S WHITE ONYX BUTTONS AND STUDS.

# WALTHAM REPEATERS

STRIKING HOURS AND MINUTES.

TO THE TRADE:—

Having purchased the entire remaining stock of WALTHAM REPEATING MOVEMENTS from the American Waltham Watch Co., and cased them in 20 year 14k. Cases, I am prepared to sell them at prices 30 per cent. less than they have ever been offered before.

Artistic Special Catalogue Free.

Send for Prices and Terms.

# JOHN B. YATES,

21 & 23 MAIDEN LANE, NEW YORK.

# BLANCARD & CO.,

LATEST ROCCO DESIGN IN GALLERY.



DIAMOND SETTINGS. GALLERIES. HOLLOW BALLS, ETC.

SEND FOR OUR CATALOGUE.

## 45 & 47 John St., New York.

**Wilmington, Del.**

Mr. Robinson, bookkeeper for S. H. Baynard, has returned from the World's Fair.

Millard F. Davis has been appointed watch inspector for the Philadelphia division of the B. & O. R. R. Co.

Harry E. Thomas, of Harry E. Thomas & Co., went to the World's Fair on the 20th to stay a month.

Chas. Banks, formerly with Millard F. Davis, of this city, but late with Simons, Bro. & Co., Philadelphia, will open a jewelry store on E. 7th St.

Edwin Hirst, the veteran watchmaker, served in a Delaware regiment during the Civil war. He lost the sight of his left eye, and has been a sufferer from rheumatism. Last July Mr. Hirst's pension was suspended pending a physical examination. He has just received his pension application marked "disallowed."

**Lancaster, Pa.**

Ernest Zahm spent several days in New York the past week.

Jobbers report trade to be improving and in some lines to be ahead of that of last year.

The Lancaster Silver Plating Co., whose plant was destroyed by fire some days ago, are arranging to secure temporary quarters for the resumption of business. The burned building will be restored as soon as possible.

An unusual large number of traveling men are visiting the trade hereabouts. Among those in the city the past week were: Mr. Jacobson, Jacobson Bros.; Mr. Woodland, Larter, Elcox & Co.; H. E. Bleecker, Bassett Jewelry Co.; J. L. Rounds, Rogers & Bro.; F. W. Sackett; C. M. Cassel, L. Black & Co.; Chas. L. Depollier, Dubois Watch Case Co.; J. N. Beckwith, Jos. H. Fink & Co.; F. W. Bliss, Unger Bros.; Joseph McPhail, Ed. Todd & Co.; Mr. Wood, Howard Sterling Co.; W. N. Walker, Hayden W. Wheeler & Co.; James Panton, Mabie, Todd & Bard.



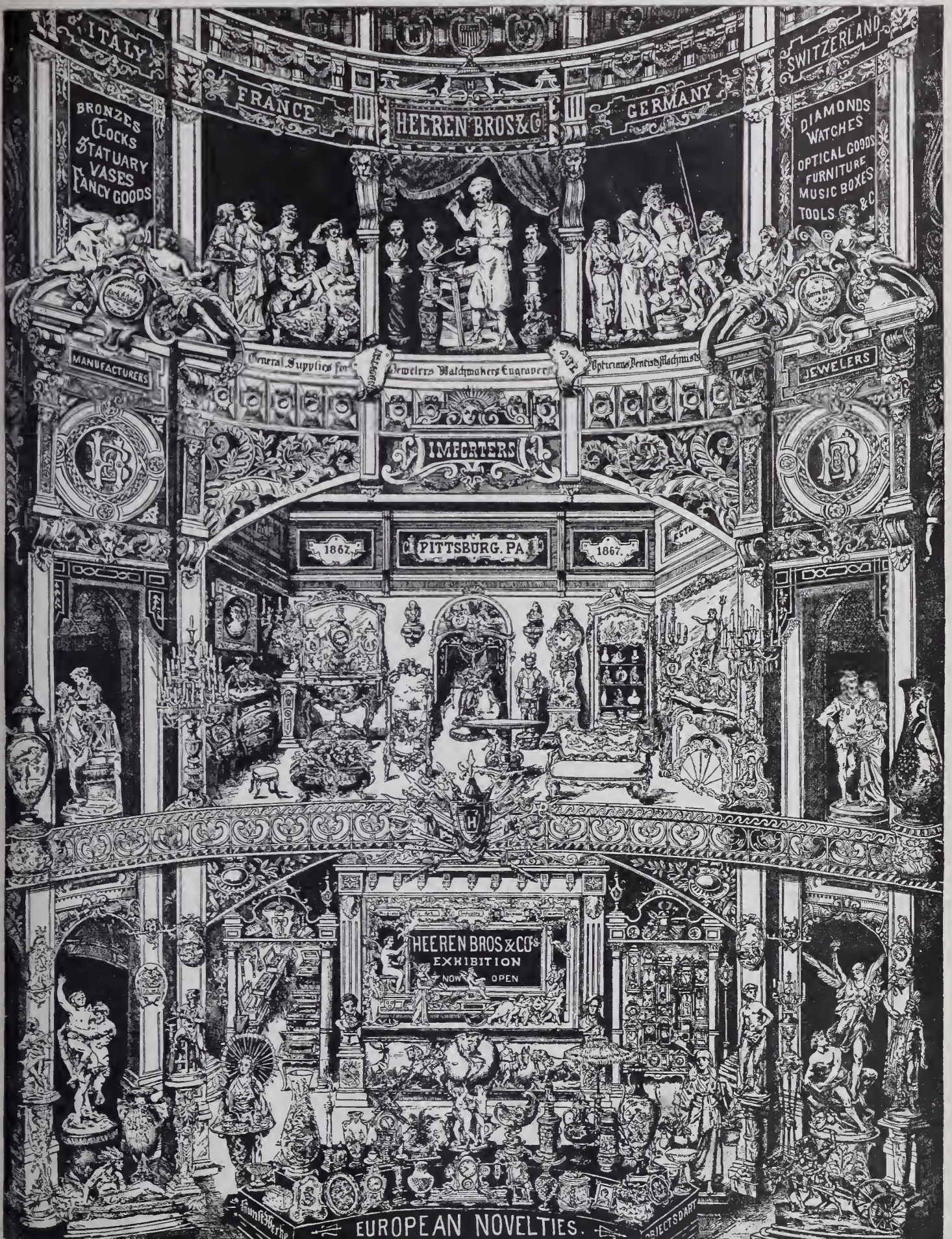

### News Gleanings.

M. Ansell, Chattanooga, Tenn., has been sued for \$74.

P. L. Clare, Verndale, Minn., has closed his store.

J. C. Horrie has opened his new store in Mazon, Ill.

W. D. Banner, Norfolk, Va., has sold out to B. N. Batchelder.

George Groffenberg will open a new store in Luverne, Minn.

Rudolph Taussig, Hammond, Ind., has made an assignment.

W. B. Cubberly, Harlan, Ia., has given a chattel mortgage for \$200.

Wm. Bellman, Harrisburg, Pa., is selling out his store to quit business.

Aime B. Bruneau, Fall River, Mass., has given a chattel mortgage for \$1,200.

Pulaski Wise, St. Charles, Ia., will soon be married to Miss Sylvia Williams.

A judgment for \$53 has been entered against A. E. Siviter, Wilkinsburgh, Pa.

Dr. Vineberg, optician, Troy, N. Y., will open a new store at 240 River St., Oct. 1.

A judgment for \$2,125 against Max Olenick, Minneapolis, Minn., has been entered.

Judgments aggregating \$125 have been entered against M. L. Freeman, Augusta, Ga.

Davis A. Hodge, jeweler, Auburn, Ind., was last week married to Miss Mabel Hartman.

R. H. McFadden, Mattoon, Ill., has given a chattel mortgage for \$300 on show cases, etc.

The Murray Jewelry Co., Dayton, O., have opened a branch store at 1018 W. 3d St.

H. Henry Weithoner, Nebraska City, Neb., has given a chattel mortgage for \$1,400.

C. Irving Burbank will open a jewelry store in Howard Blackburn's block, Gloucester, Mass.

A blaze occurred in the window of J. E. Thompson, Lowell, Mass., last week. The damage was slight.

Frank E. Sargent, Portland, Me., has given a mortgage on his stock and fixtures to Mrs. E. G. Sargent.

H. Silverthorn, Roanoke, Va., has sold out his business to Edward S. Green, a practical jeweler and optician.

The store of G. S. Catchadal, Superior, Neb., was a few days ago destroyed by fire. Nearly the entire stock was saved.

A. M. Greer, Iowa City, Ia., has gone to Chicago to attend the meeting of watch inspectors being held there this week.

J. E. Bazzley, Plano, Tex., has filed a chattel mortgage on his stock, naming R. L. Stevens trustee. The liabilities are \$500.

A. J. Wheaton, jeweler, North Cambridge Junction, Mass., was recently united in wedlock to Miss Alice M. Parker, of West Somerville.

The jewelry store of J. B. Lorge, Kiel, Wis., was entered by burglars last week, and robbed of all the jewelry and watches and \$40 in cash.

An attachment was placed a few days ago on the store of H. H. Wells, Holliston, Mass., by John F. Brown, of New York. The goods have been sold at auction.

The Keppler Jewelry Co., Anaconda, Mon., with a capital stock of \$25,000 has been incorporated by Jos. C. Keppler, Wm. M. Thornton and Geo. B. Winston.

H. L. Weymouth, of Howland, Me., has returned from Waltham, Mass., where he has been learning the watchmaker's trade and has opened a repairing department in the store of F. M. & H. L. Weymouth.

The marriage of Louis F. Bally to Miss Marie A. Stevens occurred at the residence of the bride's parents, in Towanda, Pa., last week. Mr. Bally is a member of the well-known jewelry firm of John Bally & Son, Elmira, N. Y.

The stock of Arthur McQuoid, Center ville, Ia., was a few days ago taken possession

of under a chattel mortgage, and the stock is now in the hands of an agent of the mortgagee. It will probably be sold out.

G. D. Nelson, Providence, R. I. has sold out to Roger Smith & Co.

Frank Bruce, the notorious jewelry robber and burglar, was last week tried in Terre Haute, Ind., and sentenced to the penitentiary for nine years.

Ernest H. Miller, 169 Central Ave., Albany, N. Y., drank a large quantity of laudanum last Tuesday. His wife notified the police, and the jeweler was taken to the hospital, where he was relieved of the poison by a stomach pump.

J. H. Knickerbocker and J. C. Leibel, of Aspen, Col., will start a jewelry factory in Salt Lake City, Utah. They propose to have a plant for the cutting and polishing of all kinds of stones, as well as for manufacturing jewelry.

J. E. Griffith, formerly of the Hartford Silver Plate Co., Hartford, Conn., in conjunction with other former employes of that concern, has organized a business at 28 High St., Hartford, under the name of the Hartford Plating Co.

Charles Veicht, jeweler, 404 Chestnut St., Milwaukee, Wis., has been arrested on the charge of leasing a dwelling house at 528 River St., for purposes of lewdness and prostitution. The case will be tried on the 27th. He has been released on \$400 bail. It is understood that the police will prefer two other charges against him on similar grounds.

### St. Louis.

Wild Brothers, 104 and 106 N. 6th St., have added a third story to their establishment.

Hess & Culbertson opened their new store at the northeast corner of 6th and Locust Sts. last Monday.

Freeman A. Durgin, of the Mermod & Jaccard Jewelry Co., who has been in charge of the firm's display at the World's Fair, has returned to resume his former position in the store.

William Walsh, of Merrick, Walsh & Phelps Jewelry Co., is mourning the death of a young relative, Wilson Shannon Walsh, who was killed by a crowd of drunken Mexicans near Trinidad, Col.

The traveling men in St. Louis, last week included: John Hayes, L. H. Keller & Co.; Tom B. Davis, Middletown Plate Co. H. A. Bliss, Kremetz & Co.; W. A. Copeland, Martin, Copeland & Co.; and I. Be dichimier.

Simon Ellman & Co., wholesale jobbers of dry goods, jewelry and notions, failed here a few weeks ago for about \$75,000. Their goods were sold at auction and only \$14,000 was realized. Since then the claims have been pouring in and from them it is quite evident that several jewelry firms among the unfortunate creditors. The Illinois Watch Co. are concerned for \$800.



ESTABLISHED 1801.

# HINRICHS & CO.,

29 & 31 PARK PLACE,

Cor. Church Street,

NEW YORK.

## Art Pottery and Bric-a-Brac,

CUT GLASS, FANCY GLASS, CHINA.

Large Assortment of

## Fine Dresden China Lamps, Glass and other Fancy Lamps.

THE LARGEST ASSORTMENT OF SPECIALTIES FOR THE JEWELRY TRADE, AT LOWEST PRICES.

CATALOGUE ON APPLICATION.



## Our Traveling Representatives

Traveling representatives may consider these columns open for the publication of any news or items of interest regarding themselves or their confreres.

**W. S. POND**, for E. G. Webster & Son, Brooklyn, N. Y., and G. A. Webster, Chicago, sent in satisfactory orders all the way from the north to New Orleans.

E. M. Landon started in the first of the month for The Weber Co., Chicago, and is doing well in Illinois, Iowa and southern Wisconsin.

H. M. Tenney is sending in nice comfortable orders to Lapp & Flerhem, from Indiana and Illinois.

C. W. Battey, traveler for Waite, Matherson & Co., was married to Miss Lydia A. Gill, in Providence, R. I., last week.

The traveling salesmen in Wilmington, Del., last week: were H. W. Brunjes, F. Kroeber Clock Co.; L. C. Reisner, Ezra F. Bowman & Co.; M. J. Sheridan; Mr. Stoddard, J. C. Buck & Co.; H. Sickles, of M. Sickles & Sons.

Swartchild & Co.'s travelers are all on the road. I. G. Adler is taking in south Wisconsin, Illinois, Michigan and Indiana. H. J. Linn goes to Wisconsin, north Iowa, north Michigan and Minnesota, and H. Schmidt calls on the trade in Iowa, Kansas, Nebraska and Missouri.

The following traveling men will visit Kansas City, Mo., this week: M. D. Fielding, A. Wittnauer; Arthur W. Warc, Wm. Demuth & Co.; Fred J. Foster, Unger Bros.; John Stanley, Meriden Silver Plate Co.; W. S. Dudley, Rogers, Smith & Co.; Henry H. Jacobson, Jacobson Bros.

The traveling fraternity was represented in Philadelphia last week by Ed. Eckfeldt, Wm. B. Kerr & Co.; Ralph Hamilton, Hamilton & Hamilton, Jr.; J. H. Williams, Armenia & Co.; Chas. Duffey, Enos Richardson & Co.; Joseph Fowler, Fowler Bros.; J. Rosenstock, J. Rosenstock & Co.

Travelers for The Weber Co. on the road are: R. A. Boyer, who is doing better than a year ago in Wisconsin and Minnesota; E. M. Landon, a new man who has done business with everyone so far approached; T. D. Brewster, who finds things quiet in Iowa; and E. J. Wells, who recently left for western Iowa and the Dakotas after a month's illness.

Frank Horton, Carter, Sloan & Co.; Thos. E. Rogers, Hayes Bros.; C. F. Livermore, Middletown Plate Co.; Sol H. Veit, Marx, Veit & Co.; Frank Hodgins, Rogers & Bro.; C. O. E. Hartung, Sussfeld, Lorsch & Co.; Mr. Bechet, Wm. B. Kerr & Co.; E. O. Baumgarten, Pairpoint Mfg. Co.; C. S. Hungerford, J. B. Bowden & Co., and W.

Royal Berth, Gorham Mfg. Co., were in Kansas City, Mo., last week.

Traveling men calling on Davenport, Ia., merchants recently were: F. R. Horton, Carter, Sloan & Co.; T. L. Carrow, Shafer & Douglas; S. W. Frohlichstein, Henry Froehlich & Co.; D. I. Byers, Cincinnati Gold & Silver Refining Co.; M. Roback, Otto Young & Co.; C. A. Garlick, C. H. Knights & Co.; M. Schmidt, Swartchild & Co.; A. L. Sercomb, Meriden Britannia Co.; C. E. Patterson, Towle Mfg. Co.

Traveling men in Indianapolis, Ind., last week were: L. G. Call, Simpson, Hall, Miller & Co.; H. C. Bliss, Bliss Bros.; Geo. Whiting, S. E. Fisher & Co.; J. G. Grafton, Wheaton, Richards & Co.; Henry Bodenheimer, Fink, Bodenheimer, & Co.; Mr. Dudley, Rogers, Smith & Co.; S. M. Peck, S. M. Peck & Co.; Mr. Plaut, National Jewelry Co.; David Gunzburger; and Mr. Rogers, Parks Bros. & Rogers.

Traveling men in Louisville, Ky., recently were: Fred Foster, Unger Bros.; Mr. Bechet, W. B. Kerr & Co.; Mr. Fink, Fink, Bodenheimer & Co.; Geo. Nelson Fenn, for C. Sydney Smith; Mr. Woods, Dominick & Hoff; Chas. F. Ketchum, Riker Bros.; Mr. Kaiser, Enos Richardson & Co.; A. Peabody, Peabody & Engelsman; C. B. Burgess, F. M. Whiting & Co.; Fred Leigh, for W. B. Durgin; Thos. E. Rogers, Hayes Bros.; J. D. Underwood, Champenois & Co.; C. S. Joralemon, A. Joralemon & Co.; Matthias Stratton, Jr., Jno. W. Reddall & Co.; Louis Lassner, Goodfriend Bros. & Lassner.

Among eastern travelers anxious to increase Chicago stocks were last week noted Harry Scofield, Lincoln, Bacon Co.; H. C. Bliss, Bliss Bros.; Richard Robinson, T. G. Frothingham & Co.; E. A. Bliss, E. A. Bliss Co.; representative of Mason & Robbins; A. Rosenthal, Koch, Dreyfus & Co.; John Hagan, W. H. Manchester & Co.; Mr. Kettlety, Marden & Kettlety; Geo. M. Geer, Tilden-Thurber Co.; Mr. Josephs, Albert Lorsch & Co.; Mr. Lawton, H. M. Quackenbush & Co.; Mr. Hall, Bristol Brass & Clock Co.; Joe Brill, Dattelbaum & Friedman; G. H. Cook; B. S. Freeman, B. S. Freeman & Co.

Travelers in Pittsburg, Pa., last week were: Will Miller, Seth Thomas Clock Co.; Mr. Engelsman, Peabody & Engelsman; E. I. Rogers, Parks Bros. & Rogers; F. V. Kennion, John T. Mauran; Mr. Sweet, Hayward & Sweet; Frank Sherry, Jos. Fahys & Co.; Cheever Hudson, H. F. Barrows & Co.; Fred Heffron, Riley, French & Heffron; Rube Thompson, H. Glorieux; C. S. Cooke, C. S. Cooke Co.; Mr. Kingman, G. A. Dean & Co.; L. S. Freedman, Bachrach & Freedman; W. F. Corey, Corey & Osmun, John Abel, Lewis, Kaiser & Luthy; Manasseh Levy; W. H. Bryant, T. G. Hawkes & Co.; Mr. Sideman, Ferd. Fuchs & Bros.; E. Todd, Jr., Edward Todd & Co.; E. H. Retzlau, James W. Miller; Mr. Tinker, Wm. B. Durgin; Arthur Totten, Rogers

& Bro.; H. R. Shirley, C. Dorflinger & Sons; and M. D. Rothschild.

The traveling men have begun to visit the trade of Detroit, Mich., in large numbers. Among them last week were: W. H. Allardyce, Ed. Todd & Co.; Mr. Merry, Julius King Optical Co.; W. H. Arnold, L. Black & Co.; William Elcox, Larter, Elcox & Co.; William Pierce, for G. Armeny; E. H. Retzlau, for James W. Miller; P. M. Woods, Dominick & Hoff; E. F. Badoux, Spencer Optical Mfg. Co.; Harry Osborne, Whiting Mfg. Co.; Mr. Brooks, Brooks & Pike; F. H. Carpenter, Alfred H. Smith & Co.; H. C. Barnum, Shafer & Douglas; Edward Kubie, Levy, Dreyfus & Co.; F. B. Tuck, Craighead & Wilcox; B. F. Reed; William V. Moore, Jules Laurentot & Co.; Mr. Tiffany, F. H. Sadler & Co.; Mr. Fay, Kirby, Mowry & Co.; W. F. McDonough, the Courvoisier-Wilcox Mfg. Co.; W. A. Elliott, Adelphi Silver Plate Co.; and Mr. Trewin, Keystone Watch Case Co.

Traveling men were numerous in Boston the past week. Among them were: E. W. Martin, Martin, Copeland & Co.; Henry G. Thresher, Waite, Thresher Co.; Fred H. Carpenter, Columbus Watch Co.; E. B. Bliss, Bliss Bros.; Mark Flanders, United States Watch Co.; E. L. Spencer, E. L. Spencer & Co.; Robert Hamilton, Hamilton & Hamilton, Jr.; Chas. E. Hancock, Hancock, Becker & Co.; Harry Barrows, H. F. Barrows & Co.; Mr. Crippen, Bates & Bacon; Thomas B. Wilcox, Pairpoint Mfg. Co.; Irving Smith, Crescent Watch Case Co.; Frank Sherry, Jos. Fahys & Co.; Mr. Ives, Wilcox Silver Plate Co.; Mr. Hutchison, Hutchison & Huestis; E. A. Woodmancy, Potter & Buffinton; John Lindsay, Keystone Watch Case Co.; F. S. Mills, Foster & Bailey; F. S. Hough, Jr.; H. W. Dunham; George B. Osborn, Wm. Smith & Co.; H. H. Curtis; S. O. Bigney, Marsh & Bigney.

The jewelry houses represented in Syracuse, N. Y., the past week were: William Kinscherf, by Jul. Schuman, Jr.; S. Cottle Co., Mr. Bride; W. G. Clark & Co., S. W. Granbery; Manhattan Silver Plate Co., C. E. Thomas; William S. Hick's Sons, E. W. Dellar; Acme Silver Plate Co., Geo. S. Melville; Fensterer & Ruhe, R. Meyer; W. E. Webster & Co., William H. Lee; Herzog, Goldsmith & Frank, M. Traub; American Watch Case Co., T. S. Richter; Max Freund & Co., Frank G. Moyer; S. Hutchins & Co., Frank W. Collom; E. S. Johnson & Co., Joseph M. Vose; Crescent Watch Case Co., M. Brinck; Jos. Fahys & Co., F. S. Sherry; G. A. Dean & Co., H. E. Kingman; Wade, Davis & Co., Charles Whiting; Essex Watch Case Co., Wm. MacDonald; W. R. Cobb & Co., W. R. Cobb; H. F. Barrows & Co., M. Hudson; S. Valfer & Co., S. Valfer; Fidelity Watch Case Co., M. Freeman; Strobel & Crane, Mr. Isabel; N. H. White & Co., Fred D. Steck; J. T. Scott & Co., Fred S. Eason; Julius King Optical Co., Edwin Beckwith; Hutchison & Huestis, Mr. Booth; King & Eisele, Mr. Parker.

# THE BEST PIVOT DRILLS IN THE WORLD.

One Gross without charge for proof that this is not so.

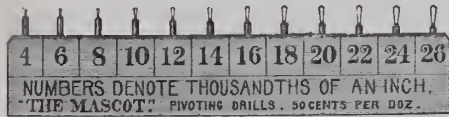

## The Mascot, 50 Cents per doz.

By all Jobbers, or sent post-paid on receipt of price.

**Ezra F. Bowman & Co.,**  
LANCASTER, PA.



Elk, Shrine and Masonic Emblems a Specialty.

Badges of Every Known Order.

G. A. SCHLECHTER,

Manufacturing Jeweler,

READING, PA.

## Waltham Horological School,

PALMER & SWAIN, Props.,

WALTHAM, MASS.

## Summary of Prospectus.

**LOCATION** in Martyn Square, in the city of Waltham, Mass. Pleasant location, hotels, boarding houses, churches, etc.

**CURRICULUM**:—Pupils are taught watch making, repairing and bench tool making complete. American and foreign systems. Special branches taught when desired.

**BRANCHES TAUGHT** include work on plates, barrels, wheels, pinions, jewels, balances, shafts, springs, screws, stem-winding parts, matching, gilding, finishing, adjusting, repairing, tool work, engraving, etc., etc. Also a thorough course in Ophthalmology by a professor of universal reputation and a course in gem cutting in detail.

**COURSE** may begin at any time and pupils are taught to make everything that enters into a watch movement. When the student has finished his course he is able to make and put together a watch complete in all its parts and properly adjusted; he is also a first-class repairer and gets such a thorough instruction in his trade as cannot be obtained in any workshop or any other school in the United States. The workshop of this School is fitted up with thousands of dollars' worth of the best watch tools and machinery, and with the capable instructors always ready to give their attention to the individual student, there being no class system, he has an advantage not to be obtained elsewhere. Materials for a watch movement will be given free to students who desire to make a watch of their own.

Send for full prospectus, terms for special branches, etc.

D. D. PALMER.

EUGENE H. SWAIN.

**SOLICITORS OF AMERICAN & FOREIGN PATENTS**  
FOR DESIGNS, TRADE MARKS & INFRINGEMENT PROSECUTED OR DEFENDED  
SEARCHES MADE & TRADE MARKS  
THE TRADE WILL SAVE TIME AND MONEY BY HAVING THEIR PATENTS TAKEN BY  
**COX & SONS 11 PARK ROW, N.Y.**

## The Latest Patents.

ISSUE OF SEPTEMBER 12, 1893.

**501,839. CHATELAINE.** AUGUSTA B. KNIGHT, Boston, Mass.—Filed Feb. 1, 1893. Serial No. 460,544. (No model.)

A chatelaine bow comprising a plurality of branches emanating from a knot or head and provided on their inner sides with pockets and means for suspending the bow from the person of the wearer.

**501,884. POCKET BOOK OR CASE.** HENRY MEYER, Philadelphia, Pa.—Filed Mar. 8, 1893. Serial No. 465,197. (No model.)

**505,000. EYE-TESTING DEVICE.** BENJAMIN I. PRICE, Denver, Col.—Filed Dec. 15, 1892. Serial No. 455,268. (No model.)

The combination with a frame having goggle shaped eye pieces, and having grooved seats at the lower side

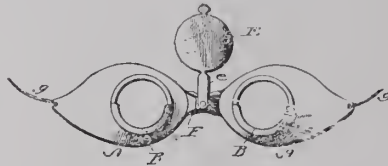

of the opening in said eye pieces of a disk pivoted to the nose piece or bridge of said frame and adapted to be turned to rest in and be held in place by the grooved seat in either of the eye pieces.

**505,052. STOP-WATCH.** HENRY A. LUGRIN, Brooklyn, assignor to Albert Wittnauer, New York, N. Y.—Filed April 11, 1893. Serial No. 469,366. (No model.)

In a stop watch, the combination, with a bridge and a post projecting from the same, of a hollow arbor surrounding said post, a timing wheel on one end of said

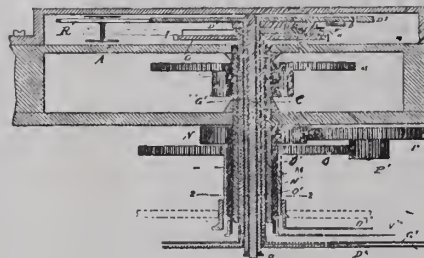

arbor, a hand on the other end of said arbor, a second hollow arbor surrounding the first hollow arbor, a split seconds hand wheel on one end of said second arbor and a split seconds hand on the other end of said second hollow arbor.

**505,062. ELECTRIC TIME RECORDER.** CHARLES E. ONGLEY, New York, N. Y., assignor, by direct and mesne assignments, to the Ongley Electric Company, same place.—Filed Jan. 24, 1891. Renewed Nov. 16, 1892. Serial No. 452,148. (No model.)

**DESIGN 22,776. PINCUSION.** FREDERICK RATCLIFF, New Bedford, Mass., assignor to the



Pairpoint Manufacturing Company, same place.—Filed June 21, 1893. Serial No. 478,416. Term of patent 7 years.

**DESIGN 22,777. BADGE.** GUSTAVUS A. SCHLECHTER, Reading, Pa.—Filed May 24, 1893. Serial No.



475,378. Term of patent 7 years.

**DESIGN 22,778. SPOON, & C.** FRANK A. DOWL-



ING, Cleveland, Ohio.—Filed June 28, 1893. Serial No. 479,101. Term of patent 3 1/4 years.

**DESIGN 22,779. HANDLE FOR SPOONS, & C.** ROWLAND RHODES, New York, N. Y., assignor

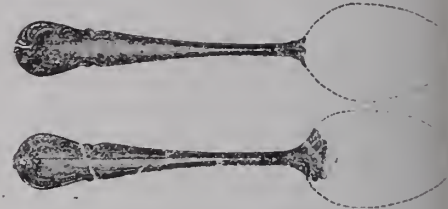

to William H. Durgire, Concord, N. H.—Filed July 8, 1893. Serial No. 479,957. Term of patent 7 years.

**DESIGN 22,780. PLATE.** ALFRED HACHE, Vierzion, France.—Filed Aug. 21, 1893. Serial No. 483,683. Term of patent 7 years.

**DESIGN 22,781. CONDIMENT-HOLDER.** ALBERT STEFFIN, New Bedford, Mass., assignor



to the Mount Washington Glass Company, same place.—Filed Mar. 31, 1891. Serial No. 468,617. Term of patent 7 years.

**DESIGN 22,783. CLOCK-CASE.** JOHN H. ZEILIN

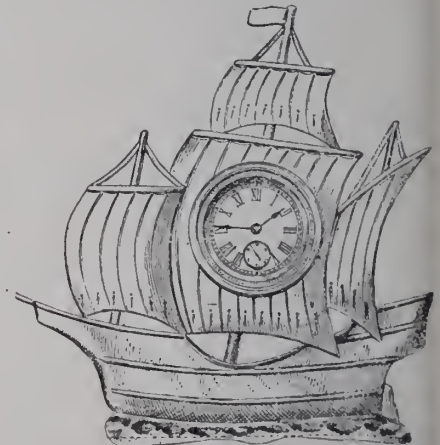

Philadelphia, Pa.—Filed Apr. 14, 1893. Serial No. 470,383. Term of patent 3 1/4 years.

## Canada and the Provinces.

Isaac Benjamin, Toronto, Ont., has assigned to John W. Lawrence.

The store of W. H. Stephenson, Kamloops B. C., was burnt out last week; no insurance.

The American Watch Case Co., Toronto, Ont., have brought suit for \$5,000 against William F. Doll, Winnipeg, on a charge of libel and slander.

W. W. Didier, Three Rivers, Que., who assigned recently, was arrested on a capias at the instance of Simpson, Hall, Miller & Co., that firm having good reasons to believe that he was about to skip. The defendant was released on giving bonds for \$3,000. Mr. Whinby, manager of Simpson Hall, Miller & Co., and Alfred Eaves, were appointed inspectors to the estate.

**A Swindler Gets Goods "On Memorandum" and then Skips.**

A number of New York diamond merchants and incidently, the police authorities, are anxious to find a young man calling himself Simon Jacobs who, something over two weeks ago, secured a large amount of diamonds on memorandum, and then skipped. He had at one time been in the employ of a Maiden Lane firm, and knew of people to whom he could refer.

He represented himself to Schultz & Ruloph, of 24 John St., as an agent of the Equitable Life Assurance Society, and on the pretense that his brother-in-law wanted

to buy rings and earrings, obtained two rings and a loose diamond worth in all about \$800. Ludeke & Power, 23 John St., were in a like manner mulcted of \$200 worth of goods, and Stern Bros. & Co., 30 Maiden Lane, let him have two rings worth about \$200 which were never returned.

**She Was Not so Tricky as She Thought She Was.**

JERSEY CITY, N. J., Sept. 21.—The substitution game was unsuccessfully tried yesterday by a colored woman who went into Adolph Walter's jewelry store, 52 Newark

Ave., and asked to be shown some rings.

She examined several trays of rings but apparently none suited her, for she started to go without purchasing. Before she had left the store, however, it was discovered that one of the diamond rings had been removed from a tray and an imitation diamond ring put in its place. The woman was accused of the trick and in spite of her denial, was arrested.

At the station house she gave her name as Charlotte Henry, and said she lived at 35 W. 33d St., New York. The missing ring was found upon her and she was locked up upon a charge of grand larceny.

# THE "FLORALIA"

STERLING 925-1000 FINE.

THE SENTIMENT OF FLOWERS DAINILY EXPRESSED IN ARTISTIC SILVER FORMS.

Charmingly adapted for Wedding, Birthday and Friendship Gifts.

**MARGUERITE.**  
INNOCENCE.



Of all the flowers in the meadow I love the Daisie, white and red.—Chaucer.

**CLOVER.**  
INDUSTRY.



Clover, sweet Clover, All the world over.—Old Rhyme.

**FORGET-ME-NOT.**  
REMEMBRANCE.



"Souviens de moi" (Remember me.) The motto of King Henry IV

**PANSY.**  
THOUGHT.



And there is Pansies, That's for thought.—Shakespeare.

**LILY.**  
PURITY.



Have you seen but a bright Lily grow?—Longfellow.

**ROSE.**  
BEAUTY.

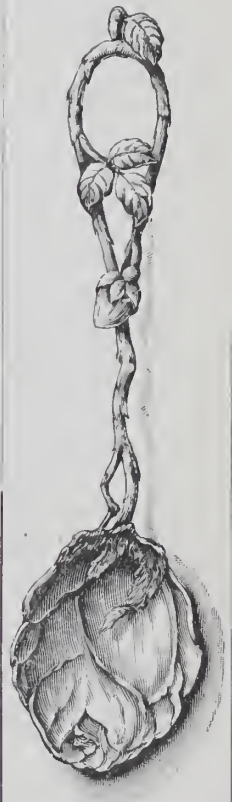

Flowers of all hue and with out thorn, the Rose.—Milton.

Price \$4.00 a Set of Six Coffee Spoons, Oxidized or Bright.



**Alvin Manufacturing Co., Silversmiths,**  
860 BROADWAY, NEW YORK.

Works: IRVINGTON, N. J.

# CLASSIFIED INDEX TO ADVERTISEMENTS.

All Advertisements are entitled to one insertion under proper heading. Extra insertions, \$6.00 per annum.  
Extra Headings, \$12.00 per annum.

	Page.		Page.		Page.
<b>Art Pottery, Bric-a-brac, Etc.</b>		<b>Gold Jewelry.</b>		<b>Sample Trunks.</b>	
Ahrenfeldt & Son, 56 Murray St., N. Y.....	46	Bippart & Co., Newark, N. J.....	7	Crouch & Fitzgerald, 161 Broadway, N. Y....	42
Bing, Ferdinand & Co., 106 Grand St., N. Y..	44	Carter, Sloan & Co., 15 Maiden Lane, N. Y..	41	<b>Settings and Galleries.</b>	
Borgfeldt, Geo. & Co., 18, 20 & 22 Washington Place, New York.....	48-49	Hook, G. W., Chicago, Ill.....	24	Blancard & Co., 76 John St., N. Y.....	32
Bradley & Hubbard Mfg. Co., Meriden, Conn	8	Kerr, Wm. B. & Co., 860 Broadway, N. Y....	14	<b>Silver Mounted Ebony Goods.</b>	
Buning, F. W. & Co., 58 Murray St., N. Y....	50	Kremetz & Co., 182 Broadway, N. Y.....	8	Deutsch Bros., 7 E. 17th St., N. Y.....	3
Gleanzer Leon, J. & Co., 80 & 82 Chambers St., N.Y. ....	47	Larter, Elcox & Co., 21 & 23 Maiden Lane, N. Y.....	32	<b>Silver Plated Ware.</b>	
Haviland & Abbott, 26 Barclay St., N. Y.....	50	Racine Jewelry Mfg. Co., Racine, Wis.....	28	Homan & Co., Cincinnati, O.....	21
Hinrichs & Co., 29 & 31 Park Place, N. Y....	34	Smith, C. Sydney, 191 Broadway, N. Y.....	10	Pairpoint Mfg. Co., New Bedford, Mass.....	5
Le Boutilier & Co., 860 Broadway, N. Y.....	19	Street, Geo. O. & Sons, 15 John St., N. Y....	50	Rogers & Bro., 16 Courtlandt St., N. Y.....	20
Levy, Dreyfus & Co., 9 & 11 Maiden Lane, N.Y	51	Uhry, Chas. L. & Co., Newark, N. J.....	5	Rogers, Smith & Co., Meriden, Conn...	51
<b>Auctioneers.</b>		<b>Horological Schools.</b>		<b>Silversmith.</b>	
Comrie, A. J., P. O. Box 2403, New York.....	9	Parson's School for Watchmakers, Peoria, Ill.	26	Rohrbach, Henry J., 94-96 State St., Chicago,	28
Firuski, S. & Son, 85 Bowery, N. Y.....	39	Palmer & Swain, Waltham, Mass.....	36	<b>Show Cases.</b>	
<b>Assayers &amp; Refiners.</b>		<b>Hotels.</b>		Smith, B. & W. B., 220 W. 29th St., N. Y....	52
Clark, J. L., Philadelphia, Pa.....	50	Gibson House, Cincinnati, O.....	24	<b>Souvenir Spoons.</b>	
Howard, S. P., 8 John St., N. Y.....	52	<b>Imported Clocks, Bronzes, Etc.</b>		Alvin Mfg. Co., 860 Broadway, N. Y.....	37
<b>Badges, Medals, Etc.</b>		Jacques, Chas., Clock Co., 22 Cortlandt St., N.Y.	52	<b>Sterling Silverware.</b>	
Irons & Russell, Providence, R. I.....	24	<b>Jewelry Mailing Boxes.</b>		Campbell-Metcalf Silver Co., Providence, R. I.	40
Schlechter, G. A., Reading, Pa.....	36	Am. Railway Supply Co., 24 Park Place, N. Y.	4	Dominick & Haff, 860 Broadway, N. Y.....	11
Stockwell, E. R., 19 John St., N. Y.....	4	<b>Jewelry, Silverware and Optical Cases.</b>		Durgin, W. B., Concord, N. H.....	18
<b>Chains, Seamless.</b>		Birmingham, Wm. & Co., 728 Arch St., Phila.	91	Knowles, J. B. & S. M. Co., Silversmiths'	
Kent & Stanley Co., Providence, R. I.....	4	Borzinner, S. & A., 82 & 84 Nassau St., N.Y.	31	Hall, Union Square, N. Y.....	7
<b>Diamond Cutters.</b>		Jackson, S. C., 180 Broadway.....	9	Ovatt & Warner, Portland, Oregon.....	28
Humphrey, J. B., Boston, Mass.....	52	Troesch, A. & Co., 69 Nassau St., N. Y.....	40	Reed & Barton, 37 Union Sq., N. Y.....	28
<b>Diamond &amp; Precious Stone Importers.</b>		Wiggers & Froelick, 60 Nassau St., N. Y.....	40	Shiebler, Geo. W., Co., 179 Broadway, N. Y....	43
Disselkoen, John N., 19 E. 16th St., N. Y....	41	<b>Jobbers, Watches, Diamonds, Etc.</b>		Towle Mfg. Co., Newburyport, Mass.....	43
Falkenau, Oppenheimer & Co., 40 Maiden Lane, N. Y.....	52	Aikin-Lambert Jewelry Co., 19 Maiden Lane..	10	Wallace, R. & Sons Mfg. Co., 3 Park Place, N. Y.....	6
Hahn, Rud. C., 194 Broadway, N. Y.....	30	Bonnet, Albert H., Columbus, O.....	28	Wood & Hughes, 10 John St., N. Y.....	40
Hedges, Wm. S. & Co., 170 Broadway, N. Y....	40	Bowman, Ezra F. & Co., Lancaster, Pa.....	36	<b>Stem Winding Attachments.</b>	
Juergens & Andersen Co., Chicago, Ill.....	26	Cross & Beguelin, 17 Maiden Lane, N. Y....	30	Abbott, Henry, 2 Maiden Lane, N. Y.....	39
Kahn, L. & M. & Co., 10 Maiden Lane, N. Y.	52	Giles Bros. & Co., W. H. Gleason, receiver, Chicago, Ill.....	27	<b>Tool Manufacturers and Dealers.</b>	
Kipling, R. A., Hays Bldg., N. Y.....	40	Heeren Bros. & Co., Pittsburgh, Pa.....	33	Bullock, O. W., Springfield, Mass.....	7
Ludeke & Power, 23 John St., N. Y.....	40	Myers, S. F. & Co., 48 Maiden Lane, N. Y....	52	Gesswein, F. W., 39 John St., N. Y.....	10
Nissen, Ludwig & Co., 18 John St., N. Y....	40	Yates, John B., Hays Building, Maiden Lane, N. Y.....	32	Horological Tool Co., Chicago, Ill.....	28
Randel, Baremore & Billings, 29 Maiden Lane,	41	<b>Leather and Silver Goods.</b>		Logan, A. J., Waltham, Mass.....	50
Scott, J. T. & Co., 4 Maiden Lane, N. Y.....	17	Deutsch Bros., 7 E. 17th St., N. Y.....	2	Mosely & Co., Elgin, Ill.....	26
Smith, Alfred H. & Co., 182 Broadway, N. Y.	40	<b>Musical Boxes.</b>		<b>Tortoise Shell Goods.</b>	
Wolff & Gunzburger, 87 Nassau St. N. Y.....	52	Jacot & Son, 298 Broadway, N. Y.....	7	Rice & Hochster, 483 & 485 Broadway, N. Y..	9
<b>Diamond Jewelry.</b>		Wolff, A., 194 Broadway, N. Y.....	9	<b>Trunks and Traveling Bags.</b>	
Waterman & Lehman, 37 Maiden Lane, N. Y.	30	<b>Optical Goods.</b>		Crouch & Fitzgerald, 161 Broadway, N. Y....	42
<b>Eye Glass Holders and Chains.</b>		Geneva Optical Co., Chicago, Ill.....	22	<b>Watch Case Manufacturers.</b>	
Merritt, S. F., Springfield, Mass.....	12	Kirstein, E., Sons Co., Rochester, N. Y.....	12	Goll, Henry, 17 John St., N. Y.....	30
<b>Fine Stationery.</b>		Laurencot, Jules, 49 Maiden Lane, N. Y....	50	The Planchamp & Becker Co., Chicago, Ill...	26
Parsons, Green & Co., 18 Murray St., N. Y....	5	Queen & Co., Philadelphia, Pa.....	4	The Wadsworth Watch Case Co., Newport, Ky.....	29
<b>Fountain Pens.</b>		The Nous Verrons Co., Boston, Mass.....	10	<b>Watchman's Clocks.</b>	
The Boston Pen Co., Boston, Mass.....	12	Winsted Optical Co., Winsted, Ct.....	12	Hausburg, O. E., 41 Maiden Lane, N. Y.....	39
<b>Cleaning Solution.</b>		<b>Pens, Pencil Cases, Etc.</b>		<b>Watch Importers.</b>	
Quarters, W. F., Providence, R. I.....	10	Aikin, Lambert & Co., 19 Maiden Lane, N. Y.	4	Hyde's, J. E., Sons., 22 Maiden Lane, N. Y..	12
<b>Gold and Silver Plating.</b>		Beaume, D. W., 17 John St., N. Y.....	30	Mathey Bros. & Mathez Co., 21 & 23 Maiden Lane, N. Y.....	12
Brunor Plating and Jewelry Repairing Co....		<b>Patents.</b>		Wittnauer, A., 19 Maiden Lane, N. Y.....	31
Maiden Lane, N. Y.....	5	Cox & Sons, 11 Park Row, N. Y.....	36	<b>Watch Keys.</b>	
H. B., Bolstad, Plating Co., Chicago Ill.....	39	<b>Ring Makers.</b>		Clark, A. N., Plainville, Conn.....	42
		Bryant, M. B. & Co., 10 Maiden Lane, N. Y..	52	<b>Watch Manufacturers.</b>	
		Bowden, J. B. & Co., 192 Broadway, N. Y....	7	Baume & Co., London, England, and Syracuse, N. Y.....	21
		Hildreth Mfg. Co., 51 Maiden Lane, N. Y....	8		
		<b>Rolled Plate Jewelry.</b>			
		Dederick, J. H., 16 Maiden Lane, N. Y.....	50		

## Special Notices.

Rates 75c. per insertion for notices not exceeding 3 lines (25 words), additional words 2 cents each. If answers are to be forwarded, postage stamps must be enclosed. Two insertions, 15 per cent. off; three insertions, 20 per cent. off; four insertions or more, 25 per cent. off. Payable strictly in advance. Display cards on this page will be charged at \$2.00 per inch for first insertion, subject to same discount as above for subsequent insertions.

Under the heading of **Situations Wanted** on this page advertisements will be inserted for One Cent a Word. This offer refers to **Situations Wanted only**. Payable strictly in advance. If answers are to be forwarded, postage must be enclosed.

## Situations Wanted.

Notices under this heading **ONLY** are charged at one cent a word, payable strictly in advance. If answer are to be forwarded, postage must be enclosed.

**POSITION** as salesman, retail jewelry or silverware. Experienced. References. Address, "F," care, JEWELERS' CIRCULAR.

**TO JEWELRY NOVELTY MANUFACTURERS.**—Young man, who has traveled with a line of fancy metal articles, is open for an engagement. Would like to cover New England, and nearby States for a jewelry or fancy goods house. Highest references. Address B. E. C., care JEWELERS' CIRCULAR.

**SITUATION** wanted as watchmaker, clock and jewelry repairer, by a single man, twenty-seven years of age. Address Ed. S., Dresden, Ohio.

**BOOKKEEPER.**—Young man (25), experienced double entry and general office man, one acquainted in jewelry trade, desires position. A I reference. E., care JEWELERS' CIRCULAR.

**WANTED.** A POSITION in a diamond, jewelry or fancy goods house. Have a thorough knowledge of the goods and a fair trade acquaintance. Satisfactory references. Address D. J. F., care of JEWELERS' CIRCULAR.

**A FIRST-CLASS** watchmaker wants position as good salesman. Has full set of tools. Address Waltham, care JEWELERS' CIRCULAR.

**A YOUNG** experienced traveling jewelry salesman open for engagement. Highest references. Illustrator, care of JEWELERS' CIRCULAR.

**WANTED.**—A position as jeweler and diamond setter; 15 years' experience; best of references. Address L. W., care JEWELERS' CIRCULAR.

**WANTED.**—Position by competent lady stenographer and typewriter; has her own machine; will assist on books or office work. Address S. M. W., care JEWELERS' CIRCULAR.

**POSITION WANTED.**—By young Swede, as watchmaker and clock repairer; three years' experience; speaks English; own tools; best references. Address D. C., JEWELERS' CIRCULAR.

**BY YOUNG MAN.**—Single, 6 years' experience at bench; own tools; no bad habits; best of references; south preferred. Address W. R. Heartsfield, High Point, N. C.

**SITUATION WANTED.**—By a thoroughly competent watch repairer who has had a great deal of experience on fine work, and is also competent on fine clocks and jewelry repairing. Address E. 70, care of JEWELERS' CIRCULAR.

**FIRST-CLASS WATCHMAKER** and engraver; ten years' experience; graduate of the Jewelers' School for Letter and Monogram Engravers; single; good salesman. R. H. Hitchcock, Muskegon, Mich.

**SITUATION WANTED.**—By Electro plater on all kinds of jewelry work, coloring and oxidizing. Have had charge of factory for 15 years. Address Plater, 61 West 124th St., New York.

**POSITION WANTED** in wholesale jewelry house by a young lady thoroughly adapted for any inside position. Can furnish highest references. Address G. R. A., care JEWELERS' CIRCULAR.

**A JOB BY WATCHMAKER** or assistant by Nov. 15th or Dec. 1st. Do jewelry work and some little script engraving; also fair salesman; married. Address W. F. S., Marietta, Ga., care of J. H. Bate & Co.

**WANTED.**—Situation as watchmaker; good workman; have my own tools; first-class references; Massachusetts, Connecticut or eastern New York preferred. Address B. S., care JEWELERS' CIRCULAR.

**WANTED BY A YOUNG MAN** 23 years of age, situation as watchmaker and plain engraver; also salesman and good all round man for store; can give good references; ready to go to work November 6th. Address F., care R. O. Kandler, 1312 Columbus Memorial Building, Chicago, Ill.

**ENGRAVER AND SALESMAN.**—First-class man with A1 references desires a situation in a large jewelry store. Good all round workman. New York or Brooklyn, Middle or Eastern States preferred. Address Mizpah, care JEWELERS' CIRCULAR.

**DESIGNER IN JEWELRY** and first-class mechanic, with a thorough knowledge of the trade, acid coloring, etc., desires a position as foreman or some position where his abilities would be recognized. Address Designer, 27 1/2 Lombardy Street, Newark, N. J.

**SITUATION WANTED** by a first-class jeweler, with fourteen years' experience. Had own business. Can do acid color and battery gilding, also do repairing, &c. Can turn hand to everything. "Greek," JEWELERS' CIRCULAR.

## Help Wanted.

**WANTED.**—A first-class jewelry jobber, up on hard soldering, and who can set single stones. Good salary. Permanent situation. Address with particulars and references, Thens Brothers, Savannah, Ga.

**WANTED, MECHANICAL SUPERINTENDENT**—a man possessing experience and ability—to take mechanical and business management of well equipped factory for the manufacture of small, well finished articles in optical and scientific instruments, &c. One who could invest some capital preferred, as the present owners have other business and wish a responsible manager. A. L. Smith, 69 Washington St., Chicago.

**WANTED.**—Experienced watchmaker and engraver. Must be single and temperate. A good all around man. Salary \$12 a week and board. Address Otto Salzmann, 309 Main St., Danville, Va.

**WANTED.**—A first-class watchmaker for railroad watch work; must be thoroughly competent; one who can engrave and repair jewelry, and is a good salesman, preferred; a permanent job; state age; send sample of engraving and reference; salary \$20 per week. Address F. A. Boerner, Fort Worth, Texas.

**WE WANT** one or two good watchmakers; none but first class mechanics need apply; best of wages paid. Address Julius C. Walk & Son, Indianapolis, Ind.

## For Sale.

**FOR SALE.**—On account of death of owner, Hopkin's Lathe, with all attachments; Universal Lathe, Pivoting Lathe, and a complete watchmaker's outfit at less than one-third of original cost. Address Mrs. J. R. Abbott, care F. C. Gleason, 133 E. 125th St., N. Y. City.

**FOR SALE.**—\$500 for \$300 cash. Jewelry, News Depot and furnished rooms for two. Rent \$8. Store pays profit; bench work for one. Address Cyrus Condit, 2344 Bellevue Avenue, Kansas City, Mo.

**FOR SALE.**—A spectacle and thimble plant long established. Good set of machinery and tools, with power, all in fair condition. Price \$3,000, with liberal discount for cash. Continued ill health the reason for selling. For particulars inquire of Gustave Walters, 33 Maiden Lane, New York.

**FOR SALE.**—Well established jewelry and optical business; in a Virginia city of about 30,000 population; best location in city; rent \$500 per annum; store 15 feet wide and 40 feet deep; in good condition. Nice clean stock, no old or undesirable goods; stock inventory about \$4,500; fixtures, materials, tools, sale, etc., about \$1,500; fine Hall's fire and burglar proof safe; Webster Whitcomb lathe and all tools in good shape; best business city in the south; sales in 1892, over \$8,000 and profits over \$3,000; business could be easily doubled by an energetic wide awake man; am compelled to change business on account of failing health. Address at once Jeweler and Optician, care of JEWELERS' CIRCULAR.

## Miscellaneous.

### DEMAGNETIZING.

**PERFECT WORK.**—Watch repairing in all its branches; all work warranted. Winslow & Penney, 608 Masonic Temple, Chicago.

**I BUY JEWELRY STOCKS.**—Manufacturers, jobbers and retailers desiring to dispose of surplus or entire stocks of diamonds, watches and jewelry can find quick cash buyer by addressing Stephen S. Harmon, 134 East 96th St., New York city.

**FOUND.**—On our showcase, in June a paper of mounted diamond jewelry, supposed to have been left by some traveling salesman; has been advertised in Boston Herald; owner will please call, prove property, pay expenses and take the goods. M. S. Page & Co., No. 1 Salem Street, Boston, Mass.

**WANTED.**—A set of jewelers geared ring rolls. Must be in good order and cheap. Address M. Parse & Co., Pine Bluff, Ark.

**WANTED PARTNER.**—With brains, money, hustle and integrity, to enlarge an established rapidly growing western wholesale jewelry business. The best of references given and required. Address O. B. Edmund, care of JEWELERS' CIRCULAR.

**Headquarters**  
FOR  
ELECTRIC & PORTABLE  
Watchman's Clocks

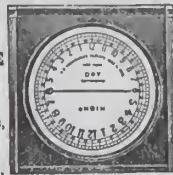

Price, Complete  
\$10.00

Lowest Prices.  
Latest Improvements,  
Patents 1886-1893.  
Send for Circular.

E. O. HAUSBURG,

41 Maiden Lane, New York. THE "ALERT."

## PAWNBROKERS' SALES

BY

**S. FIRUSKI & SON,**

AUCTIONEERS,

85 Bowery, New York,

AT 11 A. M.

See N. Y. Herald for full particulars of Sales.

The Trade is Respectfully Solicited to Attend.

H. B. BOLSTAD.

J. H. NIGHTINGALE.

WATCH CASE MAKERS AND REPAIRERS.

**H. B. Bolstad Plating Co.**

GOLD AND SILVER PLATING.

DESIGNING AND ENGRAVING.

170 Madison Street, - - CHICAGO.

## HENRY ABBOTT,

MANUFACTURER OF

Stem-Winding Attachments

FOR WATCHES,

No. 2 Maiden Lane, NEW YORK.

To insure Publication of Advertisement in current week, copy should be received not later than Monday Night.

## OLDEST PUBLICATION

Of all the Jewelry Journals.

Jewelers' Circular Publishing Co.,

189 BROADWAY, NEW YORK.

ESTABLISHED 23 YEARS.

**DIAMONDS.**

**Wm. S. Hedges & Co.,**  
**Importers of Diamonds,**

And Manufacturers of **DIAMOND JEWELRY.**  
**170 Broadway, New York.**  
 27 Holdorn Viaduct, London.

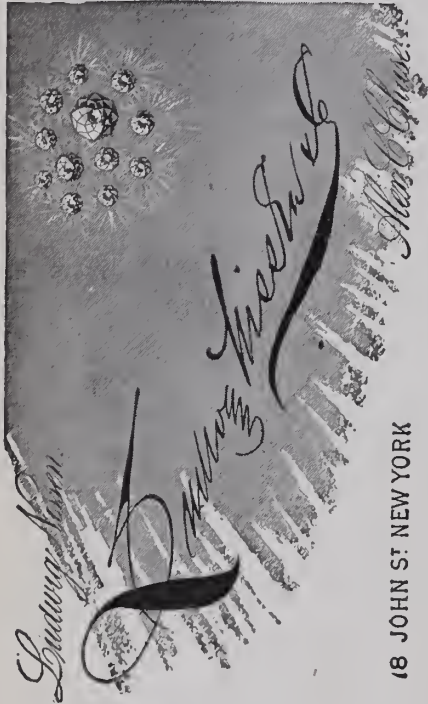

**R. A. KIPLING,**  
 Importer of

**PRECIOUS STONES,**

**21 & 23 Maiden Lane,**

**19, RUE DROUOT, New York.**  
**PARIS.**

**Alfred H. Smith & Co.,**

**IMPORTERS**

**DIAMONDS**

AND

**PRECIOUS STONES,**

**182 BROADWAY, COR. JOHN STREET,**  
**NEW YORK.**

**33 Holborn Viaduct, London, E. C.**

**CAMPBELL-METCALF SILVER CO.**



176 Broadway, N. Y., Room 14. 66 Stewart St., Prov., R. I.  
 Mills Bldg., San Francisco, 8th Floor, Room 1.



Patent applied for

Victoria Novelties, many fancy shapes.  
 Celluloid Top, Sides, Bottom and Cushions  
**A. TROESCHER & CO., 69 Nassau St., N. Y.**

**Trade Gossip.**

Jonas, Dorst & Co., Cincinnati, O., are turning out unusually pretty designs in white stone goods for the Fall trade.

Shipments of old gold are pouring in to Goldsmith Bros., assayers and refiners at 63-65 Washington St., Chicago, in reply to their offer to forward a check immediately upon receipt of the shipment. The firm will also give you the money for your old gold as soon as you pass it over the counter. It is an easy way for all jewelers to pay their expenses to the World's Fair.

So greatly has the business of the Spencer Optical Mfg. Co., 15 Maiden Lane, New York, extended, that they have found it necessary to increase the working force in the mechanical departments, in order to handle the large amount of special prescription work sent in by opticians many of whom are graduates of the optical institute connected with this house.

The bicycle and dashboard watch introduced by A. Wittnauer, 19 Maiden Lane New York, is a practical and reliable novelty which deserves the success it is attaining. It is an improvement which will be appreciated by every wheelman and driver, filling as it does a long felt want, and cannot fail to be a profitable line for the retailer to handle. The movement is one of the best manufactured by the Longines Watch Co., and the watch is tightly set in a leather case which thoroughly protects it. The perfect workmanship which it shows, and its neatness, compactness, strength and durability, speak eloquently for it.

Yacht races being the all absorbing tope at present, yacht club signal pins made by Henry C. Haskell, Corbin Building, New York, have become particularly appropriate articles of decoration as the sales of them will no doubt prove. The principal pin, of course, is now that representing the flag of the New York Yacht Club, which is triangular in shape and contains a red cross on a blue background, a single white star appearing in the center of the cross. This is the official pin of the club and is made in 14 karat gold with the colors in enamel. The workmanship is perfect and is in keeping with that in the novelties previously turned out by Mr. Haskell.

A new feature which will be inaugurated this Fall by the Waltham Horological School is an advanced or finishing course of three months for business men who cannot spare more time, and for those already grounded in horological work. Optics, by the professor of ophthalmology of Tufts College, Boston, will also be a feature appreciated by students. A new instructor in the person of Chas. H. Taylor, and the popular W. D. Clement, guarantee capable and competent tuition. Each year sees the Palmer & Swain school more firmly established. A repair department will shortly be opened, for which all sorts of watch repair work will be solicited.

**LUDEKE & POWER,**

**IMPORTERS OF DIAMONDS**

AND OTHER PRECIOUS STONES,

ADOLPH LUDEKE,  
 CHAS. L. POWER.

**23 JOHN STREET, N. Y.**

**WOOD & HUGHES.**  
**STERLING SILVERWARE MANUFACTURERS**

New York Agents for the Derby Silver Co.'s  
**FINE QUADRUPLE PLATED WARE,**  
**NO. 16 JOHN STREET, NEW YORK**  
 206 Kearney St., San Francisco, Cal.  
**HASKELL & MUEGGE, Agents.**

**WIGGERS & FROELICK,**  
**60 NASSAU ST., NEW YORK.**

**Sample Cases and Trays**  
**For Watches, Jewelry, Optical Goods, Etc.**

**WE STRIVE TO MAKE THE BEST.**



**Paris Jewelers in New Fields.**

CHARLES RIVAUD'S SUCCESSES IN ELECTROTYPING WITH GOLD.—SILVER STATUETTES DECORATED WITH ENAMEL.—THE TENDENCY TO ASSOCIATE SILVER WITH SEMI-PRECIOUS SUBSTANCES MORE DECIDED.

PARIS, France, Sept. 15.—A very skilful electrotyper, Charles Rivaud, has succeeded after numerous attempts in making exact reproductions with gold of some of the most delicate works of art. By his process electrotyping with gold is as perfect as it is with silver or brass. The specimens which Rivaud showed recently at the *Société d'Encouragement de la Bijouterie* are so perfect that they do not differ whatsoever from the models they reproduce. He has obtained copies in gold of bracelets and brooches modeled by Roty and of other small articles chased by Ledouble.

Success may be attained only under the following conditions: The reproduction must be faithful without requiring any touching up; the metal must be malleable, but not granulated; it must be compact in proportion with its thickness; must be solid enough to undergo firm soldering; it should contain neither inflated swellings nor flaws of any description; it must allow of the *ragréure* of assembled parts being done with chasing and it must be supple enough to permit of bending when it is necessary to assemble certain parts.

Rivaud has obtained another result, namely; he has electrotyped plaques with gold, which he easily managed to cover with enamel. This has never been done with brass or silver.

The artistic effect of a statuette of oxidized silver is greatly enhanced by the addition of *accessoires* in enamel. The pretty little boy in silver, that stands on a pedestal in Boucheron's hall with his left knee resting on the stump of a tree, looks up wonderingly at a big shell of translucent enamel with gold lines winding around it, which he holds up at arms' length in a natural manner. This forms a pretty night lamp. Statuettes of saints have a halo in enamel at the back of the head. Bishops hold croziers the top parts of which are magnificently worked in enameled gold. Silver statuettes of queens and historical beauties are adorned with bracelets, necklaces, diadems and girdles made of chased gold with translucent enamel parts imitating colored stones.

The tendency, which I mentioned some time ago, to associate silver with semi-precious substances is becoming more decided. Clocks of ivory inlaid with gold arabesques, or of rock crystal with floral *motifs* in gold applied on the crystal are exhibited in several stores in the Rue de la Paix. There are also a great many jardinières, lamps and vases in malachite, lapis-lazuli, jasper, etc., adorned with graceful gold *motifs* partly sunk and partly in relief. On some, large sardonyx and heliotrope cameos are incased in the gold handles.

JASEUR.

ESTABLISHED 50 YEARS.

LANDEL, BAREMORE & BILLINGS,

IMPORTERS OF

DIAMONDS,

AND OTHER PRECIOUS STONES.

FINE PEARLS A SPECIALTY.

MANUFACTURERS OF

DIAMOND JEWELRY,

IN THE LATEST DESIGNS.

Diamonds Recut in Modern Styles or Repaired on Premises.

58 Nassau Street,  
29 Maiden Lane  
NEW YORK.

1 Tulp Straat,  
AMSTERDAM.

1 St. Andrews St.,  
Holborn Circus,  
LONDON, E. C.

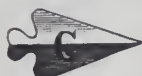

TRADE MARK.

ESTABLISHED 1841.

CARTER, SLOAN & CO.,

MANUFACTURERS OF GOLD JEWELRY,

No. 15 MAIDEN LANE,

NEW YORK.

A. CARTER, JR.  
A. K. SLOAN.  
C. E. HASTINGS.

GEO. R. HOWE.  
WM. T. CARTER.  
WM. T. GOUGH.

FACTORY, NEWARK, N. J.



JOHN N. DISSELKOEN,  
Cutter and Importer of  
DIAMONDS

FACTORY.  
76 LANGEBLEEKERPAD,  
AMSTERDAM.

19 East 16th St.,  
NEW YORK.

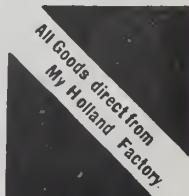

**Some American Spoons.\***

BY ELIZA RUHAMAH SCIDMORE.

**P**REHISTORIC man was not born with a spoon in his mouth, and it was after many slow stages of development that he reached any such refinement of feeding as to use an implement in the act. After he had received the divine gift of fire, and learned to toast his raw meat on the end of a stick, or lay it on hot stones or in the ashes, the next great step was to cook liquid messes by throwing hot stones in a hollowed rock. Burned fingers soon suggested the use of an implement, and as our remotest ancestors lived by the sea-shore or river-bank, where food was easily secured, shells were naturally the first spoons. Many such primitive implements are found in mounds, and some even show rude attempts at shap-



ALASKA SILVER SPOONS.

Copyright, 1893, by Harper & Brothers.

ing and ornamenting. Single perforations suggest that they were suspended from the owner's person, just as in later centuries European noblemen wore their fine silver spoons fastened to chains. Other perforations and notchings show that prehistoric genius, by combining the shell and stick, invented the complete spoon. This same archaic spoon — a clam or scallop shell held in a split stick or lashed to it by thongs — is in use to-day by many of our coast Indians, by Breton and Japanese fisher-folk, and is reproduced in miniature by the cleverest of Japanese silversmiths. In southern countries the gourd and cocoanut shell furnished drinking vessels without man's

\* Copyright, 1893, by Harper & Brothers.

thinking, and the spoon is only a lesser form that came naturally into use.

Spoons appear among relics of the iron and bronze age, and with civilization and the use of the precious metals all of art and ingenuity was lavished on this necessity. Greeks, Etruscans and Romans bequeathed their forms to later centuries, and in northern Europe the spoon had its fullest development. Custom, etiquette, legends, traditions, superstitions and history were attached to this common utility, and one sees all the quaint and artistic spoons of other centuries in many museums and large private collections. Only replicas and base imitations of such old spoons are now to be had in Europe, and as silversmiths there have reproduced apostle, windmill, coin, coronation, and heraldic spoons to meet the tourist demand, American dealers have fostered a spoon craze on this side. There is no city or any Summer or Winter resort so poor as not to have one or more souvenir spoons for sale, and "collections of American spoons" are often boasted of.

The spoons of the American Indians are full of suggestions for designs in silver, and many of them are of most unique and graceful form. Besides their shell spoons, which match the mound builders' treasures, they have spoons of wood, horn, bone, clay and copper, and following natural and inherent forms, have obtained many pleasing and original designs. Columbus, the Pilgrim Fathers, and John Smith found the red man eating with wood and shell spoons. The Sioux and the plain tribes long had clumsy buffalo-horn spoons, and they still make their counterparts of cow horns, the sharply recurved handles formed to deers' heads, and tricked out with dyed quills, beads and metal tags. The interesting wooden spoon of simple form, bearing a well-carved tortoise on the handle, was found in the Sioux camp after the battle of White Hills. While the Navajos, Zufis and Moquis of the southwest are more advanced than any of the other plains tribes, have fixed homes, and possess the art of pottery, their spoons are the crudest of all. Spoons suggested by and hollowed out from knots in the wood, and made by merely splitting the lower half of a horn, seem to have sufficed for their needs.

All the northwest coast is a land of spoons, and from Puget Sound to Mount St. Elias the Haidas have directed and influenced all the native arts. Inhabiting the islands on



CARVED HORN SPOONS.

Copyright, 1893, by Harper & Brothers.

either side of Dixon entrance now, the origin of the Haidas is unknown. From some older race, some unknown past, the Haidas received the traditions or the germ of a most original school of art, in which students have found suggestions of Aino, Chinese, New Zealand and Aztec methods. An elaborate symbolism or system of monstrous hieroglyphs is their only record of events or ideas, and by rigidly conventionalized animal forms they express all of legend, myth, history and genealogy. While surrounded by a strange richness of vegetation, nothing in their decorative schemes seems derived from this luxuriant leafage and bloom. Shells are little used, and shell forms rarely followed by these people, who live beside and on the sea, and who subsist almost entirely on marine food. The raven, the bear, the frog, the eagle, the whale and other beasts whose qualities and protection they wish, and whose hostility they would appease, crowd upon one another, and are curiously interwoven in their carvings. The totem or heraldic animal of his family marks all the belongings of a coast Indian, and before the increasing trade and tourist travel of the last decade changed it a Haida home was a museum in itself.

**CROUCH & FITZGERALD,**

Jewelry Trunks and Cases.

161 Broadway

bet. Cortlandt and Liberty Sts.,

688 B'way,

701 6th Ave.

NEW YORK



Sold by all wholesale dealers at manufacturer's price.

**A. N. CLARK,**  
PLAINVILLE,  
CONN.

Manufacturer of the Celebrated

**LOOP WATCH KEY.**

The Best for the Price in the World.  
CROSBY'S JEWELING TOOLS IMPROVED.

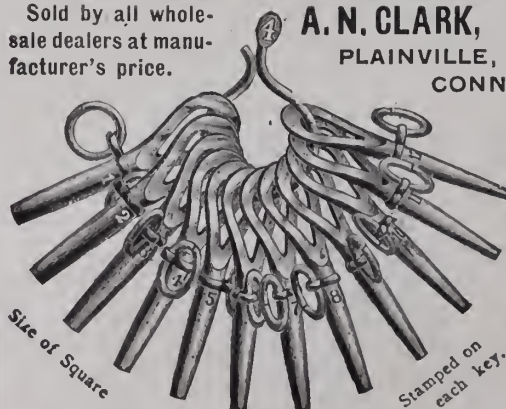

Size of Square

Stamped on each key.



Will quote royalty or price for the manufacturing of articles of real worth.

The Haida carvers have wood and a soft slate to expend their genius on, but the finest work is shown in their spoons of mountain-sheep and mountain-goat horn. The fine black goat horn is steamed soft, bent, pressed into shape, and held in a wooden mould or matrix while the artist carves totemic figures in full relief the whole length of the handle, and etches over the outer surface of the bowl with totemic designs. He does it all with a short knife blade and a rude gouge, which he has lashed into a carved handle of his own contriving. He smooths and finishes off the surface with a scraper and a piece of shark-skin, but does not attempt polishing. Inlaying with abalone shell brightens the work; and the copper riveting, when bowl and handle are not entire, is rather ornamental.

There are spoons or, more properly, ladles two feet long, shaped from the horns of mountain sheep, or big-horn. This horn is heavy and coarse in grain, and little open or relief work is attempted with it, fancy expending itself in shaping the tip into some totemic animal and etching and inlaying the bowl. Such spoons are a pale dull yellow when first cut, but time and seal oil tone them to rich reddish-brown shades, and when finely polished they are like old amber. The bowl holds a pint or more, and at great potlatches, or feasts, the heroes of the day or youths attaining their majority bravely took a whole spoonful of seal oil at a single draught. Faith "he must have a long spoon who would eat with the devil," and these same sizes in spoons must have been in fashion in Virginia when "ye na-

which is in the National Museum at Washington.

The natural curve of the tapering goat horns easily gave the graceful handles of these spoons; but the symmetrical bowls, made by deliberate effort, and the straightening of twisted sheep horns into more pleasing and manageable lines, show that there was an artistic idea in the maker's mind.

The Chilkat sheep-horn spoon is in strong contrast to the gracefully curved and richly carved Haida spoons. It is a form often copied in wood, and stained brown or black in these degenerate days of trade; and all the Thlinket tribes from the Stikine to Yakutat use it as well. It is a form easily secured from horn, and has economy of material as well as of effort to recommend it, and its flat handle and shallow bowl are most in vogue with the spoon makers to-day.

The Indians of the coast used to have quantities of carved spoons that had come to them by inheritance, were made by their commands, or given them at potlatches, when the rich men and chiefs of the tribe gave away all their belongings as souvenirs of the entertainment. In these degenerate modern days they have been quick to sell these heirlooms to tourists and traders, and slow to make any new spoons after the old models, content to have a dozen of the trader's shiny metal spoons for one of their ancestral trophies. Few horn spoons are to be had now save of the traders and curio dealers whose prices are absurdly extravagant. Their scales range from three to fifty dollars, polishing and metal mountings

doubling both cost and beauty. Spoon-polishing is a recent fad, and tourists in Alaska soon learn to scrape their horn spoons thin enough to show all their amber tones, their tortoise-like shades and cloudings. Sand and emery paper, pumice-powder, and rotten-stone succeed one another, and then only rubbing with the bare hand can bestow that final gem-like polish which makes them resemble onyx or amber.

As the fever for souvenir spoons spread, the Alaskan was led to hammer silver dollars into clumsy imitations of fiddle pattern spoons, or merely etch totemic designs on the traders' plated ware. A Haida silversmith has made some simple little spoons after the old wood and horn models, and a Stikine has combined an egg-shaped bowl with a canoe paddle for a handle with good effect. Unfortunately, the eager Summer buyers will take anything that looks like a spoon, and the natives are not encouraged to do any really good work or express their own ideas.

A SERVANT'S ALARM CLOCK.

FAIR CUSTOMER—Are those pretty alarm clocks good for anything?

DEALER—Yes, indeed, madam; I have one of the smallest sizes at home, and always depend on it when I want to catch a train.

"Well, I want one for the servant girl's room."

"Ahem! Perhaps I better show you our new patent alarm made specially for that purpose. It is rather expensive but very effective, being a mechanical compound of a whistling buoy, an engine bell and a fog horn."—*Texas Siftings.*



CAMEO SPOON, LENGTH, 18 INCHES.

ALASKA SILVER SPOON.

Copyright, 1893, by Harper & Brothers.

tives" were so convulsed at the tiny spoons used by the first Englishmen, and the frequent trips to the mouth their size occasioned. There are some gigantic wooden spoons used at the great potlatches, whose bowls hold two quarts and more. These usually served as loving cups, from which every one drank in turn, but it is said that there were men in the old days who could even toss down such spoonfuls of oil without stopping.

By combining sheep and goat horn the most beautiful results are obtained, the black carved handle setting off the yellowish bowl, and its figures often overlapping it in cameo effect. One of the finest specimens of this cameo work is the long spoon



"Old English"  
Coffee Spoon.



DESIGN PATENTED.

Towle Mfg. Co.,

MANUFACTURERS OF

STERLING SILVERWARE.

NEWBURYPORT: No. 214 Merrimack St. CHICAGO: Nos. 149 & 151 State St.

# Grand STREET Exhibition!

To the Jewelers . . . . .

You have visited the World's Fair, now come and see us.

You will find in our Warerooms more ARTISTIC NOVELTIES than you have seen at Jackson Park

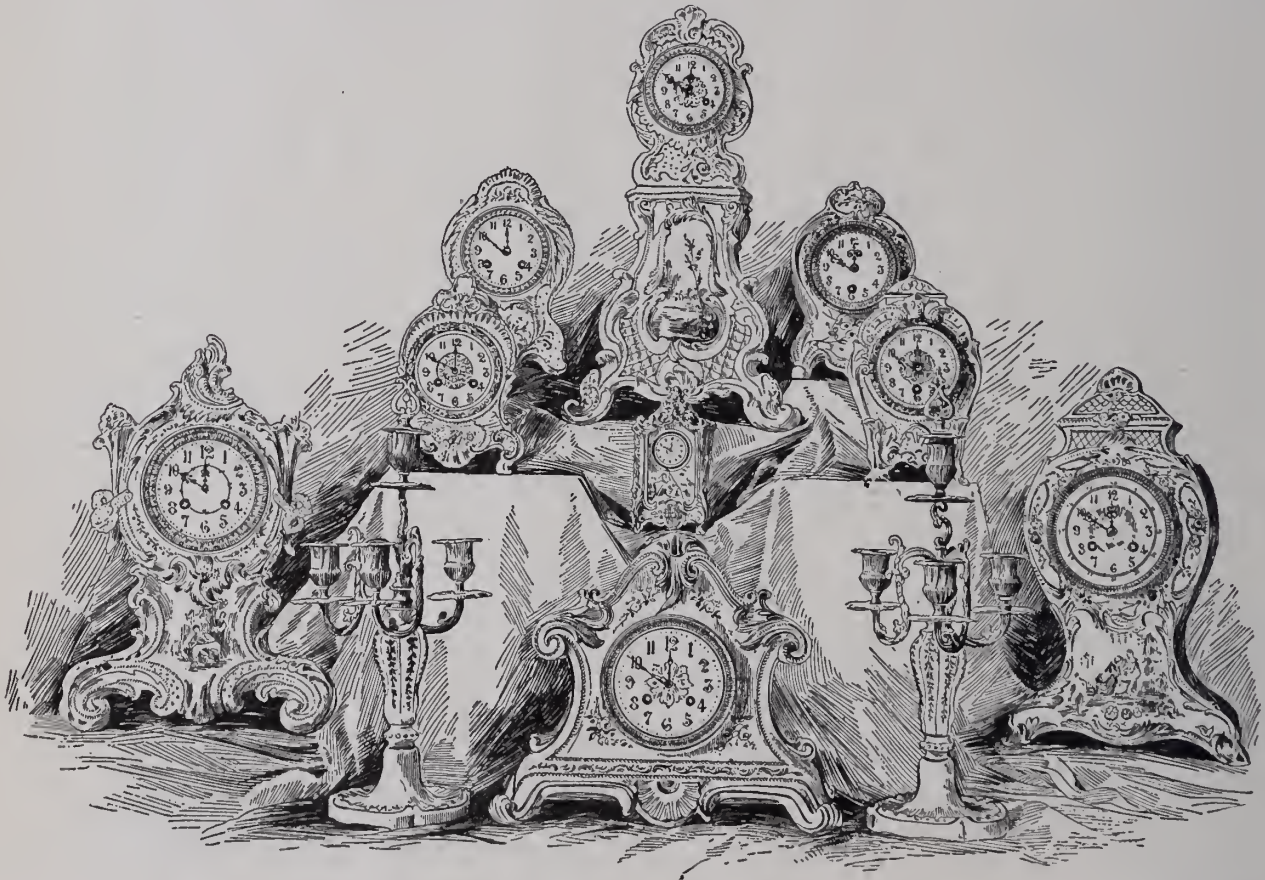

**France**==BRONZES, CLOCKS OF ALL DESCRIPTIONS, SEVRES VASES, LAMPS, PORCELAINS, FINE FURNITURE.

**Germany**==ROYAL BERLIN, ROYAL BONN, NURNBERG MAJOLICA, DRESDEN VASES, DRESDEN LAMPS IN ENDLESS VARIETY, DRESDEN FURNITURE, IVORIES.

**Austria**==DECORATED GLASS, OLD VIENNA WARE, TEPLITZ GOODS, FAYENCE STATUARY, BRONZES.

**Italy**==SUPERB LINE OF CARRARA AND CASTELLINA MARBLES, NOVE AND BASSANO FAYENCE, CARVED FURNITURE

**England**==ROYAL WORCESTER, COALPORT, TULIP GLASS, ENGLISH CHIMING HALL CLOCKS.

## Ferdinand Bing & Co.,

74 Rue d'Hauteville,  
PARIS.

106 Grand Street,  
NEW YORK.

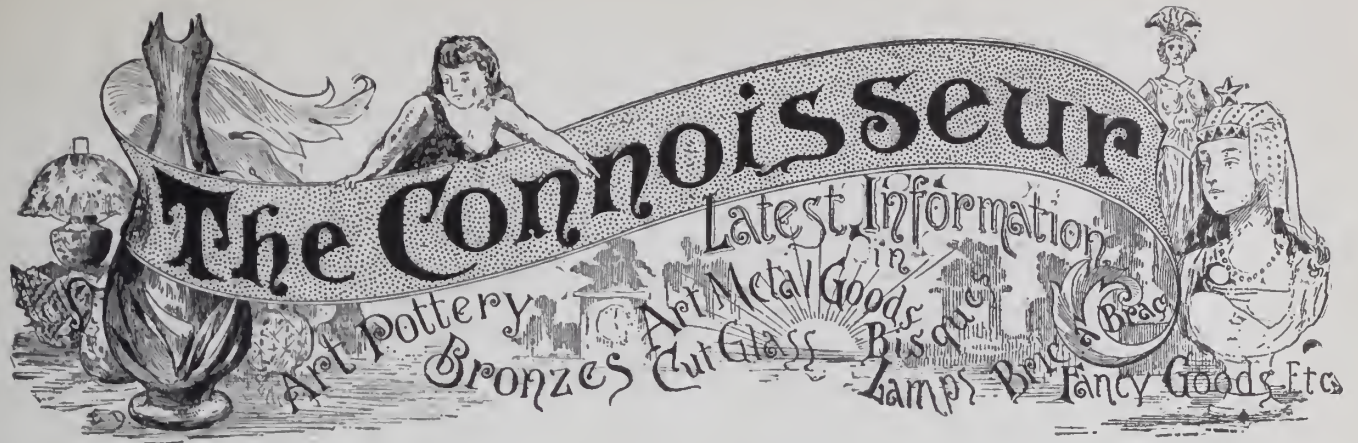

**Artistic Lamps at Ferd. Bing & Co.'s.**

**T**HE marvelous increase in the demand for artistic lamps has caused to be

brought to New York the beautiful wares of the world and the leading importing houses have now found it necessary to have their ware-rooms replete with the finest products of European and American manufacturers. Convincing proof of this statement is to be found in an inspection of the show-rooms of Ferdinand Bing & Co., 106 Grand St., New York, who are at present making a specialty of all varieties of beautiful lamps, of which the specimens depicted in the illustration are representative.

The center piece, a magnificent Sèvres piano vase-lamp is of a rich dark blue, with raised gold decorations. The framework and tripod are of real bronze in mercury gilt. The shaft running down into the stand which has the same colors and decorations as the body of the lamp, is a new feature, and is an im-

provement in piano lamps, as it not alone augments their beauty but causes them to appear as one piece and less like a banquet lamp upon a stand. The shade shown upon the lamp in the illustration is of silk, with

a true copy of the original Royal Dresden lamp in the Dresden Museum. Besides the Watteau panels surrounded by raised flowers which ornament the bowl, the perforated stem is decorated with gold, blue and pink

forget-me-nots. Between this and the center lamp is a Sèvres banquet vase-lamp of a rich pink color on a white background. The beautiful painting represents "Spring." The decorations are of heavy raised gold. The other Sèvres banquet lamp is almost a miniature of the large piano lamp, save that the color is a rich turquoise blue. The paintings are by Quentin. The subject of the panel shown represents Venus instructing Cupid. As in the large lamp, the stand and trimmings are of fine gilt bronze. The Stalk lamp upon the edge of the group, is an example of a line previously described in these columns, of which this firm is showing one of the largest varieties to be found in



SPECIMENS OF NEW ARTISTIC LAMPS SHOWN BY FERDINAND BING & CO.

the finest Swiss embroidery.

The Dresden banquet lamp at one end of the group is an extremely tall specimen and

the country. The piece shown is of real bronze and represents a sunflower plant in bloom.

## The Connoisseur.

(Continued from page 45.)

### The Rambler's Notes.

WHAT THE RAMBLER SAW AND HEARD AMONG THE DEALERS IN ART POTTERY, CUT GLASS, BRONZES, ETC.

**BAWO & DOTTER'S DRESDEN CLOCKS.** AMONG the latest goods shown by Bawo & Dotter, 30 Barclay St., New York, is a line of Dresden clocks in which the rococo styles prevail. The shapes are both numerous and attractive and the decorations artistic. Empire green, soft salmon pink and other popular colors appear in great variety and in all cases blend harmoniously with the colors of the raised flowers with which the cases are ornamented. Candelabra to be used as side pieces, are shown in the same styles and decorations as the clocks.

\*

**NEW PORCELENE POMPADOUR CLOCKS.** Many new varieties in shapes, colors, and decorations have been added to the Porcelene Pompadour mantel clocks and alarm clocks manufactured by the F. Kroeber Clock Co., 360 Broadway, New York. The finish on the cases is now superior to that on the older pieces, and the tints are now as beautiful, soft and delicate as any ever shown upon a clock

case. These clocks are of enameled iron, manufactured under the patented process of the Kroeber Clock Co., and have a lustre, finish and color equal in beauty to the finest porcelain. In fact, many connoisseurs who have looked at some of the lines which have just been introduced, and admired their graceful shapes and artistic gilt decorations, have found it difficult to believe that these clocks are not of the finest porcelain.

\*

**T. B. CLARK & CO'S COLORED CUT GLASS.** Additions have been made to the assortment of colored cut glass pieces at the warerooms of T. B. Clark & Co., 53 Park Place, New York, particularly in the blue and light green vases and flower holders. The beauty which glassware adds to the appearance of the dinner table when used as center or side pieces, cannot be overrated. When it is remembered that to the delicate tint of the glass and the artistic shape of the piece is added the brilliancy accruing from the Nevada, Thetus and the new Egyptian and Coval cuttings, the popularity of these vases and flower holders is not surprising.

\*

**MANTEL AND CABINET ORNAMENTS.** A beautiful line of mantle and cabinet ornaments is to be seen at the New York warerooms of the New Jersey Lamp and Bronze Works, 44 Murray St. These are ewer shaped, and are in silver and

gilt finished bronze or bronze and china. In the latter the body is of china of a delicate tint, either plain or decorated, and the stem, handle and top are of bronze. In some, silver open work covers the body of the piece.

\*

**JEWEL BOXES SHOWN BY HINRICHS & CO.** Hinrichs & Co., 31 Park Place, New York, are at present making a specialty of jewel boxes of all descriptions. Among those to which they are calling special attention are the gilt mounted mat-glass jewel boxes, with flower decorations, those of optic glass in rose, blue and aqua, which also have flower decorations, the gold filigree boxes of various shapes, besides a variety of extremely handsome gilt mounted Sèvres jewel boxes. These last are but part of a line of Sèvres novelties containing ink stands, pen trays, mounted vases, candlesticks, plates, etc., which is considered to be one of the finest and most complete of its kind ever carried by any firm.

\*

**INTERESTING LINES AT CHAS. AHRENFELDT & SON.** A particularly fine display of all varieties of Dresden china, is to be seen at the warerooms of Chas. Ahrenfeldt & Son, 50-54 Murray St., New York, among which are the artistic novelties with Wettin decorations, fancy goods, baskets, magnificent centrepieces, candelabra of many colors and beautifully decorated lamps, all of which cannot fail to

**WE** beg to notify our friends that our stock is now complete with all the latest productions. You will find goods especially adapted to the Jewellery Trade, such as

**Royal Worcester,**

**Sevres,**

**Doulton,**

**Crown Derby,**

**Crown Vienna,**

**Royal Bonn,**

**M. Redon,**

**Carlsbad,**

**AND OTHER CHOICE AND DESIRABLE LINES.**

Give us an early call as it will be to your interest to do so.

**CHARLES AHRENFELDT & SON,**

50, 52 and 54 Murray St.,

New York.

PARIS.

LIMOGES.

DRESDEN.

CARLSBAD.

# ANNOUNCEMENT



## FALL, 1893.

OUR Importations for the coming season are now arriving and we have on exhibition at our ware-rooms a complete assortment of exclusive

# Novelties and Specialties

SELECTED FOR THE JEWELRY TRADE.



SPECIMENS OF FALL GOODS FROM THE STOCK OF LEON J. GLAENZER & CO.

Clocks, Bronzes, Sevres Vases, Fine Decorated Porcelains, Cups and Saucers, Tea Sets, Lamps and gilt and silver plated filigree Photo Frames in endless variety.

# LEON J. GLAENZER & CO.,

35 Boulevard de Strasburg, Paris,

80 & 82 CHAMBERS ST., N. Y

## The Connoisseur.

(Continued from page 46.)

be of interest to the jewelers who handle fine china, art pottery, etc. Other wares shown in new and extensive varieties are Crown Derby vases in pink, yellow and blue with gilt decorations. Faience figures of every size, groups, busts and single pieces, and the new Magdeburg ware in which is shown many attractive but comparatively inexpensive vases, candlesticks, large punch bowls and ornamental pieces of various kinds, form a stock of goods that all jewelers should inspect, if they have their own interests at heart.

THE RAMBLER.

## Clay Figures in Athens.

A MOST pleasing instance occurred the other day. In the streets of Athens there were sold by some casual street boys, figures about ten inches in height of the human form made in baked clay, and some man with a practised eye recognized at once that they were of exquisite beauty and began to purchase them. More figures appeared, more buyers appeared, and at last the Louvre in France, and the British Museum in England, and other places, became anxious to arrange these figures among their great art objects.

Where were they found? They were found in the tombs of Tanagra, a second rate city in a second rate province of Greece, in Bœotia, which was known as the least clever of all the provinces of Greece. Think what must have been the redundancy of the sense of beauty and the power of producing beauty in visible form among a people who could afford to throw into the tombs of second rate people of a second rate city of a second rate province those objects we were now glad to accept from them and exhibit in the choice cases of the Louvre or the British Museum.

## THE GIRL AND THE RING.

A SUMMER girl stood on the cool, white sands,  
And she toyed with the rings on her nut-brown hands,  
And she looked at the jewels that flashed by the sea,  
But her heart beat fast and her heart beat slow  
As she stared at the finger that held but three.  
Then the Summer girl raised her eyes of brown,  
And she spied a man that had just come down;  
So she lifted her finger and held it high,  
And the man came fast and the man came quick,  
And at last caught on with a gladsome sigh.  
Now the Summer girl sits on the cool, gray sands,  
And he fondles the rings on her gloveless hands;  
And the moon comes up o'er that lone sea shore,  
And it shines on her and it shines on him  
As they stare at the finger that now holds four.  
—Vogue.

No one believes that President Cleveland's younger daughter was born with a silver spoon in her mouth.—Life.

## The Other Side of Life.

The pessimist is a gentleman who expects to choke to death on the golden spoon born in his mouth.—Puck.

HE—Why do you wear the ring if it is too small and hurts your finger?

SHE—Oh, it's my wedding ring, and helps me to remember.—Life.



LEARNING EVERY DAY.

MR. MURPHY (as he gazes at sun-dial near Illinois Building)—Faith, an' thot must be wan o' thim toime tables Oi heerd tell av.—World's Fair Puck.



## Exceptional Opportunity

FOR

## Bric-a-Brac Buyers!

OUR entire collection of IMPORT SAMPLES of HIGH ART NOVELTIES, specially imported for the Jewelry Trade, are now on exhibition and will be sold on and after Sept. 1st, at Big Reductions to make room for new importations of Fine Pottery, Art Furniture, Marbles, Exclusive Art Productions, &c.

## GEO. BORGFELDT & CO.,

18, 20, 22 WASHINGTON PLACE, cor. Greene Street, NEW YORK.



# Art Corners in Geo. Borgfeldt & Co.'s Establishment.



ART ROOM NO. 1.

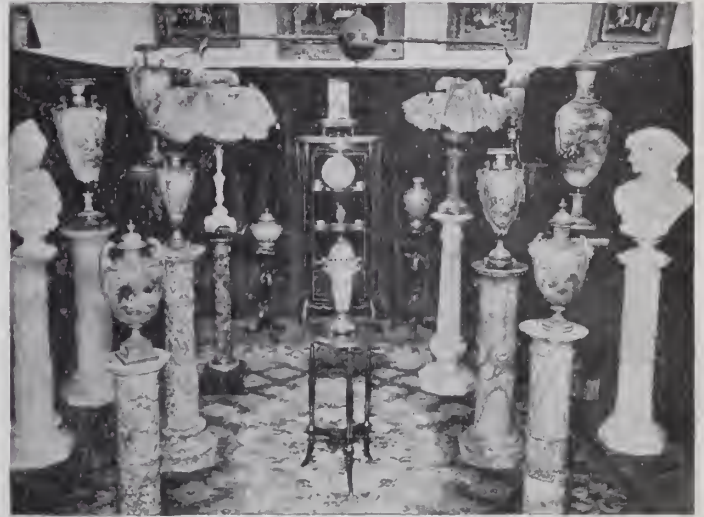

ART ROOM NO. 2.



ART ROOM NO. 3.



ART ROOM NO. 4.

## To Jewelers and Art Dealers :

Our third floor, 100x100 FEET is devoted exclusively to BRIC-A-BRAC, ARTISTIC NOVELTIES and the RICHEST PRODUCTIONS in ART POTTERY, GLASSWARE, CLOCKS, PEDESTALS, ETC., of which these cuts will give some idea.

We are disposing of these collections at SPECIAL PRICES, preparatory to the arrival of our new lines for 1894, thus affording an EXCELLENT CHANCE for buyers to obtain, with small outlay, a beautiful assortment of CHOICE GOODS.

Very Respectfully,

# GEO. BORGFELDT & CO.,

18, 20 & 22 Washington Place, New York.

OURS IS THE  
**CH. FIELD HAVILAND**  
LIMOGES CHINA.

FABRIQUE FONDÉE EN 1797.  
**E. GERARD, DUFRAISSEIX & CIE.,**  
SUCCESSIONS :

WHITE WARE.  
**CFH**  
GDM  
FRANCE  
TRADE MARK.

DECORATED.  
**CH. FIELD HAVILAND**  
LIMOGES  
TRADE MARK.



SOMETHING ABSOLUTELY NEW IN CERAMICS, FURNACE FIRE COLORS.

**HAVILAND & ABBOT,**

AGENTS FOR THE UNITED STATES,

29 Barclay Street, NEW YORK.

**FRENCH CHINA SPECIALTIES FOR JEWELERS.**

BRUSH & COMB TRAYS,  
CARD TRAYS,  
MANICURE TRAYS,  
PEN TRAYS,

PHOTOGRAPH FRAMES,  
FRUIT PLATES,  
ODD CUPS AND  
SAUCERS, ETC.

◁ SEND \* ORDER \* FOR \* SAMPLE \* ASSORTMENT. ▷

**F. W. BUNING & CO.,**

58 MURRAY STREET, NEW YORK.

**J. H. DEDERICK, JR.,**  
— DEALER IN —  
*Roll Plate Jewelry and Chains,*  
Optical Goods and Jewelers' Supplies,  
16 MAIDEN LANE, NEW YORK.  
JET GOODS A SPECIALTY.

**A. J. LOGAN,**  
MANUFACTURER OF  
WATCH TOOLS, HAIR SPRINGS AND  
**WATCH MATERIALS.**  
◁ New Catalogue just issued, Sent on Application. ▷  
WALTHAM, MASS.

ESTABLISHED 1870.

**J. L. CLARK,**  
SWEEP SMELTER AND REFINER OF GOLD AND SILVER.  
Buys every kind of Gold and Silverware, Jewelry, Watches and Platinum. Full market value paid.  
**No. 724 Filbert Street, Philadelphia, Pa.**  
SEND BY EXPRESS or Registered Mail. If my price is not satisfactory, I will return all articles.

**THE POTTER**

I WATCHED a potter at his wheel one day,  
For he was making pitchers out of clay—  
The feet of beggars and the heads of kings—  
Dust blown from old, dead cities, far away.

Not heaven itself more splendid is and high  
Than was this palace when its kings went by—  
Race after race. The turtle sits here now  
"Where? Where?" she cries. But there is no reply.

They who, endowed with wisdom, are like light—  
Torches to guide their followers' feet aright—  
They have not taken yet one step beyond  
This night of mystery—this awful night.

Speak of these wise ones, then, with bated breath;  
The most that of the wisest wisdom saith  
Is—they bequeathed you fables, nothing more.  
Before returning to the sleep of death.

The great wheel of the heavens will still go round  
When you and I, my friend, are under ground;  
At once creating life, conspiring death,  
With death and life inexorably bound.

Come, sit upon the grass, and drink your wine,  
And quickly while the suns of Summer shine;  
For other grass than that you sit upon  
Will soon be springing from your dust and mine.

When you and I are gone, for we must go,  
They will raise bricks above us, and I know  
That other bricks for other tombs than ours  
Will out of us be molded. Be it so.

I do not fear the world. I do not fear  
The leaving it, though I confess it dear.  
We should fear nothing but not living well  
In the only life and world we know of—Here.

But come, my friend, since we must pass away,  
Since all we are goes back again to clay,  
What does it matter whether we remain  
A hundred years, or but a single day?

Be it our care, since pitchers we began,  
To hold the heart's good wine long as we can,  
Before the potter moulds our dust again  
Into new shapes that are no longer man.

—RICHARD HENRY STODDARD.

A man never has so much use for his  
watch as when listening to a long sermon.—  
*Atchison Globe.*

ESTABLISHED 1837.  
**GEO. O. STREET & SONS,**  
MAKERS OF  
Fine Rings, Locketts, Seals,  
Sleeve Buttons and Links,  
15 John Street, NEW YORK.

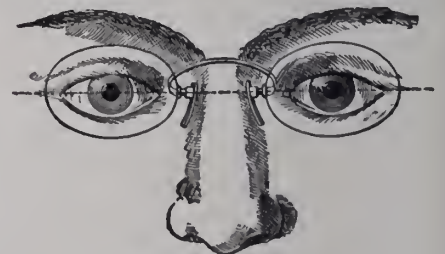

Patented Feb. 9, 1892.

**THE W. B. & E.**

Marvel Tilting Spring Eyeglass in Gold,  
Steel, and Frameless.

**JULES LAURENCOT & CO.,**  
49 MAIDEN LANE, NEW YORK.

Sole Agents in the United States and Canada.

Call early to see our Art Goods for Jewelers, Especially selected for all classes of Jewelry Stores.

NOTE—MANY FINE IMPORT SAMPLES AT 50 PER CENT. REDUCTION.

LEVY,  
DREYFUS & Co.,  
9 & 11 Maiden Lane, N. Y.

OPERA GLASSES IN VARIETY UNEQUALED IN THE U. S.

An entire New Stock direct from the Art Centers of Europe.



The finest line of "Novelties" for Jewelers ever shown in this market.

# ROGERS, SMITH & CO.

UNION SQUARE,  
NEW YORK.



MERIDEN,  
CONN.

BEST QUALITY

GOLD AND SILVER PLATE.

**B. & W. B. SMITH,**

220 WEST 29TH ST.,

NEW YORK CITY.

AT THE

**WORLD'S FAIR, CHICAGO,**

OUR EXHIBIT IS IN THE

Manufactures and Liberal Arts Building, Section A, Block One.

CALL AND SEE US AT OUR OFFICE IN NEW YORK.

**WHY**

S. F. MYERS & CO. sell more goods than any other Wholesale Jewelry House.

**BECAUSE**

They are the only firm in the Metropolis who carry in stock a full line of everything a jeweler requires. They give the utmost values and endeavor to please their trade in every respect. Refer to their various publications and illustrated catalogues.

MYERS BUILDINGS, 48 & 50 Maiden Lane, NEW YORK.

**The Bryant Rings.**

have in 45 years earned the reputation of being the standard in quality, style, finish and durability. They are made of solid gold, in great variety, for men, women and children.

**ASK YOUR JEWELER FOR THEM.**

If he don't keep them and won't send for them, send us your money and we will deliver them through the nearest reliable jeweler.

**OUR INITIAL AND RAILROAD BROTHERHOOD RINGS**

With or without diamonds, are the handsomest made.



856



857



548

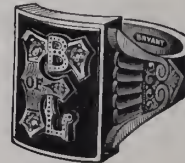

859

**M. B. BRYANT & CO., No. 10 Maiden Lane, New York.**

OLDEST RING MAKERS IN AMERICA.

**The Bryant Rings.**

Are extensively advertised in the leading magazines, Family, Religious and Fashion papers for the benefit of the Retail Jeweler.

The adjoining advertisement will appear for a year in the great R. R. BROTHERHOOD Journals.

PRICES of our INTERCHANGEABLE Rings either with emblems with six diamonds, or without diamonds will be sent to Jewelers only on application.

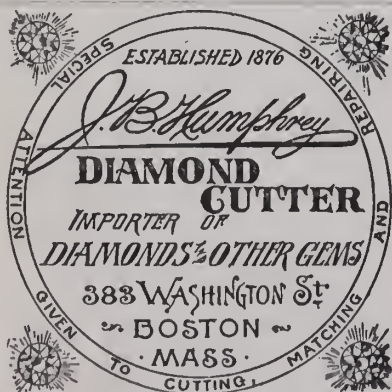

**S. P. HOWARD,**  
Gold and Silver Assayer,  
**Refiner and Sweep Smelter,**  
33 MAIDEN LANE, NEW YORK.  
Smelting and Refining Works,  
28 & 30 Cumberland Street, Brooklyn, N. Y.  
Specialties: Sweepings, Gold, Silver and Platinum.



**GILT AND CHINA SET, 2040/1,**  
Clock 13 inch. High—in three decorations.

15 Day Fine French Movement Time, \$14.50, cash with order.  
" " " Gong Strike, 18.00, " "

**CHAS. JACQUES CLOCK Co.,**

22 CORTLANDT ST.,

NEW YORK.

**IT PAYS** TO KEEP IN TOUCH WITH TRADE AFFAIRS. **THE JEWELERS CIRCULAR,** For 4c. a Week will do it. **Subscribe.**

(Fulton Building), NEW YORK.

WORLD & GUNZBURGEN, Importers of DIAMONDS, NEW YORK.

L. & W. KATIN & CO., Importers of DIAMONDS, Cor. Maiden Lane, NEW YORK.

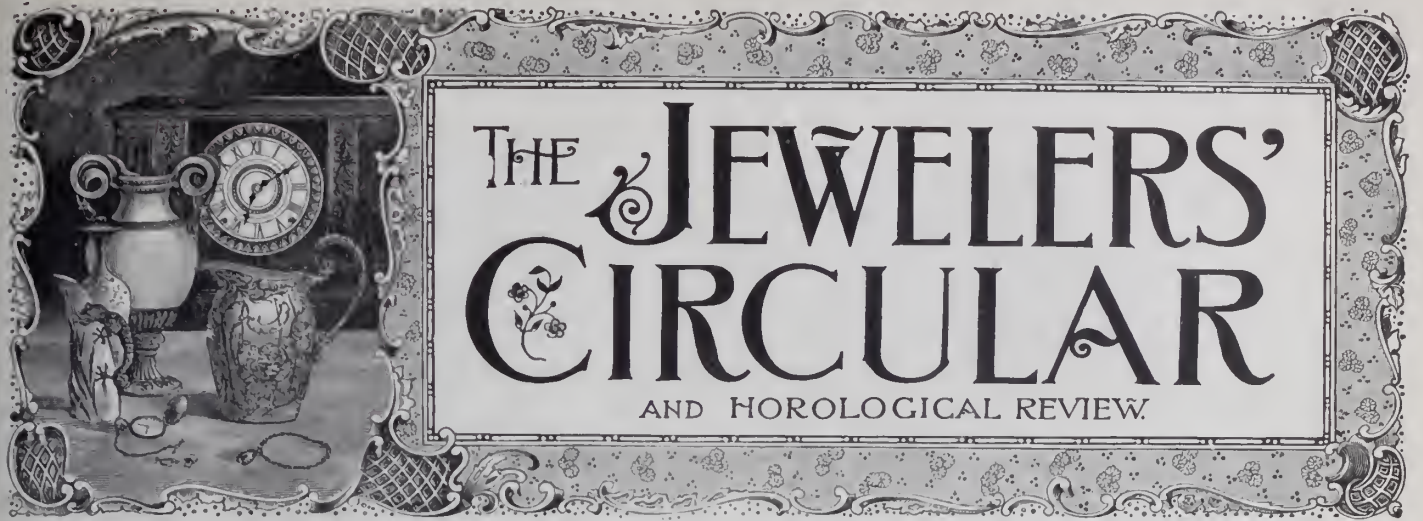

Copyright, by THE JEWELERS' CIRCULAR PUB. CO.

189 Broadway, New York.

Entered at the Post Office in N. Y. as second-class matter.

VOL. XXVII.

NEW YORK, WEDNESDAY, OCTOBER 4, 1893.

NO. 10

BEAUTY AND APPROPRIATENESS IN SILVER TROPHIES.

THE winner of the International Bicycle Trophy, at Chicago, Arthur Zimmerman, is a fortunate individual, not only in possessing marvelous powers as a cyclist, but in being enabled through these powers of gaining such a work of art in silver, as is illustrated on this page. There were thirteen competitors in the race to win the contract for furnishing the trophy, but to the Gorham Mfg. Co. fell the selection. The trophy cost \$1,000, is made of sterling silver with an ebony base, and is the largest and most expensive prize ever given to the winner of a bicycle race. It was ordered by H. L. Saltonstall, captain of the Elizabeth Athletic Club cyclers.

The piece is a punch bowl standing on a six-inch high ebony base, surmounted by the form of Fame, standing on a globe and holding a wreath outstretched in one hand. The trophy is in the form of a Grecian urn, and the Grecian style of art as exemplified by the acanthus is followed throughout. The height of the work is about twenty-seven inches. The globe upon which Fame stands is engraved with a map of the world, and around it are grouped the flags of the nations. The arms of the urn are formed of acanthus leaves, and from each is extended a wreath of the same design. On one arm is the head of Bacchus, on the other, the head of Mercury, the two emblematic of speed and strength. Directly under each arm is an American eagle with the American shield on its breast. On the front and center of the urn is a winged sphere, on which is engraved one of the hemispheres. On the rear and center is another winged sphere upon which is engraved the well-known L. A. W. emblem. Extending from each

are graceful loops and folds of acanthus. A perfect figure of a racing wheelman,

of the trophy. Altogether the work is on the most classical and artistic plan, and is a great triumph for the skilful designers and artists connected with the Gorham Mfg. Co. Especially in the arms of the urn, having as handles the heads of Bacchus and Mercury, and the dainty and exquisite feminine form of Fame riding the globe with a laurel wreath in her hand, is the skill of the designer displayed to the best advantage.



THE INTERNATIONAL BICYCLE TROPHY—MADE BY GORHAM MFG. CO.

mounted on a pneumatic tired bicycle, waiting for the word to start, adorns the bottom

ounces to 124 tons, both of iron found within 80 miles of the city of Sydney.

Monster Earrings in Borneo.

IN a paper read recently before the Royal Geographical Society, London, Eng., on the highlands of Borneo, in the Indian archipelago, Charles Hose gave an account of how the native mothers stick huge rings through their daughters' ears at the age of eight months only, eventually increasing them to the weight of two pounds each. By the time that a girl has come to her maturity her ears thus weighed down, reach almost to their elbows, and Mr. Hose has seen one woman put her head through one of these elongated ear-lobes. In the south of Italy long and heavy earrings are worn, though not approaching those of Borneo.

Evan Jones, Sydney, N. S. W. strikes off medals at the World's Fair in the form of a Maltese cross  $\frac{3}{4}$  inch in diameter, with the complete Lord's Prayer or Ten Commandments on one side in microscopic letters. Mr. Jones is a manufacturing jeweler of Sydney, and brought to the Fair two medal presses of his invention, one striking 2 ounces to 68 tons, the other 2

## THESE LEATHERS ARE MADE IN THE FOLLOWING ARTICLES:

Card Cases,  
Pocket  
Books,  
Photo.  
Frames,  
Calendars,  
Folios,  
Purses,  
Combination  
Books,

Desk Pads,  
Cigar Cases,  
Prayer  
Books and  
Hymnals,  
Stamp Cases,  
Watch Card  
Cases,  
Marriage  
Registers,

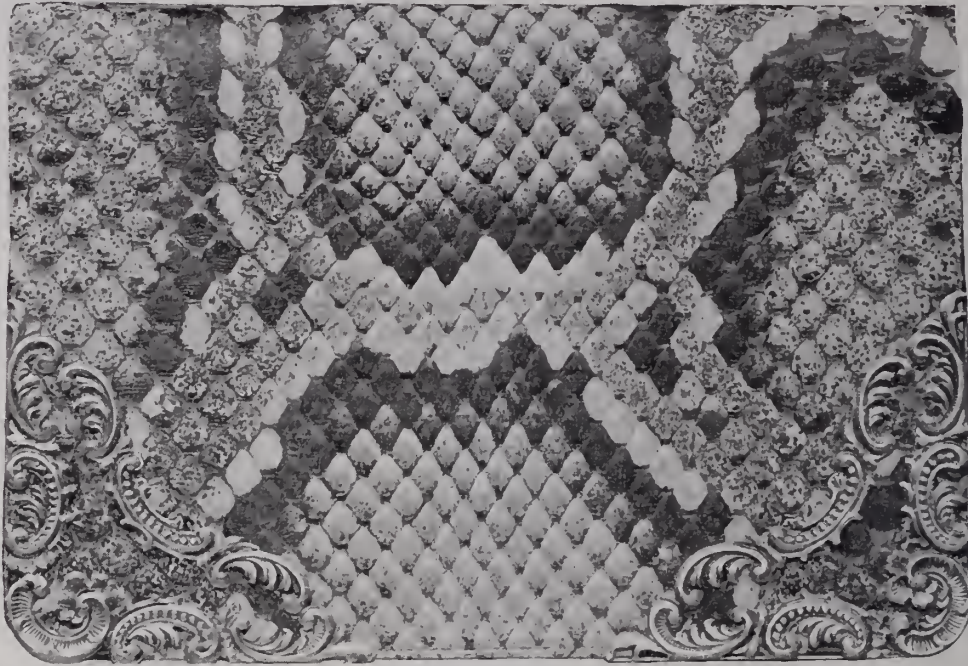

NATURAL SNAKE CARD CASE—STERLING CORNERS— ROCOCO."

Spectacle  
Cases,  
Memo.  
Books,  
Check  
Blotters,  
Address  
Books,  
Visiting  
Books,  
Bill Folds,  
Cigarette  
Cases,

Engagement  
Pads,  
Eye Glass  
Cases,  
Finger  
Prayer  
Books,  
Telegraph  
Pads,  
Chatelaine  
Bags,  
Pen Wipers.

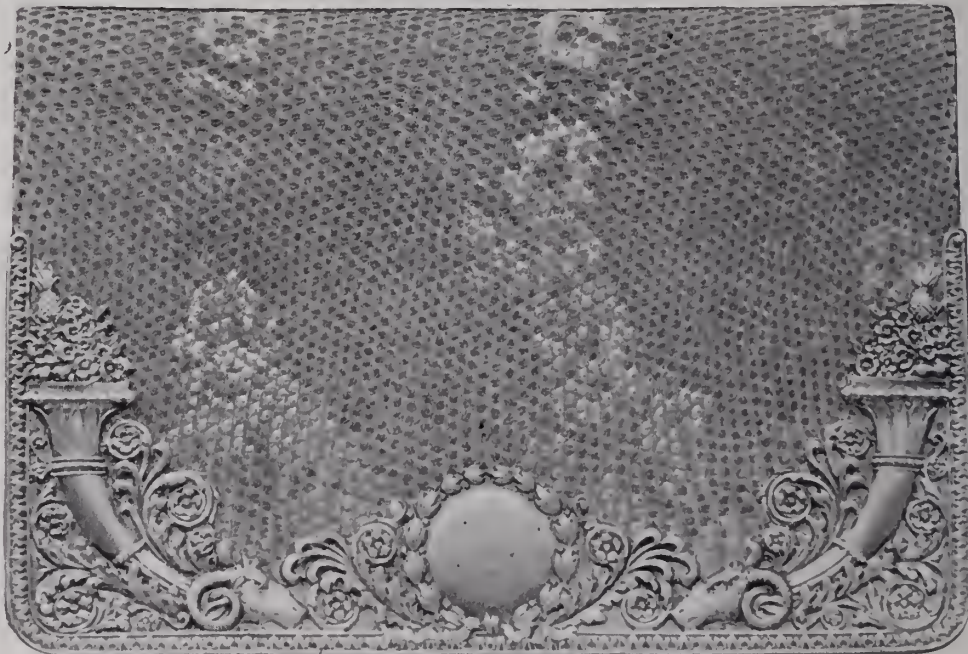

NATURAL LIZARD COMBINATION—STERLING FRONT— EMPIRE."

# DEITSCH BROS., MAKERS,

7 EAST 17th STREET, NEW YORK.

ORIGINATORS OF NOVELTIES IN LEATHER AND STERLING SILVER COMBINATIONS.

MARJORIE.

INITIAL.



ILLUSTRATING DESIGNS OF  
**EBONY AND SILVER**

COMBINATIONS

—IN—

**TOILET SETS.**

**DEITSCH BROS.,**

—ORIGINATORS OF NOVELTIES—

—IN—

—Ebony and Silver Combinations.—

7 EAST 17TH STREET, NEW YORK CITY.

# "DO YOU KNOW?"

THAT GOODS FREE FROM SOLDER ARE THE BEST?  
 THAT GOODS MADE FROM SEAMLESS WIRE ARE SUPERIOR IN FINISH ON THIS ACCOUNT?  
 THAT SEAMLESS WIRE MAKES THE BEST FILLED CHAINS?  
 THAT WE ARE THE MAKERS OF THE ORIGINAL AND CELEBRATED

## SEAMLESS GOLD FILLED CHAINS?



Do not fail to visit our beautiful and artistic display at the World's Fair. The finest of its kind at the Exposition.



Northeast Corner of Manufactures Building, Department O.  
 Right on the corner. See Official Catalogue.



# Kent & Stanley Co.,

BRANCH OFFICES:

NEW YORK: 17 MAIDEN LANE. SAN FRANCISCO: PHELAN BUILDING.  
 BOSTON, 58 WINTER STREET, MONTREAL, TEMPLE BUILDING.

MAIN OFFICE AND WORKS:

PROVIDENCE, R. I.

**AIKIN, LAMBERT & CO:**  
 19 Maiden Lane, NEW YORK.  
 Branch, 42 & 44 East Madison St., CHICAGO, ILL.  
 Manufacturers and Exporters of  
 Gold Pens, Holders, Picks, Pencils,  
 Fountain Pens, etc.

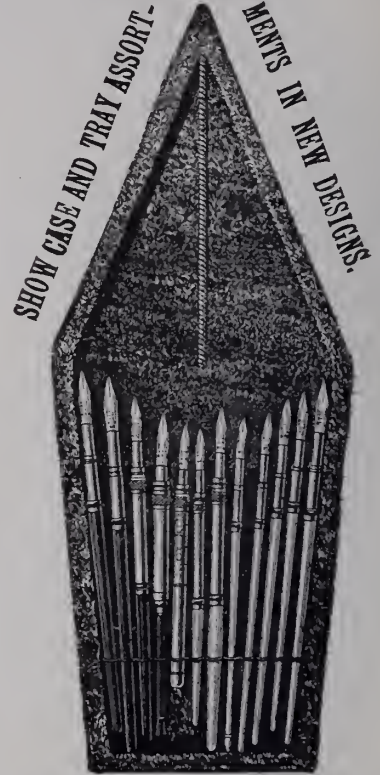

11 x 5 1/2 inches.

PLUSH TRAY WITH EASEL BACK.

1 Doz. 16 K. Pens and Assorted Holders, List, \$30.  
 1 Doz. 10 K. Pens and Assorted Holders, List, \$24.  
 Send for Trade Discount.

**OPTICIANS' SUPPLIES**  
 Jobbing and Prescription Work.  
 The "Graduate" Trial Cases, 180 lenses, \$30.00; 375 lenses set, \$37.50. The "Standard" Trial Cases, 220 lenses set, \$65.00. All with rings. Loring Ophthalmoscope, \$9.00. Artificial Eyes, for selection, \$1.00 each, \$50.00 per hundred. Ophthalmometers, \$50.00 to \$70.00. Queen's Standard Perimeter, \$18.50. Queen's Lens Grindin' Outfit, \$3.00. Steel Frames, 15 to 60 cents each. Spherical Lenses, 35 cents per pair. Cylinders, 35 cents per pair. Lenticular Rificials, 81 cents per pair, (all broken). Nose pieces, Gold or Shell. German Silver, \$1.00 per dozen pairs. Gold, \$2.00 per dozen pairs.  
**QUEEN & CO.,** Opticians and  
 Catalogue free, 1010 Chestnut St., Phila., Pa.



AMERICAN RAILWAY SUPPLY CO.  
 24 Park Place, NEW YORK.

For **BADGES AND MEDALS.**

Flag Pins, Class Pins, Class Rings  
 and Special Work of all Descriptions.  
 SEND TO **E. R. STOCKWELL,** MANUF'R.  
 19 John Street, New York.



# The "Pairpoint" MFG. COMPANY

....New Bedford, Mass.

## SUPERIOR SILVER PLATE.

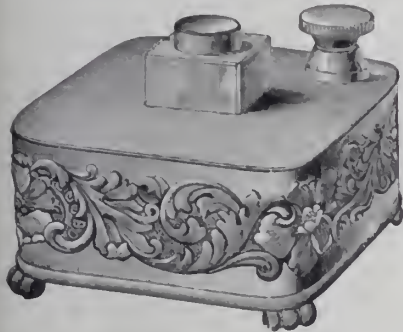

No. 5402, Ink.

**Do Not Fail** to see our Exhibit at Columbian Exposition, Section N, Manufactures Building, and our Store, 224 Wabash Avenue, Chicago.

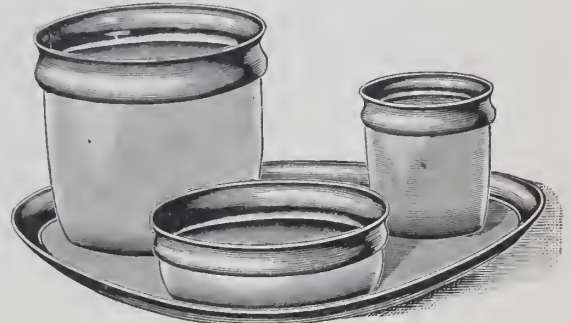

No. 4903, Smoking Set.

### SALESROOMS:

NEW YORK,  
20 Maiden Lane.

CHICAGO,  
224 Wabash Ave.

SAN FRANCISCO,  
220 Sutter Street.



SPECIALTY: SALES OF  
**JEWELRY, BRIC-À-BRAC**  
AND  
ARTICLES OF VERTU

We sell to the legitimate Jewelry and Stationery trade only.



### CHOICE PAPERS

MAKERS OF

## FINE STATIONERY

For Correspondence, Wedding and Business Use, handsomely boxed, specially suited to the Jewelry Trade.

18 MURRAY STREET, NEW YORK.

### Brunor Plating and Jewelry Rep. Co.

Jewelry Matched and Repaired, Engraving, Chasing and Enameling, Setting, Polishing and Lapping, Battery Gilding and Roman Coloring, Watch Cases Repaired, Polished and Gilded.  
32 Maiden Lane, New York.

# NOVELTIES IN STERLING SILVER



No. 330. MATCH SAFE.



No. 14. PIN BALL.



No. 13. PIN BALL.



No. 325. MATCH SAFE.

Trade Mark.



No. 104. POCKET KNIFE.



No. 102. POCKET KNIFE.



No. 3. COURT PLASTER CASE.



No. 39. CANDLE HOLDER.



No. 800. NAPKIN RING.

## R. WALLACE & SONS MFG. CO., SILVERSMITHS,

NEW YORK,  
3 PARK PLACE.

WALLINGFORD, CONN.

SAN FRANCISCO, 120 SUTTER ST.

CHICAGO,  
86 WABASH AVE.

**Providence Jewelers Show Much Interest in the State Fair.**

PROVIDENCE, R. I., Sept 27.—The seventy-third annual State Fair which closed Saturday was a notable one in more than one respect, and as connected with the jewelry industry of the State marks an era in its history in this vicinity. For the first time in the annals of fairs in this State the jewelers took a great interest in this exhibition, and a number of firms made handsome and creditable displays.

Martin L. Read's famous stallion, "Tantallon," was awarded a first premium.

J. A. Foster & Co. occupied a large space devoted to the display of useful and ornamental articles of jewelry and silverware. Conspicuously displayed in the booth of this firm was an immense gilded wooden watch chain, illustrative of the products of Hamilton & Hamilton Jr.

Henry C. Whittier & Son had a prettily draped booth, which was devoted to their "Matchless" silver polish. The colors used in decorating were pea green and red, the two blending together very artistically.

William L. Ballou & Co. had a booth draped in light yellow, pink and white muslins, wherein was displayed a choice collection of sterling silver novelties which found a ready sale.

Ulysses Racine, designer and engraver, 151 Pine St., had on exhibition a beautiful collection of monograms, crests, etc., in filigree, bas-relief, etchings, bright cut, etc.

Fred H. Cole made a neat display in the cheaper grades of jewelry that found many purchasers.

Charles G. Bloomer's Sons, Pawtuxet, under the name of the Aluminum Novelty Works, had a large display of attractive goods made from aluminum. This display was the only one of its kind in the fair and attracted considerable attention, many people on this occasion seeing the metal for the first time. The firm enjoyed a good business, many purchases being made as souvenirs of the fair. Among other things which Messrs. Bloomer exhibited was a line of aluminum horse shoes. William and Charles Bloomer Jr. were in charge.

Nelson S. Davis, traveler for B. S. Freeman & Co., Attleboro Falls, was assistant superintendent of the extensive poultry department.

William Loeb & Co. had an attractive display of metal finger rings warranted to wear for three years; also a large line of collar buttons and general jewelry.

Irons & Russell showed a full line of gold and plate emblems, sporting medals, secret society pins, buttons and badges, working jewels for Masonic lodges, etc., the gold goods predominating by reason of the limited space allotted them. They had a large sale of the official souvenir medal of the Fair which was made in bronze, gilded white metal, or aluminum. The obverse bears the figure of Ceres and various agricultural emblems, with the words, "73d

**BIPPART & CO.**  
 MANUFACTURERS OF  
**DIAMOND JEWELRY**  
 NEWARK, N. J.

BROOCHES,  
 SCARF PINS,  
 HAT PINS,  
 HAIR PINS,  
 EARRINGS.

LINK BUTTONS,  
 CUFF PINS,  
 BRACELETS,  
 NECKLACES,  
 RINGS.

NEW YORK OFFICE 19 MAIDEN LANE.

**THE BOWDEN SEAMLESS RING**

IS MADE ONLY BY

**J. B. BOWDEN & Co.,**  
 Makers of Finger Rings of every Description.  
 COR. BROADWAY & JOHN STREET,  
 NEW YORK.

**J. B. & S. M. KNOWLES CO.,**  
 MAKERS OF

**Sterling Silverware.**

FACTORY,  
 Providence, R. I.

SALESROOM,  
 860 Broadway, N. Y.

**O. W. BULLOCK & CO.,**  
 SPRINGFIELD, MASS.  
 Makers of Watch and Jewelry Tools,  
 NEW CATALOGUE NOW READY.  
 Sent on Application. Please Mention this Paper.

**JACOT & SON**  
 IMPORTERS AND MANUFACTURERS OF  
**MUSICAL BOXES**  
 298 BROADWAY, NEW YORK



**ARTISTIC**  
**METAL**  
**GOODS.**

NEW DESIGNS,  
 NEW FINISHES.

Our line of Pitchers, Vases, Tables, Candlesticks, Five O'Clock Teas, Etc., cannot be equaled.

**THE**  
**CELEBRATED**  
**"B & H" LAMP.**

BEAUTIFUL DESIGNS,  
 particularly adapted to the Jewelry Trade.  
 SEE OUR LINE OF  
**TABLE, BANQUET AND PIANO LAMPS**  
 before placing your orders. Send for our Little Book.



**BRADLEY & HUBBARD MFG. CO.**  
 NEW YORK, BOSTON, CHICAGO,  
 21 BARCLAY ST., 160 CONGRESS ST. 88 WABASH AVE.  
 26 PARK PLACE. Factories, MERIDEN, CT.

**"THE BEST BUTTON MADE."**

**THE KREMENTZ**

**IN GOLD** FROM **KREMENTZ & CO.** **ONE** **PIECE** FROM **ALL JOBBERS.** **IN ROLLED PLATE**

**COLLAR BUTTON.**  
**IS THE ORIGINAL ONE PIECE BUTTON.**  
**IS STILL THE BEST AND STILL UNSURPASSED**

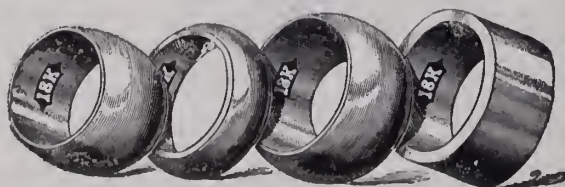

**PLAIN SOLID GOLD RINGS.**  
**HILDRETH MFG. CO.,**  
 53 MAIDEN LANE, NEW YORK.

Annual State Fair, September, 1893, Narragansett Park." On the reverse side is stamped the coat of arms of the State of Rhode Island. The exhibit was in charge of H. M. Tallman.

O. C. Devereux & Co. had a small booth attractively fitted up for the display and sale of a fine assortment of mother-of-pearl novelties, including paper cutters, book marks, collar buttons, salt spoons, etc., the first display of its kind ever seen at the State Fair.

George E. Homer, Boston, Mass., had an elaborate exhibit of jewelry, novelties in sterling silver and souvenir spoons. Among the latter were several new patterns including the Gov. Russell spoon, the Boston Tea Party, the Columbus spoon and the Baby Roger spoon. The latter was well received and a large number sold on account of the allusion to Baby Roger, the baby elephant recently purchased by the children of Providence for Roger Williams Park.

The decorations of Herbert S. Tanner equaled anything of the kind in the building. Delicate tinsel muslins were used to great effect.

The Baxter Optical Co. had a line of fine grade optical goods.

**We Should all Awake, for Abner Kirby is Dead.**

MILWAUKEE, Wis., Sept. 28.—Abner Kirby, one of the old settlers of Milwaukee, died a few days ago. His death had been expected for several days. Two years ago Mr. Kirby fell and broke his arm. The shock was so great to his system that he never recovered.

There were few men better known throughout the country than Abner Kirby. Rough in dress and language, his heart was soft as that of a child. His old motto, "Wake me up when Kirby dies," became almost historic. When a young man just settled in this city and working as a jeweler he placed it on his sign, and it was a trademark until he went out of active business.

Mr. Kirby was born in 1818, in Starks, Me., and learned the jeweler's trade in Bangor. He was in business at Skowhegan, Me., for seven years, and then, in 1844 became a resident of Milwaukee. Not long after his arrival he was made postmaster. In those early days he bought the property at the southeast corner of E. Water and Mason Sts., and here erected a brick building which he occupied for about ten years as a jewelry store. In 1856 he engaged in the lumber business and built a sawmill at Menominee, Mich.

**James E. Tyler Fails After a Long Career.**

RICHMOND, Va., Sept. 27.—James E. Tyler, proprietor of one of the largest jewelry stores in the city, made an assignment Monday morning to John Pickerel, trustee. The liabilities are placed at \$28,000. The deed conveys all of the goods and fixtures



TORTOISE SHELL.

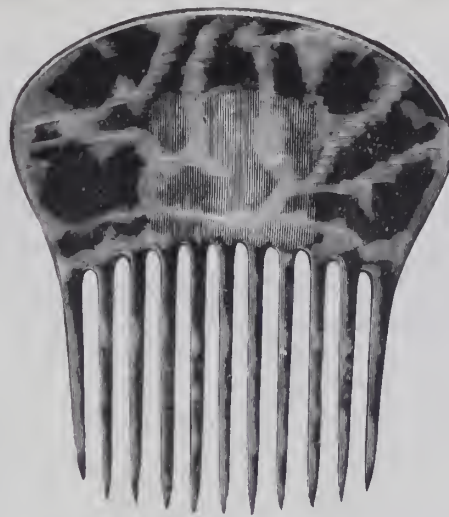

TORTOISE SHELL.



RICE & HOCHSTER,

.... MANUFACTURERS. ....

483 & 485 Broadway,  
NEW YORK.

---NEW STYLES ALMOST DAILY.---

PROGRESSIVE  
PROSPERITY

is indicated when a  
Jeweler carries a full line of

HOLMES & EDWARDS,

SILVER : PLATED : FLAT : WARE.

STERLING SILVER INLAID.

XIV Extra Plate - - - fancy pieces with  
gilt, engraved, or gilt engraved bowls  
and blades.

BEAUTIFUL EFFECTS ARE PRODUCED.

— Salesrooms: New York, Chicago, St. Louis. —

THE HOLMES & EDWARDS SILVER CO., BRIDGEPORT, CONN.

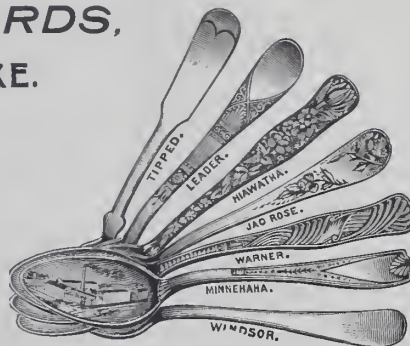

NEW ! IMPROVED NEW !  
Adjustable "Eclipse" Eye Glasses.

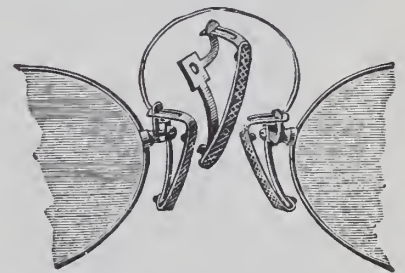

PATENT APPLIED FOR.

We claim this invention to be the only one which com-  
bines the advantages of both the adjustable and offset  
guards. We will furnish these frames or guards by  
Sept. 1st, in either Zylonite or Cork.

WRITE FOR CIRCULAR.

JOHN SCHEIDIG & CO., SOLE AGENTS  
43 MAIDEN LANE, NEW YORK.

VACHERON & CONSTANTIN,  
GENEVA, SWITZERLAND.

FINEST QUALITY OF WATCH MOVEMENTS, FITTING  
ALL SIZES OF AMERICAN CASES.

\* V. & C. \*

CHAS. LEO ABRY,

Agent for the United States and Canada.

41 and 43 Maiden Lane, - - - NEW YORK.



**Aikin Lambert Jewelry Co**  
 Importers of  
**Diamonds**  
 Jobbers in **WATCHES**,  
 Jewelry Chains etc.  
 19 Maiden Lane.  
*New York*

JAMES C. AIKIN, Pres.  
 JOHN B. SHEA, V. Pres.

SAM'L B. MANN, Treas.  
 FRED. D. ILGEN, Sec'y.

**C. SYDNEY SMITH,**

HAS REMOVED TO 191 BROADWAY,  
 New York.

FACTORY:  
 PROVIDENCE, R. I.

Manufacturer of { **GOLD CHAINS,  
 LOCKETS AND CHARMS.**



**The Warren**  
**Eye Protector**

(Patented Jan. 12, 1892, Feb. 21, 1893.)

Saves the Eyes From  
**Dust, Wind, or Glaring Light.**

Folds in a Compact Case, Is  
**Comfortable, Durable,  
 Water and Dust Proof.**

Its large field does not obstruct the sight. No brittle substance to endanger face under sudden blows.

Oculists and Physicians Recommend it.  
 Travelers, Cyclists, Railroadmen,  
 Horsemen, Motormen, Quarrymen,  
 Pronounce it Indispensable for Man or Woman.

Ask your Dealer for it.

Colors, Clear, Smoke, Blue or Green. Black frames, 60c. Silver, 75c. Sent by mail on receipt of price. Manufactured solely by

**The Nous Verrons Company**  
 P. O. Box 3273, Boston, Mass.

in the store, 807 E. Maine St., together with all accounts due the house.

After providing for the payment of the costs of the deed, rent, salaries and lawyers' fees, the deed says Mrs. Anna M. Tyler shall be paid \$15,767.42 for money lent; the State Bank of Virginia for two notes discounted amounting to \$675 and also \$135 amount overdrawn; Robert Wendenburg \$150 money lent.

All other creditors share ratably. The trustee is empowered to sell at public auction or privately, but the business must be closed up within four months.

**J. F. Clark Assigns to Secure all his Creditors.**

ABILENE, Tex., Sept. 28.—J. F. Clark has filed a deed of general assignment, conveying to Abdon Holt, as assignee, his stock of merchandise, real estate, live stock, notes and accounts to secure all creditors. The assets are placed at \$3,365.18, while the liabilities are \$2,941.91.

**A Miniature Geyser in Wm. H. Wilmarth & Co.'s New Building.**

ATTLEBORO, Mass., Sept. 29.—The large cast iron pipe supplying water to the new factory of W. H. Wilmarth & Co. burst shortly after 5 o'clock yesterday afternoon. Before a key could be secured to shut off the water at the main, the basement floor was flooded to the depth of four to five inches. A large invoice of paper boxes in the direct track of the deluge, was reduced to a mass of pulp and paper. Shafting, tools, and piping on the floor were submerged, and more or less damage was done in several of the lower work rooms.

When the geyser was finally shut off it was seen that the connection between the end of the main and the water pipes in the building had been made by simply inserting a smaller, perfectly smooth piece of pipe, and caulking the joint with lead. The pressure of the water on an elbow simply pulled the smooth pipe out. The miniature geyser lasted fifteen minutes.

In a fire last week in Perry, Ia., the store of M. H. Overholser, was burned out with a loss of \$6,000; insurance, \$3,500.

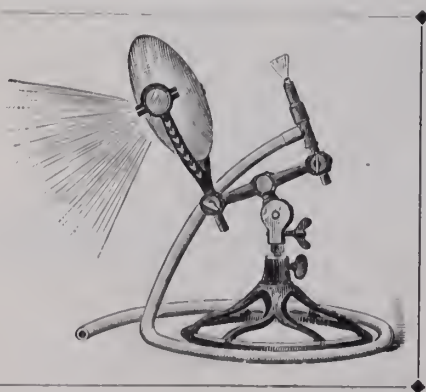

**F. W. GESSWEIN,**

39 JOHN STREET, NEW YORK.

**ENGRAVERS' REFLECTORS**

FOR OIL OR GAS, SINGLE OR DOUBLE.

The Glass Reflecting Globe magnifies and concentrates the light, and can be adjusted to cast it on any desired point.

..... Circulars and Price Lists on Application .....

# EBONY AND SILVER TOILET ARTICLES.

IN NEW AND ELEGANT  
COMBINATIONS.



AS this combination is to be very fashionable this season, we have produced the most elaborate line on the market in Ladies' and Gentlemen's Toilet and Manicure Articles. These goods are mounted with pierced Sterling Silver, and decorated by the most artistic hand engraving.

A full line of these goods will make a beautiful window display. Send for samples.



**MADE IN**

- |                         |                        |
|-------------------------|------------------------|
| HAIR BRUSHES.           | SHOE AND BUTTON HOOKS. |
| MILITARY BRUSHES.       | NAIL POLISHERS.        |
| CLOTH BRUSHES.          | POWDER AND PUFF BOXES. |
| HAT BRUSHES.            | NAIL POWDER BOXES.     |
| BONNET BRUSHES.         | SHOE HORNS.            |
| GENTLEMEN'S COMBS.      | NAPKIN RINGS.          |
| LADIES' COMBS.          | PAPER CUTTERS.         |
| ROUND AND OVAL MIRRORS. | HAND BLOTTERS.         |
| WHISK BROOMS.           | NAIL FILES.            |
| PIN TRAYS.              | CORN KNIVES, etc.      |

**J. N. PROVENZANO,**

GOLD AND SILVERSMITH,

No. 39 UNION SQUARE.

NEW YORK CITY.



HENRY C. HASKELL,



11 JOHN STREET,

NEW YORK.



Gold or Silver.

Samples sent on approval.  
"PREPAID."



Welded Chrome Steel and Iron

5 PLY

FOR BUILDING

Jewelers' Safes, Vaults, Etc.

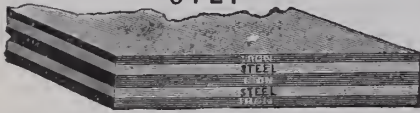

Positively BURGLAR PROOF, cannot be Cut, Sawed or Drilled.

WE are the only manufacturers of Chrome Steel in the United States.  
None genuine unless stamped with our Trade Mark.

**CHROME STEEL WORKS,**

KENT AVENUE, KEAP AND HOOPER STREETS, BROOKLYN, N. Y.



YOU CAN MAKE MONEY By Putting in a Handsome Assortment of

**FINE POCKET CUTLERY.**

We are agents for the SOUTHWINGTON CUTLERY CO.'S Celebrated RAZORS and POCKET KNIVES.

SEND FOR AN ASSORTMENT.

H. B. BEACH & CO., - 418 Washington St., Boston, Mass.

Henry Goll & Co.,  
WATCH CASE MAKERS

AND

REPAIRERS.

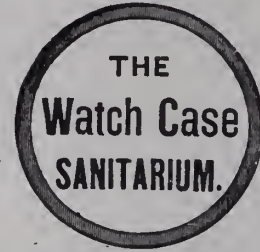

The fact that we are constantly making New Cases to order, gives us

Facilities to do a General Line of Repairing possessed by No Other Repairing Establishment in this city. Hence we can finish all such work quickly, well and at reasonable figures.

ESTABLISHED 1837.

GEO. O. STREET & SONS,

MAKERS OF

Fine Rings, Locketts, Seals,

Sleeve Buttons and Links,

15 John Street, NEW YORK.

**HENRY FERA,**  
IMPORTER OF DIAMONDS

AND DIAMOND BORTZ.

Diamond Cutting and Polishing Establishment,  
10 Maiden Lane, NEW YORK.

“CROMWELL”

Is the name of the new Spoon and Fork Pattern W. B. DURGIN is placing on the market this Fall.

This house produced the ORIGINAL “LOUIS XV.” and “WATTEAU.” Everybody in the trade knows of THEIR success. CROMWELL is pronounced the peer of anything the CONCORD FACTORY has done.

It is good taste, the die work is perfection, the finish is simply what the trade has grown to expect in “DURGIN'S GOODS.”

CROMWELL will be illustrated in these pages shortly. The FANCY PIECES, HOLLOW-WARE and NOVELTIES made by W. B. DURGIN are as saleable as his Famous Spoons. PRICES ARE RIGHT.

CHICAGO:

COLUMBUS MEMORIAL  
BUILDING.

W. B. Durgin,

Concord,

New Hampshire.



**Ezra Kelley Celebrates his Ninty-sixth Birthday.**

NEW BEDFORD, Mass., Sept. 26.—Ezra Kelley, the veteran manufacturer of watch and clock oils, and small machines, who is probably the oldest resident of New Bedford, is celebrating his ninty-sixth birthday to-day at his home, 118 Mt. Pleasant St. Mr. Kelley is enjoying comparatively good

wider and more general as years went by. To-day it finds a place in almost every center throughout the world. They have obtained awards in expositions in Philadelphia, Geneva, Paris and last at the World's Columbian Exposition. Mr. Kelley long ago passed the age at which most men cease to work, but he still exercises a vigilant supervision over his business, and, thanks to the efficient management of his son-in-law, the article for which he made a name maintains its high reputation.

Mr. Kelley has crossed the Atlantic five times, visiting many countries. While he has made his business life a success, he has not accomplished it at the sacrifice of other matters that go to make a well-rounded and useful career. Being a birthright Quaker, he was expelled from the Society of Friends for marrying Nancy Simmons, a member of the Methodist Church with which people he was for many years identified. Mr. Kelley was an anti-slavery man of the most radical type, and it was because of his pronounced opinions on this subject that he withdrew from the Methodist Church. It was the action of such men as he that precipitated the separation of this body into two organizations—the M. E. Church North and M. E. Church South. In his later years he has rejoined the church of his father, the Friends' Meeting.

Mr. Kelley married on Jan. 30, 1823, Nancy Simmons, daughter of Allen and Silence Simmons, of Hingham, Mass. This lady died in New Bedford, Dec. 9, 1865, at the age of 71 years. Of the union six children were born, of which two are living, George S. Kelley and Joanna R., wife of John Wing. May 12, 1875, he married Abby S. Ellison, daughter of Abraham and Rebecca Wing, of Sandwich.



EZRA KELLEY.

health in spite of his advanced years and his genial and kindly disposition is a benediction to his many friends. He is a great favorite with the children.

Mr. Kelley was a son of Cyrenus and Jerusha Kelley, and was born in Dennis, Mass., Sept. 26, 1798. When eighteen years of age he left the paternal roof to seek through his own exertion a place for himself in the world. With a natural taste for mechanical achievement, he apprenticed himself to Allen Kelley, South Yarmouth, and acquired his first knowledge in clock making. Two years later he entered the employ of John Baily, Hanover. In 1820 he went to Venezuela, South America, where he started in business for himself. He successfully pursued his avocation for several years in this new field.

In 1838 Mr. Kelley returned to the United States, and established himself in this city, and for more than half a century has been diligently employed in business. His clocks have almost a national reputation, and are to be found in many of the households of New England. When eighty-eight years of age Mr. Kelley made a clock that for finish, style and accuracy, is equal to any that ever came from his hand.

A more important and by far the most profitable invention and discovery of Mr. Kelley was that of a lubricant oil especially adapted for clocks and watches. This article he produced soon after he took up his residence in New Bedford. The superior merits of Kelley's watch and clock oils were quickly appreciated, and their use became

**Silver Mounted Scissors.**

Thirty-two styles and sizes for Manicure, Embroidery, Silk, Library, Grapes, Flowers, Chateaines, Button hole' and various other uses.

Silver mounted Manicure Instruments and Toilet Articles in a large variety of patterns and sizes.



**BACHRACH & FREEDMAN,**

1 & 3 Union Square,

NEW YORK.

**CLEAN JEWELRY SELLS QUICK.**

Quarters' Cleaning Solution removes dirt and tarnish in an instant, makes stock like new and brings up diamond and stone work to a beautiful lustre. Solution can be used over and over. Highly commended by all who use it. Send at once \$1.50 for half gallon with full directions. References.

**W. F. QUARTERS ELECTROPLATER,**  
139 EDDY STREET. PROVIDENCE, R.

**Jules Jürgensen**  
OF COPENHAGEN.

The reputation these watches have maintained for Fifty Years has never been equalled, being made on strictly scientific principles and no expense spared to give the Best results in mechanism and timekeeping qualities.

SOLE AGENTS.  
**John C. Hyde's Sons,**  
NO. 22 MAIDEN LANE.

**Larter, Elcox & Co.**

Manufacturers of Fine Gold Jewelry  
21 & 23 Maiden Lane, New York.



WE ARE READY FOR THE FALL TRADE.

**Rings, Seals, Spring Back Studs.**

GENTLEMEN'S WHITE ONYX BUTTONS AND STUDS.

**"Old English"**

Coffee Spoon.



DESIGN PATENTED.

**Towle Mfg. Co.,**

MANUFACTURERS OF  
**STERLING SILVERWARE.**



NEWBURYPORT: No. 214 Merrimack St. CHICAGO: Nos. 149 & 151 State St.

# THE "FLORALIA"

STERLING 925-1000 FINE.

Charmingly adapted  
for Wedding, Birthday and  
Friendship Gifts.

THE SENTIMENT OF FLOWERS DAINTILY EXPRESSED  
IN ARTISTIC SILVER FORMS.

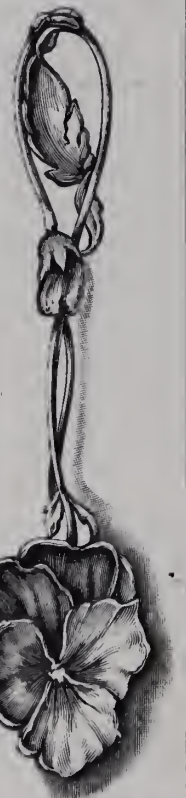
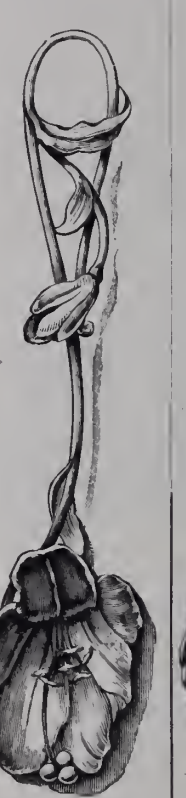
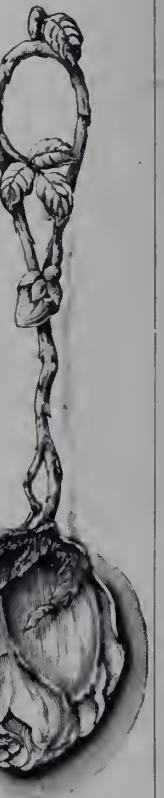
<p><b>MARGUERITE.</b> INNOCENCE.</p>  <p>Of all the flowers in the mead I love the Daisie, white and rede.—Chaucer.</p>	<p><b>CLOVER.</b> INDUSTRY.</p>  <p>Clover, sweet Clover, All the world over. —Old Rhyme.</p>	<p><b>FORGET-ME-NOT.</b> REMEMBRANCE.</p>  <p>'<i>Souviens de moi</i>' (Remem- ber me.) The motto of King Henry IV</p>	<p><b>PANSY.</b> THOUGHT.</p>  <p>And there is Pansies, That's for thought. —Shakespeare.</p>	<p><b>LILY.</b> PURITY.</p>  <p>Have you seen but a bright Lily grow? —Longfellow.</p>	<p><b>ROSE.</b> BEAUTY.</p>  <p>Flowers of all hue and with- out thorn, the Rose. —Milton.</p>
--	---	--	--	--	--

Price \$4.00 a Set of Six Coffee Spoons, Oxidized or Bright.

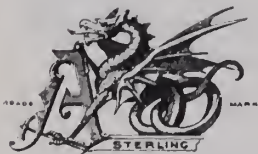

**Alvin Manufacturing Co., Silversmiths,**  
860 BROADWAY, NEW YORK.

Works: IRVINGTON, N. J.



**TO WATCHMAKERS.**—We have on hand a number of Chronometers, by various good makers, not new, which have been in service for purposes of navigation, and are excellent instruments. They have been put in perfect repair, and will give satisfactory results as to performance. We will sell these chronometers at low prices, either for cash, or on accommodating terms to suit special cases, or will hire them at moderate rates, and will allow the hire to apply on purchase. Send for Circular giving prices and terms.

Our Watchmakers' Transits are readily set in position. Printed instructions, easily understood, accompany each instrument, and no preliminary calculations are required. With them correct time can be obtained within one second.

**JOHN BLISS & CO.**

Manufacturers of Marine Chronometers,  
128 Front Street, New York.

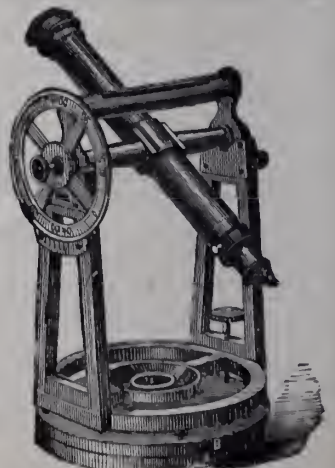

**Charles G. Brown's Store Closed by the Sheriff.**

LOCKPORT, N. Y., Sept. 27.—The jewelry store of Charles Gilman Brown has been closed by the Sheriff. The execution was held by his father-in-law, George W. Weaver, and amounted to \$2,800.

Mr. Brown has been a successful business man for some years and it is thought the reasons of his being closed up are owing to the hard times and the late stringency of the money market.

**Demise of a Former Jeweler of Danville, Va.**

DANVILLE, Va., Sept. 29.—Milton Elmer Roberts, son of S. I. Roberts, superintendent of the Riverside Cotton Mills, died in North Danville, a few days ago of diabetes.

Deceased was engaged in the jewelry business in this city several years ago, but for the past two years had been living in New York. He leaves a wife and two children. The remains have been taken to the old home in New Hampshire for burial.

**A New Chapter in Jeweler Ben Davies' Romance.**

LEADVILLE, Col., Sept. 27.—The wife of Julius Ratbe some time ago fell in love with Ben Davies, a jeweler, who returned her affection. The matter resulted in Mrs. Ratbe securing a divorce from her husband and marrying the jeweler the following day. She retained her children.

Davies' jewelry store caught fire nine months ago, as reported in THE CIRCULAR at the time, and Mr. Davies was burned to death. Mrs. Davies has four children by her first husband and four by her second husband. After the funeral Mr. Ratbe agreed to care for his offspring, and yesterday a reconciliation took place. The wedding followed to-day.

**Nimble Fingered Gum Chewers Foiled in Their Attempt at Theft.**

ST. PAUL, Minn., Sept. 27.—A couple of well-dressed ladies entered the store of Adolph H. Simon last week and desired to examine some loose diamonds. While looking over an assortment of stones one of the women chided the other for chewing gum. The gum chewer removed the wax from her mouth and shortly after a diamond was missing. While the women were suspected the circumstances were such that they could hardly be held, and Mr. Simon concluded to say nothing for the time being.

A search was instituted and purely by accident a searcher who was looking on the floor saw the sparkler in a piece of chewing wax stuck to the bottom edge of the show case. If the women had been arrested and searched, of course no diamond would have been found, but next day Mr. Simon would have been called upon to show goods to the male "pals" of the women, and the gum "plant" would have been secured without suspicion.

**JEWELRY—CASES,  
TRAYS.**

**Jewelers' Findings.  
Chamois Bags.**

**SILVERWARE—CASES.**

**S. & A. BORGZINNER,**  
82 & 84 Nassau Street,  
NEW YORK.

WE HAVE IMPORTED FOR THIS SEASON AN EXTRA LINE OF  
**Fine Silk Velvet Cases.** Our prices are so low that you can buy them in place of Plush Cases.  
Write us for Prices. Samples Mailed Free.



*Our Catalogue No 4 of  
Diamond Ring Mountings is  
ready - it is useful, send for it  
Waterman & Lehmann 37 Maiden Ln  
New York*

**J. H. DEDERICK, JR.,**  
— DEALER IN —  
**Roll Plate Jewelry and Chains,**  
Optical Goods and Jewelers' Supplies,  
**16 MAIDEN LANE, NEW YORK.**  
JET GOODS A SPECIALTY.



Elk, Shrine and Masonic  
Emblems a Specialty.  
Badges of Every Known Order.  
**G. A. SCHLECHTER**  
Manufacturing Jeweler, READING, PA.

# THE "KENSINGTON,"

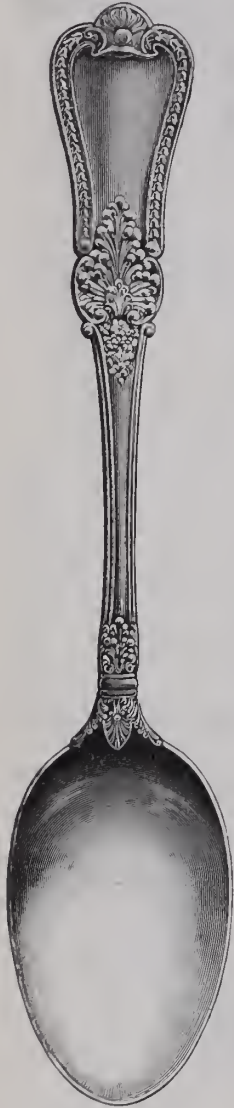

8, 10, 12 oz.



15, 18 oz.



22, 28 oz.



20, 25 oz.



15, 18 oz.

GORHAM MFG. CO., SILVERSMITHS.

# GORHAM SOLID SILVER.

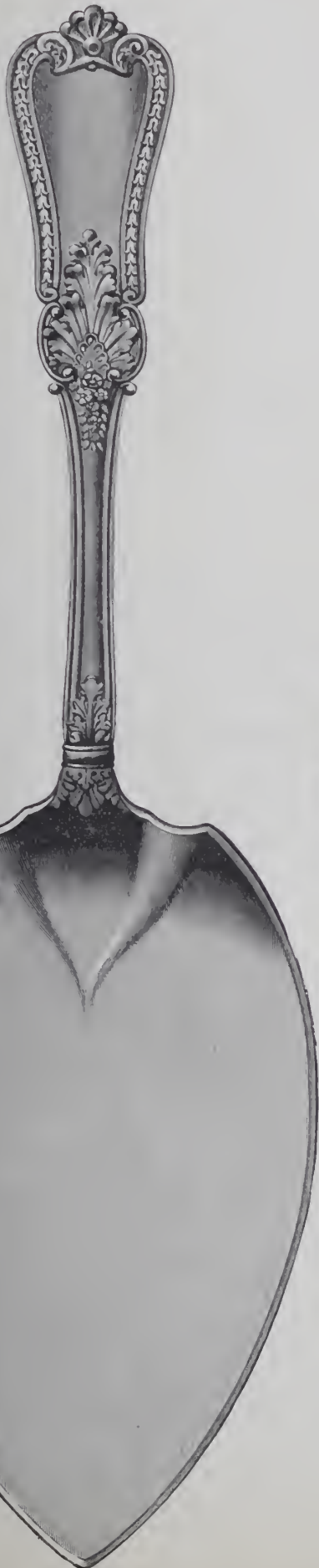

PIE KNIFE.



SUGAR.

## THE KENSINGTON.

This pattern is accepted throughout the country, wherever silver stocks are carried.

It is refined and artistic in design, having the feeling and effect of a very heavy pattern.

The Fancy Pieces, as well as Spoons and Forks, will be found to be the lowest priced articles of flat-ware ever offered, bearing a reputable trade mark.

Combination Chests of all sizes, up to 303 pieces, containing Kensington Ware can be delivered this month.



NEW YORK:  
BROADWAY AND 19TH STREET.  
23 MAIDEN LANE.

CHICAGO:  
137 AND 139 STATE STREET.  
PARIS, FRANCE: 36 AVE. DE L'OPERA.

SAN FRANCISCO:  
118 AND 120 SUTTER STRET.  
WORKS: PROVIDENCE, R. I.

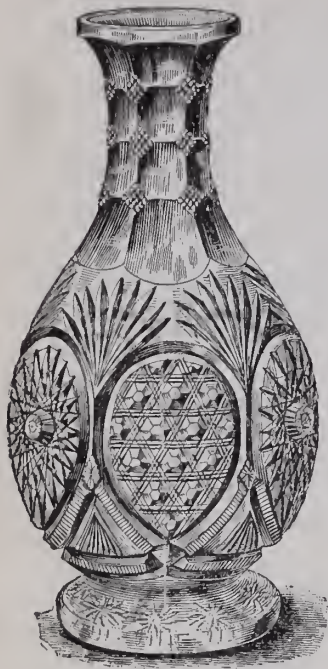

CARAFE, 455 | 53. COLUMBUS.

# Richest

\* \* \* \*

# CUT GLASS

FROM OUR OWN WORKS IN THIS CITY.

None but the Highest Grade in Quality and  
Workmanship.

**LARGEST ASSORTMENT.**

**MOST MODERATE PRICES.**

A LARGE variety of new  
and strikingly original  
shapes and many new cut-  
tings, protected by U. S. Patents.

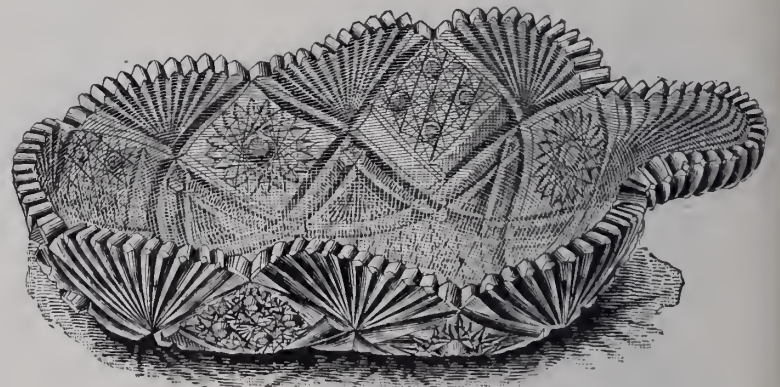

SALAD, 434 | 55. LA RABIDA.



PITCHER, 453 | 58. BRAZILIAN.

## L. STRAUS & SONS,

MANUFACTURERS,

42, 44, 46 AND 48 WARREN ST.,

AND 116 CHAMBERS ST.,

NEW YORK.

See our Exhibit at the World's Fair, in Section H  
of the Manufactures Building.

# The Jewelers' Circular

AND  
HOROLOGICAL REVIEW.

PUBLISHED EVERY WEDNESDAY BY

THE JEWELERS' CIRCULAR PUB'G CO.,

189 BROADWAY, NEW YORK CITY.

A JOURNAL DEVOTED TO THE INTERESTS OF JEWELERS, WATCHMAKERS, SILVERSMITHS, ELECTRO-PLATE MANUFACTURERS, AND ALL ENGAGED IN KINDRED BRANCHES OF INDUSTRY.

Our Editorial columns will contain our own opinions only, and we shall present in other columns only what we consider of interest or value to our readers. Advertising matter will not be printed as news.

Advertising rates in THE CIRCULAR are lower, considering the number of tradesmen reached by this large circulation, than in any other jewelry journal.

Notices of changes in standing advertisements must be received one week in advance; new matter can be received up to Monday.

## INFORMATION FOR SUBSCRIBERS.

### Terms of Subscription, Postage Prepaid.

	PER ANNUM
United States and Canada. . . . .	\$2.00
Foreign Countries in Postal Union. . . . .	4.00
Sing'e Copies. . . . .	.10

New subscribers can commence at any time.

Payments for THE CIRCULAR, when sent by mail, should be made in a Post Office Money Order, Bank Check or Draft, or an Express Money Order or Registered Letter. All postmasters are required to register letters whenever requested to do so.

Pay money only to authorized collectors having proper credentials.

Returning your paper will not enable us to discontinue it as we do not find your name on our books unless your address is given.

In changing address always give the old as well as new one. Your name cannot be found on our books unless this is done.

We will continue to send papers until there is a specific order to stop, in connection with which all arrearages must be paid; but such an order can be given at any time, to take effect at the expiration of the subscription. All such orders will be promptly acknowledged by mail.

The Courts have decided that all subscribers to journals are responsible until arrearages are paid in full and an order to discontinue has been received by the publisher.

Member of the American Trade Press Association.

VOL. XXVII. Oct. 4, 1893, No. 10.

## WINDOW DESIGN CONTEST, NO. 2.

A Prize of \$10.00 is offered by THE JEWELERS' CIRCULAR for the best design for dressing a jeweler's window. The contest is open to all members of the trade, to the clerks, salesmen and others, as well as to the dealers. Following are the conditions:

1. The design is to be submitted as a pencil or other sketch or photograph, from which a finished engraving may be made. The design may be an original conception or a copy of a window already dressed.
2. A brief description is to accompany the design.
3. The design must be appropriate for the Fall and holiday season.
4. Designs for Contest No. 2 must reach us no later than Nov. 1.

**Likely to be a Fair Fall Trade.** ACCORDING to reliable authorities there is no longer only a microscopic improvement in the that cannot be measured. Some increase is seen both in production and in distribution of products. The industries are giving strong proof that consumption of goods was not as much arrested as many feared when the collapse of trade and manufactures came. While manufacturers show caution, improved financial conditions enable them to accept many orders which would have been, or were refused weeks ago, and actual orders are rendered frequent by the exhaustion of retail supplies. Jewelry and kindred lines show increased encouragement and a stronger feeling. The central west, as indicated by travelers' reports, is moderately quiet, Pacific coast trade sluggish, while the north, northwest, south and southwest evince a firmer tone and good business. A more cheerful feeling pervades the entire trade.

**Figures and Facts of Interest.** A CAREFULLY prepared article on the business embarrassments for nine months, in that admirable publication, *Bradstreet's*, discloses figures and facts that should not be passed without notice. During this period there were 11,174 failures, or 51 per cent. more than in 1892, when the total was only 7,378, and 26 per cent. more than in the corresponding period in 1891, the heaviest previous nine months' total of mercantile embarrassments, 8,866. The relative severity of the recent panic in the money market, particularly when compared with the disturbance in May, 1884, is made plain when it is shown that the assets of firms, individuals and concerns reported embarrassed amount this year to 70 per cent. of the total liabilities at dates of failure, an unprecedented showing. During ten preceding years the ratio of assets and liabilities of those reported embarrassed and failing has ranged from 48 to 51 per cent.; in 1884 it was 55 per cent. This difference of ratio, while extraordinary, is easy of explanation. During the periods of panic, or when the money market suddenly becomes and long remains stringent, many who may ordinarily be classed as solvent are forced to the wall and obliged to suspend payments—in many instances practically forced into failure. In the New England States the increase in number of failures in 1893 over 1892 was 26 per cent.; Middle States 18½ per cent.; Western States, 129 per cent.; Southern States, 25½ per cent.; North-western States, 92 per cent.; Pacific States, 21 per cent.; Territories 96 per cent. Of failures having liabilities of \$100,000 or more there were 670 in the nine months of 1893, compared to 121 in 1892, 229 in 1891, 111 in 1890. One reason for the great increase will be found in the enforced suspensions of financial institutions, numbering 300, many of which were really solvent. In

the lines of jewelry and diamonds there were in the nine months of 1893, 12 failures with liabilities of \$1,922,000, compared with 2 in 1892 with \$367,040 liabilities, 2 in 1891 with \$240,000 liabilities, and none in 1890. Some of these failures, especially the diamond firms of New York, who were mutually involved, the suspension of one house causing the failure of at least one other, have been adjusted satisfactorily to the creditors. The jewelry trade was eighth in the list of large failures, and considering the relative extent of the different industries, it doubtlessly suffered more than any with the exception of the banks and bankers.

## The Week in Brief.

HENRY C. WHITTIER & SON, Providence, R. I., made an assignment—Ezra Kelley, the veteran watch oil manufacturer, New Bedford, Mass., celebrated his ninety-sixth birthday—The death of Abner Kirby, once a prominent jeweler of Milwaukee, Wis., was reported—James E. Tyler, Richmond, Va., assigned—Sanford L. Wood, Providence, R. I., was arrested charged with assaulting his wife with intent to kill—J. F. Clark, Abilene, Tex., assigned—A water pipe in the factory of W. H. Wilmarth & Co., Attleboro, Mass., burst—The store of M. H. Overholser, Perry, Ia., was burned out—The store of Charles Gilman Brown, Lockport, N. Y., was closed by the sheriff—The death occurred of Milton E. Roberts, formerly a jeweler of Danville, Va.—Judgments were entered against Augustus Coran, Philadelphia, Pa.—William Lipman, a dangerous thief, was sentenced in Providence, R. I.—Robert Tipping pleaded guilty to robbing Kirby, Mowry & Co., Providence, R. I., his employers, and was sentenced—The business of Fred Wilson, Waukesha, Wis., was seized by the sheriff—The death occurred of Charles Wilfong, traveler for Simons, Bro. & Co., Philadelphia, Pa.—Executions of judgment were issued against C. Edward Eager, Syracuse, N. Y.—Emil Graff, Brooklyn, N. Y., attempted to commit suicide—The creditors of Chas. S. Crossman, New York, held a meeting—Ephraim Grinspan, New York, was arrested charged with obtaining goods by false pretenses—The death occurred of Charles Franks, optician, New York—Two receivers were appointed for Elias M. Pilzer, New York—The C. S. Hook Co., Memphis, Tenn., assigned—The sheriff took possession of the store of Anthony Hessels, New York—The death occurred of Stephen Albro, Providence, R. I.—A meeting of the creditors of M. Fox & Co., New York, was held—The offer of settlement of Charles Seale, New York, was not accepted—The store of W. F. Kirkpatrick & Co., St. Joseph, Mo., was damaged by fire—The annual meeting of the Retail Jewelers' Association of Alabama, was postponed.

### New York Notes.

Sam. Stern, of Sam. Stern & Co., returned Sunday from his trip to the World's Fair.

S. F. Myers & Co. have entered a judgment for \$1,425.49 against Elias M. Pilzer.

David Van Moppes has entered a judgment against Louis Borneman for \$199.16.

Max Freund, of Max Freund & Co., returned Sunday, from his visit to the World's Fair.

J. N. Provenzano leaves Saturday on a two weeks' business and pleasure trip to Chicago.

The Meriden Britannia Co. have entered a judgment for \$2,748.87 against Remington Vernam.

The James Jewelry Co. have removed from 245 Broadway, to the Havemeyer Building, Certlandt and Church Sts.

Stern Bros. & Co. have commenced work in their diamond cutting establishment, 29 Gold St., with a full force of hands.

M. B. Bryant, of M. B. Bryant & Co., who has been spending the Summer at his home in the Berkshire Hills, returned to his office Friday.

The sheriff last week closed the jewelry store of Rudolph Deutsch, 72 Ave. D. on an execution for \$841, in favor of Nathan Heimlich.

Samuel Cohn, assignee of Alexander Davidoff, 85 Nassau St., places the insolvent's liabilities at about \$15,000, and his assets at about \$4,000.

Adolph Goldsmith & Son have consummated a settlement with all their creditors and resumed business. Their property was reassigned to them Sept. 26th.

E. B. Hayden has given a chattel mortgage on fixtures to F. E. Leimbach for \$1,330, and another to Hayden W. Wheeler & Co., on tools and machinery, for \$829.

Emil Graff, who is said to be a watchmaker, at 218 Johnson Ave., Brooklyn, jumped into the East River, Thursday, from the deck of a ferryboat. He was rescued.

E. E. Kipling, 182 Broadway, has consummated a settlement with his creditors and will resume business as soon as the papers formally dismissing the receiver have been entered.

J. F. Fradley sailed for Europe Saturday on the *Campania*; C. J. Ahrenfeldt, of Chas. Ahrenfeldt & Son, and J. Redon, Limoges, France, left the same day on *La Bourgogne*.

De B. O. Scott, who has been in the auction business for the past seven years, is now located at 347 Fifth Ave., this city. He makes a specialty of selling watches, bronzes, bric-à-brac, etc., in which lines he has conducted many very successful sales.

Judge Pryor, of the Court of Common Pleas, has extended the time in which Louis Engel, assignee of S. Lyons & Son, is given to file his schedules of the assigned estate, to thirty days from Sept. 28th.

James Brennan, a fifteen-year-old boy, was arrested last week on the charge of stealing a diamond from the jewelry store of Henry J. Bridger, 478 Fulton St., Brooklyn. He claimed that the stone was found and not stolen.

H. Didisheim, wife and child, New York, arrived from Europe Sunday on *La Bretagne*; J. H. Crosby, of Greenleaf & Crosby, of Jacksonville, Fla., arrived on the *Umbria*; B. Freund, New York, arrived on the *Berlin*.

Siegfried Brinkman was on Friday appointed by Judge Van Wyck of the City Court, receiver in supplementary proceedings, for Elias M. Pilzer, 97 Clinton St., on the application of Alois Kohn & Co. The same day in the Supreme Court, Wm. H. Ricketts was also appointed receiver for Pilzer on the application of S. F. Myers & Co.

At the meeting of the creditors of Charles Seale held at 320 Broadway, Thursday afternoon, the committee consisting of Chas. Kuhn, Jr., John R. Keim and M. D. Rothschild, appointed at the previous meeting, reported unfavorably upon the offer made by Mr. Seale of fifteen per cent. unsecured, and it was the sense of the meeting that the offer be not accepted.

Prof. Charles Franks, a well known optician, of 310 Grand St., died at his residence Wednesday, aged seventy-three years. He was born in Manchester, England, in 1820. His father and grandfather had been oculists, and he was apprenticed in his father's shop. In 1836 he started in business in New York as an optician. The deceased leaves a wife and five children. The funeral services took place Thursday.

The sheriff last week took possession of the jewelry store of Anthony Hessels, 1275 Ninth Ave., on executions amounting to \$10,572.95 in favor of Henry Fera. Mr. Fera's judgment which was entered Thursday was obtained on notes given by Mr. Hessels in payment for goods prior to his failure which occurred Dec. 15, 1888, when he assigned to Franklyn Bien. His liabilities were then \$67,000. No settlement was effected with the creditors.

A meeting of the creditors of M. Fox & Co. was held at the office of that firm, 1 Maiden Lane, Monday afternoon. A new proposition of settlement was submitted and was generally accepted. It is as follows: 5 per cent. cash, 10 per cent. in six months, 15 per cent. in twelve months, and 10 per cent. in eighteen months; or 30 per cent. secured, in equal payments in six, twelve and eighteen months. Some of the creditors have agreed to the former and some to the latter proposition.

The Middletown Plate Co. have obtained a judgment for \$1,196.36 against William Belden.

About twenty-five creditors of Chas. S. Crossman, 19 Maiden Lane, met in the rooms of the New York Jewelers' Association, on Friday afternoon, to hear the offer of settlement proposed by the insolvent. The offer was 20 per cent. in four equal

instalments payable in three, six, nine and twelve months. Creditors whose claims amounted to less than \$50 were to be paid in cash in three months. An agreement embodying this proposition was drawn up, and is now being circulated among the creditors.

James Alexander, an old man who makes a business of selling jewelry on commission, on Feb. 8, 1892 obtained two gold chains on memorandum from A. Wallach & Co. As he neither returned the chains nor paid for them, the firm instituted a suit in the 11th District Court for \$57, the amount due. When the suit was tried last week the Judge gave judgment against Alexander, and on account of fraud being a part of the charge the judgment carried with it liability to imprisonment; but the defendant was given three weeks in which to pay for the chains, or else be sent to prison.

The failure of Mrs. Ephraim Grinspan which was announced in THE CIRCULAR last week was the cause of her husband's appearance as a prisoner in the Yorkville Police Court on Friday to answer to the charge of obtaining about \$500 worth of diamonds by false representations. Durlach Bros., 41 Maiden Lane, the plaintiffs, claimed that the accused obtained the diamonds from them in August upon a written statement in which he said he had about \$8,000 over and above all liabilities and that he only owed about \$1,400. Grinspan's store was closed out on a chattel mortgage, Sept. 16th, and then Durlach Bros. had him arrested. The defendant's attorney submitted a brief and the Justice reserved his decision.

### One of Benj. F. Spink's Stores Boldly Burglarized.

One of the most cool and daring robberies that has been committed in New York in many years was perpetrated in Benjamin F. Spink's jewelry store, 359 Sixth Ave., early last week. On the morning of Tuesday, Sept. 26, when Mr. Hickman, manager of the store, opened the place for business, he noticed that the cellar door, which is directly under the show window, was open. When he entered the store he discovered that the three large showcases along the south side of the store had been emptied of their contents, and that everything in the show window together with the finished and unfinished repair work had also been taken. The safe had not been tampered with.

An examination disclosed the fact that in the space between the window and the floor a hole about two feet square had been bored and through this aperture the burglars had gained access to the store. The police were immediately notified and detectives are now at work on the case.

The value of the stock stolen amounted to about \$2,000. The full value of the jewelry left for repairs has not yet been ascertained.

John Tebbetts & Co., jewelers, Bangor, Me., have gone into insolvency.



Solid Silver  
Exclusively.



WHITING M'F'G Co.

SILVERSMITHS,

Broadway & 18th Street,

NEW YORK.

WORKS--AT FOURTH ST. AND LAFAYETTE PLACE.

### Henry C. Whittier & Son Make an Assignment.

PROVIDENCE, R. I., Sept. 29.—The announcement this morning of the assignment of Henry C. Whittier & Son to Robert S. Burbank, attorney-at-law, created considerable of a sensation in jewelry and business circles generally. The firm were the second largest dealing in jewelry and diamonds in this State, their store being prettily located at 327 Westminster St., where they carried a large and valuable stock. The liabilities are estimated at between \$50,000 and \$75,000, while it is believed that the assets will amount to fully twice that.

Henry C. Whittier is one of the best diamond workers in this country and has been prominently identified with diamond mounting in this city during the past quarter of a century. He was for about ten years, as employe and partner, connected with the well known concern of Cahoon, Alexander & Co. In October, 1884, he started in business for himself in a modest way and has steadily increased it until about a year ago, when he admitted his son, Ira G. to the firm and shortly afterwards removed to the commodious location which the firm now occupies.

In speaking of the assignment to-day Mr. Whittier said: "The failure is due to the stringency of the money market and the dull trade since January. The assignment was made as a matter of protection, there being no law in this State which gives a firm an extension of time in meeting notes or claims due. The assignment was due to two things—First, as every business man is well aware, and particularly those in the jewelry business, the year 1893 has been one of the very worst from a business point of view. It affected us as it did others. Then the house went to a heavy expense in moving into new quarters. The principal cause, however, was due to the suspension of the State Bank, of this city, which closed its doors in July last. On the morning that the bank suspended the firm deposited \$1,150 there, and within six weeks the house was called upon to make good some \$17,000 with which the firm had been accommodated by the bank."

This reduced the ready capital in the firm's possession, and as several obligations were to be paid during October, the cash was not forthcoming, and Ira G. Whittier, the junior member of the firm, consulted the largest creditors who are in New York. He presented the case as it was, and they realizing that an attachment would materially injure the business, advised him to make an assignment. The creditors said they would do all they could to assist the firm, and the business, it was said this morning, will be continued as formerly.

Mr. Whittier could give no figures at present as to the exact amount of the assets and liabilities, but said "that the business would be continued and affairs straightened out as soon as possible, and we believe that Jan. 1, 1894, will see us again on a solid footing. Assignee Burbank is now preparing a statement of the firm's condition.

About three-fourths of the firm's debt is held by Carter, Sloan & Co., Ludwig Nissen & Co., and E. Aug. Neresheimer & Co.

An official of the State Bank when interviewed with reference to the Whittier failure denied that his institution was in any way responsible. He states that at the time the bank closed its doors the embarrassed firm had not more than \$100 on deposit.

Regarding the above statement Ira Whittier, said this afternoon: "Indirectly the cause of the assignment was the collapse of the bank; directly it was not. That is, at the time of the bank's trouble, we were compelled to pay out a considerable amount of our capital to make good accommodations extended by banks. The bank people have treated us very fairly, and to-day they are practically square with the house. The assignment must be attributed largely to the hard times."

Robert W. Burbank, assignee of Henry C. Whittier & Son, has called a meeting of the creditors of that firm for this afternoon at the rooms of the New York Jewelers' Association, 146 Broadway. The assignee,

and it is expected one of the firm, will be present to confer with the creditors.

### The Death of Charles Wilfong.

PHILADELPHIA, Pa., Oct. 2.—On Thursday, Charles Wilfong, one of the best known of traveling jewelry salesmen, died at North Wales, a few miles from this city. He entered the service of Simons, Bro. & Co., when a boy, and steadily advanced himself until he occupied the position of one of the firm's most trusted representatives on the road.

Deceased was but thirty-eight years of age, and his death was due to a complication of diseases. The funeral services will be held at his late home in North Wales to-day. Among the floral tributes was a magnificent piece sent by the Brotherhood of Jewelry Travelers from New York. The interment was private.

### Executions of Judgments Against C. Edward Eager.

SYRACUSE, N. Y., Sept. 30.—About six o'clock Wednesday evening the store of C. Edward Eager was closed by Deputy Sheriff Bennett on executions issued on several judgments filed at the County Clerk's office. There were six confessed judgments as follows:

Bank of Syracuse, \$4,547.60, amount due for discounts extending over a period of several months; William H. Niven \$1,628.58, amount of two loans, one on July 20th last for \$200 and the other on September 26th for \$1,410;—the balance being due for interests and costs; William H. Niven, as executor of the estate of Amelia D. Niven, \$1,060.58, amount of a note given for money loaned on June 17th, 1891; Edmund A. Hudson, \$320.58, for money loaned on July 1st, 1893; Charles N. Hatch \$167.38, for money loaned, and Seymour Harvey for \$120.33 for money loaned.

Mr. Eager was for twelve years with different jewelry firms of this city, and in 1885 began business for himself. The financial depression following a very dull season is responsible for the failure. On Sept. 17th, Mr. Eager began an auction sale for the purpose of realizing money sufficient to meet pressing obligations, but was unsuccessful. The assets will cover the liabilities, it is thought.

### Booty of Train Robbers Recovered.

LAPORTE, Ind., Sept. 29.—The firm of C. F. Lefman & Co., of this city, to-day received a consignment of jewelry valued at \$1,900, which had been stolen from the Lake Shore passenger train, in the robbery at Kendallville. The plunder was found in the possession of a couple at Syracuse, N. Y., and their discovery may prove an important link in apprehending the robbers.

Jacob Schissler was in Salt Lake City, Utah, last week from southeastern Utah and Arizona. He is an old prospector, and had a little sack of 500 rubies, which he says he found in the San Juan country.



SEND TO  
**J.T. Scott & Co.**  
 4 MAIDEN LANE,  
 NEW YORK.

### Awards for Exhibits Interesting to the Jewelry Trade.

CHICAGO, Ill., Oct. 2.—Awards were announced Sept. 27th by John Boyd Thacher in Group 151, including instruments of precision, experiment, research, photography and photographs. Awards of interest to the jewelry and kindred trades were as follows:

- Seth Thomas Clock Co., astronomical clocks.  
 Geneva Optical Co., optical goods.  
 F. A. Hardy & Co., optical instruments and apparatus.  
 Self-Winding Clock Co., self-winding astronomical regulators.  
 J. H. Gerry, astronomical regulators.  
 H. H. Heinrich, marine chronometers.  
 T. H. McAllister, stereopticons, magic lanterns, etc.  
 United States Coast and Geodetic Survey, one-half second pendulum, engraving machines, etc.  
 John A. Brasheur, telescopes, spectroscopes, etc.  
 Fauth & Co., telescopes, astronomical and geodetic instruments, etc.  
 Gundlach Optical Co., photos, lenses, microscopic goods, microscopic stands.  
 Bausch & Lomb Optical Co., optical goods.

#### FOREIGN.

- Schott & Gen, Jena, optical glasses.  
 Bernhard Halle, Steglitz, optical apparatus.  
 Doerrfel & Faerber, Berlin, ophthalmological instruments.  
 Deutsche Gesellschaft, Berlin, instruments of precision.  
 Lorch, Schmidt & Co., Frankfort, works for watchmakers.  
 Hilmar Boch, Oberweissbach, artificial eyes, etc.  
 Voigtlaender & Son, Gothingen, telescopes, lenses and field glasses.  
 Riley Bros., Bradford, optical lanterns and slides.  
 Ross & Co., London, lenses, field glasses and instruments of precision.  
 Esmail Enamel Co., London, miniatures on enamel.  
 Richter, St. Petersburg, optical apparatus.  
 G. W. Linderth, Stockholm, chronometers.  
 Falk (Edwards), Madrid, optical instruments.

Awards were officially announced Friday in Group 99, Department of Manufactures, including watches, clocks, etc. The awards are as follows:

#### UNITED STATES.

- Ansonia Clock Co., clocks.  
 Newman Clock and Manufacturing Co., mechanical watchman's clock.  
 Self-Winding Clock Co., automatic time signal clocks, sub-master clocks, self-winding marine striking movement, self-winding synchronizing clocks, self-winding clocks, method of time distribution by electricity, electric chimes in clock tower.  
 Tiffany & Co., watch cases, clocks, astronomical time keeper.  
 Bundy Mfg. Co., Binghamton, N. Y., automatic time recorder.

The Waterbury Watch Co. artistic display, general exhibit, century clock, duplex watches.

American Waltham Watch Co., watch movements, watch machinery, decorated watch dials, mainspring, magnetic watch movements, collective exhibit of watch movements and machinery, Breguet hair-springs.

Washburn & Moen Mfg. Co., Worcester, Mass., watch movements and parts of watches, watchmaker's tools and machinery in parts.

Keystone Watch Case Co., gold filled, rolled plate, silver, and silveroid watch cases, non-pull-out bow for watch cases.

H. Muhr's Sons, watch cases.

#### FOREIGN COUNTRIES.

*Switzerland* (for watches) — Eugene Clemence Beurret, La Chaux de Fonds; F. Borgel, Geneva; Alcide Baume, Les Bois Canton, Berne; L. Bachmann, Geneva; Borel & Courvoisier, Neuchatel; Paul Matthey Doret, Le Locle; Gindrat Delachoux, La Chaux de Fonds; Albert Didisheim Frères, St. Imier; Maurice Didisheim, La Chaux de Fonds; C. Degallier, Geneva; Ernest Francillon & Cie., St. Imier; Piguët, Guilleme & Cie., Le Sentier; Arthur Graizley, La Ferriere; J. Alfred Jurgensen, Le Locle; G. Jeanneret & E. Kochen, La Chaux de Fonds. Albert Jeanneret & Frères, St. Imier; Jacoby & Cie, Geneva; Droz-Jeannot Fils, Les Brenets; Klingelfuss Fr., Basle; Marius Lecoultré, Geneva; A. Goflay, Leresche & Fils, Geneva; Ch. Coulern-Meuri, La Chaux de Fonds; Paul D. Nardin, Le Locle; Z. Perrenoud & Fils, La Chaux de Fonds; Louis Rozat, La Chaux de Fonds; H. Redard & Fils, Geneva; Fred Julian Sagne, La Neuveville; Willeumier Frères, Renan; Weill & Cie. La Chaux de Fonds; Zentler Freres, Geneva; P. Brunner-Gabus, Le Locle; Droz & Cie, St. Imier. Miscellaneous: Boulanger, Mailard & Co., Geneva, watch dials; Baehni & Co., hair springs; P. Guye & Cie., Geneva, hair springs; Grobet Freres, Vallorbes, files; A. Herzog, Geneva, mainsprings; L. E. Junod, Lucens, jewel hole stones; Ch. Dufaux, Geneva, hair springs; Vautier et Fils, Geneva, files and tools; Morte & Meroz, Geneva, watch dials; C. A. Millet, Geneva, mainsprings; Ulysse Perret, Renan, mainsprings; Richardet Frères, La Chaux de Fonds, watch hands; Ch. Schweingruber, St. Imier, mainsprings; J. Marc Servet, Geneva, files and tools; Tschumi Fils, Geneva, brushes; J. Wyss Fils, La Chaux de Fonds, dials and enameled articles; Wagnon Frères, Geneva, watch hands; Borloz Noquet Borloz, Vallorbes, tools and files; C. & E. Leisenheimer Frères, Geneva, hands.

*Spain*—Guzasola & Goviola, Madrid, damascene steel watch case.

*Germany*—Joh. B. Beha & Sohne, Eisenbach, cuckoo clocks, cuckoo clocks with musical works, Frederick Dick, Esslingen, files and tools for watchmakers; Dürstein & Co., Dresden, novelties in

watch works and cases; J. N. Eberle, & Co., Augsburg, collection of watch springs, collection of saws, files, etc.; Ette & Mischke, Berlin, manufactory of house clocks; Furtwaengler & Sors, Furtwagen, house clocks; Theodore Hahn, Stuttgart, electromagnetic clock; Joseph Hoefler, Eisenbach, wall clocks; J. Jagemann, Munich, fine household clocks, decorative clocks; Jahresuhrenfabrik, Friberg, clocks; Junghaus Gebruder, Schramberg, clocks; A. Lange & Sonne, Glasshütte, near Dresden, watches in gold and silver cases, watch works, parts of cases; Frederick Manthe, Schwengingen, Black Forest clocks; Frederick Pfahrer, Friberg, carved clocks, carvings; R. Schneckenberger, Mulheim, wall clocks; J. C. Schweizer, Munich, clocks; Aug. Schwer, Friberg, various small clocks finely executed; Gustave Speckhart, Mogelsdorf, Oberammergau clock; E. Wehrle, Furtwagen, wall clocks; F. H. Wildemauer, Munich, clocks of various kinds; Winterhalder & Hofmeier, Neustadt, clocks striking every quarter hour; Lorch, Smith & Co., Frankfort, watchmakers' tools; Cl. Riefler, Munich, astronomical clocks; W. Dieckmann, Celle, geographical astronomical clocks; Gedon, Munich, table clock tower carried by walking deer; F. Pecher and A. Gehrig, Karlsruhe, Schwartzwald clock presented Emperor Wilhelm I.; A. Gehrig and B. Hammer, trumpeter clock, property of Grand Duke Frederick of Baden; Maurer & Hoffer, Eisenbach, fancy bracket clocks.

*Russia*.—N. N. Makarovsky, City Ufa., apparatus for control.

*Sweden*.—Halda Watch Mfg. Co., Svangsta, telecrox (apparatus for telephone); C. W. Linderth, Stockholm, clocks, pendulum clocks, carved, in gilt and porcelain cases.

*Great Britain*—London, J. H. Smith & Sons, bells, chimes, clocks; Goldsmiths' and Silversmiths' company, sea chronometers, watches.

*Denmark*—Bertram Larsen, tower clock.

*New South Wales*—Marcus Benjamin, Sydney, watch with one movement.

The exhibit of Patek, Philippe & Co., of Switzerland, was withdrawn from examination. A few exhibits in this group are not yet reported on and will be announced later.

A paper has been sworn to before a notary public and filed with the Bureau of Awards protesting against the awards given by Dr. A. Westphal to exhibitors of microscopes. Not a microscope but those of German make received an award, such fine instruments as are shown by the Geneva Optical Co., Bausch & Lomb Optical Co., Ross & Co., Watson and Beck being ignored. This is a logical outcome of the one-judge system of making awards.

H. D. Cone & Albright, Cedar Rapids, Ia., have been succeeded by The Cone Co.



## Our Traveling Representatives

Traveling representatives may consider these columns open for the publication of any news or items of interest regarding themselves or their confreres.

**F. H. WALKER**, for J. N. Provenzano, New York, who lately returned from a successful trip through the south, started again for the same territory Saturday.

E. Levy started Tuesday on a six weeks' trip through the entire west and south for Sam. Stern & Co., New York.

George N. Rouse, traveler for the Geneva Optical Co., left for the southwest the past week and reports trade good in his section.

George T. Bynner, for the Wymble Mfg. Co., left Tuesday week for a two weeks' business trip to Pittsburgh, Buffalo, Cleveland, Detroit and Cincinnati.

Chicago jewelers are said to be waiting to give Harry Schimpf, of H. Muhr's Sons, Philadelphia, a hearty reception on his arrival in the city this week. Quarters on the Midway have been reserved.

S. and A. E. Myers are in the Western States making a four months' trip in the interests of M. Myers, 367 Washington St., Boston, Mass., J. Myers started out last week and Geo. V. Turgeon reports a good trade in Maine.

The traveling salesmen in Wilmington, Del., last week were: G. W. Kerr, Averbeck & Averbeck; C. J. Bioren, Bioren Bros.; M. Vogel, Morris Vogel & Bro.; Mr. Faber, William Faber & Sons; Mr. McClennan, for E. A. Robinson.

Among the traveling men in Lancaster, Pa., the past week were: Mr. Burt, R. Wallace & Son's, Mfg. Co.; John W. Ehlers; Alexander Conklin; Mr. Weil, of J. M. Weil & Bros., Arthur Bradshaw, Meriden Britannia Co.; Mr. Bryant, T. G. Hawkes & Co.; H. B. Bliss, Gorham Mfg. Co.; F. D. Nacke, Nacke, Brinkman & Co.

Among the traveling representatives in Philadelphia, Pa., last week were J. W. Reddall, J. W. Reddall & Co.; Edward Ackley, Unger Bros.; B. Griscom, Riker Bros.; E. Blake, Blake & Claffin; W. M. Oakley, Thornton Bros.; Otto Wolf, Bippart & Co.; Sumner Blackinton, W. & S. Blackinton; and J. Green, for O. M. Draper.

Among travelers in St. Louis recently were: B. Hyman, of Low, Weinberg & Hyman; C. J. Dodgshun, Waterbury Clock Co., Frank Hodgins, Rogers & Bro., J. B. Ettinger; F. W. Franke, Wood & Hughes; Frank H. Dana, G. E. Luther & Co.; S. W. Abbey, E. Ira, Richards & Co., C. W. Edwards, Duerber Watch Case Mfg. Co.; H. C. Walton, Wadsworth Watch Case Co.; W.

F. Corey, of Corey & Osmun; Julius Schuman, with Wm. Kinscherf; A. Peabody, of Peabody & Engelsman.

Among the traveling fraternity visiting Boston, Mass., last week were: G. B. Osborn, Wm. Smith & Co.; C. W. Cary, J. B. & S. M. Knowles Co.; E. A. Woodmancy, Potter & Buffinton; Mr. Untermeyer, Keller & Untermeyer Mfg. Co.; Chas. E. Hancock, Hancock, Becker & Co.; Louis Jones and John L. Sweet, R. F. Simmons & Co.; Harry F. Barrows; W. S. Metcalf, Plainville Stock Co.; George L. Vose; M. D. Rothschild; Mr. Kent, W. H. Ball & Co.; A. Barker, Meriden Britannia Co.; W. B. Durgin.

The following traveling salesmen passed through Detroit, Mich., last week: Mr. Clark, Clark & Coombs; Mr. Platt, Foster & Bailey; Eugene Kingman, G. A. Dean & Co.; John Hagen, W. H. Manchester & Co.; R. E. Kiel, F. H. Noble & Co.; W. R. Cobb, W. R. Cobb & Co.; A. Pinover, A. Pinover & Co.; Edward Kuten, Levy, Dreyfus & Co.; W. C. Coombs, Edward F. Sanford & Co.; E. F. Badoux, Spencer Optical Mfg. Co.; Mr. Pierce for G. Armenia; W. H. Arnold, L. Black & Co.; Arthur S. Holly, Towle Mfg. Co.; Thomas E. Rogers, Hayes Bro.; F. F. Neefus, E. N. Welch Mfg. Co.; Charles E. Dorr, Gorham Mfg. Co.; Mr. Sichel, Eichberg & Co.; George W. Mabie, Mabie, Todd & Bard; Mr. Swift, Charles M. Swift Mfg. Co.; Mr. Sloan, John A. Riley & Sloan Co.; H. Black, Mathews & Willard; and M. S. Levy, S. Levy & Co.

The end of September and the first three days of October found Chicago a focus for traveling men. Among those in town were: Mr. Platt, Foster & Bailey; Mr. Whiting, Wade, Davis & Co.; C. L. Joralemon, A. Joralemon & Co.; Mr. Heffron, Riley, Frank & Heffron; Louis A. Blackinton, W. & S. Blackinton; J. D. Underwood, Champenois & Co.; F. V. Kennon, for J. T. Mauran; Harry Kent; J. T. Inman; J. G. Trafton; Nate Swift, for G. K. Webster; James Peacock; J. J. Sullivan, M. W. Carr & Co.; S. A. Bennett; Mr. Brown, Ellis, Livsey & Brown; L. H. Bosworth, Potter & Buffinton; H. A. Scofield, Lincoln, Bacon & Co.; G. A. Whiting, S. E. Fisher & Co.; Will A. Schofield, Lambert, Schofield & Co.; H. E. Kingman, G. A. Dean & Co.; S. W. Granbery, W. G. Clark & Co.; Chas. F. Lanhaar, Phenix Chain Co.; John J. Robinson, Holden & Knox; Mr. Bell, Bell & Cobb; Mr. Freeman, Jr., B. S. Freeman & Co., (wife and mother); Mr. Sweet, Hayward & Sweet; S. W. Pickering, Shoemaker, Pickering & Co.; C. C. Offerman, Wm. Smith & Co.; R. A. Thompson, for Henry Glorieux; Richard Robinson, T. G. Frothingham & Co., (and wife); Wm. W. Middlebrook, B. A. Ballou & Co.; E. A. Bliss, E. A. Bliss Co.; H. C. Bliss, Bliss Bros.; G. C. Booth, Hutchison & Huestis; J. A. Granbery, Reeves & Silcock; Geo. B. Caldwell, Plainville Stock Co.; F. W. Collom, S. Hutchins & Co.; Mr. Oakley, Thornton Bros.; Byron Greene, W.

C. Greene & Co.; Mr. Metcalf, R. Blackinton & Co.; and representatives of F. W. Weaver & Co. and Geo. L. Vose & Co.

### St. Louis.

Sidney Bauman, of the L. Bauman Jewelry Co., is taking in the World's Fair.

Fred Hoyt, of J. N. Andrews & Co., has gone on the road for a two months' tour.

The Western Jewelry Co. have been appointed southwestern agents for the Duerber-Hampden watches.

Daniel Earle, of Sydney, N. S. W., is expected here in a few days with samples of his opals and precious stones.

Albert French, a popular attache of the M. Eisenstadt Jewelry Co., was married recently to Miss Lizzie Kelsch, of Quincy, Ill.

Not one of the local jewelry houses has a display at the exposition this year. The A. S. Aloe Optical Co., however, have a very attractive exhibit.

Among the visiting retailers here last week were: M. Dorenfield, Corsicana, Tex.; George Lippel, Nokomis, Ill.; Dorrell & Wallace, Walnut Ridge, Ark.; and Peter Ziegel, Nashville, Ill.

Louis Schnurr, 424 S. 2d St., swore out a warrant a few days ago charging a man named Grockway, who was arrested at Pacific, Mo., with having stolen thirty watches valued at \$100.

An express package containing \$500 worth of solid silverware was delivered to T. J. Bradley, a barber, a few days ago when it should have gone to another man of that name. Last Tuesday Bradley, Peter Dolan and Gambetta Achard were arrested charged with melting the silver and selling it. Achard's father, E. Achard, is secretary of the Western Jewelry Co.

Otto Baehr & Co.'s store is still closed, and inside Otto Baehr and assignee John H. Bohle are busy taking an inventory of the stock. Mr. Baehr when seen by a CIRCULAR reporter readily discussed his failure. "It was caused principally by my brother Max. He was with me here but was not a partner in the firm, having only a contingent interest in the profits. I am now trying to figure out my exact assets and liabilities, and I hope in a few days to be able to settle with my creditors and maybe resume business."

### Newark.

Jean Tack and wife have returned from a visit to the World's Fair.

F. H. Larter and family have returned from Mount Tabor, where they have been spending the Summer.

Chas. Joy, formerly of the firm of the Joy & Seliger Co., has been appointed manager of the Newark branch of A. R. Chisholm & Co.'s banking house.

Henry Smith, a jeweler of Camden St., was arrested last week and taken to the Third precinct. Smith is charged by William Finger, of Finger Brothers, jewelers, with embezzling \$18.90 on June 28.



**THE QUESTION ?**  
 WILL IT TARNISH ? Need  
 not be asked if your Tissue Paper bears  
 this label.

MANUFACTURED BY

**C. H. Dexter & Sons,**

WINDSOR LOCKS, CONN.

**BE SURE YOU GET THIS BRAND.**

It has been adopted and is now used by the leading  
 manufacturers of this country.

**A. J. HEDGES & Co.,**

— MANUFACTURERS OF —

**Variegated and Enameled Jewelry,**

Black and White Enameled Goods.

*A SPECIALTY.*

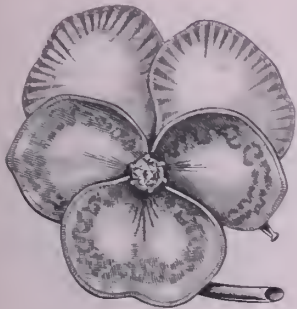

- Lace Pins, Scarf Pins,
  - Brooches and Pendants,
  - Gold and Silver Garters,
  - Link Buttons, Bracelets,
  - Hat and Hair Pin Attachments.
- 6 Maiden Lane, New York.**

FACTORY--90 Mechanic St.,  
 NEWARK, N. J.

**LLOYD PATENT.**

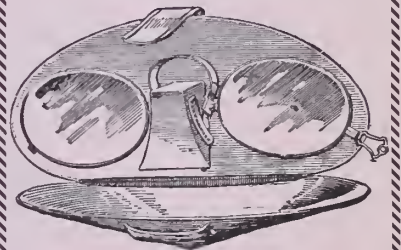

In **CASE** you want a  
 Good send for  
 LLOYD

**H. E. KIRSTEIN & CO.,**  
 MANUFACTURERS,  
 Rochester, N. Y.

**R., L. & M. Friedlander,**



IMPORTERS OF  
**DIAMONDS.**

WHOLESALE  
**JEWELERS.**

JOBBERS IN  
 American Watches.

Tools, Materials, and Optical Goods.

Send for Catalogue.

65 & 67 Nassau Street, New York.

# BAUME & CO.,

21 HATTON GARDEN, LONDON, ENGLAND,  
AND SWITZERLAND.

EXHIBITORS AT CHICAGO OF

## TOURBILLION CHRONOMETER WATCH,

WHICH HOLDS THE RECORD AT ROYAL OBSERVATORY KEW.

HIGH CLASS SWISS WATCHES, PLAIN AND COMPLICATED.

PATENTEES FOR SPLIT SECONDS CHRONOGRAPHS (Treble Action.)

AGENT FOR U. S., GEO. E. WILKINS, SYRACUSE, N. Y.



# GERMANY

SEEKS

AMERICAN TRADE,



And for the purpose of securing it has for several years **STUDIED AMERICAN WANTS.** The German exhibit at the World's Fair contains a full line of jewelry, specially **SUITED TO YOUR NEEDS** and expressly made with a view to furthering the jewelry and silverware trade between the two countries. Mr. Richard Horstmann, under whose supervision, and through whose efforts the consolidated German exhibits were secured to the Fair, represents the following lines:

**WATCHES.** { The celebrated patent watches of **DURRSTEIN & CO.'S UNION WORKS AT GLASHUTTE.** Among them movements held by bolts, and not by springs, insuring thinnest cases, split seconds, Chronometers, etc.  
**JEWELRY.** { Representative manufacturers of Pforzheim, Hanau and Gmünd. These cities are known worldwide for taste in designs and beauty of gold colorings and enamel work in all branches of the jewelry trade.  
**SILVERWARE.** { Reproductions of the best old German, Dutch and Rococo designs.

We can serve your best interests if you will but let us know your wants. Correspondence invited.

## RICHARD HORSTMANN,

VIENNA.

Seigmundgasse 15. Tel.-Adr.: PARATUS WIEN.

BERLIN, S. W.

Oranienstrasse 101 102. Tel.-Adr.: PARATUS BERLIN.

LONDON, E. C.

13 Charterhouse Street. Tel.-Adr.: WELLROOM LONDON

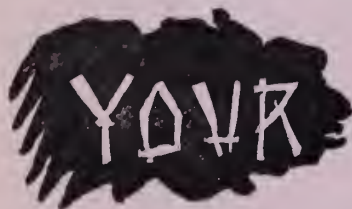

CHICAGO.—German Jewelry Exhibit, Manufactures Building, World's Fair.

GERMAN COURT OF HONOR.

# WORLD'S FAIR and WESTERN SUPPLEMENT of THE JEWELERS' CIRCULAR

CHICAGO OFFICE: ROOM 308, INTER-OCEAN BUILDING.

VOL. XXVII.

CHICAGO, WEDNESDAY, OCTOBER 4, 1893.

NO. 10

## THE WORLD'S FAIR EXHIBIT OF R. F. S. & CO. CHAINS.

THE wearer of a watch chain requires three essentials in this universal article of personal adornment—durability, reasonableness of price and attractiveness of design. Electroplate may fill the requirements of two of the essentials, but durability cannot be claimed for it; rolled gold plate answers every requirement. Reasonableness of price is effected by this process in all cases, but design work and durability are subject to wide variations according, in the first case, to the skill of the artisans engaged, and in the second to the methods employed in rolling and drawing out the combination of gold, solder and base metal.

pany's workshop, in Attleboro, Mass.

The cylinder is housed in an octagonal

dome on all the eight sides. Surmounting the dome is a short staff from which an old-time sign board tells the public that the display is that of "R. F. Simmons & Co., Attleboro, Mass.," a brass rail incloses the carpeted space about the pavilion, and a stand in the corner is covered with literature concerning the process of manufacture.

The process is interesting. First the bar of plating metal is prepared. Then gold is melted and cast into flat bars which are rolled to the desired thickness. Hard silver solder is next rolled very thin and the sheets, cut to the size of the bar of plating metal, are placed between this metal and a sheet of gold on either side. The five sheets are placed in a clamp and subjected to a heat sufficient to unite the various sheets into one solid ingot which can be rolled to any desired thickness. Tubing is formed by taking stripes of base metal with but one side treated as above described, the stripes passing through a draw bar which forms the tube. This is larger than required and shows a faint line where the parts are soldered. This line entirely disappears as the tube is drawn into a wire.

Aside from the care exercised in the manufacture, the variety of patterns shown on the cylinder is of importance. Pendant chains, draperies, an artistically arranged shield, a

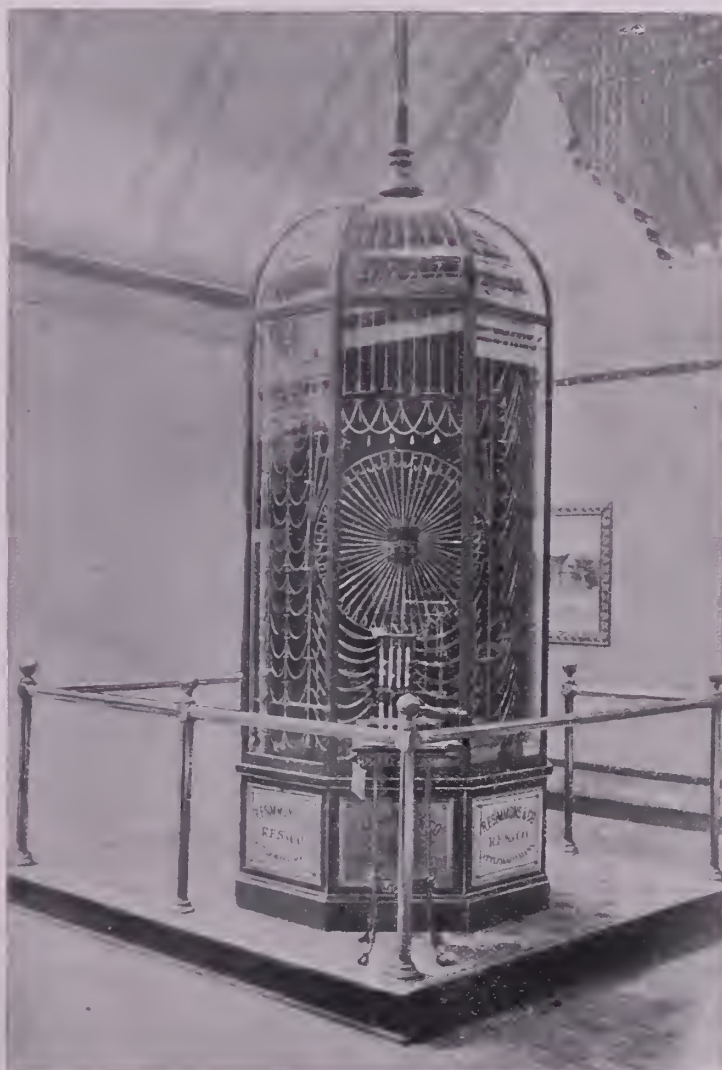

THE CYLINDER CASE EXHIBIT OF R. F. SIMMONS & CO.

recent patterns and beautiful forms, every iota of which is manufactured in the com-

pavilion of natural finish oak with paneled base, plate glass reaching to the octagonal

huge wheel, Dickens chains with sardonxy pendants, ladies' chatelaines and

long guard chains follow in rapid succession as the cylinder revolves. Pendent chains are displayed in many choice patterns. Draperies are arranged from chains in angular patterns with pearl and gold bar links. The shield has lockets for stars and pendent chains in groups for stripes, with guard chains outlining the border. The

laces in gold and silver; in the center are draped long guard chains, and below are ladies' chains with fancy pendants. Then comes a line of gents' chains hanging pendent with a line of gold-mounted ribbon vests forming the lower border. Then comes a draped effect of long-link fancy patterned gold and mother-of-pearl chains

7. Greatest variety of styles.
8. Lapped surfaces on so-called gold fronts which gives a dead flat surface.
9. Large, superior swivels and bars.
10. Absence of common round wire designs.
11. Solid gold and gold front slides.
12. Uniformity in thickness of plate.

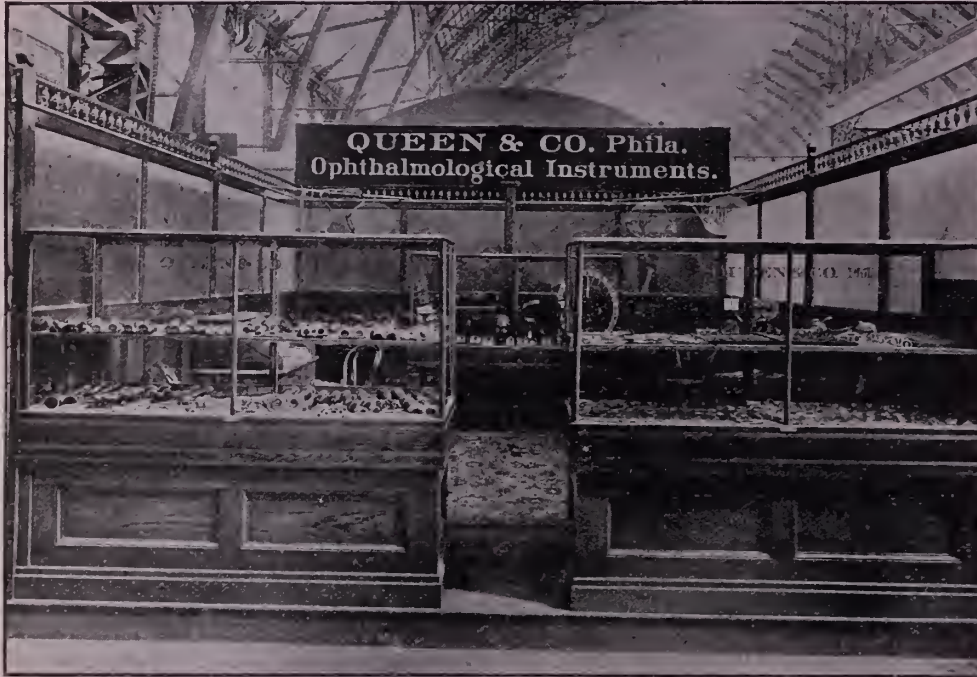

EXHIBIT OF OPHTHALMOLOGICAL INSTRUMENTS OF QUEEN & CO., INC.

13. Excellence of exhibit.  
Beauty of form in R. F. S. & Co. chains is produced by angles which cannot be found in round or curved effects. In variety of shapes requiring the use of dies and shaping machines, the products of the factory possess a rare and pleasing originality.

### A Remarkable Pair of Diamonds.

A S fine a pair of matched diamonds as were ever exhibited are shown by R. E. North, of 57d Hatton Garden, London, in a central location in the British section of Manufactures building. The diamonds in this case could hardly fail to be perfectly matched, as they were cut from a single stone by a leading expert among diamond cutters. When the stone in the rough, weighing 199½ karats, was found by J. Mylchreest in the Dutoitspan mine, it was found necessary to cleave it and Mr.

North was engaged to do the work. The stone was cleaved in half so scientifically that each was of exactly the same weight as the other. These are known as the Mylchreest diamonds; they are brilliant cut, and arc an inch in diameter. A certificate from Mr. Mylchreest states that the pair were cut from a single stone by Mr. North and that, in the opinion of judges, there is no other pair of brilliants of this size cut from a single stone known to exist.

The pair were exhibited to the Royal family of England at the social function held at the Imperial Institute, May 17, 1893, and were installed at the Fair the past week. There is a wonderful play of color in the stones.

Unlike most of the large diamonds these were cut and polished to produce the greatest brilliancy and not for weight.

wheel is the most noticeable geometric figure on the cylinder and is formed of three wide ribbon fobs with gold buckles and sardonyx pendants as a hub from which radiate the spokes, single chains with bars at the end forming a continuous fellow. In the center below the wheel are hand-painted gros grain white silk ribbon chains for ladies, with gold and silver findings, and from each side of these are draped double strand vest chains with "gold front" slides. After the Dickens chains come ladies' chains and chain bracelets. At the top are bead neck-

for gentlemen which completes the cylinder.

The R. F. Simmons & Co. chains, bracelets and lockets are rolled gold plate of 12 and 14 karat gold of 1/10, 1/8 and 1/4 stock and the following claims are presented:

1. Full weight of gold.
2. Full karat of gold.
3. Every article and every part of each article are made in their factory.
4. Superior finish of surfaces.
5. Superior joining of parts.
6. Originality of styles, and designs.

ESTABLISHED 1879.

G. W. HOOK,

MANUFACTURING JEWELER,

149 and 151 State Street,

Chicago, Ill.

INSPECTION BY THE VISITING TRADE INVITED.

## GIBSON HOUSE,

CINCINNATI, OHIO.

ABSOLUTELY FIRST-CLASS AMERICAN PLAN HOTEL.

\$3.00 PER DAY.

Extra Charge for Parlors and Rooms with Bath attached. The unequalled advantages in central location, liberal management, modern appointments, experienced service and perfect cuisine, have permanently established the Gibson House as The Most Popular First-Class Hotel in Cincinnati.

AMPLE VAULTS FOR THE PROTECTION OF VALUABLES.

THE GIBSON HOUSE CO.,

H. B. DUNBAR,

President and Manager.



EST. 1870.

DR. PETER HENRY,  
SPECIALIST IN  
WATCH • CASE • DISEASES

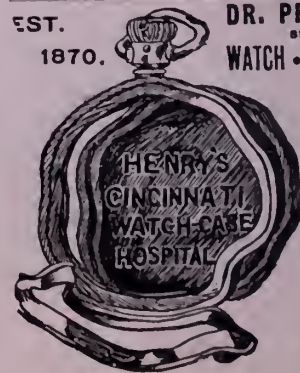

Key Winders changed to Stem Winders.

Hunting Case: changed to O. F.

English Cases changed to fit American movements

Can be cured at 53

Longworth St., Cincinnati, Ohio.



OPTICAL PRODUCTIONS AT THE WORLD'S FAIR

PART IV.—THE OPTICAL EXHIBITS OF QUEEN & CO., INC.

THE optical exhibit of Queen & Co., Inc., Philadelphia, Pa., is one of six under their charge and is in the Manufactures and Liberal Arts building, gallery floor, north end, Section E. The space allotted them has been converted into a room in which every conceivable article used in testing the eye has been tastefully

ophthalmoscope and mirror for retinoscopy. The Javel ophthalmometer manufactured in Queen & Co.'s own factory, also occupies a prominent position. The large skeleton spectacles and eyeglasses measuring 4½ feet across, are objects of much interest to visiting opticians and jewelers.

A complete outfit, comprising trial case,

and is pronounced the *multum in parvo* o a traveling optician's outfit. This firm make a specialty of filling oculist's prescriptions, and anyone wishing such prescriptions accurately filled at moderate prices should communicate with them. They have also every facility for doing all kinds of special work in their factory which is complete in every respect.

The exhibit of Ad. & Ed. Deraisme, 167 Rue St. Maur, Paris, is under the charge of Queen & Co., and comprises in addition to the regular lines of opera and field glasses, a number of exceptionally fine novelties. As this exhibit is in one of the most elegant cases to be found in the building, it naturally attracts much favorable attention.

(Series to be continued.)

C. S. Kepner, Chester, Pa., who for the past three years has conducted a glass, china and small wares store at 11 W. 3rd St., retired from the business Oct. 1, and about the middle of the month will engage in the jewelry business at 536 Market St. Mr. Kepner is a practical jeweler.

H. B. BOLSTAD. J. H. NIGHTINGALE.

WATCH CASE MAKERS AND REPAIRERS.

**H. B. Bolstad Plating Co.**

GOLD AND SILVER PLATING.

DESIGNING AND ENGRAVING.

170 Madison Street, - - CHICAGO.

**THE PLANCHAMP & BECKER CO.**

Makers and Repairers of

**WATCH CASES,**

Gold and Silver Plating —

— of Watch Cases a Specialty.

UNEXCELLED FACILITIES.

63 and 65 East Washington St., Chicago.

**PARSONS : SCHOOL**

— FOR —

**WATCHMAKERS,**

PEORIA, - - - ILL.

Send for Circular and Terms.

**PARSONS & CO.**

**JEWELERS.**

We guarantee to sell you Sterling Silver Flat Ware at a less price than any other manufacturer, and give you newer designs.

We will increase your profits if you will let us. Is it not worth trying?

**OVAITT & WARNER, Silversmiths,**  
PORTLAND, OREGON.

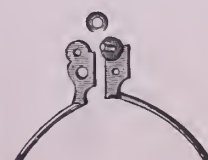

Racine Jewelry Mfg

CO.,

**SPECTACLE TEMPLE**

**WASHERS,**

Gross in a Bottle, 25c.

For Sale by Dealers in Jobbing Materials



THE EXHIBIT OF AD. & ED. DERAISME, UNDER CHARGE OF QUEEN & CO., INC.

and attractively grouped. Prominent among these is the largest and most complete trial case ever produced, containing as it does over 500 lenses, 4 trial frames, prism, Mobile

sample spectacle and eyeglass frames, fitting frames for taking facial measurements with necessary order blanks and test types, all set in, a leather carrying case, is also shown

**IRONS & RUSSELL,**

(SUCCESSORS TO CHARLES F. IRONS.)

MANUFACTURERS OF

**SOLID GOLD EMBLEMS ROLL PLATE**

PINS, CHARMS AND SOLID GOLD RINGS.

102 Friendship Street, - - Providence, R. I.



### Exhibit of W. B. & C. Watch Glasses.

**I**N the German gallery of the Manufacturers building, Walter, Berger & Co., of Goetzenbruck, Lorraine, have a fine exhibit of the celebrated W. B. & C. watch glasses and spectacle lenses. The goods are displayed on upright white cloth covered surfaces in a handsome walnut case. On one side are watch glasses, from the smallest to the largest, in plain, beveled edge and ground centers of every description. Larger glasses for photo and miniature frames are shown in oval, rectangular and circular forms, and the base between the pyramid and case is piled deep with scores of original packages in dozens and grosses.

A small line of artificial eyes and a large line of samples of spectacle lenses of all varieties of form and color occupy the opposite surface. On both sides, the glasses are arranged in geometrical designs, and are well arranged for a proper examination. As showing the capacity of the works for varying dimensions the ends of the case are filled with huge watch glasses of some 20 inches diameter. Walter, Berger & Co., are prize winners at the World's Columbian Exposition, having received a medal and diploma for their exhibit. The firm is represented in this country by Albert Berger & Co., 47 Maiden Lane, New York.

The factory of Walter, Berger & Co. is

situated in a small town in Lorraine called Goetzenbruck. The origin of this factory dates as far back as 1640, when the ancestors of the present glassmakers went to that country where woodland was plentiful. About this time Richelieu, minister of Louis XIII., King of France, made a tour of Lorraine, and being much pleased with that new industry, made a concession of 1,000 acres of woodland to the brothers, Nicholas, Etienne and Martin Walter to encourage and help them in their undertaking. The conflict known as the Thirty Years War was then raging. The Swedish army passed through Lorraine, devastated the country, set fire to the factory, famished the people and enlisted most of the workmen. Notwithstanding these discouragements, the three brothers with perseverance and hard work managed to start again, and build up what is now the biggest watch glass and lens factory in the world.

At first these people made only hollow glassware such as bottles and drinking glasses, and it was as late as 1724 that the glassmakers of Goetzenbruck began to make watch glasses, at the time the watch trade used only the verge glass, which was a section of a glass ball.

In 1766 at the request of a Frenchman by the name of Chambre, the factory manufactured Geneva glasses. These glasses were blown piece by piece on small round bottles, the bottom of which would constitute the watch glasses, and afterwards taken out by

a red hot iron. The center of commerce was then Holland, and it was there that most of the glasses were sold. Switzerland, where the new industry of watchmaking was becoming established, also consumed a large quantity of the glasses. The price of these glasses was then 200 francs per gross, an enormous price from the present day standpoint.

In 1824 the business developed to such a great extent that the manufacture of glassware was given up entirely and the factory applied itself to the making of watch glasses only. At that time it employed about four hundred workmen. In 1830 Hilaire Walter, son of the owner, went to New York and established a branch house called Berger-Walter, and introduced the W. B. & C. watch glasses. This brand of glasses holds the highest position in the American market by reason of their superiority, fine finish and flexibility, and are celebrated not only in Europe but in the world over, being known by all watchmakers. It is but in reason to suppose that such a firm as Walter, Berger & Co., with its long active career at its back, would produce an article of the most perfect qualities. As such every watchmaker regards the W. B. & C. watch glass.

A proof that the W. B. & C. are the best glasses is that the firm has received the highest award at every large exhibition held in various cities of the world, including the great distinction of the cross of the *Legion d'Honneur*, and, as above stated, the highest award for their remarkable workmanship at the World's Columbian Exposition, Chicago. Were no other proofs available, these awards would be sufficient in evidence of the good qualities and superiority of manufacture of these watch glasses.

In 1835 Hilaire Walter invented a method of making Geneva glasses by a new molding process, which saves a great deal of handwork. In 1854 the house of Berger-Walter changed its name to Albert Berger & Co., which is in existence yet, at 47 Maiden Lane, New York.

In 1860 André Walter, whose death occurred about a month ago made the first flat parallel and mi-concave glasses, and invented an automatic lathe to grind them by. There is no other factory producing watch glasses and spectacle lenses that manufacture their own glass. Walter, Berger & Co., not only make the rough glass, but also the potash and other chemicals used in the composition of the same. The manufacturers' idea in thus doing is to have always the whitest, purest and hardest glass which possibly can be made for optical purposes. The cost of manufacturing the glass is considerably greater than if they bought it, as other watch glass and lens makers do. By making their own glass they are enabled to have it more uniform and more suitable for their purpose.

The factory constantly uses two furnaces, each with ten melting pots, each pot containing 1,000 pounds of glass. A few years ago it was necessary to build a new grind-

## HIGHEST AWARD WAS OBTAINED

AT THE COLUMBIAN EXPOSITION.

BY OUR

# Musical Boxes



## JACOT & SON,

298 Broadway, - New York.



Send Business Card for Large Illustrated  
Catalogue and Trade Prices.

ing shop with 1,000 tours which are in full operation day and night. There are employed at the present moment about 1,800 workmen and the work people of Goetzenbruck are all prosperous, happy and own the houses and gardens they occupy.

Albert Berger & Co., who represent the factory in New York are very closely connected with Walter, Berger & Co. and are the sole agents for their glasses.



**J. R. WOOD & SONS,**  
14 JOHN STREET, NEW YORK.

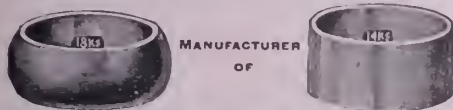

PLAIN SOLID GOLD RINGS.  
SEAMLESS PLAIN SOLID GOLD RINGS.  
ENGRAVED AND CHILD'S RINGS.  
No Ring Stamped Different from Quality.  
Send for Catalogue and Price List.

Old Gold and Silver received and estimated on: If amount allowed does not give satisfaction, notify at once and will return at our expense, in same condition as received.

# RECEIVER'S SALE.



ENTIRE Stock of **Giles, Bro. & Co.** Fourth Floor Masonic Temple, consisting of Diamonds, American and Swiss Watches, Jewelry, Silver and Plated Ware, Tools, Materials, etc. will be sold in lots to suit the purchasers, at large reduction from original cost price.

An unusual chance for live Jewelers to obtain bargains.

W. H. GLEASON, Receiver.

July 14th, 1893

## ETCHING TAUGHT FOR \$10.

Having received numerous requests for our formulas in silver etching, we have decided to give individual instruction to those desiring to do their own work and save delay and shipping expenses. Jewelers can take advantage of this offer while visiting the Fair. Printed formulae and practical instruction in their use will be given where time is limited. Refer to any jewelry firm in Chicago. All kinds of etching done for the trade.

**LYMAN & CO.,** ETCHERS AND ENGRAVERS, 96 State Street, Chicago.

# JUERGENS & ANDERSEN COMPANY,

## DIAMONDS AND MOUNTINGS,

Order Work a Specialty.

125-127 State St., Chicago.

ONE OF THE BEST OF THE VERY BEST.

QUALITY IS THE STANDARD OF VALUE.

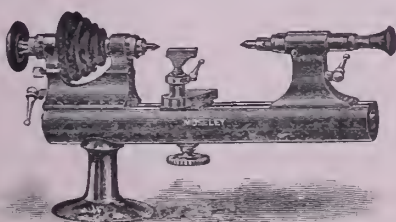



MEN INTERESTED WRITE YOUR JOBBER OR

**MOSELEY & CO., - - - ELGIN, ILL.**



HAS LENGTH, STRENGTH, ACCURACY.

**VICTOR.**    
SIMPLEST FEED. ALWAYS THE SAME.  
GUARANTEED FOR ONE YEAR.  
**THE VICTOR FOUNTAIN PEN**  
(Pat. Feb. 4, 1890.)

**THE BOSTON PEN CO.,**  
N. C. Whitaker & Co., Proprietors.  
363 Washington Street, - - Boston, Mass.,  
Manufacturers of finest quality  
TORTOISE SHELL AND HORN GOODS  
in every variety. Also Aluminum Hair Pins.  
Send for Illustrated Pen Price List No. 1.

## Chicago.

The following figure among the buyers and visitors in Chicago and at the Fair :

A. Manning, San Francisco, Cal.; John F. Beyerle, Reading, Pa.; John Becker, Wheeling, W. Va.; J. M. Whitney, Woodstock, Ont.; Mr. Redero, Pueblo, Mex.; Henry Yost and wife, Erie, Pa.; Sol. Lesser, Adolfo Aronson, D. F., Mexico, Mex.; Mr. Gansl, Grand Forks, N.D.; H. B. Shellito, Sault de Ste. Marie, Mich.; Joseph Beyer and wife, Erie, Pa.; Fred Neshmard, Syracuse, N. Y.; Matt Haug, Houghton, Mich.; W. A. Bowne, Kewanee, Ill.; L. Vanderbee, Jr., Plattville, Wis.; E. G. Allen, Marshalltown, Ia.; Fred Neshmard, Elgin, Ill.; M. Wollmann, Freeman, S. D.; E. H. Newman, Owen Sound, Ont.; D. H. Porterfield, Holyoke, Mass.; Bernard Karsch, New York; Geo. E. Sherwood, Waterloo, N. Y.; W. B. McLane, Cantril, Pa.; G. W. Hardwar, Fort Smith, Ark.; G. W. Meyer, Meridian, Miss.; O. G. Ginn, Meridian, Miss.; C. Arveson, Sleepy Eye, Minn.; B. J. Walker, Windsor, Ont.; J. H. Whiteside, Liberty, Mo.; Wm. Glover, Jr., Hazleton, Pa.; Geo. A. Johnston, Cadiz, O.; D. L. Bowles, Martinsville, Va.; Manis Hyams, New York; L. W. Bever, Shelton, Neb.; M. A. Rainboldt, Mitchell, Ind.; Hy. Lowenstein, St. Louis, Mo.; N. P. Petersen, Minneapolis, Minn.; A. C. Gies, Pittsburgh, Pa.; Hermann Rohne, St. Louis, Mo.; J. Myer, Elwood, Ind.; M. N. Berg, Cloquet, Minn.; Wm. H. Horton, Clarkston, Mich.; C. E. Warson, Thorntown, Ind.; I. Bedichimer, Philadelphia, Pa.; F. B. Harris, Lincoln, Neb.; J. L. Bliss, Atchison, Kan.; H. H. Brainard, Medina, O.; O. A. Anderson, Lyle, Minn.; W. S. Carson, Pleasant Plains, Ill.; W. A. Gill, St. Louis, Mo.;

F. M. Sommerkamp, with T. Spear, Columbus, Ga.; L. M. Lowenthal, Dexter, Ia.; O. H. Pitkin, Princeton, Ill.; John R. Kocher, San Jose, Cal.; Hustace & Anderson, New London, Conn.; Albert Weber, Fenimore, Wis.; Henry A. Dodd, Cincinnati, O.; R. J. Riles, Palatka, Fla.; C. R. Blake, Marion, Ind.; Alden Bros., Waterford, Me.; G. H. Roling, Bellevue, Ia.; Zierleyn & Carstons, Grand Rapids, Mich.; E. C. Bates, Alliance, O.; A. W. Pringle, Port Hope; Louis Bros., Piqua, O.; Geo. H. Doerr, Spokane, Wash.; W. S. Mills, Fillmore, N. Y.; H. C. Reine-man, Pittsburg, Pa.; Ed. L. Daron, Steelton, Pa.; S. A. Dodge, Millbury, Mass.; H. S. Hart, Jacksonville Ill.; The Levy Bros. Co., Ltd., Hamilton, Ont.; Chas. E. Keever, Fountain City, Ind.; Jas. H. Bell, Tarboro, N. C.; G. H. Hall, Golden City, Mo.; J. W. Greer, Evans City, Pa.; F. D. Kelsey, East Aurora, N. Y.; Wm. Dietz, with L. Combremont, New York; Herman Watts, Augusta, Ill.; Wm. L. Jobe, Columbus, Miss.; C. Sieglitz, Vevay, Ind.; J. B. Dunham, Jr., Oneida, Ia.; Henry P. Towner, Bloomington, Ind.; M. C. Miller, Swartz Creek, Mich.; J. W. Eddy, Kewanee, Ill.; F. L. Fuller, Joplin, Mo.; D. F. Hewitt, Toulon, Ill.; J. E. Stiles, St. Louis Park, Minn.; A. C. Tobey, Pictou, Ont.; G. G. Case, Jackson, Mich.; S. W. Gray, Fort Dodge, Ia.; R. A. Magee, Marion, Ia.; John F. Kohler, Richmond, Va.; W. C. Ball, Cleveland, O.; G. A. Schlecter, Reading, Pa.; Carl C. Schmidt, St. John, N. B.; Herman Vallmer, Princeton, Ind.; B. Barnett, New Orleans, La.; E. W. Blossom, Sterling, Ill.; R. H. Bedford & Son, Ionia, Mich.; H. T. Schlegel, Peoria, Ill.; Harris Bros., Niles, O.; John Hueter, Cleveland, O.; A. Hanson, Milwaukee, Wis.; W. C. Seaton, Jr., Troy, N. Y.; J. S. Esely, Leipsic, O.; H. A. Johnson & Bro.,

Tuscola, Ill.; Max Rich, Saginaw, E. S., Mich.; Wm. Nordhoff, Washington, D. C.; W. F. and J. C. Dotter, Philadelphia, Pa.; J. Jacoby, New York; H. J. Hallock, Wyalusing, Pa.; J. B. and G. H. Spangle, Chetopa, Kan.; J. W. Knapp, Cross River, N. Y.; Charles Jordan, Cambridge, Ill.; Lee Roberts, Bristol, Conn.; A. Egle, Lexington, Mo.; S. Thomas, Jr., Charleston, S. C.; Geo. McDonald, Tweed, Ont.; B. N. Greenland, Philadelphia; George H. Griffin, Portland, Me.; George H. Stinson, Camden, Ark.; Ben Vey, Allegheny, Pa.; J. H. Ewin, Farley, Ia.; H. R. Cuddon, St. Catharines, Ont.; M. W. Manahan, M. D., Atlanta, Ga.; B. Petterson, Montevideo, Minn.; Weld & Sons, Minneapolis, Minn.; W. H. Billade, Enosburgh Falls, Vt.; Oliver A. Watson, Watseka, Ill.; F. E. Fate, Lena, Ill.; A. P. Child, Alden Station, Pa.; W. A. Strong, Kendallville, Ind.; Wm. C. Lutz & Co., Buffalo, N. Y.; Glasgow Bros., Cherokee, Iowa; W. A. Bowen, Kewanee, Ill.; L. M. Bird, Aurora, Ill.; A. Shire, Paris, Ky.; Fritz Guy, Ft. Cloud, Minn.; Elijah Steitler, Owensboro, Ky.; F. G. Meyer, Dayton, O.; L. A. Perret, St. Paul, Minn.; J. H. Wright & Son, Wellington, O.; John McBride, Fort Worth, Tex.; Geo. A. McHenry, West Superior, Wis.; C. L. Ruth, Montgomery, Ala.; T. W. Gardner, Indianapolis, Ind.; C. W. Mosher, Holly, Mich.; Mr. Siebel, Saginaw, W. S., Mich.; Louis Miller & Bro., Albany, N. Y.; W. R. Bristol, Beaufort, S. C.; Laird H. Wallace, Ogden, Utah; Az. Megede, Norborne, Mo.; Archie M. Allen, Buffalo, N. Y.; F. H. Shearer & Co., Bay City, Mich.; William Pratt, Lake City, Mich.; C. H. Curtis, Eureka, Kan.; Lozier Keeney, Breckinridge, Mo.; D. Oppenheimer & Bro., Baltimore, Md.; Calvin Sollday, New Hope, Pa.; L. Stocker & Son, Macomb, Ill.; A. Wolf, Louisville, Ky.; C. C. Will, Pittsburgh, Pa.; Max Freund, New York; W. C. Ernst, Danville, Ill.; J. H. Awitt, Parkersburg, W. Va.; Ostrander & Comstock, Alden, Minn.; M. F. Robinson, Springfield, Mass.; A. E. Frederick, Louisville, Ky.; W. J. Lukens, Wheeling, W. Va.; Edw. Coriell, Portsmouth, O.; A. J. Kahn, Iron Mountain, Mich.; H. Parks, Woodward, Ia.; R. D. Rirmse, Dubuque, Ia.; John W. Neasham, Ottumwa, Ia.; Joseph A. Williams, Boston, Mass.; Robert C. Pahr, Lancaster, Pa.; C. A. Baier, Salina, Kan.; E. C. Macomber, Hopener Junction, N. V.; D. Leonhisen and wife, Huron, O.; Carl F. Walk, Indianapolis, Ind.; A. J. Stoend, Milwaukee, Wis.; A. J. Hofer, Kearney, Neb.; S. Waugh Bauman, St. Louis, Mo.; E. A. Waller, Omaha; H. C. Reiling, Philipsburg, Pa.; M. A. Hartigan and wife, Syracuse, N. Y.; Jas. D. Leys, Butte, Mont.; Geo. A. Montgomery, Los Angeles, Cal.; C. Ed. Mellert, Lancaster, Pa.; B. Hoffman, Leavenworth, Kan.; N. N. Davis, Philipsburg, Pa.; E. L. Marsh, Fort Dodge, Ia.; Chas. Jordan, Cambridge, Ill.; E. J. Peck, Braidwood, Ill.; Mr. Ormond, Winnipeg, Can.; A. L. Schlienty, Defiance, O.; F. J. Fella, Defiance, O.; C. E. Dale, Bennington, Kan.; Saginaw Watch Co., Saginaw, E. S., Mich.; E. R. Moser, Ft. Bend, Kan.; J. E. De Long, Wapello, Ia.; E. E. Morrow, Buffalo, N. V.; D. L. Bowles, Martinsville, Va.; A. Gluck, Dodge City, Kan.; Fred L. Swait, Auburn, N. Y.; J. A. George, Iowa Falls, Ia.; W. A. Bowen, Kewanee, Ill.; Clark Bros., Philadelphia, Pa.; Justice Stahn, Baltimore, Md.; Lou M. Beck, Peru, Ind.; Thos. Lawrence, Cleburne, Tex.; E. H. Taylor, Stockton, Md.; H. B. Clark, Rantoul, Ill.; C. F. W. Marquardt, Norfolk, Neb.; F. Crain, Massillon, N. Y.; Jules Vantroit, Jr., Warren, O.; F. N. Eikhoff, Gd. Rapids, Mich.; J. L. Grady, Slater, Mo.; Meyer Louis, Piqua, O.; E. S.

# REED & BARTON,

## SILVERSMITHS,

MANUFACTURERS OF

STERLING  SILVER PLATED  
SILVER  WARE.

SALESROOMS :

37 Union Square, New York.

34-36 WASHINGTON STREET,

Venetian Building, Chicago.

FACTORIES, TAUNTON, MASS.

# ALBERT H. BONNET,

ONLY EXCLUSIVE WHOLESALE JEWELRY HOUSE IN OHIO.

COLUMBUS, WALTHAM, ELGIN, HOWARD AND STANDARD WATCHES,  
GOLD AND FILLED CASES, JEWELRY, CHAINS, CLOCKS.

FULL LINE OF TOOLS AND MATERIALS.

No. 24 E. SPRING STREET,

COLUMBUS, OHIO.

Robinson, Patchogue, N. Y.; H. L. Terry, Sayville, N. Y.; J. M. Tryon, Monroeville, Ind.; Lee Aberdorfer, Henderson, Ky.; A. M. Perkins, Kyneton, Victoria, Australia; Geo. A. Hyde, East Smithfield, Pa.; J. G. Parr, Smithfield, O.; W. S. Mills, Fillmore, N. V.; F. H. Weld, Minneapolis, Minn.; F. Witter & Co., Storm Lake, Ia.; Otto Frederick, Cape Girardeau, Mo.; Mr. Rich, Saginaw, Mich.; Chas. D. Bayless, Waukon, Ia.; Wm. Pratt, Lake City, Mich.; Samuel Levy, Peoria, Ill.; Harry E. Thomas, Wilmington, Del.; H. M. Jacobson, Albany, N. Y.; Wm. Farrand, Savannah, N. Y.; Geo. W. Moore, Bloomville, O.; W. H. Cooper, Hodgesville, Ky.; John Glenn, Newport, Tenn.; O. Nelson, Peshtigo, Wis.; John Ontwater, Lockport, N. Y.; W. W. Stambaugh & Co., Kunkle, O.; H. E. Boughton, Brooklyn, Ia.; D. L. Nielson, Vermillion, O.; M. V. Waters, Marshalltown, Ia.; Louis Kahn, New York; C. Herbert Thompson and family, Marshall, Mich.; F. L. Combs, Omaha, Neb.; H. S. Lewyt, Baltimore, Md.; C. Karstophy, Helena, Mont.; Geo. T. Stoneham, Salt Lake City, Utah; H. M. Jacobson, New York; S. Lyons, Leavenworth, Kan.; S. Livingstone, Tamaqua, Pa.; H. Richardson, Ingersoll, Ont.; Theo. E. Mason, Newtown, Mass.; G. H. Wilson, Griggsville, Ill.; Taylor & Wright, Binghamton, N. Y.; C. M. Thrasher, Piedmont, W. Va.; C. H. Rudolph, Massillon, O.; Joseph Harz, New Orleans, La.

J. P. Johnson has given a chattel mortgage for \$1,500.

Mr. Riley, of Riley, French & Heffron, and Clarence Fisher, of Attleboro, are at the Fair.

Mr. Potter, of Potter & Buffinton, Providence, stopped at the Auditorium the past week.

Solly Lesser, of A. Lesser's Sons, Syracuse, N. Y., sojourned last week at the amusement places in Jackson Park.

Charles F. Heintz, of Heintz Bros., Buffalo,

N. Y., with his family and a party of friends spent two weeks at the Fair.

Tatsch & Wild have moved from their temporary to permanent quarters in room 1402 Columbus Memorial building.

E. A. Codding, of Codding Bros. & Heilborn, has returned cast from a week at the Fair. Mr. Heilborn is now in the city.

George Becker, of Hancock, Becker & Co., and Albert Totten, of Thomas Totten & Co., wind up a six weeks' trip, with a visit to the Fair before returning home.

Daniel Earl, of Sydney, N. S. W., opal specialist and dealer in colored stones, who has been in Chicago for seven months, has left for New York, where he will stop at the Fifth Avenue Hotel, for three or four weeks.

"We'd all be proud of it too," chorused Sol. Kaiser's friends when he drew from his pocket an elegant open faced minute repeater, a gift from Mr. Strasburger, Sept. 24th, on the anniversary of Sol's (?) birthday.

The Chicago Jewelers' Association were expected at their regular monthly meeting yesterday to take action on closing Oct. 9th, Chicago Day at the Fair. Individual members were interviewed and favored closing for the day.

S. A. Dale, president of the Horological Tool Co., 86 N. Clark St., leaves the present week for a Pacific Coast trip on combined pleasure and business. He will be away two months and spend most of the

time in Southern California. Charles J. Dale assumes charge of the business during his brother's absence.

F. W. Hall, representing Codding Bros. & Heilborn, N. Attleboro, and the Peckham Seamless Gold Ring Co., New York, has removed from 243 State St., to room 802 Columbus Memorial building and carries a full sample line of both concerns. A novelty of Codding Bros. & Heilborn in which Mr. Hall is having great success is a line of flags of all nations in scarf pins, lace pins, link buttons and tie clasps. The flags are in silver and gilt with enamels.

Thirty-five trades unionists associated with the Paris Labor Exchange spent a week at the Fair. Their expenses are paid by the French Government, and they were delegated to visit the Exposition and gather material for a report on its industrial features. Among the tradesmen were two jewelers and two watchmakers. Some of the best known artisans were: M. Heller, engraver and M. Bricy, silversmith. The party was reinforced on the day of their departure by over thirty fellow workmen whose expenses are paid by the municipality of Paris. Engravers and jewelers are in the party. M. Ouny is one of the jewelers.

Judge Grosscup heard arguments last Tuesday made by counsel for the World's Columbian Exposition to dissolve the injunction obtained by J. V. Hunoldt in the State Court restraining the Exposition

PHILADELPHIA, 1876.

GENEVA, 1880.

PARIS, 1889.

CHICAGO, 1893.

# ... EZRA KELLEY'S ... LUBRICATING OILS,

FOR WATCH, CLOCK AND CHRONOMETER MAKERS, ALSO TYPE WRITERS, MECHANICS AND SEWING MACHINE OILS

HAVE BEEN INVARIABLY VICTORIOUS.

The discovery of a Lubricator for **Fine Machinery**, such as Watches, Clocks and Chronometers, that is free from gum and glutinous matter, has taxed the ingenuity of hundreds of men whose efforts have proved a failure; but we are happy to say (being largely interested) that such an article has been supplied by

**MR. EZRA KELLEY OF NEW BEDFORD, MASS.**



Who, after sixty years of study of the subject, perfected a lubricator that recommends itself to all who have used the **GENUINE**, there having been numerous counterfeits in the market, as witness also the first class awards and diplomas by the judges at the Exhibition in Philadelphia in 1876, Geneva in 1880, and in Paris in 1889, receiving the only medal awarded to an American exhibitor of oils.

It is for the interest of every Watch, Clock and Chronometer Maker and Repairer to use in his work the **BEST** oil obtainable, regardless of cost. **EZRA KELLEY'S** claim to be the fore-



most manufacturer of the **Best, Purest and Finest Oils**, giving the best results, is not based upon his own assertion, but is founded upon the fact that wherever his oils have been exhibited in competition with other makes subject to an examination by experts, they have received the highest award of merit. We have no hesitation in saying that his oils are the **best** manufactured, always uniform in quality and capable of standing all tests applied to lubricating oils.

P. S.—There are two grades of Clock Oil, the "Superior" and the "American." The Superior is adapted



for lighter bearings, as found in French, German and Swiss Clocks. The American for American Clocks, Gun and Locksmiths' use, it having more body and being adapted for heavier bearings.

The above oils can be procured at all first-class wholesale Watch and Clock Establishments in the United States, as well as at wholesale of his only Agents,

**HENRY GINNEL & CO.,**  
31 MAIDEN LANE, NEW YORK.

**GRIMSHAW & BAXTER,**  
35 GOSWELL ST., LONDON, ENGLAND.

authorities from interfering with the sale of goods in his exhibit in the French section at the World's Fair. The court sustained the motion, and overruled the cross-motion made by complainant to remand the case back to the State Court. It had been taken from there upon the petition of the Exposition. This leaves the Exposition authorities free to control the sale of these foreign exhibits according to the rules and regulations provided.

Max Freund, New York, is dividing his time between the city and the Fair.

Stein & Ellbogen report trade better, travelers doing good business, and orders coming in. Customers now in the city are buying.

S. Strauss, of Backes & Strauss, dealers in precious stones, London, and Robert E.

North, expert diamond cutter, of London, are visiting the Fair.

Joseph Redon, of Limoges, France, head of the house of M. Redon, French china manufacturer, left Friday week for New York, via Cincinnati, and sailed for Limoges on the 30th.

Mr. Clark, of Clark & Coombs, Mr. Becker, of Hancock, Becker & Co., Clarence Bates, with R. L. Griffith & Son, and O. A. Ostby, of Ostby & Barton Co., were interested visitors at the Fair.

Charles J. Adams, of the watch department of Lapp & Fiershem, and Miss Clara Cooley were united in marriage Sept. 26th at the home of the bride, in So. Evanston, Ill. The boys of the house presented the couple with a fine French porcelain clock.

The executive bureau of awards have ap-

pointed the Russian vice-president of the board of judges for Manufactures building to write up all reports. Dr. Charles F. Carpenter has been recalled from Louisville to assist in the preparation of the horological report.

The Wendell Mfg. Co., 67-69 Washington St., are working nights on World's Fair business and special orders that cannot be delayed. They report business better than for some time past, and that the souvenir spoon trade keeps up better than was expected.

"There has been a marked improvement and an improvement in prospects generally," said C. H. Knights. "There need be no alarm felt for Fall business, but we must not raise the standard to last year. We are pleased with the healthy tone of business the past week."

Visitors at the rooms of Chicago Jewelers' Association last week were:

E. R. Shelmerdine, Jr., Santa Rosa, Cal.; S. L. Legro, Santa Rosa, Cal.; J. R. Ormond, Winnipeg, Man.; O. A. Watson, Watsaka, Ill.; Henry Kohn, Hartford, Conn.; J. R. Koche, San Jose, Cal.; L. C. Wallace, Ogden, Utah; Fred D. Carr, Providence, R. I.; A. O. Ostby, Providence, R. I.; P. M. Snyder, Thurmond, W. Va.; D. L. Bowles, Martinsville, Va.; Frank Kind, Philadelphia, Pa.; A. F. Hall, Janesville, Wis.; F. M. Finch, St. Paul, Minn.; R. J. Riles and wife, Palatka, Fla.; Jas. H. Bell, Tarboro, N. C.; D. H. Kaley, Red Cloud, Neb.; J. E. Haep and wife, Montpelier, O.; A. W. Warren, Ogden, Utah; W. B. McLane, Cantril, Ia.; C. F. Lauterbach, Petersburg, Va.; H. Kirgrasser, Mobile, Ala.; E. Walter, Omaha, Neb.; Leon Schwab, New York; R. W. Adams, New York; E. R. Bonnett, Amherst, Mass.; W. H. Oberbeck, St. Louis, Mo.; O. G. Hulberg, Duluth, Minn.; Leon Sachs, New York; F. A. Frey, New York; M. J. Tannerhalz, New York; C. M. Thrasher, Piedmont, W. Va.; F. A. Heberline, New Brighton, Pa.; Geo. M. Geer, Providence, R. I.; E. F. Randolph, Farina, Ill.; Lou Beck and wife, Peru, Ind.; J. H. Whiteside and wife, Liberty, Mo.; Meyer Louis, Pigua, O.; H. J. Hallock, Wyalusing, Pa.; C. F. W. Marquardt, Norfolk, Neb.; H. M. Eliassof, Albany, N. Y.; C. R. Hetter, St. Louis, Mo.; Geo. B. Hare, Ansley, Neb.; H. Rehmke, Ellensburg, Wash.; Chris Senner, Ellensburg, Wash.; Geo. W. Sanders, Marengo, Ill.; A. E. Barre, Seattle, Wash.; S. R. Mace, Moulton, Ia.; Ritter & Tenny, Muncie, Ind.; Geo. W. Cromer, Muncie, Ind.; Robert S. Gardner, Birmingham, Conn.; F. C. Lawrence, Whatcom, Wash.; F. M. Hall, Mooresville, N. C.; A. F. Toepel, Detroit, Mich.; Albert Schaub, Detroit, Mich.; Eugene Deimel, Detroit, Mich.; Robert Croskery, Gladwin, Mich.; C. F. Heintz, Buffalo, N. Y.; E. A. Heintz, Buffalo, N. Y.; H. Krieheder, Buffalo, N. Y.; John C. Dueber,

**ENGEL'S IMPROVED PATENT RING GAUGE.** Ask your Jobber for Them.

ENGEL'S RING GAUGE PAT. SEPT. 23. 90 PAT. SEPT. 1. 91

1 2 3 4 5 6 7 8 9 10 11 12 13

A.W. ENGEL M'FG. CHICAGO U.S.A.

U. S. ED BY ALL BY MAIL SAMPLE 15 CENTS. PRICE PER DOZEN \$1.25



25 DIFFERENT SIZES ALL IN ONE. SIZES CORRESPOND TO ANY STANDARD RING GAUGE. THE DEVICE BEING MADE OF DURABLE FLEXIBLE MATERIAL IN A STRAIGHT TAPE, IS ADAPTED TO BE SENT THROUGH THE MAIL. EXCELLENT ADVERTISING MEDIUM.

SPACE FOR NAME AND ADDRESS WHICH WE PLACE ON LARGE QUANTITIES FREE OF CHARGE. WRITE FOR QUANTITY PRICE

**A. W. ENGEL,** Manufacturer, Jobber and Watchmaker for the Trade

115 Dearborn Street, CHICAGO, Ill.

**HARDINGE ROLLER REMOVERS,** THE BEST ON EARTH.

MANUFACTURED BY

**HOROLOGICAL TOOL CO.**

OFFICE: 86 N. CLARK STREET, CHICAGO.

Factory: 1036 Lincoln Ave., CHICAGO.

For Sale by all Jobbers.





A. A. MARGOT. **MARGOT BROTHERS,** E. F. MARGOT:

Watch Case Manufacturers, Engine Turners and Jobbers, 11 FRANKLIN ST. (FORMERLY 23 WATER ST.) BOSTON, MASS.

Special Attention to Watch Case Repairing, Springing, Re-engine Turning, Engraving, Polishing, etc. Flat Glasses Fitted, Jewelry, Silverware, Dies, etc., engine turned.

Particular Attention to Orders from Expresses.



**MUELLER'S ARTIFICIAL EYES.**

\$75 per hundred; smaller lots, \$15 per dozen; \$2 each. A large assortment of eyes will be sent to any dealer to enable him to make selection, upon receipt of satisfactory references. We carry the largest stock in America.

ONLY MANUFACTURERS OF THE "DIAMANTA" SPECTACLES AND EYE-GLASSES. Oculists' prescriptions promptly and accurately filled. Catalogue, price lists, test cards, etc., on application.

**M. ZINEMAN & BRO.,** American Agents, 130 South Ninth St., Philadelphia.

**THE FINEST OILS EXTANT:**



**Wm. F. NYE** - Superfine - **CLOCK OIL.** New Bedford, Mass. U.S.A. WITHOUT MY SIGNATURE

**Wm. F. NYE** - Superfine - **WATCH OIL.** New Bedford, Mass. U.S.A. WITHOUT MY SIGNATURE

**Wm. F. NYE** - Superfine - **CHRONOMETER OIL.** New Bedford, Mass. U.S.A. WITHOUT MY SIGNATURE

**Wm. F. NYE** - Superfine - **TYPE WRITER OIL.** New Bedford, Mass. U.S.A. WITHOUT MY SIGNATURE

**Wm. F. NYE** - Superfine - **GUN LOCK OIL.** New Bedford, Mass. U.S.A. WITHOUT MY SIGNATURE

**\$1,000 CHALLENGE FOR THEIR EQUAL.**

Canton, O.; Joseph Beyer, Erie, Pa.; Minnie E. Hoy, Bellefontaine, O.; A. M. Lindsey, Coalport, Pa.; E. H. Pritchett, Linden, Ont.; E. M. Collins, Blissfield, Mich.; Edward E. Bruder, Columbus, Miss.; Wm. K. Krips, Philadelphia, Pa.; John A. Hagen, St. Louis, Mo.; B. L. Burbank, Allison, Ia.; M. N. Berg and wife, Cloquet, Minn.; S. Strauss, London, England; Robert E. North, London, England; N. Ellis, Toronto, Can.; Albert C. Bleich, Paducah, Ky.; John F. Meyer, Paducah, Ky.; Leo. A. Heilborn, No. Attleboro, Mass.; A. E. Coddling Jr., No. Attleboro, Mass.; O. H. Stackett, Havana, Ill.; J. B. Dehm, Havana, Ill.; Fred H. Taber, Grand Ledge, Mich.; F. Cawker, Telluride, Col.; John Banner, Omaha, Neb.; D. G. Langendorf, Camden, N. J.; L. M. Lowenthal, Dexter, Ia.; L. C. Wiser, Mankato, Minn.; Henry Wexel and wife, Attleboro, Mass.; James Peacock, New York; Fredk. Mockridge, Newark, N. J.; Albert Weber, Fenimore, Wis.; A. Peterson and wife, Minneapolis, Minn.; K. Carson, Ballinger, Tex.; Joseph M. Schaefer, Pittsburgh, Pa.; Geo. B. Owen, Jr., New York; Mrs. M. Marks, New York; Miss M. Lafoin, New York; J. R. Young, Bourbon, Ind.; J. H. Gregory, Washington, D. C.; W. H. Ogle, Centerville, Ia.; Mr and Mrs. E. J. Cain, Lodi, Wis.

### Detroit.

Charley Morrison and Eugene Deimel returned last week from Chicago.

F. C. Langerwisch, formerly a well known jeweler at Novi, Mich., died last week of consumption.

Hugh Connelly, of Black & Connelly, left for Stratford, Ont., last week, where his mother is seriously ill.

R. E. Kiel, representing F. H. Noble & Co., Chicago, visited the jobbing trade here last week. He says business is better in Canada than over the line.

S. A. Hammond, Novi, Mich., bought goods here last week. He is looking for a western location, and will probably start a jewelry business at some point in Montana.

The following Detroit jewelers were in Chicago last week: R. Rolshoven, who returned Oct. 2d, A. F. Toepel, M. S. Smith, 2d, and the proprietor of the Instalment Watch Co.

William Walthers, for eighteen years a jeweler at Wyandotte, Mich., has sold his store and real estate. He is looking for another location and will shortly move his stock to some other city.

Business with the jobbers brightened up last week. Mail orders were unusually heavy. Country jewelers in this vicinity are beginning to freshen up stocks that have been allowed to run low. The following were in the city last week: J. P. Van Alstine, Morenci; George Chambers and wife, Mt. Clemens; S. A. Hammond, Novi; A. B. Scattergood, Ithaca, and Herman Jacobs, Sand Beach.

### Lancaster, Pa.

James Perry, who was arrested in this city for robbing the jewelry store of Frank E. Bailey, Steelton, pleaded guilty on Monday last and was sentenced to two years' imprisonment.

The jewelry store of J. S. Keagy, Hollidaysburg, was broken into last Friday night and gold pens, rings, and spectacles etc., to the value of \$350 taken. The robbers tried to open the safe, but were not successful. There is no clue to the robbers.

Henry C. Foehl celebrated three important events last Sunday, his silver wedding, the forty-seventh anniversary of his birth and the christening of his young son, Charles Peter Foehl.

### Connecticut.

The Meriden Bronze Co.'s works now run full time six days a week.

W. P. Morgan, who has charge of the Meriden Britannia Co.'s business in San Francisco, is in Meriden for a short time.

Col. W. J. Leavenworth has returned from the World's Fair; Gurdon W. Hull is in Montreal; jeweler R. N. Johnquest, Ansonia, has returned from Old Point Comfort and West Virginia.

Business continues to improve at the various silver plate factories in Meriden and the change is noticeable in the plating, burnishing and buffing departments. The Meriden Silver Plate Co. are getting out some beautiful silver mounted pictures of Lillian Russell.

Two handsomely mounted silver cups were last week on exhibition in the windows of the firm of Lake, Strobel & Co., Waterbury. They are to be known hereafter as the Col. Doherty and Col. Burpee cups, and are to go to the Second regiment, to be shot for every year at the annual regimental tournament. The cups were made by Simpson, Hall, Miller & Co.

The town authorities of Avon, Canton, Burlington, Barkhamstead, Farmington, New Hartford and Simsbury at a joint convention held recently adopted under the new Connecticut law regarding peddlers and itinerants a schedule of rates taxing such peddlers and itinerants. The tax fixed for peddlers of jewelry and silverware is: for persons on foot, \$24 a year; with teams \$48 a year.

Peter J. Strain, Waterbury, was seized with a fit of insanity at his home last Saturday evening and attempted to cut his wife's throat with a razor. Mrs. Strain escaped to the apartments of a family upstairs. Two policemen were summoned, but Mr. Strain had barricaded all the doors and his wife requested the officers not to break in lest the insane man might do himself harm. Mr. Strain was in the jewelry business on Bank St., and met with business troubles about two years ago, since which his mind has been failing.

### Baltimore.

D. J. Emich, Sr., jeweler, 1009 N. Broadway, is nominee for the House of Delegates of the Prohibitionists of the first Legislative District.

Jewelers in Baltimore are trying to intro-

duce the habit practised by many of the society women of Florida, that of wearing chameleons. Several are now on exhibition in stores along Baltimore St. The women of Florida have little silver rings put on the lizards' necks, and to this they attach a string, allowing the animal to crawl over their shoulders and about their hair.

One of the very interesting gifts which Cardinal Gibbons will receive on the occasion of the celebration of Oct. 15, will be a free set of archiepiscopal jewelry, pectoral cross, episcopal ring, crozier, chalice and archiepiscopal cross. These articles will cost in the neighborhood of \$40,000. For costliness, beauty of design and execution of finish, it is claimed they have never before been duplicated.

### THE DRUMMER.

A LITTLE chaff, a merry laugh,  
A word for every comer;  
There is not a man in all the land  
But who extends a ready hand  
To greet the jolly drummer.

In business wise, in enterprise  
As thrifty as a plumber;  
So chivalrous and debonnaire,  
This favored one that ladies fair  
All love the gallant drummer.

His latest joke it will provoke  
A roar from every bummer  
That hangs around the village bar,  
Reflecting lustre from his star—  
The gay commercial drummer.

With work and wit he hits the grit,  
Fall, Winter, Spring and Summer;  
Alert and watchful day and night—  
The world would go to ruin quite  
But for the busy drummer.

A skull that's numb may beat the drum,  
But, ah! it takes a hammer—  
A freak of supernatural brood—  
Some being most supremely shrewd  
It takes to beat the drummer.

—M. M. Folsom.

## W. F. Evans & Sons

### SOHO CLOCK FACTORY,

HANDSWORTH,  
BIRMINGHAM,  
ENGLAND.

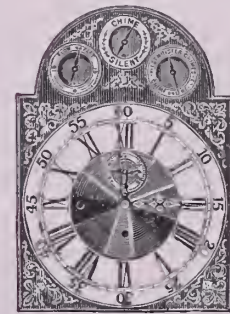

ORADPATTERN CLOCK

Manufacturers of  
CHURCH,  
CHIME &  
QUARTER  
CLOCKS,

SCHOOL AND  
HOUSE CLOCKS

With arch brass dials to chime upon  
Bells, Gongs, and Harrington's  
Patent Tubes.

ESTABLISHED 1805.

## THE IMPROVED RIVAL FOUNTAIN PEN.

Most Reliable and Guaranteed to Give Perfect Satisfaction. Over 75,000 in Use.

Send for  
Price List.



Liberal Dis-  
counts to  
the Trade.

D. W. BEAUMEL, Inventor and Manufacturer,  
REPAIRING A SPECIALTY, 17 John St., New York,



61 Hanover Street, Boston, Mass.

Sales made for Jewelers only in their established places of business. Can give best references of any auctioneers in America.

All communications strictly confidential.

**Pacific Coast Notes.**

G. F. Willis is about to open a jewelry store in Farmington, Wash.

H. S. Parlin Stockton, Cal., is selling out his business at auction.

Hoyt Bros. are about to embark in the jewelry business at Monmouth, Ore.

Chas. T. Pomeroy, Woodburn, Ore, has received a deed for a nominal consideration.

Judgment has been entered against F. C. Lawrence, New Whatcom, Wash., for \$271.65.

V. Hunziker has bought a half interest in Geo. Ludwigs' jewelry business, Walla Walla, Wash.

C. H. Hinges, formerly of Fairhaven, Wash., is now in the jewelry business in Portland, Ore.

H. A. Whitman, jeweler, Hubbard, Ore., is under arrest, charged with being one of the leaders in an anti-Chinese movement whereby eighteen Chinese were driven out of Hubbard some days ago.

The store of Bernard F. Fink, 1144 Pacific Ave., Tacoma, Wash., was recently entered by burglars who took eight clocks and jew-

elry valued at \$200. The burglars used skeleton keys to make an entrance. There is no clue to the thieves.

**Minneapolis and St. Paul.**

W. C. Weld, Minneapolis, has gone to Chicago on business.

F. A. Defiel, St. Paul, has returned from a visit to the World's Fair.

Frank A. Upham, St. Paul, and N. P. Peterson, Minneapolis, have gone to Chicago.

O. M. Draper, Attleboro, Mass., called on the Twin Cities jobbers the past week.

C. C. Bergh, St. Paul, has removed from 47 E. 3rd St. into a new store at 91 E. 7th St.

C. Marshall, of B. B. Marshall & Son, Minneapolis, left last week for the east on business.

A. Wahlberg, Minneapolis, has removed from 1111 Washington Ave. S., to 1117 same street, where he now occupies an entire store.

United States Marshal Sheehan brought to St. Paul last week A. Fenner, charged with counterfeiting in changing silver quarters to represent ten dollar gold pieces. Fenner lived at Cold Springs, Minn. and is a jeweler.

Out-of-town jewelers visiting the Twin Cities the past week were: G. H. Doerr, Spokane Falls, Wash.; J. D. Leys, Butte, Mon.; H. Rehmke, Ellensburg, Wash.; F. J. Schisler, Blooming Prairie, Minn.; N. C. Pabst, Fargo, Dak.

Last week a young man entered the store of Henry Jacke, St. Paul, and asked to see some diamond rings which were displayed in the show window. The rings were shown him but the would-be purchaser could not find anything in stock to suit him. When he was about to leave the store Mr. Jacke discovered that the man held a ring in his hand. The man started to run into the street, followed by Mr. Jacke who succeeded in overtaking the thief and turning him over to a policeman for arrest. The prisoner had a hearing the next day and was found guilty of petty larceny and sentenced to the county jail for ninety days.

**Denver.**

M. Lippold has been succeeded by M. Ramey.

Three large judgments were awarded in the District Court Sept. 21st, against the Green-Smith Watch & Diamond Co. The Denver National Bank secured judgment for \$26,749.60; Susan T. Knox for \$53,114.25; and John W. Knox for \$65,000.

The Denver Jewelry Mfg. Co., of this city, have incorporated with a capital stock of \$5,000 to manufacture and sell jewelry, etc. The incorporators are Lillian Reiche, Robt. E. Reiche, Thos. J. Lewis, Jas. B. Ross and Frank J. Donk, all of this city.

William A. Latta, a few days ago was viciously assaulted and seriously in-

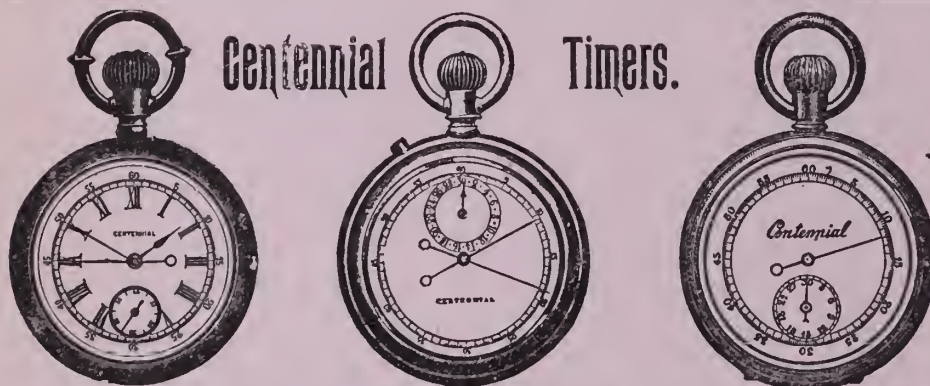

These watches are one-third larger than above cuts.

**CROSS & BEGUELIN,**  
Manufacturers, Importers and Jobbers of  
Watches, Diamonds, Jewelry, Watch Materials, etc.,  
17 MAIDEN LANE, NEW YORK.

**BLANCARD & CO.,**

LATEST ROCOCO DESIGN IN GALLERY.



DIAMOND SETTINGS. GALLERIES. HOLLOW BALLS, ETC.

SEND FOR OUR CATALOGUE.

45 & 47 John St., New York.



jured by a Mr. W. O. LeTord and his wife, in trying to collect a debt. Mr. Latta some time since took a mortgage on \$400 worth of diamonds which the LeTords purchased. The jeweler when rescued by neighbors, was still unconscious. He was removed to police headquarters, where the police surgeon found that Latta had been dangerously wounded in the stomach. He recovered sufficiently later in the day to swear out a warrant for LeTords' arrest.

### Boston.

E. V. Clergue, of the E. Howard Watch and Clock Co.'s New York office, was in town last week.

Frederick E. Harwood has returned from a trip to Chicago, and Charles Harwood is enjoying an outing this week at the World's Fair.

Buyers in town the past week included: D. M. Quimby, Exeter, N. H.; G. W. Furbur, Hartland, Me.; N. L. Hildreth, Marlboro, Mass.; G. H. Willoby, Franklin, Mass.; H. S. Tanner, Providence, R. I.; J. J. Woodward, Somersworth, N. H.; R. H. Boynton, Portland, Me.; B. S. Kingman, Newmarket, N. H.

William O'Brien who is charged with breaking and entering the store of Joseph Waxman, 807 Washington St., on the night of Feb. 19, 1892 was brought to Boston Thursday from Joliet, Ill., where he has been serving time. Witnesses have given information to the effect that two men were seen coming from the store with a tray of goods and one of the gang of thieves to which they belonged has confessed to this and other robberies in which they were implicated.

### The Attleboros.

J. Irving Metcalf is touring the west.

Roy Blackinton, son of Ross Blackinton, has entered the office of R. Blackinton & Co.

J. L. Sweet has been chosen a member of the Democratic committee-at-large for Massachusetts.

The Democrats of the town met last week and among the hosts of delegates chosen for councillor were Albert Totten, J. G. Barden and T. W. Draper.

E. S. Horton, J. F. Streeter, G. F. Bicknell, A. W. Sturdy, W. H. Smith, A. R. Crosby and E. C. Martin are delegates for the Bristol G. A. R. convention.

H. D. Merritt has returned from the World's Fair. He resigned his position in the office of H. D. Merritt & Co., in order to re-enter Tufts College.

Sanford L. Wood, a young watch case maker of Providence, who was arrested at his mother's home in Attleboro Falls last Monday on a charge of having assaulted his wife, was re-arrested the next afternoon upon a more serious charge. This time the warrant reads that Wood assaulted his wife with intent to kill.

In North Attleboro, the Republican party has elected for delegates to the various conventions, the following jewelers: State, Thomas G. Sandland, Charles T. Guild, Edwin Whiting, E. I. Franklin; councillor, R. Blackinton, W. W. Fisher, O. L. Swift; county, B. S. Freeman, Jr., J. E. Sturdy, S. E. Fisher, Stephen Stanley; senatorial, C. I. Richards, C. H. Randall, and D. S. Hall.

### Pittsburgh.

Will Seidle, of R. Seidle & Sons, is seriously ill.

J. C. Grogan will be found among October visitors in Chicago.

The new building of Heeren Bros. & Co., is now under roof, and will be occupied in the early spring.

James Gregory, jeweler, Washington, D. C., is visiting his brother, C. E. Gregory, Hazelwood, this city.

### Death of Stephen Albro.

PROVIDENCE, R. I., Oct. 2.—Stephen Albro, formerly of the large manufacturing jewelry concern of S. Albro & Co., died at Butler's Asylum for the Insane, late Saturday night, after an illness of more than a year. While his death had been expected for several weeks it came suddenly at the end, as few of his most intimate acquaintances were aware that he was so low.

The deceased was born in 1839 at South Portsmouth, R. I. In 1867 he removed to this city and opened a large gents' furnishing goods store on Westminster St., building up one of the largest businesses in that line in the city. He continued here until about 1875, when he sold out and changed to the manufacturing jewelry business.

His firm soon took high rank among similar concerns of New England. On Oct. 1, 1891, the name of the firm was changed to the S. Albro Co., with acts of incorporation under the laws of the State of New York, Mr. Albro being president. Early in the Spring of 1892, Mr. Albro began to show indications that he was suffering from brain troubles which rapidly developed until he became very violent and about the first of March, 1892, it was found necessary to place him under restraint and treatment. He was accordingly removed to the Butler's Asylum where he has since been an inmate.

The deceased was one of the best known jewelers in this city, and was widely connected with social life of Providence. He was an active member of the New England Manufacturing Jewelers' Association, of the Manufacturing Jewelers' Board of Trade, of the West Side Social Club, the Elmwood Club, the Pomham Club and the Union Club, and a member of St. John's Lodge and other Masonic fraternities of Newport. He leaves a widow and one child to mourn his loss. His funeral will be solemnized from Belmont Chapel, Newport, at 12.30 o'clock Tuesday.

### Last Week's Arrivals.

*THE CIRCULAR has perfected arrangements for obtaining the names and hotel addresses of all the latest buyers visiting New York, and each day posts in its office, 189 Broadway, a bulletin which every member of the trade is cordially invited to copy.*

The following out-of-town dealers were registered in New York during the past week: A. M. Hill, New Orleans, La., Marlborough H.; S. Thomas, Charleston, S. C.; L. H. Bonestell, San Francisco, Cal., Grand Union H., Mr. Whittier, Providence, R. I., Grand Union H.; D. P. Smyth, Wilmington, Del.; Astor H.; H. Miller, buyer for Barnes, Hengerer & Co., Buffalo, N. Y., Imperial H.; J. Lewis, Boston, Mass., Coleman H.; F. Souter, Philadelphia, Pa., Astor H.; H. Schwartz, Philadelphia, Pa., Astor H.; D. B. Ryland, Lynchburg, Va.; F. M. Brown, New Haven, Conn., 108 Worth St.; J. Fleischman, Chicago, Ill., Astor H.; D. C. Elsheimer, Rochester, N. Y., Union Square H.; F. H. Sloan, Hartford, Conn., Imperial H.; I. Levi, Baltimore, Md., Cosmopolitan H.; M. Eiseman, Chicago, Ill., Broadway Central H.; C. S. Davis, Philadelphia, Pa., Astor H.; I. Wolf, San Francisco, Cal., Marlborough H.; E. L. Everett, Washington, D. C., Murray Hill H.; G. A. Reidpath, buyer for R. H. White & Co., Boston, Mass., Imperial H.; H. E. Hall, buyer for Forbes & Wallace, Springfield, Mass., Murray Hill H.; W. F. Waters, buyer for Jordan, Marsh & Co., Boston, Mass., 8 Greene St.; R. E. Johnson, Cumberland, Md., Astor H.; L. E. Kirstein, Rochester, N. Y., Imperial H.; M. W. Shaw, Galveston, Tex., St. Stephen H.; I. D. Landis, Coatsville, Pa., Rodgers H.; J. E. Jarck, Danville, Va., Astor H.; W. D. Moses, Richmond, Va., Albemarle H.; L. Hahn, New London, Conn., St. Denis H.; Mrs. A. E. Martin (Cooke & Martin), Jacksonville, Fla., Astor H.; G. Kaufman, Pittsburgh, Pa., Gilsey H.; L. A. Krull, Buffalo, N. Y., Sinclair H.; W. J. Hoggson, New Haven, Conn., Park Avenue H.; A. K. Hawkes, Atlanta, Ga., Astor H.; J. Newman, San Francisco, Cal., Imperial H.; J. Cahill, Boston, Mass., Continental H.; J. Rosenstock, Baltimore Md., Astor H.; Mr. Nordlinger, Los Angeles, Cal.; J. W. Campbell, Chicago, Ill., Cosmopolitan H.; A. Anderson, Boston, Mass., Murray Hill H.; R. J. Wilson, Philadelphia, Pa., Morton H.; M. Ellis, Toronto, Ont., Astor H.; J. H. Crosby, Jacksonville, Fla., St. Denis H.; B. Lemon, Louisville, Ky., St. Denis H.

### Indianapolis.

Jewelers Emmet Pee, Louis C. Lowes and Rhiney Miller are off on a fishing trip.

Monroe City, Ind., is soon to have a new jewelry store. Mr. Bonewitz will be proprietor.

J. C. Sipe, the instalment jeweler, 18 N. Meriden St., recently purchased all the leases and accounts of the F. E. Fuller Instalment Co.

# THE COLUMBIA.

★ ROGERS & BRO., A.-I.

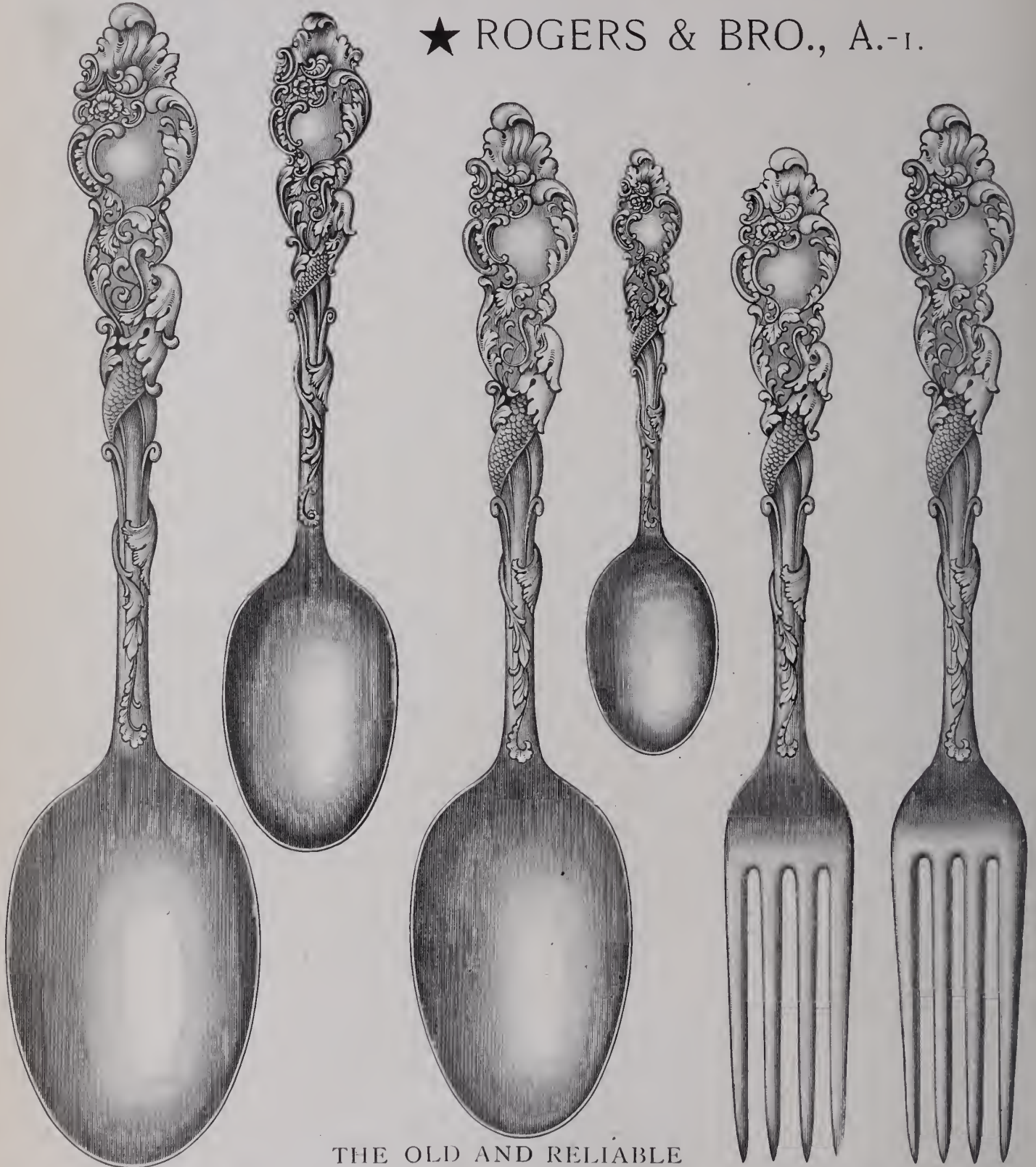

THE OLD AND RELIABLE

# STAR ★ BRAND

Electro Silver Plated Flatware.

# THE COLUMBIA.



MADE IN

EXTRA PLATE PER DOZ.  
SECTIONAL PLATE XI PER DOZ.  
TRIPLE PLATE PER DOZ.

SPoons

TEA	-	-	-	\$4 75	\$5 50	\$7 25
DESSERT	-	-	-	8 50	9 63	12 50
TABLE	-	-	-	9 50	11 00	14 50
FIVE O'CLOCK TEA	OR					
CHILDREN'S	-	-	-	4 75		7 25
COFFEE	-	-	-	4 75		7 25
ORANGE	-	-	-	6 00		9 00
BOUILLON	-	-	-	9 00		13 00
BERRY OR NUT	-	-	-	24 00		36 00
SALAD	-	-	-	36 00		48 00

FORKS

DESSERT	-	-	-	8 50	9 63	12 50
MEDIUM	-	-	-	9 50	11 00	14 50
OYSTER	-	-	-	7 00		11 00
STRAWBERRY	-	-	-	7 00		11 00
CHILDREN'S	-	-	-	7 00		10 00
SALAD	-	-	-	36 00		48 00
SALAD, INDIVIDUAL	-	-	-	9 00		13 00
FISH	-	-	-	42 00		60 00

KNIVES

BUTTER, TWIST HANDLES	-			10 50		14 50
BUTTER PICKS	-	-	-	10 50		14 50
BUTTER SPREADERS, INDIVIDUAL	-	-	-	9 00		13 00
CHILDREN'S	-	-	-	9 00		12 00
PIE	-	-	-	42 00		60 00
PIE, ICE CREAM OR CAKE						
SERVERS, Hollow Handles	-	-	-	42 00		
FISH	-	-	-	42 00		60 00
CRUMB	-	-	-	48 00		72 00

LADLES

GRAVY	-	-	-	18 00		27 00
OYSTER	-	-	-	39 00		57 00
MEDIUM	-	-	-	48 00		72 00

SHELLS AND TONGS

SUGAR SHELLS	-	-	-	9 00		13 00
SUGAR TONGS, Tête-à-Tête	-	-	-	18 00		24 00

CHILDREN'S SETS

(KNIFE, FORK AND SPOON)						
ON FANCY COLORED CARDS	-	-	-	24 00		
IN PLUSH LINED BONES	-	-	-	25 50		

Nickel Silver Hollow Handle Knives

DESSERT	-	-	-	14 00		
MEDIUM	-	-	-	16 00		

GOLD LINED AND SATIN ENGRAVED BOWLS AND BLADES, EXTRA

STAMPED

★ ROGERS & BRO., A-1.

WHICH HAS STOOD THE TEST FOR FIFTY YEARS

FOR SALE BY ALL FIRST-CLASS JOBBERS.

MANUFACTURED ONLY BY

ROGERS & BROTHER,

Waterbury, Conn.,

16 Cortlandt St., N. Y.

SEND FOR NEW CATALOGUE NOW READY.

### Philadelphia.

E. M. Stern has returned from a trip to Attleboro and New York.

J. Warner Hutchins departed for the World's Fair on Saturday last.

Philip Stevens has completed extensive repairs to his store in Frankford Ave.

L. P. White has abandoned Atlantic City and has again taken up his residence in Philadelphia.

J. E. Caldwell had a unique and striking window decoration in honor of the visit of the Australian cricketers to this city.

A committee has been appointed by the Jewelers' Club to arrange for a series of entertainments during the Winter months.

Judgments were past week issued against Augustus Coran, 305 Market St., on four notes in favor of D. F. Conover & Co. for \$597.76; S. C. Behm, \$448.25; Fred. Karl, \$335.50, and Behm & Gerhardt, \$206.28; all dated on the 21st ult. and payable in one day.

Charles Hollinshed, Jr., the twelve-year-old son of Police Commissioner Hollinshed, of Camden, while playing on a scaffold in the new building of the North Baptist Church this week stepped on a board which broke with him and precipitated him to the ground, a distance of about 60 feet. He was taken to his home where a physician was summoned. The lad is in a very precarious condition.

On Wednesday last jeweler Walter Harman was charged before Magistrate Ladner with larceny as bailee of numerous watches given him to repair. Harman was held in \$1,500 bail for a further hearing.

John Williamson pleaded guilty in quarter sessions on the 25th ult., to smashing the window of John Bernkopft's jewelry store, 257 N. 9th St., and stealing four diamond rings and two gold lockets. He was sent to the Eastern penitentiary for eighteen months.

Simons, Bro. & Co., at the close of the World's Fair, will present to Mrs. Potter Palmer a beautiful thimble which is in their exhibit. The article is of gold, exquisitely made and is set with forty diamonds around the rim. It bears a design of Machinery Hall with "World's Columbian Exposition, 1492-1892," in relief.

### Providence.

William Loeb has returned from a prosperous business trip through Canada and the west.

George H. Kettley, of Patt, Kelley & Kern, is in Chicago, combining business with pleasure.

Robert C. Fletcher has started in the retail business at the corner of Westminster and Snow Sts.

Rud C. Hahn, New York, has opened an office at 103 Westminster St., Room B. William C. Hunter will have charge of it.

William G. Hopkins, administrator of the estate of the late Walter E. White, has offered the shop of W. E. White & Co. for sale.

F. Kohlhagen, for many years with the Gorham Mfg. Co., has been appointed teacher to the modeling class at the Rhode Island School of Design.

Robert Tipping who was recently arrested for purloining gold wire from his employers, Kirby, Mowry & Co., pleaded guilty to the charge of larceny last week and was sentenced to fifteen months' imprisonment.

Herbert S. Barrows, formerly with H. C. Lindol, and Charles H. Kenaston, for several years with R. D. Hertton, have formed a co-partnership for the manufacture of jewelry, under the style of the Whatcheer Jewelry Co. They have purchased the plant of Bride, Revens & Co., 143 Summer St., where they will continue the business. They have given a chattel mortgage of \$200 to Mary A. Trimbell on all the machinery, tools, fixtures, stock, etc.

The final open competition of rifle shooting by members of the Rhode Island State Militia occurred last Friday. Among the crack shots are the following: Capt. Geo. A. Forsyth, (Co. G. 1st Regt.) with Thornton Bros., 200 yards, 42 points, 300 yards, 46, 500 yards, 47, total 135 out of a possible 150; Private Harry D. Gorman (Co. G. 1st Regt.) with Martin, Copeland & Co., 200 yards, 42, 300 yards, 42, 500 yards, 45, total 129; Capt. Jerome Fitzgerald (Aide-de-camp on Brig. Gen. Kendall's staff), of Hope Silverware Co., 200 yards, 42, 300 yards, 42, 500 yards, 43, total 127.

About two months ago three or four of the large retail jewelers of this city were the victims of a pair of cool and daring thieves who succeeded in obtaining upwards of \$1,000 worth of booty in broad daylight by their daring schemes. Leopold Goldstein had the toughest experience with the duo, for he was attacked and struck down by a blow from a slung shot and severely injured. The principal operator in this affair, a youth claiming to be William Lipman, was captured after a long chase. Friday morning he was sentenced to twenty years' imprisonment.

The new building to be erected by the Kent & Stanley Co., at the junction of Sabin, Aborn, Beverly and Mason Sts., will cover an entire block, 280 by 120 feet. It will consist of six stories and a basement, and will be constructed of brick with free stone trimmings. In the center will be a rectangular court yard, 40 feet wide and about 200 feet long. The area of each floor will be about 25,000 square feet, and the building will probably be the largest jewelry factory structure in the United States if not in the world. All modern conveniences will be introduced and ample light will be supplied to every part of the structure. It is estimated that the cost will be about \$300,000. The building will be ready for occupancy in about a year.

# LE BOUTILLIER & Co.,

860 BROADWAY,

N. E. cor. of 17th St., - NEW YORK,

Invite an Inspection of their  
Novelties in

ROYAL WORCESTER,

WEDGWOOD,

CROWN DERBY,

COALPORT,

PÂTE SUR PÂTE,

BISQUE.

Prices are very low this season, and dealers will find many exclusive styles in our stock.

### News Gleanings.

M. C. Ramsey & Co., Rico, Col., have dissolved.

John Kray has opened a jewelry store in Des Plaines, Ill.

W. D. Smith, Kent, Wash., has given a bill of sale for \$500.

Chas. G. Willson, Reading, Pa., has given a mortgage for \$1,500.

Frank Hughes has opened a jewelry shop in Oswego Falls, N. Y.

T. M. Bceson has removed from Prescott, Ariz., to San Diego, Cal.

The C. S. Hook Co., Memphis, Tenn., have made an assignment.

E. Frantz has bought W. H. Wheeler's jewelry store, Palmyra, Ill.

Ober & Phillips have removed from New Enterprise, Pa., to Everett, Pa.

The store of Frank Clark, Princeton, Minn., was burned out last week.

W. W. Shockley, Middletown, Del., has opened a new store in the Ingram building.

Charles D. Hedinger and wife, Clio, Mich., have given a chattel mortgage for \$200.

Judgments aggregating \$550 have been entered against James M. Balmaine, Buffalo, N. Y.

H. A. Harrison, Sault de Ste. Marie, Mich., has given a chattel mortgage for \$3,300.

John E. Thoma, Kalamazoo, Mich., has given seven chattel mortgages aggregating \$3,067.

F. Duncan, of F. Duncan & Sons, oculists, Des Moines, Ia., has given a chattel mortgage for \$335.

Milton Kohler, Hagerstown, Md., has been appointed watch inspector of the Western Maryland Railroad.

In the destructive fire in St. Joseph, Mo., last week, W. F. Kirkpatrick & Co., jewelers, suffered a slight loss.

A. Chatelain, Danville, Va., has given a deed of trust on real estate for \$1,600 to secure \$800 borrowed money.

Mr. Schless, who has a jewelry store in Wilmington, Del., will open a branch store in Trenton, N. J., this week.

C. E. Henrickson, Chattanooga, Tenn., has given a deed of trust to W. H. Payne, trustee, securing amounts aggregating \$804.

Joseph M. Knight, formerly watchmaker for Preston Ayres, Wilmington, Del., has opened a repair shop at 2 E. 7th St., that city.

Samuel Mallory, of Mallory & Hollenbeck, Catskill, N. Y., had a stroke of paralysis last week and is now lying in a critical condition.

The secretary of Retail Jewelers' Association, of Alabama, has been instructed to postpone indefinitely the meeting of the organization, as many members have written they cannot now visit Birmingham.

A judgment for \$130 has been entered against C. G. Christopherson, of Carpenter & Christopherson, Buffalo, N. Y.

The Young Men's Association, of Dunkirk, N. Y., last week met to consider the proposition of a manufacturer of plush jewelry cases who is anxious to locate there.

L. Emery, Jr. & Co., Bradford, Pa., are tearing out the front and partition wall of the room next to their jewelry department in order to enlarge the room.

H. M. Rich & Co., jewelers' auctioneers, 61 Hanover St., Boston, Mass., report sales last month for L. H. Pratt & Co., Fitchburg, Mass., and C. E. Eager, Syracuse, N. Y.

The marriage of Frank T. Koons, jeweler, Allentown, Pa., to Miss Georgiana Schoenfelder, of Rochester, N. Y., took place last Tuesday morning at the home of the bride.

C. H. Andrews, Frankfort, Kan., has sold a half interest in his jewelry and music store to T. P. Ceaser and the business is now transacted under the firm name of Andrews & Ceaser.

The third class creditors of Jas. M. Chapel & Co., Richmond, Va., a full account of whose failure was published in THE CIRCULAR last week, will not receive more than 70 per cent. of their claims.

J. H. Knickerbocker and J. C. Leibel have completed arrangements for establishing a manufacturing jewelry plant in Salt Lake City, Utah, and expect to have it in operation within thirty days.

Frank Shercliff, alias "Kid" McCoy, convicted of assaulting and robbing W. G. Pollack, of W. L. Pollack & Co., New York, was sentenced to seventeen years at hard labor in the penitentiary at Fort Madison.

The Columbian Clock Co. have organized at Kittery, Me., for the purpose of manufacturing and dealing in electric clocks, with \$250,000 capital stock of which \$150 is paid in. The officers are: President, Chas. J. Noyes, of Boston, Mass.; treasurer, Wm. S. King, of Boston, Mass.

The fixtures and stock of Fred. Wilson, Waukesha, Wis., are in the hands of the sheriff under a chattel mortgage held by Charles Cork.

Burglars entered the house of jeweler Jacob Glick, Stockton, Cal., a few nights ago, and carried away valuables and coin to the amount of \$300. They chloroformed the family and made a thorough search for the plunder.

Last Sunday night the finding of a door open in the rear of Roulet & Baker's store, Toledo, O., gave rise to a rumor of an attempted burglary. It appears that the policeman who found the door open thought he heard a noise in the store, but when it was explored there was nothing missing, nor was there any sign of anybody being in the place.

#### Philip Silverthau Fined Under a New Connecticut Law.

WATERBURY, Conn., Sept. 30.—In the police court to-day, Philip Silverthau, of S. Silverthau & Sons, New Haven, was tried for peddling jewelry in this city without a license, the arrest being the first made here under the law concerning itinerant peddlers passed by the last General Assembly.

His counsel, Judge Lowe, entered a demurrer to the charge which Judge Root overruled, and as the defense did not wish to try the case in this court a fine of \$50 and costs was imposed. An appeal was taken to the Superior Court and the bond was fixed at \$300 which was furnished.

#### A Short Respite from this Young Lady's Tricks.

JERSEY CITY, N. J., Sept. 29.—Before Judge Hudspeth, in Special Sessions this morning, Evelyn Henry, a colored woman, was tried for grand larceny. She was charged with substituting a glass ring for a diamond ring worth \$125, in the jewelry store of Adolph Walter, 52 Newark Ave., on Sept. 19th.

The court found her guilty, and imposed a sentence of one year and a half at hard labor in the State prison.

## W. B. & C.

Watch Glasses and Spectacle Lenses.

Received  
the Highest  
Award  
at the Columbian  
Exposition.

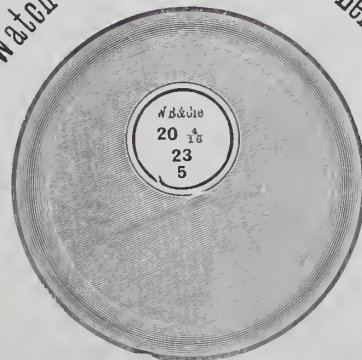

Ask  
Your Jobber  
for the  
W. B. & C.  
Watch Glasses.

They are the Best and  
Cheapest at the  
End.

A. BERGER & CO.,

47 MAIDEN LANE, N. Y.

**CLASSIFIED INDEX TO ADVERTISEMENTS.**

All Advertisements are entitled to one insertion under proper heading. Extra insertions, \$6.00 per annum. Extra Headings, \$12.00 per annum.

<p><b>Art Pottery, Bric-a-brac, Etc.</b>                  Ahrenfeldt &amp; Son, 56 Murray St., N. Y. .... 52                  Bing, Ferdinand &amp; Co., 106 Grand St., N. Y. ... 50                  Borgfeldt, Geo. &amp; Co., 18, 20 &amp; 22 Washington Place, New York.....54-55                  Bradley &amp; Hubbard Mfg. Co., Meriden, Conn 8                  Buning, F. W. &amp; Co., 58 Murray St., N. Y. ... 5                  Craighead &amp; Wilcox, 33 Barclay St., N. Y. .... 59                  Gleanzer Leon, J. &amp; Co., 80 &amp; 82 Chambers St., N.Y. .... 53                  Hinrichs &amp; Co., 29 &amp; 31 Park Place, N. Y. .... 58                  Le Boutillier &amp; Co., 860 Broadway, N. Y. .... 40                  Levy, Dreyfus &amp; Co., 9 &amp; 11 Maiden Lane, N.Y 56                  Scott, De B. O., 20 Murray St., N. Y. .... 43                  Straus, L. &amp; Sons, 42 to 48 Warren St., N. Y. ... 18</p> <p><b>Auctioneers.</b>                  Firuski, S. &amp; Son, 85 Bowery, N. Y. .... 43                  French, J. H., P. O. Box 2775, New York. .... 5                  Rich, H. M. &amp; Co., Boston, Mass. .... 36</p> <p><b>Assayers &amp; Refiners.</b>                  Clark, J. L., Philadelphia, Pa. .... 49                  Howard, S. P., 8 John St., N. Y. .... 60                  Le Long, L. &amp; Bro., Newark, N. J. .... 60                  Rathbone, J., Providence, R. I. .... 45</p> <p><b>Badges, Medals, Etc.</b>                  Irons &amp; Russell, Providence, R. I. .... 29                  Schlechter, G. A., Reading, Pa. .... 15                  Stockwell, E. R., 19 John St., N. Y. .... 4</p> <p><b>Chains, Seamless.</b>                  Kent &amp; Stanley Co., Providence, R. I. .... 4</p> <p><b>Chronometers.</b>                  Bliss, John &amp; Co., 128 Front St., N. Y. .... 14</p> <p><b>Chrome Steel.</b>                  Chrome Steel Works, Brooklyn, N. Y. .... 12</p> <p><b>Cleaning Solution.</b>                  Quarters, W. F., Providence, R. I. .... 13</p> <p><b>Clocks, French and English.</b>                  Jacques, Chas., Clock Co., 22 Courtlandt St., N. Y. .... 60</p> <p><b>Clocks.</b>                  Evans W. F. &amp; Sons, Birmingham, Eng. .... 35</p> <p><b>Cut Glass.</b>                  Mt. Washington Glass Co., New Bedford, 58</p> <p><b>Diamond Cutters.</b>                  Humphrey, J. B., Boston, Mass. .... 52</p> <p><b>Diamond &amp; Precious Stone Importers.</b>                  Disselkoe, John N., 19 E. 16th St., N. Y. .... 47                  Falkenau, Oppenheimer &amp; Co., 40 Maiden Lane, N. Y. .... 60                  Fera, Henry, 10 Maiden Lane, N. Y. .... 12                  Hedges, Wm. S. &amp; Co., 170 Broadway, N. Y. ... 46                  Jeane, Paul, Bradley Bldg., N. Y. .... 45                  Juergens &amp; Andersen Co., Chicago, Ill. .... 31                  Kahn, L. &amp; M. &amp; Co., 10 Maiden Lane, N. Y. ... 60                  Kipling, R. A., Hays Bldg., N. Y. .... 46                  Leonhardt &amp; Curran, 44 1/2 Maiden Lane, N. Y. ... 45                  Lorsch, Albert &amp; Co., 37 Maiden Lane, N. Y. ... 60                  Ludeke &amp; Power, 23 John St., N. Y. .... 46                  Nissen, Ludwig &amp; Co., 18 John St., N. Y. .... 46                  Randel, Baremore &amp; Billings, 29 Maiden Lane, 47                  Rothschild, M. D., 41 &amp; 43 Maiden Lane, N. Y. ... 60                  Scott, J. T. &amp; Co., 4 Maiden Lane, N. Y. .... 22                  Smith, Alfred H. &amp; Co., 182 Broadway, N. Y. ... 46                  Wolff &amp; Gunzburger, 87 Nassau St. N. Y. .... 60</p> <p><b>Diamond Jewelry.</b>                  Waterman &amp; Lehman, 37 Maiden Lane, N. Y. ... 15</p> <p><b>Etching School.</b>                  Lyman &amp; Co., Chicago, Ill. .... 31</p> <p><b>Fine Stationery.</b>                  Parsons, Green &amp; Co., 18 Murray St., N. Y. .... 5</p>	<p><b>Fountain Pens.</b>                  Smith, H. M., &amp; Co., 83 Nassau St., N. Y. .... 45                  The Boston Pen Co., Boston, Mass. .... 31</p> <p><b>Gold and Silver Plating.</b>                  Brunor Plating and Jewelry Repairing Co. ....                  Maiden Lane, N. Y. .... 5                  H. B., Bolstad, Plating Co., Chicago Ill. .... 29</p> <p><b>Gold Jewelry.</b>                  Bippart &amp; Co., Newark, N. J. .... 7                  Carter, Sloan &amp; Co., 15 Maiden Lane, N. Y. ... 47                  Hancock, Becker A Co., Providence, R. I. .... 45                  Hook, G. W., Chicago, Ill. .... 28                  Horstman, Richard, World's Fair Grounds, 26                  Kremenz &amp; Co., 182 Broadway, N. Y. .... 8                  Racine Jewelry Mfg. Co., Racine, Wis. .... 29                  Richardson, Enos &amp; Co., 23 Maiden Lane, N.Y 45                  Smith, C. Sydney, 191 Broadway, N. Y. .... 10                  Street, Geo. O. &amp; Sons, 15 John St., N. Y. .... 12</p> <p><b>Horological Schools.</b>                  Parson's School for Watchmakers, Peoria, Ill. 29                  Palmer &amp; Swain, Waltham, Mass. .... 49</p> <p><b>Hotels.</b>                  Gibson House, Cincinnati, O. .... 28</p> <p><b>Jewelry Mailing Boxes.</b>                  Am. Railway Supply Co., 24 Park Place, N. Y. ... 4</p> <p><b>Jewelry, Silverware and Optical Cases.</b>                  Birmingham, Wm. &amp; Co., 728 Arch St., Phila. 43                  Borgzinner, S. &amp; A., 82 &amp; 84 Nassau St., N.Y. ... 15                  Troescher, A. &amp; Co., 69 Nassau St., N. Y. .... 46                  Wiggers &amp; Froelick, 60 Nassau St., N. Y. .... 46</p> <p><b>Jobbers, Watches, Diamonds, Etc.</b>                  Aikin-Lambert Jewelry Co., 19 Maiden Lane. ... 10                  Bonnet, Albert H., Columbus, O. .... 32                  Bowman, Ezra F. &amp; Co., Lancaster, Pa. .... 49                  Cross &amp; Beguelin, 17 Maiden Lane, N. Y. .... 36                  Friedlander, R. L. &amp; M., 65 Nassau St., N. Y. ... 25                  Giles Bros. &amp; Co., W. H. Gleason, receiver, Chicago, Ill. .... 31                  Heeren Bros. &amp; Co., Pittsburgh, Pa. .... 57                  Myers, S. F. &amp; Co., 48 Maiden Lane, N. Y. ... 60</p> <p><b>Leather and Silver Goods.</b>                  Deitsch Bros., 7 E. 17th St., N. Y. .... 2</p> <p><b>Musical Boxes.</b>                  Jacot &amp; Son, 298 Broadway, N. Y. .... 7                  Wolff, A., 194 Broadway, N. Y. .... 31</p> <p><b>Optical Goods.</b>                  Kirstein, E., Sons Co., Rochester, N. Y. .... 25                  Queen &amp; Co., Philadelphia, Pa. .... 4                  Scheidig, John &amp; Co., 43 Maiden Lane, N. Y. ... 9                  The Nous Verrons Co., Boston, Mass. .... 10                  Zineman, M. &amp; Bro., Philadelphia, Pa. .... 34</p> <p><b>Pens, Pencil Cases, Etc.</b>                  Aikin, Lambert &amp; Co., 19 Maiden Lane, N. Y. ... 12                  Beaumel, D. W., 17 John St., N. Y. .... 35</p> <p><b>Patents.</b>                  Cox &amp; Sons, 11 Park Row, N. Y. .... 45</p> <p><b>Pocket Cutlery.</b>                  Beach, H. B. &amp; Co. .... 12</p> <p><b>Ring Makers.</b>                  Bryant, M. B. &amp; Co., 10 Maiden Lane, N. Y. ... 60                  Bowden, J. B. &amp; Co., 192 Broadway, N. Y. .... 7                  Haskell, H. C., 192 Broadway, N. Y. .... 12                  Hildreth Mfg. Co., 51 Maiden Lane, N. Y. .... 8</p> <p><b>Ring Gauges.</b>                  Engel, A. W., Chicago, Ill. .... 34</p> <p><b>Rolled Plate Jewelry.</b>                  Dederick, J. H., 16 Maiden Lane, N. Y. .... 15                  Hancock, Becker &amp; Co., Providence, R. I. .... 45                  Larter, Elcox &amp; Co., 21 &amp; 23 Maiden Lane, N. Y. .... 13                  Wood, John R. &amp; Sons, 14 John St., N. Y. .... 31</p>	<p><b>Sample Trunks.</b>                  Crouch &amp; Fitzgerald, 161 Broadway, N. Y. .... 48</p> <p><b>Settings and Galleries.</b>                  Blancard &amp; Co., 76 John St., N. Y. .... 36</p> <p><b>Silver Mounted Ebony Goods.</b>                  Deitsch Bros., 7 E. 17th St., N. Y. .... 3                  Provenzano, J. N., 39 Union Square, N. Y. .... 11</p> <p><b>Silver Plated Ware.</b>                  Holmes &amp; Edwards Silver Co., Bridgeport, Conn. ....                  Pairpoint Mfg. Co., New Bedford, Mass. .... 5                  Rogers &amp; Bro., 16 Courtlandt St., N. Y. .... 38, 39</p> <p><b>Souvenir Spoons.</b>                  Alvin Mfg. Co., 860 Broadway, N. Y. .... 14</p> <p><b>Sterling Silverware.</b>                  Campbell-Metcalf Silver Co., Providence, R. I. 46                  Durgin, W. B., Concord, N. H. .... 12                  Gorham Mfg. Co., Broadway &amp; 19th St., N.Y 16, 17                  Knowles, J. B. &amp; S. M., Co., Silversmiths' Hall, Union Square, N. Y. .... 7                  Ovaitt &amp; Warner, Portland, Oregon. .... 29                  Reed &amp; Barton, 37 Union Sq., N. Y. .... 32                  Shiebler, Geo. W., Co., 179 Broadway, N. Y. ... 15                  Towle Mfg. Co., Newburyport, Mass. .... 13                  Wallace, R. &amp; Sons Mfg. Co., 3 Park Place, N. Y. .... 6                  Whiting Mfg. Co., Broadway and 18th St., N. Y. 21                  Wood &amp; Hughes, 10 John St., N. Y. .... 46</p> <p><b>Sterling Silver Novelties.</b>                  Bachrach &amp; Freedman, 183 Union Sq., N. Y. ... 13</p> <p><b>Stem Winding Attachments.</b>                  Abbott, Henry, 2 Maiden Lane, N. Y. .... 60</p> <p><b>Thimbles.</b>                  Ketcham &amp; McDougall, 198 Broadway, N. Y. ... 45</p> <p><b>Tissue Paper.</b>                  Dexter, C. H., Sons, Windsor Locks, Conn. ... 25</p> <p><b>Tool Manufacturers and Dealers.</b>                  Bullock, O. W., Springfield, Mass. .... 7                  Gesswein, F. W., 39 John St., N. Y. .... 10                  Horological Tool Co., Chicago, Ill. .... 34                  Logan, A. J., Waltham, Mass. .... 49                  Mosely &amp; Co., Elgin, Ill. .... 31</p> <p><b>Tortoise Shell Goods.</b>                  Rice &amp; Hochster, 483 &amp; 485 Broadway, N. Y. ... 9</p> <p><b>Trunks and Traveling Bags.</b>                  Crouch &amp; Fitzgerald, 161 Broadway, N. Y. .... 48</p> <p><b>Varigated and Enameled Jewelry.</b>                  Hedges, A. J. &amp; Co., 6 Maiden Lane, N. Y. .... 25</p> <p><b>Watch Case Manufacturers.</b>                  Goll, Henry, 17 John St., N. Y. .... 12                  Margot Bros., Boston, Mass. .... 34                  The Planchamp &amp; Becker Co., Chicago, Ill. ... 29</p> <p><b>Watchman's Clocks.</b>                  Abry, Chas. Leo, 41 &amp; 43 Maiden Lane, N. Y. ... 9                  Hausburg, O. E., 41 Maiden Lane, N. Y. .... 43</p> <p><b>Watch and Clock Oils.</b>                  Nye, Wm. F., New Bedford, Mass. .... 34                  Kelley, Ezerah F., New Bedford, Mass. .... 33</p> <p><b>Watch, Glasses and Spectacle Lenses.</b>                  Bergen A., &amp; Co., 47 Maiden Lane, N. Y. ... 19</p> <p><b>Watch Importers.</b>                  Hyde's, J. E., Sons, 22 Maiden Lane, N. Y. ... 13</p> <p><b>Watch Keys.</b>                  Clark, A. N., Plainville, Conn. .... 48</p> <p><b>Watch Manufacturers.</b>                  Baume &amp; Co., London, England, and Syracuse, N. Y. .... 26</p> <p><b>Watch Repairers.</b>                  Henry, Peter, Cincinnati, O. .... 28</p>
---	--	---

## Special Notices.

Rates 75c. per insertion for notices not exceeding lines (25 words), additional words 2 cents each. If answers are to be forwarded, postage stamps must be enclosed. Two insertions, 15 per cent. off; three insertions, 20 per cent. off; four insertions or more, 25 per cent. off. Payable strictly in advance. Display cards on this page will be charged at \$2.00 per inch for first insertion, subject to same discount as above for subsequent insertions.

Under the heading of **Situations Wanted** on this page advertisements will be inserted for One Cent a Word. This offer refers to **Situations Wanted only**. Payable strictly in advance. If answers are to be forwarded, postage must be enclosed.

## Situations Wanted.

Notices under this heading **ONLY** are charged at one cent a word, payable strictly in advance. If answer are to be forwarded, postage must be enclosed.

**TO JEWELRY NOVELTY MANUFACTURERS.**—Young man, who has traveled with a line of fancy metal articles, is open for an engagement. Would like to cover New England, and nearby States for a jewelry or fancy goods house. Highest references. Address B. E. C., care **JEWELERS' CIRCULAR**.

**SITUATION** wanted as watchmaker, clock and jewelry repairer, by a single man, twenty-seven years of age. Address Ed. S., Dresden, Ohio.

**WANTED, A POSITION** in a diamond, jewelry or fancy goods house. Have a thorough knowledge of the goods and a fair trade acquaintance. Satisfactory references. Address D. J. F., care of **JEWELERS' CIRCULAR**.

**A FIRST-CLASS** watchmaker wants position as good salesman. Has full set of tools. Address Waltham, care **JEWELERS' CIRCULAR**.

**A YOUNG** experienced traveling jewelry salesman open for engagement. Highest references. Hustler, care of **JEWELERS' CIRCULAR**.

**FIRST-CLASS WATCHMAKER** and engraver; ten years' experience; graduate of the Jewelers' School for Letter and Monogram Engravers; single; good salesman. R. H. Hitchcock, Muskegon, Mich.

**SITUATION WANTED.**—By Electro plater on all kinds of jewelry work, coloring and oxidizing. Have had charge of factory for 15 years. Address Plater, 61 West 124th St., New York.

**WANTED.**—A position in New York or Brooklyn, in the jewelry or optical business. Address Box 85, Dayton, N. J.

**WANTED.**—Position by a good all round workman, watchmaker, engraver, manufacturing jeweler and enameler; good references from present employer. Address "All Round," care **JEWELERS' CIRCULAR**.

**WATCHMAKER.**—Young man wants situation as jobber; good all round workman; best London (England) reference. Address R. S., care **THE JEWELERS' CIRCULAR**.

**OPTICIAN.**—Conversant with the optical business in every detail, desires to represent some first class house on the road or take indoor position; competent to take entire charge; in business for himself ten years; six years road experience; can satisfy every requirement. Address Vision, **THE JEWELERS' CIRCULAR**.

**POSITION WANTED.**—By a young man, watch, clock, jewelry repairer and plain engraver; A1 reference. Address Jeweler, Box 599, Ticonderoga, N. Y.

**WATCHMAKER,** jewelry repairer and all around workman wants situation. References given. Address "Round," care **JEWELERS' CIRCULAR**.

**SITUATION WANTED.**—An experienced traveler wishes a position in a first-class house. Many years on the road and well acquainted in all sections east of Omaha. Diamond house preferred. Address E. D., **JEWELERS' CIRCULAR**.

**GOOD WATCHMAKER AND JEWELER** wants position at once; diamond setter and plain engraver; thoroughly competent man. "G," 114 South Main St., Paris, Tex.

**WANTED.**—Position as watchmaker, jeweler and salesman. Have full set American tools. Will exchange references. Address Permanent, care H. H. Kayton, 82 Nassau St., New York.

**ENGRAVER AND SALESMAN.**—First-class man with A1 references desires a situation in a large jewelry store. Good all round workman. New York or Brooklyn, Middle or Eastern States preferred. Address Mizpah, care **JEWELERS' CIRCULAR**.

**DESIGNER IN JEWELRY** and first-class mechanic, with a thorough knowledge of the trade, acid coloring, etc., desires a position as foreman or some position where his abilities would be recognized. Address Designer, 27 1/2 Lombardy Street, Newark, N. J.

**SITUATION WANTED** by a first-class jeweler, with fourteen years' experience. Had own business. Can do acid color and battery gilding, also do repairing, &c. Can turn hand to everything. "Greek," **JEWELERS' CIRCULAR**.

**First-Class Watchmaker and Engraver.**  
19 years experience, fine salesman, fine tools, come at once. Address "C," Lock Box 5, New Hartford, N. Y.

## Help Wanted.

**WANTED.**—A first-class jewelry jobber, up on hard soldering, and who can set single stones. Good salary. Permanent situation. Address with particulars and references, Theus Brothers, Savannah, Ga.

**WE WANT** one or two good watchmakers; none but first-class mechanics need apply; best of wages paid. Address Julius C. Walk & Son, Indianapolis, Ind.

**WANTED.**—A young man to repair clocks and do some hard soldering. Will pay \$8 per week. Apply to Henry Nockin, 669 Columbus Ave., New York City.

## For Sale.

**FOR SALE.**—\$500 for \$300 cash. Jewelry, News Depot and furnished rooms for two, Kent \$8. Store pays profit; bench work for one. Address Cyrus Condit, 2344 Bellevue Avenue, Kansas City, Mo.

**FOR SALE.**—A spectacle and thimble plant long established. Good set of machinery and tools, with power, all in fair condition. Price \$3,000, with liberal discount for cash. Continued ill health the reason for selling. For particulars inquire of Gustave Walters, 33 Maiden Lane, New York.

**FOR SALE.**—Well established jewelry and optical business; in a Virginia city of about 30,000 population; best location in city; rent \$500 per annum; store 15 feet wide and 40 feet deep; in good condition. Nice clean stock, no old or undesirable goods; stock inventory about \$4,500; fixtures, materials, tools, safe, etc., about \$1,500; fine Hall's fire and burglar proof safe; Webster Whitcomb lathe and all tools in good shape; best business city in the south; sales in 1892, over \$8,000 and profits over \$3,000; business could be easily doubled by an energetic wide awake man; am compelled to change business on account of failing health. Address at once Jeweler and Optician, care of **JEWELERS' CIRCULAR**.

**FOR SALE.**—At Cleveland, O., a watch and jewelry business. Wishing to retire on account of failing health. I am obliged to sell my business; a good opportunity to purchase a business established over twenty-five years; central location; clean stock; plenty work; stock and fixtures invoice about \$3,000; terms cash. Address R., Lock Box 89, Cleveland, O.

**FOR SALE.**—An optician's lapping or lens grinding lathe, with tools, for foot or power; also two Creigleith stones, 1 1/2 x 1 inches, mounted on spindles. For particulars apply to C. A. Hoffman, 20 and 22 South Fourth St., Minneapolis, Minn.

## FOR SALE.

### THE JEWELRY MANUFACTURING PLANT

of the late Walter E. White, located at 86 Page St., Providence, R. I., consisting of machinery, tools, fixtures, stock, good will, etc.; to parties desirous of engaging in this business the well-known popularity and standard quality of the goods always manufactured by this firm makes this an exceptional opportunity, and one that rarely offers. Apply to WM. G. HOPKINS, Administrator, 53 Clifford St., Providence, R. I.

## Miscellaneous.

**I BUY JEWELRY STOCKS.**—Manufacturers, jobbers and retailers desiring to dispose of surplus or entire stocks of diamonds, watches and jewelry can find quick cash buyer by addressing Stephen S. Harmon, 134 East 96th St., New York City.

**WANTED.**—A few more students to learn engraving at Trowbridge's School of Engraving, Winona, Minn. Lowest rates of any school. Board to be had for a low figure. New term starting.

## DEMAGNETIZING.

**PERFECT WORK.**—Watch repairing in all its branches; all work warranted. Winslow & Penney, 608 Masonic Temple, Chicago.

**WANTED.**—A good lens cutting machine; must be in perfect condition. Also rolls for eye wire, press and dies and other tools necessary for manufacturing spectacles and eye glasses. Address C. A. Hoffman, 20 and 22 South Fourth St., Minneapolis, Minn.

**FOUND.**—On our showcase, in June a paper of mounted diamond jewelry, supposed to have been left by some traveling salesman; has been advertised in Boston Herald; owner will please call, prove property, pay expenses and take the goods. M. S. Page & Co. No. 1 Salem Street, Boston, Mass.

**A COURSE** of engraving at Trowbridge's School of Engraving, Winona, Minn., is what you want. Write for terms which are the lowest of any engraving school. Board to be had for less than in large cities.

**WANTED PARTNER.**—With brains, money, hustle and integrity, to enlarge an established, rapidly growing western wholesale jewelry business. The best of references given and required. Address O. B. Edmund, care of **JEWELERS' CIRCULAR**.

**WANTED.**—Address and price lists of makers of fine silver and leather spectacle cases. Address C. A. Hoffman, 20 and 22 South Fourth St., Minneapolis, Minn.

**Headquarters**  
FOR  
**ELECTRIC & PORTABLE**  
**Watchman's Clocks**  
Lowest Prices.  
Latest Improvements,  
Patents 1886-1893.  
Send for Circular.  
**E. O. HAUSBURG,**  
41 Maiden Lane, New York. **THE "ALERT."**

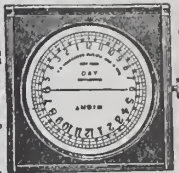

Price, Complete \$10.00

## PAWNBROKERS' SALES

BY  
**S. FIRUSKI & SON,**  
AUCTIONEERS,  
85 Bowery, New York,  
AT 11 A. M.

See N. Y. Herald for full particulars of Sales.

The Trade is Respectfully Solicited to Attend.

**If Your Sales**  
**Are Not Satisfactory**

ADDRESS

**DE B. O. SCOTT,**  
20 Murray Street, New York.  
AUCTIONEER.

Specialties: Watches, Clocks, Bric-a-Brac, &c.

Write for particulars and references.

**WM. BIRMINGHAM & CO.**  
MANUFACTURERS OF  
All Kinds of Leather Spectacle and Eye Glass  
**CASES,**  
728 Arch Street, PHILADELPHIA, PA.

## The Latest Patents.

ISSUE OF SEPTEMBER 19, 1893.

**505,115.** ALARM-CLOCK. EDWARD R. MASON and ALT O. SNOW, Binghamton, N. Y.—Filed May 1, 1893. Serial No. 472,604. (No model.)

In an alarm mechanism for clocks, the combination with the main spring shaft, of a worm, a verge-shaft having endwise movement and connected to be actuated back and forth by the said worm, an automatic trip

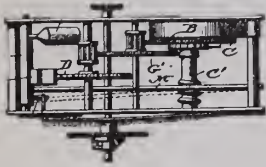

arranged to engage connections on said verge-shaft and means, substantially as described, for intermittently disengaging the trip from said connections whereby two separate alarms are sounded.

**505,218.** CLUSTER-SETTING FOR GEMS. RUDOLPH FUCHS, New York, N. Y.—Filed Apr. 11, 1893. Serial No. 469,886. (Model.)

The cluster setting for gems, comprising a ring portion, a plurality of projections extending outwardly from the ring portion and disconnected with one another



save at the ring portion from which they emanate, said projections having branches at their outer ends, which together with the projections serve to form the outer and side walls of the gem opening.

**505,316.** CANDELABRUM. CHARLES S. KOEHLER, Brooklyn, assignor to Benziger Bros., New York, N. Y.—Filed Apr. 25, 1893. Serial No. 471,796. (No model.)

In a candelabrum, the combination, with a base and a body adjustable therein, of standards supported by

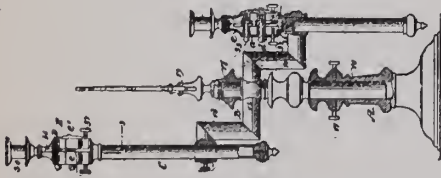

the said adjustable body and vertically adjustable in relation thereto, arms pivotally connected with the said standards, and candle sticks carried by the arms.

**505,323.** FRUIT-HOLDER. WILLIAM NICHOLSON, Brooklyn, N. Y., assignor of one-half to Adelbert A. Webster, same place.—Filed Apr. 12, 1893. Serial No. 470,916. (No model.)

A fruit holder, comprising a cup having a base, and

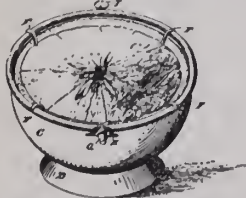

a ring hinged on the said cup and provided with inwardly and downwardly projecting prongs adapted to engage the fruit to hold the same in place in the cup.

The appendix to the Meriden Britannia Co.'s catalogue of 1847 Rogers Bros. spoons, forks, knives, etc., is now ready for delivery. It will be mailed to any jeweler on application, and will prove convenient and instructive.

## Official Announcement of Awards for Silverware Exhibits.

CHICAGO, Ill., Oct. 3. — The following awards in the silverware lines are officially announced:

Dirksen Silver Filigree Co., silver filigree spoons, silver filigree sugar tongs, napkin rings, card cases.

Gorham Mfg. Co., (30 awards), hollow ware, electro plate on hard metal, ecclesiastical goods in silver, bronze, brass, electro plate, silver and gold mounted leather goods, enamel work on silver hollow ware, fine art pieces, silver hollow ware, commercial silver, special exhibit of prize pieces in solid silver, knives, forks and spoons, silver flat ware, silver mounted cut glass and crystal, silver with glass blown in, silver deposit on glass and American pottery, medals, silver, bronze and gold, artistic display exhibit as a whole, special exhibit of silver gilt ware, dessert service with candelabra, special for W. C. E., toilet ware (silver), brushes, combs, etc., Rose dinner and dessert services (six pieces), plate ecclesiastical goods, bronze statuary, bronze castings, electro plate goods, enamels on silver, paintings on enamel solid silverware.

Tiffany & Co., (15 awards) silver table ware, plates, salvers, candelabra, gold and silverware, gilt ware for table decoration, knives, forks and spoons, fancy articles, silver spoons, cane heads, mixed metals, mokumi inlaid enameled plated ware on hard nickel silver base, damascening of gold and silver on iron, etchings on decarbonized steel.

Meriden Britannia Co., (5 awards) artistic display, silver plated hollow ware, works of art, hollow ware in nickel, silver plated knives, forks, spoons.

Holmes & Edwards Silver Co., (3 awards) silver plated spoons, silver plated forks, silver plated table flat ware.

William Rogers Mfg. Co., (3 awards) silver plated ware, silver plated knives, silver plated forks.

Manhattan Silver Plate Co., (3 awards) electroplated silver and gold ware, hollow ware, electroplated gold hollow ware.

Pairpont Mfg. Co., silver plated ware.

Wymble Mfg. Co., silverware.

Mrs. H. L. Goodwin, Boston, spoons, cups, and foil.

The list of foreign awards is large. A few exhibits in this group are not yet reported upon and will be announced later.

## Kansas City.

L. S. Cady has been empaneled as one of the special grand jurors to investigate the failure of the Kansas City Safe Deposit and Savings Bank.

J. R. Gleason has opened a new jewelry store at 1007 Walnut St. Mr. Gleason had been for ten years a member of the firm of M. B. Wright & Co.

Cady & Olmstead and Streicher's Watch and Jewelry Co. are the only jewelry houses making exhibits at the Inter-State Fair, in this city, this year.

The stock of J. Niles Kimball is still locked up in his store on 6th St., J. M. Garner, who holds it on mortgages for preferred creditors, not having been able to dispose of it.

The Hart Jewelry Co., 925 Main St., has for sometime been missing articles from the store and suspicion fastened upon Richard Ericke, who had been employed there as watchmaker for about a year. A detective was put on the case, and Friday he succeeded in finding a case of jewelry in Ericke's coat pocket. He confessed and produced \$75 worth of stolen goods. Out of consideration for his family, Mr. Hart refused to prosecute Ericke, but discharged him from his employ.

## Springfield, Mass.

F. A. Hubbard has returned from a two weeks' visit to the World's Fair.

The funeral of William W. Coomes, Longmeadow, was held on Sept. 23, and was largely attended. Mr. Coomes began his business career a half century ago as an apprentice to Demond Chandler, in the spectacle and thimble trade. Later he entered into partnership with John Colton, but finally established a business of his own.

## Cincinnati.

Thos. Geohegan, with C. Hellebush, has returned from the World's Fair.

Max Nathan, New York, was in Cincinnati last week renewing old acquaintances.

R. H. Galbreath, of Duhme & Co., accompanied by his wife, is at the World's Fair.

Henry Hahn is out reviewing the trade. Morris Hahn has returned after securing some good orders.

A. G. Schwab has returned from a short trip and says he was agreeably surprised to find such good trade.

John C. Dueber narrowly escaped assassination a few days ago, so a daily newspaper stated. A demented designer secured a revolver and waited for him, but was discovered before Mr. Dueber appeared on the scene.

John Holland Gold Pen Co.'s salesroom was entered by burglars Thursday night and about \$200 worth of gold and silver pens and pencils taken from the show case. The thieves tried to open the safes where the principal stock was stored. There is no clue to the thieves.

Oskamp, Nolting & Co. have taken the lead in a charitable movement toward relieving the unemployed of this city. They began last Monday and will give 10 per cent. of gross sales in the retail department during the week up to Saturday night. It is a move that has been commended by the citizens and all business men and will no doubt lead to a number of such offerings.



# THANKS

To our friends who have so kindly favored us with orders which have kept our factory busy the past few weeks.

# THANKS

For accommodating us with the necessary payments during the hard financial trouble, which enabled us to pay our help with cash.

# THANKS

Are also due those who sent us such liberal ORDERS from selections of new holiday NOV-ELTIES, made specially to stir up a sluggish trade.

Respectfully Yours,

**Hancock, Becker & Co.,**

Providence, R. I.

Manufacturing Jewelers,

JOBGING TRADE ONLY.

**SOLICITORS OF AMERICAN & FOREIGN PATENTS**  
 FOR DESIGNS INVENTIONS & TRADE MARKS  
 SEARCHES MADE & INFRINGEMENT PROSECUTED OR DEFENDED  
 THE WILL TRADE BY HAVING THEIR PATENTS TAKEN BY  
 SAVE TIME AND MONEY  
**COX & SONS 11 PARK ROW, N.Y.**

## THE PERFECT COLLAR BUTTON, "THE BENEDICT."

PATENTED AUGUST 17TH, 1886.

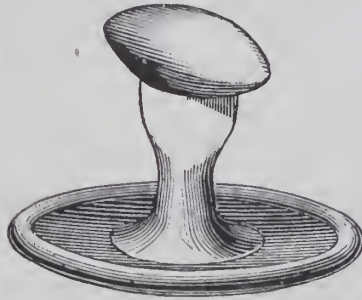

Having secured the sole right to manufacture the above buttons, they are now offered to the trade in

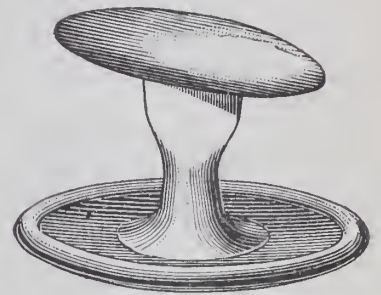

14 Kt. Gold, 10 Kt. Gold, Sterling Silver and Rolled Plate.

**ENOS RICHARDSON & Co.**  
23 MAIDEN LANE, NEW YORK.

**Paul Jeanne,** EIGHTEENTH STREET and 4<sup>TH</sup> AVE., N. Y.  
(Bradley Building.)  
MANUFACTURER OF

≡ FINE ⊗ DIAMOND ⊗ JEWELRY. ≡

We Have Removed to ●●●●●●●●●●  
**57 MAIDEN LANE.**  
**LEONHARDT & CURRAN,**  
MANUFACTURERS OF DIAMOND MOUNTINGS.

## BIG RETURNS MADE FOR OLD GOLD AND SILVER.

Check Forwarded 24 Hours After Receipt of Consignment.

**J. RATHBONE,**  
GOLD AND SILVER REFINER, ASSAYER AND SWEEPSMELTER,  
Nos. 1 to 9 Matthewson St., Cor. Cove, Providence, R. I.

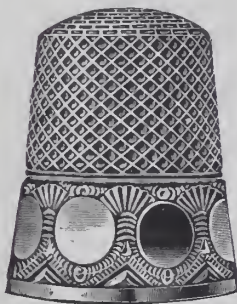

**KETCH'AIM & McDoucal',**  
MANUFACTURERS  
GOLD & SILVER THIMBLES,  
GOLD COLLAR BUTTONS,  
AUTOMATIC EYE-GLASS HOLDERS,  
198 BROADWAY N. Y.

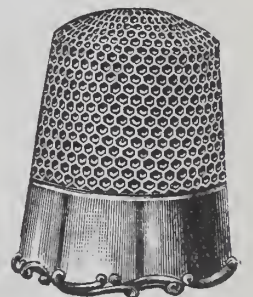

## BLACK DIAMOND FOUNTAIN PEN.

Unequaled for Price.

Send for Circular.



**H. M. SMITH & Co.,**

83 NASSAU STREET, N. Y.

**DIAMONDS.**

**Wm. S. Hedges & Co.,**  
**Importers of Diamonds,**  
 And Manufacturers of **DIAMOND JEWELRY.**  
**170 Broadway, New York.**  
 27 Holdorn Viaduct, London.



18 JOHN ST. NEW YORK

**R. A. KIPLING,**  
 Importer of

**PRECIOUS STONES,**

21 & 23 Maiden Lane,

19, RUE DROUOT, New York.  
 PARIS.

**Alfred H. Smith & Co.,**

**IMPORTERS**

**DIAMONDS**

AND

**PRECIOUS STONES,**

182 BROADWAY, COR. JOHN STREET,  
 NEW YORK.

33 Holborn Viaduct, London, E. C.

**CAMPBELL-METCALF SILVER CO.**



176 Broadway, N. Y., Room 14. 66 Stewart St., Prov., R. I.  
 Mills Bldg., San Francisco, 8th Floor, Room 1.



Patent applied for.

Victoria Noveltes, many fancy shapes.  
 Celluloid Top, Sides, Bottom and Cushions  
**A. TROESCHER & CO., 69 Nassau St., N. Y.**

**LUDEKE & POWER,**  
**IMPORTERS OF DIAMONDS**

AND OTHER PRECIOUS STONES,

ADOLPH LUDEKE.  
 CHAS. L. POWRR.

23 JOHN STREET, N. Y.

**WOOD & HUGHES,**  
**STERLING SILVERWARE MANUFACTURERS**  
 New York Agents for the Derby Silver Co.'s  
 FINE QUADRUPLE PLATED WARE,  
 NO. 16 JOHN STREET, NEW YORK  
 206 Kearney St., San Francisco, Cal.  
 HASKELL & MUEGGE, Agents.

**WIGGERS & FROELICK,**  
 60 NASSAU ST., NEW YORK.  
**Sample Cases and Trays**  
 For Watches, Jewelry, Optical Goods, Etc.  
**WE STRIVE TO MAKE THE BEST.**

**Trade Gossip.**

E. & J. Swigart, Cincinnati, O., are making a specialty of optical goods and trays and boxes for the trade.

The new catalogue of O. E. Bell & Co., Cincinnati, O., will be out in a couple of weeks. It will be a beauty.

Jos. Noterman & Co., Cincinnati, O., have just issued an elegant diamond catalogue of mountings with price list.

H. B. Beach & Co., 418 Washington St., Boston, Mass., are showing an artistic and very complete line of silver plated novelties, pocket cutlery, combs, brushes, candelabra, etc. Dealers will be well repaid by a visit to the firm's show rooms. A really good thing also shown by the firm is the Gem letter scale, weighing accurately up to 11 ozs. and adjustable to any angle or position.

The Wadsworth Watch Case Co. show in 0 and 16 sizes a scalloped center case with engravings "equal to those on solid gold cases;" which are having a large run. Chicago Manager Loeb says double tags are put on all these goods to prevent the trade selling them for solid gold. A customer writes to a Chicago jobber that nothing will substitute a Wadsworth case. The hand engraved scalloped center is the latest Wadsworth out and is a beauty. The goods are shown in quantities at the Chicago office, 611-613 Columbus Memorial building.

The Meriden Britannia Co., Meriden, Conn., have just issued a most artistic catalogue illustrating some of their latest and most desirable patterns in hollow ware and flat ware. The cover bears an original design in black and silver, chaste and ornate. A handy index enables one to quickly find any article within the 130 pages of the book while a scale by means of which the exact dimensions of any price may be ascertained and a code word for convenience in ordering are other excellent features. An appendix to the catalogue of 1847 Rogers Bros. flat ware has also just been issued.

The "Colonia" novelty clocks recently received from the factory by the Ansonia Clock Co., 133-135 Wabash Ave., Chicago, are marvels of elegance in clock designs. The pattern is a rococco scroll in high relief, and the clocks are in both silver and gold. The silver is frosted with projecting bright tips and the gold is a dull finish with polished high lights. From four scroll legs at the corners the base recedes in graceful lines to the neck below the dial. Thence a rococco curve encircles the dial with a slight projection above. The gems are 4 3/4 inches high, with silver dials bearing black enameled figures. The design is graceful and is destined to become very popular. Advance plates of fine porcelain clocks, received at the Chicago office the past week, show choice designs and hand painted decorations, with fancy gold dials.

**Questions By Circular Readers.**

VINCENNES, Ind., Sept. 13, 1893.

Editor of THE JEWELERS' CIRCULAR:

I have noted in your Connoisseur department several allusions to Watteau decorations in bric-à-brac. While I know what the Watteau style is, I would like you to give some particulars regarding the name.

A. B. C.

ANSWER:—Antoine Watteau was born at Valenciennes, France, in 1684. He was characteristic of French art in the reign of Louis XIV. We don't know if his birthplace at Valenciennes, with its chief product of dainty lace, had anything to do with it, but the other items of Watteau's history are considerably removed from the very artificial grace which one connects with his name. He was the son of a carpenter, and struggled up by the hard instrumentality of third-rate masters and of picture dealers to the rank which he attained among artists, taking his stand from the first, however, as the painter of well-bred, well-appareled people—the frequenters of *bals masqués* and *fêtes champêtres*, who were only playing at shepherds and shepherdesses. Watteau was elected an Academician in 1717, when he was thirty-three years of age, and he afterwards went to England, but did not remain there. He died of consumption at Nogent-sur-Marne in 1721, when he was thirty-six years of age. Watteau's gifts were his grace and brilliance on a small scale. He did not draw well; as to design, his composition may be said to be suited to such work as the collection of "fashionable figures," which he engraved and left behind him. Yet, if we were to see at this moment some of his exquisite groups of ladies in *sacques* and Watteau hats, and cavaliers in flowing wigs and lace cravats, we have no doubt the most of us would admire them.

FINDLAY, O., Sept. 19, 1893.

Editor of THE JEWELERS' CIRCULAR:

Thinking that you will answer questions through the medium of your valuable CIRCULAR, I would be thankful if you would give me some particulars regarding the process of gilding. Yours respectfully,

BUCKEYE.

ANSWER:—Place in a plate leaf gold, and add a little honey; stir the two substances carefully together with a glass stopper, the lowest end of which is to be very flat. Throw the resulting paste in a glass of water mixed with a little alcohol; wash and leave it to settle; decant the liquid, and again wash the deposit. Repeat the operation until the result is a fine, pure, and brilliant powder of gold. This powder, mixed with common salt and powdered cream-of-tartar and stirred up in water, serves for gilding. A French authority gives another method of gilding: Dissolve in aqua regia one grain of fine gold, previously rolled out very thin, in a porcelain capsule; heat on the sand bath and concentrate until it is the color of ox blood. Add a pint of distilled water hot, in which has been dissolved four grains of white cyanide of potassium. Stir with a glass rod, and filter the liquid through unsized paper. To gild with this liquid it is heated a little above lukewarmness, and the articles to be gilt are immersed in it.

ESTABLISHED 50 YEARS.

RANDEL, BAREMORE & BILLINGS,

IMPORTERS OF

DIAMONDS,

AND OTHER PRECIOUS STONES.

FINE PEARLS A SPECIALTY.

MANUFACTURERS OF

DIAMOND JEWELRY,

IN THE LATEST DESIGNS.

Diamonds Recut in Modern Styles or Repaired on Premises.

58 Nassau Street,  
29 Maiden Lane  
NEW YORK.

1 Tulp Straat,  
AMSTERDAM.

1 St. Andrews St.,  
Holborn Circus,  
LONDON, E. C.



ESTABLISHED 1841.



TRADE MARK.

CARTER, SLOAN & CO.,

MANUFACTURERS OF GOLD JEWELRY,

No 15 MAIDEN LANE,

NEW YORK.

A. CARTER, JR.  
A. K. SLOAN.  
C. E. HASTINGS.

GEO. R. HOWE.  
WM. T. CARTER.  
WM. T. GOUGH.

FACTORY, NEWARK, N. J.

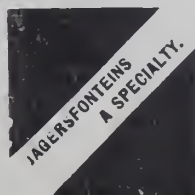

JOHN N. DISSELKOEN,  
Cutter and Importer of  
DIAMONDS

FACTORY.  
76 LANGELEEKERSPAD,  
AMSTERDAM.

19 East 16th St.,  
NEW YORK.

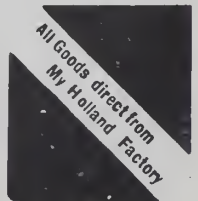

**A Few Novelties in Horology.**

A REPORTER of the *Revue Universelle* recently paid a visit to the watch factories of Aeby, Bellenot & Co., Bienne, Switzerland, and publishes the results of his observations in the columns of above mentioned paper, which THE CIRCULAR translates for the perusal of its readers. We should rather write, he says, Bienne and Lyss, because Aeby, Bellenot & Co. own two large factories, one at Bienne where they also have their principal office, and where they

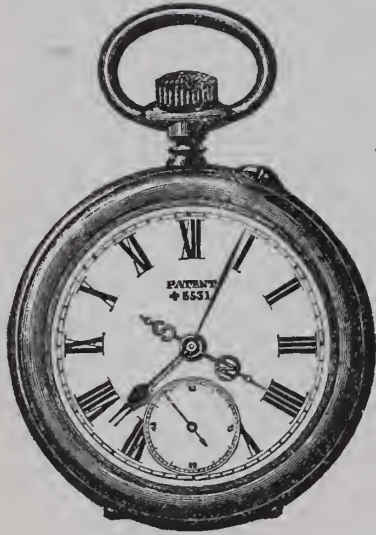

COMPASS WATCH.

devote themselves specially to the manufacture of watches, the other at Lyss for the manufacture of blank work and finishing; in addition there are also a foundry and a department for the manufacture of bronze and copper at this place.

Aeby, Bellenot & Co. have not at all adopted the motto of Nicolet, who at the end of the last century had written above his theatre on the boulevard, "Always from better to best," because in matters of horology, these gentlemen leave the beaten track. They are innovators in the full force of the term, having a horror for everything vulgar; they desire new things, everything that is new. This concern is comparatively new—being, we believe, only four years old—but that signifies nothing, because its commencement dates back many years; Mr. Aeby reminded us that his father had al-

ready established himself as watchmaker in 1840. The old firm of Aeby & Landry, on the basis of which the present stock company was organized, dates back to 1848.

Aeby, Bellenot & Co. constantly seek to produce new things, although they manufacture all the different kinds of stem-winding watches. We therefore single out the new things with the descriptions of which we desire to entertain our readers. First, we have the watch indicating two kinds of time. Let us suppose an ordinary watch with two dials, the one beside the other, and indicating two different times, while a third small dial placed underneath marks the seconds—in other words, it is a watch which indicates two different hours, an advantage not to be underrated especially in countries where the local and the railroad times vary. We have seen instances in many places in Switzerland, where we had to keep constantly posted on the difference between the time of the place and that of the train which we desired to take—say, to Berne, Paris, Berlin, Prague, or Rome. This watch is indispensable to the employes on one of the lines; there is but a single movement to regulate the two hours and the price is relatively very reasonable.

Another novelty is the automatic watch upon the dial of which small articulated personages are actuated by the movement. With the *puntero*, who gives the killing stroke to the bull in the arena, we are in the land of the oranges, guitars and *toreros*. All the different callings of trade are passed in defile, and we can see in the exercise of their functions the butcher, baker, shoemaker, etc.

We must mention next two great specialties of the firm, the compass watch and the handless watch with springing hours. In the first of the two, to have the magnetic needle point exactly to the north, the watch must be held in such a manner that the hour hand is pointed toward the sun, and completely covers its shadow. This shadow is visible even if the day should be cloudy. In a word, it is a watch and a compass, with a hand discharging two dif-

erent functions; it suffices to re-establish the hour when the experiment with the compass is finished; the watch is sold at the same price as ordinary kinds are.

The watch with springing hours is a 19-line anchor, and is constructed in a faultless condition. Up to the present, this style of watch, manufactured on different systems, had never yet given the desired results because it was somewhat too complicated in its construction. In the new system, that of Aeby, Bellenot & Co., the escapement is not left free during the time of impulsion, which itself is made so weak that it resembles in nothing the shocks of the system Pallweber. The transmitting discs are of one piece, whereby a derangement cannot take place, and the dial discs are by screws fixed to these wheels in such a manner as to form a whole. Finally, the construction of the transmitting wheels is made on the Harding system, advantageously known for a number of years. Beside this, each piece is interchangeable.

The rate of the watches without hands has been observed by the Observatory of Geneva, and the rate papers issued show

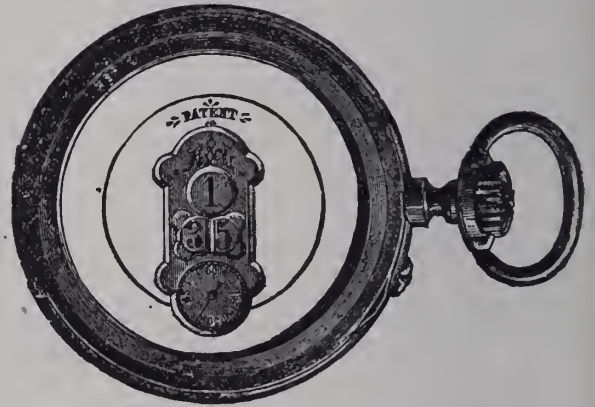

WATCH WITHOUT HANDS.

that this watch complies with great satisfaction with all the conditions of the exacted tests.

Two men were last week arrested at Spirit Lake, Ia., for the robbery of the jewelry store of Lohr & Lohr. They have confessed the crime and say they are members of a gang that has been working South Dakota.

**CROUCH & FITZGERALD,**

Jewelry Trunks and Cases.

161 Broadway

Bet. Cortlandt and Liberty Sts.,

688 B'way,

701 6th Ave.,

NEW YORK.



Sold by all wholesale dealers at manufacturer's price.

**A. N. CLARK,**  
PLAINVILLE,  
CONN.

**Manufacturer of the Celebrated LOOP WATCH KEY.**

The Best for the Price in the World.  
CROSBY'S JEWELING TOOLS IMPROVED.

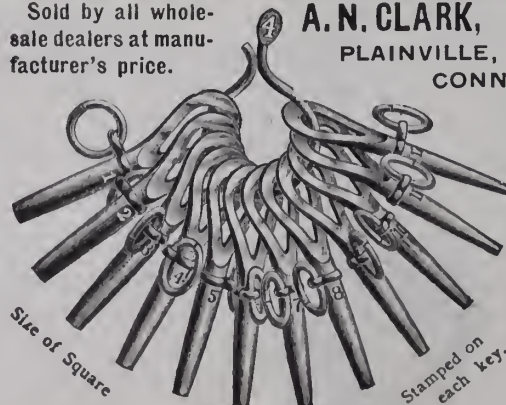

Size of Square

Stamped on each key.



Will quote royalty or price for the manufacturing of articles of real worth.

**Workshop Notes.**

**To Bronze Steel.**—Methylated spirits, one pint; gum shellac, four ounces; gum benzoin, half an ounce. Set the bottle in a warm place and shake occasionally. When dissolved, decant the clear part for fine work and strain the dregs through muslin. Now, take four ounces powdered bronze green, varying the color with yellow ochre, red ochre, or lampblack, as may be desired. Mix the bronze powder with the above varnish in quantities to suit, and apply to the work, after previously cleaning and warming the articles, giving them a second coat, and touching off with gold powder, if required, previous to varnishing.

**Watch Cleaning.**—When cleaning a watch, the work should be done conscientiously. This is very important, because when the parts are carelessly cleaned with soap and water or impure benzine, they will, after a few months, assume a dull color in consequence of a thin layer of the material used in cleaning having been left on the surface. It has at times been noticed that steel work was preserved from rust after having been cleaned with certain fluids, through the perspiration of the owner. Evidently this was due to a thin coating having been left on the surface of the metal. The conclusion to be drawn is obvious: clean carefully; push the pivots into fairly hard pith; finish with a soft brush in proper condition, and clear out all pivot holes with pegwood.

**Good Qualities of Watch Oil.**—In the case of very many watchmakers who complain bitterly of the oils they employ, the fault is their own and not of the oil; for they neglect the most simple cautions both in purchasing and using it. The following are a few points to which attention should be given; do not buy old oil from motives of economy. Keep the oil away from the light, and only take in the oil cup the quantity required for immediate use; ascertain that the watch cases close well; if they do not, there will be air currents generated and the oil will suffer. The oil in a cylinder escapement will always deteriorate very rapidly; some European watchmakers coat over the inside of the dome point, and recommend the owner not to open it. By doing so, the oil can be maintained in good condition for a long time at the escapement.

**To Measure the Length of Staff.**—The proper way to measure for the length of staff is, first, to take off both end stones, fit the balance cock properly to the plate, and screw it fast in its place. Then, with a degree gauge, take the measure from the outside of one hole jewel to the outside of the other, and to this add the amount of end shake the staff is to have, which gives the exact length of the staff between the extreme ends of the pivots. The length should be such that when one pivot rests against its end stone, the top pivot shall come level with the outer surface of its hole

jewel, and the same when resting on the other pivot. The end shake should be equal to the distance from the outer surface of the hole jewel to the adjacent surface of its end stone when fastened in place. If this distance is neither great nor small (the jewels must not touch) the end shake will be correct. A safe way for length is to take the article's measure from the surface of the sink in which the bottom end stone fitting rests to the top surface of the balance cock. Then having screwed on one of the end stones, shorten up either or both pivots of the finished staff a trifle to bring the top end of the other pivot level with the surface of its hole jewel, as before explained.

**Good Way to Clean a Mainspring.**

**T**HERE are several ways to clean and mount a mainspring, but the following ranks with the best in use among good watchmakers. Let us suppose we have a watch that has run twelve months or more. After taking the watch down, first examine the mainspring by taking off the barrel cap, carefully removing the arbor; then holding the barrel in the thumb and fingers of the left hand, lift out the inner end of the spring with small round nose pliers, holding the thumb and fingers in such a manner as to allow the spring to uncoil itself from the barrel in a gentle manner into the hand, and if sound and of the right strength, proceed to clean it with a piece of domestic, (a clean soft rag is preferable, as it is free from starch and other foreign matter calculated to injure steel.)

Holding the cloth or rag in the left hand and the spring just as it has come out of the barrel in the right, gently move it back and forth, holding two or three of the coils between the thumb, first and second fingers, pressing the coils slightly over with the ball of the thumb (not nail), so as not to materially change the natural curvature of the spring in any way during the operation. In this way the entire spring can be cleaned, with the exception of a small portion of the inner coil, which can be cleaned by using a corner of the rag, applied with a piece of pegwood, or by a slight brushing with a brush used for this purpose.

A first-class spring (and no watchmaker should use any other if he values time and reputation) thus cleaned, with proper space in the barrel, and with the arbor free of proper size, and a liberal application, of watch oil but not flooded with it, turned up to its proper capacity, will give out its full force for one or two years at least, without breaking, rusting, or becoming gummy and foul.

ESTABLISHED 1870.

**J. L. CLARK,**  
SWEEP SMELTER AND REFINER OF GOLD AND SILVER.  
Buys every kind of Gold and Silverware, Jewelry, Watches and Platinum. Full market value paid.

No. 724 Filbert Street, Philadelphia, Pa.  
SEND BY EXPRESS or Registered Mail. If my price is not satisfactory, I will return all articles.

**THE BEST PIVOT DRILLS IN THE WORLD.**

One Gross without charge for proof that this is not so.

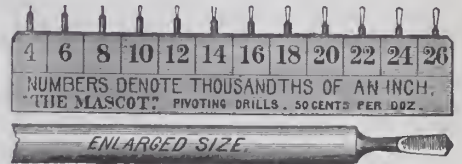

The Mascot. 50 Cents per doz.

By all Jobbers, or sent post-paid on receipt of price.

**Ezra F. Bowman & Co.,**  
LANCASTER, PA.

**Waltham Horological School,**

**PALMER & SWAIN, Props.,**  
WALTHAM, MASS.

**Summary of Prospectus.**

**LOCATED** in Martyn Square, in the city of Waltham, Mass. Pleasant location, hotels, boarding houses, churches, etc.

**CURRICULUM:**—Pupils are taught watch making, repairing and bench tool making complete. American and foreign systems. Special branches taught when desired.

**BRANCHES TAUGHT** include work on plates, barrels, wheels, pinions, jewels, balances, staffs, springs, screws, stem-winding parts, matching, gilding, finishing, adjusting, repairing, tool work, engraving, etc., etc. Also a thorough course in Ophthalmology by a professor of universal reputation and a course in gem cutting it desired.

**COURSE** may begin at any time and pupils are taught to make everything that enters into a watch movement. When the student has finished his course he is able to make and put together a watch complete in all its parts and properly adjusted; he is also a first-class repairer and gets such a thorough instruction in his trade as cannot be obtained in any workshop or any other school in the United States. The workshop of this School is fitted up with thousands of dollars' worth of the best watch tools and machinery, and with the capable instructors always ready to give their attention to the individual student, there being no class system, he has an advantage not to be obtained elsewhere. Materials for a watch movement will be given free to students who desire to make a watch of their own.

Send for full prospectus, terms for special branches, etc.

D. D. PALMER. EUGENE H. SWAIN.

**A. J. LOGAN,**  
MANUFACTURER OF  
WATCH TOOLS, HAIR SPRINGS AND  
WATCH MATERIALS.

◁ New Catalogue just issued, Sent on Application. ▷  
WALTHAM, MASS.

# Grand STREET Exhibition!

To the Jewelers . . . . .

Below you will find detail  
and to which we add con-

of the lines which we carry  
stantly the latest novelties.



**France**==BRONZES, CLOCKS OF ALL DESCRIPTIONS, SEVRES VASES, LAMPS, PORCELAINS, FINE FURNITURE.

**Germany**==ROYAL BERLIN, ROYAL BONN, NURNBERG MAJOLICA, DRESDEN VASES, DRESDEN LAMPS IN ENDLESS VARIETY, DRESDEN FURNITURE, IVORIES.

**Austria**==DECORATED GLASS, OLD VIENNA WARE, TEPLITZ GOODS, FAYENCE STATUARY, BRONZES.

**Italy**==SUPERB LINE OF CARRARA AND CASTELLINA MARBLES, NOVE AND BASSANO FAYENCE, CARVED FURNITUR

**England**==ROYAL WORCESTER, COALPORT, TULIP GLASS, ENGLISH CHIMING HALL CLOCKS.

## Ferdinand Bing & Co.,

74 Rue d'Hauteville,  
PARIS.

106 Grand Street,  
NEW YORK.



**High Art Goods Shown by Geo. Borgfeldt & Co.**

while the other watches over her shoulder. The artist, Antonio Frantelli, has spared no efforts in his work, as the perfect lines and artistic details show. Next to this is an Italian carved wood table, and on this a blue

The French walnut chiffonnier which is decorated with Watteau panels, acts as a stand for a handsome gilt trimmed onyx clock, and also three small pieces, a Sèvres bouquet holder and a Dresden photo stand

IN probably no establishment in the country is there displayed a finer assortment of artistic novelties, art pottery, clocks, pedestals, etc., than in the bric-à-brac department of Geo. Borgfeldt & Co., which occupies the entire third floor of their immense building at 18, 20 and 22 Greene St., corner Washington Place, New York. The group depicted in the illustration, represents but a few of the numerous choice lines which they are now opening. The magnificent pedestal clock is of onyx whose beautiful shades of pink, green and yellow, make an artistic combination with the bright colors of the Byzantine bronze enamel with which the clock is trimmed.

Upon the clock is a Royal Bonn vase with handsome floral decorations outlined in gold. Behind the Italian carved wood chair, the centerpiece, and upon a pedestal of Missouri onyx, stands a group in Cararra marble. The piece represents two maidens, one reading a letter

Dresden banquet lamp with raised floral decorations. A Cupid on the top of the stem upholds the fount of the lamp.

and vase which represent a large line of rich novelties. Upon the left of the group is a large Luneville jardiniere, one of the handsomest of these large pieces that this firm have ever shown. The color is a beautiful cobalt blue, and the decorations are in rich raised gilt. Its three legs are of the same color and decoration as the body of the piece.

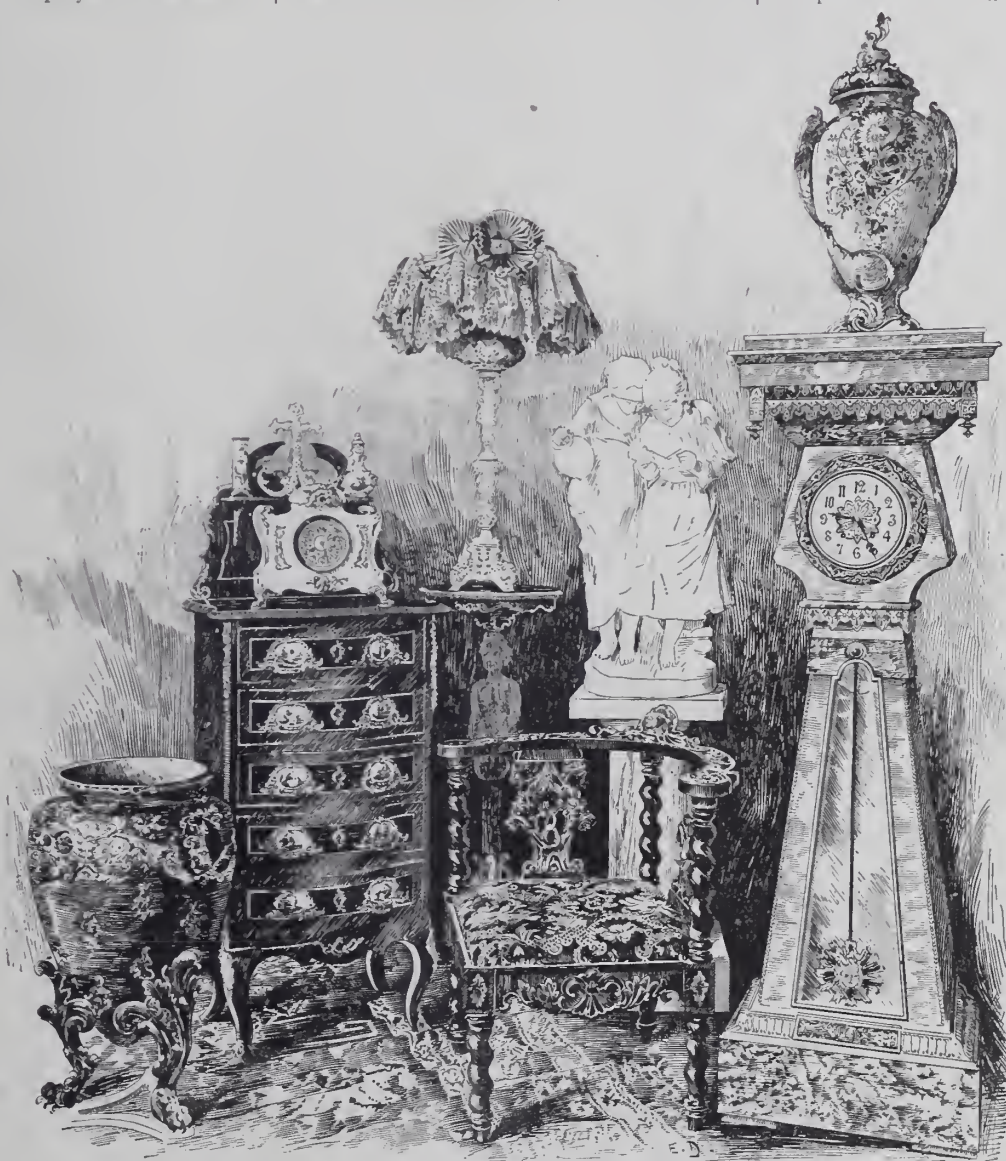

SPECIMENS OF NEW ART GOODS SHOWN BY GEO. BORGFELDT & CO.

nieres, glove boxes, etc., are made in this manner. The fashion promises to become very prominent.

A pretty fashion in Paris consists in making articles of porcelain-cloisonné. In such wares porcelain replaces enamel. The partitions of engraved gold or silver form graceful arabesques framing small porcelain panels decorated with floral designs delicately colored. Tea-pots, cups, jardinières, jewel caskets, toilet sets, bonbon-

## The Connoisseur.

(Continued from page 51.)

### The Rambler's Notes.

WHAT THE RAMBLER SAW AND HEARD AMONG THE DEALERS IN ART POTTERY, CUT GLASS, BRONZES, ETC.

HALL CLOCKS  
BEAUTIFUL AND CHEAP.

ABOUT fifty different varieties of English hall clocks are displayed in the show rooms of the Chas. Jacques Clock Co., 22 Cortlandt St., New York, in plain and carved oak and mahogany cases. The movements are both Elliot's and Evan's striking one, two and sometimes three chimes upon gongs, or bells, or upon both. Many magnificent cases of entirely new designs are now shown at prices that are astonishingly low. As this company now manufacture their own cases, they are enabled to offer their hall clocks at a lower figure than their former import cost, in many instances the selling price being twenty per cent. less than that of last year.

HONORS IN  
AUSTRIAN CHINA.

I noticed in the New York Times of Sept. 28th, the following notice of the World's Fair exhibit of Lazarus, Rosenfeld & Lehmann: The Victoria China Works, of Altröhlau, near Carlsbad, Bohemia, owned by Lazarus & Rosenfeld,

represented in New York at 60 and 62 Murray St., and in Chicago at 66 Lake St., by Lazarus, Rosenfeld & Lehmann, have been awarded the highest honors by the jury of awards in the conferring of medals and diplomas for china and Bohemian glass. This action of the jury, so far as it relates to the china display of the Victoria Works, is the only recognition made of china in the Austrian section. The exhibit of china and glass thus signally distinguished is under the balcony in the Austrian section, and is naturally a very superior one. It is rendered specially notable by a \$10,000 pair of vases, representing Liberty and Progress, produced at the Victoria Works, superbly decorated by Prof. A. Griel, chief designer and artist of the Imperial Court Theatre, Vienna. Besides these vases, there are displayed dinner, tea, toilet, fish and game sets, plates, souvenir cups and saucers, smaller vases, jardinières, jugs and brie-à-brac in great variety, and all in the very highest art of the china maker's skill. They are exclusively the product of the Victoria Works, and Mr. E. H. Lyons, Chicago manager of Lazarus, Rosenfeld & Lehmann, stated to the New York Times's correspondent that not a piece in the exhibit would be returned, but would be sold from the display, irrespective of price. He also said that a line similar to the competitive exhibit, which secured first honors, would be offered to the trade this season from the New York and Chicago houses.

P. H. LEONARD'S  
DRESDEN CHINA

A complete line of novelties, with the Dresden decoration and with gold finish, to be seen in the ware-rooms of P. H. Leonard, 76 Reade St., New York, is one that will in all probability become popular with jewelers who handle these lines, as the variety is unusually extensive and the pieces exceedingly pretty. The trade mark here illustrated, which is the coat-of-arms of the city of Dresden, is stamped on all the pieces in this line and is a guarantee of their perfect quality and fineness.



ADDITIONS IN  
COLONIAL WARE.

At the New York ware-rooms of the Mt. Washington Glass Co., 46 Murray St., there can be seen many entirely new additions to the line of exquisite Colonial ware which this company put upon the market some months ago. In jewel boxes and trays particularly have been introduced many beautiful varieties in shapes and decorations, both, original and artistic. The new jewel boxes are of two different styles and in three sizes, and with the brush and comb, fruit, tea and manieure trays, show handsome colorings in tints of red, blue, lemon, pink and light green.

# NOTICE TO JEWELERS!

WE ARE NOW PREPARED TO SHOW YOU THE MOST EXQUISITE

— LINE OF —

## M. REDON'S FRENCH CHINA,

WHICH HAS GAINED A WORLD WIDE REPUTATION FOR EXCELLENCE OF MANUFACTURE AND NEATNESS AND BEAUTY OF SHAPE AND DECORATION; A FULL AND COMPLETE LINE SHOULD BE CARRIED BY EVERY JEWELER.

# CHAS. AHRENFELDT & SON,

50, 52 & 54 MURRAY STREET,

NEW YORK.

AGENTS FOR THE UNITED STATES AND CANADA.



# ANNOUNCEMENT



**FALL, 1893.**

OUR Importations for the coming season are now arriving and we have on exhibition at our ware-rooms a complete assortment of exclusive

## Novelties and Specialties

SELECTED FOR THE JEWELRY TRADE.

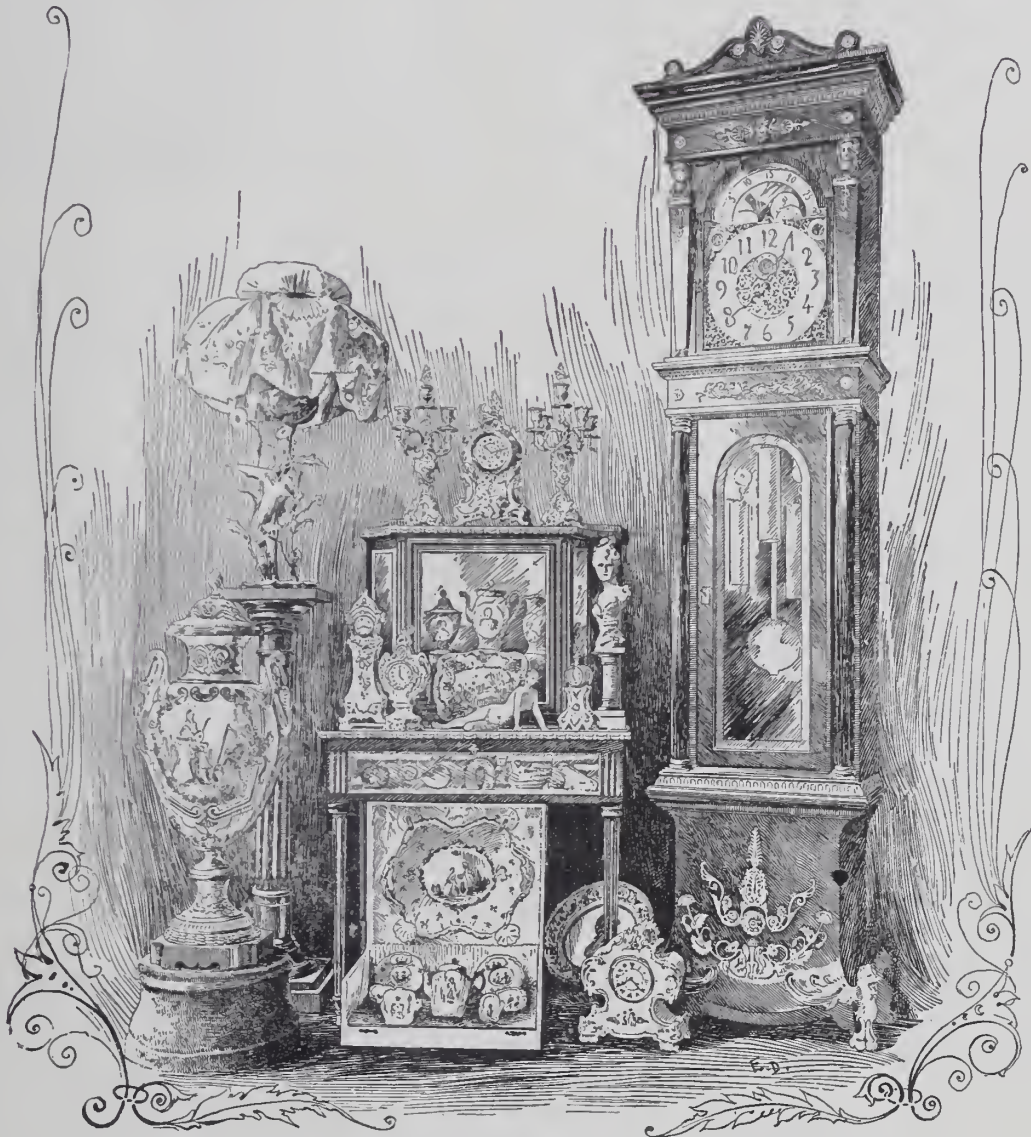

SPECIMENS OF FALL GOODS FROM THE STOCK OF LEON J. GLAENZER & CO.

Clocks, Bronzes, Sevres Vases, Fine Decorated Porcelains, Cups and Saucers, Tea Sets, Lamps and gilt and silver plated filigree Photo Frames in endless variety

# LEON J. GLAENZER & CO.,

35 Boulevard de Strasburg, Paris.

80 & 82 CHAMBERS ST., N. Y.

## The Connoisseur.

(Continued from page 52.)

Floral decoration of various kinds, outlined in gold, ornament nearly all the pieces.

\*

F. W. BUNING & CO.'S  
NEW SPECIALTIES.  
New lines are constantly being added to the French china specialties for jewelers, imported by F. W.



BISQUE SHOWN BY LEVY, DREYFUS & CO.

Büning & Co., 58 Murray St., New York, especially to the line of photo-frames, trays, bonbon and jewel boxes, sugar, creams and

chocolate and other sets. The line of novelties with the delicate green decoration is now very extensive, and is replete with the specialties before mentioned. Some are ornamented with the delicate lily-of-the-valley in natural color, while others, principally the plates, have a slight green and gold decoration on the rim with a group of Cupids in the center.

THE RAMBLER.

### Levy, Dreyfus & Co.'s Glazed Bisques.

AMONG the specialties shown by Levy, Dreyfus & Co., 11 Maiden Lane, New York, are many exceedingly large and handsome pieces, three of which are depicted in the illustrations in this department. The first, the woman with the fan, is one of a pair of glazed bisque busts representing Chinese ladies in court dress. The piece illustrated portrays her in the position before bowing, and the companion piece that after bowing. The colors, especially those in the fan, are extremely rich and bright.

The bird fancier and snake charmer shown in the other illustration are two of a set of three figures representing Hindoo fakirs in their native costumes. These are also of glazed bisque, and stand about three feet high. The turban and dress are of pale Nile green which harmonizes well with the natural brown color of the face and arms.

Fashion is a fickle jade. For quite a considerable time now silver mounted china and pottery ware has been all the rage for



BISQUES SHOWN BY LEVY, DREYFUS & CO.

small table goods, to the great advantage of the Staffordshire firms. Now, all this promises to be changed in favor of glass, judging from the steadily growing demand for such ware reported by Sheffield silver-smiths.—*Pottery Gazette*. (London.)

One man's eyes are spectacles to another, to read his heart with.—*Steele*.



## Exceptional Opportunity

FOR

## Bric-a-Brac Buyers!

OUR entire collection of IMPORT SAMPLES of HIGH ART NOVELTIES, specially imported for the Jewelry

Trade, are now on exhibition and will be sold on and after Sept. 1st, at Big Reductions to make room for new importations of Fine Pottery, Art Furniture, Marbles, Exclusive Art Productions, &c.

## GEO. BORGFELDT & CO.,

18, 20, 22 WASHINGTON PLACE, cor. Greene Street, NEW YORK.

# Art Corners in Geo. Borgfeldt & Co.'s Establishment.



ART ROOM NO. 1.



ART ROOM NO. 2.



ART ROOM NO. 3.



ART ROOM NO. 4.

## To Jewelers and Art Dealers :

Our third floor, 100x100 FEET is devoted exclusively to BRIC-A-BRAC, ARTISTIC NOVELTIES and the RICHEST PRODUCTIONS in ART POTTERY, GLASSWARE, CLOCKS, PEDESTALS, ETC., of which these cuts will give some idea.

We are disposing of these collections at SPECIAL PRICES, preparatory to the arrival of our new lines for 1894, thus affording an EXCELLENT CHANCE for buyers to obtain, with small outlay, a beautiful assortment of CHOICE GOODS.

Very Respectfully,

# GEO. BORGFELDT & CO.,

18, 20 & 22 Washington Place, New York.

### Points of Law.

#### PAYMENT OF TAXES BY CHECK.

As the statutes of Massachusetts contemplate payment of taxes in money, if the collector, for the convenience of taxpayers or himself, receives checks in the absence of any agreement to the contrary, they are to be taken as a conditional payment, and if they are not paid the claims for taxes is not satisfied and may still be enforced.

*Houghton v. City of Boston. Supreme Court of Mass.*

#### DAMAGES FOR UNLAWFUL DISCRIMINATIONS BY CARRIERS.

The measure of damages to a shipper of coal, for unlawful discriminations by a railroad company, in favor of another coal shipper, similarly circumstanced as to place and distance, is the amount which the complaining party would have received if he had been allowed the same rebate per ton as the favored shipper. The question whether profits were lost in the sale of coal by reason of the non-allowance of such rebates is too remote to be considered.

*Union Pac. R. Co. v. Goodridge.*

#### REMEDY AGAINST MORTGAGEE FOR STORAGE OF MORTGAGED GOODS.

The fact that a landlord on rightfully taking possession of the leased premises, finds himself involuntarily in possession of

a stock of goods left by an outgoing tenant, which are mortgaged to their full value, and which the mortgagee declines to take into possession or pay for storing, does not give the landlord a right of action against the mortgagee to recover compensation for storage, and to reach in payment thereof his interest in the goods, although the remedy by suit against the mortgagor is worthless.

*Field v. Roosa, Sup. Jud. Court of Mass.*

### Art Works in Semi-Precious Stone.

A CRYSTAL name seal shown in the World's Fair exhibit of Krauth & Dreyer, is 4 inches long, of skilful workmanship, and is valued at \$300. A table top in varied colors of American petrified woods can be purchased for \$2,000. Mortars and pestles, bowls, writing sets in cases, and numerous small pieces complete what is without doubt the greatest collection of cut agate wares ever exhibited. The German Government fostered the exhibit of the industry, by sending experts to investigate at Hettstein-Idar, and later paying the freight and giving a bonus of 600 marks.

The German committee expressed themselves that Krauth & Dreher were the most worthy to introduce the industry in the United States. With a total value of \$150,000 it is indeed a wonderful exhibit.

### CUPID'S GOLD-TIPPED ARROWS.

ONE day in May, when apple buds  
Upon the bough were pink  
And every wind caught up a song  
Of thrush or bobolink,  
Along the meadows Cupid lagged,  
His silver bow unstrung,  
The lashes on his rosy cheek  
With heavy tear-drops hung.

"O mother, mother mine!" he sobbed,  
"The world is all awry,  
And hearts to-day are nothing like  
The hearts of times gone by.  
In vain my pretty arrows fly—  
There's not a knowing lass  
But from her window scornful leans  
To mock me as I pass."

Dame Venus kissed his tears away  
And whispered in his ear  
A word that sent him dancing off  
With laughter blithe to hear.  
While fitting to his string a shaft  
He watched it, as of old,  
Unerring speeding to the mark—  
Ah, me! 'twas tipped with gold!

—Vogue.

#### A GENTLE REMINDER.

Colonel Calliper in one of his softer moods—it was after dinner and he was at peace with all the world—was gently whistling "Silver Threads Among the Gold."

"Jason, dear," said Mrs. Calliper, "didn't you know the Silver bill had been repealed?"—*New York Sun.*

Call early to see our  
Art Goods for Jewel-  
ers, Especially select-  
ed for all Jewelry  
Stores.

NOTE—MANY FINE IMPORT SAMPLES  
AT 50 PER CENT. REDUCTION.

An entire  
New Stock di-  
rect from the  
Art Centers of  
Europe.



The finest  
line of "Nov-  
elties" for  
Jewelers ever  
shown in this  
market.

LEVY,  
DREYFUS & Co.,  
9 & 11 Maiden Lane, N. Y.

OPERA GLASSES IN VARIETY UN-  
EQUALED IN THE U. S.

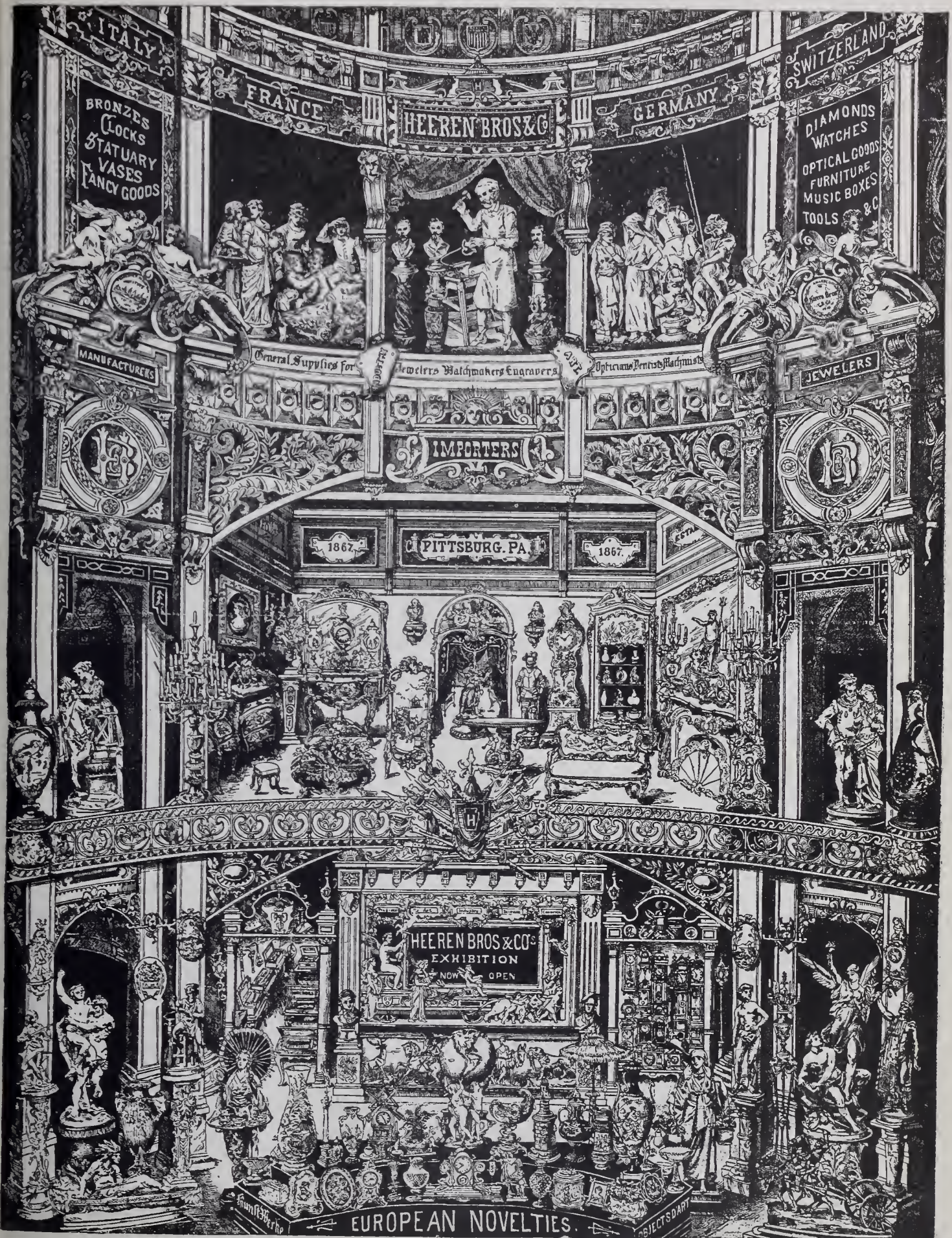



ESTABLISHED 1801.

# HINRICHS & CO.,

29 &amp; 31 PARK PLACE,

Cor. Church Street,

NEW YORK.

Art Pottery and Bric-a-Brac,  
CUT GLASS, FANCY GLASS, CHINA.

Large Assortment of

Fine Dresden China Lamps, Glass and  
other Fancy Lamps.

THE LARGEST ASSORTMENT OF SPECIALTIES FOR THE JEWELRY TRADE, AT LOWEST PRICES.  
CATALOGUE ON APPLICATION.

## FRENCH CHINA SPECIALTIES FOR JEWELERS.

BRUSH & COMB TRAYS,  
CARD TRAYS,  
MANICURE TRAYS,  
PEN TRAYS,

PHOTOGRAPH FRAMES,  
FRUIT PLATES,  
ODD CUPS AND  
SAUCERS, ETC.

◁ SEND \* ORDER \* FOR \* SAMPLE \* ASSORTMENT. ▷

## F. W. BUNING & CO.,

58 MURRAY STREET,

NEW YORK.

### Rich Cut Glass

AND

DECORATED ART WARES.



Mt. Washington Glass Co.,

New Bedford, Mass.

RICH DISPLAY OF GOODS AT

New York Store: 46 Murray St.

When you visit Chicago do not  
fail to inspect our full line of goods  
at the new store of Pairpoint Mfg.  
Co., 224 Wabash Avenue.

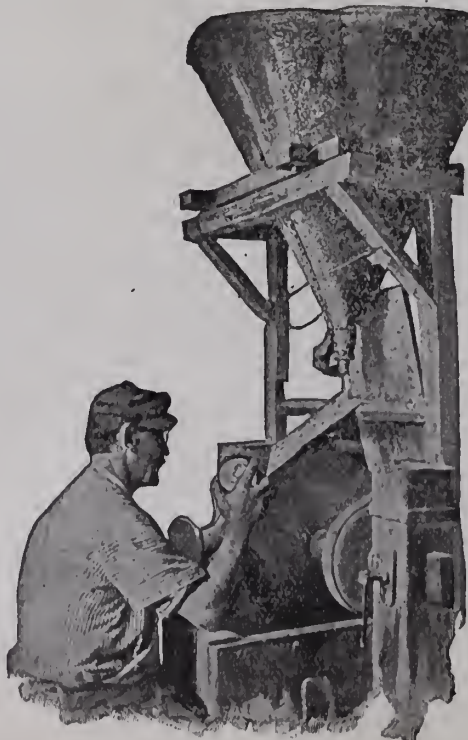

GLASS CUTTER AT WORK.

### The Other Side of Life.

A GENTLE HINT.



TOM PUFFER (as he blows out a ring of smoke)—Ah, isn't that a perfect silver ring!  
GRACE INNIT (with feeling, as she puts her finger through it)—O George! How nice it would be if it were only gold!—*Puck*.

"Have you a watch?" asked Brown.

"No; but here's my 'time piece,'" replied White, producing a pawnticket for his ticker.—*Philadelphia Record*.

She was from Boston, and he was showing her around the city.

"There," he said, pointing to the Penn statue in the City Hall court yard, "what do you think of that? The nose of that man is 13 inches long."

SHE—What a lovely nose for spectacles.—*Philadelphia Record*.

AN APPLICATION OF IT.

JIM—Love laughs at locksmiths.  
TOM—That's what your *fiancée* said when I was holding her hand, and saw that lock bracelet you put on her arm.—*Life*.

PRECIOUS SOUVENIRS.

"I am in a dreadful fix. Do, please, lend me ten marks."

"But you have got a diamond ring; why don't you pawn it?"

"I can not find it in my heart to do so; the ring is a memento of my deceased aunt."

"Really? Well, then, my money is a memento of my deceased father."—*Der Bar*.

A SWEETHEART'S DILEMMA.

Hanging over a jewelry stall at a fair were a bashful young farmer and his equally embarrassed sweetheart. They were painfully unsophisticated, and the vendor obligingly assisted in the selection of a jeweled twenty-five cent ring, while rattling off, "There ain't no jewelry on the grounds like this, neighbors. Plenty of brass, but here I have gold and silver—things as high as dollar and a half. It'll never tarnish, lady—all you do is take your tooth brush and polish it a bit," etc.

The sweetheart glanced half timidly at her companion and he looked his readiness to stand even the \$1.50 limit, but the first-mentioned ring was the purchase settled on.

# Craighead & Wilcox,

NO. 33 BARCLAY STREET, }  
NO. 38 PARK PLACE, }

NEW YORK CITY.



## REPRESENTING

CRAIGHEAD & KINTZ CO., Makers of Lamps and Metal Fancy Goods.

WALTER S. BERG, Maker of Silk Lamp Shades.

HARTFORD SILVER CO., Makers of Silver Plated Goods.

ALFRED HACHE & CO., Successors to HACHE, JULLIEN & CO.,

Vierzon, France, Makers of French China.

---

THE COMPLETE NEW LINES ARE NOW ON EXHIBITION AT OUR SALESROOM.

WOLFF & GUNZBURGER, Importers of DIAMONDS, (Fulton Building), NEW YORK.

**FALKENAU, OPPENHEIMER & Co. DIAMONDS**  
40 MAIDEN LANE NEW YORK

**PEARLS.**  
M. D. ROTHSCHILD,  
NEW YORK: 41 & 43 MAIDEN LANE  
LONDON: 15 HOLBORN VIADUCT  
PARIS: 58 RUE LAFFITTE.

FRENCH WRITE FOR CATALOGUE. ENGLISH  
**CLOCKS**  
AND CLOCK MATERIALS.  
CHAS. JACQUES CLOCK CO., 22 CORTLANDT ST., N. Y.



**L. LELONG & BRO.,**  
GOLD AND SILVER  
Refiners, Assayers AND Sweep Smelters,  
SOUTHWEST CORNER HALSEY AND MARSHALL STREETS,  
**NEWARK, N. J.**  
SWEEPINGS A SPECIALTY.

**S. P. HOWARD,**  
Gold and Silver Assayer.  
Refiner and Sweep Smelter,  
33 MAIDEN LANE, NEW YORK.  
Smelting and Refining Works,  
28 & 30 Cumberland Street, Brooklyn, N. Y.  
Specialties: Sweepings, Gold, Silver and Platinum

**HENRY ABBOTT,**  
MANUFACTURER OF  
Stem-Winding Attachments  
FOR WATCHES,  
No. 2 Maiden Lane, NEW YORK.

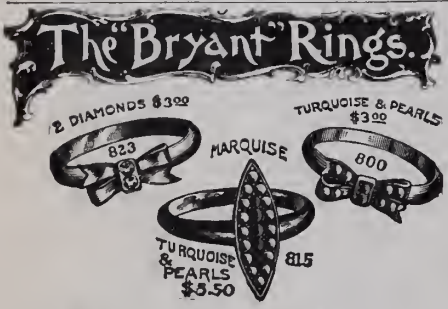

have in 45 years earned the reputation of being the standard in quality, style, finish and durability. They are made of solid gold, in great variety, for men, women and children.

**ASK YOUR JEWELER FOR THEM.**

If he don't keep them and won't send for them, send us your money and we will deliver them through the nearest reliable jeweler.

**OUR INITIAL AND RAILROAD BROTHERHOOD RINGS**

With or without diamonds, are the handsomest made.



**M. B. BRYANT & CO.,** No. 10 Maiden Lane, New York.  
OLDEST RING MAKERS IN AMERICA.

**The Bryant Rings.**

Are extensively advertised in the leading magazines, Family, Religious and Fashion papers for the benefit of the Retail Jeweler.

The adjoining advertisement will appear for a year in the great R. R. BROTHERHOOD Journals.

PRICES of our INTERCHANGEABLE Rings either with emblems with six diamonds, or without diamonds will be sent to Jewelers only on application.

**WHY** S. F. MYERS & CO. sell more goods than any other Wholesale Jewelry House. **BECAUSE** They are the only firm in the Metropolis who carry in stock a full line of everything a jeweler requires. They give the utmost values and endeavor to please their trade in every respect. Refer to their various publications and illustrated catalogues.  
**MYERS BUILDINGS, 48 & 50 Maiden Lane, NEW YORK.**

**ALBERT LORSCH & CO.**

37 MAIDEN LANE, NEW YORK.  
Branch, 167 Broad Street, Providence, R. I.

— IMPORTERS OF DIAMONDS, —  
Rose Diamonds, Rubies, Sapphires, Emeralds, Opals, Moonstones, Fancy and IMITATION STONES, NOVELTIES.

SOLE OWNERS AND IMPORTERS OF *The Sumatra Gem.* REGD.

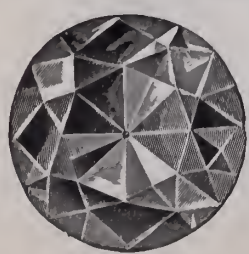

L. & W. KATIN & CO., Importers of DIAMONDS, Cor. Maiden Lane, NEW YORK.



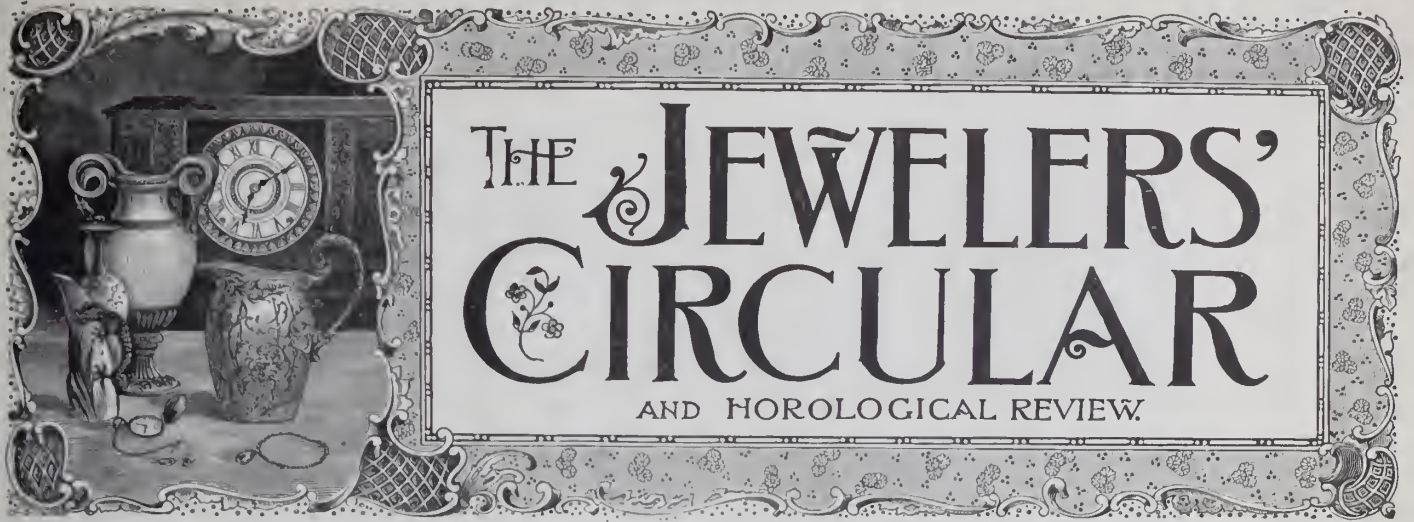

Copyright, by THE JEWELERS' CIRCULAR PUB. Co.

189 Broadway, New York.

Entered at the Post Office in N. Y. as second-class matter.

VOL. XXVII.

NEW YORK, WEDNESDAY, OCTOBER 11, 1893.

NO. 11.

ART IN TIFFANY & CO'S WORLD'S FAIR EXHIBIT.

THE receiving by Tiffany & Co. of the many awards at the World's Columbian Exposition as reported in this and previous numbers of THE CIRCULAR, is sufficient evidence of the excellence of the wares produced by the house, and is a continuation of the honor conferred upon them at the Paris Exposition Universelle of 1889, when they were awarded the grand prix. The distinction conferred upon this house by the Princess Eulalia, upon the occasion of her visit to the Exposition, in the appointment of Tiffany & Co. as jewelers and silversmiths to Her Highness, is a tribute to the genius of a people, to the artistic inspiration of its native talent, and to the extraordinary skill developed by its artisans, through whose delicate manipulation, the conception of the artist is faithfully expressed.

A general review of the exhibit was published in THE CIRCULAR of March 29, and as it would be a vain undertaking to endeavor to enumerate and describe the complete display, we will place before our readers illustrations of only some of the salient pieces in the jewelry, silverware and horological lines. The general character of the jewelry exhibit made by the firm reveals the most exhaustive study of all the earlier periods noted for their artistic productions; there are suggestions of the Giardinetto

teenth and fifteenth centuries, old Hungarian, Russian, Turkish, Spanish, Egyptian,

the French of the Renaissance, the Empire, the Louis' and other periods.

The tiara in the illustration (page 27) is a band set with brilliants, diamond cluster in the centre and five pear shaped pearls pendent on the side. It is a characteristic piece and one of the handsomest in the exhibit. Other prominent hair ornaments in the display are a spray of moss roses, three yellow sapphires forming the roses, diamonds the petals, demantoids the leaves and stems, the gold mounting being colored like the flower and stem in nature; dragon fly consisting of tourmalines and diamonds with gold fancy ornamentation; Raphael head ornament of diamonds in cluster and feather of demantoids; dragon fly of demantoids and diamonds with gold fancy ornamentation; urchin spray aigrette with an ornamented and pierced gold center, the form being suggested by a sea urchin; and a diamond aigrette set in a pear shaped Peruvian emerald.

A marvelous set is the pink topaz and diamond set shown in the illustration on this page. It consists of a tiara of pink topaz and brilliants in clusters and scrolls, a pendant of pink topaz set in brilliants, and a necklace of pink topaz, the whole being in medieval style. There are 1,722 diamonds and 105 remarkable specimens of pink topaz in this set

(Continued on page 27.)



PINK TOPAZ AND DIAMOND SET IN WORLD'S FAIR EXHIBIT OF TIFFANY & CO.

jewelry, the old Italian style of the four-

tian, Portuguese, Grecian, Siamese, East Indian, Burmese, Javanese, Japanese and

able specimens of pink topaz in this set

# THESE LEATHERS ARE MADE IN THE FOLLOWING ARTICLES:

Card Cases,  
 Pocket Books,  
 Photo. Frames,  
 Calendars,  
 Folios,  
 Purses,  
 Combination Books,

Spectacle Cases,  
 Memo. Books,  
 Check Blotters,  
 Address Books,  
 Visiting Books,  
 Bill Folds,  
 Cigarette Cases,

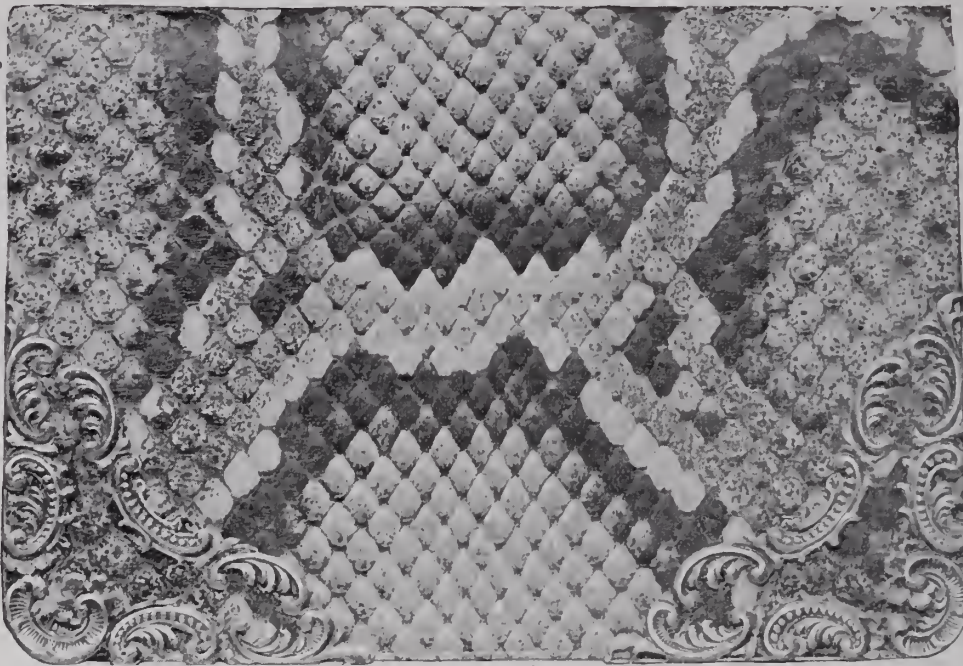

NATURAL SNAKE CARD CASE—STERLING CORNERS— ROCOCO.”

Desk Pads,  
 Cigar Cases,  
 Prayer Books and Hymnals,  
 Stamp Cases,  
 Watch Card Cases,  
 Marriage Registers,

Engagement Pads,  
 Eye Glass Cases,  
 Finger Prayer Books,  
 Telegraph Pads,  
 Chatelaine Bags,  
 Pen Wipers.

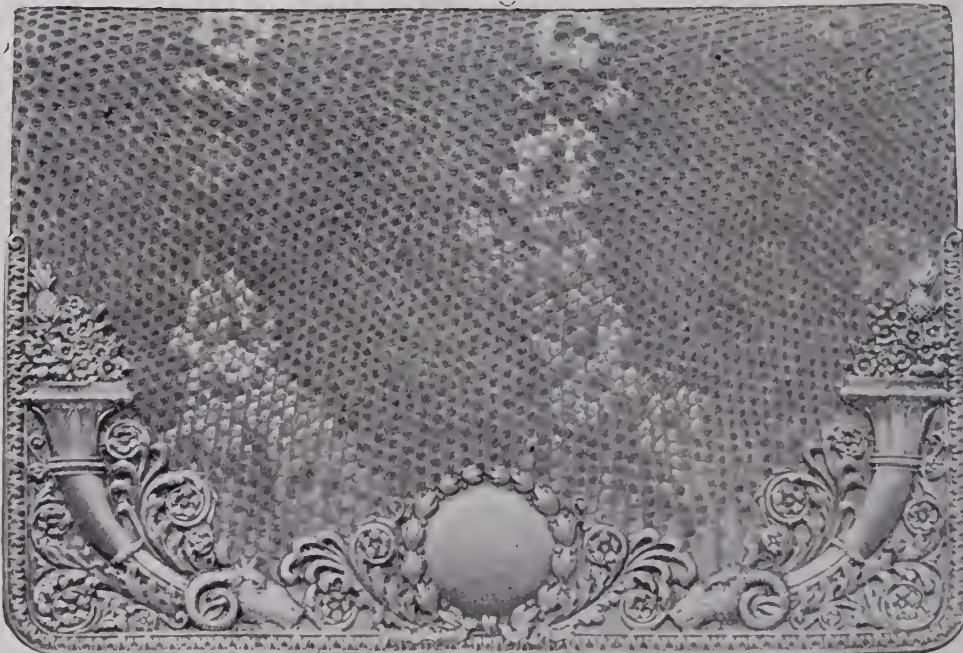

NATURAL LIZARD COMBINATION—STERLING FRONT— EMPIRE.

# DEITSCH BROS., 7 E. 17th Street, NEW YORK.

ORIGINATORS AND MAKERS OF

## NOVELTIES IN LEATHER AND STERLING SILVER COMBINATIONS,

### ALSO EBONY AND SILVER COMBINATIONS IN NOVELTIES AND TOILET SETS.

LARGEST ASSORTMENT IN THE COUNTRY.

# ROGERS, SMITH & CO.

UNION SQUARE,  
NEW YORK.

MERIDEN,  
CONN.



## BEST QUALITY GOLD AND SILVER PLATE.

### LLOYD PATENT.

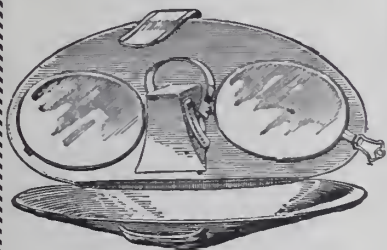

In Good LLOYD **CASE** you want a send for

**H. E. KIRSTEIN & CO.,**  
MANUFACTURERS,  
Rochester, N. Y.

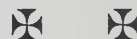
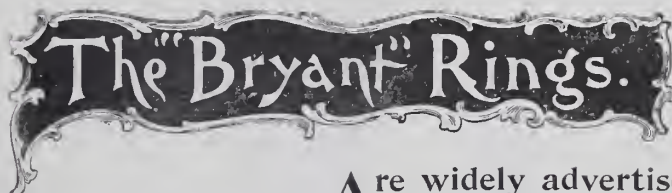

Are widely advertised and will sell  
when anything will, therefore  
every Retail Jeweler should buy them.

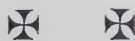

IF NOT CALLED UPON BY OUR TRAVELERS  
ORDER DIRECT FROM

**M. B. BRYANT & CO.,** - 10 MAIDEN LANE, N. Y.

OLDEST RING MAKERS IN AMERICA.

**OPTICIANS' SUPPLIES**  
Jobbing and Prescription Work.

The "Graduate" Trial Cases, 150 1/2 doz set, \$30.00; 220 lens set, \$37.50. The "Standard" Trial Case, 229 lens set, \$65.00. All with lugs. Loring Ophthalmoscope, \$9.00. Artificial Eyes, for selection, \$1.00 each, \$50.00 per hundred. Ophthalmometers, \$50.00 to \$70.00. Queen's Standard Perimeter, \$18.50. Queen's Lens Grinding Outfit, \$3.00. Steel Frames, 15 to 20 cents each. Spherical Lenses, 25 cents per pair. Cylinders, 35 to 40 cents per pair. Lenticular Bifocals, 80 cents per pair, (all best). Nose pieces, German or Shelly. German Silver, \$1.00 per dozen pairs, (all) \$5.00 per dozen pairs.

**QUEEN & CO.** Opticists and Opticians,  
Catalogue free. 1010 Chestnut St., Phila., Pa.

# THE FIVE MOST DESIRABLE PATTERNS

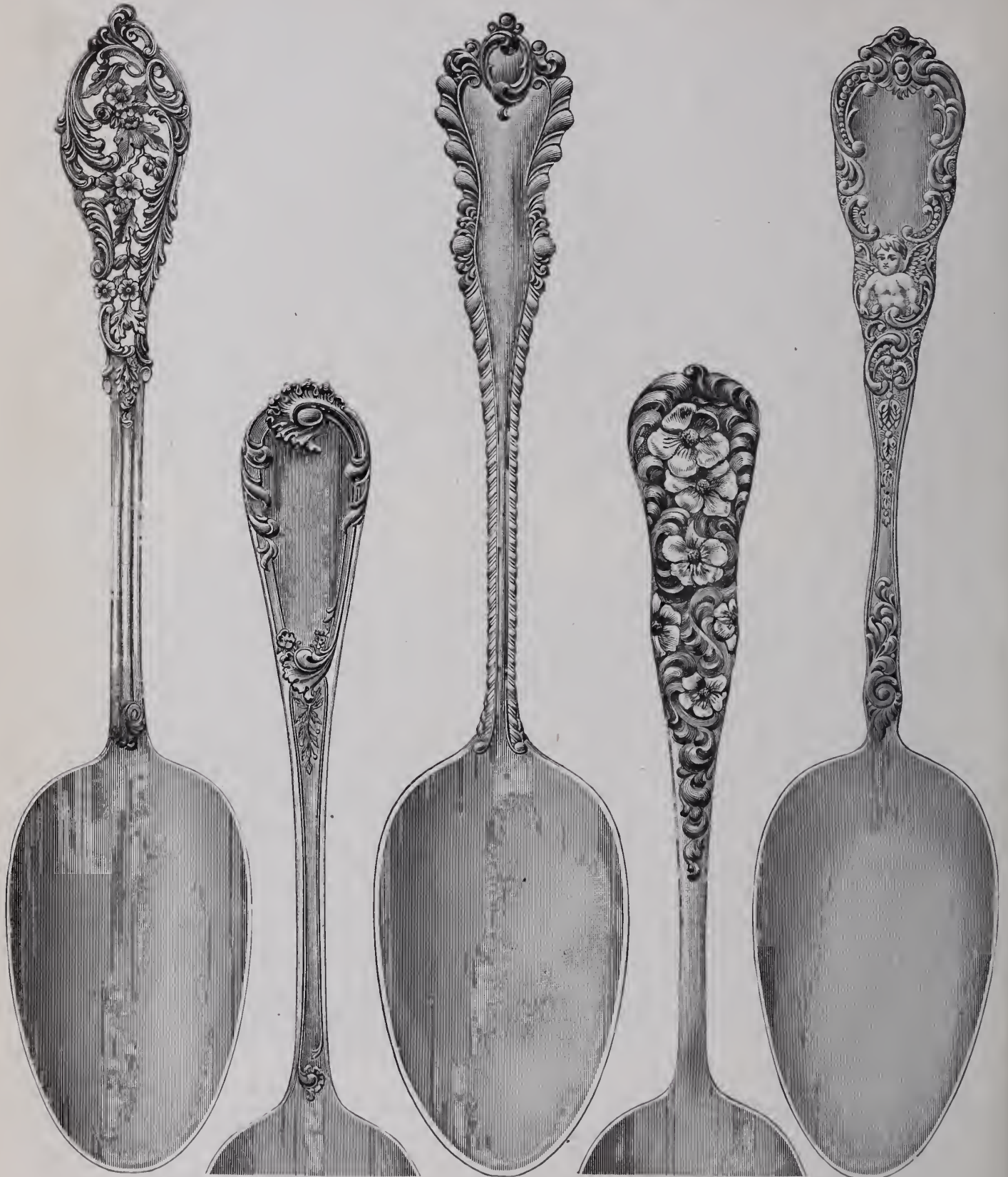

TRIANON.—Pierced.

LOUIS XIV.

MAZARIN.

ROCOCO.

CUPID.

**Dominick & Haff,** Makers of Wares in Sterling Silver.  
 ESTABLISHED 1821, Broadway and Seventeenth St., Union Square, N. Y.

*Pairpoint*

# MFG. COMPANY,

GOLD AND SILVER PLATE, New Bedford,

Mass.

DO NOT FAIL to see our exhibit at Columbian Exposition, Section N, Manufactures Building, and our store, 224 Wabash Avenue, Chicago.



No. 3483. Embossed Tea Caddy.

CHICAGO,  
224 Wabash Ave.



No. 927. Jewel Casket.

NEW YORK,  
20 Maiden Lane.



No. 3727. Hair Pin Box.

SAN FRANCISCO, CAL.,  
220 Sutter Street.

## CHAS. L. UHRY & Co.

N. Y. OFFICE,

189 BROADWAY.

- SCARF PINS,
- BROOCHES,
- CHARMS,
- FOBS.
- HAT PINS,
- HAIR PINS,
- CHATELAINES.

336 Mulberry St., Newark, N. J.

## CHAS. L. UHRY & Co.

### Brunor Plating and Jewelry Rep. Co.

Jewelry Matched and Repaired, Engraving, Chasing and Enameling, Setting, Polishing and Lapping, Battery Gilding and Roman Coloring, Watch Cases Repaired, Polished and Gilded.

32 Maiden Lane, New York.

We sell to the legitimate Jewelry and Stationery trade only.



### CHOICE PAPERS

MAKERS OF

## FINE STATIONERY

For Correspondence, Wedding and Business Use, handsomely boxed, specially suited to the Jewelry Trade.

18 MURRAY STREET, NEW YORK.

# NOVELTIES IN STERLING SILVER



No. 330. MATCH SAFE.



No. 14. PIN BALL.



No. 13. PIN BALL.



No. 325. MATCH SAFE.

Trade Mark.



R. W. & S.  
Sterling.



No. 104. POCKET KNIFE.



No. 102. POCKET KNIFE.

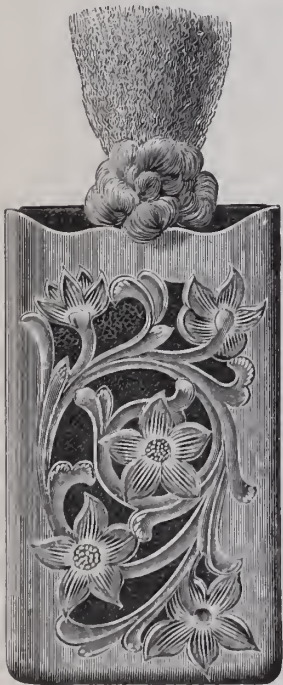

No. 3. COURT PLASTER CASE.



No. 39. CANDLE HOLDER.



No. 800. NAPKIN RING.

# R. WALLACE & SONS MFG. CO.,

# SILVERSMITHS,

NEW YORK,  
3 PARK PLACE.

WALLINGFORD, CONN.

SAN FRANCISCO, 120 SUTTER ST.

CHICAGO,  
86 WABASH AVE.

**The Demise of B. F. Wiggin.**

NEW ORLEANS, La., Oct. 2.—News was received here this week that B. F. Wiggin, for many years a resident of New Orleans, and engaged in business here, died on Tuesday night last at the residence of his brother-in-law, Wm. P. Coleburn, in Milford, N. H., where he had been spending the Summer months for the benefit of his health.

Benjamin F. Wiggin was born at Dorchester Heights, now a part of Boston, April 27th, 1832, and was a direct descendant of one of the best and oldest New England families. When his schooldays were over he learned the watchmaking business, and was one of the first to be employed by the American Waltham Watch Co. In New Orleans he was regarded as an expert on watch and chronometer work, and was one of the best authorities on horology in the country. Leaving Boston he came south about 1855, and was located in Mobile. He was twice married, his first wife being a Miss Benjamin, a ward of Gideon Welles, who was called to be secretary of the navy in President Lincoln's cabinet. This lady died of yellow fever at Mobile, in 1858.

When the civil war broke out Mr. Wiggin was in New Orleans and was commissioned by Governor Thos. O. Moore, as lieutenant of Company A, of the Fourth Regiment. Longing for immediate service and a place at the front he was transferred to the trans-Mississippi department, and served in Cowan's Battery of light artillery, of Vicksburg, participating in all the battles of the Army of the Tennessee, including the sieges of Vicksburg and Atlanta. It can be understood that young Wiggin, northern born and closely connected by marriage with President Lincoln's secretary of the navy, could have had speedy promotion if he had chosen to enter the northern army, but he was not of that class of men who have selfish ends in view. He became a southern man when he cast his lot with this people, and no better confederate soldier went to the war than he was, and until his death he was an active and honored member of the Veteran Army of the Tennessee Association. After the war Mr. Wiggin married Miss Julia C. Colburn, of New Hampshire, and she survives him.

The deceased was in every respect one of the finest and most honorable men the jewelry trade has had to boast of. The funeral took place yesterday. One of the pall bearers appointed by the Grand Army of Tennessee, was William Bardel, of Heller & Bardel, New York.

**Imports and Exports for August, 1893, and the Preceding Eight Months.**

WASHINGTON, D. C., Oct. 5.—The summary statement of imports and exports for the month ending Aug. 31, 1893, and for the eight months ending the same date, compared with the corresponding periods of 1892, has been issued and contains the following figures relative to the jewelry trade:

IMPORTS.—Diamonds and other precious

**BIPPART & CO.,**

— MANUFACTURERS OF —

**FINE JEWELRY,**  
NEWARK, N. J.

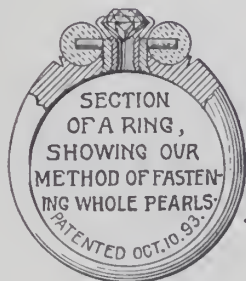

We claim our

**"Patent Whole Pearl Fastener"**

superior to all others now in use, and absolutely secure. It enables us to make a line of Rings, Scarf Pins and Brooches unsurpassed in durability and finish.

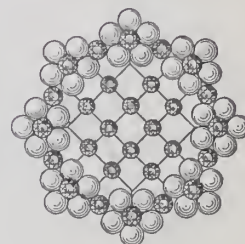

PATENTED OCT. 10TH, 1893.

New York Office, 19 MAIDEN LANE.

**THE BOWDEN SEAMLESS RING**

IS MADE ONLY BY

**J. B. BOWDEN & Co.,**

Makers of Finger Rings of every Description.

**COR. BROADWAY & JOHN STREET,  
NEW YORK.**

**J. B. & S. M. KNOWLES CO.,**

MAKERS OF

**Sterling**



**Silverware.**

FACTORY,  
Providence, R. I.

SALESROOM,  
860 Broadway, N. Y.

**O. W. BULLOCK & CO.,**  
SPRINGFIELD, MASS.

Makers of Watch and Jewelry Tools,  
NEW CATALOGUE NOW READY.

Sent on Application. Please Mention this Paper.

**CLEAN JEWELRY SELLS QUICK.**

Quarters' Cleaning Solution removes dirt and tarnish in an instant, makes stock like new and brings up diamond and stone work to a beautiful lustre. Solution can be used over and over. Highly commended by all who use it. Send at once \$1.50 for half gallon with full directions. References.

**W. F. QUARTERS ELECTROPLATER,**  
139 EDDY STREET. PROVIDENCE, R. I.



**ARTISTIC  
METAL  
GOODS.**  
NEW DESIGNS,  
NEW FINISHES.

Our line of Pitchers, Vases, Tables, Candlesticks, Five O'Clock Teas, Etc., cannot be equaled.

**THE  
CELEBRATED  
"B & H" LAMP.**



BEAUTIFUL DESIGNS,  
particularly adapted to the Jewelry Trade.

SEE OUR LINE OF

**TABLE, BANQUET AND PIANO LAMPS**

before placing your orders. Send for our Little Book.

**BRADLEY & HUBBARD MFG. CO.**

NEW YORK, BOSTON, CHICAGO,  
21 BARCLAY ST., 160 CONGRESS ST. 88 WABASH AVE.  
26 PARK PLACE, Factories, MERIDEN, CT.

**"THE BEST BUTTON MADE."**

IN GOLD

FROM

**KREMENTZ & CO.**

And all Jobbers.

THE KREMENTZ



ONE PIECE

IN ROLLED PLATE

FROM

ALL JOBBERS.

**COLLAR BUTTON.**

IS THE ORIGINAL ONE PIECE BUTTON.

IS STILL THE BEST AND STILL UNSURPASSED.

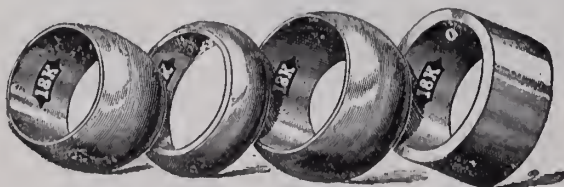

**PLAIN SOLID GOLD RINGS.**

**HILDRETH MFG. CO.,**

53 MAIDEN LANE,

NEW YORK.

stones, rough or uncut, including glaziers' and engravers' diamonds not set, and jewels to be used in the manufacture of watches: Month of August 1893, \$43,647 against \$110,761 same month of 1892, and \$23,393 in July; clocks and parts of, August, 1893, \$23,552 against \$19,744 same month of 1892, and \$17,544 in July; watches and parts of, and watch materials and movements, August, 1893, \$96,941 against \$123,961 same month of 1892, and \$130,791 in July; jewelry and manufactures of gold and silver, August, 1893, \$58,149 against \$56,980 same month last year, and \$60,848 in July; precious stones and imitations of not set, August, 1893, \$347,200 against \$1,979,968 same month last year, and \$561,692 in July; platinum, unmanufactured, August, 1893, \$33,792 against \$45,241 same month last year, and \$45,688 in July.

EXPORTS OF DOMESTIC MERCHANDISE.—Clocks and parts of, August, 1893, \$84,073 against \$86,629 same month last year, and \$65,904 in July; watches and parts of, August, 1893, \$45,958 against \$16,892 same month last year, and \$34,373 in July; jewelry and manufactures of gold and silver, August, 1893, \$103,871 against \$43,198 same month last year, and \$96,336 in July; plated ware, August, 1893, \$22,076 against \$28,144 same month last year, and \$32,739 in July.

IMPORTS, for eight months ending August 31, 1893.—Diamonds and other precious stones, rough and uncut, etc., \$632,738 against \$703,042 in 1892; clocks and parts of, etc., \$115,022 against \$92,417 in 1892; watches and parts of, etc., \$1,040,650 against \$933,550 in 1892; jewelry and manufactures of gold and silver, \$508,812 against \$284,237 in 1892; precious stones and imitations of, not set, \$8,966,567 against \$9,603,342 in 1892; platinum, unmanufactured, \$420,891 against \$390,634 in 1892.

EXPORTS OF DOMESTIC MERCHANDISE, for eight months ending August 31.—Clocks and parts of, \$613,230 against \$594,303 in 1892; watches and parts of, \$332,441 against \$109,386 in 1892; jewelry and manufactures of gold and silver, \$731,359 against \$437,648 in 1892; plated ware, \$221,318 against \$208,895 in 1892.

EXPORTS OF FOREIGN MERCHANDISE.—Diamonds and other precious stones, etc., August, 1893, nothing against nothing and \$355 against nothing for eight months; clocks and parts of, August, 1893, \$59 against nothing in August, 1892, and \$654 against nothing for eight months; watches and parts of, etc., August, 1893, \$153 against \$220 in August, 1892, and \$333 against \$252 in eight months; jewelry and manufactures of gold and silver, August, 1893, \$906 against \$3,123 and \$7,486 against \$59,777 for eight months; precious stones, etc., August, 1893, \$345 against nothing in August, 1892, and \$1,168 against \$4,395 for eight months.

The Appleton Clock Co., Appleton, Mo., have received their certificate of incorporation.



BUY ONLY THE BEST  
Electro Silver Plated Flatware,

STAMPED

★ ROGERS & BRO., A. I.

THE ORIGINAL, GENUINE AND CELEBRATED

**STAR ★ BRAND**

Which has stood the test for fifty years.....

.....For sale by all first-class jobbers.

MADE ONLY BY

**ROGERS & BROTHER,**

**Waterbury, Conn.,**

**16 Cortlandt St., N. Y.**

SEND FOR NEW ILLUSTRATED CATALOGUE, NOW READY.



TORTOISE  
\*  
SHELL.

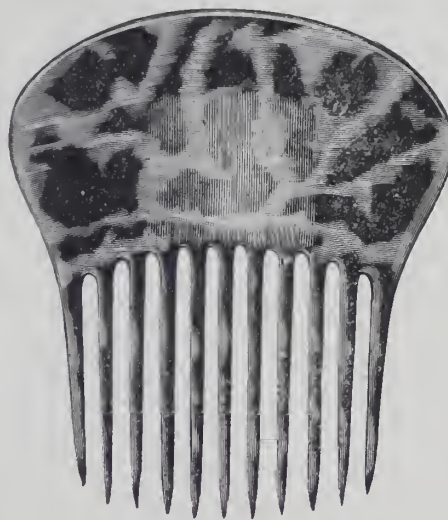

TORTOISE  
\*  
SHELL.



**RICE & HOCHSTER,**

.... MANUFACTURERS, ....

**483 & 485 Broadway,**

**NEW YORK.**

—NEW STYLES ALMOST DAILY.—

# THE "FLORALIA"

STERLING 925-1000 FINE.

Charmingly adapted for Wedding, Birthday and Friendship Gifts.

THE SENTIMENT OF FLOWERS DAINTIPLY EXPRESSED IN ARTISTIC SILVER FORMS.

MARGUERITE.  
INNOCENCE.



Of all the flowers in the mead I love the Daisie, white and rede.—Chaucer.

CLOVER.  
INDUSTRY.



Clover, sweet Clover, All the world over.—Old Rhyme.

FORGET-ME-NOT.  
REMEMBRANCE.



'Souviens de moi' (Remember me.) The motto of King Henry IV

PANSY.  
THOUGHT.



And there is Pansies, That's for thought.—Shakespeare.

LILY.  
PURITY.



Have you seen but a bright Lily grow?—Longfellow.

ROSE.  
BEAUTY.



Flowers of all hue and with out thorn, the Rose.—Milton.

Price \$4.00 a Set of Six Coffee Spoons, Oxidized or Bright.



## Alvin Manufacturing Co., Silversmiths,

860 BROADWAY, NEW YORK.

Works: IRVINGTON, N. J.

### THE IMPROVED RIVAL FOUNTAIN PEN.

Most Reliable and Guaranteed to Give Perfect Satisfaction. Over 75,000 in Use.



D. W. BEAUMEL, Inventor and Manufacturer, REPAIRING A SPECIALTY, 17 John St., New York.

WM. BIRMINGHAM & CO.,  
MANUFACTURERS OF  
All Kinds of Leather Spectacle and Eye Glass  
**CASES.**  
728 Arch Street, PHILADELPHIA, PA.

SOLICITORS OF AMERICAN & FOREIGN PATENTS

FOR DESIGNS INVENTIONS TRADE MARKS

SEARCHES MADE & INFRINGEMENTS PROSECUTED OR DEFENDED

THE WILL TRADE WILL SAVE TIME AND MONEY BY HAVING THEIR PATENTS TAKEN BY

COX & SONS 11 PARK ROW, N.Y.

PEARLS.

RUD. C. HAHN,

194 BROADWAY, NEW YORK.

GARNETS.

**The French Delegation Inculcate American Ideas on Jewelry.**

PROVIDENCE, R. I., Oct. 2.—When the 10 o'clock train rolled into the Union station Tuesday morning last, it brought to this city a delegation of thirty-nine French artisans, sent to the United States by the French government to visit the World's Fair and to inspect American manufactories, etc., in some of the great industrial centers. The delegation has visited the World's Fair, New York, Philadelphia, Pittsburgh, Chicago and Boston, and last week the members enjoyed the hospitalities of the citizens of Providence and Rhode Island.

The delegation comprises fifty-two persons. Among them are: M. Heller, engraver and chaser; M. Autogue, ceramist; M. Coeurdevey, watchmaker; M. Brecy, jeweler; M. Chiquet, painter on china; M. Jacquemin, watchmaker; M. Morage, watchmaker; M. Mulard, jeweler; M. Rose, chaser; M. Pillet, ceramist, and M. Vauthier, jeweler. The invitation of the Gorham Mfg. Co. to inspect their factory at Elmwood was accepted and nearly four hours were spent in the largest silversmithing establishment in the world.

The visitors were received in the directors' room which was decorated with American and French flags, and in the midst of the drapery was a bust of "Joannis Jacob Alier—1608-1657," the founder of a Jesuit institution in Montreal. The foremen of the departments were summoned by an electric signal, and the strangers were escorted through the buildings in parties of three or four by the officers and others representing the company.

The chasing department was among the most interesting of the many visited. Some of the chasers were engaged in ornamenting bowls with hammers and other tools; others were raising the surfaces by striking the snarling irons, which transmitted the vibrations to the points set at right angles to the part receiving the blow, the outside blows upon the iron being converted to blows upon the interior of the bowls, and making the desired relief.

The machinery which enables the company to manufacture spoons, forks, etc., by thousands of dozens was fully explained; the process of cutting dies which do in a second what the chaser cannot do in hours, was particularly interesting; and considerable attention was given to the powerful rolls for pressing the bars of silver into sheets preparatory to cutting them into blanks for articles of tableware. The presses for changing flat discs of silver into cups or bowls by the descent of heavy plungers into dies and the drop stamps which print the patterns of the dies upon the metal were spoken of as wonderful machines.

Exhibits of cut glass ornamented with silver, silver frames with the glass body blown in, and silver mounted Rookwood ware, were examined with much interest. Among the other departments visited were the polishing rooms, the photograph gal-

**MORE DURABLE THAN IMPORTED,  
CHEAPER THAN IMPORTED,  
SUPERIOR TO IMPORTED.**

**FOX TAIL CHAINS**  
MADE BY  
**BLANCARD & CO.,**  
45 & 47 JOHN STREET, N. Y.

We keep a full Stock in 14 and 10 kt. Gold also in Silver. We make to order in 18 kt. Gold, Platinum, Aluminum Composition or German Silver.

**Hair Pin and Eye Glass Chain  
COMBINED.**



This illustrates the Hair Pin and Eye Glass Chain Combined. It is one of the most dressy as well as the most comfortable ways of securing the Eye Glass ever put on the market, and it is justly becoming very popular.

**S. F. MERRITT, Manufacturer,**

N. Y. Office, 194 Broadway.

SPRINGFIELD, MASS.

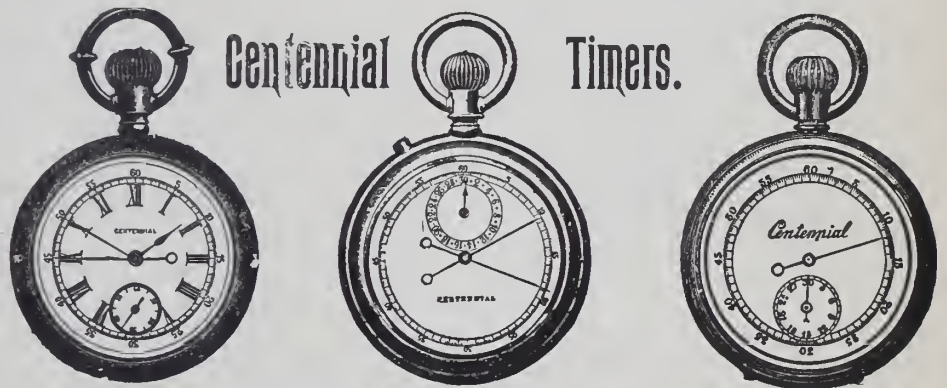

These Watches are one-third larger than above cuts.

**CROSS & BEGUELIN,**  
Manufacturers, Importers and Jobbers of  
**Watches, Diamonds, Jewelry, Watch Materials, etc.,**  
17 MAIDEN LANE, NEW YORK.

**S. C. JACKSON,** 180 BROADWAY, NEW YORK.  
MANUFACTURER OF

Fine \* Cases \* for \* Jewelry, \* Silverware, \* Etc.

ALSO SHOW CASE TRAYS AND FANCY HARD WOOD WORK.

Samples sent on application. Estimates furnished.

**Aikin Lambert Jewelry Co**  
 Importers of  
**Diamonds**  
 Jobbers in **WATCHES,**  
 Jewelry, Chains etc.  
 19 Maiden Lane.  
*New York*  
 SAM'L B. MANN, Treas.  
 FRED. D. ILGEN, Sec'y.

JAMES C. AIKIN, Pres.  
 JOHN B. SHEA, V. Pres.

**C. SYDNEY SMITH,**

HAS REMOVED TO 191 BROADWAY,  
 New York.

FACTORY:  
 PROVIDENCE, R. I.

Manufacturer of { **GOLD CHAINS,  
 LOCKETS AND CHARMS.**



**The Warren**  
**Eye Protector**

(Patented Jan. 12, 1892, Feb. 21, 1893.)

Saves the Eyes From  
**Dust, Wind, or Glaring Light.**

Folds in a Compact Case, is  
**Comfortable, Durable,  
 Water and Dust Proof.**

Its large field does not obstruct the sight. No brittle substance to endanger face under sudden blows.

Oculists and Physicians Recommend it.

Travelers, Cyclists, Railroadmen,  
 Horsemen, Motormen, Quarrymen,  
 Pronounce it Indispensable for Man or Woman.

Ask your Dealer for it.

Colors, Clear, Smoke, Blue or Green. Black frames, 50c. Silver, 75c. Sent by mail on receipt of price. Manufactured solely by

**The Nous Verrons Company**  
 P. O. Box 3273, Boston, Mass.

lery, the bronze and silver foundries, the ecclesiastical branch, the plating rooms, the case departments, the mounting room, the bullion building and the melting furnaces. All joined in pronouncing the Gorham works marvelous and the products unexcelled in variety, beauty and richness. On returning to the office each was given, as a souvenir, an Isabella sterling silver ring, which, when the World's Fair closes, will be in the hands of about 100,000 people.

The extensive manufactories of the Ladd Watch Case Co., Joseph H. Fanning & Co. and Charles Sydney Smith were inspected before the visitors left the city.

**Maiden Lane will Retain its Noisy Granite Pavement.**

The petition sent by the property owners and tenants of Maiden Lane, New York, to commissioner of public works, Michael L. Daly asking that Maiden Lane be included in the streets to be paved with asphalt, has evidently failed to have produced the desired effect. The following letter received last week by William Barthman, whose name happened to be first on the list of signers, will explain itself:

DEPARTMENT OF PUBLIC WORKS.

COMMISSIONER'S OFFICE,  
 31 Chambers St.

NEW YORK, Oct. 3, 1893.

WILLIAM BARTHMAN, Esq.,  
 1 Maiden Lane.

Dear Sir:—In answer to the petition, signed by yourself and others, for an asphalt pavement on Maiden Lane, I beg to say I have report from the Consulting Engineer on Pavements that Maiden Lane has just been paved with granite blocks, and that the heavy traffic on Maiden Lane renders an asphalt pavement impracticable. I concur in this report.

Yours respectfully,

(Signed) MAURICE F. HOIAHAN,  
 Deputy Commissioner of Public Works.

**J. H. DEDERICK, JR.,**

— DEALER IN —

**Roll Plate Jewelry and Chains,**

Optical Goods and Jewelers' Supplies,

**16 MAIDEN LANE, NEW YORK.**

JET GOODS A SPECIALTY.

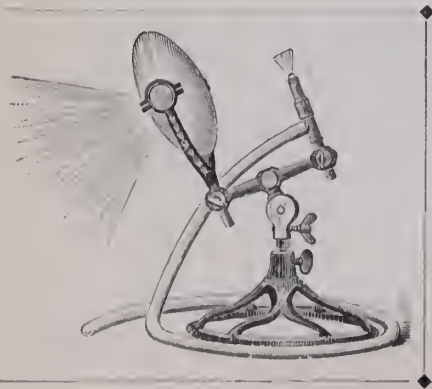

**F. W. GESSWEIN,**

39 JOHN STREET,

NEW YORK.

**ENGRAVERS' REFLECTORS**

FOR OIL OR GAS, SINGLE OR DOUBLE.

The Glass Reflecting Globe magnifies and concentrates the light, and can be adjusted to cast it on any desired point.

..... Circulars and Price Lists on Application .....

THE

# “CROMWELL”

PATENTED SEPT. 12TH, 1893.



FRONT.

BACK.

W. B. DURGIN, Concord, N. H.



HENRY C. HASKELL,



11 JOHN STREET,



NEW YORK.



Gold or Silver.

Samples sent on approval.  
"PREPAID."



**"Old English"**

Coffee Spoon.



NEWBURYPORT: No. 214 Merrimack St. CHICAGO: Nos. 149 & 151 State St.

YOU CAN MAKE MONEY By Putting in a Handsome Assortment of

**FINE POCKET CUTLERY.**

We are agents for the SOUTHINGTON CUTLERY CO.'S Celebrated RAZORS and POCKET KNIVES.  
SEND FOR AN ASSORTMENT.

H. B. BEACH & CO., - 418 Washington St., Boston, Mass.

**Larier, Eleox & Co.**

Manufacturers of Fine Gold Jewelry  
21 & 23 Maiden Lane, New York.



WE ARE READY FOR THE FALL TRADE.

**Rings, Seals, Spring Back Studs.**

GENTLEMEN'S WHITE ONYX BUTTONS AND STUDS.

**Henry Goll & Co.,  
WATCH CASE MAKERS  
AND  
REPAIRERS.**



The fact that we are constantly making New Cases to order, gives us

Facilities to do a General Line of Repairing possessed by No Other Repairing Establishment in this city. Hence we can finish all such work quickly, well and at reasonable figures.

ESTABLISHED 1837

**GEO. O. STREET & SONS,**  
MAKERS OF  
Fine Rings, Lockets, Seals,  
Sleeve Buttons and Links,  
15 John Street, NEW YORK.



Elk, Shrine and Masonic Emblems a Specialty.

Badges of Every Known Order.  
G. A. SCHLECHTER.

Manufacturing Jeweler,

READING, PA

**R.W. TIRRELL.**  
THE  
JEWELERS AUCTIONEER.  
114 PEMBROKE ST.  
BOSTON, MASS.  
MY METHODS ARE  
SUCCESSFUL.  
REFERENCES NUMEROUS.  
TERMS REASONABLE.  
ALL CORRESPONDENCE CONFIDENTIAL.

**MATHEY BROS., MATHEZ & CO.**

21 & 23 MAIDEN LANE, N. Y., and BRASSUS, SWITZERLAND.

MANUFACTURERS AND IMPORTERS OF

Plain and Non-Magnetic Movements.

Complicated Watches a Specialty.

A FULL LINE OF 10 and 16 SIZE

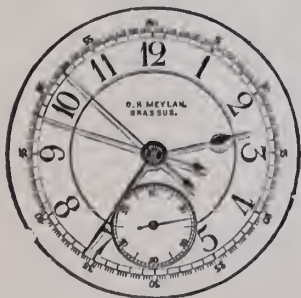

SIZE 10.

**SPLITS**



10 SIZE

### Meeting of the Creditors of H. C. Whittier & Son.

In response to the notices sent out by Robert W. Burbank, assignee of H. C. Whittier & Son, Providence, R. I., twenty of the New York creditors, representing about 70 per cent. of the firm's indebtedness, met in the rooms of the New York Jewelers' Association, New York, Wednesday afternoon. Wm. L. Sexton was made chairman, and P. T. Tunnison secretary of the meeting.

The statement submitted by Mr. Burbank showed the following assets: merchandise taken at cost, \$31,534.13; tools and fixtures, \$4,000; and bills receivable and collectable, \$5,860, making a total of \$41,394. The liabilities which amounted to \$49,760 consist of bills payable, \$39,807, and open accounts due amounting to \$9,953. "The stock," said the assignee, "was clean and desirable, and it would be suicidal" he claimed "to sell it at auction, as under the present conditions of trade, it would probably realize no more than 25 per cent. of its value." He desired to further the interests of both the debtors and creditors and therefore asked the latter's consent to his continuing the business until Jan. 9, 1894, in order to reap the advantages of the holiday trade. It was his intention in so doing to reduce all expenses to a minimum, and employ Messrs. Whittier & Son to conduct the business. He said that in doing this he expected help from the creditors in supplying goods on memorandum which would be paid for as soon as sold and accounting made of the profit.

The assignee believed that by Jan. 9th the firm might be able, by the help of friends, to pay 100 cents or make a satisfactory offer. Concluding he informed the creditors that under the laws of Rhode Island he could dispose of the property assigned to him according to his discretion, but preferred to meet the creditors and get their consent to his proposition.

Ludwig Nissen, speaking for his firm and E. Aug. Neresheimer & Co., two of the largest creditors, heartily favored the proposition, which when put to a vote was accepted by all the creditors present. Mr. Burbank thanked the creditors and the meeting then adjourned. Among the firms represented at the meeting were: Ludwig Nissen & Co., Strobel & Crane, F. H. La Pierre, Corey & Osmun, Chas. F. Wood & Co., Chas. Leo. Abry, Durand & Co., E. Karelson, Meriden Cutlery Co., B. H. Davis & Co., Ketcham & McDougall, E. Aug. Neresheimer & Co., Jeannot & Shiebler, Bippart & Co., Meriden Britannia Co., R. Wallace & Sons Mfg. Co., Derby Silver Co. and Chas. L. Uhry & Co.

Mrs. D. Ashby, Colorado Springs, Col., died suddenly on her way home from church about noon last Sunday. She lived but a few moments after the attack. The disease was either apoplexy or heart trouble, it is not yet known which.

### Annual Meeting of the New York Jewelers' Association.

At the annual meeting of the New York Jewelers' Association held in the rooms of the association, 246 Broadway, New York,



JOSEPH B. BOWDEN.

on the afternoon of Oct. 3d, the following officers were elected for the ensuing year: President, Joseph B. Bowden, of J. B. Bowden & Co.; vice-president, Ludwig Nissen, of Ludwig Nissen & Co.; treasurer, Henry Randel, of Randel, Baremore & Billings.

The new board of directors consists of Wm. L. Sexton, of Sexton Bros. & Washburn; Wm. A. Atwater; Henry E. Ide, of H. C. Hardy & Co.; F. H. Larter, of Larter, Elcox & Co.; Jas. P. Snow, of Snow & Westcott; Jas. E. Spencer, of the Spencer Optical Mfg. Co.; A. K. Sloan, of Carter, Sloan & Co.; John F. Saunders; Frederick Webster, of E. G. Webster & Son; A. K. Shiebler, of Jeannot & Shiebler, and J. B. Bowden, Ludwig Nissen and Henry Randel, *ex officio*.

The nominating committee is composed of O. G. Fessenden, of Hayden W. Wheeler & Co., chairman; Wm. B. Kerr, of Wm. B. Kerr & Co.; John C. Day, of Day & Clark; S. Cottle, of the S. Cottle Co.; and Horace D. Sherrill, of Sinnock & Sherrill.

Two amendments to the constitution were offered. The association decided to hold an annual dinner, but no definite date was fixed.

### Harry L. Rickey Confesses Judgment to Three Creditors.

TRENTON, N. J., Oct. 5.—Harry L. Rickey has confessed judgment to the Philadelphia Optical & Watch Co., W. Reed Williams and B. J. Cooke's Sons, of Philadelphia, Pa., to the amount of \$2,800 and Sheriff Bergen this week levied upon the stock in his store.

Mr. Rickey also had a second mortgage placed upon his property to secure the persons who had loaned him money. The store is closed and no business will be conducted until the judgments are satisfied.

# LE BOUTILLIER & Co.,

860 BROADWAY,

N. E. cor. of 17th St., - NEW YORK,

Invite an Inspection of their  
Novelties in

ROYAL WORCESTER,

WEDGWOOD,

CROWN DERBY,

COALPORT,

PÂTE SUR PÂTE,

BISQUE.

Prices are very low this season, and dealers will find many exclusive styles in our stock.

### A. D. Selover Seeks and Obtains an Extension.

A meeting of the creditors of A. D. Selover, Newark, N. J., called by his attorney, Mr. Baldwin, was held in the rooms of the New York Jewelers' Association, Thursday afternoon. The roll call showed that the creditors present representing an indebtedness of \$18,382.27, were as follows: N. H. White & Co., Maurice Weil, Hayden W. Wheeler & Co., Meriden Britannia Co., Bippart & Co., Larter, Elcox & Co., Wm. S. Hedges & Co., Ripley-Howland Mfg. Co., Hildreth Mfg. Co., Julius King Optical Co., J. T. Scott & Co., and the Bassett Jewelry Co. O. G. Fessenden, of Hayden W. Wheeler & Co., acted as chairman of the meeting. Mr. Baldwin submitted the following statement of his client's assets and liabilities:

Merchandise on hand, as per inventory, at cost, \$22,778.92; money due on accounts \$4,051.90; fixtures at a low valuation \$1,200, making the total assets, \$28,030.82. The total liabilities were \$23,046.87, leaving a nominal surplus of \$4,983.95. Owing to the present stringency, his client was forced to ask for an extension and he submitted the following proposition: 20 per cent. in twelve months, 30 per cent. in fifteen months, 20 per cent. in eighteen months, 20 per cent. in twenty-one months, and 10 per cent. in twenty-four months.

A lengthy discussion then took place among the creditors, and it was finally decided to appoint a committee of three to confer with Mr. Selover and his attorney, to decide on a more feasible proposition. The committee appointed are: J. T. Scott, of J. T. Scott & Co., Mr. Parker, of the Bassett Jewelry Co., and Mr. Mason, of N. H. White & Co. A recess was then taken while the committee, Mr. Selover and his attorney consulted.

When the meeting was called to order again, the committee reported the following proposition: That N. H. White, of N. H. White & Co., be nominated as trustee for all the creditors, the debtor and creditors agreeing that Mr. Selover pay over to the trustee each month commencing with November such moneys as he had at his command and could spare from the business, said amount to equal at least 5 per cent. every three months; that Mr. White agree to accept such moneys and pay them pro rata to the creditors. The proposition, as submitted, was unanimously accepted and Mr. Baldwin was instructed to draw up the necessary papers and submit them to Mr. White before obtaining the signatures of the creditors.

### The Stock of C. Edward Eager Bid in by his Creditors.

SYRACUSE, N. Y., Oct. 4.—At 10 o'clock yesterday morning, deputy sheriff M. G. Bennett sold the stock of jewelry, etc., of C. Edward Eager, who failed in business a week ago, as reported in THE CIRCULAR. The store on the corner of E. Genesee and

S. Salina Sts., was closed on executions issued on several confessed judgments. The inventory of the stock is said to have been about \$9,000.

Attorney C. F. Ayling, in behalf of several of the judgment creditors, bid the stock off at \$2,000. The store was opened yesterday afternoon in charge of Mr. Eager, who is to act as agent till the goods are disposed of.

### Death of James William Young.

PETERSBURG, Va., Oct. 5.—James William Young, one of the oldest jewelers in this city, died suddenly on Monday night from heart failure.

Deceased was born in Petersburg, March 31, 1839. He was married Dec. 13, 1865, to Miss Mary E. Kirkham, who survives him with five children. Mr. Young had conducted a jewelry business in Petersburg for the past thirty years and had been in the trade ever since he was twelve years of age.

When the civil war broke out Mr. Young entered the confederate army as a member of the Petersburg City Guard, Captain John P. May. After serving about twelve months in this company he was transferred to Graham's battery, in which he served gallantly throughout the war, and at the time of his death he was a member of A. P. Hill Camp Confederate Veterans. Mr. Young was a good and useful citizen and his genial manners won for him a large circle of friends and acquaintances.

### A New Clock Company Organized in Michigan.

GRAND RAPIDS, Mich., Oct. 7.—Articles of incorporation of the Dryden, Annin, Rose Clock Co. have been filed with the county clerk. The company will manufacture, buy and sell clocks, clock cases and movements, etc. Their factory is located at 194-196 Stocking St., and the plant will be run by electricity. The capital stock is placed at \$25,000 in \$10 shares.

The number of shares already subscribed is 1,875, of which E. E. Dryden, C. H. Annin and John A. Rose each own 625. The new company have already shown some samples and have received considerable encouragement and some orders.

### Must be Used to Being Robbed by This Time.

MINNEAPOLIS, Minn., Oct. 6.—It is reported from Grafton, N. Dak., that a few nights ago while Elliot Bjorneby was at supper one evening, burglars entered his jewelry store from behind, breaking in a door, and cleaned out the watches and a case of jewelry, taking almost everything in sight except the clocks. The robbery was committed at 6.30 p. m.

One suspect is in the lockup and police and citizens are out looking after the robbers. This is the third time Jeweler Bjorneby has been robbed. His store is situated in the heart of the town.

### The Annual Attleboro Agricultural Association Fair.

ATTLEBORO, Mass., Oct. 7.—The annual fair of the Attleboro Agricultural Association is a thing of the past. It opened Tuesday and closed Friday noon, and is considered by press and public to have been the most successful held during the past decade. On the first day a veteran firemen's tournament was held, and on the committee were: E. A. Sweeney, S. O. Bigney, George Randall and T. W. Draper. On the second day were seven bicycle races held under the L. A. W. rules and several records were broken. C. E. Sandland and F. W. Northup were judges; F. H. Brigham starter, and H. A. Clark, R. Blackinton and John Cummings, timers.

The third day was Knights of Pythias day, and John P. Bonnett personally entertained over two hundred members of the uniformed rank. At the regimental meeting S. M. Holman was elected major of the 3d Regiment. President Bigney and others had worked hard to make the display of jewelry one of the largest for years but they were disappointed.

Regnell, Bigney & Co. showed a large line of articles in enamel and silver and were awarded a premium. Considerable space was occupied by George D. King & Co. for their exhibit of dies and jewelers' machinery. G. A. Wales had a display of optical goods and spectacle frames. H. A. Streeter confined his space to showing society emblems and badges.

Charles P. Young, of Young & Stern, made the most extensive showing of horticultural products at the Fair and received several first premiums.

Tilden-Thurber Co., of Providence, donated a handsome silver cup of original design to be contested for by members of the Providence Riding Club, on Thursday.

E. S. Horton, of Horton, Angell & Co., was general marshal during the fair and had charge of the police arrangements.

### A Third Large Failure in Richmond, Va.

RICHMOND, Va., Oct. 5.—The H. M. Moses Co. failed yesterday. Liabilities are estimated at \$9,000, and assets are not yet known. The deed makes Sol. L. Bloomberg trustee. Dulness and depression in business and general stringency in finances are assigned as causes of the failure.

The deed declares that the company have actual assets to an amount much larger than the liabilities. The officers of the concern are Alfred Moses, president, and Harry M. Moses, secretary and treasurer. After paying in full all just and legal demands of the company's creditors, the trustee is to turn over the residue to the stockholders. Mr. Bloomberg is directed to take immediate charge of the business. After the payment of all rents, taxes, commissions of the trustee, and costs of executing this trust, including attorney's fees, the remaining creditors are to share ratably.



**A Threatening Cloud Over the Head of Edmund J. Scofield.**

Edmund J. Scofield has been retired from the managership of the New York department of the Elgin National Watch Co., under circumstances that have given rise to innumerable rumors of a sensational character. Mr. Scofield was the president of the New York Jewelers' Board of Trade and as such held a conspicuous position not only among the jewelers of New York but in the trade at large.

General Manager J. M. Cutter is now in charge of the New York office of the Elgin Co., at 11 John St. Wednesday afternoon a CIRCULAR reporter called at the company's office, and upon being informed that Mr. Scofield was no longer connected with the company interviewed Mr. Cutter and asked him the cause. Mr. Cutter, who was making an examination of the books of the office, stated at first that Mr. Scofield's retirement had not been announced, but upon being assured that the fact was generally known stated that he had nothing to say as to the reason of the retirement. Where Mr. Scofield was, or where he could be found, Mr. Cutter said he did not know. Since then he has declined to see all reporters.

The Elgin National Watch Co. from their Chicago office later officially notified all jobbers who handle their goods, that Mr. Scofield was no longer in their employ. A statement of account was also sent to each jobber asking that it be verified.

Henry Ginnel, 31 Maiden Lane, admitted to a CIRCULAR reporter that an investigation was then in progress at the New York office of the Elgin Co., and said that though irregularities had been found in the accounts, nothing of a definite nature was

known or could be known until the examination was finished.

Many of the jobbers who had received statements for verification were interviewed and nearly every one of them said that the statement submitted was not correct. Whether this was the fault of the Chicago or New York office they would or could not say. In some cases the discrepancy was exceedingly large. A CIRCULAR reporter attempted to see Mr. Scofield, but the latter could not be found either at his residence, 185 Gates Ave., Brooklyn, or in the jewelry district. It is said that when the time came to make a statement Mr. Scofield will have a full explanation to offer.

One of the largest dealers in Maiden Lane assured the writer that for some time back Mr. Scofield had been borrowing money from him and from other dealers, and that these actions on the part of a prominent representative of so rich a concern as the Elgin National Watch Co. caused some comment.

Secretary H. M. Condit, of the New York Jewelers' Board of Trade, Saturday received Mr. Scofield's resignation as president and director.

**A Receiver Appointed for the E. N. Welch Mfg. Co.**

HARTFORD, Conn., Oct. 6.—In the Superior Court to-day a receiver was appointed for the E. N. Welch Mfg. Co., of Bristol, with salesrooms in New York, Chicago, London, Glasgow, Shanghai and Yokohama. E. A. Freeman, of Bristol, was temporarily appointed receiver, on petition of the Bristol Brass & Clock Co., a creditor for about \$50,000. A hearing of his confirmation will be held in Hartford on the 13th inst.

The liabilities are stated at \$400,000, and

the assets are estimated at \$600,000, including the great manufacturing plant in Forestville. The business has not been satisfactory for two or three years, and for several weeks the factory had been substantially shut down. The company have been a heavy borrower, and the financial troubles and business depression recently, have made the situation steadily worse for the concern until an assignment was inevitable to prevent sacrifice of the property under attachments and forced sales. New Haven, Hartford and Bristol banks are the heaviest creditors, but are already secured by collaterals. There is also \$50,000 due the Bristol Brass & Clock Co., and about \$15,000 in small amounts, some in New York and Boston.

The business was established by the late State Senator E. N. Welch, and on his death, in 1887, the half million of its stock went to his son, president J. Hart Welch, and other relatives. There is very little stock outside the family.

Wm. H. Atwater, 13 Maiden Lane, the New York agent of the E. N. Welch Mfg. Co., told a CIRCULAR reporter, that the receivership is the result of a friendly suit instituted by the Bristol Brass & Clock Co. owned by the Welch interests, for the purpose of adjusting certain differences between the stockholders of the company, all of whom are heirs of the late E. N. Welch. E. A. Freeman, the receiver, has been for many years the book-keeper, cashier and confidential clerk of the E. N. Welch Mfg. Co. Arrangements are now being made, he said, for starting up the works promptly. The company have a well assorted stock on hand and are able to fill all orders.



**Gold Cases.**

**ROY**



**Only Award  
At World's Fair.  
A Proud Title Won.**

**"The Best."**



**Photo=Miniature.**

# Bouguereau's Great Masterpieces in Silver.

NYMPHS AND SATYR.



MATCH BOX



COURT PLASTER.

PSYCHE AND LOVE.



MATCH BOX.

THE highest art has been attained in modeling the subjects of those great paintings in *bas relief* on Silver and Gold. The success we have made, has elicited the highest expressions of approval from the famous painter **Bouguereau**, the recognized leader of the nude school, as may be seen in the following letter.

PARIS, 22 Juni, 1893.

WM. B. KERR &amp; Co.,

MESSIEURS: Je viens vous remercier des deux boites en argent que vous avez bien voulu m'offrir.

J'ai pu constater par les bas reliefs, qui les ornent et qui sont faite d'après deux de mes tableaux "Nymphes et Satyre" et "Psyché et l'Amour," tous le soin que vous apportez à l'exécution de vos travaux ainsi que la recherche artistique que vous y mettez.

Je ne puis que vous encourager, Messieurs, à poursuivre dans cette voie me permettant cependant de vous faire observer qu'a mon avis vous devez, avant de faire exécuter des œuvres d'art, obtenir la permission de l'Auteur.

Veillez agréer, Messieurs, l'expression de mes sentiments très distingués.

PARIS, June 22, 1893.

WM. B. KERR &amp; Co.,

GENTLEMEN: I desire to thank you for the two silver boxes, which you have so kindly presented me with.

From the *bas reliefs* which ornament them, and which are reproductions of my two paintings "Satyr and Nymphs" and "Psyche and Love," I can certify with pleasure the great care shown in the execution of the work of reproduction, also the highest artistic sentiment.

I desire to encourage you gentlemen in pursuing such a path, allowing me to suggest that in so doing, that permission be obtained from the authors.

Kindly accept gentlemen the expression of my most sincere consideration.

## WILLIAM B. KERR & CO.,

Manufacturers of ARTISTIC JEWELRY IN GOLD AND SILVER,

FACTORY:  
NEWARK, N. J.

860 BROADWAY, N. Y.

# The Jewelers' Circular

AND  
HOROLOGICAL REVIEW.

PUBLISHED EVERY WEDNESDAY BY

THE JEWELERS' CIRCULAR PUB'G CO.,

189 BROADWAY, NEW YORK CITY.

A JOURNAL DEVOTED TO THE INTERESTS OF JEWELERS, WATCHMAKERS, SILVERSMITHS, ELECTRO-PLATE MANUFACTURERS, AND ALL ENGAGED IN KINDRED BRANCHES OF INDUSTRY.

Our Editorial columns will contain our own opinions only, and we shall present in other columns only what we consider of interest or value to our readers. Advertising matter will not be printed as news.

Advertising rates in THE CIRCULAR are lower, considering the number of tradesmen reached by its large circulation, than in any other jewelry journal.

Notices of changes in standing advertisements must be received one week in advance; new matter can be received up to Monday.

## INFORMATION FOR SUBSCRIBERS.

### Terms of Subscription, Postage Prepaid.

	PER ANNUM
United States and Canada, - - -	\$2.00
Foreign Countries in Postal Union, - - -	4.00
Single Copies, - - - - -	.10

New subscribers can commence at any time.

Payments for THE CIRCULAR, when sent by mail, should be made in a Post-Office Money Order, Bank Check or Draft, or an Express Money Order or Registered Letter. All postmasters are required to register letters whenever requested to do so.

Pay money only to authorized collectors having proper credentials.

Returning your paper will not enable us to discontinue it, as we cannot find your name on our books unless your address is given.

In changing address always give the old as well as new one. Your name cannot be found on our books unless this is done.

We will continue to send papers until there is a specific order to stop, in connection with which all arrearages must be paid; but such an order can be given at any time, to take effect at the expiration of the subscription. All such orders will be promptly acknowledged by mail.

The Courts have decided that all subscribers to journals are responsible until arrearages are paid in full and an order to discontinue has been received by the publisher.

Member of the American Trade Press Association.

VOL. XXVII. Oct. 11, 1893, No. 11.

## WINDOW DESIGN CONTEST, NO. 2.

A Prize of \$10.00 is offered by THE JEWELERS' CIRCULAR for the best design for dressing a jeweler's window. The contest is open to all members of the trade, to the clerks, salesmen and others, as well as to the dealers. Following are the conditions:

1. The design is to be submitted as a pencil or other sketch or photograph, from which a finished engraving may be made. The design may be an original conception or a copy of a window already dressed.
2. A brief description is to accompany the design.
3. The design must be appropriate for the Fall and holiday season.
4. Designs for Contest No. 2 must reach us no later than Nov. 1.

AMERICAN manufacturers are pushing the French manufacturers pretty hard for first place in furnishing clocks to the United Kingdom. During the first seven months of 1893, the imports of American clocks equaled \$238,000, while the imports of French clocks amounted to \$379,000, a decrease of \$22,000 for the latter, and an increase of \$14,000 for the former as compared with 1892. The imports from all the other countries are lumped.

IT is an assertion not open to question that foreign governments as France and Germany adopt more effective means to foster home industries than our own United States. The delegation of fifty-two expert artisans sent by France to this country to visit the World's Columbian Exposition and to inspect American manufactories will take away with them more valuable ideas than they can possibly leave behind. However, jewelers, silversmiths and watch manufacturers may open wide their factory doors to this body and treat them with all due hospitality, without fear of spreading their ideas to their own disadvantage; they are beyond foreign competition.

### Novelties For Holiday Trade.

THE New York *Herald* in its apparent policy to keep the public in a constant ferment and uneasiness of mind, hath it that manufacturing jewelers are not producing any novelties this year. THE CIRCULAR strenuously refutes this assertion, and asks the retail jeweler to accept the evidence of his own eyes, in inspecting the lines shown by travelers on the road or in the offices of the manufacturers. The stocks produced for the Fall and holiday trade are fruitful of novelties, fertility and ingeniousness of design in the line of jewelry, perhaps never before having been more in evidence.

### A Liberal Education Easily Obtained.

A FEW weeks hence and the World's Columbian Exposition will be a thing of the past. The exposition is all it purports to be, for the whole world has contributed its best in science, art and manufactures. Those who fail to see the Fair will have just cause to regret their neglect, for never before has there been an exposition so grand in conception, so complete and comprehensive in detail and so magnificent in execution. Especially valuable to artist-artisans, as jewelers, silversmiths and watchmakers, will prove a visit to the World's Fair, howsoever brief, for the exhibits of jewelry, silverware, watches, clocks, optical instruments and kindred lines are of surpassing interest, a careful examination of them comprising a liberal education in the field of mechanical and artistic production of which they form a part. If the visitor finds his time too limited to inspect both the American and foreign displays, let him at least view the former, which are of the highest order of merit and regarding

which the October *Art Journal*, of London, in an interesting review of art metal work at the Fair, has the following to say: "The United States, which, in the furniture section, is very limited in the number of her artistic exhibits, has here a superb display, easily distancing, in some departments of art metal-work, any other nation. Her silversmiths' and goldsmiths' work is astonishingly good. Judging by the productions exhibited, one may well be in doubt whether, our much boasted European pre-eminence in these things is to last much longer and whether after all, we shall not in the near future be compelled to regard the firms of New York as at least our equals, if not our superiors, in the production of high-class gold and silver work."

## The Week in Brief.

EDMUND J. SCOFIELD was suspended from the position of New York manager of the Elgin National Watch Co., and sensational developments are expected—The annual meeting of the New York Jeweler Association was held and Joseph B. Bowden was elected president—A meeting of the creditors of H. C. Whittier & Son Providence, R. I., was held in New York—The death occurred of Mrs. D. Ashby, Colorado Springs, Col.—Harry L. Rickey, Trenton, N. J., confessed judgments—The death of B. F. Wiggin, a former prominent jeweler of New Orleans, La., was reported—The monthly statement of imports and exports was issued by the Treasury Department—The petition of New York jewelers to have Maiden Lane paved with asphalt failed to achieve its object—The creditors of A. D. Selover, Newark, N. J., held a meeting in New York—The stock of E. Edward Eager, Syracuse, N. Y., was sold by the sheriff—The death occurred of James William Young, Petersburg, Va.—The Dryden, Annin, Rose Clock Co., of Grand Rapids, Mich., incorporated—The jewelers of Attleboro, Mass., took part in the fair of the Attleboro Agricultural Association.—A receiver was appointed for the business of S. Kaufman, Atlanta and Savannah, Ga.—H. M. Moses Co., Richmond, Va., failed—Joseph Monzie, a jewelry peddler, was murdered near Mount Vernon, Ky.—The stock of C. A. Mabie, Holley, N. Y., was sold out by the sheriff—John Simonton, a jeweler of Washington, N. J., committed suicide—The Nielson Jewelry Co., Logan, Utah, assigned—World's Fair awards were officially announced in the groups including jewelry, precious stones, watchmakers', jewelers' and optical machinery and tools, lamps, pocket cutlery, etc.—Chicago jewelers observed Chicago Day at the World's Fair—Frank Armstrong, a former jeweler of Bridgeport, Conn., died—The optical goods business of H. M. Ruddy, Omaha, Neb., was burned out—A gang of jewelry thieves was captured near Montreal, Can.

### New York Notes.

E. W. Laurençot sailed for Europe Oct. 4th on the *Noordland*.

C. W. Little & Co. have removed from 42 Franklin St., to 32 Cortlandt St.

Albert Lorsch and family arrived from Europe Sunday on *La Gascogne*.

L. Mann & Co. have entered a judgment for \$409.02 against Jos. D. Lynch.

The Foster Keeping Co. have given a chattel mortgage to S. F. Myers & Co. for \$2,166.

The Gorham Mfg. Co. have obtained a judgment for \$1,029.25 against Richard De Logerot.

The judgment for \$1,003.42 entered July 28 by Wm. R. Alling against E. E. Kipling was satisfied Oct. 6th.

Deputy Sheriff Finn last week sold out the stock of Rudolph Deutch, 72 Ave. B. The amount realized was \$311.

H. G. Ellis, of Toronto, Canada, stopped for a few days in New York, last week, on his return from the World's Fair.

Judgments were last week entered against Edward Flatow by Louis Gordon for \$3,158.38 and by Hattie Flatow for \$1,717.75.

Sternscher & Flato, manufacturing jewelers, 75 Nassau St., have dissolved partnership. Mr. Sternscher continues at the same address.

Emil Fox, manufacturer of silver goods, 133 Crosby St., has given a bill of sale to R. J. Bernhardt, for \$1,000. His place is closed and to rent.

Frank Mauser, formerly superintendent of the Mauser Mfg. Co., resigned from that position Thursday and severed his connection with the company.

Eugene and Jennie Leroux were indicted for smuggling jewelry by the United States Grand Jury, sitting in Brooklyn last week. Their trial will take place Oct. 25th.

Frank De Mar, who was killed by a Pennsylvania R. R. passenger train Sept. 29th, is reported to have been a silversmith, who was at the time seeking employment.

Henry Dreyfus & Co. have entered a judgment for \$3,531.50 against Charles Seale & Co. J. Wertheimer has entered a judgment against the same firm for \$3,194.50.

Siegfried Strass, of Backes & Strauss, Limited, London, Eng., returned from Chicago last week and spent a few days with friends in New York. He left for England Saturday on the *Saale*.

A warrant was issued last week for the arrest of a Mrs. Sire who is charged with disposing of diamond earrings which she had not paid for. The complainant, L. Spero, is said to be a jeweler at 247 East Broadway.

The annual meeting of the stockholders of the Prentiss Calendar & Time Co. has been called by Geo. E. Fahys, secretary, for Thursday, Oct. 19th, at 3 p. m., in the office of Jos. Fahys & Co., 41 Maiden Lane. Trustees for the ensuing year will be elected.

The action in the New York Supreme Court brought by Mary C. Steinhäuser against L. Tannenbaum and Jas. McCormick, the sureties on an undertaking upon an appeal of John Mason, has been placed on the calendar for the trial of short causes for Oct. 13th.

The suits brought by A. Pinover and Durlach Bros. against Morris Ginsburg were tried at a Special Term of the Superior Court before Judge Gildersleeve, Wednesday. Decision was reserved. Ginsburg's assignment was recently set aside on the ground of fraud, and these suits are brought by judgment creditors to allow them to share in the benefit accruing therefrom.

Lewis Heller, a jeweler of Dorrance, Pa., was asphyxiated in a room in the International Hotel, on Park Row, last Wednesday. It is supposed that he blew out the gas. Heller was visiting New York for the first time. Wednesday a chambermaid employed at the hotel detected an odor of gas coming from Heller's room and gave the alarm. The door was broken open and the jeweler was found on the bed, a corpse. The body was taken to the Morgue and his friends notified.

The following judgments against Edw. F. Sanford and Wm. T. Coombs were recorded satisfied Friday: By Carter, Sloan & Co., for \$548.58, entered July 6th; L. & M. Kahn & Co., for \$8,581.61, entered June 27th; H. Vietor, for \$2,264.87, entered Aug. 8th; E. Aug. Neresheimer & Co., for \$38,605.86, entered June 27th; M. Weil, for \$3,647.15 entered June 27th; H. C. Hardy & Co., for \$3,900.87, entered June 27th; C. F. Wood & Co., for \$12,078.72, entered June 27th; J. A. Brown, for \$1,081.17, entered Aug. 1st; H. Levey, \$1,000.76, entered July 5th, and by W. R. Alling & for \$1,003.42, entered July 28th.

The appeal of Wm. A. Clevenger from the judgment entered last June upon a verdict of the jury in favor of Lewisohn & Co., was argued at the General Term of the Supreme Court, Oct. 3d. Lewisohn & Co. sued Clevenger to recover the value of diamonds said to have been stolen from the plaintiff by young Duncan, a former employe and sold by the thief to Clevenger. The plaintiffs were given judgment for about \$2,100, and this judgment was appealed from. The appeal was argued and submitted and decision reserved.

Bowling clubs have been formed by representatives of the following well-known firms of Maiden Lane: Hayden W. Wheeler & Co., Aikin, Lambert & Co., J. T. Scott & Co., Keystone Watch Case Co., Jos. Fahys & Co. and N. H. White & Co. The clubs are composed of four members from each firm. The clubs form an association of which John L. Shepherd, of the Keystone Watch Case Co., is president, and R. B. Stors, of Hayden W. Wheeler & Co., is treasurer. The first games of the series took place yesterday at the Tremont Hotel. The contestants were: Aikin, Lambert &

Co., Hayden W. Wheeler & Co. and Jos. Fahys & Co.

Louis Borneman, 91 John St., in a letter taking exception to an item published last week, stating that a judgment for \$199 against him had been entered by D. L. Van Moppes, says: "The original amount was a balance of \$32 which I owed him and not \$199, and this judgment was obtained in my absence while out of town, but was satisfied the very earliest possible moment of the following day, which was last Saturday." The records at the County Clerk's office show the entry Sept. 29 of a judgment for \$199.16 against Louis Borneman, in favor of David Van Moppes. There is no record of any satisfaction of this judgment.

A meeting of manufacturers of watch movements and cases was held in the office of Jas. H. Noyes, in the Corbin building on Tuesday, Oct. 3d. The object of the meeting was to make arrangements by which the manufacturers would take concerted action in regard to failures. A committee, consisting of Henry Hayes, of the Brooklyn Watch Case Co.; David Untermeyer, of Keller & Untermeyer Mfg. Co.; W. C. Roberts, of the New York Standard Watch Co. and J. C. Lowry, of the Keystone Watch Case Co. were appointed to draft the necessary resolutions. The committee reported at a meeting held yesterday after THE CIRCULAR had gone to press.

The fashionable multitudes of upper Broadway are being treated to a view of an exhibit of silverware unprecedented in extent, richness and artistic qualities. In the four spacious windows of the Whiting Mfg. Co., 18th St. and Broadway, are tastefully arranged two hundred gorgeous silver trophies, each piece being entirely different in design from the others and disclosing individual points of excellence in conception and execution. The exhibit was suggested by the occurrence of the International Yacht races, and the trophies consist of loving cups, bowls, etc., won by the swiftest yachts of the New York, Larchmont and other great yacht clubs. Crowds are constantly gathered about the windows and the exhibit excites the sense of the marvelous in the minds of the on-lookers.

On the first day of the series of races between *Vigilant* and *Valkyrie*, Thursday, Oct. 5, the steamer *Gay Head*, chartered by the Atlantic Yacht Club, of Brooklyn, carried among its jolly passengers a goodly representation from the jewelry trade, including A. M. Crommelin and wife, Irving Smith and wife, E. R. Crippen, of Bates & Bacon, and wife, John B. Yates, F. R. Simons, of Henry Ginnel, John C. Mount, of Randel, Baremore & Billings, Jacob Bunn, Jr., of Illinois Watch Co., Eugene Unger, of Unger Bros., and Mr. King, of N. H. White & Co. Other enthusiasts who viewed the race were Thos. K. Benton and Geo. Courvoisier, of the Courvoisier-Wilcox Mfg. Co., Mr. Cadmus, of Chas. F. Wood & Co., Geo. C. White, of Rogers & Bro., who was on the *Olivette*, and Will A. Bryant, of M. B. Bryant & Co.



L. CARAFE, 455 | 53. COLUMBUS.

# Richest CUT GLASS

FROM OUR OWN WORKS IN THIS CITY.

None but the Highest Grade in Quality and Workmanship.

**LARGEST ASSORTMENT.**

**MOST MODERATE PRICES.**

A LARGE variety of new and strikingly original shapes and many new cuttings, protected by U. S. Patents.

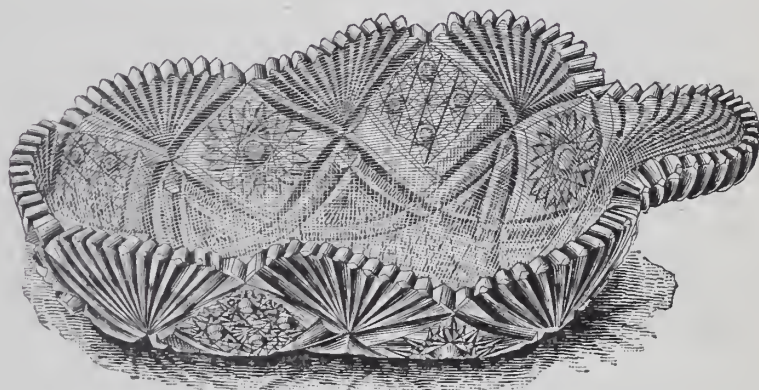

SALAD, 434 | 55. LA RABIDA.

## L. STRAUS & SONS,

MANUFACTURERS,

42, 44, 46 AND 48 WARREN ST.,

AND 116 CHAMBERS ST.,

NEW YORK.



PITCHER, 453 | 58. BRAZILIAN.

See our Exhibit at the World's Fair. in Section H  
of the Manufactures Building.

R. A. Breidenbach has entered a judgment for \$366 against Solomon Hansen.

The following judgments were entered Saturday against Elias Pilzer: by Alois Kohn & Co., for \$1,049.25, and by the State Bank for \$1,189.15.

The appeal from the order of Judge Freedman denying the motion of Allan C. Dalzell for permission to inspect the books of Jos. Fahys & Co., was argued at the General Term of the Superior Court, before Judges McAdam and Gildersleeve, Saturday morning. Briefs were submitted and decision reserved.

### Boston.

A. W. Anthoine recently located in the jewelry business at 821 Washington St. Mr. Anthoine is an experienced watchmaker and jeweler.

The wedding of Joseph G. O'Hara, assistant superintendent in the Waltham Dial Co.'s factory, to Miss Gertrude Hicks will occur this month.

Beginning last Wednesday, the United States Watch Co.'s factory, Waltham, will run on three-quarters time until further notice. This step is taken rather than discharge any of the help.

J. G. Boutelle, jeweler, of Pepperel, who will settle in insolvency, owes \$12,053, which includes \$1,500 secured; assets, real estate mortgage for \$1,000, and stock of jewelry and bicycles and fixtures.

A rumor current last week in New York to the effect that the E. Howard Watch & Clock Co. had sold out to the Ansonia Clock Co. is absolutely denied by President Little of the Howard Co. He told your correspondent that he knew nothing whatsoever concerning the rumor.

J. L. Chase, of Malden, died at the City Hospital, Boston, last Thursday evening, from blood poisoning. He was thirty years of age and unmarried. As a result of

an accident on the ice he was lame in one leg, and by excessive bicycle riding it is claimed the bones of the knee became dry and began to decay. He was advised to have his leg amputated a month ago. The operation was performed; but it was too late, as blood poisoning had already set in. Deceased was a jeweler.

### The Affairs of the Silversmiths' Company.

The report that the Silversmiths' Company incorporated early this year would never come into actual existence has been officially denied. An investigation, however, showed that at present the affairs of the company are in *statu quo*. No stock has yet been issued and the five companies, the Gorham Mfg. Co., Whiting Mfg. Co., Dominick & Haff, Geo. W. Shiebler Co., and Towle Mfg. Co., which were to be embodied in and form the company have as yet taken no steps in that direction.

Edward Holbrook, of the Gorham Mfg. Co., told a CIRCULAR reporter that the only proper statement that could be made was that the companies composing the Silversmiths' Company have decided to take no action for the present toward consummating the original arrangement. The understanding at the formation was that the companies were to join at a future time not definitely stated. The decision to take no definite action at present, therefore, could in no way be construed as an abandonment of, the original plan. Every step so far taken has been mutual and unanimous.

### The Liabilities of C. S. Hook Co.

MEMPHIS, Tenn., Oct. 4.—The assignment of C. S. Hook Co., announced in last week's CIRCULAR is general and covers the entire stock of goods, all accounts and the fixtures of the company, and no creditors are preferred; but it is expressly stipulated that all debts be paid ratably. M. H. Katzenberger is assignee. The principal creditors are

Otto Young & Co., \$240; T. B. Clark & Co., \$132.57; Hartford Silver Plate Co., \$120; Goodman Bros., \$313; L. & J. Adler & Co., \$660; C. H. Knights & Co., \$100.11; The Weber Co., \$188.25; Wendell Mfg. Co., \$161.36; Henry Cowan, \$530.35; L. Black & Co., \$145.25; E. A. Cowan & Co., \$302; Adolph Goldsmith & Son, \$577.38; Roseman & Levy, \$217.34; H. H. Curtis & Co., \$109.49; Osborn & Co., \$116.66; Josephine Bergman, \$520. The total scheduled liabilities foot up \$6,695.35.

### Newark.

Richard Luddy, a watchmaker of 163 Bergen St., was arraigned in the Third Criminal Court on Thursday charged by Michael Gyn with having sold a watch left with him for repair.

Henry A. Badestein, a pedler of spectacles and eye glasses from New York, was knocked down and robbed of all his stock consisting of about \$25 worth of gold rimmed spectacles and \$8.70 in cash, while on his way from South Orange to Newark, on Friday evening.

"Isn't one man as good as another?" asked an orator in the course of a stump speech, and a voice in the crowd replied, "Yes, and a blamed sight better!" Now, it is a good deal the same with the Big Four Route to Chicago. Why? In the first place the train service, equipment and roadbed are unexcelled by any railroad in the country; in the second place, the sleeping cars, parlor cars and day coaches are the finest specimens of the car builder's art; in the third place, all trains of the Big Four Route enter Chicago along the Lake Front, stopping at Midway Plaisance, the Main Entrance to the World's Fair grounds, 60th St., Hyde Park, 39th St., 22d St., 12th St., and land passengers and baggage convenient to all the World's Fair hotels and boarding houses, as well as the down-town hostleries. All ticket agents throughout the country are supplied with Big Four tickets.

# ALBERT LORSCH & COMPANY,

167 Broad Street,  
PROVIDENCE, R. I.

37 Maiden Lane,  
NEW YORK.

IMPORTERS : OF : DIAMONDS,

PRECIOUS STONES, IMITATION STONES, NOVELTIES.

SOLE OWNERS AND IMPORTERS OF *The Sumatra Gem.*  
REG'D.

HIGHEST AWARD AT WORLD'S COLUMBIAN EXPOSITION,

CHICAGO, 1893.

# OTTO YOUNG & CO.

WHOLESALE ONLY.

Diamonds, Watches, Jewelry, Silverware, Tools and Material,

◁ OPTICAL GOODS, ETC. ▷

149, 151 & 153 STATE ST., CHICAGO, ILL.

WE will soon issue our new Illustrated Catalogue. It will be sent by Express or mail, prepaid, to all legitimate Jewelers, in territory tributary to Chicago. It will contain a full line of all staples and novelties required by Watchmakers and Jewelers. The goods are right and the prices uniformly low, and we trust to receive frequent orders from you for goods selected from its pages.

IF YOU DO NOT RECEIVE A COPY OF SAME, ADVISE US.

In addition to our regular stock, we have a large line of discontinued American made watch movements, in 18, 16 and 6 size, which we offer at greatly reduced prices and we will be pleased to write you fully regarding same, upon application.

# DÜRRSTEIN & CO., Watch Manufacturers,

DRESDEN AND GLASHÜTTE, GERMANY.

**SPECIALTIES:** Repeaters, self-striking minute and quarter repeaters, chronographs, chronometers, finest Glashütte anchor watch (patent union) in sizes for ladies and gents, in plain cases and in cases richly chased, engraved, enameled and diamond set. PRODUCTS OF FACTORY FOR SALE BY LEADING JEWELERS.

REPRESENTED BY

**Richard Horstmann,**  
BERLIN, S. W.  
ORANIENSTRASSE 101, 102.  
World's Fair, German Court of Honor.  
MANUFACTURES BUILDING.

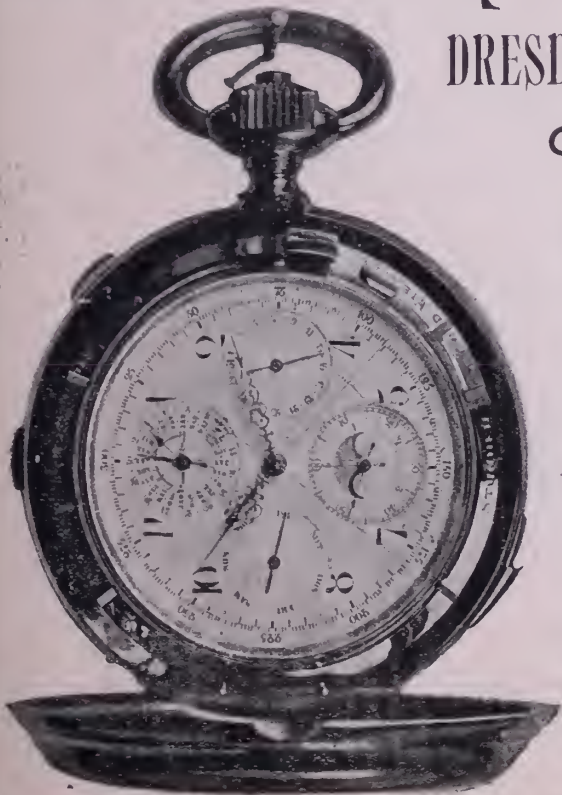

# AIKIN, LAMBERT & CO.

19 Maiden Lane, NEW YORK.  
Branch, 42 & 44 East Madison St., CHICAGO, ILL.  
Manufacturers and Exporters of  
Gold Pens, Holders, Picks, Pencils,  
Fountain Pens, etc.

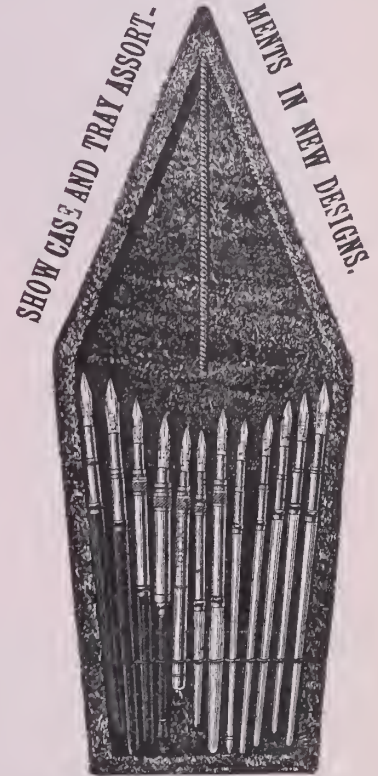

11 x 5 1/2 inches.

PLUSH TRAY WITH EASEL BACK.

1 Doz. 16 K. Pens and Assorted Holders, List, \$31  
1 Doz. 10 K. Pens and Assorted Holders, List, \$24  
Send for Trade Discount.

H. B. BOLSTAD. J. H. NIGHTINGALE.  
WATCH CASE MAKERS AND REPAIRERS.  
**H. B. Bolstad Plating Co.**  
GOLD AND SILVER PLATERS.  
DESIGNING AND ENGRAVING.  
170 Madison Street, - - CHICAGO.

**PARSONS : SCHOOL**  
—FOR—  
**WATCHMAKERS,**  
PEORIA, - - - ILL.

Send for Circular and Terms.  
**PARSONS & CO.**

## JEWELERS.

We guarantee to sell you Sterling Silver Flat Ware at a less price than any other manufacturer, and give you newer designs. We will increase your profits if you will let us. Is it not worth trying?

**OVAITT & WARNER,** Silversmiths,  
PORTLAND, OREGON.

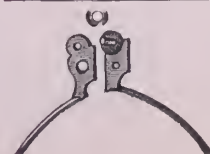

Racine Jewelry Mfg.  
Co.,  
**SPECTACLE TEMPLE**  
WASHERS,  
Gross in a Bottle, 26c.  
For Sale by Dealers in Jobbing Materials

As Regards

SILVER PLATE

WE BELIEVE

THAT an Honest article at an Honest price goes further toward making sales than all the advertising in Christendom,

AND WE WORK ACCORDINGLY.

MAKING and SELLING a BETTER Article for the SAME MONEY, or an EQUAL Article for LESS Money than any other concern, is the principal cause of our fast increasing business.



143.—NAPKIN RING.

HOMAN & COMPANY,

CINCINNATI.

 Visitors to the Columbian Exposition, Remember our Complete Line is displayed at  
155 STATE STREET, CHICAGO.

**BAUME & CO.,** 

21 HATTON GARDEN, LONDON, ENGLAND,  
AND SWITZERLAND.

EXHIBITORS AT CHICAGO OF 

**TOURBILLION CHRONOMETER WATCH,**

WHICH HOLDS THE RECORD AT ROYAL OBSERVATORY KEW.

HIGH CLASS SWISS WATCHES, PLAIN AND COMPLICATED.

PATENTEES FOR SPLIT SECONDS CHRONOGRAPHS (Treble Action.)

AGENT FOR U. S., GEO. E. WILKINS, SYRACUSE, N. Y.



# WORLD'S FAIR and WESTERN SUPPLEMENT of THE JEWELERS' CIRCULAR

CHICAGO OFFICE: ROOM 308, INTER-OCEAN BUILDING.

VOL. XXVII.

CHICAGO, WEDNESDAY, OCTOBER 11, 1893.

NO. 11

## DE BEERS CONSOLIDATED MINES AT THE WORLD'S FAIR.

A MOST interesting sight in the Mining building of the World's Columbian Exposition, one that every jeweler visiting the Fair should study, is the diamond industry display in the Cape of Good Hope exhibit, several allusions to which have been made in precious numbers of THE CIRCULAR. The DeBeers Consolidated Mines Co. have shipped a great quantity of diamond-bearing rock to the Exposition, and through glass windows all the processes of washing, etc., may be witnessed. Their exhibit of rough diamonds is very extensive, containing in all about 10,000 karats, and in it are several notable stones. One, of a fine yellow color, is valued at \$15,000 and weighs 282 karats. One long brown stone is in two pieces which fit exactly, though from the finding of the first part a year elapsed before the second was discovered. The collection contains the only pink diamond of considerable size ever found. It is too

flat to cut, but is very valuable and interesting as a curiosity.

Connected with this exhibit Tiffany & Co., New York, have a plant for cleaving, cutting, and polishing the stones. Here the rough and almost lustreless diamond is carefully ex-

shape and has blemishes necessitating its remodeling. This is the work of the cleaver, and is an operation requiring great skill and a perfect knowledge of the diamond's grain.

The stone to be treated is embedded in a cement holder on the end of a stick; a slight incision is made in its surface by rubbing against it the sharp edge of another diamond similarly fastened in another stick; into the incision the blunt edge of a knife is inserted; a slight tap is given the back of the knife with a small steel bar, and the diamond is split in the direction desired. The new surface so exposed is as smooth and true as if it were polished. This process is repeated until the required form and purity are attained.

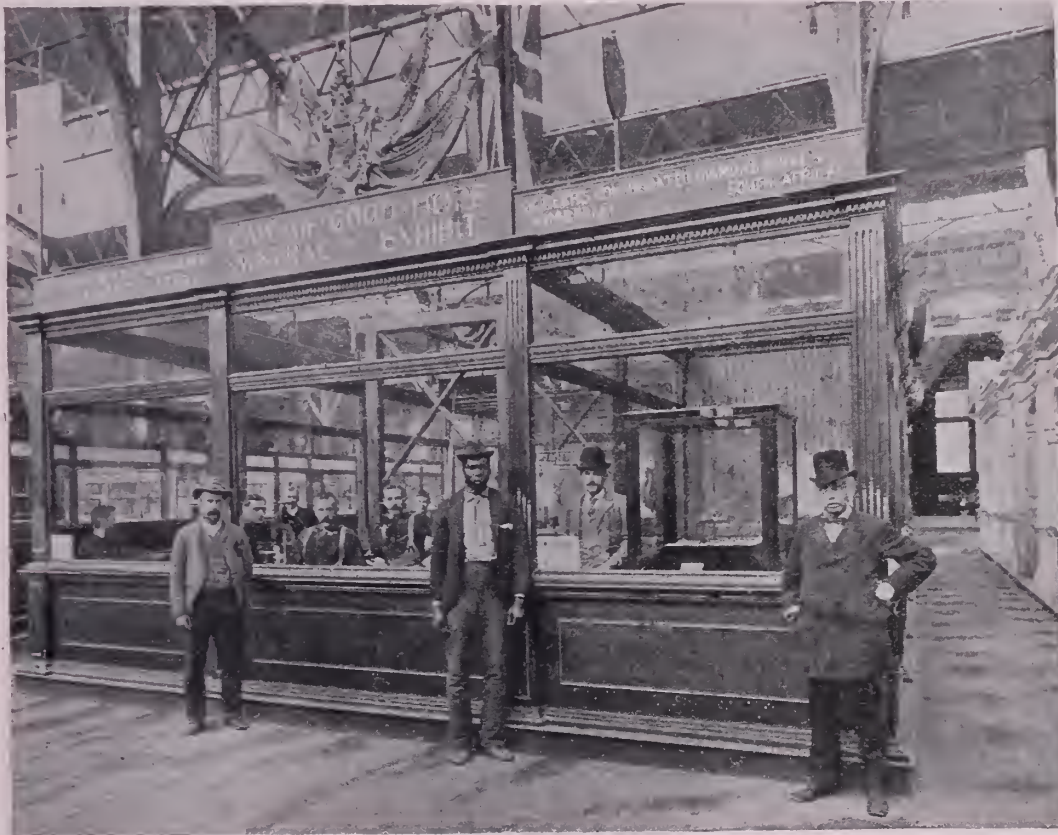

DE BEER'S CONSOLIDATED MINES EXHIBIT IN THE MINING BUILDING.

amined, its grain, general shape, flaws if any, noted, and a decision made as to what form of cutting would bring out its greatest possibilities. Occasionally a stone is of such perfect form that it may be sent to the cutter at once, but usually it is of irregular

The stone then goes to a cutter, who, placing it in a cement holder and employing another sharp diamond as before, gives the gem its general shape, and cuts upon it the larger facets. Next it is taken in hand by the polisher.

### Exhibit of Wm. F. Nye's Watchmaker's Oils.

A DROP of oil, though a small thing in itself, is most essential in prolonging the lifetime and maintaining the accuracy of a time-piece, provided a proper oil be used. A drawback to perfection is the thickening from heat or cold and sometimes evaporation. Again there are oils that contain acids that corrode the parts. It is important that oil for use in the delicate mechanisms of chronometers, watches and small machinery should retain its lubricating properties for a long time through all temperatures and conditions. Summed up, a perfect oil must have uniform consistency, stability, freedom from acid and non-evaporating qualities.

A search for an oil with these qualities brought us to the exhibit of Wm. F. Nye, New Bedford, Mass., in the northeast section of the Fisheries building at the World's Fair. Here, in a handsome case, is shown the product of years of skill and close study, to say nothing of the hardships endured by hardy mariners in hunting porpoise in the seas of the far north, for the fleets of New Bedford often cross the Arctic Circle, and the oil is refined in the coldest Winter weather of the Frigid Zone. No efforts have been spared by Mr. Nye to produce an oil that will stand alone in its perfectness, and the reputation his oils have attained for watch

and chronometer purposes shows that his efforts have always been in the right direction.

The World's Fair exhibit is contained in a fine black walnut upright case with glass sides. On the cornice in gilt letters are the words, "Wm. F. Nye, New Bedford, Mass.," and on the lower sash, "Watch, clock, and chronometer oils." At the rear corner outside the case are piled alternately dozens on dozens of wooden cases of the various oils, including those for the typewriter, and piled high on top of the case is a pyramid of dozens of boxes. Within the case is a display fixture of circular plate glass shelves in pyramidal form supported by a nickel standard running through the center of each plate. These are four in number and revolve by means of a clock movement.

The small top shelf is given to four ounce bottles of superfine watch oil. Below these are watch and chronometer oils in pints, interspersed with four ounce clock oils, and about these a horder of dozens of watch oil in ounces. The third shelf from the top has in the center, watch, chronometer and clock oils in eight ounce hottles encircled by small hottles of clock oil. The lower revolving shelf has a center filled with four ounce packages of the different oils and a horder in ounces of the same. Pints and quarts of all varieties fill the case, which has an outer circle of tall slender exhibition tubes.

The oils by being refined at a temperature

lower than 20° below zero are freed from all impurities that corrode and blacken the pivots of a watch and at the same time are entirely unaffected by heat or cold. Inferior oils have cost the American watch companies thousands of dollars in taking apart and cleaning watches that had been stored for any length of time and in many cases the parts have been found so corroded that it was necessary to change the steel work—all of which would have been avoided by the use of Wm. F. Nye's oil, an oil that meets every requirement.

Said Prof. G. D. Parsons, principal of the Chicago Watchmakers' Institute, in speaking of watch oils: "In factory practice I tested all oils and found the Nye oil to be the best at that time. I have had no occasion to change my opinion, and use it exclusively in the institute. I have found it will maintain a more uniform consistency in hot and cold weather than any other I have ever used." "We use Nye's, and can use no other at this altitude," says Mr. Meyer, of Leadville, (8,500 feet above the sea.) "It is needless to say that I have never attempted to use any other than yours, since I found it the only oil that would run our watches at 50° below zero," says Mr. D. L. Brown, of Detroit, Minn.

This is expert testimony given unsolicited to a seeker after facts. Wm. F. Nye claims they are "the finest watch and clock oils in the world, and we feel a just pride in the position we hold before the horological world, in supplying them with this important factor in giving accuracy to the wheel of time."

#### St. Louis.

Edwin Massa, of the Bauman-Massa Jewelers' Supply Co., and H. Estinghausen have been appointed by the Circuit Court to appraise the effects of Otto Baehr, who assigned recently.

President Herman Mauch and Herman Rohne represented the Missouri Retail Jewelers' Association at the convention here Sunday called by the St. Louis Retail Grocers' Association for the purpose of organizing a State association of retail merchants. The association was organized and Mr. Mauch elected a director thereof.

The employees of the St. Louis Watch Case Co., who are members of the Watch Case Makers' Protective Union No. 6137, declare that they have a grievance against their employers and that some remedy must be forthcoming. They alleged that about the middle of July they were subjected to a ten per cent. reduction in their wages and recently to another ten per cent. reduction. They further say that they have just been notified that if they do not care to work longer on a twenty per cent. reduction they might quit. The St. Louis Watch Case Co. are in business at 118 N. 3d St., Isaac Swope being president.

Wesley Huber, Paynesville, Minn., has removed his store to Jamestown, same State.

## HIGHEST AWARD WAS OBTAINED

AT THE COLUMBIAN EXPOSITION

BY OUR

# Musical Boxes



## JACOT & SON,

298 Broadway, - New York.



Send Business Card for Large Illustrated  
Catalogue and Trade Prices.

ART IN TIFFANY & CO.'S WORLD'S FAIR EXHIBIT.

(Continued from page 1.)

Another notable set is of aquamarines. It comprises a collar, pendant and tiara the general style of which consists of conventional shells and seaweeds, introducing 147 aquamarines in the entire set cut from the same price and 1,843 diamonds. All the aquamarines are crystal; they are remarkable for the perfect match and tone of color. Some of the stones weigh from 75 to 100 karats each.

Among the corsage jewels the shoulder ornament, depicted in the illustration, is notable. It is a foulard or Spanish epaulette, suggested by a piece of old Spanish lace. The jewel may be worn either as an epaulette upon the left shoulder, or as an ornament for the bodice with all the parts detached for other uses. There are nine yellow sapphires, 861 emeralds, and 1072 diamonds in this piece.

Other remarkable corsage ornaments are the Narcissus, a stem of green gold set with demantoids, leaves of diamonds, and a yellow sapphire in the center, drilled and cut to represent the flower in nature, the outer waving edge of the sapphire being set with tiny rubies; a bow-knot decoration consisting of a large diamond bow-knot to be worn on the bodice or hair, with vine of rubies and diamonds, there being two hundred and

forty-four brilliants and sixty-eight rubies in this piece; a stomacher, being a diamond sun, very large, with an extraordinary star-sapphire, weighing ninety karats in the center surrounded by thirty-five small rubies, the rays of the sun being composed of one hundred and eight brilliants set in platinum, while twining in and out between

Among necklaces a Portuguese diamond one consisting of festoons and pendants introducing 550 rose diamonds set in a new diamond metal is prominent, while other praiseworthy pieces are a collar in modern arrangement of yellow, blue and white sapphire rondelles -trands with a center ornament of thirteen cabochon sapphires and diamonds,

and an Oriental necklace of beryls in the center of ruby and diamond ornaments. A Burmese pendant consists of aquamarine incrustated center embedded in a ground of fine Burmese colored gold, set with Oriental rubies and Brazilian topaz. A Turkish pendant is composed of a succession of diamond pendants arranged in Turkish fashion. The diamonds are examples of all the various styles of cutting, such as rondelle, pierced and faceted like beads, briollette, with lozenge facets, pear shape,

table diamonds, and other forms of cutting.

Limited space prevents a summary of the many rings, scarf pins and sleeve buttons that the exhibit discloses. The styles are numerous, fine gem-work not only being embodied, but carving, as in the Amour and Psyche ring, being a feature of interest.

A St. Louis man just back from Morganfield, Ky., states that Harry Poindexter, the famous diamond thief, passed through there a few days ago handcuffed, in charge of a sheriff and en route to the State prison. He was convicted ten years ago of a diamond robbery in Louisville and sent up for sixteen years. He escaped four years ago, however, and was captured recently in Evansville, Ind., and resented.

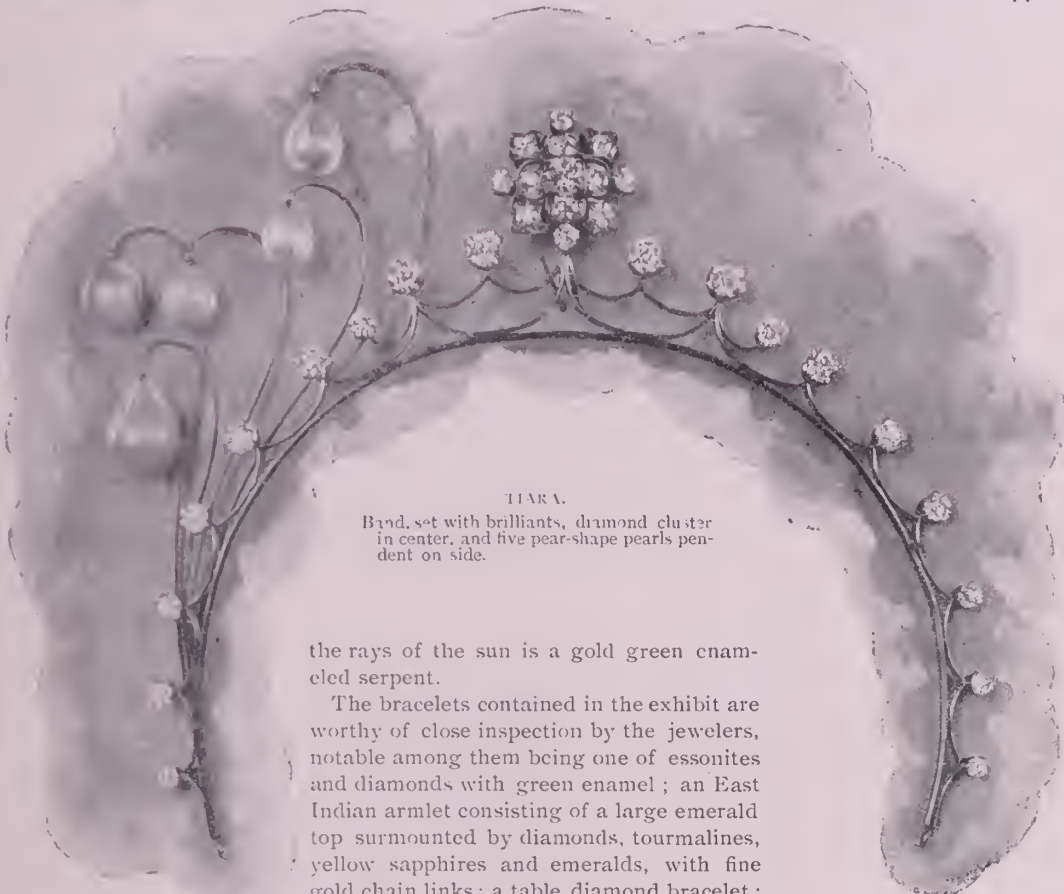

TIARA.

Band set with brilliants, diamond cluster in center, and five pear-shape pearls pendent on side.

the rays of the sun is a gold green enameled serpent.

The bracelets contained in the exhibit are worthy of close inspection by the jewelers, notable among them being one of essonites and diamonds with green enamel; an East Indian armet consisting of a large emerald top surmounted by diamonds, tourmalines, yellow sapphires and emeralds, with fine gold chain links; a table diamond bracelet; a snake bracelet, and a serpent enameled in colors, with diamonds and emeralds in the head.

The display of brooches is extensive and of the most varied nature imaginable, containing as it does Empire, ribbon, pearl, Louis XVIII bonnet, Empire bonnet, Hungarian, crescent, flower, beetle, Louis XIV, caterpillar, Giardinetto, Renaissance, catseye, Navajo Indian, star, zircon, butterfly and many other brooches.

GIBSON HOUSE,

CINCINNATI, OHIO.

ABSOLUTELY FIRST-CLASS AMERICAN PLAN HOTEL.

\$3.00 PER DAY.

Extra Charge for Parlors and Rooms with Bath attached. The unequalled advantages in central location, liberal management, modern appointments, experienced service and perfect cuisine, have permanently established the Gibson House as The Most Popular First-Class Hotel in Cincinnati.

AMPLE VAULTS FOR THE PROTECTION OF VALUABLES.

THE GIBSON HOUSE CO.,

H. B. DUNBAR,

President and Manager.



DALE CHUCKS.



Manufactured by

HOROLOGICAL TOOL CO.,

86 N. CLARK STREET,

For Sale by all Jobbers.

CHICAGO.

### Pacific Coast Notes.

Miss Corinne Butler has opened a jewelry store in Waitsburg, Wash.

L. T. Burnt, representing Salomar Davison, New York, is in San Francisco.

M. German, Los Angeles, Cal., is soon to construct a fine business block on 5th St.

B. W. Rowell, late of San Diego, Cal., has opened a jewelry store in Oceanside.

Fred Corder will open a new jewelry store at 27 New Montgomery St., San Francisco.

John Garbutt has removed his jewelry store from San Francisco to Broadway, Oakland.

J. E. Southworth, Santa Clara, Cal., is slowly recovering from a recent serious illness.

J. R. Williams, a well known jewelry store thief, has been arrested in San Francisco.

J. G. Talbott has been admitted as a partner into the business of E. D. Smith, Santa Ana, Cal.

M. Lissner, of Cohn & Co., Oakland, Cal., has returned from an extended business trip to Chicago and New York.

F. R. Templeton, Modesto, Cal., has sold his jewelry store and will go to San Francisco, where he will probably open a new store.

A new jewelry store is soon to be opened on 2d St., San Francisco, by Will R. Davis, who arrived in California from Chicago a few days ago.

Shaindel & Hoskins, 1109 Market St., San Francisco, have retired from the jewelry business and will hereafter deal only in hardware and furniture.

Isaac Wood, who retired from the jewelry business recently to go upon the stage as a tragedian, has returned to San Francisco and will again adopt his old vocation.

### Detroit.

Hugh Connolly has been called to Stratford, Ont., by the death of his mother.

The cane and umbrella business of John Harley & Co., is advertised for sale under a chattel mortgage.

Edward Rochm, of R. J. F. Roehm & Son, went to New York last week. He will be absent three weeks.

F. Rolshoven returned from Chicago Saturday, R. Rolshoven expects to buy his Fall stock the latter part of October, in New York.

William Walthers, Wyandotte, Mich., is selling his stock at auction. He will move to Buffalo and engage in the jewelry business on a larger scale.

T. J. Commerford, manager of the United States Optical Co., is in Chicago. He will visit Omaha, Neb., on business and return Oct. 11. The company expect to move their factory into their new quarters on Miami Ave., next week.

Business is slowly but steadily improving. Country retailers are purchasing more freely, principally by mail. The following Michigan country jewelers were here last week: H. M. Baxter, Birmingham; H. Wooten, Milford; S. A. Cleveland, Utica; W. E. Skinner, Milford; H. Wood, Leslie; and Fred Grimm, Mt. Clemens.

L. B. Collwell & Co. filed articles of association here last week. The firm intend to refine gold, silver and platinum, and to smelt sweeps containing gold, silver, platinum, copper and iron. The capital stock is \$5,000, of which \$3,000 is paid in. The stock is held as follows: L. B. Collwell, 150; Oscar B. Marx and T. J. Commerford, of the United States Optical Co., 100 and 50 shares respectively.

Dispatches to the Detroit papers announce that the jewelry store of W. J. Till, Columbiaville, Mich., was robbed on the night of Oct. 2d. About \$900 worth of stock was taken. Several other stores were also entered. Mr. Till was in Detroit last week. He stated that the thieves took the cream of his stock, leaving only a few clocks, and that the loss will almost cripple him. There is no clue to the robbers. It is probable that they shipped the goods to some large city. Mr. Till will purchase a new stock.

### Indianapolis.

T. W. Gardner and Carl F. Walk have, returned from the World's Fair.

H. A. Comstock has laid a handsome white tile floor in the entrance of his store. The name, Comstock is in blue tiles.

A reward of \$200 has been offered for the apprehension of the thieves who recently broke into E. F. Stark's jewelry store, New-point.

E. T. Jordan, Harmony, Ind.; Geo. A. Fletcher, Carthage, Ind.; and L. C. Phillips, Carbon, Ind., were buyers from local jobbers last week.

B. C. Calhoun, Purcell, Ind., is selling out his jewelry stock to quit the business, and B. Clark has recently opened a new store in the same town.

Indiana jewelers have been numerous at Chicago, some of the most recent visitors being: J. R. Young, Bourbon; J. Myer, Elwood; C. E. Warson, Thorntown; M. A. Rainboldt, Mitchell; J. M. Tryon, Monroeville; L. M. Beck, Peru; C. R. Blake, Marion; Wm. A. Strong, Kendallville; Herman Vallmer, Princeton, and C. Sieglitz, Vevay.

## RECEIVER'S SALE.



ENTIRE Stock of Giles, Bro. & Co. Fourth Floor Masonic Temple, consisting of Diamonds, American and Swiss Watches, Jewelry, Silver and Plated Ware, Tools, Materials, etc. will be sold in lots to suit the purchasers, at large reduction from original cost price.

An unusual chance for live Jewelers to obtain bargains.

W. H. GLEASON, Receiver.

July 14th, 1893

## IRONS & RUSSELL,

(SUCCESSORS TO CHARLES F. IRONS.)  
MANUFACTURERS OF

SOLID GOLD EMBLEMS ROLL PLATE  
PINS, CHARMS AND SOLID GOLD RINGS.



102 Friendship Street, - - Providence, R. I.

**Chicago.**

Visitors and buyers interested in Chicago and the Fair last week were :

C. C. Hoefler, Kansas City, Mo.; E. F. Hartman, St. Louis, Mo.; T. Blackburn, Delaware, O.; J. C. Stalford, Canton, Pa.; R. I. Baker, Madison, N. Y.; Richards & Park, Colorado, Tex.; G. W. Hardway, Ft. Smith, Ark.; C. F. Hurd, Medina, N. Y.; F. Rols-hoven, Detroit, Mich.; Law & Mathew, Washington, Ia.; L. B. Feuerstein, Kensington, Ill.; J. G. Martz & Son, Erie, Pa.; C. A. Danner, Owosso, Mich.; John H. Frease, Napoleon, O.; C. Stall, Bryan, O.; J. G. Car-nahan, Oxford, Ind.; Jason Weiler, Pittsfield, Me.; S. V. Patterson & Son, Belle Mina, Ala.; J. M. Roland, Greenville, Pa.; W. R. Hale, Greenville, S. C.; Geo. A. Walker, West Winfield, N. V.; C. W. Conger & Co., Groton, N. Y.; H. Remke, Danville, Pa.; J. B. Wainwright, Port Jarvis, N. Y.; W. J. Johnston, with N. H. White & Co., New York; Edwin G. Lloyd, Scranton, Pa.; F. W. Terhune, Barron, Wis.; P. E. Pederson, Rushford, Minn.; Raphael Anzueto, Puebla, Mex.; Georg Bähr, San Pedro Sala, Honduras; W. B. Doddridge, Mentone, Ind.; Alexander Hart, Hamp-stead, Ont.; Harry C. Brittain, Strathroy, Ont.; A. D. Wycoff, Villisca, Ia.; D. Elsheimer & Son, Niagara Falls, N. Y.; Eugene M. Wilhite, Danville, Ind.; Harry H. Weylman, Kittanning, Pa.; W. J. Davisson, Farmland, Ind.; E. R. V. Seutter, Meridian, Miss.; L. C. Bailey & Co., Calais, Me.; E. V. Seutter, Jackson, Miss.; B. E. Arons, Pittsburgh, Pa.; Reinhardt Bros., Lincoln, Ill.; W. L. Weeks, Far Rockaway, N. Y.; E. R. Hopkins, Port Byron, Ill.; J. E. Hunt, Lamont, Wis.; H. S. Solomon & Co., Denver, Col.; H. E. Cole, Mt. Carroll, Ill.; J. W. Perry & Son, Lewiston, Me.; Geo. F. Hill, Ghent, Ky.; B. F. Spranger & Co., Aurora, Ill.; John Stoecker, Syracuse, N. Y.; F. Brun-ner, Cincinnati, O.; Edwin S. Proper, Saybrook, Ill.; S. W. Carroll, Sanilac Centre, Mich.; Elmer G. Tucker, Worcester, Mass.; D. P. Lanning, Gilmore, O.; Chilton Jewelry Co., St. Louis, Mo.; C. R. & H. M. Stilson, Delhi, N. Y.; E. K. Hall, Branwell, W. Va.; H. Goldstein, Watertown, N. Y.; M. Gittler, Ashland, Wis.; Ed. Showerman, Lyons, Ia.; S. E. Eichenlaub, South Chicago, Ill.; G. N. Luckey, Bald-winsville, N. Y.; Henry Motzner, New York; Wm. H. Horton, Clarkston, Mich.; H. A. Johnson, Monmouth, Ill.; A. Hawkins, Noblesville, Ind.; I. N. Jaspes, South Milwaukee, Wis.; Homer D. Parker, Lansing, Mich.; Hiram Luce, Rochester, Minn.; Wm. A. Turner, Clinton, N. Y.; Archie M. Allen, Buffalo, N. Y.; Rufus E. Sharpley, Mechanicburg, Pa.; D. S. Bair, Pittsburgh, Pa.; James Savage, Columbus, O.; M. Weinstein, Minneapolis, Minn.; H. W. Luther, Pitts-burgh, Pa.; E. F. Tinkham, Middleboro, Mass.; F. G.

Meyer, Dayton, O.; Henry F. Finke, Dayton, O.; Fred Spencer, Hudson, N. Y.; Edmund Spencer, Hudson, N. Y.; E. R. Mason, Binghamton, N. Y.; C. H. Loveland, Binghamton, N. Y.; Wm. King, Jr., Buffalo, N. Y.; W. H. Ogle, Centerville, Ia.; S. M. Frankenstein, Cincinnati, O.; F. H. Harm, St. Paul, Minn.; Geo. Henry, Columbus, O.; S. J. Ward, Michi-gan City, Ind.; M. Dissingl, Mecharbe, Pa.; Frank Lewenthal, Hartford, Conn.; I. Farnsworth, Wenona, Ill.; Brashear, Lay & Kyle, Gas City, Ind.; R. A. Brashear and wife, Gas City, Ind.; Lewis J. Grubb, Philadelphia, Pa.; E. S. Bugbee, Tracy, Minn.; Bechtold & Biegler, Sigel, Ill.; M. I. Graham, Nashville, Tenn.; W. B. Nimmerfall, Nashville, Tenn.; T. M. Gaines, Ft. Atkinson, Wis.; S. Engle, Jr., Hazle-ton, Pa.; John M. Freer, Binghamton, N. Y.; W. A. Hill, Lowell, Mass.; J. L. Peake & Son, Decatur, Ill.; R. A. Peake, Decatur, Ill.; W. C. Odemal, Paris, Tex.; W. R. Hale, Greenville, S. C.; Jason Wesler, Pittsfield, Minn.; John E. Beringer, Raton, N. M.; H. S. Compson, Big Rapids, Mich.; E. F. Straw, Pittsburgh, Pa.; A. W. Taft, Providence, R. I.; David R. Burns and wife, Philadelphia, Pa.; M. C. Prince, Herkimer, N. Y.; Chas. Kohler, Norristown, Pa.; Thomas A. Adams, Marshall, Mo.; Fred H. Taber, Grand Ledge, Mich.; M. Peters, Indianapolis, Ind.; A. Oehler, Indian-apolis, Ind.; W. L. Burnam, Maitland, Mo.; J. G. Kapp, Toledo, O.; Louis A. Bürgener, Aurora, Ill.; H. E. Cole, Mt. Carroll, Ill.; Chas. Livingston, Phila-delphia, Pa.; Peter J. Coke, Grand Rapids, Mich.; Ed. V. Allison, Pontiac, Mich.; Edw. Kubic, New York; M. Gittler, Ashland, Wis.; A. C. Gies, Pitts-burgh, Pa.; J. C. Hashman, Unionville, Mo.; N. Stein, Geneseo, Ill.; Wm. T. Vogler, Winsted, N. C.; W. W. Bridges, Marine City, Mich.; W. A. Fenwick, Erie, Ont.; J. W. Knapp, Cross River, N. Y.; Geo. W. Moore, Bloouville, O.; S. L. Harding, Camden, N. Y.; J. E. Adkins, London, Ont.; W. H. Cooper, Hodgesville, Ky.; E. Munson, Mendota, Ill.; Walter Vail, Deposit, N. Y.; F. H. House, Galva, Ill.; J. V. Rettinbury, Dushore, Pa.; Brigham & Eager, Marlborough, Mass.; C. A. Church, Amboy, Ill.; Arthur & Richardson, Webster City, Ia.; G. R. Powell, Cayuga, Ont.; S. S. Hannaca, Booneville, Mo.; Henry C. Smith, North Amherst, O.; E. H. Newman, Owen Sound, Ont.; L. B. Bronston, Garnet, Kan.; John Glennon, Newport, Tenn.; J. M. Chalmers, Lake City, Minn.; Henry Yoste, Vicks-burgh, Miss.; Hugo Watson, Manayunk, Pa.; Henry S. Zinn, Hutchinson, Kan.; C. L. Gil-mour, Greenville, Mich.; T. J. Smith, Grant City, Mo.; Basinger & Co., Lima, O.; L. M. Shaw & Son, Monroe, Ia.; Geo. D. Hamilton, South Lyon, Mich.; F. S. Petz, Detroit, Mich.; W. H. Hill, Sunbury, Pa.;

Henry Sobel, New York; C. C. Hopper, Maysville, Ky.; Birrell & Fobes, Kinsman, O.; Gust. Dahlstedt, Corry, Pa.; Kindig H. Bare, Lancaster, Pa.; C. T. An-dreas, Bayfield, Wis.; Emil Holl, Media, Pa.; Fred Preston, Coshocton, O.; J. Farnsworth, Wenona, Ill.; B. I. Wehrle, Indiana, Pa.; A. C. Anderson & Co., Toronto, Ont.; C. F. Tryon, West Superior, Wis.; J. Drull, Buffalo, N. Y.; John F. Beyerle, Reading, Pa.; C. J. Ricker, Emporia, Kan.; J. H. Gregory, Wash-ington, D. C.; J. R. Grieb, Butler, Pa.; Lyon & Co., Wauseon, O.; Knud C. Pedersen, Warsaw, Ill.; B. S. Stackhouse, Lachute, Que.; Ozias Riley, Champaign, Ill.; Chas. P. Murphey, New Castle, Ind.; G. J. Daum, South Bend, Ind.; J. S. Hotchkiss & Bro., Meadville, Pa.; J. L. Wilson, Woodstock, Ont.; S. B. Bailey, Po-mona, Cal.; F. A. Follett, Tremont, Ind.; F. H. Harm, St. Paul, Minn.; J. G. Wirt, Pittsburgh, Pa.; L. J. Day, Muskegon, Mich.; John D. Doyle, Emporia, Kan.; W. H. Doyle, Bristol, N. Y.; M. E. Kinney, Utica, N. Y.; Will Young, Geneva, N. Y.; August Jarecki, Erie, Pa.; H. A. Boley, De Land, Fla.; Dr. Martin, Pomeroy, Ia.; O. C. Hustad, Tower City, N. D.; Croskey Bros., Gladwin, Mich.; Ph. Zoellner, Portsmouth, O.; A. C. Campbell, Sheldon, Ia.; J. M. Bickford, Rich Falls, Ill.; Henry A. Winn, Newman, Ill.; E. E. Chandler, Boone, Ia.; David T. Keiss, To-peka, Kan.; W. E. Dodd, Lebanon, Mo.; W. H. Reit-erman, Ph. D., Sturgis, Mich.; H. L. Pierce, Belle-ville, Kan.; H. T. Shepard, Eureka Springs, Ark.; John Mundie, N. Tonawanda, N. Y.; A. C. Morck, Jr., Warren, Pa.; Theo. D. Bentley, Philadelphia, Pa.; H. S. Johnston, Apollo, Pa.; T. G. Watts, M. D., Springfield, Mo.; W. T. Harris, Los Angeles, Cal.

Visitors to the rooms of the Chicago Jew-ellers' Association last week were :

W. H. Arewo, Jamestown, Ind.; M. N. Berg and wife, Cloquet, Minn.; C. G. Tomlinson, New York; C. J. Josephson, Moline, Ill.; J. R. Armond, Winnep-egon, Man.; H. Kirgasser, Mobile, Ala.; Robert Croskey, Gladwin, Mich.; K. C. Pedersen and wife, Warsaw Ill.; F. A. Heberline, New Brighton, Pa.; S. H. Bailey, Providence; Wm. Glover, Jr., and Sylvester Engel, Jr., Hazleton, Pa.; H. A. Johnson, Monmouth, Ill.; L. H. Wallace, Ogden, Utah; A. B. Hall, Danville, Ia.; Fred Claringbowl, Hamilton, Ont.; C. E. Hayden, Raymond, O.; Harry E. Thomas, Wilmington, Del.; J. B. Stegall, Chattanooga, Tenn.; Chas. F. Richards, Granite, Mont.; E. S. Proper, Seattle, Wash.; C. F. Tryon, West Superior, Wis.; Jas. H. Whiteside, Lib-erty, Mo.; Ralph Binder, Wm. Zibell and J. Mart Miller, Philadelphia, Pa.; Chas. F. Willemin, New York; Joseph M. Schaefer, Pittsburgh, Pa.; R. B. Geoghegan, Louisville, Ky.; J. J. Gray, Barry, Ill.; J. W. Wood and wife, Galva, Ill.; J. L. Smith, St. Cath-

# The Wadsworth Watch Case Co.



Filled



Cases.



General Offices,  
**NEWPORT, KY.**

Chicago Office,  
**COLUMBUS BUILDING.**

arines, Ont.; H. Rehmke and C. Senner, Ellensburg, Wash.; J. D. Parker, Toronto, Ont.; W. H. Hill, Sunbury, Pa.; Laurel V. Stone, Conneaut, O.; J. B. Hudson and wife, Minneapolis, Minn.; W. H. Ogle, Centerville, Ia.; K. Carson, Ballinger, Tex.; W. H. Long, Philadelphia, Pa.; J. H. Gregory, Washington, D. C.; Miss Swift, Miss Lizzie Swift, Mrs. Baylies, Mr. and Mrs. Chas. F. Borden and Miss Grace L. Borden, New Bedford, Mass.; J. J. Phelps, Philadelphia, Pa.; Ferd. Phillips, Cincinnati, O.; Wm. Conrad, Tecumseh, Neb.; A. F. Mirlach, and A. Mirlach, Jr., Beaver Dam, Wis.; John A. Didot and wife, Geneva, Ind.; James Gammack, Port Huron, Mich.; S. Swart, and Arthur T. Swart, West Bay City, Mich.; H. M. Ryman, New York; Evan H. Eastwood, Newark, N. J.; Chas. W. Park, Newark, N. J.; Carl Adler, Baker City, Ore.; Peter Kosele, and J. W. Adams, N. Attleboro, Mass.; Otto Wettstein, Rochelle, Ill.; Wm. H. Horton,

Clarkston, Mich.; Henry Ford, Lafayette, Ala.; Joseph Tom, Waltham, Mass.; Lorenz and Christ. Kolsens, New York; C. Janke, Galveston, Tex.; C. F. Smith, Smith & Newell, Harvard, Ill.; H. O. Thomas, Indianapolis Ind.; Thos D. Farrell, Bradford, Pa.; L. Bennett, St. Joseph, Mo.; Chas. C. Massina, Williamsport, Pa.; Fred A. Riefler, Buffalo, N. Y.; Lucas Hermann, Calumet, Mich.; J. G. Willeke, Springfield, Mo.; B. A. Ballou, Providence, R. I.

John D. Doyle, Emporia, Kan., formerly in the optical business in New York State, is in the city preparing to again enter the optical field.

Tatsch & Wild, in their new quarters, 1402 Columbus building, have a room in every way suited to the needs of the precious

stone trade. The north light is perfect for the examination of gems, and the absence of street noises and dust is also an advantage.

August Jarecki, Erie, Pa., one of the oldest jewelers in the United States, is in the city.

Bruce Bonney has resumed charge of the Gorham Mfg. Co.'s World's Fair exhibit, Mr. Le Cato having returned to New York.

The next session of the Chicago Ophthalmic College, 607 Van Buren St., will begin, in evening classes, the first Tuesday in November, commencing 7.30 P.M. The class is rapidly filling.

## World's Fair Exhibit of W. B. & Co. Watch Glasses and Spectacle Lenses.

From JEWELERS' CIRCULAR, October 4th.

IN the German gallery of the Manufacturers building, Walter, Berger & Co., of Goetzenbruck, Lorraine, have a fine exhibit of the celebrated W. B. & C. watch glasses and spectacle lenses. The goods are displayed on upright white cloth covered surfaces in a handsome walnut case. On one side are watch glasses, from the smallest to the largest, in plain, beveled edge and ground centers of every description. Larger glasses for photo and miniature frames are shown in oval, rectangular and circular forms, and the base between the pyramid and case is piled deep with scores of original packages in dozens and grosses.

A small line of artificial eyes and a large line of samples of spectacle lenses of all varieties of form and color occupy the opposite surface. On both sides, the glasses are arranged in geometrical designs, and are well arranged for a proper examination. As showing the capacity of the works for varying dimensions the ends of the case are filled with huge watch glasses of some 20 inches diameter. Walter, Berger & Co., are prize winners at the World's Columbian Exposition, having received a medal and diploma for their exhibit. The firm is represented in this country by Albert Berger & Co., 47 Maiden Lane, New York.

The factory of Walter, Berger & Co. is situated in a small town in Lorraine called Goetzenbruck. The origin of this factory dates as far back as 1640, when the ancestors of the present glassmakers went to that country where woodland was plentiful. About this time Richelieu, minister of Louis XIII., King of France, made a tour of Lorraine, and being much pleased with that new industry, made a concession of 1,000 acres of woodland to the brothers, Nicholas, Etienne and Martin Walter to encourage and help them in their undertaking. The conflict known as the Thirty Years War was then raging. The Swedish army passed through Lorraine, devastated the country, set fire to the factory, famished the people and enlisted most of the workmen. Notwithstanding these discouragements,

the three brothers with perseverance and hard work managed to start again, and build up what is now the biggest watch glass and lens factory in the world.

At first these people made only hollow glassware such as bottles and drinking glasses, and it was as late as 1724 that the glassmakers of Goetzenbruck began to make watch glasses, at the time the watch trade used only the verge glass, which was a section of a glass ball.

In 1766 at the request of a Frenchman by the name of Chambre, the factory manufactured Geneva glasses. These glasses were blown piece by piece on small round bottles, the bottom of which would constitute the watch glasses, and afterwards taken out by a red hot iron. The center of commerce was then Holland, and it was there that most of the glasses were sold. Switzerland, where the new industry of watchmaking was becoming established, also consumed a large quantity of the glasses. The price of these glasses was then 200 francs per gross, an enormous price from the present day standpoint.

In 1824 the business developed to such a great extent that the manufacture of glassware was given up entirely and the factory applied itself to the making of watch glasses only. At that time it employed about four hundred workmen. In 1830 Hilaire Walter, son of the owner, went to New York and established a branch house called Berger-Walter, and introduced the W. B. & C. watch glasses. This brand of glasses holds the highest position in the American market by reason of their superiority, fine finish and flexibility, and are celebrated not only in Europe but in the world over, being known by all watchmakers. It is but in reason to suppose that such a firm as Walter, Berger & Co., with its long active career at its back, would produce an article of the most perfect qualities. As such every watchmaker regards the W. B. & C. watch glass.

A proof that the W. B. & C. are the best glasses is that the firm has received the highest award at every large exhibition

held in various cities of the world, including the great distinction of the cross of the *Legion d'Honneur*, and, as above stated, the highest award for their remarkable workmanship at the World's Columbian Exposition, Chicago. Were no other proofs available, these awards would be sufficient in evidence of the good qualities and superiority of manufacture of these watch glasses.

In 1835 Hilaire Walter invented a method of making Geneva glasses by a new molding process, which saves a great deal of handwork. In 1854 the house of Berger-Walter changed its name to Albert Berger & Co., which is in existence yet, at 47 Maiden Lane, New York.

In 1860 André Walter, whose death occurred about a month ago made the first flat parallel and mi-concave glasses, and invented an automatic lathe to grind them by. There is no other factory producing watch glasses and spectacle lenses that manufacture their own glass. Walter, Berger & Co., not only make the rough glass, but also the potash and other chemicals used in the composition of the same. The manufacturers' idea in thus doing is to have always the whitest, purest and hardest glass which possibly can be made for optical purposes. The cost of manufacturing the glass is considerably greater than if they bought it, as other watch glass and lens makers do. By making their own glass they are enabled to have it more uniform and more suitable for their purpose.

The factory constantly uses two furnaces, each with ten melting pots, each pot containing 1,000 pounds of glass. A few years ago it was necessary to build a new grinding shop with 1,000 tours which are in full operation day and night. There are employed at the present moment about 1,500 workmen and the work people of Goetzenbruck are all prosperous happy and own the houses and gardens they occupy.

Albert Berger & Co., who represent the factory in New York are very closely connected with Walter, Berger & Co. and are the sole agents for their glasses.

**A. BERGER & CO., - 47 Maiden Lane, N. Y.**

F. T. Pearce and Louis Blackinton are pleased with the awards granted on pens and chains. Both gentlemen are in the city.

H. Muhr's Sons' World's Fair souvenir case openers are being worn as watch charms and pendants by World's Fair visitors and attract much attention.

If B. A. Ballou isn't a lover of Chicago from now on, it will not be the fault of his many friends in the west. Mr. Ballou was deeply interested in both city and Fair.

Mr. Jacot, of Jacot & Son, the celebrated music box manufacturers, spent the past week at the Fair. In view of the fact that their boxes received the highest award at the Fair, Mr. Jacot is of belief the Fair is a success, in some ways as great as the success of the boxes his firm make.

At the regular monthly meeting of the Chicago Jewelers' Association held in their rooms the 3d inst., it was moved by F. M. Sproehnle and seconded by A. Hirsch that it was the sense of the association that members should keep their places of business closed on Chicago Day at the Fair, Oct. 9th, the anniversary of the great fire of 1871. The motion was carried and the assistant secretary, Mr. Hurd, instructed to inform all the members of the passage of the above resolution and present to each for signature an agreement to keep his place of business closed on that day. Lapp & Flershem and F. M. Sproehnle & Co. furnished all employes with Chicago Day tickets to the Fair, two tickets being given to married employes. The day was almost universally regarded as a business holiday.

The September class of the Chicago Ophthalmic College, 607 W. Van Buren St., Dr. H. M. Martin, president, included the following gentlemen, many of whom are prominently identified with the jewelry trade in various sections of the country: C. E. Hayden, Raymond, O.; Tetey Blackburn, Delaware, O.; Fred H. Taber, Grand Ledge, Mich.; Wm. Piper, Johnstown, Pa.; H. R. Martin, Canandaigua, N. Y.; H. C. Korfhage, Racine, Wis.; Anna Carter, Chicago, Ill.; O. W. Rood, Iowa City, Ia.; H. B. Shellito, Sault de Ste. Marie, Mich.; C. W. Robinson, Colorado Springs, Col.; Chas. M. Haynes, Chillicothe, O.; Fred. A. Perry, Lewiston, Me.; Albert W. Kirk, London, Can.; Hattie M. Betts, Lincoln, Neb.; C. H. Todd, New Richmond, Wis.; Wm. Sprasser, Watertown, Wis.; Edward H. Bonnett, Zanesville, O.; Henry N. Rogers, Winona, Minn.; E. A. Mullen, Chicago, Ill.; P. H. O'Gara, Chicago, Ill.; Wm. H. Dougherty, Chicago, Ill.; T. J. Watts, M. D., Springfield, Mo.; J. G. Graham, Pittsburgh, Pa.; Joseph H. Greer, M. D., Chicago, Ill.; and C. W. Jones, New York, N. Y.

**Cincinnati.**

Jos. Hornback, of Duhme & Co., says business in the material department has increased greatly the past month.

Louis Albert has been buying goods for a fresh trip.

The death of Geo. E. Reisinger occurred some days ago.

Frank Herschede has given a real estate mortgage for \$5,000.

Herman Keck, of the H. Keck Mfg. Co., has left for Europe, to be gone several weeks. He went direct to Amsterdam.

Cliff Miller, salesman for Duhme & Co., returned from his trip to take a wife. The charming young lady is Miss Emma Walters, of Walnut Hills.

Ed Kromgir, of W. T. Eichelberger & Co., is at the World's Fair, as is Moses Schwab, of A. G. Schwab & Bro., Walter Russell, of Russell Bros., and Joseph Mermert.

The Gibson House management has introduced a time recorder clock that will make the laggards among the hotel employes get a hustle on themselves when they report for duty.

It is said that Amberg & Co., who moved from Fountain Square the first of the year to 5th and Elm Sts., will return to their old locality. Though they have not succeeded

in renting their old store, they are only a few blocks away from it.

John Holland appeared in Police Court last week and identified a quantity of gold penholders and silver novelties stolen from the store of his company a few days ago. The thieves confessed to throwing a lot into a sewer. Several street fakirs have been arrested with the goods which they were hawking on the streets.

**Minneapolis and St. Paul.**

J. B. Hudson, of Minneapolis, has gone on a two weeks' business trip to New York.

C. N. Nelson, St. Paul, has returned from a protracted visit to Chicago.

C. C. Berg, St. Paul, has purchased the entire stock and fixtures formerly belonging to W. H. Breen recently assigned, for \$530, at assignee's sale.

A building permit was issued a few days ago to J. R. Elliot, Minneapolis, for a brick building of three stories to be erected at 428 Nicollet Ave. corner 5th St., to cost \$20,000.

**REED & BARTON,**

**SILVERSMITHS,**

MANUFACTURERS OF

**STERLING SILVER and SILVER PLATED WARE.**

SALESROOMS:

**37 Union Square, New York.**

34-36 WASHINGTON STREET,

**Venetian Building, Chicago.**

FACTORIES, TAUNTON, MASS.

ONE OF THE BEST OF THE VERY BEST.

QUALITY IS THE STANDARD OF VALUE.



HAS LENGTH, STRENGTH, ACCURACY.

MEN INTERESTED WRITE YOUR JOBBER OR

**MOSELEY & CO., - - ELCIN, ILL.**

### Awards of Interest to the Jewelry and Kindred Trades.

CHICAGO, Ill., Oct. 9.—The following awards for the Mines and Mining building exhibits were made Tuesday:

Geo. F. Kunz, of Tiffany Co., New York, collection of platinum, meteorites and diamond associations.

Tiffany Co., New York, collections of fine minerals, gems and precious stones.

A. M. Field, Asheville, N. C., collection of cut and uncut gems.

Bunde & Upmeyer, Milwaukee, Wis., diamonds and pearls.

Dayton & Murphy, Stevens Point, Wis., jasper and serpentine.

American Turquoise Co., New York, turquoise.

Snake River Opal Mine, Idaho, fire and peacock opals.

H. C. Deming, Harrisburgh, Pa., collection of cut gems.

Ramon Martinez, San Luis Potosi, Mexican opals.

Geological Exploring Commission, Mexico, opals.

Minister of Mines, Sydney, N. S. W., diamonds and diamondiferous earth.

Prof. A. Liversidge, Sydney, N. S. W., gems.

Spiers & Rigg, Sydney, N. S. W., rough gem stones.

Jagersfontein Mining & Exploration Co., limited, South Africa, rough diamonds.

Government of Siam, Bangkok, precious stones, unmounted.

Rodrigues de Moura & Co., San Salvador, Bahia, Brazil, amethysts.

De Beers Mining Co., Cape of Good Hope, diamonds in the matrix and in the rough.

The awards in Group 98, Department Manufactures, include jewelry and ornaments were made Wednesday as follows:

#### PROVIDENCE.

Charles F. Irons, gold and plated emblem pins, charms, rings.

Kent & Stanley Co., watch chains, jewelry.

S. & B. Lederer, rings.

A. Lorsch & Co., imitation stones.

R. L. Moorhead & Co., lace and scarfpins, silver novelties.

Marden & Kettlety, chains.

New England Manufacturing Jewelers' Association, general line of jewelry, chains, charms, lockets, bracelets.

Ostby & Barton, solid gold rings.

William K. Potter, tortoise shell jewelry, tortoise shell combs.

Providence Stock Co., gold and silver necklaces, vest chains, aluminum chains.

Payton & Kelley, chains, charms, pendants.

F. T. Pearce & Co., gold pens, gold pencils, gold penholders.

Reynolds Jewelry Co., plated jewelry.

R. L. Griffith & Son, brooches, white stone goods, shell pins.

Hancock, Becker & Co., gold rings.

J. H. Fanning & Co., chain mountings.

Poster & Bailey, sleeve buttons, lace pins, lockets, bracelets.

Arnold & Steere, set, plain and engraved rings.

O. C. Devereux & Co., mother-of-pearl book marks, mother-of-pearl paper cutters, mother-of-pearl bodkins.

E. L. Spencer & Co., chains, gold rings, gold drops.

W. E. Webster & Co., gold rings.

#### PAWTUCKET.

George H. Fuller & Son, jewelers' trimmings, jewelers' ornaments, jewelers' supplies, jewelers' chains, jewelers' balls, jewelers' buttons.

#### NEW YORK.

Tiffany & Co., gold ornaments, rings, chains, bracelets, necklaces, diamonds, colored gems, rubies, sapphires, fancy stones, diamond cutting, rubies and fancy stones, agate, jade, rock crystal.

Brown Amber Mfg. Co., amber jewelry, pipe and cigar holders.

Bell & Barber, pyrites, jewelry and ornaments.

Leon Favre (Roy Watch Case Co.), ivory miniatures.

#### SARATOGA SPRINGS.

J. A. Canini, jewelry, mosaic jewelry, gold silver with turquois, coral jewelry.

#### ATTLEBORO.

W. & S. Blackinton, gold plated, silver, and fancy chains.

R. F. Simmons & Co., gold, rolled, and plated chains.

#### ST. LOUIS.

Mermod-Jaccard Jewelry Co., diamonds, diamond jewelry and solid silverware.

Awards were announced Thursday in groups 77 (machinery) and 114 (lighting apparatus and appliances,) in which the following will interest the reader:

F. A. Hardy & Co., automatic lens grinding machines.

Crown Pen Co., exhibit of tools and machines in operation for making gold pens.

Faneuil Watch Tool Co., bench lathes and attachments, watchmakers' lathes and attachments, staking tools and the rivet patent friction clutch.

Samuel Moore, Providence, automatic machine for making metal beads.

Tiffany Glass and Decorating Co., sanctuary lights of silver and copper of new and artistic design, a metal mother-of-pearl electrolier, novel in form and artistic design, a church electrolier of great size, glass and metal.

Rochester Lamp Co., lamps, lamp shades and appurtenances, artistic display.

The announcement was made Friday of awards in group 119 of manufactures, including files, cutlery, etc., as follows:

Nicholson File Co., Providence, R. I.,—files and rasps, filer's specialties.

McCaffrey File Co., Philadelphia, Pa.—files and rasps.

Kearney & Foot Co., New York—files and rasps.

C. O. Oberg & Co., Eskilstuna, Sweden—files and rasps.

I. N. Eberle & Co., Augsburg, Germany—saws, files, etc., saw blades, watch-springs, needles, etc.

Egydzer Eisen und Stahl Industrie Gesellschaft, Vienna, Austria,—files.

Grobet Frères, Vallorbes, Switzerland—files.

Adolph Werner, Schmalkalden, Germany—tweezers of all kinds.

Northfield Knife Co., Northfield, Mass.—pocket cutlery.

R. Torrey Razor Co., Worcester, Mass.—razors.

Hatch Cutlery Co., Milwaukee, Wis.—shears, scissors, pocket cutlery and knives.

Gallus & Wolf, Prague, Austria.—Dessert knives, etc.

A. Zandoo, Vienna, Austria.—Table and dessert knives, etc.

Carl Mintschel, Nixdorf, Austria.—Pocket and hunting knives.

Antonia Bezerra, Ciara, Brazil.—Dagger with silver handle set with fine stones.

S. Yoshida, Osaka, Japan.—Cutlery.

D. D. Kondratoff, Vatschi, Russia.—Cutlery.

Vollogda Perpetual County Industry, Vollogda, Russia.—Cutlery.

W. T. Stamforth, Sheffield, England.—(3 awards). Pocket cutlery, farmers' and hunters' knives, razors.

George Wostenholm & Son (Ltd.) Sheffield, England.—3 awards: Pen, pocket, and sporting knives, table cutlery, razors and scissors.

The following is posted in Chief Gammon's office:

In view of the fact that it will be impossible to deliver medals to exhibitors for a month or two to come, John Boyd Thacher has arranged to furnish them with a temporary substitute. These substitutes are in the shape of bronzed cards, about 6x8 inches in size, on which is printed:

CHICAGO, 1893, WORLD'S COLUMBIAN EXPOSITION. MEDAL AWARDED. JOHN BOYD THACHER, CHAIRMAN EXECUTIVE COMMITTEE ON AWARDS.

The Awards Bureau began sending out the bronzed cards Tuesday week.

### Springfield, Mass.

Richard F. Grady, formerly employed in the Russell & Jones clock shop in Pittsfield, is now city clerk of Waterbury, Conn.

Forbes & Wallace, the large dry goods dealers, have opened an optical department and put D. C. Loomauey in charge. They will examine eyes and prescribe, free of charge.

E. C. Watson, manager for O. W. Bullock & Co., has gone west on his semi-annual business trip. He will go as far as Kansas City and Omaha and will be away six weeks.



# DID YOU HEAR HIM CROW?

HIGHEST  
AWARD  
MEDAL  
AND  
DIPLOMA.



HIGHEST  
AWARD  
MEDAL  
AND  
DIPLOMA.

## W. & S. B. ★

### ❖ Old Reliable Chains ❖

RECEIVE HIGHEST AWARD

— AT THE —

## WORLD'S ❖ COLUMBIAN ❖ EXPOSITION,

1893 ❖ CHICAGO ❖ 1893

NOTE OUR PATENTED TRADE MARKS.

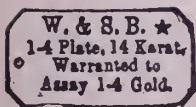

SUPERFINE QUALITY.

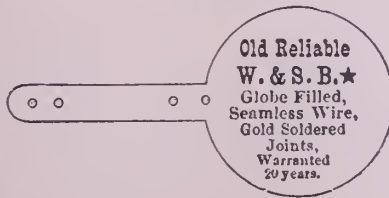

EXTRA FINE QUALITY.

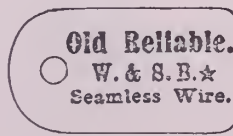

REGULAR QUALITY.

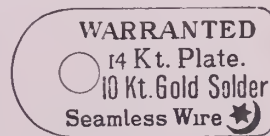

SECOND QUALITY.



SECOND QUALITY.

# W. & S. BLACKINTON, ATTLEBORO, MASS.

**Canada and the Provinces.**

Miss E. E. Ernst, optician, is at present in Lunenburg, N. S.

The stock of Benjamin Isaac, Toronto, was sold at auction Oct. 3.

The estate of John Brodie, London, Ont., is advertised for sale by tenders.

F. H. Bird, London, G. B., has opened an establishment at Springhill, N. S., for the repair of watches, etc.

James Carr, Halifax, N. S., has moved his business from 31 Buckingham St., to a new shop a few doors further west on the same street.

C. G. Schulze who has for years carried on a large business at 167 Barrington St., Halifax, N. S., has removed his store to a new building one door south of his old stand.

Charles Taylor, of P. W. Ellis & Co., Toronto, was agreeably surprised on his return from his wedding trip last week, by his fellow employes presenting him with a handsome marble clock and oxidized silver ornament.

Moses Cochenthaler, Montreal, has been made the official jeweler to Lady Aberdeen as an acknowledgment of the skill shown in resetting and cleaning the jewels of Her Excellency, recently entrusted to him for that purpose.

Last Tuesday a gang of desperados were captured at Vandrenie, near Montreal after a desperate fight with detectives. The

prisoners are supposed to be men who recently robbed several stores in Oshawa, Ont., including that of J. A. Gibson, jeweler.

A movement is on foot in Toronto to procure new dials for "The People's Clock" on St. James' Cathedral in that city. It is proposed to erect new dials of 150 feet diameter, which will be in proportion to those in Victoria tower, Westminster, London. These will be the largest upon this continent. The secretary of the Citizens' Committee has received a contract from Benson & Sons, London, the makers of this prize clock, which with the freight and erection, comes to about \$2,000.

**Connecticut.**

W. Sparks, traveling salesman for the Seth Thomas Clock Co., started on his Fall trip Oct. 2d.

Mr. and Mrs. C. L. Rockwell, of Meriden, left Oct. 4th for the World's Fair, to be absent a week or ten days.

George Strobel, of Waterbury, has accepted a position as traveling salesman for the Waterbury Watch Co.

Mr. and Mrs. W. P. Morgan, of San Francisco, who have been visiting in Meriden, left on Oct. 3d to return to California.

Leroy Upson and Herbert M. Upson, of Waterbury, left Oct. 5th for the World's Fair, the former going on business for the Waterbury Watch Co.

C. Rogers & Bros., Meriden, are nearly ready to commence their manufac-

ture of table cutlery, and they claim to have a secret process whereby a fork can be stamped, tined and shaped, and the bolster made while cold.

F. B. Shuster, of New Haven, was in Ansonia last week for the purpose of keeping an appointment with Phelps & Bartholomew Co. He is the inventor of a new clock case which is said to be a vast improvement on the old metal cases. The new case, being made of sheet steel, would not break from a fall, and if it did fall a person would not have to exercise his whole strength to lift it to its place again.

Bridgeport meets with a loss in the death of Frank Armstrong, an ex-jeweler, aged sixty-two, who died Oct. 4th. He was one of its wealthiest and most benevolent citizens. He leaves an estate valued at half a million dollars. He came from his native land, Poland, to Waterbury, Conn., where thirty-five years ago he was employed as a journeyman watchmaker by the late James R. Ayres, jeweler. Later he became a proprietor of a jewelry store there. His business talents attracted the attention of the Wheeler & Wilson Sewing Machine Co. and he served the company for years as their European agent. He made money rapidly largely by wise investments. He came back to Bridgeport and founded the Armstrong Suspender Co. He learned the trade of a watchmaker in Poland and ever took a deep interest in the development of the watch and jewelry industry in his adopted country.

CHICAGO, 1893.

PHILADELPHIA, 1876.

GENEVA, 1880.

PARIS, 1889.

**... EZRA KELLEY'S ...  
LUBRICATING OILS,**

**FOR WATCH, CLOCK AND CHRONOMETER MAKERS, ALSO TYPE WRITERS, MECHANICS AND SEWING MACHINE OILS  
HAVE BEEN INVARIABLY VICTORIOUS.**

The discovery of a Lubricator for **Fine Machinery**, such as Watches, Clocks and Chronometers, that is free from gum and glutinous matter, has taxed the ingenuity of hundreds of men whose efforts have proved a failure; but we are happy to say (being largely interested) that such an article has been supplied by

**MR. EZRA KELLEY OF NEW BEDFORD, MASS.**



Who, after sixty years of study of the subject, perfected a lubricator that recommends itself to all who have used the **GENUINE**, there having been numerous counterfeits in the market, as witness also the first class awards and diplomas by the judges at the Exhibition in Philadelphia in 1876, Geneva in 1886, in Paris in 1889, receiving the only medal awarded to an American exhibitor of oils, and at the World's Columbian Exposition, Chicago, this year.

It is for the interest of every Watch, Clock and Chronometer Maker and Repairer to use in his work the **BEST**



oil obtainable, regardless of cost. **EZRA KELLEY'S** claim to be the foremost manufacturer of the **Best, Purest and Finest Oils**, giving the best results, is not based upon his own assertion, but is founded upon the fact that wherever his oils have been exhibited in competition with other makes subject to an examination by experts, they have received the highest award of merit. We have no hesitation in saying that his oils are the **best** manufactured, always uniform in quality and capable of standing all tests applied to lubricating oils.

P. S.—There are two grades of



Clock Oil, the "Superior" and the "American." The Superior is adapted for lighter bearings, as found in French, German and Swiss Clocks. The American for American Clocks, Gun and Locksmiths' use, it having more body and being adapted for heavier bearings.

The above oils can be procured at all first-class wholesale Watch and Clock Establishments in the United States, as well as at wholesale of his only Agents,

**HENRY GINNEL & CO.,  
31 MAIDEN LANE, NEW YORK.**

**GRIMSHAW & BAXTER,  
35 GOSWELL ST., LONDON, ENGLAND.**

### Providence.

W. H. Smith, 45 Dorrance St., is out of business.

Sigmund Lederer and family have gone to Chicago.

I. G. Thresher, of Waite, Thresher & Co., has bought real estate for \$10.

R. G. Schutz, salesman for J. W. Grant & Co., has severed his connection with that concern.

Chas. F. Irons has gone on an extensive western trip in the interests of Irons & Russell.

John S. Palmer has been elected president and Dutee Wilcox, a director of the City Savings Bank.

S. & B. Lederer are making extensive alterations in their building on Trinity Square, which will cost about \$5,000.

By the recent failure of Otto Baehr & Co., St. Louis, Mo., eastern manufacturers are interested to the extent of from \$1,000 to \$1,200.

Isaac M. Potter, of Potter & Buffinton, George Becker, of Hancock, Becker & Co., and A. O. Ostby, of Ostby & Barton, are all at the World's Fair.

Dr. William F. Hutchinson, who died on Sept. 30th, was the author of some of the handsome little leaflets and other pamphlets issued by the Gorham Mfg. Co.

Capt. Jerome Fitzgerald, of the Hope Silverware Co., is prominently mentioned as the successor of General Dennis, to the position of Adjutant General of Rhode Island.

One of the fashionable weddings of this vicinity will be that of Miss Florence H. Fisher, daughter of the late William M. Fisher, to Dr. William Reeves Lamb of East Greenwich.

Foster & Bailey are having two artesian wells driven in the yard in the rear of their works, from which it is their intention to supply all the water used in their works for drinking and manufacturing purposes.

Robert E. Northam, William Spencer and Charles H. Merriman have been appointed by the Probate Court of the town of Barrington as commissioners to examine and receive all claims against the estate of the late Henry A. Monroe, formerly of J. B. Mathewson & Co. The settlement of this estate will in a great measure determine the future settlement of the J. B. Mathewson matters.

### The Attleboros.

Henry D. Merritt was painfully injured in a bicycle collision on Thursday.

Many of the shops were closed Thursday to allow the hands to attend the fair.

The "company shop" occupied by O. M. Draper, G. W. Cheever & Co., E. I. Richards & Co. and other firms is brilliantly illuminated evenings showing that business has taken a new lease here. It is several months since these shops were lighted up at night.

Philip Lederer, for years designer and pattern maker for T. I. Smith & Co., has engaged with the Plainville Stock Co.

Among those who started for the World's Fair last week were: E. D. Guild, W. H. Wilmarth & Co.; Jesse Stanley, Stanley Bros.; George H. Chase, A. Busbee & Co.; and J. H. Sturdy F. J. Barden, J. G. Barden and H. F. Barrows returned.

S. E. Fisher, who has been suggested by the Republicans as a strong candidate for representative, has announced his willingness to run if nominated.

### Philadelphia.

A judgment for \$749 has been entered against Morris Lewis.

I. Weiss, 713 South St., has disposed of his stock and fixtures to M. Sangursky.

J. C. Buck & Co. are preparing to move from 422 Commerce St., to 6th and Commerce Sts.

James Gylowski & Co. have associated with them Theodore Schell, who for a number of years conducted business at 3d and Chestnut Sts.

John M. Scott and Harry A. Kane, old gold dealers, have been acquitted of the charge of receiving stolen goods, in connection with the thefts of F. W. Peoples.

Lucey R. Davis, the wife of Junius H. Davis, of Davis & Galt, died suddenly on the evening of the 29th ult. She was forty-nine years of age, and was the daughter of George and Anna Ruhl. The funeral was held on the 4th inst., the interment being private.

On last Monday Frank Roop pleaded guilty to the embezzlement of \$300, the property of H. M. Betz, jeweler, by whom he was employed. Sentence was suspended and the defendant discharged with the understanding that he was to make restitution.

Charles Elson, 316 N. 9th St., was on Saturday committed for trial by Magistrate Clement, on the charge of stealing goods from various jewelers for whom he had worked as a watch repairer. Among his victims were: Lazarus Dewitz, 122 N. 2d St., and Harris Cohen, 1705 N. 3d St.

Joralemon & Diesinger, 720 Sansom St., have entered suit against Myer Isman, to recover \$686.87, as the value of a pair of diamond earrings and a loose diamond which Isman obtained from the firm to sell as agent for them, and which, it is alleged, he sold and converted the proceeds to his own use.

Walker Hayman, watchmaker, living in West Philadelphia, who was arrested several days ago and bound over for a further hearing on numerous charges of the larceny by bailee of watches and jewelry belonging to customers, which had been entrusted to him to be repaired, was discharged by Magistrate Clement, who said he had been informed that Hayman's friends had made restitution to the losers, and that the latter desired to withdraw the prosecutions.

### Last Week's Arrivals.

*THE CIRCULAR has perfected arrangements for obtaining the names and hotel addresses of all the latest buyers visiting New York, and each day posts in its office, 189 Broadway, a bulletin which every member of the trade is cordially invited to copy.*

The following out-of-town dealers were registered in New York during the past week: E. Klein, Buffalo, N. Y., Sinclair H.; H. Keck, Cincinnati, O., Astor H.; O. Kerr, Chicago, Ill., Astor H.; H. Kohn, Hartford, Conn., Metropolitan H.; J. Karr, Washington, D. C., Gilsey H.; Mr. Hubbard, of Cowell & Hubbard Co., Cleveland, O., Astor H.; J. J. Coyne, buyer for Mandel Bros., Chicago, Ill., 55 Franklin St.; Mrs. J. C. Nourse, buyer for Woodward & Lathrop, Washington, D. C., 415 Broadway; C. Vose, Boston, Mass., Gilsey H.; C. H. Osgood, Lewiston, Me., Astor H.; M. Ernst, Cleveland, O., Astor H.; M. Bonn, Pittsburgh, Pa., Astor H.; F. Klein, Baltimore, Md., Metropolitan H.; H. H. Brandies, buyer for J. L. Brandies & Sons, Omaha, Neb., Broadway Central H.; F. M. Brown, New Haven, Conn., 108 Worth St.; J. E. Gallagher, Boston, Mass., Grand Union H.; F. T. Brown, Boston, Mass., International H.; A. K. Hawks, Atlanta, Ga., Astor H.; C. G. Case, Hartford, Conn., Broadway Central H.; A. M. McDougall, buyer for Porteous & Mitchell, Norwich, Conn., Metropolitan H.; A. M. Gillum, Philadelphia, Pa., Bartholdi H.; W. P. Cole, Washington, D. C., Astor H.; A. E. Covell, Pawtucket, R. I., Astor H.; C. G. Wells, New Haven, Conn., Imperial H.; I. Wolf, San Francisco, Cal., Marlborough H.; J. Lowengardt, of M. Scooler, New Orleans, La., Marlborough H.; J. E. Hill, Boston, Mass., Astor H.; F. F. Morrill, Boston, Mass., Astor H.; J. Levi, Baltimore, Md., Metropolitan H.; W. L. Blair, Philadelphia, Pa., Astor H.; J. H. Cox, Washington, D. C., Astor H.; J. H. Crosby, of Greenleaf & Crosby, Jacksonville, Fla., St. Denis H.; J. Bennett, Philadelphia, Pa., Broadway Central H.; H. Franks, Chicago, Ill., Morton H.; W. P. Gordon, Boston, Mass., Grand Union H.; H. Nelson, Boston, Mass., Grand Union H.; E. A. Wilson, Boston, Mass., Metropolitan H.; W. J. Rood, Boston, Mass., Park Avenue H.; C. S. Holland, Chicago, Ill., Grand H.; J. A. Williams, Boston, Mass., Everett H.; R. Harper, Philadelphia, Pa., Ashland H.; J. Furgeson, St. John, N. B., Astor H.; A. Davidow, Wilkesbarre, Pa., Murray Hill H.; Mr. Thomas, Galveston, Tex., D. L. Solomon, Roanoke, Va.

Traveling men in St. Louis, Mo., last week included: H. H. Jacobson, Jacobson Bros.; H. J. Rolfe, Wilcox Silver Plate Co.; Charles White, Randel, Baremore & Billings; Millard Veit, Marx, Veit & Co.; Leon Sichel, Eichberg & Co.; Arthur Ware, Wm. Demith & Co.; Maj. Marschuetz, Spencer Optical Mfg. Co.; B. Hyman; and T. W. Franke, Wood & Hughes.

## Our Traveling Representatives



Traveling representatives may consider these columns open for the publication of any news or items of interest regarding themselves or their confreres.

**T**HE attractive and genial personality of J. E. Simonson, representative of A. J. Hedges & Co., New York, is well known to a large number of the readers of this journal, having been for twenty years identified with the jewelry trade, and possessing a wide circle of friends both among the dealers and travelers. In 1873 he was engaged as office boy by Horace Bedell, of McIntire, Champenois & Bedell, 21 Maiden Lane. In 1876 he made his first trip east, being introduced to the trade by H. Elcox. After traveling in this territory for some time, he left the old firm mentioned and engaged with Shoemaker, Pickering & Co.,

attending to their New York office for a time and subsequently traveling west for them until 1883 when he went with A. J. Hedges & Co., to travel west, which he has done till the present time. When off the road he

spends his time in the office or factory. Though not a practical jeweler, he possesses decided talent as a designer, many of his conceptions being remarkably beautiful and salable. Mr. Simonson is in his thirty-fifth year, having been born on Dec. 1st, 1858, in Newark, N. J. He received his education in a private school and in the New Jersey Business College. In 1880 he married Miss Matte Gager, daughter of Commodore E. V. Gager, of Newark, and has one child, a bright girl six years of age. The subject of this sketch was one of the founders of the Brotherhood of Traveling Jewelers and has been a member of the executive committee of this organization since its establishment. He is also a member of the Jewelers' Club of Philadelphia.

The following in regard to Detroit traveling salesmen will be of interest. George L. Lowe, Kennedy & Koester, is traveling through the Upper Peninsula; Hal Hurlbut, Burt & Hurlbut Co. started out last Monday; Eugene Deimel has been without a salesman all Summer, but will start one out this week; the United States Optical Co. will start out their five salesmen as soon as they are moved into new quarters.

Among the traveling salesmen in Wilmington, Del., last week were: W. H. Guyer, the Waterbury Clock Co.; C. H. Anderson, M. B. Bryant & Co.; H. Rhoads,

Simons, Bro. & Co.; L. W. Rubenstein, Rubenstein Bros.; Ben. H. Lyon, G. S. Lovell Clock Co.

The following traveling salesmen passed through Detroit, Mich., last week: Mr. Harris, Ansonia Clock Co.; Mr. Rogers, Parks Bros. & Rogers; Mr. Pettee, Waterbury Clock Co.; Mr. Bell, Bell & Cobb, Mike Lambert, H. Zimmern & Co.; Mr. Goldberg, Payton & Williams; A. O. Waterman, Pairpoint Mfg. Co.; George D. Munson, Wm. Rogers Mfg. Co.; Richard D. Ledig, for Reinhold G. Ledig; Mr. Winship, T. B. Clark & Co.; William Matschke, Kuhn, Doerflinger & Co.; Matthias Stratton, Jno. W. Reddall & Co.; Mr. Swift, Charles N. Swift Mfg. Co.; George White, Wm. S. Hicks' Sons; George W. Mabie, Mabie, Todd & Bard; Maurice Powers, Powers & Mayer; E. Todd Jr., Ed. Todd & Co.; J. M. Neefus, E. N. Welch Mfg. Co.; W. H. Gregory, Strobel & Crane; Charles F. Ketcham, Riker Bros.; N. A. Copeland, Martin, Copeland & Co.; Robert Welch, Welch & Miller; John H. Curran, Cox, Cooper, Ward & Young; W. C. Coombs, E. F. Sanford & Co.; and Luther Hyde, Reed & Barton.

The following traveling salesmen passed through Indianapolis, Ind., last week: F. H. Gladding, Gladding & Coombs Bros.; W. T. R. Miller, H. E. Connolly & Co.; Fred. L. Pettee, Waterbury Clock Co.; S. W. Granbery, W. G. Clark & Co.; Mr. Oakley, Thornton Bros.; Mr. Fowler, Fowler Bros.; Mr. Mount, T. Quayle & Co.; F. B. Lawton, S. B. Champlin & Son; J. M. Phillips, Hamilton & Hamilton, Jr.; J. S. Platt, Foster & Bailey; Leo O. Cowell, Cowell & Hall Mfg. Co.; Geo. B. Caldwell, Plainville Stock Co.; E. M. Blake, Barden, Blake & Co.; F. N. Vaslett, Fletcher, Burrows & Co.; Mr. Harris, R. L. Griffith & Son; Alfred Frank, Herzog, Goldsmith & Frank; L. Bernheim, L. Weil & Co.; Mr. Pyle, A. F. Towle & Son Co.; Mr. Freedman, Bachrach & Freedman; Mr. Smith, Kent & Stanley Co.; Wm. Solomon, J. J. Cohn; Wm. W. Middlebrook, B. A. Ballou & Co.; T. B. Ettinger, Keller, Ettinger & Fink; A. C. Stearns, Roy Watch Case Co. W. F. Adams, with Simpson, Hall, Miller & Co.'s Chicago house, returned from his western trip to celebrate Chicago Day at the Fair and left the next day for his territory.

C. F. Willemin, of H. Muhrs' Sons' ring and thimble department, left Chicago

Wednesday night for the west. Harry Schimpf, with the same house, cut short his pleasure trip to the Fair on account of illness.

Geo. T. Howard, representing the Towle Mfg. Co. in the south, returned to Newburyport, Mass., via Chicago, spending a week in the latter city.

The Commercial Travelers' League organized a few days ago owes its formation to the Commercial Travelers' Club, 15 W. 31st St., New York, in which representatives of the New York jewelry houses form a large contingent. The objects of the league and the club are to obtain a uniform mileage rate and special concessions for travelers in regard to baggage. At the dinner at the Fifth Avenue Hotel which followed the formation of the League Col. George B. McClellan, President of the Board of Aldermen, represented the Mayor, and there were letters from Senator Platt, George Gould, Chauncey M. Depew, Grover Cleveland, and many others. As the object for which the League is working will directly benefit all houses employing travelers, it deserves and will no doubt receive the hearty support of all the large firms of the country.

Mr. Abbey, E. Ira Richards & Co., and Mr. Rogers, Hayes Bros., were last week in Pittsburgh, Pa., and attended the Douglass-Whitaker wedding Oct. 4.

James Brown, traveler for G. B. Barrett & Co., will marry Miss Sadie Reed, October 11. The wedding will be a quiet affair at the residence of the bride's mother, Rev. Mansell officiating.

Wm. H. Reinhardt, formerly of Reinhardt & Co., Pittsburgh, Pa., is now traveling for Grafner Bros., same city.

The Cincinnati salesmen who have returned from the road are H. C. Pfaffle, O. E. Bell & Co.; Harry Martin, A. G. Schwab & Bro.; Is. Schroder, D. Schroder & Co.; A. J. Augustine and Cliff Miller, Duhme & Co.; Rabe Hawkins, for C. Hellebush; R. E. Kramig, H. Keck Mfg. Co. They will all restart on a new trip this week.

Some of the traveling salesmen in Springfield, Mass., last week were: J. H. Beckwith, J. H. Fink & Co.; Mr. Supple, for Wm. B. Durgin; A. N. Dorchester, Kent & Stanley Co.; William H. Jones, Larter, Elcox & Co.; W. S. Campbell, Day & Clark; C. T. Dougherty, Sexton Bros. & Washburn.

## Gold Plated Enamel Tableware,

ABSOLUTELY NEW.

I control the line of Gold Plated Enamel Ware, including Coffee, Tea, and thirty varieties of larger Spoons. These are beautiful goods and at a price that places the Enamel Ware within the reach of all, for practical use. Designs and finish equal to Sterling Silver Enamel Goods. Send for samples.

### SOPHUS SAMSON,

ROOM 802, COLUMBUS MEMORIAL BUILDING,

CHICAGO, ILL.

# Waltham Repeaters,

STRIKING HOURS AND MINUTES.



TO THE TRADE



HAVING PURCHASED THE ENTIRE REMAINING STOCK OF **Waltham Repeating Movements** FROM THE **American Waltham Watch Co.**, AND CASED THEM IN **20 year 14k. Cases**, I AM PREPARED TO SELL THEM AT PRICES 30 PER CENT. LESS THAN THEY HAVE EVER BEEN OFFERED BEFORE.

Artistic Special Catalogue Free. Send for Prices and Terms.

## JOHN B. YATES,

21 and 23 Maiden Lane,

NEW YORK.

## News Gleanings.

Andrew J. Littcer, Bedford, Ia., has sold out.

J. W. Straughan, Hickman, Ky., has sold out.

E. L. Dunham, Greeley, Col., is reported sold out.

J. D. Perry will open a jewelry store in Houlton, Me.

August Bruder, Ft. Wayne, Ind., has left for New York.

L. W. Lewis has opened a jewelry store in Antioch, Ill.

F. H. Alford has opened a jewelry store in Honeoye, N. Y.

H. J. Vincelette, Clinton, Ia., has given a bill of sale for \$500.

L. Stevenson, New Whatcom, Wash., will discontinue business.

H. M. Gabriel, St. Augustine, Fla., has gone out of business.

Mr. Willets will engage in the jewelry business in Poultney, N. Y.

J. C. Tilton, Davenport, Ia., has given a chattel mortgage for \$2,500.

E. P. Durando & Co., Chattanooga, Tenn., have sold real estate for \$2,000.

A judgment for \$219 has been entered against L. Crawley, Buffalo, N. Y.

The store of A. O. Oberholzer, Centerburg, O., was burned out last week.

F. A. Robbins, Pittsfield, Mass., opened his remodeled store on last Tuesday.

Martin C. Conley, Saginaw, Mich., has renewed a chattel mortgage for \$377.

H. N. Crane, Mount Pleasant, Ia., has given a real estate mortgage for \$1,600.

George W. Weaver is in possession of the stock of C. G. Brown, Lockport, N. Y.

The Silver Polish Co., of Toledo, O., with a capital stock of \$10,000 have incorporated.

Two judgments aggregating \$232 have been entered against Mary Stapf, Dunkirk, N. Y.

P. A. Goodnough, jeweler, Union City, Pa., was last week married to Miss Nellie Marker.

The Manhattan Silver Plate Co., Lyons, N. Y., commenced running on full time the past week.

F. E. Brodie, of Lexington, S. C., has opened a jewelry store in Spartanburg, same State.

J. H. Havill, jewelers' auctioneer, is selling off the stock of J. C. Watts & Co., Saginaw, Mich.

Frank H. Wells, Syracuse, N. Y., has made a general assignment for the benefit of creditors.

F. G. Bartram, who opened a jewelry store in Wilmington, Del., last Spring, has sold out at auction.

The Nielson Jewelry Co., Fred. Nielson, proprietor, Logan, Utah, has assigned, with liabilities of \$1,200.

J. H. Park, Big Springs, Tex., has opened a branch store at Midland, Tex., under the firm name of Marshall & Park.

M. Taylor, of the W. F. Main Jewelry Co., Iowa City, Ia., is back from a short business trip to Cedar Rapids.

The trustee's sale of the stock of J. B. Capron, Bridgeport, Conn., was advertised last week to take place Oct. 10th.

The store of W. C. Pfaeffle, Fort Worth, Tex., has been sold out at auction upon the order of the trustee, R. N. Denham.

Andrew Conrad, in the jewelry business in Rochester, N. Y., was married recently to Miss Rose Fletcher, of Utica, N. Y.

Edward Mason, who was in the jewelry business with C. Cousens, Morrisville, N. J., has started in business on his own account.

J. C. Koegel, Fort Wayne, Ind., has returned from Cincinnati with a stock of jewelry. He is fitting up a store room at 173 Broadway.

Two judgments aggregating \$243 have been entered against C. G. Christopherson, of Carpenter & Christopherson, Buffalo, N. Y.

Miss Mabel Wells, who has been employed in F. A. Knowlton's store, Worcester, Mass., was married to Herbert P. Hopkins on Thursday evening.

George Keitz, Wilmington, Del., is spending ten days at the World's Fair. H. E. Thomas, of the same city, has returned from a two weeks' visit to the Fair.

Seventy-five standard and two hundred souvenir badges made by Chas. G. Willson, Reading, Pa., for the Neversink Fire Co., are on exhibition in one of his windows.

W. T. Beans, of Beans & Keck, Glenwood Springs, Col., has sold his interest to B. Schmidt, of Memphis, Tenn., and the business will be continued by Keck & Schmidt.

Joseph Monsie, a Polish jewelry pedler, was murdered some days ago a mile south of Mount Vernon, Ky., by two negro tramps. Robbery was the purpose of the crime.

The jewelry stock of C. A. Mabie, Holley, N. Y., was sold out last week by Sheriff Rice, of Albion, to satisfy two judgments amounting to \$385. Hardin Beebe bid in the stock.

Lizzie Davis, convicted of stealing a diamond ring at the store of R. P. Thorn & Son, Albany, N. Y., was sentenced last Saturday to Auburn prison for two years and three months.

The jewelers of Saratoga Springs, N. Y., will close their stores at eight o'clock every night, except Saturday and the holidays, beginning Oct. 1st; every night at six o'clock beginning Jan. 1st.

The death occurred last week of Mrs. Clair M. Voirol, wife of Frank A. Voirol, watchmaker, who is engaged with his son, Frank J. Voirol, in the jewelry business at 164 Calhoun St., Ft. Wayne, Ind. Death was due to stomach trouble.

John Simonton, a young man engaged in the jewelry business in Washington, N. J., shot himself a few days ago. He was insane through grief over the death of a child. His wife survives him.

George W. Ludwig, Chambersburgh, Pa., has secured the services of Harry E. Bemis, of Spencer, Mass. Mr. Bemis is in business for himself in Spencer, Mass., for seven years, and for the past three years worked in Denver, Col. He is a workman of high skill, being a diamond setter, watchmaker engraver and optician.

Parties from Moreno and Colton, Cal., returning from Lytle Creek, have filed a claim upon a large deposit of onyx found there. It is said to be of finer quality as regards texture and color than any other in the United States, and exists in large quantities. The deposit is on the North Fork of Lytle Creek above the Sliuce mine.

Superintendent Burns, of the Rio Grande R. R. Co. has appointed the following licensed watch inspectors for that system: H. P. Nagle and A. B. Ingols, Denver; M. F. Warren, Colorado Springs; Chas. Otero and H. Schenkein & Son, Pueblo; H. W. Cunningham, Trinidad; D. F. Connell and A. A. Carpenter, Salida, all of Colorado.

The affairs of S. Kaufman, an auctioneer and jeweler of Savannah and Atlanta, Ga., and of Birmingham, Ala., are in the hands of a receiver. A despatch from Atlanta says that Kaufman had given a chattel mortgage on the stock in that city to the Capitol State Bank and a second mortgage for \$700 to Henry Stearns. The Birmingham stock has been attached for \$1,200.

Three strangers entered the jewelry store of J. H. Burk, 708 Edmond St., St. Joseph, Mo., late last Monday afternoon and while one of them engaged the clerk's attention the other two reached under a counter on the opposite side of the room and extracted from the money drawer \$3.90. The robbery was not discovered until after the strangers had disappeared.

## Pittsburgh.

M. Bonn is east purchasing Fall stock.

G. Miller has started in business on Ohio St., Allegheny.

Herman Cerf, of M. Bonn & Co., and Mrs. Cerf, have returned from a pleasant trip through the west.

Carl D. Smalley, formerly with Joslin & Park, Denver, Col., is now connected with W. W. Wattles & Co., this city.

Buyers in town last week were: John Linnenbrink, Rochester, Pa.; Mr. Luce, Perryopolis, Pa., and H. H. Weylman, Kittingan, Pa.

F. R. Stoner, attorney for the creditors of Reinhardt & Co., is endeavoring to show criminal negligence on the part of Mr. Wilcox, assignee, for an amount a little below the appraised value which was in the neighborhood of \$8,000. Mr. Stoner further alleges that goods were disposed of at a sacrifice. The appraisers were Charles T. Ahlborn and Henry Barrett.

The Latest Patents.

ISSUE OF SEPTEMBER 26, 1893.

505,432. COVER-FASTENING FOR POTS. CARL J. P. BIENGRABER, Hamburg, Germany.—Filed Apr. 5, 1893. Serial No. 469,105. (No model.)

The combination of a pot having a shoulder a²,

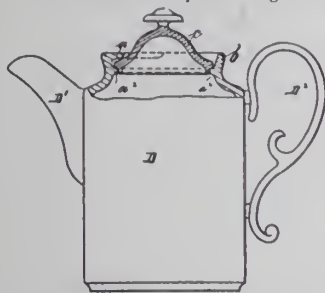

which is exposed at its rear half, with an eccentric flange which extends over the front of the shoulder and with a cover adapted to fit upon the shoulder.

505,474. WATCHCASE-PENDANT. FRITZ MINK, Philadelphia, Pa., assignor to the Keystone Watch Case Company, same place.—Filed Jan. 18, 1893. Serial No. 458,788. (No model.)

The combination with the pendant of a watch case, of a stem movable longitudinally therein, a spring projection carried by the stem, a projection carried by the

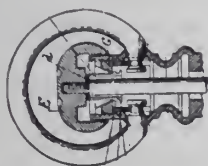

pendant upon its interior and located in the path of the spring when it is moved with the stem, and a stop independent of the spring projection carried with the stem so as to move with it and limit the upward longitudinal movement of the stem.

505,496. FACIAL MEASURE. ALBERT M. WARD, Detroit, Mich., assignor to George Johnston, same place.—Filed Apr. 24, 1893. Serial No. 471,586. (No model.)

In a facial measure, eye frames having perforated plates in connection therewith at their adjacent por-

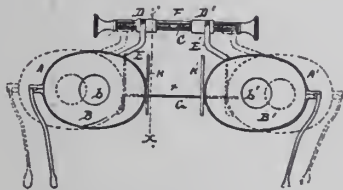

tions and extending substantially at right angles thereto, a screw to adjust said frames laterally, and a scale bar to indicate the lateral adjustment.

505,650. SPECTACLE-FRAME. ALLAN E. FRANCIS, Cleveland, Ohio.—Filed Oct. 3, 1892. Serial No. 447,749. (No model.)

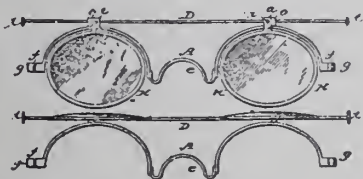

The combination of the elastic frame A, provided with hinge lugs o o having projections l l, with the lens holders H, H, having slots x, x.

505,657. WATCH GUARD OR CHAIN HOLDER. HENRY M. HENNING, Minocqua, Wis.—Filed Apr. 17, 1893. Serial No. 470,661. (No model.)

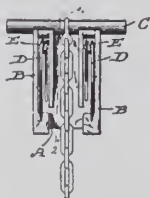

A watch-guard or chain holder comprising a suitable plate channeled upon its rear side and provided with means for detachable connection with a garment.

DESIGN 22,796. BADGE. MARTIN D. WOOD, Kansas City, Mo.—Filed May 18, 1893. Serial No. 474,714. Term of patent 7 years.

DESIGN 22,797. JEWEL SETTING. MAURICE



L. POWERS and JOSHUA W. MAYER, New York, N. Y.—Filed Aug. 16, 1893. Serial No. 483,306. Term of patent 7 years.

DESIGN 22,798. BOWL. CHARLES C. WIENGF, Providence, R. I., assignor to the Howard Ster-

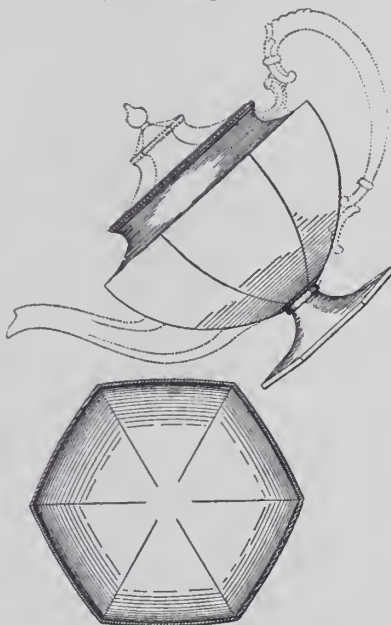

ling Company, same place.—Filed July 28, 1893. Serial No. 481,771. Term of patent 7 years.

DESIGN 22,799. DISH. SETH W. BABBITT, Meri-

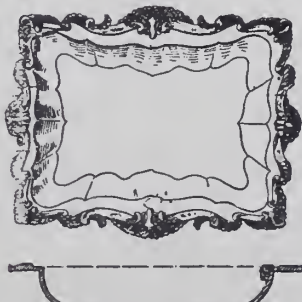

den, Conn.—Filed Sept. 4, 1893. Serial No. 484,790. Term of patent 3½ years.

Trade Gossip.

The new catalogue of O. E. Bell & Co., Cincinnati, O., will be out this week. It has a very elaborate cover embossed in colors.

Jos. Mehmert, Cincinnati, O., has received propositions from two New York firms to handle his new watch hand remover, on a royalty. It is just ready for the market and will no doubt be a ready seller.

The New York Jeweler, published by S. F. Myers & Co., 48 and 50 Maiden Lane, contains sixteen large pages which are filled with illustrations and descriptions of the various lines carried by this house. Every page of this publication contains matter of interest to the retail jeweler.

The United States Watch Co. has placed in the market a new movement, which has been designated as No. 79. The movement is an 18 size, has 17 ruby jewels in gold settings and is accurately adjusted. A double sunk dial completes the list of merits of the new time piece, which is especially intended for railway service and other uses requiring more than ordinary accuracy.—Waltham News.

The new catalogue of Richards & Rutishauser, 601 Columbus building, Chicago, has been received from the press and is a neat book of one hundred and seventy-four pages neatly bound and well printed. Eight pages are given to diamond jewelry in colors on black paper. The catalogue is the same size as the last, but there is a marked improvement in the quality of the goods offered.

The factory of J. W. Sanborn & Co., 414 Washington St., Boston, Mass., has been running full time right along and recently several new hands have been added. The house is now New England agent for F. A. Hardy & Co.'s new ophthalmometer, the improved Javal, and has added some new trial cases comprising smaller sets for physicians and others not wishing complete sets, which range in price from \$5.50 to \$38.00. Explanatory circulars will be mailed on application. Also worthy of special attention is a very full line of French spectacles and eye-glasses from the celebrated Morez factory at Jura.

The exhibition case of historical diamonds advertised by Julius Eichenberg, 174 Weybosset St., Providence, R. I., contains facsimiles of the well-known Koh-i-noor, Regent, Star of the South, Orloff, Shah, Piggott, Florentine, Nassac, Pasha of Egypt, Soucy, Polar Star, Blue Diamond and the Empress Eugenie. These stones range in weight from 40 to 279 karats, and with each collection is a complete descriptive pamphlet. The stones are not only of value to collectors, but make a most attractive article for window display, which is something every jeweler particularly desires.

The watch case business of Emil Bouquin, Newark, N. J., has been attached.

# CLASSIFIED INDEX TO ADVERTISEMENTS.

All Advertisements are entitled to one insertion under proper heading. Extra insertions, \$6.00 per annum. Extra Headings, \$12.00 per annum.

<b>Art Pottery, Bric-a-brac, Etc.</b>	Page.	<b>Gold and Silver Plating.</b>	Page.	<b>Settings and Galleries.</b>	Page.
Ahrenfeldt & Son, 56 Murray St., N. Y.....	44	Brunor Plating and Jewelry Repairing Co....		Blancard & Co., 76 John St., N. Y.....	11
Bing, Ferdinand & Co., 106 Grand St., N. Y. . .	42	Maiden Lane, N. Y.....	5	<b>Show Cases.</b>	
Borgfeldt, Geo. & Co., 18, 20 & 22 Washington		H. B., Bolstad, Plating Co., Chicago Ill.....	21	Smith, B. & W. B., 220 W. 29th St., N. Y.....	52
Place, New York.....	46, 47	<b>Gold Jewelry.</b>		<b>Silver Mounted Ebony Goods.</b>	
Bradley & Hubbard Mfg. Co., Meriden, Conn	8	Bipart & Co., Newark, N. J.....	7	Deitsch Bros., 7 E. 17th St., N. Y.....	2
Buning, F. W. & Co., 58 Murray St., N. Y. . .	50	Carter, Sloan & Co., 15 Maiden Lane, N. Y. . .	39	<b>Silver Plated Ware.</b>	
Gleanzer Leon, J. & Co., 80 & 82 Chambers		Krementsz & Co., 182 Broadway, N. Y.....	8	Homan & Co., Cincinnati, O.....	22
St., N. Y. . . . .	45	Racine Jewelry Mfg. Co., Racine, Wis. . . . .	12	Pairpoint Mfg. Co., New Bedford, Mass.....	5
Haviland & Abbott, 29 Barclay St., N. Y.....	49	Smith, C. Sydney, 191 Broadway, N. Y.....	21	Rogers & Bro., 16 Courtlandt St., N. Y.....	9
Hinrichs & Co., 29 & 31 Park Place, N. Y.....	50	Street, Geo. O. & Sons, 15 John St., N. Y.....	14	Rogers, Smith & Co., Meriden, Conn. . . . .	3
Le Boutillier & Co., 860 Broadway, N. Y.....	15	Kerr, Wm. B. & Co., 860 Broadway, N. Y.....	16	<b>Silversmith.</b>	
Levy, Dreyfus & Co., 9 & 11 Maiden Lane, N.Y	48	Uhry, Chas. L. & Co., Newark, N. J.....	5	Rohrbach, Henry J., 94-96 State St., Chicago. 37	
Scott, De B. O., 20 Murray St., N. Y.....	37	<b>Horological Schools.</b>		<b>Souvenir Spoons.</b>	
Straus, L. & Sons, 42 to 48 Warren St., N. Y. . .	19	Parson's School for Watchmakers, Peoria, Ill. 21		Alvin Mfg. Co., 860 Broadway, N. Y.....	10
<b>Auctioneers.</b>		Palmer & Swain, Waltham, Mass.....	41	<b>Sterling Silverware.</b>	
Comrie, A. J., P. O. Box 2403, New York.....	51	<b>Hotels.</b>		Campbell-Metcalf Silver Co., Providence, R. I. 38	
Firuski, S. & Son, 85 Bowery, N. Y.....	37	Gibson House, Cincinnati, O.....	27	Dominick & Haff, 860 Broadway, N. Y.....	4
Tirrell, R. W.....	14	<b>Jewelry Mailing Boxes.</b>		Durgin, W. B., Concord, N. H. . . . .	13
<b>Assayers &amp; Refiners.</b>		Am. Railway Supply Co., 24 Park Place, N. Y. 49		Knowles, J. B. & S. M. Co., Silversmiths'	
Clark, J. L., Philadelphia, Pa.....	41	<b>Jewelry, Silverware and Optical Cases.</b>		Hall, Union Square, N. Y.....	7
Howard, S. P., 8 John St., N. Y.....	52	Birmingham, Wm. & Co., 728 Arch St., Phila. 10		Ovatt & Warner, Portland, Oregon.....	21
<b>Badges, Medals, Etc.</b>		Jackson, S. C., 180 Broadway.....	11	Reed & Barton, 37 Union Sq., N. Y.....	29
Irons & Russell, Providence, R. I.....	26	Troesch, A. & Co., 69 Nassau St., N. Y. . . . .	38	Shiebler, Geo. W., Co., 179 Broadway, N. Y. . . . .	3
Schlechter, G. A., Reading, Pa.....	14	Wiggers & Froelick, 60 Nassau St., N. Y.....	38	Towle Mfg. Co., Newburyport, Mass.....	14
Stockwell, E. R., 19 John St., N. Y.....	49	<b>Jobbers, Watches, Diamonds, Etc.</b>		Wallace, R. & Sons Mfg. Co., 3 Park Place,	
<b>Chain Manufacturers.</b>		Aikin-Lambert Jewelry Co., 19 Maiden Lane. 12		N. Y.....	6
Blackinton, W. & S., Attleboro, Mass.....	31	Bowman, Ezra F. & Co., Lancaster, Pa.....	41	Wood & Hughes, 15 John St., N. Y.....	38
<b>Chronometers.</b>		Cross & Beguelin, 17 Maiden Lane, N. Y.....	11	<b>*Stem Winding Attachments.</b>	
Heinrich, H. H., 14 John St., N. Y.....	51	Giles Bros. & Co., W. H. Gleason, receiver,		Abbott, Henry, 2 Maiden Lane, N. Y.....	51
<b>Cleaning Solution.</b>		Chicago, Ill.....	26	<b>Tool Manufacturers and Dealers.</b>	
Quarters, W. F., Providence, R. I.....	7	Myers, S. F. & Co., 48 Maiden Lane, N. Y. . . . .	52	Bullock, O. W., Springfield, Mass.....	7
<b>Clocks, French and English.</b>		Yates, John B., Hays Building, Maiden Lane,		Gesswein, F. W., 39 John St., N. Y.....	12
Jacques, Chas., Clock Co., 22 Courtlandt St.,		N. Y. . . . .	33 <sup>b</sup>	Horological Tool Co., Chicago, Ill.....	27
N. Y.....	52	Young, Otto & Co. Chicago, Ill.....	21	Logan, A. J., Waltham, Mass.....	41
Kroeber F., Clock Co., 360 Broadway, N. Y. . . . .	49	<b>Leather and Silver Goods.</b>		Mosely & Co., Elgin, Ill.....	29
<b>Diamond Cutters.</b>		Deutsch Bros., 7 E. 17th St., N. Y.....	2	<b>Tortoise Shell Goods.</b>	
Humphrey, J. B., Boston, Mass.....	52	<b>Musical Boxes.</b>		Rice & Hochster, 483 & 485 Broadway, N. Y. . . . .	9
<b>Diamond &amp; Precious Stone Importers.</b>		Jacot & Son, 298 Broadway, N. Y.....	24	<b>Trunks and Traveling Bags.</b>	
Disselkoe, John N., 19 E. 16th St., N. Y. . . . .	39	Wolff, A., 194 Broadway, N. Y.....	49	Crouch & Fitzgerald, 161 Broadway, N. Y.....	40
Eichenberg, Julius, Providence, R. I.....	37	<b>Optical Goods.</b>		<b>Watch Case Manufacturers.</b>	
Falkenau, Oppenheimer & Co., 40 Maiden		Kirstein, E., Sons Co., Rochester, N. Y.....	3	Goll, Henry, 17 John St., N. Y.....	14
Lane, N. Y.....	52	Laurencot, Jules, 49 Maiden Lane, N. Y. . . . .	51	Roy Watch Case Co., 17 Maiden Lane, N. Y. . . . .	15 <sup>b</sup>
Hahn, Rud. C., 194 Broadway, N. Y.....	10	Queen & Co., Philadelphia, Pa.....	3	The Wadsworth Watch Case Co., Newport,	
Hedges, Wm. S. & Co., 170 Broadway, N. Y. . . . .	38	Sanborn, J. W. & Co., Boston, Mass.....	52	Ky.....	27
Kahn, L. & M. & Co., 10 Maiden Lane, N. Y. . . . .	52	The Winsted Optical Co., Winsted, Conn.....	50	<b>Watchman's Clocks.</b>	
Kipling, R. A., Hays Bldg., N. Y.....	38	The Nous Verrons Co., Boston, Mass.....	12	Hausburg, O. E., 41 Maiden Lane, N. Y.....	51
Lorsch, Albert & Co., 37 Maiden Lane, N. Y. . . . .	20	<b>Pens, Pencil Cases, Etc.</b>		<b>Watch and Clock Oils.</b>	
Ludeke & Power, 23 John St., N. Y. . . . .	38	Aikin, Lambert & Co., 19 Maiden Lane, N. Y. . . . .	21	Kelley, Ezera F., New Bedford, Mass.....	52
Nissen, Ludwig & Co., 18 John St., N. Y.....	38	Beaunel, D. W., 17 John St., N. Y.....	10	<b>Watch, Glasses and Spectacle Lenses.</b>	
Randel, Baremore & Billings, 29 Maiden Lane,		<b>Patents.</b>		Berger A., & Co., 47 Maiden Lane, N. Y. . . . .	28
Scott, J. T. & Co., 4 Maiden Lane, N. Y.....	41	Cox & Sons, 11 Park Row, N. Y. . . . .	10	<b>Watch Importers.</b>	
Smith, Alfred H. & Co., 182 Broadway, N. Y. . . . .	38	<b>Pocket Cutlery.</b>		Hyde's, J. E., Sons., 22 Maiden Lane, N. Y. . . . .	41
Wolff & Gunzburger, 87 Nassau St., N. Y.....	52	Beach, H. B. & Co., Boston, Mass.....	14	Mathey Bros. & Mathez Co., 21 & 23 Maiden	
<b>Diamond Jewelry.</b>		<b>Ring Makers.</b>		Lane, N. Y.....	14
Waterman & Lehman, 37 Maiden Lane, N. Y. . . . .	51	Bryant, M. B. & Co., 10 Maiden Lane, N. Y. . . . .	3	<b>Watch Keys.</b>	
<b>Enameled Tableware.</b>		Bowden, J. B. & Co., 192 Broadway, N. Y.....	7	Clark, A. N., Plainville, Conn.....	40
Sampson, Sophus, Chicago, Ill.....	37 <sup>a</sup>	Haskell, H. C., 192 Broadway, N. Y.....	14	<b>Watch Manufacturers.</b>	
<b>Eye Glass Holders and Chains.</b>		Hildreth Mfg. Co., 51 Maiden Lane, N. Y. . . . .	8	Baume & Co., London, England, and Syracuse,	
Merritt, S. F., Springfield, Mass.....	11	Larter, Elcox & Co., 21 & 23 Maiden Lane,		N. Y.....	21
<b>Fine Stationery.</b>		N. Y.....	14	Durrstein & Co., World's Fair, Chicago.....	22
Parsons, Green & Co., 18 Murray St., N. Y. . . . .	5	<b>Rolled Plate Jewelry.</b>		<b>Watch Manufacturers.</b>	
<b>Fountain Pens.</b>		Dederick, J. H., 16 Maiden Lane, N. Y.....	12	Baume & Co., London, England, and Syracuse,	
Smith, H. M., & Co., 83 Nassau St., N. Y.....	52	<b>Sample Trunks.</b>		N. Y.....	21
The Boston Pen Co., Boston, Mass.....	41	Crouch & Fitzgerald, 161 Broadway, N. Y.....	40	Durrstein & Co., World's Fair, Chicago.....	22



## Special Notices.

Rates 75c. per insertion for notices not exceeding 5 lines (25 words), additional words 2 cents each. Answers are to be forwarded, postage stamps must be enclosed. Two insertions, 15 per cent. off; three insertions, 20 per cent. off; four insertions or more, 25 per cent. off. Payable strictly in advance. Display cards on this page will be charged at \$2.00 per inch for first insertion, subject to same discount as above for subsequent insertions.

Under the heading of **Situations Wanted** on this page advertisements will be inserted for **One Cent a Word**. This offer refers to **Situations Wanted only**. Payable strictly in advance. Answers are to be forwarded, postage must be enclosed.

## Situations Wanted.

Notices under this heading **ONLY** are charged at one cent a word, payable strictly in advance. If answer are to be forwarded, postage must be enclosed.

**SITUATION** wanted as watchmaker, clock and jewelry repairer, by a single man, twenty-seven years of age. Has lathe and tools. Address Ed. S., Dresden, Ohio.

**WANTED**. A POSITION in a diamond, jewelry or fancy goods house. Have a thorough knowledge of the goods and a fair trade acquaintance. Satisfactory references. Address D. J. F., care of JEWELERS' CIRCULAR.

A **FIRST-CLASS** watchmaker wants position as good salesman. Has full set of tools. Address Waltham, care JEWELERS' CIRCULAR.

**WANTED**.—A position in New York or Brooklyn, in the jewelry or optical business. Address Box 85, Dayton, N. J.

**WATCHMAKER**, jewelry repairer and all around workman wants situation. References given. Address "Round," care JEWELERS' CIRCULAR.

**SITUATION WANTED**.—An experienced traveler wishes a position in a first-class house. Many years on the road and well acquainted in all sections east of Omaha. Diamond house preferred. Address E. D., JEWELERS' CIRCULAR.

**POSITION** by good watchmaker and jeweler; best of references. Address O. Kayler, Decatur, Ill.

**SITUATION WANTED** as watchmaker, clock and jewelry repairer; over 5 years' experience; good references. Address A. Austin Willmot, Salem, New Jersey.

**SITUATION WANTED**.—By watchmaker, jeweler and plain engraver; young man; good workman; references given. Address 23, care JEWELERS' CIRCULAR.

**BY** a first-class jeweler and watchmaker, 10 years' experience; complete set of tools; A 1 reference as to ability and etc.; wages \$15 per week. Address B., care JEWELERS' CIRCULAR.

**WATCHMAKER** capable of doing all kinds of fine Swiss and American watchwork and having a very complete set of tools desires a position in a first-class jewelry house in one of the eastern States. Salary \$18. Address W. W., care JEWELERS' CIRCULAR.

**I AM A GOOD WATCHMAKER** and wish a good situation. Samuel L. H. Simpson, Winona, Minn.

**SITUATION WANTED** by a competent watch maker and optician; licensed railroad watchmaker 7 years for one of the largest railway systems; best of references; position as optician and salesman preferred. Address W. S. L., care JEWELERS' CIRCULAR.

**YOUNG MAN**, 27, good practical and theoretical optician, desires to connect himself with a good house, to take charge of optical branch and learn watch repairing; A 1 salesman; first-class references; New York or vicinity preferred. Address X Y Z, care JEWELERS' CIRCULAR.

**POSITION WANTED** as watchmaker, jewelry repairer, salesman and general charge of store; fully competent for either branch; have lathe and full set of tools. Address W. C., Box 67, New York Mills, N. Y.

**SITUATION WANTED** by a first-class jeweler, with fourteen years' experience. Had own business. Can do acid color and battery gilding, also do repairing, &c. Can turn hand to everything. "Greek," JEWELERS' CIRCULAR.

## Help Wanted.

**WANTED**.—A first-class watchmaker; must give good references as to competency and character. Bennett & Gusselman, Urbana, O.

**WANTED**.—A thoroughly competent WATCHMAKER and JEWELER; one who can do engraving also, preferred; none but strictly first-class workmen need apply; must be temperate, and come well recommended; a permanent place to the right man. Address "South Carolina," care JEWELERS' CIRCULAR.

**WANTED**.—Experienced traveling salesman to carry a leading and well-known line of spectacles and eye-glasses; samples easily carried; liberal commission. Address Optics, care JEWELERS' CIRCULAR.

## For Sale.

**FOR SALE**—A spectacle and thimble plant long established. Good set of machinery and tools, with power, all in fair condition. Price \$3,000, with liberal discount for cash. Continued ill health the reason for selling. For particulars inquire of Gustave Walters, 33 Maiden Lane, New York.

**FOR SALE**.—Well established jewelry and optical business; in a Virginia city of about 30,000 population; best location in city; rent \$500 per annum; store 15 feet wide and 40 feet deep; in good condition. Nice clean stock, no old or undesirable goods; stock inventory about \$4,500; fixtures, materials, tools, safe, etc., about \$1,500; fine Hall's fire and burglar proof safe; Webster Whitcomb lathe and all tools in good shape; best business city in the south; sales in 1892, over \$8,000 and profits over \$3,000; business could be easily doubled by an energetic wide awake man; am compelled to change business on account of failing health. Address at once Jeweler and Optician, care of JEWELERS' CIRCULAR.

**FOR SALE**.—At Cleveland, O., a watch and jewelry business. Wishing to retire on account of failing health. I am obliged to sell my business; a good opportunity to purchase a business established over twenty-five years; central location; clean stock; plenty work; stock and fixtures invoice about \$3,000; terms cash. Address R., Lock Box 89, Cleveland, O.

## FOR SALE.

### THE JEWELRY MANUFACTURING PLANT

of the late Walter E. White, located at 86 Page St., Providence, R. I., consisting of machinery, tools, fixtures, stock, good will, etc.; to parties desirous of engaging in this business the well-known popularity and standard quality of the goods always manufactured by this firm makes this an exceptional opportunity, and one that rarely offers. Apply to WM. G. HOPKINS, Administrator, 53 Clifford St., Providence, R. I.

### TRUSTEE'S SALE.

THE undersigned will sell privately upon most advantageous terms to purchasers, either as a whole or in such parts as may be desired, the stock of jewelry and store fixtures of James E. Tyler, 807 East Main Street, Richmond, Virginia, said stock being in point of extent, selection, quality and variety unsurpassed in the South. Arrangements can be made, if desired for the purchase of the good will of the business of James E. Tyler, who with his predecessors, John H. Tyler & Co., Mitchell & Tyler and William Mitchell, Jr., has conducted in the City of Richmond the jewelry business for the better part of this century, and has always commanded the cream of city and State custom. Richmond presents at this particular time an exceptionally fine opening to persons desiring to embark in the jewelry business under such auspices. Correspond with John Pickrell, Trustee, State Bank Building, Richmond, Va.

## Miscellaneous.

**I BUY JEWELRY STOCKS**—Manufacturers, jobbers and retailers desiring to dispose of surplus or entire stocks of diamonds, watches and jewelry can find quick cash buyer by addressing Stephen S. Harmon, 134 East 96th St., New York city.

**WANTED**.—A few more students to learn engraving at Trowbridge's School of Engraving, Winona, Minn. Lowest rates of any school. Board to be had for a low figure. New term starting.

### DEMAGNETIZING.

**PERFECT WORK**—Watch repairing in all its branches; all work warranted. Winslow & Penney, 608 Masonic Temple, Chicago.

A **COURSE** of engraving at Trowbridge's School of Engraving, Winona, Minn., is what you want. Write for terms which are the lowest of any engraving school. Board to be had for less than in large cities.

## PAWNBROKERS' SALES

BY

### S. FIRUSKI & SON,

AUCTIONEERS,

85 Bowery, New York,

AT 11 A. M.

See N. Y. Herald for full particulars of Sales.

The Trade is Respectfully Solicited to Attend.

## If Your Sales

## Are Not Satisfactory

ADDRESS

### DE B. O. SCOTT,

20 Murray Street, New York.

AUCTIONEER.

Specialties: Watches, Clocks, Bric-a-Brac, &c.

Write for particulars and references.

## Excellent For Window Display.



Size, 6x10 Inches.

Fac-Similes of the World's Historical Diamonds, Leather Cases, Velvet Lined, each Stone named. Price complete, \$10.00.

### Julius Eichenberg,

Precious and Imitation Stones,

174 Weybosset St., Providence, R. I.

WHITE AND JOBBING STONES.

—SPECIAL INDUCEMENTS TO MANUFACTURERS AND JOBBERS.—

## HENRY J. ROHRBACH,

94-96 State Street,

Room 524, CHICAGO.

SILVERSMITH AND MANUFACTURING JEWELER,

GOLD, SILVER AND NICKEL PLATER.

Silver and Silver-Plated Ware of all kinds Repaired, Refinished and Polished at Low Prices.

SEND FOR PRICE LIST.

ALL KINDS OF BRONZES

REPAIRED AND REBRONZED.

Full facilities for manufacturing and repairing all classes of Jewelry for the Trade.

Remember—Room 524.

**DIAMONDS.**

**Wm. S. Hedges & Co.,**  
**Importers of Diamonds,**  
 And Manufacturers of DIAMOND JEWELRY.  
 170 Broadway, New York.  
 27 Holdorn Viaduct, London.



**R. A. KIPLING,**  
 Importer of

**PRECIOUS STONES,**

21 & 23 Maiden Lane,

19, RUE DROUOT, New York.  
 PARIS.

**Alfred H. Smith & Co.,**

IMPORTERS

**DIAMONDS**

AND

PRECIOUS STONES,

182 BROADWAY, COR. JOHN STREET,  
 NEW YORK.

53 Holborn Viaduct, London, E. C.

**CAMPBELL-METCALF SILVER CO.**



176 Broadway, N. Y., Room 14. 66 Stewart St., Prov., R. I.  
 Mills Bldg., San Francisco, 8th Floor, Room 1.



Patent applied for

Victoria Novelties, many fancy shapes.  
 Celluloid Top, Sides, Bottom and Cushions  
**A. TROESCHER & CO., 69 Nassau St., N. Y.**

**LUDEKE & POWER,**

IMPORTERS OF DIAMONDS

AND OTHER PRECIOUS STONES,

ADOLPH LUDEKE,  
 CHAS. L. POWER.

23 JOHN STREET, N. Y.

**WOOD & HUGHES,**  
**STERLING SILVERWARE MANUFACTURERS**

New York Agents for the Derby Silver Co.'s  
 FINE QUADRUPLE PLATED WARE,  
 NO. 16 JOHN STREET, NEW YORK  
 206 Kearney St., San Francisco, Cal.  
 HASKELL & MUEGGE, Agents.

**WIGGERS & FROELICK,**  
 60 NASSAU ST., NEW YORK.

**Sample Cases and Trays**  
 For Watches, Jewelry, Optical Goods, Etc.

**WE STRIVE TO MAKE THE BEST.**

**Omaha.**

C. A. Weidlich, Waterbury Watch Co., was in this city last week.

F. E. Hewitt, of the Johnston Optical Co., Detroit, Mich., has been in the city for a week past, having been on the sick list. Mr. Hewitt has also been representing since August the Campbell-Metcalf Silver Co., Providence.

Sol Bergman, who recently returned from a trip to New York and Chicago, reports two firms started in Nebraska and Kansas: W. S. Conard at Hastings, Neb., and Butler Bros., at Cherryvale, Kan., they having been in Omaha the some days ago purchasing stock. Mr. Conard was formerly with O. C. Zinn, of Hastings.

A fire on the 3d inst. consumed the Farnam St. Theatre block. Among the firms in the building was N. M. Ruddy, dealer in optical goods. The building was completely gutted, and Mr. Ruddy loses almost his entire stock. He was, however, insured to the amount of \$3,000. He has not yet decided what arrangements he will make about opening up again. W. O. Saunders, watchmaker, was also established in the same building; he carried no stock, but lost most of his tools, and a few watches and clocks left with him for repairs. He had no insurance.

A man representing himself as a diamond drummer, registered about two weeks ago at the Mercer Hotel as Alf. W. Heidenreiter, of Chicago. Last Monday he was reported missing at the hotel and his whereabouts have not yet been discovered. Inquiry among the local jewelry houses elicited the information that he had not called on any of them, and that he was not at all known to the trade. Inquiry in Chicago has discovered his boarding house at 95 37th St., where it was said that, having lost his position in the repair department of Studebaker Bros.' carriage store, he had obtained a position as traveling salesman for a wholesale jewelry house.

**Monthly Meeting of the Jewelers' League.**

At the regular monthly meeting of the executive committee of the Jewelers' League held at the League Office, New York, Friday, Oct. 6th, there were present Messrs. Bowden, Grcason, Jeannot, Untermeyer, Van Deventer and Sexton. Three requests for change of beneficiary were granted, and the following persons were admitted to membership:

G. W. Marquardt, Jr., Des Moines, Ia., recommended by Wm. S. Sparrow and Martin Teetor; Gustav H. Wormuth, New Orleans, La., by A. Sirjacques and Wm. B. Young, and C. E. Snyder, Pittsburgh, Pa., by A. H. Gerwig.

L. F. Giering, Bethlehem, Pa., has been awarded the contract to keep in repair the clocks in all the shops, stations, offices and locomotives of the Lehigh Valley Railroad between Jersey City, N. J., and Pittston, Pa.

**Fashions in Jewelry and Silverware.**

A LADY'S RAMBLES AMONG THE JEWELERS.

Entree dishes of polished silver plate with beaded edge are provided in view of the hospitable season.

The envelope moisteners will soon persuade us that it is very vulgar to seal letters by applying the tip of the tongue.

Small diamonds are never used to more advantage than in the dainty flower wreathed brooches that are in vogue.

The obsolete castor reappears in a sort of temple on one leg with niches in which the glass bottles are enshrined like gods.

Odd pieces of table and toilet silver are appreciated, such are hot water jugs, silver bread platters, muffineers, toast racks and egg boilers.

Most beautiful silver bowls for cracked ice or flowers are shown this season. They have waving shell-like ridges with richly wrought broken edges.

A curious piece was seen the other day. It was a botanic cheese pot, mounted like a brass coal scuttle at an angle, on a stand with a rest for the cheese scoop.

Bursting suns, the diamond stars of the last season are seen in a new variety. This can only be described as a bursting sun struck by lightning. The rays are jagged with sharp angles. The effect is novel and even pretty.

West Point buckles are reproduced in silver and silver-gilt. These are solid and frequently plain, except for the engraved monogram which, however, is made highly ornate. Navy buckles, on the other hand, have some appropriate insignia.

Brush trays seem to recommend themselves as necessities. They are of ivory with oblong compartments at either end for the brushes. The square compartment in the center is floored with a mirror, and into this the round brush for the hair, hat or velvet may be dropped.

There are interesting designs in dinner table lines. In one, on a tree branch perches an owl. Another is of overlaying grape leaves and fruit. Beautifully modeled leaves are applied to jugs, and animals in low relief and plain surfaces are thrown out from hammered back grounds. Old coins as ornamental disks are treated in the same manner.

The scarf-pins for the coming season are more desirable than ever. One is a flying dove with a pearl body and diamond wings. Another is a toad with a body of seed pearls and spots of olivine. The bug world does not seem so supreme now as during the Summer when their appropriateness is more apparent, but designs with a central jewel and surrounding gems are more common. There are, however, many beautiful floral forms such as tiny jeweled sprays.

ELSIE BEE.

ESTABLISHED 50 YEARS.

RANDEL, BAREMORE & BILLINGS,

IMPORTERS OF

DIAMONDS,

AND OTHER PRECIOUS STONES.

FINE PEARLS A SPECIALTY.

MANUFACTURERS OF

DIAMOND JEWELRY,

IN THE LATEST DESIGNS.

Diamonds Recut in Modern Styles or Repaired on Premises.

58 Nassau Street,  
29 Maiden Lane  
NEW YORK.

1 Tulp Straat,  
AMSTERDAM.

1 St. Andrews St.,  
Holborn Circus,  
LONDON, E. C.



TRADE MARK.

ESTABLISHED 1841.

CARTER, SLOAN & CO.,

MANUFACTURERS OF GOLD JEWELRY,

No 15 MAIDEN LANE,

NEW YORK.

A. CARTER, JR.  
A. K. SLOAN.  
C. E. HASTINGS.

GEO. R. HOWE.  
WM. T. CARTER.  
WM. T. GOUGH.

FACTORY, NEWARK, N. J.



JOHN N. DISSELKOEN,  
Cutter and Importer of  
DIAMONDS

FACTORY,  
76 LANGEBLEEKERSPAD,  
AMSTERDAM.

19 East 16th St.,  
NEW YORK.



### To Drill Exactly Through the Center of the Arbor.

BY CLAUDIUS SAUNIER.

If the old arbor nut is available it will, of course, afford the best guide for performing this operation, and if the arbor is tapped, such a hole will not be required. But when neither of these conditions is satisfied, the workman will have two slight difficulties to overcome; the drilling of the arbor and its nut exactly in the center and parallel to the plane of the ratchet. By adopting the following method, he can easily satisfy these conditions:

Take a brass disc D, fig. 1, turned smooth on its two faces. Enlarge its central hole until the barrel arbor enters it to such a

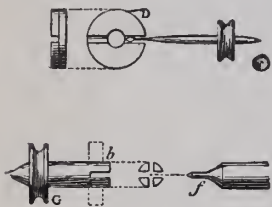

FIG. 1.

distance that a blow of a mallet will drive it up against the ratchet where it should hold firmly. This disc is chucked on the wheel-

cutting engine, and a groove is formed that passes exactly through the center, using a hinged cutter frame, or advancing the frame by a screw. Ascertain by means of a douzieme or a thickness gauge whether the thickness of the disc, measuring from the the bottom of the groove to the under side, is equal to the space between the shoulder of the arbor that corresponds to the outside edge of the barrel hole and the point at which the hole should be drilled.

If the thickness is excessive, diminish it from the under side; if, on the other hand, it is not sufficient, fit some thin discs on the arbor, and then force the brass disc to the position thus determined upon. It is hardly necessary to add that when this is done, holes must be drilled to some depth on either side of the arbor, using a drill that does not shake about in the groove, although quite free and inclining slightly downward so that the hole shall not be above the point determined upon, namely, the bottom of the groove. Continue the drilling until the two holes meet, the drill being maintained during this part of the operation, parallel to the face of the ratchet.

If the workman is not provided with a

tool for cutting the groove exactly in the axis of the disc, the accuracy that is so essential can be insured as follows: A brass rod G, fig. 1, is divided into four at the end as near the center as possible by means of a fine saw or a file that only cuts with its edge, which will be used to form the groove. Set the rod G in the turns, a center of the form *f* being inserted at *b* where the slits cross, and turn down the rod G *b* although only a little metal should need to be removed, until it enters the hole in the brass disc and projects a short distance on the other side. It then only remains to insert in one of the notches of G *b* the cutting file or the saw previously used, to form a groove on the surface of the disc that passes exactly through its center; it is to be carefully remembered that the saw, etc., must only cut with its edge, and should enter the notch with a very slight friction, sufficient to indicate that it fits without play.

*The diameter of the arbor nut.*—The usual practice is to make the diameter of the nut equal to one-third that of the inside of the barrel. With thick springs of but slight flexibility, it must be larger so as to avoid over-straining the innermost coil, and, conversely, with a very thin spring it is diminished, rendering the employment of a longer spring possible. When the nut is too small the spring must be made long, and, by setting up the stopwork, a coil of the spring can be maintained always on the nut.

For drilling the nut along a diameter by means of the rod G, fig. 1, draw a straight line to indicate a diameter of the nut. This line will serve as a guide for making two

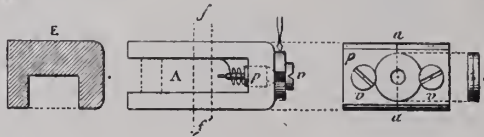

FIG. 2.

points opposite to one another on the circumference round which a circle has previously been traced with a graver; one such point is seen at *n*, fig. 2. The point should be marked so deeply as to insure that the drill does not displace itself in the initial stages of the drilling; with a little caution and using a glass, very little difficulty will

be experienced in insuring that the points are in a right line. One of the following methods may be employed for drilling the nut:

1. Prepare a brass block of the form shown at *f* *β*, *f*<sup>1</sup>, fig. 2, the space A being cut away, and the end, *β*, provided with large headed screws shown at *v v*, in the plan. The two faces, *f* *f*<sup>1</sup> must be parallel to each other, and at right angles with the face *β*, a condition which can be easily satisfied by means of the mandril; the face *f*<sup>1</sup> for example, being turned toward the headstock, and the dogs introduced into the space A, the opposite face, *f*, is then trued with the slide rest. If a mandril is not available, drill two holes in the direction indicated by the dotted lines *f* *f*<sup>1</sup> and turn the two external faces flat in a pair of turns. In the vertical face, *a a*, make a round hole through which a pointed center passes, being pressed forward by a spiral or other spring, and the point corresponding exactly with the line, *a a*, traced on the face of the brass; of course the axis of this center must be at right angles to the same line. A small block may be inserted within the space A to prevent any flexure of the arms.

An inspection of the figure will make clear the manner in which this little tool is to be used. Having fixed the nut on the face, *β*, by the screws, *v v*, so that the two points on its circumference coincide with the line, *a a*, the whole is placed in the drilling tool with the dogs pressing either on the upper external face or in the space A. After the block is fixed, ascertain by rotating the uprighting spindle that its point coincides in all positions with the top mark on the edge of the nut, and drill as usual. Drill one side, invert the block and proceed in a similar manner to drill the other. The mandril can be used for this operation, the drill being centered in a runner.

The little appliance above described might be simplified by being made of the form shown at E, fig. 2, which would require to be reversed when the second hole is about to be drilled.

2. After tracing the circle round the nut, and marking the points in the manner already explained, some watchmakers fix it in a screw ferrule, and supporting one of

### CROUCH & FITZGERALD,

Jewelry Trunks and Cases.

161 Broadway

Bet. Cortlandt and Liberty Sts.,

688 B'way,

701 6th Ave.,

NEW YORK.



Sold by all wholesale dealers at manufacturer's price.

A. N. CLARK, PLAINVILLE, CONN.

### Manufacturer of the Celebrated LOOP WATCH KEY.

The Best for the Price in the World. CROSBY'S JEWELING TOOLS IMPROVED.

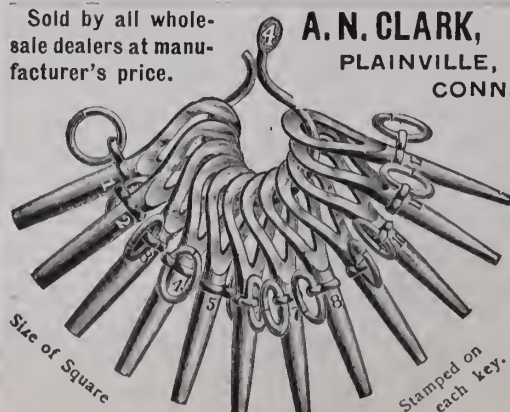

Size of Square

Stamped on each key.

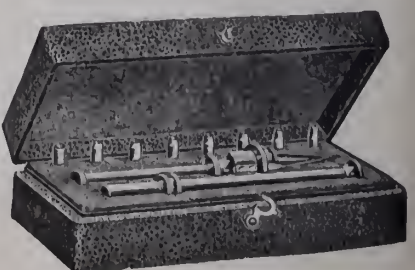

Will quote royalty or price for the manufacturing of articles of real worth.

the points by a runner of the turns, present the drill, which is supported on the T rest, against the other point and rotate the nut by a bow passing round the ferrule; in fact by a process exactly similar to that adopted in replacing a broken pivot.

One objection to this method is that a ferrule must be used that is very large as compared with the size of the object oper-



FIG. 3.

ated on, especially if it cannot be held in the rim of the ferrule. It would be better to use a ferrule the center of which has been entirely cut away, as shown at A, fig. 3, or merely with a slot in it, as B. The nut would in such a case be cemented in position.

**Workshop Notes.**

**The Clock Case.**—In your clock work, do not neglect your cases, but restore them to as fresh a look as possible. It pleases the customers, because they can see the case, but how well the movement is repaired is a matter of confidence. A little French polish rubbed over the case is very quickly done, and will add 25 or 50 cents to the job.

**Reliable Cement.**—A reliable cement, one that will resist the action of water and acid, especially acetic acid, is composed of: Finely powdered litharge, fine, dry, white sand, and plaster of paris, each three quarts by measure; finely pulverized resin, one quart; mix and make into a paste with boiled linseed oil, to which a little drier has been added, and let it stand for four or five hours before using. After fifteen hours' standing, it loses strength.

**Examining Depth by Touch.**—A sharply tapering pegwood is pressed against one end of the pivot, so that the pinion only moves with difficulty, while the driving wheel is pushed forward with another wood; by repeatedly pushing the wheel forward, the watchmaker will feel whether the process occurs gently without heating or false friction; he must in the same manner feel the shake of every single tooth. The depth may afterwards be placed in a depthing tool, so that he is convinced by ocular inspection. If this style of working has been done for a sufficiently long time, the operator will ultimately acquire a fair degree of fineness of feeling, so that eventually he will be able to judge a depthing by the touch. In the case of pendulum clocks, it is only necessary to gently press with one finger upon the pinion arbor, while another finger drives the wheel. Generally speaking it is to be highly recommended to open holes for observing a depthing during the going of the watch, as this affords the securest and best guarantee for its quality.

With Guarantee as to Quality



FOR

SEND TO

**J. T. Scott & Co.**

**4 MAIDEN LANE,  
NEW YORK.**

**VICTOR.** ☉ ☉

SIMPLEST FEED. ALWAYS THE SAME.  
GUARANTEED FOR ONE YEAR.

**THE VICTOR  
FOUNTAIN PEN**

(Pat. Feb. 4, 1890.)

**THE BOSTON PEN CO.,**

N. C. Whitaker & Co., Proprietors.

363 Washington Street, Boston, Mass.,

Manufacturers of finest quality

TORTOISE : SHELL : AND : HORN : GOODS  
in every variety. Also Aluminum Hair Pins.

Send for Illustrated Pen Price List No. 1.

**Jules Jürgensen**

OF COPENHAGEN.

The reputation these watches have maintained for **Forty Years** has never been equalled, being made on strictly scientific principles and no expense spared to give the **Best** results in mechanism and timekeeping qualities.

SOLE AGENTS.

**John C. Hyde's Sons,**  
NO. 22 MAIDEN LANE.

ESTABLISHED 1870.

**J. L. CLARK,**

**SWEEP SMELTER AND REFINER OF GOLD AND SILVER.**

\* Buys every kind of Gold and Silverware, Jewelry, Watches and Platinum. Full market value paid.

**No. 724 Filbert Street, Philadelphia, Pa.**

SEND BY EXPRESS or Registered Mail. If my price is not satisfactory, I will return all articles.

**THE BEST  
PIVOT DRILLS IN THE WORLD.**

One Gross without charge for proof  
that this is not so.

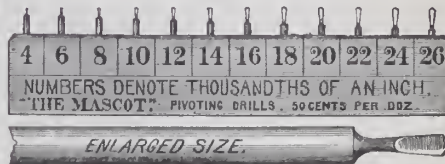

The Mascot, 50 Cents per doz.

By all Jobbers, or sent post-paid  
on receipt of price.

**Ezra F. Bowman & Co.,**  
LANCASTER, PA.

**Waltham Horological School,**

**PALMER & SWAIN, Props.,**  
WALTHAM, MASS.

**Summary of Prospectus.**

**LOCATED** in Martyn Square, in the city of Waltham, Mass. Pleasant location, hotels, boarding houses, churches, etc.

**CURRICULUM:**—Pupils are taught watch making, repairing and bench tool making complete. American and foreign systems. Special branches taught when desired.

**BRANCHES TAUGHT** include work on plates, barrels, wheels, pinions, jewels, balances, staffs, springs, screws, stem-winding parts, matching, gilding, finishing, adjusting, repairing, tool work, engraving, etc., etc. Also a thorough course in Ophthalmology by a professor of universal reputation and a course in gem cutting if desired.

**COURSE** may begin at any time and pupils are taught to make everything that enters into a watch movement. When the student has finished his course he is able to make and put together a watch complete in all its parts and properly adjusted; he is also a first-class repairer and gets such a thorough instruction in his trade as cannot be obtained in any workshop or any other school in the United States. The workshop of this School is fitted up with thousands of dollars' worth of the best watch tools and machinery, and with the capable instructors always ready to give their attention to the individual student, there being no class system, he has an advantage not to be obtained elsewhere. Materials for a watch movement will be given free to students who desire to make a watch of their own.

Send for full prospectus, terms for  
special branches, etc.

**D. D. PALMER. EUGENE H. SWAIN.**

**A. J. LOGAN,**

MANUFACTURER OF

**WATCH TOOLS, HAIR SPRINGS AND**

**WATCH MATERIALS.**

◁ New Catalogue just issued, Sent on Application. ▷  
**WALTHAM, MASS.**

# Grand STREET Exhibition!

To the Jewelers . . . . .

Below you will find detail  
and to which we add con-

of the lines which we carry  
stantly the latest novelties.



**France**==BRONZES, CLOCKS OF ALL DESCRIPTIONS, SEVRES VASES, LAMPS, PORCELAINS, FINE FURNITURE.

**Germany**==ROYAL BERLIN, ROYAL BONN, NURNBERG MAJOLICA, DRESDEN VASES, DRESDEN LAMPS IN ENDLESS VARIETY, DRESDEN FURNITURE, IVORIES.

**Austria**==DECORATED GLASS, OLD VIENNA WARE, TEPLITZ GOODS, FAYENCE STATUARY, BRONZES.

**Italy**==SUPERB LINE OF CARRARA AND CASTELLINA MARBLES, NOVE AND BASSANO FAYENCE, CARVED FURNITURE.

**England**==ROYAL WORCESTER, COALPORT, TULIP GLASS, ENGLISH CHIMING HALL CLOCKS.

## Ferdinand Bing & Co.,

74 Rue d'Hauteville,  
PARIS.

106 Grand Street,  
NEW YORK.



## An Exposition of Glass Making.

ONE of the interesting features of the World's Fair is the cut glass manufactory of the Libbey Glass Co., an illustration of which is here given. In consideration of \$100,000, the World's Columbian Exposition Co. granted to the Toledo firm the exclusive concession to manufacture and sell American glassware, within the grounds of the Exposition, during the period of the Fair.

The space allotted the company is upon the Midway Plaisance, directly opposite the Woman's building, and adjoining the Illinois Central Railroad on the west, 59th St., on the south, and the Japanese building on the east.

The building has an extreme frontage of 160 feet. The grouping is picturesque and in its way unique, the whole having a pronounced Italian expression. The construction is a combination of steel and wood, clothed with stucco and elaborate staff decorations similar to many of the World's Fair buildings. It has a capacity of accommodating over 2,000 people at one time. Upon either side of the main entrance is seen the life size figure of a glass blower at work, holding in his hand a long blow iron, upon the end of which is a large glass globe which he appears to be blowing; at night this globe is illuminated by a very strong incandescent light.

To the right of the main entrance is a crystal fountain, being the only cut glass fountain ever produced. It is made of immense pieces of the clearest glass, the total weight being over twenty tons.

Entering the main doorway, the visitor

finds himself in the glass house or blowing room, an immense glass-melting furnace being located in the center of and directly under the great dome. Between the furnace and the railing, some 20 feet distant, extending all around the furnace, is the space occupied by the workmen, and on the outside of the railing is the main aisle for the visitors, in which they can circulate around and see each workman, without in any way interfering with the progress of manufacturing. The various processes of glass manufacturing, including blowing, cut-

to the periphery of the wheel, and is quickly drawn upon it, until a sufficient number of revolutions have been made. The glass, having been spun is taken from the wheel, while in motion, and cut into desired lengths, then it is ready for the loom, and is soon woven into glass fabric. From this fabric are made colored napkins, lamp mats, neckties, baskets, book-marks, etc.

In the display room are samples of all the different products manufactured by the Libbey Co., the most noticeable of which is their beautiful display of cut glass. As we

enter this tastefully arranged room, we are surrounded on all sides by a lustre and brilliancy suggesting to one's mind a room lined with diamonds. It is so arranged with concealed electric lights as to get the very best effect, which is very pleasing to the eye. The glass is arranged in elegant show cases, upon cut glass shelves, backed by mirror plate, the ceiling of which is also lined with mirror. It would be a vain task to describe in detail the various cuttings and designs. Directly adjoining this display room is a comfortable reception room.



THE WORLD'S FAIR GLASS FACTORY OF THE LIBBEY GLASS CO.

ting, decorating, and spinning and weaving are thoroughly exposed to the interest of the visitors. An account of the spinning of glass and weaving the same into fabrics by the Libbey Glass Co., was given in a former number of THE CIRCULAR, under this department.

The spinning of glass into the finest threads is done by a rapidly revolving wheel, about 9 feet in diameter, the glass rod of the desired color having the end nearest the wheel exposed to a blow pipe flame. The glass when melted is attached

Many are the novelties that one sees within this building. The building shows great enterprise upon the part of the Libbey Co., in providing for the visitors an exhibit upon a scale never before attempted. No expense has been spared to make it one of the greatest attractions within the Exposition grounds. The exhibit is a revelation to the foreign tourist, and a great satisfaction to Americans to see in this immense industrial palace, what America has done toward the perfection of the glass maker's art, in less than half a century.

## The Connoisseur.

(Continued from page 47.)

### The Rambler's Notes.

WHAT THE RAMBLER SAW AND HEARD AMONG THE DEALERS IN ART POTTERY, CUT GLASS, BRONZES, ETC.

L. STRAUS & SONS' ART FURNITURE.

IN the statuary and art furniture department which occupies the new store of L. Straus & Sons, at 116 Chambers St., New York, there can be seen one of the finest collections of French, Italian, Dresden and Vienna furniture that has ever been exhibited in America. Among the principal French pieces is a line in inlaid wood, handsomely decorated with gilt bronze mountings, containing game tables, canopy tables, work tables, jewel cabinets, and music stands. Vernis-Martin and other cabinets in Louis XV., Louis XVI. and Empire styles are shown in many sizes. Another beautiful French piece is the combination table and screen, of bronze, with large porcelain panels. The chief pieces in the Italian furniture are the magnificent hand-carved book cases, cabinets, chairs, benches, desks, hall clock cases and pedestals. Dresden cabinets with beautiful Watteau panels and German walnut hall clock cases are shown in great variety. Among the richest pieces are the Vienna gilt wood tables, in

the tops of which are set large, artistically painted porcelain plaques. The gilt of the table forms a handsome frame for the panels, and combines beautifully with the delicate colors of the painting thereon.

\*

A. KLINGENBERG'S NOVELTIES.

Novelties in great variety are among the principal new goods shown by A. Klingenberg, 35 Park Place, New York. The new Dresden novelties with green and Watteau decorations, are exceedingly numerous and show many new shapes in flower holders and vases. One in particular represents a tree trunk, a small limb forming the handle. Many other new shapes in pitchers, vases, fruit baskets, etc., are to be seen in a line of Royal Worcester novelties that has just been opened. These are shown both in the plain color and with floral decorations. The latest goods in Limoges novelties, the product of the factory of this house, are the boudoir sets, desk sets and jardinières. Among the last is a new feature—a closely fitting china flower pot which allows the plants to be removed or replaced without bother or danger to the jardinière.

\*

NEW ROYAL VIENNA WARE.

Lazarus, Rosenfeld & Lehman, 60-62 Murray St., New York, have opened an exceedingly large variety of the smaller pieces in Royal Vienna, such as vases, bonbonnières, cups and saucers,

plates, etc. The subjects of the paintings in nearly every case, are new in this ware. Those on the vases, cups and saucers, and some of the plates, are principally copies of celebrated paintings of women of mythology, Phoebe, Diana, Psyche and the like. Other plates contain portraits of celebrated Munich beauties, from pictures in the Munich Gallery, while some show portraits of the great musicians, Wagner, Mendelssohn, Verdi, Mozart, Rubenstein or Liszt. The prevailing colors which ornament this line are maroon and cobalt, with a slight green decoration, though some of the plates have a border of rich colors. Throughout the line the shades are such as cannot be found in the cheaper grades of goods.

\*

A MAGNIFICENT VASE.

The New Jersey Lamp and Bronze Works, 44 Murray St., New York, have introduced a vase which has been pronounced to be the handsomest piece in the line of mantel and cabinet ornaments, mentioned in this column some weeks ago. It is in bronze with an old silver finish. The body is of open work and the handles show a new and graceful form.

THE RAMBLER.

Tea baskets are provided for traveling. They are of rattan and contain spirit lamp, cup and saucer, tea caddy, plate, knives, biscuit box and butter jar.

# NOTICE TO JEWELERS!

WE ARE NOW PREPARED TO SHOW YOU THE MOST EXQUISITE

≡ LINE OF ≡

## M. REDON'S FRENCH CHINA,

WHICH HAS GAINED A WORLD WIDE REPUTATION FOR EXCELLENCE OF MANUFACTURE AND NEATNESS AND BEAUTY OF SHAPE AND DECORATION; A FULL AND COMPLETE LINE SHOULD BE CARRIED BY EVERY JEWELER.

## CHAS. AHRENFELDT & SON,

50, 52 & 54 MURRAY STREET,

NEW YORK.

AGENTS FOR THE UNITED STATES AND CANADA.



# ANNOUNCEMENT



## FALL, 1893.

OUR Importations for the coming season are now arriving and we have on exhibition at our ware-rooms a complete assortment of exclusive

# Novelties and Specialties

SELECTED FOR THE JEWELRY TRADE.



SPECIMENS OF FALL GOODS FROM THE STOCK OF LEON J. GLAENZER & CO.

Clocks, Bronzes, Sevres Vases, Fine Decorated Porcelains, Cups and Saucers, Tea Sets, Lamps and gilt and silver plated filigree Photo Frames in endless variety

# LEON J. GLAENZER & CO.,

35 Boulevard de Strasburg, Paris .

80 & 82 CHAMBERS ST., N. Y.

## The Connoisseur.

(Continued from page 48.)

### Bawo & Dotter's Carlsbad China.

NOTABLE in an exhibit of special excellence is the Columbus pattern dinner set in the choice selection of Carlsbad china exhibited by Bawo & Dotter, 28, 30 and 32 Barclay St., New York, and 75 and 77 Lake St., Chicago, in their Austrian display in Manufactures building at the World's Fair. The dinner set comprises one hundred and fifty pieces and in color is a shaded apple green, graduated from bright apple green at edges to white in center of the plates and bottom of the cups. The covered dishes are shaded from bottom to top and the covers from edges to center. In form the plates and rims of the cups are perfectly round while the larger open dishes are of oval shape with plain smooth edge midway of the sides and ends and slight scalloped indentions at the "corners," or points of greatest curvature.

All pieces for an inch from the rim are decorated in raised gold partaking of a rococo pattern. At each end of the platters and sides of the covered pieces are ships tossed on the waves, in raised gold, and at the sides of the platters are blades of barley and other gold ornamentation. Below the scalloped parts of the rims are parallel lines of gilt representing the sea.

The chief ornamentation, however, are branches of apple blossoms finely executed in realistic colors. The handles of the covered dishes are a representation of the davits of the *Santa Maria*, with ropes connecting the ends, and the lifts of the covers are a tiller and tiller ropes of Columbus' time. The covers of the tea pot and sugar bowl are crowned with a golden sail, with on one side the words "Chicago, 1893," and "World's Columbian Exposition" on the opposite side. The handles of these pieces are of the davits pattern. All davits and tillers are in gold and pink.

The set is exquisite in its richness of decoration and most beautiful in design and coloring, the pink and apple green forming "a most lovely combination," as the ladies remark. The firm have some thirty feet of space on the right of the main aisle entering Austria from the German section, and the Columbus set takes up the center of the broad table that displays the wares of the Fischer works and Bohemian glass.

At either end of the dinner set is a vase of royal blue underglaze Carlsbad porcelain about 4 feet in height. The stand, gradually decreasing in size, rises to a height of 18 inches, in which the blue is relieved by gilt bands of oak leaves and acorns, a beaded band and very narrow borders of gilt. Gilt leaves in raised gold form the decoration of the cup, from which rises a vase body the form of an egg standing on its smaller end. On the front center of the

body of one is depicted the departure of Columbus from Palos, and on the other his landing at San Salvador. Huge goats' heads with beards and horns in solid gilt form the handles. The cover is in the form of a ship's capstan and is perforated, the pierced work being outlined in gilt. The vases are attractive and emblematic of the occasion that brought them forth.

A complete set of two hundred and nine pieces for breakfast, dinner and tea is in white Carlsbad china, decorated with pale gray vines bearing white blossoms with gilt stamens. Raised gold is also used in the ornamentation and the edges have a clouded gilt effect. The cups are odd in shape, flaring outward from the bottom nearly an inch, then receding slightly and broadening again in a slight outward curve to the top.

A toilet set of fifteen pieces largely in royal blue is remarkable in its decorative effects. A chamber set in dark shaded green with pansy and gold decoration and heavy gold handles, and a pink chamber set with brilliant dark pink at the top and bottom, dark pink handles, and apple blossom, lily and lilac decoration on the various pieces are also attractive.

Game and fish sets, vases with Cupid decorations, chocolates, toilet sets and cupidors in various colors and patterns, complete the interesting china exhibit.

In Bohemian glass from the Steinschocnau factory are shown many brilliant cut glass stand and sidelight candelabra from



## Exceptional Opportunity

FOR

## Bric-a-Brac Buyers!

OUR entire collection of IMPORT  
SAMPLES of HIGH ART NOVELTIES,

specially imported for the Jewelry Trade, are now on exhibition and will be sold on and after Sept. 1st, at Big Reductions to make room for new importations of Fine Pottery, Art Furniture, Marbles, Exclusive Art Productions, &c.

## GEO. BORGFELDT & CO.,

18, 20, 22 WASHINGTON PLACE, cor. Greene Street, NEW YORK.

# Art Corners in Geo. Borgfeldt & Co.'s Establishment.



ART ROOM NO. 1.



ART ROOM NO. 2.



ART ROOM NO. 3.



ART ROOM NO. 4.

## To Jewelers and Art Dealers :

Our third floor, 100x100 FEET is devoted exclusively to BRIC-A-BRAC, ARTISTIC NOVELTIES and the RICHEST PRODUCTIONS in ART POTTERY, GLASSWARE, CLOCKS, PEDESTALS, ETC., of which these cuts will give some idea.

We are disposing of these collections at SPECIAL PRICES, preparatory to the arrival of our new lines for 1894, thus affording an EXCELLENT CHANCE for buyers to obtain, with small outlay, a beautiful assortment of CHOICE GOODS.

Very Respectfully,

# GEO. BORGFELDT & CO.,

18, 20 & 22 Washington Place, New York.

one to five light; slender cut glass and gilt vases; Bohemian glass in white and gilt showing cut glass effects; many graceful shapes in decanters, toilet sets, liqueur sets, wine sets, bowls and saucers, and glasses; a liqueur set of white glass with raised ground figures of woodland elves; and a toilet set of five pieces in red Bohemian glass heavily decorated in gilt.

The exhibit is well located and is full of interest.

### Historic Dish.

SOMETIMES parts of the history of interesting relics are enveloped in mystery, philosophizes *Youth's Companion*, and the satisfaction of their proud possessors may depend on this mystery to a greater extent than they are aware of. An amusing instance of this kind is related by an ex-United States minister who is an enthusiastic collector of rare and beautiful china.

This gentleman recently purchased a beautiful piece of china, decorated in gold and colors, bearing the monogram "M. W.," a motto, and figures symbolical of the original States of the Union. He put it in his cabinet, and often looked at it with great satisfaction.

One day a gentleman who is an expert critic of fine china called upon him, a man who is also a member of the firm of Brown & Co., a well-known house, one department

of whose business is a crockery manufactory. The ex-official proudly displayed his latest prize.

"What is that?" inquired the visitor.

"Why, that is a piece of the famous Martha Washington dinner set. It is one of the very few pieces now in existence. I bought it at an auction sale in Philadelphia."

"How much did you pay for it?" asked the expert, meanwhile examining it carefully.

"I paid twenty-five dollars for it, and it was a bargain. The agent had an offer of three hundred dollars for it immediately after I bought it."

"My friend," said the expert, solemnly, "I am sorry for you. This dish was made by Brown & Co., in 1876, and we sold it for one dollar and forty-seven cents."

One particular story that Chris. Strobel, the genial jeweler of Waterbury, Conn., who is just back from the World's Fair, tells, is amusing. During his stay one of the Bedouins on the Midway Plaisance had several aching teeth extracted, and a collection was raised to buy the fellow a false set of teeth. The man was delighted, but the second day suffered a terrible accident. In eating with the new molars he forgot that they were false, and swallowed them. This calamity drove the frightened fellow into madness, and when he recovered from his temporary aberration he was sent to his home.

### The Owners of the "Jagersfontein Excelsior."

THE owners of the "Jagersfontein Excelsior" are B. I. Barnato and Cecil Rhodes. Mr. Barnato is one of the directors of the De Beers company, and has had a somewhat notable career on the diamond fields. He reached here in the palmy days of Kimberley, when fortunes were often made between sunrise and sunset of the same day. With a capital of only thirty shillings he started hawking watches on commission. It is pretty clear that he must not only have sold a fair number, but that he must have had good profits, for two years later he was a diamond merchant. A few years later he had large interests in the Kimberly mine, and to-day he and Mr. Rhodes are the two wealthiest men of South Africa. Mr. Rhodes is the son of an English clergyman and began his South African business experience as a sugar planter in Natal. Later on he was working with pick and shovel as a diamond miner and within a few years had amassed a large fortune for a young man; he is not forty years' old yet. Later he returned to Cambridge University, finished his education, duly graduated and subsequently passed as a barrister-at-law. Coming back to South Africa, he had a chief part in carrying through the great scheme of amalgamation and is now the prominent factor in the management of the De Beers concern.



The finest line of  
"Novelties" for  
Jewelers ever shown in  
this market.

An entire New Stock  
direct from the Art  
Centers of Europe.

# Levy, Dreyfus & Co.,

9 & 11 MAIDEN LANE, N. Y.

OPERA GLASSES IN VARIETY UN-  
EQUALED IN THE U. S.

Call early to see  
our Art Goods for Jewel-  
ers, Especially se-  
lected for all Jewelry  
Stores.

NOTE.—Many Fine Import  
Samples at 50 Per Cent.  
Reduction.





EUROPEAN  
CLOCKS  
AND  
ART GOODS.

LOW PRICES TO SUIT  
THE TIMES.

F. KROEBER CLOCK CO.,

360 Broadway,

ALSO

BROADWAY, Cor. 17th St.,

NEW YORK.

OURS IS THE  
CH. FIELD HAVILAND  
LIMOGES CHINA.

FABRIQUE FONDEE EN 1797.  
E. GERARD, DUFRAISSEIX & CIE.,  
SUCCESEURS:

WHITE WARE.  
CFH  
GDM  
FRANCE  
TRADE MARK.

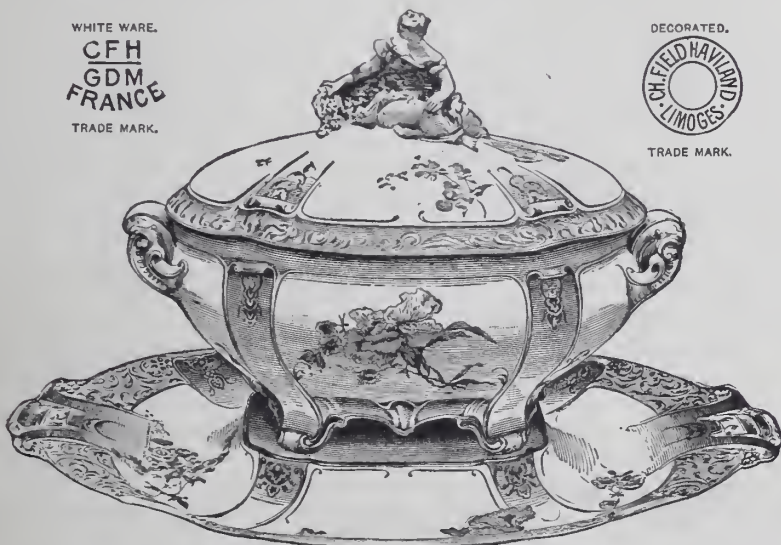

SOMETHING ABSOLUTELY NEW IN CERAMICS, FURNACE FIRE COLORS.

HAVILAND & ABBOT,

AGENTS FOR THE UNITED STATES,

29 Barclay Street,

NEW YORK.



AMERICAN RAILWAY SUPPLY CO.  
24 Park Place, NEW YORK.

For BADGES AND MEDALS,

Flag Pins, Class Pins, Class Rings  
and Special Work of all Descriptions.

SEND TO E. R. STOCKWELL, MANUF'R.,  
19 John Street, New York.



ESTABLISHED 1801.

# HINRICHS & CO.,

29 &amp; 31 PARK PLACE,

Cor. Church Street,

NEW YORK.

**Art Pottery and Bric-a-Brac,  
CUT GLASS, FANCY GLASS, CHINA.**

Large Assortment of

**Fine Dresden China Lamps, Glass and  
other Fancy Lamps.**

THE LARGEST ASSORTMENT OF SPECIALTIES FOR THE JEWELRY TRADE, AT LOWEST PRICES.  
CATALOGUE, ON APPLICATION.

## FRENCH CHINA SPECIALTIES FOR JEWELERS.

BRUSH & COMB TRAYS,  
CARD TRAYS,  
MANICURE TRAYS,  
PEN TRAYS,

PHOTOGRAPH FRAMES,  
FRUIT PLATES,  
ODD CUPS AND  
SAUCERS, ETC.

◁ SEND \* ORDER \* FOR \* SAMPLE \* ASSORTMENT. ▷

### F. W. BUNING & CO.,

58 MURRAY STREET,

NEW YORK.

HE HAD A

~△ HANG-DOG LOOK, △~

BECAUSE HE BOUGHT HIS

Gold, Silver, Steel and Nickel

Spectacles and Eyeglasses.

Gold, Silver, Aluminum and German Silver

THIMBLES!

—: AND :—

SEAMLESS, GOLD FILLED,

SPECTACLES AND EYEGASSES,

BEFORE SEEING OUR LINE.

### THE WINSTED OPTICAL CO.,

MANUFACTURERS OF

The BURBANK Patent Eyeglass, SEAMLESS Gold Filled Spectacles and Eyeglasses. And all other goods enumerated above, WRITE US! WEST WINSTED, CT.



### The Other Side of Life.

PEARLS AND JOYS.

Little boys are little joys,  
When they are loving and true;  
Little girls are little pearls,  
When they are sweet—like you!  
—*Youth's Companion.*

CRIMINAL NEGLIGENCE.

Stealing the spoons and overlooking the forks.—*World's Fair Puck.*

SHE—Take back your ring (sadly). You said when we became engaged that you were the luckiest man in the world.

HE (taking the ring)—Now I know I am.  
—*New York Herald.*

SMYTHE—I prefer silver to gold, because it is so typically American.

TOMPKINS—How so?

SMYTHE—Why, it wants to be equal to its superior, and superior to its equal!—*Puck.*

NOT A STEM-WINDER.

LANDLUBBER—What is the first work on board you give to a green man when he ships?

SAILOR—We generally set him at winding up the starboard watch.—*Judge.*

UNCLE GEORGE—Instead of wearing diamonds, don't you think it would be more becoming to pay your tailor bill?

HARRY—But if I paid my tailor bills how could I afford to wear diamonds? And if people didn't buy diamonds what would keep the diamond merchants from starving to death?

UNCLE GEORGE—But you don't pay for your diamonds, either.

HARRY—Ah! now you are wandering from the subject.—*Boston Transcript.*

OBEYED ORDERS.

"Bridget," said Mrs. Morse, instructing her new waitress, "when a lady comes to call on me, you must hand her this tray, and bring her card upstairs to me." "Yis'm," replied Bridget promptly. The next afternoon Mrs. Morse was surprised by the appearance of Bridget bearing a card in her hand.

"Why, Bridget," she remonstrated, "didn't I tell you yesterday to hand the little silver tray to the callers?"

"Yis'm," replied the smiling maid, "an' I did hand it to her, an' it's herself was unwillin' to take it; but when I tould her it was my mistress's ixpress orthers, she give in, quite mild and pleasant like. You'll find it safe wid her down in the parlor, ma'am."

And sure enough, Mrs. Morse, when she had made a hasty descent, found her visitor holding the card receiver, while her mouth was twitching with amusement.

"I didn't dare refuse it," she said meekly, "as long as Bridget was so urgent!"—*Youth's Companion.*

**HENRY ABBOTT,**  
 MANUFACTURER OF  
 Stem-Winding Attachments  
**FOR WATCHES,**  
 No. 2 Maiden Lane, NEW YORK.



Patented Feb. 9, 1892.

**THE W. B. & E.**

Marvel Tilting Spring Eyeglass in Gold, Steel, and Frameless.

**JULES LAURENCOT & CO.,**  
 49 MAIDEN LANE, NEW YORK.

Sole Agents in the United States and Canada.

**Headquarters**  
 FOR  
 ELECTRIC & PORTABLE  
 Watchman's Clocks

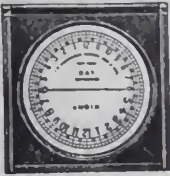

Price, Complete \$10.00

Lowest Prices.  
 Latest Improvements,  
 Patents 1886-1893.  
 Send for Circular.

**E. O. HAUSBURG,**  
 41 Malden Lane, New York. THE "ALERT."

*Our Catalogue No 4 of  
 Diamond Ring Mountings is  
 ready - it is useful, send for it  
 Waterman & Lehmann 37 Maiden Lane  
 New York*

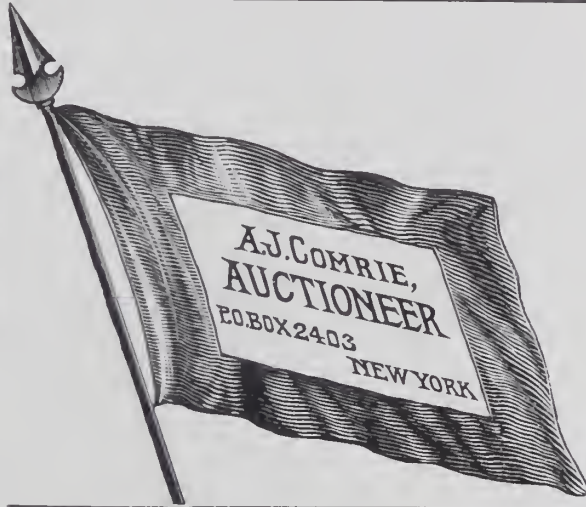

SPECIAL SALESMAN OF  
**WATCHES, DIAMONDS,**  
 Bric-a-Brac  
 and Art Goods  
 FOR  
**Established Jewelers.**

WRITE FOR PARTICULARS.

Communications Strictly Confidential.

References given in all parts of the United States from Retailers and Jobbers

**Awards for H. H. Heinrich's Chronometers.**  
**CHICAGO, 1893.**

**PARIS, 1889.**

**BERNE, 1858.**

A Good Stock of First-Class New and Second-Hand Chronometers  
 always on hand at Moderate Prices.

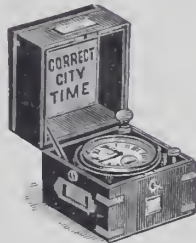

**H. H. HEINRICH,**

14 John Street,  
 NEW YORK.

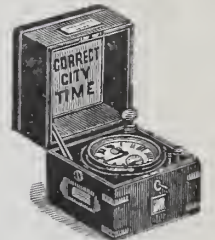

**SPECIAL**  
 IN  
 THE JEWELERS'  
 CIRCULAR  
 Produce the  
 results desired.

**NOTICES**

# "WORKSHOP NOTES"

For Jewelers and Watchmakers."

BEING A COLLECTION OF THE LATEST PRACTICAL RECEIPTS ON THE MANUFACTURE AND REPAIRING OF WATCHES AND CLOCKS, AND ON THE VARIOUS PROCESSES ENTERING INTO THE MANUFACTURE AND REPAIRING OF JEWELRY, AS COLORING, POLISHING, ENAMELING, ANNEALING, OXIDIZING, ETC. IN; SHORT A THOROUGH COMPENDIUM OF THE NUMEROUS MECHANICAL DEPARTMENTS OF THE JEWELERS' AND WATCHMAKERS' SHOP.

200 PAGES, BOUND IN CLOTH, STIFF COVERS.

PRICE \$2.50, BY MAIL, POSTPAID,

Including a Year's Subscription to the "Jewelers' Circular."

87 NASSAU ST.,  
(Fulton Building), NEW YORK.

Importers of DIAMONDS,

WOLFF & GUNZBURGER,

L. & W. KATLIN & Co., Importers of DIAMONDS, Cor. Maiden Lane, NEW YORK.

**B. & W. B. SMITH,**

220 WEST 29<sup>TH</sup> ST.,

NEW YORK CITY.

AT THE

**WORLD'S FAIR, CHICAGO,**

OUR EXHIBIT IS IN THE

Manufactures and Liberal Arts Building, Section A, Block One.

CALL AND SEE US AT OUR OFFICE IN NEW YORK.

**WHY**

S. F. MYERS & CO.  
sell more goods than any  
other Wholesale Jewelry  
House.

**BECAUSE**

various publications and illustrated catalogues.

They are the only firm in the Metropolis who carry  
in stock a full line of everything a jeweler requires.  
They give the utmost values and endeavor to  
please their trade in every respect. Refer to their  
various publications and illustrated catalogues.

MYERS BUILDINGS, 48 & 50 Maiden Lane, NEW YORK.

**JOHN W. SANBORN & Co.,**

414 Washington Street, - - Boston.



Importers, Manufacturers and Jobbers of

**OPTICAL GOODS,**

WE have just received several New Specialties in Trial Cases and have in  
stock all the older makes. Our work-shop has all the modern improve-  
ments which enables us to execute prescriptions with promptness and accuracy.  
New Catalogues of Trial Cases sent on application.

**BLACK DIAMOND FOUNTAIN PEN.**

Unequaled for Price.

Send for Circular.



**H. M. SMITH & Co.,**

83 NASSAU STREET, N. Y.

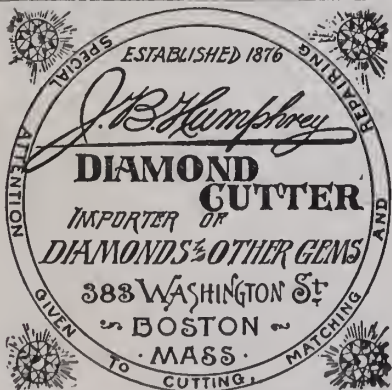

**S. P. HOWARD,**  
Gold and Silver Assayer.

**Refiner and Sweep Smelter,**  
33 MAIDEN LANE, NEW YORK.  
Smelting and Refining Works,  
28 & 30 Cumberland Street, Brooklyn, N. Y.  
Specialties: Sweepings, Gold, Silver and Platinum



**GILT AND CHINA SET, 2040/1,**  
Clock 13 inch. High—in three decorations.

15 Day Fine French Movement Time, - - - \$14.50, cash with order.  
" " " Gong Strike, - - - 18.00, " "

**CHAS. JACQUES CLOCK Co.,**

22 CORTLANDT ST.,

NEW YORK.

**IT PAYS** TO KEEP IN TOUCH WITH TRADE AFFAIRS.  
THE JEWELERS CIRCULAR, For 4c. a Week will do it. **Subscribe.**



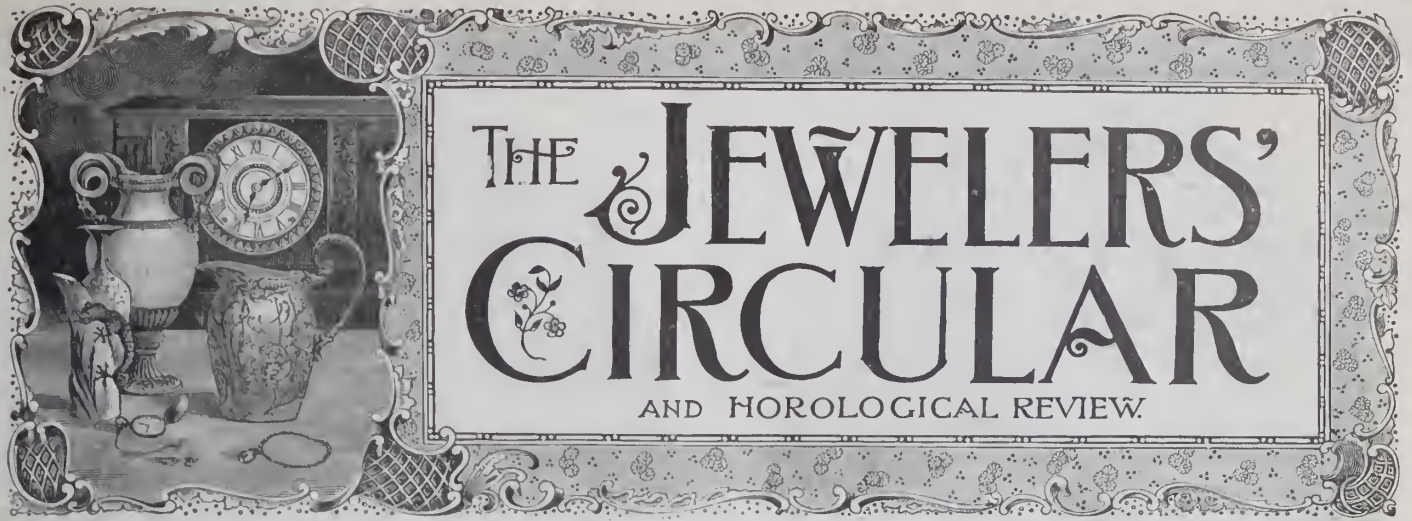

Copyright, by THE JEWELERS' CIRCULAR PUB. CO.

189 Broadway, New York.

Entered at the Post Office in N. Y. as second-class matter

VOL. XXVII.

NEW YORK, WEDNESDAY, OCTOBER 18, 1893.

NO. 12.

### THREE FAMOUS SILVER YACHTING TESTIMONIALS.

THE struggle between the representative American yacht and the representative English yacht for the America's cup, has ended and the symbol of supremacy in the great sport remains for at least another year, on this side of the Atlantic, where its possession has been regarded with pride since 1851. Radical advancements have been made in the designing of yachting trophies since the Messrs. Garrard, of England, fashioned the cup in 1849. Though a graceful specimen of silversmithing, suggesting the German hanaps of the seventeenth century, it is void of all symbolism, and there

have called into existence of late years are marvels of beauty and originality.

*Volunteer*, in grateful recognition of his unequalled skill and ability, in thrice defending America's Cup.

These trophies are of special interest just at the present moment. Each of these trophies is a more striking and appropriate work in silver than the America's cup. The illustrations scarcely do credit to their grace and delicate workmanship. The figures in bas-relief are as clearly cut in every detail as though they were distinct from the cup. The significance of the figures add much to their interest. That on the *Puritan* cup is a testimonial to the genius of Burgess,



PRESENTED TO MAYFLOWER.



PRESENTED TO PURITAN.

The New York Yacht Club has after each of several international races, presented to the owners of the victorious yachts an honorary testimonial in the shape of a fine silver trophy, three of which are here given: One to General Charles J. Paine, to commemorate the victory of his sloop *Mayflower* over cutter *Galatea*, in America's cup race of September, 1886; one presented to the owners of *Puritan*, in commemoration of her victory over the *Genesta*, representing the Royal Yacht Squadron of England, in the race for possession of the America's cup, sailed September, 1885; and the other to Captain Charles J. Paine, owner of the



PRESENTED TO VOLUNTEER.

being an idealized representation of the great designer attired in the Puritan costume. (Continued on page 15.)

is nothing but the inscription to connect it with the sea. To the admirer of art, the cups that the demand for yachting trophies

MARJORIE.

INITIAL.



EBONY AND SILVER COMBINATIONS IN  
TOILET SETS  
 AND  
NOVELTIES.

ORIGINATORS AND MAKERS

**DEITSCH BROS.,**

7 EAST 17TH STREET, NEW YORK.

ALSO

Novelties in Leather and Sterling Silver  
Combinations.

**LARGEST ASSORTMENT,**  
**IN THE COUNTRY.**

# THE "TUDOR"

PATENT APPLIED FOR.



From 8 oz. up.

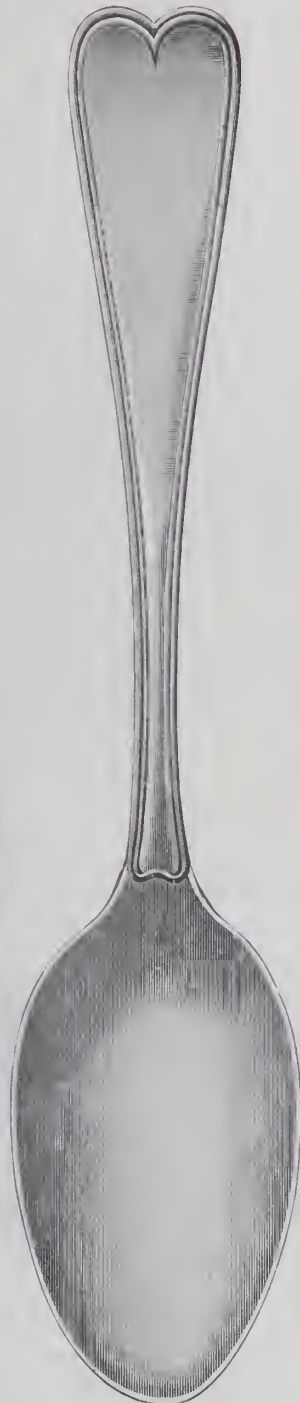

From 16 oz. up.

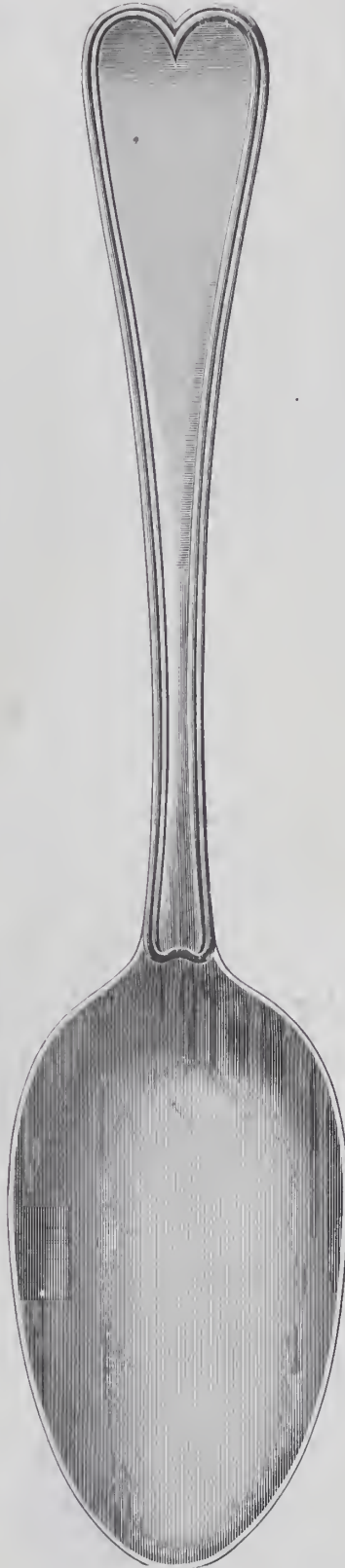

From 20 oz. up.



From 18 oz. up.



From 15 oz. up.

THESE illustrations show the Tea, Dessert and Table Spoons, and Dessert and Medium Forks.

A Small Dessert Spoon, a Table Fork, larger than the medium, and a Complete Line of Fancy Pieces are made in this pattern.

## Dominick & Haff,



ESTABLISHED 1821.



Makers of Wares in Sterling Silver

FOR THE TRADE ONLY.

Broadway and Seventeenth St., Union Square, N. Y.



The finest line of  
 "Novelties" for    
 Jewelers suitable for  
 Holiday trade, ever shown in  
 this market.

  An entire New Stock  
 direct from the Art  
 Centers of Europe.

# Levy, Dreyfus & Co.,

9 & 11 MAIDEN LANE, N. Y.

OPERA GLASSES IN VARIETY UN-  
 EQUALED IN THE U. S.

If you are not coming  
 to New York, send for  
 Photos of Latest Nov-  
 elties, or leave selec-  
 tion to us.

*NOTE.—Many Fine Import  
 Samples at 50 Per Cent.  
 Reduction.*



## Silver Mounted Scissors.

Thirty-two styles and sizes  
 for Manicure, Embroidery, Silk,  
 Library, Grapes, Flowers, Cha-  
 telaines, Button hole and va-  
 rious other uses.

Silver mounted Manicure In-  
 struments and Toilet Articles  
 in a large variety of patterns  
 and sizes.

 **BACHRACH & FREEDMAN,**  
 1 & 3 Union Square,  
 NEW YORK.

**HENRY ABBOTT,**  
 MANUFACTURER OF  
**Stem-Winding Attachments  
 FOR WATCHES,**  
 No. 2 Maiden Lane, NEW YORK.

Sold by all whole-  
 sale dealers at manu-  
 facturer's price.

**A. N. CLARK,**  
 PLAINVILLE,  
 CONN.

Manufacturer of the Celebrated  
**LOOP WATCH KEY.**  
 The Best for the Price in the World.  
 CROSBY'S JEWELING TOOLS IMPROVED.

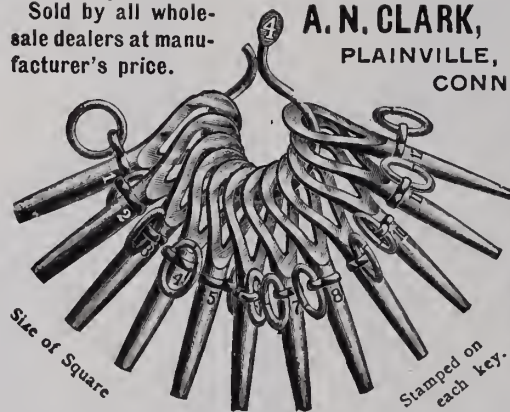

Will quote royalty or price for the manufacturing of articles of real worth.

## Enterprising Jewelers Catch On!



**Jewish Shekel, Masonic Mark or Pocket Piece.**  
 THE LATEST AND BEST SELLING NOVELTY.

The mark is struck in coin silver; by using either the obverse or reverse of the coin, the back being the same in either case, and permitting of the purchaser's name, blue lodge, chapter and individual mark, with date of same being engraved thereon, as shown in cut above.

Price, without engraving, ONE DOLLAR. Engraved Mark, Dates, etc., 75c. EXTRA.  
 Liberal Discount to the Trade.  
**CHAS. C. WILLSON, MANUFACTURING JEWELER, READING PA.**

*Pairpoint's*

# MFG. COMPANY,

## GOLD AND SILVER PLATE, New Bedford,

### Mass.

DO NOT FAIL to see our exhibit at Columbian Exposition, Section N, Manufactures Building, and our store, 224 Wabash Avenue, Chicago.



No. 3483. Embossed Tea Caddy.



No. 927. Jewel Casket.



[No. 3727. Hair Pin Box.

CHICAGO,  
224 Wabash Ave.

NEW YORK,  
20 Maiden Lane.

SAN FRANCISCO, CAL.,  
220 Sutter Street.

## LLOYD PATENT.

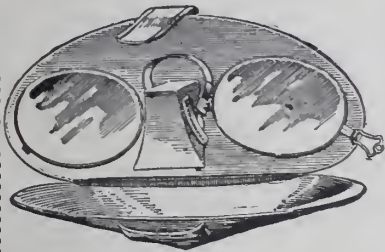

In Good LLOYD **CASE** you want a send for

**H. E. KIRSTEIN & CO.,**  
MANUFACTURERS,  
Rochester, N. Y.

We sell to the legitimate Jewelry and Stationery trade only.



## CHOICE PAPERS

MAKERS OF

# FINE STATIONERY

For Correspondence, Wedding and Business Use, handsomely boxed, specially suited to the Jewelry Trade.

18 MURRAY STREET, NEW YORK.

## OPTICIANS' SUPPLIES

Jobbing and Prescription Work.

The "Graduate" Trial Cases, 150 lens set, \$30.00; 220 lens set, \$31.50. The "Standard" Trial Case, 220 lens set, \$35.00. All with lens. Loring Ophthalmoscope, \$9.00. Artificial Eyes, for selection, \$1.00 each, \$50.00 for hundred. Ophthalmometers, \$50.00 to \$70.00. Queen's Standard Perimeter, \$18.50. Queen's Lens Grinding Outfit, \$3.00. Steel Frames, 15 to 30 cents each. Spherical Lenses, 25 cents per pair. Cylinders, 33 cents per pair. Lenticular Bifocals, 81 cents per pair, full base nose pieces. German or Shell. German Silver, \$1.00 per dozen pairs. Gold, \$2.00 per dozen pairs.

**QUEEN & CO.** Opticians and  
Catalogue free. 1010 Chestnut St., Phila., Pa.

# NOVELTIES IN STERLING SILVER



No. 330. MATCH SAFE.



No. 14. PIN BALL.



No. 13. PIN BALL.



No. 325. MATCH SAFE.

Trade Mark.



R. W. & S.  
Sterling.



No. 104. POCKET KNIFE.



No. 102. POCKET KNIFE.

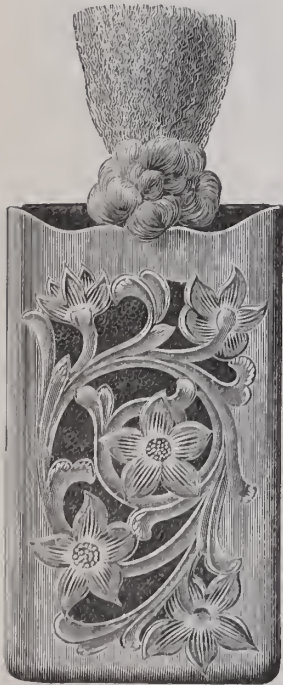

No. 3. COURT PLASTER CASE.



No. 39. CANDLE HOLDER.

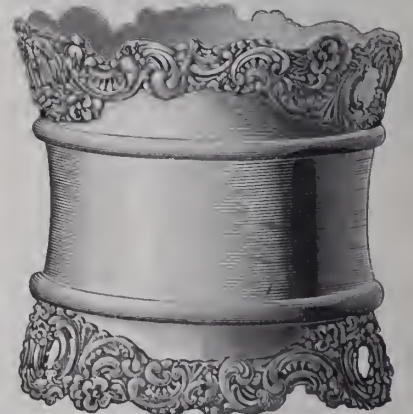

No. 800. NAPKIN RING.

# R. WALLACE & SONS MFG. CO., SILVERSMITHS,

NEW YORK,  
3 PARK PLACE.

WALLINGFORD, CONN.  
SAN FRANCISCO, 120 SUTTER ST.

CHICAGO,  
86 WABASH AVE.

**Is This the Man Who Looted Optician Wagner's Store.**

CINCINNATI, O., Oct. 12.—Information has been received at police headquarters which leads the detectives to believe that they are on the track of the burglars who, about a month ago, as reported in THE CIRCULAR, robbed the store of Ferdinand Wagner. Wagner's optical goods store was broken into and spectacles and other property stolen, the value being placed at \$2,000. Detectives were assigned to the case, but the most persistent efforts failed to give them a clue. None of the goods was offered for sale in this city, and they were unable to locate the plunder.

The information which they now have came in a letter from Jelico, Tenn. The authorities there state that a man is under arrest at that place who gives his name as Spence Henderson and claims to live in Cincinnati. He is a negro, and when arrested a lot of razors and knives were found upon him. The officers learned that he had a large box which was concealed somewhere. He refused to tell where it was. This box is supposed to contain some of the plunder secured from Wagner's store.

**The Annual Meeting of the Alabama Retail Jewelers' Association.**

BIRMINGHAM, Ala., Oct. 12.—As previously announced, the annual meeting of the Retail Jewelers' Association, of Alabama, has been indefinitely postponed on account of the failure to secure reduced railroad rates and the general financial depression which would necessarily have made the attendance small.

Secretary Rosenstihl thinks that the Association will not hold its annual meeting this year, but will probably convene here early next Spring. He says that despite the fact that the meeting has been postponed, the Association is in a prosperous condition, the membership being about sixty.

Among the new members recently added are: Alston & Maxwell, Tuscaloosa, Ala.; C. A. Nettles, Eutaw, Ala., and the Riverside Jewelry Co., Riverside, Ala. The Association began with a membership of about twenty-five a little over a year ago.

**A Celebrated Diamond Thief in Custody in Iowa.**

DENVER, Col., Oct. 9.—Pat Crowe, the man who created such a sensation in Denver last February by snatching \$600 worth of diamonds from a tray in H. L. Chapin's jewelry store is under arrest at Dennison, Ia., for robbery committed there.

Crowe is a noted diamond thief and has operated extensively. He secured his release after his arrest by the city detectives on a bond of \$2,000 furnished by his brother, a Chicago saloon keeper, and immediately decamped. He will probably be returned to Denver to answer for his crime.

C. F. Collins, Lynn, Mass., has discontinued business.

**BIPPART & CO.,**

— MANUFACTURERS OF —

**FINE JEWELRY,**  
NEWARK, N. J.

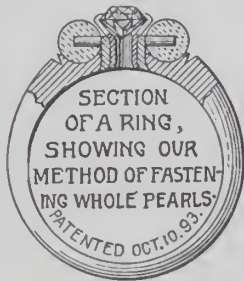

We claim our  
"Patent Whole Pearl Fastener"  
superior to all others now in use, and absolutely secure. It enables us to make a line of Rings, Scarf Pins and Brooches unsurpassed in durability and finish.

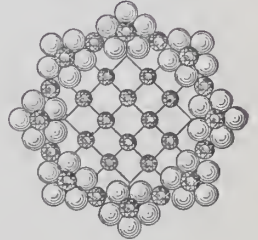

PATENTED OCT. 10TH, 1893.

New York Office, 19 MAIDEN LANE.

**THE BOWDEN SEAMLESS RING**

IS MADE ONLY BY

**J. B. BOWDEN & Co.,**  
Makers of Finger Rings of every Description.  
COR. BROADWAY & JOHN STREET,  
NEW YORK.

**J. B. & S. M. KNOWLES CO.,**

MAKERS OF

**Sterling**



**Silverware.**

FACTORY,  
Providence, R. I.

SALESROOM,  
860 Broadway, N. Y.

**O. W. BULLOCK & CO.,**  
SPRINGFIELD, MASS.

Makers of Watch and Jewelry Tools,  
NEW CATALOGUE NOW READY.

Sent on Application. Please Mention this Paper.

**CLEAN JEWELRY SELLS QUICK.**

Quarters' Cleaning Solution removes dirt and tarnish in an instant, makes stock like new and brings up diamond and stone work to a beautiful lustre. Solution can be used over and over. Highly commended by all who use it. Send at once \$1.50 for half gallon with full directions. References.

W. F. QUARTERS ELECTROPLATER,  
139 EDDY STREET. PROVIDENCE, R. I.

**Aikin Lambert Jewelry Co.**  
 Importers of  
**Diamonds,**  
 Jobbers in **WATCHES,**  
 Jewelry Chains etc.  
 19 Maiden Lane.  
 New York.

JAMES C. AIKIN, Pres.  
 JOHN B. SHEA, V. Pres.

SAM'L B. MANN,  
 Treas.  
 FRED. D. ILGEN,  
 Sec'y.

## C. SYDNEY SMITH,

HAS REMOVED TO 191 BROADWAY,  
 New York.

FACTORY:  
 PROVIDENCE, R. I.

Manufacturer of { **GOLD CHAINS,**  
**LOCKETS AND CHARMS.**



## The Warren Eye Protector

(Patented Jan. 12, 1892, Feb. 21, 1893.)

Saves the Eyes From

**Dust, Wind, or Glaring Light.**

Folds in a Compact Case, Is

**Comfortable, Durable,  
 Water and Dust Proof.**

Its large field does not obstruct the sight. No brittle substance to endanger face under sudden blows.

*Oculists and Physicians Recommend it.*

Travelers, Cyclists, Railroadmen,  
 Horsemen, Motormen, Quarrymen,  
 Pronounce it Indispensable for Man or Woman.

*Ask your Dealer for it.*

Colors, Clear, Smoke, Blue or Green. Black frames, 50c. Silver, 75c. Sent by mail on receipt of price. Manufactured solely by

**The Nous Verrons Company**

P. O. Box 3273, Boston, Mass.

### The Hollander Jewelry Co. Succeed Leo Hollander.

SALT LAKE CITY, Utah, Oct. 13.—The Hollander Jewelry Co. have filed articles of incorporation with the District Clerk. The incorporators are Frank D. Kimball, W. D. Pavey, Joseph Baumgarten, Leopold L. Baumgarten and Simon Bamberger. The capital stock is fixed at \$25,000, divided into 250 shares of the par value of \$100 each.

The officers of the company are Simon Bamberger, president; Leopold Baumgarten, vice-president, and Frank D. Kimball secretary and treasurer. The company will carry on a business in harmony with their name.

### Wholesalers Unite with Philip Silverthau to Fight a Law.

NEW HAVEN, Conn., Oct. 11. — P. Silverthau, who was arrested in Waterbury a few weeks ago, as reported in THE CIRCULAR, and fined \$50 and costs for peddling without a license, has, through his counsel, filed notice that he would appeal the matter to the Supreme Court. Mr. Silverthau has the backing of many large houses in this State and New York, and they have joined with him for the purpose of testing the constitutionality of the law.

Big mercantile houses outside of this State who send drummers into it are very deeply interested in the matter, as it is of great importance to them, and they intend to fight the law to the bitter end.

### The Sudden Death of Richard C. Acton.

ALEXANDRIA, Va., Oct. 11.—Richard C. Acton, of Richard C. Acton & Son, died suddenly at his residence at 5 o'clock Sunday morning. Mr. Acton closed his store at 10.30 o'clock on Saturday night and, going home, retired without complaining. At 4.30 Mrs. Acton was aroused by her husband's heavy breathing, and tried to awake him, but failed. The family physician was sent for, but before his arrival Mr. Acton expired. He had been complaining for a few days, but did not deem it necessary to send for a physician. His death is attributed to heart disease. His eldest son, R. C. Acton, who was at the World's

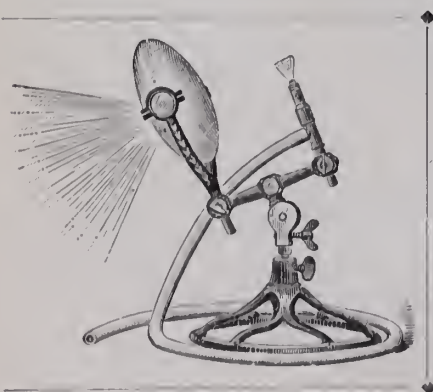

## F. W. GESSWEIN,

39 JOHN STREET,

NEW YORK.

## ENGRAVERS' REFLECTORS

FOR OIL OR GAS, SINGLE OR DOUBLE.

The Glass Reflecting Globe magnifies and concentrates the light, and can be adjusted to cast it on any desired point.

..... Circulars and Price Lists on Application .....





TORTOISE \* SHELL.

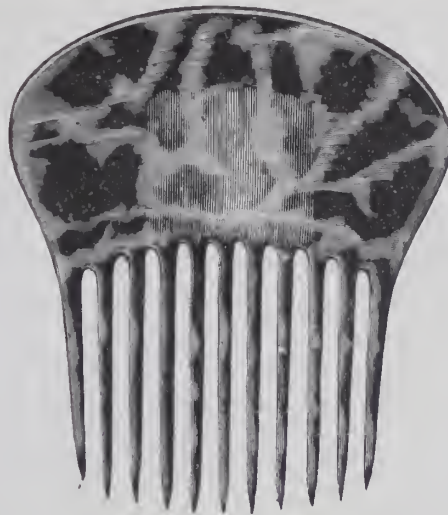

TORTOISE \* SHELL.



# RICE & HOCHSTER,

.... MANUFACTURERS, ....

483 & 485 Broadway,  
NEW YORK.

==>NEW STYLES ALMOST DAILY.<==



SPECIALTY: SALES OF  
JEWELRY, BRIC-À-BRAC  
AND  
ARTICLES OF VERTU



## The "Bryant" Rings.

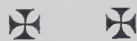
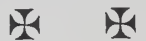

Are widely advertised and will sell  
when anything will, therefore  
every Retail Jeweler should buy them.

IF NOT CALLED UPON BY OUR TRAVELERS  
ORDER DIRECT FROM

**HENRY FERA,**  
IMPORTER OF DIAMONDS  
AND DIAMOND BORTZ,  
Diamond Cutting and Polishing Establishment,  
10 Maiden Lane, NEW YORK.

**M. B. BRYANT & CO.,**

10 MAIDEN LANE, N. Y.

OLDEST RING MAKERS IN AMERICA.

# EBONY AND SILVER TOILET ARTICLES.

IN NEW AND ELEGANT  
COMBINATIONS.



AS this combination is to be very fashionable this season, we have produced the most elaborate line on the market in Ladies' and Gentlemen's Toilet and Manicure Articles. These goods are mounted with pierced Sterling Silver, and decorated by the most artistic hand engraving.

A full line of these goods will make a beautiful window display. Send for samples.



## MADE IN

- |                         |                        |
|-------------------------|------------------------|
| HAIR BRUSHES.           | SHOE AND BUTTON HOOKS. |
| MILITARY BRUSHES.       | NAIL POLISHERS         |
| CLOTH BRUSHES.          | POWDER AND PUFF BOXES. |
| HAT BRUSHES.            | NAIL POWDER BOXES.     |
| BONNET BRUSHES.         | SHOE HORNS.            |
| GENTLEMEN'S COMBS.      | NAPKIN RINGS.          |
| LADIES' COMBS.          | PAPER CUTTERS.         |
| ROUND AND OVAL MIRRORS. | HAND BLOTTERS.         |
| WHISK BROOMS.           | NAIL FILES.            |
| PIN TRAYS.              | CORN KNIVES, etc.      |

## J. N. PROVENZANO,

GOLD AND SILVERSMITH,

No. 39 UNION SQUARE

NEW YORK CITY.

Fair, was telegraphed for, and has arrived.

The deceased was a leading jeweler of this town and was a highly respected citizen. Mr. Acton had been in business thirty years, and died possessed of considerable property. He recently took his son, R. C. Acton, Jr., into partnership, the firm name becoming R. C. Acton & Son.

**Arrest of a Gang of Men Charged With Burglary.**

NORFOLK, Va., Oct. 12th.—Detectives have succeeded in arresting George Taylor and Butler Blount charged with breaking into and robbing the jewelry store of Millard T. Pinner, in Suffolk. The men live here, and at their houses, it is alleged, was recovered a considerable quantity of the stolen goods, the rest having been sold by the thieves.

Charles Green, another suspect has been arrested in Suffolk. The men have been taken to Nansemond county jail.

**Of Interest to Columbian Souvenir Manufacturers.**

Geo. F. Kunz, gem expert for Tiffany & Co., New York, has been called upon to prepare a paper on the medallic history of the World's Columbian Exposition. He is now collecting copies of all medals or badges struck in commemoration of all events connected with the Exposition.

If manufacturers send copies to Mr. Kunz, care of Mines and Mining Department, Jackson Park, Chicago, Ill., until Nov. 1st, and after that date, care of Tiffany & Co., Union Square, New York, together with the facts stating why they were struck, whom they were cut by and other points of interest in connection with them, due credit will be given by the Society.

**Some Reminiscent Features About This Burglary.**

PHILADELPHIA, Pa., Oct. 12.—A robbery committed at the optical store of T. Haines Moore, Ridge Ave. and Spring Garden St., was reported last week. It is supposed that the thieves entered the store about 2 o'clock on Monday morning. The police report that the entrance to the place was effected by breaking the window on Spring Garden St., and that forty pairs of gold-rimmed glasses, valued at \$75 were stolen.

The proprietor tells a very different tale, however, and says his loss will not be less than \$300. After the men had broken the window and taken what they had wanted, they entered the store and packed up and carried off opera glasses, lenses, optical instruments and other valuable goods, and then unlocked the door leading to Ridge Ave. and after going out locked it again and carried off the key with them. The streets about the place are never without pedestrians and the electric lights on the corners make the surroundings of the store as bright as day.

The robbery was in many respects similar to that committed some time ago at McAlister's optical goods store, at 7th and Chestnut Sts., and the police suspect that it was the work of the same men.

**MORE DURABLE THAN IMPORTED,  
CHEAPER THAN IMPORTED,  
SUPERIOR TO IMPORTED.**



**FOX TAIL**

**CHAINS**

MADE BY

**BLANCARD & CO.,**

45 & 47 JOHN STREET, N. Y.

We keep a full Stock in 14 and 10 kt. Gold also in Silver. We make to order in 18 kt. Gold, Platinum, Aluminum Composition or German Silver.



**KETCHAM & McDOUGAL',**  
MANUFACTURERS  
GOLD & SILVER THIMBLES,  
GOLD COLLAR BUTTONS,  
AUTOMATIC EYE-GLASS HOLDERS,  
198 BROADWAY N. Y.

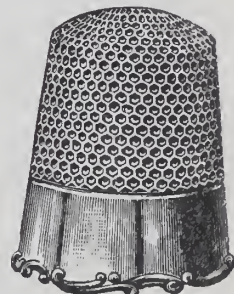

**Watches,  
Diamonds,  
Gold and Rolled Plate  
Jewelry.**



**TOOLS AND MATERIALS.**

Send for Price List.

Manufacturers of the **Centennial Watches.**

**CROSS & BEGUELIN, - 17 Maiden Lane, N. Y.**

**We Have Removed to** ○○○○○○○○○○  
**57 MAIDEN LANE.**

**LEONHARDT & CURRAN,**  
MANUFACTURERS OF DIAMOND MOUNTINGS.



**ARTISTIC  
METAL  
GOODS.**

NEW DESIGNS,  
NEW FINISHES.

Our line of Pitchers, Vases, Tables, Candlesticks, Five O'Clock Teas, Etc., cannot be equaled.

**THE  
CELEBRATED  
"B & H" LAMP.**



BEAUTIFUL DESIGNS,

particularly adapted to the Jewelry Trade.

SEE OUR LINE OF

TABLE, BANQUET AND PIANO LAMPS

before placing your orders. Send for our Little Book.

**BRADLEY & HUBBARD MFG. CO.**

NEW YORK, BOSTON, CHICAGO,  
21 BARCLAY ST., 160 CONGRESS ST. 88 WABASH AVE.  
26 PARK PLACE. Factories, MERIDEN, CT.

**"THE BEST BUTTON MADE."**

THE KREMENTZ

IN GOLD

FROM

**KREMENTZ & CO.**

And all Jobbers.



ONE PIECE

IN ROLLED PLATE

FROM

ALL JOBBERS.

**COLLAR BUTTON.**

IS THE ORIGINAL ONE PIECE BUTTON.

IS STILL THE BEST AND STILL UNSURPASSED.

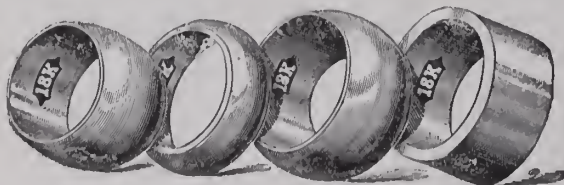

**PLAIN SOLID GOLD RINGS.**

**HILDRETH MFG. CO.,**

53 MAIDEN LANE,

NEW YORK.

**New York Jewelers Strenuously Urge  
Speedy Action by the Senate.**

At the last annual meeting of the New York Jewelers' Association, held Oct. 3d, a report of which was published in last week's CIRCULAR, a resolution was adopted authorizing the secretary to send the following letter to Senator David B. Hill, of New York. The letter was mailed Wednesday.

To David B. Hill, United States Senator,  
Washington, D. C.:—

"The New York Jewelers' Association, representing a large and influential body of manufacturers and wholesale dealers, would most respectfully call your attention and that of your fellow senators to the stagnation that has prevailed in our trade during the past three months; and the most unprecedented condition from which employer and employe alike are suffering. Factories, which during the ordinary panics have been able to run on short time, have this season been compelled to shut down completely. With the Winter rapidly approaching, the condition of the bench-worker can easily be imagined.

"Under these circumstances, and bearing in mind that the favorable action of the House of Representatives upon the repeal of the silver bill did, in a measure, restore confidence and cause an improvement in our trade conditions, and for a time gave confidence to the manufacturer and merchant, we cannot but look with impatience upon the long delay of the Senate to reach a conclusion in reference to the aforesaid bill. This delay seems to have paralyzed the improvement which was manifest a few weeks ago.

"This association, therefore, urgently requests through you that the Senate act promptly and favorably upon the bill that has been under discussion so long by the honorable body of which you are a member."

**The Assets and Liabilities of Alexander Davidoff.**

The inventory and schedules of Alexander Davidoff, 85 Nassau St., New York, who assigned Sept. 25th to Samuel Cohn, were filed with the clerk of the Court of Common Pleas, Wednesday last. They show assets nominally worth \$12,161.05, the actual value of which is \$4,228.98, and liabilities amounting to \$14,153.34. The assets consist of stock, accounts and the equity of \$500 nominally worth \$1,500 in a house at 261 Berry St., Brooklyn. There is a contingent liability on a bond given to secure the payment of \$1,500 in April, 1895, which accompanied a mortgage upon the premises at 261 Berry St., Brooklyn.

The creditors are: M. J. Lasar, R. A. Breidenbach, Frederick Goldsmith, assignee of Julius Bernstein, E. L. Anrich, John N. Disselkoe, Anna Davidoff, Louis Kleiman, Isidore Kioshneroff, Chas. Nepel, Noe. Trahan & Co., J. Macher, Nordt & Heppding, Ignatz Fried and A. Bantle.

W. J. Weichel, Scranton, Pa., has given a real estate mortgage for \$1,200.

# THE "CROMWELL"

PATENTED SEPT. 12TH, 1893.



W. B. DURGIN, Concord, N. H.

# Larter, Elcox & Co.

Manufacturers of Fine Gold Jewelry  
21 & 23 Maiden Lane, New York.



WE ARE READY FOR THE FALL TRADE.

## Rings, Seals, Spring Back Studs.

GENTLEMEN'S WHITE ONYX BUTTONS AND STUDS.

### "Old English"

Coffee Spoon.

\*\*\*



Towle Mfg. Co.,

MANUFACTURERS OF  
**STERLING SILVERWARE.**

NEWBURYPORT: No. 214 Merrimack St. CHICAGO: Nos. 149 & 151 State St.

## PROGRESSIVE PROSPERITY

is indicated when a  
Jeweler carries a full line of

**HOLMES & EDWARDS,**

SILVER : PLATED : FLAT : WARE.

STERLING SILVER INLAID.

XIV Extra Plate - - - fancy pieces with  
gilt, engraved, or gilt engraved bowls  
and blades.

BEAUTIFUL EFFECTS ARE PRODUCED.

Salesrooms: New York, Chicago, St. Louis.

THE HOLMES & EDWARDS SILVER CO., BRIDGEPORT, CONN.

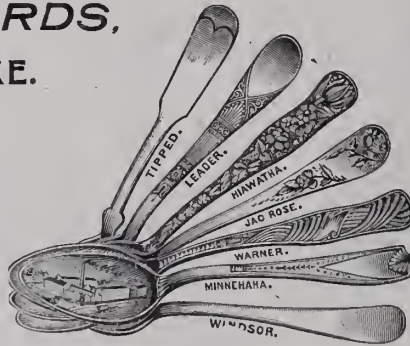

## Henry Goll & Co., WATCH CASE MAKERS

AND

### REPAIRERS.



The fact that we  
are constantly  
making New Cases  
to order, gives us

Facilities to do a General Line of Re-  
pairing possessed by No Other Repairing  
Establishment in this city. Hence we  
can finish all such work quickly, well and at  
reasonable figures.

No. 17 John Street, N. Y.

ESTABLISHED 1837.

## GEO. O. STREET & SONS,

MAKERS OF

Fine Rings, Locketts, Seals,

Sleeve Buttons and Links,

15 John Street, NEW YORK.



Elk, Shrine and Masonic  
Emblems a Specialty.

Badges of Every Known Order.

G. A. SCHLECHTER.

Manufacturing Jeweler,

READING, PA

**R.W. TIRRELL.**  
THE  
**JEWELERS AUCTIONEER.**  
114 PEMBROKE ST.  
BOSTON, MASS.  
MY METHODS ARE  
SUCCESSFUL  
REFERENCES NUMEROUS.  
TERMS REASONABLE.  
ALL CORRESPONDENCE CONFIDENTIAL.

# R., L. & M. Friedlander,



IMPORTERS OF  
**DIAMONDS.**

WHOLESALE  
**JEWELERS.**

JOBBERS IN  
American Watches.

Tools, Materials, and Optical Goods.

Send for Catalogue.

65 & 67 Nassau Street, New York.

### Three Famous Silver Yachting Trophies.

(Continued from page 1.)

tume carving a model of the *Puritan*. The figure is as graceful and attractive as the thought. An ingenious idea is carried out in the design of the Dutch tankard, the first testimonial presented to General Paine. The original *Mayflower* bringing over the Pilgrims is represented below the two figures in bas-relief. The woman is a type of the original Puritan mother who braved the ocean voyage on the first *Mayflower*, and the boy is her brave Yankee son of to-day holding a model of the yacht *Mayflower* in his arms. The *Volunteer* cup is not so significant in design, but is no less beautiful in workmanship; here the artist has sought the company of sea nymphs and mermaids, and the nereid is presented in a swirl of water which can scarcely be distinguished from her own wealth of hair.

These trophies are displayed in the wonderful exhibit that the Whiting Mfg. Co., who have made all the cups presented to the International Yacht Race victors with the exception of the America's cup, have arranged in the four spacious windows of their store, 18th St. and Broadway, New York, reference to which was made in these columns last week. There is also in this exhibit the famous loving cup presented by the New York Yacht Club to Capt. J. R. Busk, in recognition of his ability in defending America's cup in 1881, defeating the Canadian yacht *Atlanta* with his yacht *Mischief*.

#### Murtagh's Pickings and Stealings Temporarily at an End.

PATERSON, N. J., Oct. 13.—William Murtagh, who was indicted for stealing a tray of diamonds from the store of E. P. Wheeler, 202 Market St., on June 7th, was convicted this week, the jury not leaving their seats.

Murtagh who is a rather fine looking, athletic young fellow, went in Mr. Wheeler's store and asked to see some diamonds. William H. Howe, in charge of the store at the time, set out a tray containing twenty-four diamond rings. None of these seemed to suit and Murtagh asked to see another assortment. When the salesman turned to get another tray, Murtagh, picking up the one in front of him, ran off with it. After a hot chase the thief was captured and most of the rings recovered.

Burglars raided the jewelry store of M. G. Mohler, Gilman, Ill., some nights ago, blew open the safe, and succeeded in getting away with \$100 in money and \$500 worth of watches and jewelry. The burglars entered the store through the front door by means of a skeleton key. They drilled a hole in the safe near its top. The explosion wrenched the door from its hinges and hurled it entirely across the room.

#### New Officers of the New York Jewelers' Board of Trade Elected.

A meeting of the directors of the New York Jewelers' Board of Trade, took place Thursday, at the rooms of the board, 41 Maiden Lane, New York. The resignation of Edmund J. Scofield, as president and director was accepted, and August Oppenheimer



AUGUST OPPENHEIMER,  
PRESIDENT, N. Y. JEWELERS' BOARD OF TRADE.

mer of Oppenheimer Bros. & Veith, the first vice-president, was unanimously elected in his place.

The second vice-president, Geo. E. Fahys, of Jos. Fahys & Co., was elected as first vice-president and A. J. G. Hodenpyl, of Hodenpyl & Sons, was elected second vice-president. Thos. K. Benton, of the Courvoisier-Wileox Mfg. Co., was elected a di-

rector in the place of F. R. Simmons, of Henry Ginnel & Co., resigned.

Mr. Benton also succeeded Mr. Simmons as a member of the arbitration committee. Leopold Stern, of Stern Bros. & Co., was elected a director to succeed Mr. Scofield, and was made a member of the finance committee in the place of Mr. Oppenheimer, who had become president.

The banquet committee as appointed, consists of Geo. E. Fahys, of Jos. Fahys & Co., Max J. Lissauer, of Lissauer & Co., E. V. Clergue, of the E. Howard Watch & Clock Co., T. K. Benton, of the Courvoisier-Wileox Mfg. Co., A. J. G. Hodenpyl, of Hodenpyl & Sons, David Keller, of Keller, Ettinger & Fink, Geo. W. Van Deventer, of the Waterbury Clock Co., and President Oppenheimer, *ex-officio*.

#### The Assets and Liabilities of Julius Bernstein.

Frederick Goldsmith, assignee of Julius Bernstein, 48 Maiden Lane, New York, filed the inventory and schedules of the debtor's estate on Thursday. They show the liabilities to be \$64,702.47 of which \$11,933.40 is contingent. The assets are nominally worth \$54,827.63 and actually, \$28,853.94.

The assets consist of stock, nominal value \$27,038.69, actual value \$16,419.33; bills receivable, nominal value \$8,707.19, actual value \$4,237.03; bills receivable discounted by the Importers' and Traders' National Bank, and the National Butchers' and Drov-

# LE BOUTILLIER & Co.,

860 BROADWAY,

N. E. cor. of 17th St., - NEW YORK,

Invite an Inspection of their Novelties in

**Real Bronze Busts,  
Decorated Lamps,  
Gilt Mounted Faience Clocks,  
Enameled Clocks,  
Real Bronze Clock Sets,  
Plaques, Bisque, Sevres Vases,  
Pedestals, French Bronze Busts,  
Groups, Etc., Etc.**

**NO OLD STOCK IN THIS DEPARTMENT.**

ers' Bank, nominal value \$11,933.40, actual value \$6,081.70; open accounts, nominal value \$3,807.77, actual value \$2,153.30; cash in bank \$205.33; cash in drawer \$7.25; real estate in Chicago, Ill., nominal value \$2,400, actual value \$600, and office safe, furniture and fixtures, nominal value \$728, actual value \$150.

The liabilities are \$51,949.07 for goods sold and delivered, and \$820 for borrowed money. The contingent liabilities of \$11,933.40 are for moneys advanced on discounts by the Importers' & Traders' National Bank and the Butchers' and Drovers' National Bank.

The creditors are: M. J. Lasar, Maurice Weil, Vve. L. B. Citroen & Co.; Herzog, Goldsmith & Frank; Koch, Dreyfus & Co.; L. & M. Kahn & Co.; Eichberg & Co.; Stern Bros. & Co.; M. Ullman, Antwerp, Belgium; M. Fehrer & Co.; Eisenmann Bros., Paris, France; Mani Daniels; W. L. Strasburger & Co.; Lindenbaum & Weil, London, England; Kryn, Hybrechts & Fils, Amsterdam, Holland; E. L. Gordon and Bertha Bernstein.

#### A Custom House Broker Arrested Charged With Irregularities.

PHILADELPHIA, Pa., Oct. 14. — John L. Vandiver, a custom house broker, has been arrested for irregular operations in connection with an importation for the optical house of T. A. Willson & Co., Reading, Pa. There was entered at this port from London on Aug. 1st a lot of glass lenses, consigned to Vandiver, as broker for the firm of Will-

son & Co. Vandiver, it is said, notified Willson & Co. of the consignment, at the same time sending on a blank affidavit for them to sign. This was in connection with the usual declaration of ownership by means of which dutiable goods are delivered.

Willson & Co.; signed the declaration and forwarded it to Vandiver in this city. He then made out an affidavit in their behalf, and placing upon it his official seal, he presented it to the Custom House, where he succeeded in getting the goods in free. A short time afterward the examiner of the department reported fraud in the matter and Vandiver was compelled to pay over to the Government a considerable sum for duties.

Vandiver's commission as notary was revoked by Governor Pattison, and an investigation by the Treasury Department led to his arrest yesterday. He was released on \$2,500 bail, pending a hearing before the U. S. Commissioner next week.

#### Traveler Boergershauser's Trunks Rifled of Their Contents.

CHICAGO, Ill., Oct. 16.—The jewelry trunks of F. A. Boergershauser, traveler for F. M. Sproehnle & Co., were broken open at Earlville, Ill., Friday morning and part of the contents stolen. Mr. Boergershauser on his arrival at Earlville could not secure the services of a team to take his trunks to the hotel, and left them checked in the baggage room at the depot. When he returned later with a conveyance, the trunks had been broken open and their contents, minus some plain gold rings, chains, watch cases and

movements, lay strewn about the room.

The salesman carried a line of diamond goods, but it is understood at this writing that none are missing. No inventory has yet been taken and the extent of the robbery is not known. The contents were valued at between \$8,000 and \$10,000, and were fully insured with the Jewelers' Protective Union. The firm telegraphed Boergershauser to bring in his trunks and he returned Saturday afternoon and gave full details to the Messrs. Sproehnle of the robbery.

At the conclusion of the conference F. M. Sproehnle stated that the salesman did only what any commercial traveler would have done and that no blame attached to him in any way. It is thought that the thieves are green hands at the business and Pinkerton's detectives are on the ground

#### The Geneva Optical Co. Change Their Name.

ALBANY, N. Y., Oct. 11.—Notice has been given that the Geneva Optical Co., of Geneva, have made their petition to the Supreme Court, under the provisions of section 2,413 of the Code of Civil Procedure, that they be allowed to change their name to that of the Standard Optical Co., and that said petition will be presented to the Supreme Court at a special term thereof appointed to be held at the Court House in Rochester, Monroe county, on the last Monday of November, 1893, at 10 o'clock a.m. of that day or as soon thereafter as counsel can be heard.

BUY ONLY THE BEST

Electro Silver Plated Flatware,

STAMPED

★ ROGERS & BRO., A. I.

THE ORIGINAL, GENUINE AND CELEBRATED

**STAR ★ BRAND**

Which has stood the test for fifty years.....

.....For sale by all first-class jobbers.

MADE ONLY BY

**ROGERS & BROTHER,**

**Waterbury, Conn.,**

**16 Cortlandt St., N. Y.**

SEND FOR NEW ILLUSTRATED CATALOGUE, NOW READY.



**Marcus Koenigheim Foully Murdered by a Burglar.**

SAN ANTONIO, Tex., Oct. 10. — Marcus Koenigheim, one of the oldest, wealthiest and most highly respected citizens of San Antonio, was murdered and robbed some time last night, his dead body being found at 5 o'clock this morning, with a bullet hole through the head, lying in the hall at the foot of the front stairs of his residence.

Mr. Koenigheim had been for many years one of the most prominent jewelers of the city. In the back of the lower hall of his residence he had a large iron safe, which was opened with a key. In this safe he had a large stock of money and goods, amounting in value to fully \$25,000. He and his family spent the evening with friends, returning home at 12 o'clock.

The safe was opened and rifled of all the

money, jewels and valuables. The burglar had entered by way of the dining room window, and proceeding up stairs had secured Mr. Koenigheim's trousers, from the pocket of which he took the key to the safe and a pocketbook containing a considerable sum of money. It is supposed that Mr. Koenigheim heard the noise and made some move to investigate when he met his death.

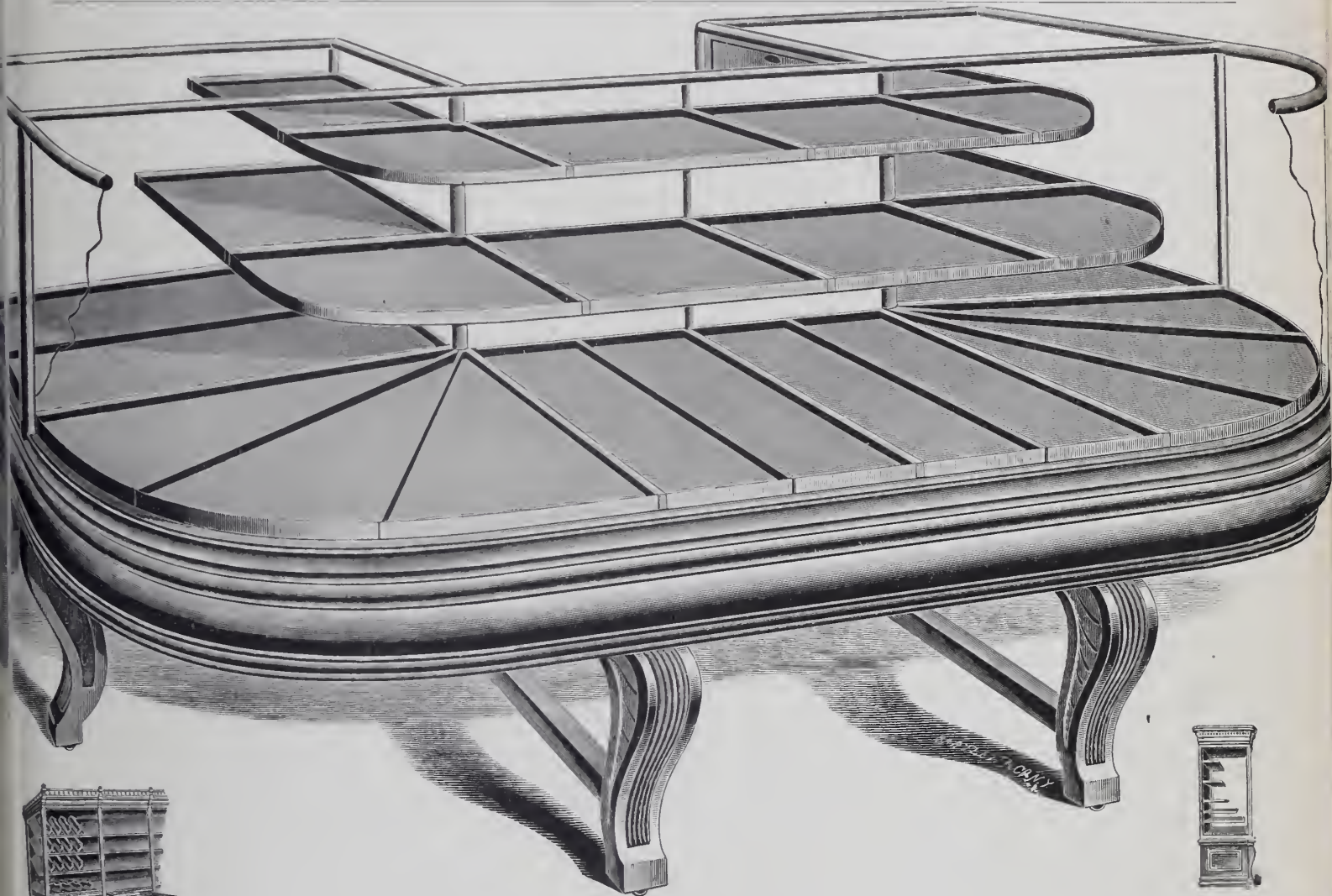

Special "Tray System" for Wall Cases.

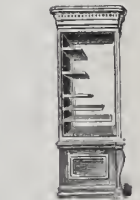

Rows of Trays, applied to Wall Cases.

**THE "FLETCHER PATENT SYSTEM OF TRAYS,"**

AS APPLIED TO "U" CURVED OR HORSESHOE CASES;  
CAN BE INTRODUCED IN ANY KIND OF CASES.

The Trays are all removable and are invisibly supported. There is no obstruction whatever. The entire floor, also the space between the trays is clear space room to work in. Viewed from the front, end, or at the back, nothing can be seen nor touched but the trays. When a tray is removed, there is nothing but clear space left. We have shown two upper rows of trays. The effect is precisely the same, with from one to seven rows of trays.

IN USE IN THE MAJORITY OF THE LEADING STORES IN THIS COUNTRY.

SEND FOR ILLUSTRATED CATALOGUES.



End View, showing clear space.

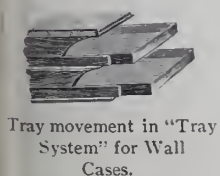

Tray movement in "Tray System" for Wall Cases.

**FLETCHER MFG. Co.,**

259 WEST 27TH STREET,  
NEW YORK.

### World's Fair Awards of Interest to the Jewelry Trade.

CHICAGO, Ill., Oct. 16.—During the past week the following awards of interest to the jewelry trade have been made:

#### TRAVELING EQUIPMENTS, CANES AND UMBRELLAS.

The medals awarded Wednesday in Group 108, of manufactures, were for traveling equipments, canes, umbrellas, etc. Among those of interest to the jewelry trade are:

Tiffany & Co., umbrellas, canes, fancy bags and pouches, card cases and portfolios, silverware and jewelry cases, valises, dress suit cases and hand bags, toilet articles, leather of animals, birds, reptiles, fishes.

William Demuth & Co., smokers' articles, meerschaum pipes mounted with amber, metal show figures.

Gorham Mfg. Co., pocket books silver mounted, card cases, traveling bags silver mounted, hand bags silver mounted, leather cases silver mounted, portfolios silver mounted, purses silver mounted, cigar cases silver mounted.

#### BRONZES, ENAMELS, LAMPS AND BRASS GOODS.

In Group 93 of manufactures awards have been granted on bronzes, enamels, lamps and brass goods.

Tiffany Glass and Decorating Co., tabernacle door in gold filigree, two table lamps in gold and copper filigree, hanging lamps, two altar crosses of gold, and candlesticks.

Tiffany & Co., niello work, champ levé enamels.

Maurice J. Powers, bronze statues, reliefs, and busts.

Miss S. H. Emerson, Normandy copper jug, brass jar with cover.

Miss Pauline Van Knyck, photo frame, repoussé work.

Gorham Mfg. Co., statuary in silver, bronze, and brass; hand paintings on enamel; cloisonné enamel on silver; champ levé, and translucent enamel on silver.

Mrs. F. M. Russel, Omaha, Neb., silver candelabra.

The cloisonné enamels in the Japanese section form a most important item.

#### HAIR GOODS, BRUSHES AND SHELL COMBS.

In group No. 107, Department of Manufactures, the following awards were granted Thursday on hair goods, brushes and shell combs:

E. Burnham, Chicago, hair jewelry.

India Rubber Comb Co., New York, combs, brushes.

Rice & Hochster, New York, tortoise shell, articles.

E. Hansen, Philadelphia, three awards for valentine novelties, jewel cases, pearl tables.

Mermod-Jaccard Jewelry Co., novel forms of illuminating and emblazoning on paper in gold, silver, bronze and colored ink.

Awards in group 89, Manufactures, comprising stationery and paper, were made as follows:

Dennison Mfg. Co., four awards for tags, stationery goods, cases for jewelry, and paper boxes for jewelry.

B. Grieshaber, gold pens.

Crown Pen Co., three awards for pens, fountain pens and gold pens.

L. E. Waterman & Co., Ideal fountain pens; Shattuck Pen Co., fountain pens.

Tiffany & Co., three awards of fine stationery, writing paper, cards.

Mermod & Jaccard Jewelry Co., society stationery.

In history and literature of mining and metallurgy, George F. Kunz, of New York, was awarded medals for statistics and history of mining for gems and precious stones; portraits of mineralogists, geologists, gems, minerals, etc.; books and pamphlets on gems, precious stones and mining mineralogy; also for his book, "Gems and Precious Stones of North America." Mr. Kunz is gem expert for Tiffany & Co.

Tiffany & Co. received an award in Group 66, Department of Mines and Mining, for collective exhibits of gold and silver alloys.

The New England Manufacturing Jewelers' Association's collective exhibit of jewelry at the Fair received five medals and diplomas which pertain to the exhibit as a whole. The 1st award was for a general line of jewelry; 2d, chains; 3d, charms; 4th, lockets; 5th bracelets. These awards being collective entitle every exhibitor of the Association to use same and receive the credit of, being a part of the general whole to which awards were granted.

Queen & Co. have obtained five awards so far. Other departments are yet to be heard from.

### The Death of Eugene S. Crump.

BOSTON, Mass., Oct. 16.—The funeral of Eugene Stanwood Crump, son of C. H. Crump, of Shreve, Crump & Low Co., took place Monday, Oct. 9th.

The deceased was connected with the concern three years in the foreign goods department. He had been ill since May, and died Oct. 6th at the age of twenty-six. He was unmarried. The employes sent a handsome floral tribute.

### A Former New York Jeweler Dies in Kansas City.

KANSAS CITY, Mo., Oct. 17.—Theodore W. Hasse, formerly a retail jeweler in New York, died here Sunday of consumption. He was on his way home from Pasadena, Cal., where he had been for the benefit of his health.

### Several Jewelry Firms in Maiden Lane Suffer Through Fire.

The first fire that has occurred in Maiden Lane, New York, for several years broke out at No. 4, at about 3.15, Thursday afternoon. The building which is a five story structure, was wholly occupied by jewelers. The fire is supposed to have started under the stairs on the second floor, traveling quickly up the stairs and walls to the roof. The two upper floors were completely destroyed and the third floor badly burned. The second floor suffered but little and the ground floor escaped damage except by water and smoke.

The heaviest loss, outside that of the building, which is owned by a Mrs. Alice Y. Eaton, will fall upon Dattelbaum & Friedman, who had an office upon the third floor, and a factory occupying the entire top floor. The damage to their stock, fixtures and machinery is estimated at between \$6,000 and \$7,000, and is fully covered by insurance. The store on the ground floor is occupied by J. T. Scott & Co. and the Julius King Optical Co. The former suffered slight damage by water, while the latter's loss has not yet been estimated.

Henry Dreyfus & Co. occupied the front of the second floor. The damage to their fixtures was about \$500. Hayden W. Wheeler & Co., who occupy the rear of this floor as an annex to their floor at No. 2, suffered slightly by water and smoke. A. M. Bachrach & Bro., jobbers in watches, and E. Sheffer, retail jeweler, on the third floor, each lost about \$250 on fixtures. Both firms were insured. The loss of H. A. Hovet and W. H. Shipman, who have offices on that floor, amounted to about \$50 in each case.

The shops of Jos. A. Feinier, manufacturing jeweler and repairer, and H. L. Smith, general repairer, on the fourth floor, and the factory of Dattelbaum & Friedman, on the top floor were almost completely destroyed. Mr. Feinier is insured for \$3,000, and Mr. Smith for \$1,000.

The fire was first discovered by Jacob Friedman, who saw smoke and flames coming from the bottom of the stairs on the second floor. He quickly notified the tenants on the third floor and from the fire-escape called to a policeman who gave the alarm. Jos. Bachrach rushed upstairs and notified the remainder of the occupants who escaped by the roof and the fire escape. When the engines arrived a few minutes later, flames were pouring from the upper windows of the building. The fire was quickly put under control, but not, however, until it had spread through the three upper floors. Chas. S. Brown, 59 Liberty St., the agent for the building, says the loss to it has not yet been estimated. It is insured for \$15,000.

Jos. A. Feinier and H. L. Smith have removed temporarily to 39 Maiden Lane.

Morris Lewin, 227 N. Front St., Philadelphia, Pa., is reported to have been closed out by Wm. Morris & Co.

# The Jewelers' Circular

AND  
HOROLOGICAL REVIEW.

PUBLISHED EVERY WEDNESDAY BY

THE JEWELERS' CIRCULAR PUB'G CO.,  
189 BROADWAY, NEW YORK CITY.

A JOURNAL DEVOTED TO THE INTERESTS OF JEWELERS, WATCHMAKERS, SILVERSMITHS, ELECTRO-PLATE MANUFACTURERS, AND ALL ENGAGED IN KINDRED BRANCHES OF INDUSTRY.

Our Editorial columns will contain our own opinions only, and we shall present in other columns only what we consider of interest or value to our readers. Advertising matter will not be printed as news.

Advertising rates in THE CIRCULAR are lower, considering the number of tradesmen reached by its large circulation, than in any other jewelry journal.

Notices of changes in standing advertisements must be received one week in advance; new matter can be received up to Monday.

## INFORMATION FOR SUBSCRIBERS.

### Terms of Subscription, Postage Prepaid.

	PER ANNUM
United States and Canada, . . . . .	\$2.00
Foreign Countries in Postal Union, . . . . .	4.00
Single Copies, . . . . .	.10

New subscribers can commence at any time.

Payments for THE CIRCULAR, when sent by mail, should be made in a Post Office Money Order, Bank Check or Draft, or an Express Money Order or Registered Letter. All postmasters are required to register letters whenever requested to do so.

Pay money only to authorized collectors having proper credentials.

Returning your paper will not enable us to discontinue it, as we cannot find your name on our books unless your address is given.

In changing address always give the old as well as new one. Your name cannot be found on our books unless this is done.

We will continue to send papers until there is a specific order to stop, in connection with which all arrearages must be paid. But such an order can be given at any time, to take effect at the expiration of the subscription. All such orders will be promptly acknowledged by mail.

The Courts have decided that all subscribers to journals are responsible until arrearages are paid in full and an order to discontinue has been received by the publisher.

Member of the American Trade Press Association.

VOL. XXVII. Oct. 18, 1893, No. 12.

## A New Art Among Retailers.

TO judge from the lack of originality and ingenuity displayed in the designs offered in the window design contest, conditions governing which are given under the department, Suggestions for Window and Store Decoration, it should be an easy matter for an ordinarily clever window dresser to win the prize. While a few of the designs submitted contain some suggestions worthy of being adopted, none are particularly felicitous. This mediocrity emphasizes a truth which this journal has seen for some time, namely, that retail jewelers generally do not exercise the care in dressing their windows that the subject warrants. THE CIRCULAR, therefore, has for over two years devoted considerable of its space to a department for the encouragement of artistic window decoration, and has presented to the trade by means of pen and graver over fifty distinct and effective designs, every one of which has contained suggestions more or less worthy of accepta-

tion. The mediocrity above referred to, we feel, makes this department more necessary than ever before, and it therefore will be energetically continued.

## Debate In the Senate.

THE judicious action on the part of the New York Jewelers' Association in forwarding a letter to Senator David B. Hill, in which this organization urges the Senate to speedily reach a conclusion in reference to the bill passed by the House of Representatives, repealing the purchasing clause of the Silver Bill, it is to be hoped will receive the consideration it deserves. The New York Jewelers' Association echoes the sentiments of numerous trade organizations, prominent among them being the Board of Trade and Transportation, of New York, which last week adopted a resolution dealing with the delay in the Senate and urging a cutting off of useless debate in this way:

*Resolved*, That the Vice-President of the United States be respectfully but earnestly requested to give notice to the Senate that after a stated reasonable time he will refuse to recognize any senator for the purpose of making a motion or a speech upon the Voorhees repeal bill which in his judgment is dilatory.

The developments taking place in the Senate are being watched with an interest which is growing in intensity as the days go by without decisive action. During the last fortnight there has unquestionably been a marked relaxation of the previous contraction of credits in anticipation of ultimate favorable action by the Senate upon silver repeal, but there is little to be hoped for from any compromise measure which would give no guarantees for the disappearance of a question which involves the entire national credit and the stability of the real business interests of the whole country.

## Peddling and Drumming in Connecticut.

IT is seldom that a new statute has excited such immediate dissatisfaction as the new peddler's law in Connecticut. The question of its constitutionality has been taken to the Supreme Court of the State by Philip Silverthau, of New Haven, who was arrested in Waterbury, and fined \$100 for selling without a license. The main section of the law reads:

Section 1. The mayor of any city, the warden of any borough, and the selectmen of any town, may issue a license to such persons as they find proper persons to engage in a temporary or transient business, in one locality, either in a building, tent or other premises, for the sale of goods, wares and merchandise, and may also issue licenses to such persons as they find proper persons to engage in the business of auctioneer, peddler or hawker of goods, wares and merchandise, or as traveling itinerant purchasers of junk or other second-hand goods, in their respective cities, boroughs or towns, for a term not exceeding one year, upon the applicant paying to such municipal corporation a fee not less than \$1 nor more than \$100, as the authority issuing such license may direct; but this section shall not authorize the selectmen of any town to issue any license within the limits of any city or borough.

Apart from the question of the constitutionality of the law, Mr. Silverthau denies that he is a peddler in the meaning of the law,

but claims that he is rather a drummer for a house which pays full taxes in New Haven, that he and his goods are in that city nearly every night and that he does not wander about the country dodging the tax collector. Mr. Silverthau is of the house of S. Silverthau & Sons, who are retail jewelers. It is understood that he will be backed by prominent New York and Connecticut firms. We fail to see how the law can reach representatives of wholesale houses in the regular and customary conduction of their business with the retailers. It is therefore to be inferred that the backers of Mr. Silverthau are the instalment dealers and the like, who send out agents to solicit trade from the public. It is but justice to the tax paying jewelers and others of the different cities, boroughs and towns that a license be exacted from persons who sell in their communities without paying any taxes in them. A peddler's license law is in active force in many States.

## The Week in Brief.

THE New York Jewelers' Board of Trade elected a president in place of Edmund J. Scofield—The schedules of Julius Bernstein, New York, were filed—William Murtagh was convicted of robbing the store of E. P. Wheeler, Paterson, N. J.—Burglars blew the safe in M. G. Mohler's store, Gilman, Ill.—The man who burglarized the store of Ferdinand Wagner, Cincinnati, O., is supposed to have been located—The Hollander Jewelry Co., Salt Lake City, Utah, incorporated—The death of Richard C. Acton, Alexandria, Va., occurred—Philip Silverthau, New Haven, Conn., will test the constitutionality of the law regulating peddling in that State—The men who robbed the store of M. T. Pinner, Suffolk, Va., were captured—The store of T. H. Moore, Philadelphia, Pa., was burglarized—The New York Jewelers' Association sent a letter to Senator David B. Hill urging speedy action on the part of the Senate, on the Repeal bill—The schedules of Alexander Davidoff, New York, were filed—The trunks of F. A. Boergershauser, traveler for F. M. Sproehnle & Co., Chicago, were rifled by thieves—The Geneva Optical Co., Geneva, N. Y., will change their name—Otto Baehr, St. Louis, Mo., offers 35 per cent. in settlement—Marcus Koenigheim, formerly a jeweler of San Antonio, Tex., was murdered—E. A. Freeman was made permanent receiver of the E. N. Welch Mfg. Co.—Samuel Levy, "gold dust" swindler, was sentenced in Hamilton, Ont.—The death occurred of August Bergstein, of Bergstein & Son, New York—Henry Müller, New York, failed—The store of P. C. Frutchey, Meshoppen, Pa., was burned out—The store of N. W. Udall, West Randolph, Vt., was damaged by fire—L. Brandt & Co., Memphis, Tenn., assigned—The firms in the building at 4 Maiden Lane, New York, suffered more or less from a brisk fire—The death occurred of E. S. Crump.

### New York Notes.

George Agassiz and son will sail for Europe on *La Touraine* the 21st inst.

L. Straus & Sons have entered a judgment for \$62.29 against Louis Wendel.

E. I. Franklin & Co. have entered a judgment for \$357.06 against Ludwig Hess.

L. S. Meyer & Bros., 39 Maiden Lane, will remove Nov. 1st to 42 Maiden Lane.

Simon Greenbaum, 8 Division St., confessed judgment last week to F. Breslauer for \$2,038.62.

Henry Zimmern, of Henry Zimmern & Co., leaves to-day for a two weeks' visit to the World's Fair.

Louis Kantrowitz, 102 E. Houston St., has given a chattel mortgage on jewelry fixtures to B. Reimer, for \$275.

M. & H. Rosmarin, 384 Grand St., have given a chattel mortgage on jewelry fixtures to the State Bank for \$275.

Max Gottlieb, 208 Eldridge St., has given a bill of sale on jewelry fixtures to M. Gottlieb for a consideration of \$1.

The sheriff Thursday received an execution for \$3,999.70 against Mendall Newman, 17 Ludlow St., in favor of Firuski & Son.

William Gibson, of London, arrived in New York from Europe Sunday on the *Etruria*. Edmond Johnson, of Dublin, arrived on the *Britannic* last Wednesday.

Tiffany & Co. are making preparations for the accommodation of their World's Fair exhibit which will be shown at their store directly after the close of the World's Columbian Exposition.

By an error in the last issue, the name of B. H. Davis & Co. appeared in the list of the creditors of H. C. Whittier & Son. This firm state that they are not and have never been creditors of Whittier & Son.

Judgments against Geo. C. Taylor, formerly doing business as Taylor & Brother, 860 Broadway, were entered last week by Henry Dreyfus & Co., for \$2,540.27 and by F. H. Carpenter for \$7,861.10.

Haywood L. Cozzens, the well-known and popular buyer for Tiffany & Co., is dangerously ill with typhoid fever at his home. The illness is the result of a cold, followed by exposure while camping the past Summer.

Decrees were entered Thursday in the suits brought by Durlach Bros. and A. Pinover & Co., against Morris Ginsburg, by which these plaintiffs will share the benefits accruing from the setting aside of Ginsburg's assignment.

Assignee Engel, of S. Lyons & Son, expects that the property of that firm will be re-assigned to them during this week, or as soon as the consent of Receiver McClure, of the National Bank of Deposit, can be obtained to the extension which Lyons & Son ask.

Pursuant to an order of Judge Giegerich, of the Court of Common Pleas, Samuel

Greenbaum, the assignee of C. Cottier & Son, is advertising for the creditors of that firm to present their claims to him at his office, 170 Broadway, on or before December 27th.

At the meeting of the watch case and movement manufacturers, held Oct. 10th, the committee appointed to draw up resolutions for taking concerted action in regard to failures reported, but the resolutions were not acted upon and it was decided that no definite steps be taken at present.

The Sheriff last week took possession of the office of B. M. Wurzburger, jobber in jewelry, 9 Maiden Lane, on an execution for \$496.84 in favor of Frederick Kaffeman, for goods sold and money loaned. Bernard Wurzburger failed about eighteen months ago and compromised at twenty-five cents on the dollar. He has since carried on business in the name of his sister, Bertha M. Wurzburger.

The *Commercial Advertiser* of Oct. 11th under the head of "Some Jewelers who are Well Known and Have Been Successful," gave brief sketches of Monroe B. Bryant, Byron W. Green, John H. Knapp, Hayden W. Wheeler, Henry C. Haskell, Howard Kirkpatrick, George R. Jaques, C. W. Schumann, W. C. Roberts, of the New York Standard Watch Co., Charles L. Tiffany, Doty and Wm. L. Sexton.

Johonnot Bros., 51 Maiden Lane, were the complainants in the Tombs Police Court Wednesday against Frederick Best, 55 Middaght St., Brooklyn, who, they said, had purchased a watch from them on instalments, paying \$10 down, and then disposed of it to a third party. Justice Meade held Best in \$1,000 bail to await the action of the Grand Jury. John Behrens, manager of the Syndicate Watch Co., 11 E. 14th St., stated that Best had tried the same game on him.

At the first series of games of the Maiden Lane Bowling Association played between clubs from Aikin, Lambert & Co., Hayden W. Wheeler & Co., and Jos. Fahys & Co., at the New York Hotel, Tuesday, Oct. 10th, the club from Hayden W. Wheeler & Co., proved the victors. The second series were played last night at the same place. The contesting clubs were from the Keystone Watch Case Co., N. H. White & Co., and Aikin, Lambert & Co.

The suit of Mary C. Steinhauser, the substituted assignee of Charles Magnus, against Lippman Tannerbaum and Jas. McCormick was tried before Judge Barrett, of the Supreme Court, Friday, and judgment for \$15,000 was allowed for the plaintiff. The suit was brought to recover on an undertaking given by the defendants on an appeal made by John Mason from a judgment against him obtained for goods purchased from Charles Magnus. The judgment against Mr. Tannenbaum was not entered, as it is expected that it will be satisfied this week.

Spott & Spott, Richmond, Va., have offered to compromise with their creditors at

50 per cent. in the following payments: 16 $\frac{2}{3}$  per cent. cash, 16 $\frac{2}{3}$  per cent. in three months, and 16 $\frac{2}{3}$  per cent. in six months, the last two to bear interest at 6 per cent. The agreement is to be binding only if 90 per cent. of the merchandise creditors for over \$100 sign. The matter has been put into the hands of the New York Jewelers' Board of Trade whose attorneys at Richmond succeeded in inducing the embarrassed firm to increase their original offer of 40 per cent. to 50 per cent.

Henry Müller, an importer of diamonds, in the Fulton Building, 89 Nassau St., has failed. A judgment for \$3,879.20 in favor of A. Latier was entered against him Friday and an execution issued to the sheriff. Blumenstein & Hirsch, the plaintiff's attorneys, state that the execution was returned unsatisfied as there was nothing in the office to levy on. Gibson Putzel, Mr. Müller's attorney, refused positively to give any information regarding his client's affairs. Mr. Müller has been in the diamond business about three years. He was formerly a manufacturing jeweler. His liabilities are estimated by the trade at about \$50,000 the bulk of which are to European creditors.

### Last Week's Arrivals.

**THE CIRCULAR has perfected arrangements for obtaining the names and hotel addresses of all the latest buyers visiting New York, and each day posts in its office, 189 Broadway, a bulletin which every member of the trade is cordially invited to copy.**

The following out-of-town dealers were registered in New York during the past week: D. Greenleaf, of Greenleaf & Crosby, Jacksonville, Fla., St. Denis H.; W. E. Carter, Portland, Me., Astor H.; W. Clark, Philadelphia, Pa., Astor H.; I. Fox, Philadelphia, Pa., Grand H.; W. E. Norcross, buyer for Houghton & Dutton, Boston, Mass., Imperial H.; J. A. Becker, buyer for J. G. Meyers, Albany, N. Y., Metropolitan H.; F. M. Brown, New Haven, Conn., 108 Worth St.; S. Tappin, Troy, N. Y., Normandie H.; L. Rosenbaum, buyer for Rosenbaum & Co., Pittsburgh, Pa., Belvedere H.; J. W. Field, Galveston, Tex., St. Denis H.; J. R. Hirst, Philadelphia, Pa., Astor H.; C. Hellebush, Jr., Cincinnati, O., Imperial H.; C. H. Duhme, Cincinnati, O., Holland H.; H. O. Jewett, Cortland, N. Y., St. Stephens H.; A. Levy, Hamilton, Ont., Astor H.; J. E. Gallagher, Boston, Mass., Grand Union H.; L. E. Kirstein, Rochester, N. Y., Imperial H.; Mr. Fox, Cincinnati, O., Grand Union H.; J. W. Morehouse, buyer for the H. M. Brown Co., Cleveland, O., Broadway Central H.; S. B. Goldsmith, Pittsburgh, Pa., Imperial H.; J. J. Freeman, Toledo, O., Savoy H.; S. Lesser, Syracuse, N. Y., Imperial H.; F. A. Davis, Toronto, Ont., Bartholdi H.; W. A. Smith, Smith & Wardwell, Washington, D. C., Astor H.

Solid Silver  
Exclusively.



WHITING M'F'G Co.

SILVERSMITHS,

Broadway & 18th Street,

NEW YORK.

WORKS--AT FOURTH ST. AND LAFAYETTE PLACE.

**The Death of August Bergstein.**

August Bergstein, an old and well-known manufacturer of gold jewelry, died at his residence, 681 E. 141st St., New York, Saturday morning, from heart failure, brought on by pleurisy.

Mr. Bergstein, who retired from active



business about eighteen months ago, was the senior member of the firm of Bergstein & Son, 20 John St. He was born in Cologne on the Rhine, Germany, Oct. 23, 1821, and when sixteen years of age learned the trade of jeweler and stone setter in Pforzheim. In 1847 he came to America

and after working for various prominent firms, started in business with Frank Zuber at 32 John St., under the name of Bergstein & Zuber.

Bergstein & Zuber dissolved on April 16, 1862, and Mr. Bergstein continued alone until 1871 when he admitted his son, Frederick W. Bergstein as a partner, and the firm name was changed to Bergstein & Son. In 1876 the concern removed to its present location at 20 John St.

The funeral services were held Monday morning. The interment took place yesterday at Greenwood cemetery.

**Adolph Shakman Closed by the Sheriff.**

CHICAGO, Ill., Oct. 17.—Adolph Shakman, wholesale jeweler, 189 Fifth Ave., was closed by the sheriff yesterday noon on an execution for \$4,500 to the Bank of Commerce. Later in the day executions were issued in favor of Theodosius Shakman, for \$4,100, Minerva Newman for \$1,947, Louis A. Shakman for \$2,582, Sarah Straus for \$330 and Henrietta Newhouse for \$2,520, making a total of nearly \$16,000.

Adolph Shakman has been in the jewelry business twenty-five years, and at one time was worth \$75,000. Up to to-day he expected to pull through. The failure is believed to be due to gradual loss occasioned by trade depression. The sheriff will sell the assets, Oct. 27, at 10 o'clock.

**Assets and Liabilities of Frank H. Wells.**

SYRACUSE, N. Y., Oct. 16.—The schedules of liabilities and assets of Frank H. Wells, whose failure was reported in THE CIRCULAR last week, have been prepared.

ASSETS.		
	Nom. value	Act. value
Stock on hand -	\$7,046.00	\$4,065.46
Franco-German rings on hand - -	1,586.00	547.80
Jewelry accounts	1,411.34	397.88
Franco-German ring accts. - -	1,706.68	555.29
A. J. Cleveland accts.	891.28	
Int. in Beaver River Club - - -	1,000.00	600.00
Note of C. S. Ball -	550.00	350.00
Fixtures - - -	2,697.00	899.50
	\$16,888.30	\$7,415.93

LIABILITIES.		
Notes - - - -		\$1,287.16
Open accounts - - -		2,448.05
Contingent liability as endorser -		967.83
W. P. Mosher note - - -		450.00
		\$5,153.04

Statutory preferences do not exceed \$10.00. Probably not over \$300 of the contingent liability, including costs of collection, will have to be paid from the estate; probably all can be collected. The Mosher note is against the interest in the Beaver River Club, Adirondaeks.



EUROPEAN  
CLOCKS  
AND —  
ART  
GOODS.

LOW  
PRICES  
TO SUIT  
THE TIMES.

360  
BROADWAY,  
— ALSO —  
BROADWAY, Cor.  
17th St.,  
NEW YORK.

**F. KROEBER CLOCK CO.**



# ARE YOU GOING TO THE WORLD'S FAIR?

If You Are Let Us Give You A Pointer.

Collect all the Old Gold, Silver, Plated Scraps, Bench Sweeps, bring same with you, call and see us, we will value your Gold, etc. accurately, and pay you for same while you wait. In this way you can pay a portion or perhaps all your expenses to the World's Fair. If you are not coming, or have more Gold, etc. than you wish to hold, would be pleased to have you ship same to us. Immediately on receipt we will remit by cash or draft. If our offer should not prove satisfactory we will return consignment intact and pay all charges.

Make us a trial shipment and you will ship again. Our Guide to Chicago and the World's Fair, mailed free on application.

**GOLDSMITH BROS.,**  
Gold and Silver Refiners and Assayers,  
63 & 65 Washington St.,

Near State,

CHICAGO, ILL.

MENTION THIS PAPER.

# DID YOU HEAR HIM CROW?

HIGHEST  
AWARD  
MEDAL  
AND  
DIPLOMA.



HIGHEST  
AWARD  
MEDAL  
AND  
DIPLOMA.

## W. & S. B. ★

### ❖ Old Reliable Chains ❖

RECEIVE HIGHEST AWARD

— AT THE —

## WORLD'S ❖ COLUMBIAN ❖ EXPOSITION,

1893 ❖ CHICAGO ❖ 1893

NOTE OUR PATENTED TRADE MARKS.

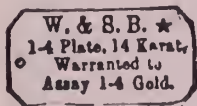

SUPERFINE QUALITY.



EXTRA FINE QUALITY.

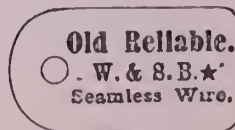

REGULAR QUALITY.

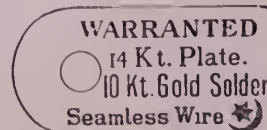

SECOND QUALITY.



SECOND QUALITY.

# W. & S. BLACKINTON, ATTLEBORO, MASS.



**WORLD'S FAIR and WESTERN SUPPLEMENT CIRCULAR**  
of THE JEWELERS'

CHICAGO OFFICE: ROOM 308, INTER-OCEAN BUILDING.

VOL. XXVII.

CHICAGO, WEDNESDAY, OCTOBER 18, 1893.

NO. 12

**EXHIBIT OF W. & S. B. ★ CHAINS AT THE WORLD'S FAIR.**

WHEN originated the process of chain-making is unknown, as the industry antedates even the graving on stones of men's thoughts and deeds. Tubal Cain, that mighty artificer and instructor in metal work, undoubtedly forged chains of iron and brass, but the first mention with which we are familiar regarding chains from precious metals was when Pharaoh placed a chain of gold about Joseph's neck as a part emblem of authority, after revealing the significance of Pharaoh's dream of the lean and fat kine. The smallest chain manufactory of the present time could in few days supply every man, woman and child of Tubal Cain's time with chains for personal adornment, and a factory like that of

of retail jewelers who never before realized the almost innumerable patterns turned out by this well known house. Four by fifteen feet of plate-glass cases are required to house this magnificent display, and in a general way this is divided into forty square feet for gents and twenty for ladies chains.

At either end of the gents' section is a

inward. Thence is a four inch slanting surface on which in two inch metal letters are the well known words, Old Reliable, on two sides and W. & S. B. ★ on the two other. The flat top just below the glass is of white velvet bordered with heavy white silk cord.

In such a setting the W. & S. B. ★ chains are fitly presented to the World's Fair

public. On the curved sides of the center mound are draped gents' chains, ladies' victorias, straight fobs, and ribbon chains in plate of handsome design and superior finish. The flat top is strewn with rich black ribbon fobs with fine mountings of silver and gold. Criss-crossed and in designs radiating from the corners on the base are gents' and ladies' chains in numberless beau-



W. & S. BLACKINTON'S EXHIBIT CASE OF LADIES' CHAINS.

W. & S. Blackinton, of Attleboro, Mass., would consider it a dull week if its products did not exceed the wants of the entire population of Pharaoh's realm.

The World's Fair exhibit of the firm's celebrated W. & S. B. ★ rolled gold plate chains in the consolidated exhibit of the New England Manufacturing Jewelers' Association, American jewelry section of Manufactures building, has been a revelation to thousands

hemisphere of gents' chains an inch apart, set off to fine advantage on the dark, rounded surfaces. At the top of the half-spheres a vacant circle twelve inches in diameter was left and this is filled with a mass of chains with bar ends reaching out to those hanging pendent. In the center rises a mound of velvet having a diamond shaped base with equilateral sides which rise in a curve to a height of twelve inches inclining

tiful and rich patterns; also ladies' chain-and-locket bracelets, a number of the latter being in sterling silver. The whole case is ablaze with golden light reflected from the perfect finish of the goods.

The section devoted to the ladies' chains is no less attractive as to setting and, as is to be expected, shows a delicacy, a femininity always charming. A roll of dark olive green velvet, 12 inches in diameter, is in

the form of a circle, 4 feet in diameter, the width of the case. In the center rises an octagonal cone of white velvet, 15 inches high. This is draped with long neck chains interspersed with victorias. Across the roll encircling the cone are ladies' chains, victorias, necklace chains and chain bracelets. On the white velvet base at one side of the

The old-fashioned way of soldering and W. & S. B. ★ chains are perfect strangers to each other, all the products of the factory being made from seamless wire. The many advantages of the use of this wire are forcibly brought out by an exhibit showing the processes of its manufacture. Six processes are employed from the metal plates to the

cess. The third gives the process further extended. In the fourth the rod is ready for the rotary hammer; and in the fifth the rod is shown as it comes from the hammer. The last shows the finished wire as used.

This clear exposition of methods requires but a minute's time to note and to an observing jeweler teaches all that may be learned

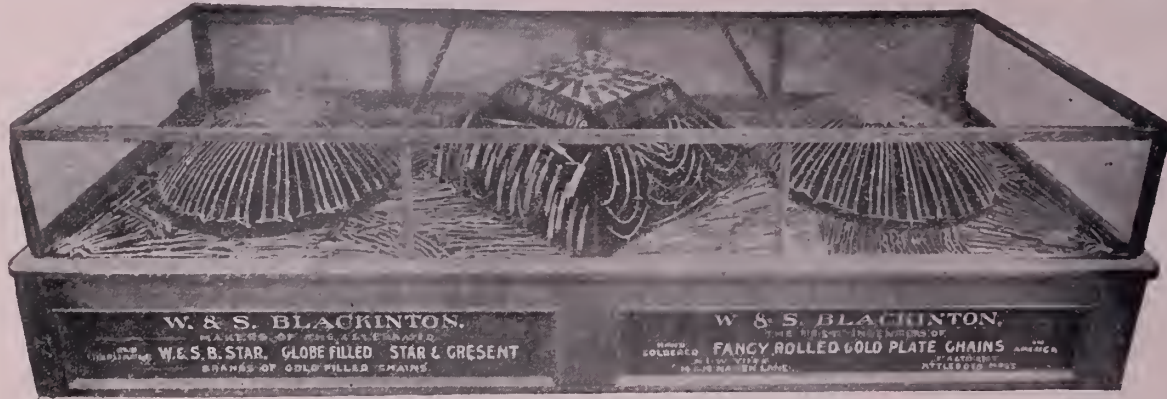

W. & S. BLACKINTON'S EXHIBIT CASE OF GENTS' CHAINS.

roll are finely finished victorias with pendants, richly executed in many choice designs, and the opposite side is strewn with ladies' chains in intricate and handsome patterns, chain bracelets and babies' neck chains in charming and delicate designs, with pretty little pendants in stone-set gold and enamel.

finished wire. In the first are shown three discs, the top one a plate of 14 karat solid gold, the middle of silver solder, and the under disc of brass. The three discs thus placed are subjected to a heat sufficient to solder the gold and brass metal. The second shows the manner in which the plates are shaped after leaving the first pro-

cess. The third gives the process further extended. In the fourth the rod is ready for the rotary hammer; and in the fifth the rod is shown as it comes from the hammer. The last shows the finished wire as used.

The firm have received the highest honors at the World's Columbian Exposition, a medal and diploma.

## HIGHEST AWARD WAS OBTAINED

AT THE COLUMBIAN EXPOSITION

BY OUR

# Musical Boxes



## JACOT & SON,

298 Broadway, - New York.



Send Business Card for Large Illustrated Catalogue and Trade Prices.

### Kansas City.

J. Russ Mercer is spending a couple of weeks at the World's Fair.

L. S. Cady has been called to Columbus, O., by the death of his wife's father.

Chan Olmstead and W. M. Smith, with Cady & Olmstead, are at the World's Fair. The former is on his second trip to the Fair.

The Jaccard Watch & Jewelry Co. have secured the contract to furnish all the plain band rings for the Scottish Rite consistory for the next two years.

Alexander Mermod, of the Mermod & Jaccard Jewelry Co., St. Louis, was here last week on his way home from his ranch, at Current Creek, Col., where he has been spending the Summer.

Jeweler J. Niles Kimball went to the Cherokee Strip at the opening Sept. 16th, and secured a claim. Now it is alleged that in so doing he lost his citizenship in Missouri, and an effort is being made to oust him from his seat in the city council.

When Frank S. Altman vacated his store at 725 Main St., he sold part of his stock and fixtures to Clement B. Altman, his brother who had been associated with him, and the rest he moved to a new store at 1117 Main St., where he has now opened for business. C. B. Altman has opened a store at 707 Main St., in which F. S. Altman has no interest

ART IN TIFFANY & CO.'S WORLD'S FAIR EXHIBIT.

PART II.

**T**HE display of gold fancy pieces in the World's Fair exhibit of Tiffany & Co. reveals the most exhaustive study and research of early periods. Some idea of this display may have been obtained by the reader from the article in THE CIRCULAR of April 12, but a thorough appreciation is im-

possible without an inspection of the exhibit itself. Among boxes and bonbonnières we see a frog box, Adirondack variety, modeled from nature, the belly being of silver, feet and back of green gold, the latter set with American pearls from New Mexico, with eyes of titanites found in New York State. Also another box representing a Long Island toad, modeled from nature, belly of silver, feet of green gold and the back set with opal matrix to correspond with the spots

and marks on the toad; interspersed through these are demantoids, increasing the color of the matrix; the eyes are of pink topaz. Another is an Egyptian box, mummy form, introducing scarabei, antique Egyptian lapis-lazuli figures from the Montigny collection, enameled snakes, gold and

of pierced, carved, and peculiar colored gold especially alloyed and introduced as in Oriental art-work; the beads are separated by washers of small rhodonites. The sheet of jade forming the wings is remarkable as a specimen of lapidary work, it having been reduced to such a thinness as to be transparent; the antennæ or feelers of the butterfly are employed to give added strength and support to the wings, and are made of gold, studded with turquoise. Another unique fan is of white ostrich

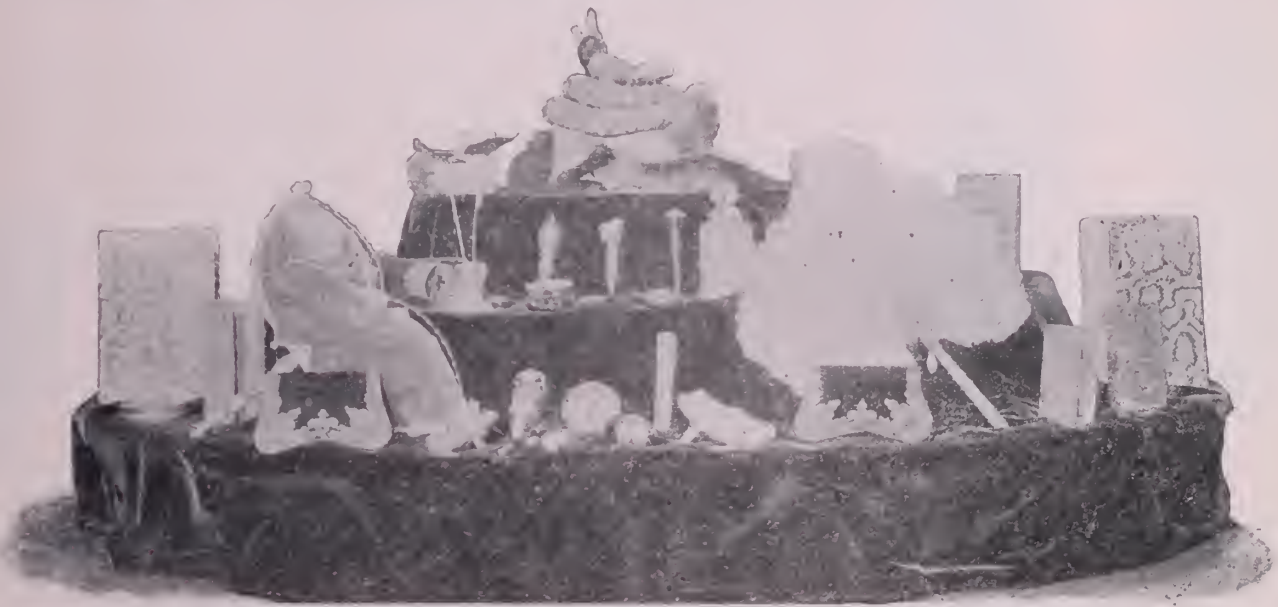

GOLD FANCY PIECES SET WITH PRECIOUS AND SEMI-PRECIOUS STONES. TIFFANY & CO'S EXHIBIT.

possible without an inspection of the exhibit itself.

Among boxes and bonbonnières we see a frog box, Adirondack variety, modeled from nature, the belly being of silver, feet and back of green gold, the latter set with American pearls from New Mexico, with eyes of titanites found in New York State. Also another box representing a Long Island toad, modeled from nature, belly of silver, feet of green gold and the back set with opal matrix to correspond with the spots

silver body metal; rock crystal bon bon box, set in carved colored gold and mounted with blue tourmaline in the center and surrounded by red tourmalines; sweetmeat box, style viking, round, gold, set with zircons; Hungarian bon bon box, of colored gold, blue enamel, with pearls set in center; lapis-lazuli bon bon box, mounted in gold and enameled; another lapis-lazuli bon bon box, mounted in gold, yellow enamel and diamonds; jade box, round, flat top and bottom, gold rim, red enameled; bon bon

of pierced, carved, and peculiar colored gold especially alloyed and introduced as in Oriental art-work; the beads are separated by washers of small rhodonites. The sheet of jade forming the wings is remarkable as a specimen of lapidary work, it having been reduced to such a thinness as to be transparent; the antennæ or feelers of the butterfly are employed to give added strength and support to the wings, and are made of gold, studded with turquoise.

Another unique fan is of white ostrich

**IRONS & RUSSELL,**

(SUCCESSORS TO CHARLES F. IRONS.)

MANUFACTURERS OF

**SOLID GOLD EMBLEMS ROLL PLATE**

PINS, CHARMS AND SOLID GOLD RINGS.

102 Friendship Street, - - Providence, R. I.



**Gold Plated Enamel Tableware,**

ABSOLUTELY NEW.

control the line of Gold Plated Enamel Ware, including Coffee, Tea, and thirty varieties of larger Spoons. These are beautiful goods and at a price that places the Enamel Ware within the reach of all, for practical use. Designs and finish equal to Sterling Silver Enamel Goods. Send for samples.

**SOPHUS SAMSON,**

ROOM 802, COLUMBUS MEMORIAL BUILDING,

CHICAGO, ILL.

H. B. BOLSTAD.

J. H. NIGHTINGALE.

WATCH CASE MAKERS AND REPAIRERS.

**H. B. Bolstad Plating Co.**

GOLD AND SILVER PLATERS.

DESIGNING AND ENGRAVING.

170 Madison Street, - - CHICAGO.

EST.

1870.

**DR. PETER HENRY,**

SPECIALIST IN

WATCH • CASE • DISEASES

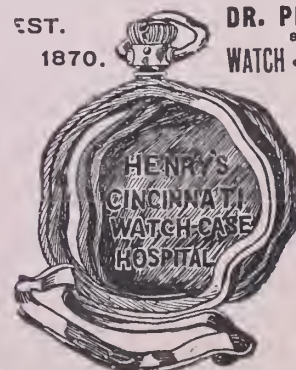

Key Winders changed to Stem Winders.

Hunting Cases changed to O. F.

English Cases changed to fit American movements

Can be cured at 53

Longworth St., Cincinnati, Ohio.

feathers, the style of decorations being Russian. The feathers are supported by a spray of pearls and emeralds, the center ornament being studded with light emeralds and rubies; the handle is of gold and is enameled in light turquoise blue color.

A marvelous piece of work is an incense burner representing a rattlesnake and a duck, an illustration

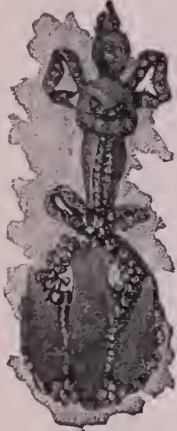

CUPID AND DOVE WATCH.



EAST INDIAN SMELLING BOTTLE.

of which is seen in the group. The rattlesnake is strangling the duck, the whole being modeled from life. The body metal is silver; the feathers of the duck are represented in colored enamel; the scales of the snake are made from opal matrix; a section opens and

contains a box for matches. The rattles and head of the snake are set with American pearls, the eyes being of emeralds. When in use, the incense is placed in the open mouth of the duck, while the head of the serpent provides space for storing the incense. There are 450 opals and 100 pearls in this piece.

In the exhibit two notable mirrors are seen. One is a scarabei mirror (Ptolemaic), or small Egyptian hand mirror. Its face is of North Carolina rock crystal, set in green gold, the back being studded with seven different scarabei; the handle is formed of a silver cobra inlaid with gold and twining around another scarabeus; lapis lazuli at the base of handle laps over the face of the mirror. The other is a small heart shaped mirror, in the early Italian style, its face being of American rock crystal set in gold, while the back is carved into gold scrolls, flowers, ribbons, etc., set with nine rock crystals of curious shapes and cuttings. A white metal dove with outstretched wings studded with rose diamonds is mounted on top over the mirror; the handle is of rock crystal and gold with carved rock crystal drop-pieces.

In the way of ornamental pieces, a miniature flower-pot and saucer, made from rhodonite should be noted. The plant, Galax Aphyllia, is a rare Japanese variety; the earth in the pot is represented by sapphire gravel; the two stems and broad leaves of the plant are of gold, while the veins and

colors are represented by enameling; on one stem a caterpillar of emeralds is crawling



JEWELED REVOLVER.

toward the top, while on one of the leaves there is a full-grown butterfly composed of table diamonds. Another piece, a stone landscape, is composed of brown jasperized wood, fossilized reptile bone, green porphyry, rubellite in lepidolite, agatized wood, Napolconite, fossil coral and isopyre.

The display of smelling bottles is remarkable in extent and in variety of design, each piece being a work in the gematologist's art. A fair example is the one illustrated in this article. It is an East Indian smelling bottle of carved jade, inlaid with cabochon rubies, gold mounting and revolving ornaments,



CURIOUS CANE HEAD.

emerald wheels, diamonds, sapphires, tourmalines and enamel. Other salient pieces in this line are a Siamese smelling bottle of gold, of an odd shape, with swelling top, blue enameled, set with fig shape and other curious cut diamonds; Javanese smelling bottle, with ribbed body, green enamel on gold, with network of fine gold, forming a matted ornament on top, the whole studded with brown, green, yellow and other unusual colors of diamonds.

The exhibit of these fancy gold pieces seems to be interminable, and to do it justice it would exercise a greater strain upon our space than it could bear. The pieces described in the foregoing will serve to convince those who may need demonstration that the scope of the gold and silver workers' art is essentially without limits.

## OTTO YOUNG & CO.

WHOLESALE ONLY.

Diamonds, Watches, Jewelry, Silverware, Tools and Material.

◁ OPTICAL GOODS, ETC. ▷

149, 151 & 153 STATE ST., CHICAGO, ILL.

WE will soon issue our new Illustrated Catalogue. It will be sent by Express or mail, prepaid, to all legitimate Jewelers, in territory tributary to Chicago. It will contain a full line of all staples and novelties required by Watchmakers and Jewelers. The goods are right and the prices uniformly low, and we trust to receive frequent orders from you for goods selected from its pages.

IF YOU DO NOT RECEIVE A COPY OF SAME, ADVISE US.

In addition to our regular stock, we have a large line of discontinued American made watch movements, in 18, 16 and 6 size, which we offer at greatly reduced prices and we will be pleased to write you fully regarding same, upon application.

### THE PLANCHAMP & BECKER CO.

Makers and Repairers of

### WATCH CASES,

Gold and Silver Plating —

— of Watch Cases a Specialty.

UNEXCELLED FACILITIES.

63 and 65 East Washington St., Chicago.



Racine Jewelry Mfg Co.

SPECTACLE TEMPLE WASHERS.

Gross in a Bottle, 25c.

For Sale by Dealers in Jobbing Materials

### JEWELERS.

We guarantee to sell you Sterling Silver Flat Ware at a less price than any other manufacturer, and give you newer designs.

We will increase your profits if you will let us. Is it not worth trying?

OVAITT & WARNER, Silversmiths, PORTLAND, OREGON.

## Chicago.

Buyers and visitors in Chicago and at the Fair last week included :

A. Huelsman, Fond du Lac, Wis.; H. W. Wood, Colfax, Ia.; John Kollman, Galsville, Wis.; D. Trumbull, Ottawa, Can.; A. Jay Carruth, Sidney, Neb.; Albert L. Sterns, New York; W. M. Freeman, Marion, Ky.; J. M. Webster, Bonne Terre, Mo.; E. A. Porter, Rippy, Ia.; R. B. Conger & Co., Oshkosh, Wis.; G. A. Donaldson, Girard, Ill.; Ralph Schwab, Birmingham, Ala.; Johnson & Paulsen, East Oakland, Cal.; C. Henningsen, Stillwater, Minn.; B. F. Ashelman, Asla, Minn.; Chas. Vreene, Waterbury, Vt.; Geo. F. Longnecker, Winchester, Ill.; Gus Brown, Bayou Sara, La.; Nash Mitchell, Pittsville, Wis.; P. W. Eigner, Kent, O.; Harry Dunning, Norfolk, Neb.; W. W. Whitehead, Philadelphia, Pa.; A. C. Thomas, Urbana, O.; R. D. McDonald, Denison, Tex.; Jule K. Pickett, Salem, O.; Harry C. Brittain, Strathroy, Ont.; A. W. Kelsey, Franklinton, N. Y.; Fred H. Bogerd, Louisville, Ky.; C. E. Searl, Merrill, Wis.; George W. Moore, Bloomville, O.; Samuel G. Parker, Dyersville, Tenn.; V. E. Wold, Colchester, Ill.; T. R. Jones, Rockford, Ill.; Jacob and Joseph Levy, Hamilton, Ont.; Fred Stark, Shippshewana, Ind.; Fred Stengel, Nevada, O.; August H. Stecher, Milwaukee, Wis.; A. F. Zimmerman, Warrensburg, Mo.; F. T. Webber, Champaign, Ill.; G. H. Sherman, Paola, Kan.; W. T. Irvine, Lacrosse, Wis.; Edward T. Taylor, Philadelphia, Pa.; C. I. Lee, Kansas City, Kan.; Tom M. Hutte, Kingman, Kan.; E. K. Hall, Bramwell, W. Va.; Hiram F. Burgess, Fairfield, Me.; Louis Heiser, Hannibal, Mo.; Henry Sobel, New York; S. Edson, Lansing, Mich.; Vincent S. Mulford, New York; John M. Clower, Cleburne, Tex.; Adolph Mascher, East Palestine, O.; W. F. Antermann, Jr., Albany, N. Y.; Ozias Riley, Champaign, Ill.; Ira Adams, North Iowa, N. Y.; E. R. Flint, Carron City, Mich.; Henry M. Dayton, Sycamore, Ill.; Edwin G. Lloyd, Scranton, Pa.; O. R. Fox, St. Paul, Minn.; J. O. Chipman, Stanton, Mich.; Will H. Maire, Paducah, Ky.; O. S. Hemphill, Philadelphia, Pa.; Frank Lamont, Sylvania, O.; I. Talbert, West Elkton, O.; T. B. Zeller, Brookville, Pa.; L. S. Hillabold, Hologate, O.; Harwood Bros., Boston, Mass.; Col. P. Engle, Wilkesbarre, Pa.; S. A. Walton, Moundsville, W. Va.; Geo. B. Bement, Broadhead, Wis.; Geo. D. Hamilton, So. Lyon, Mich.; W. O. Foster, Beresford, S. D.; Fred A. Riefler, Buffalo, N. Y.; Jos. W. Field, Galveston, Tex.; John A. Didot, Geneva, Ind.; M. C. Didot, H. Didot and E. H. Didot, Versailles, O.; P. C. Krouse & Co., Columbus, O.; R. E. Lofinck, Manhattan, Kan.; F. A. Patterson, Hicksville, O.; Henry W. Kloff, Neillsville, Wis.; E. Culver, Mason, Mich.; Emil Haeni, South Kaukauna, Wis.; Geo. W. Fischer, Sharon, Pa.; John F. Beyerle, Reading, Pa.; Geo. W. Miles, West Milton, O.; David J. Ayres, Keokuk, Ia.; H. K. Thuneman, Newark, Ill.; A. J. Thoma, Piqua, O.; Wm. F. Lower and N. Staininger, Tipton, Ia.; A. H. Wenning, Nashville, Tenn.; K. Carson, Ballinger, Tex.; J. Jacobs, Winterset, Ia.; E. L. Rinkerbach, Harrisburg, Pa.; W. H. Sumner, Gainesville, Ga.; E. J. Hutchinson, Hornellsville, N. Y.; O. C. Hustad, Tower City, N. D.; Max H. Elbe, Niagara Falls, N. Y.; J. Warner Hutchison, Philadelphia, Pa.; G. E. James, Eureka, Ill.; Harry H. Weylman, Kittinging, Pa.; Miss Tillie Pratt, Cedar Springs, Mich.; W. H. Wilson, Boston, Mass.; A. Kuckuk, Shawano, Wis.; C. E. Hunter, Bowling Green, O.; Medearis Bros., Indianapolis, Ind.; J. F. Safford, Farmington, N. H.; A. E. Zuckschroendt, Tipton, Mo.; M. Weintraub, Jacksonville, Fla.; George M. Tripp, Adrian, Mich.; George F. Hill, Ghent, Ky.; R. J. Thurstein, Lake City, Minn.; John Mesing, Hanover, Kan.; A. Abbaticchio, Latrobe, Pa.; D. B. Bancroft, Detroit, Mich.; W. P. Sedgewick, Bath, N. Y.; M. Morrison, Winona, Mich.; Ernest Eimer, Muskegon, Mich.; David Ainley, Perry, Ia.; J. B. Janssen, Philadelphia, Pa.; A. J. Leach, Karson, Minn.; Lew. Callisher, Washington, D. C.; H. M. Brennecke, Nashville, Tenn.; Wm. Bellmay, Harrisburg, Pa.; Pond & Ellithorpe, Coal City, Cal.; Settle & Welch, Scottsville, Pa.; Jennie Lowrey, Flora, Ill.; J. B. Dickey, Newton, Kan.; C. G. Combs, Corinth, N. Y.; E. H. Fisher, Loraine, O.; A. W. English, Wyorena, Wis.; W. C. Schoelkopf, Hermansville, Mich.; N. G. Wood & Sons, Boston, Mass.; C. Critenden, Des Moines, Ia.;

A. G. Crooker, Fairmont, Minn.; J. G. Perry, Great Barrington, Mass.; John Holt, Eau Claire, Wis.; W. G. Sanderson, Salem, S. D.; M. B. Messley, Canton, Ill.; G. G. Baker, Chebanse, Ill.; W. B. Hagelein, New York; D. Beatty, Montreal, Que.; M. L. Comfort, Owego, N. Y.; W. W. Matthews, Winnipeg, Man.; Jacob Roland, Cannelton, Ind.; W. G. Short, Uniontown, Ky.; F. S. Lambert, Albia, Ia.; Geo. P. Drew, Doon, Ia.; Jireh Kinney, Buffalo, N. Y.; C. O. Faller, Laporte, Ind.; Henry Greenman, Richfield Springs, N. Y.; H. M. Crothers, Bay City, Mich.; Ira H. Johnson, Washington, D. C.; S. B. Bailey, Pomona, Cal.; J. W. Beahn, Union Mills, Ind.; E. L. Chamberlain, Kansas City, Mo.; E. E. Watkins, Bloomington, Ill.; Law & Mathew, Washington, Ia.; Chas. F. Billau, Cedar Rapids, Ia.; Deal Bros., Carthage, Mo.; Otto Wettstein, Rochelle, Ill.; M. Traby, Independence, Kan.; John Walsh, Delphos, O.; D. Oppenheim, Baltimore, Md.; Alex. Moffat, Brantford, Ont.; J. W. Wood, Galva, Ill.; F. Brunner, Cincinnati, O.; E. F. Davis, Mitchell, Ont.; Dr. Joel W. Smith, Charles City, Ia.; F. M. Bonner, New Lisbon, O.; Chas. H. Schiller, Utica, N. Y.; H. Erkmann, St. Louis, Mo.; H. H. Truckenbrod, Mendota, Ill.; Duncan G. Currie, Manistiquette, Mich.; O. S. Olsen, Ruthven, Ia.; S. C. Curtiss, Elgin, Ill.; J. G. Ryan, Griffith, Ind.; T. F. McCoy, Seneca, Ill.; D. C. Spaulding, Wabasha, Minn.; E. R. Friedrich, Hebron, Neb.; J. M. Webster, Bonne Terre, Mo.; D. D. Williams, Emporia, Kan.; N. Tegtmeyer, Milwaukee; J. Houser, Rock Island, Ill.; Frank Stumpf, Stillwater, N. Y.; Mr. Ogle, Centreville, Ia.; J. L. Grady, Slater, Mo.; F. R. Vaughan, Brattleboro, Vt.; V. C. Coleman, McKinney, Tex.; S. Swart, West Bay City, Mich.; C. Stiff, Little Rock, Ark.; H. C. Taylor, Burlington, Wis.; John Larson, Madison, Wis.; H. Oettinger, Mendota, Ill.; Fred. Eywatten, Peoria, Ill.; A. M. Hart, Tiffin, O.; Chas. F. Askin, Ashport, Wis.; A. H. Furstnow & Co., Fond du Lac, Wis.; J. H. Rulston, Goshen, Ind.; Will Denman, West Unity, O.; Wm. King, Jr., Buffalo, N. Y.; Wm. Gray, Jr., New York; Harry Compson, Big Rapids, Mich.; F. H. Erickson, Laporte, Ind.; C. F. Tryon, West Superior, Wis.; Wm. Kennedy, Albany, N. Y.; Geo. Waters, Jr., Scranton, Pa.; S. M. Knowles, Providence, R. I.; Fred. Hein, Salamanca, N. Y.; Roser & Burton, Canajoharie, N. Y.; W. F. Laraway,

Glenwood, Ia.; J. C. & W. W. Watts, Ann Arbor, Mich.; L. W. Sweet, New York; Thos. M. Hannah, Belvidere, Ill.; E. A. Jones, Dodgeville, Wis.; H. Leichtenstein, Salt Lake City, Utah; B. M. Leichtenstein, Salt Lake City, Utah; H. S. Selb, Ironton, O.; F. E. Elberfeld, Ironton, O.; A. Basse, Quincy, Ill.; J. S. Smith, Mt. Vernon, Ia.; T. O. Christian, Owosso, Mich.; H. H. Sheldon, Bessemer, Mich.; John Prochaska, Toledo, O.; C. F. Hoffmann, Reynoldsville, Pa.; W. A. Huff, Rensselaer, Ind.; E. G. Guthrie, Casselton, N. D.; Thomas Brand, Findlay, O.; Leon E. Lavinburg, Detroit, Mich.; Wm. M. Johnson, Centralia, Ill.; E. J. Peck, Braidwood, Ill.; Frank Heller, Alexandria and Brazil, Ind.; F. F. Williams, Vinton, Ia.; C. L. Griswold, Blue Island, Ill.; S. L. Harding, Camden, N. Y.; John Stoecker, Syracuse, N. Y.; W. R. Hale, Greenville, S. C.; A. W. Bigler, Berchtold & Bigler, Sigel, Ill.; W. C. Seaton, Troy, N. Y.; Geo. Chambers, Mt. Clemens, Mich.; A. R. Brooks, St. Louis, Mo.; Alvin Munson, Geneseo, Ill.; F. H. Weaver & Son, Brooklyn Village, O.; Harris Bros., Niles, O.; H. A. Johnson, Monmouth, Ill.; J. H. Gregory, Washington, D. C.; Arthur & Richardson, Webster City, Ia.; Chas. Kohler & Co., Norristown, Pa.; Isaac Loengardt, New Orleans, La.; H. Luce, Rochester, Minn.; Henry S. Zinn, Hutchinson, Kan.; Parks Avery, Louisville, Ky.; Frank Mayr, South Bend, Ind.; Sam Mayer, Denver, Col.; John E. Wagner, Georgetown, D. C.; Henry M. Dayton, Sycamore, Ill.; L. H. Zesby, Huntingdon, Pa.; A. W. Brassler, Malvern, Ark.; J. H. Ellis, Le Brun, Ind.; Moses Schwab, Cincinnati, O.; T. B. Zeller, Brookville, Pa.; N. D. Guffin, Gloversville, N. Y.; W. J. Johnston, Pittsburg, Pa.; Frederick Hillworth, Philadelphia, Pa.; H. E. Scovern, Carthage, Ill.; John A. Didot, Geneva, Ind.; J. D. Howell, Livonia, N. Y.; H. W. Kloff, Neillsville, Wis.; Geo. D. Hazen, Prairieville, Ill.; Albert B. Bowman, Petoskey, Mich.; H. F. Sanger, Lima, N. Y.; H. O. Vogel, Los Angeles, Cal.; A. J. Green, Beaver City, Neb.; F. W. Quinn, Elgin, Ill.; F. W. Heron, Webster City, Ia.; Wm. J. Iliffe, Gladstone, Mich.; D. J. Cole, Denver, Col.; Wm. H. Welch, Demopolis, Ala.; Wm. Yoe, Elgin, Ill.; B. F. Watts, Ann Arbor, Mich.; W. A. Huber, Mechanicsburg, Pa.; Geo. E. James, Eureka, Ill.; M. Laubheim, New York; Sam Nathan, New York; Will Haseltine,

## RECEIVER'S SALE



ENTIRE Stock of **Giles, Bro. & Co.** Fourth Floor Masonic Temple, consisting of Diamonds, American and Swiss Watches, Jewelry, Silver and Plated Ware, Tools, Materials, etc. will be sold in lots to suit the purchasers at large reduction from original cost price.

An unusual chance for live Jewelers to obtain bargains.

W. H. GLEASON, Receiver.

July 14th, 1893

# BAUME & CO.,

21 HATTON GARDEN, LONDON, ENGLAND,  
AND SWITZERLAND.

EXHIBITORS AT CHICAGO OF

## TOURBILLION CHRONOMETER WATCH,

WHICH HOLDS THE RECORD AT ROYAL OBSERVATORY KEW.

HIGH CLASS SWISS WATCHES, PLAIN AND COMPLICATED.

PATENTEES FOR SPLIT SECONDS CHRONOGRAPHS (Treble Action.)

AGENT FOR U. S., GEO. E. WILKINS, SYRACUSE, N. Y.



# GERMANY

SEEKS

AMERICAN TRADE,



And for the purpose of securing it has for several years **STUDIED AMERICAN WANTS.** The German exhibit at the World's Fair contains a full line of jewelry, specially **SUITED TO YOUR NEEDS** and expressly made with a view to furthering the jewelry and silverware trade between the two countries. Mr. Richard Horstmann, under whose supervision and through whose efforts the consolidated German exhibits were secured to the Fair, represents the following lines :

- WATCHES. { The celebrated patent watches of **DURSTEIN & CO.'S UNION WORKS AT GLASHUTTE.** Among them movements held by bolts, and not by springs, insuring thinnest cases, split seconds, Chronometers, etc.
- JEWELRY. { Representative manufacturers of Pforzheim, Hanau and Gmeund. These cities are known worldwide for taste in designs and beauty of gold colorings and enamel work in all branches of the jewelry trade.
- SILVERWARE. { Reproductions of the best old German, Dutch and Rococo designs.

We can serve your best interests if you will but let us know your wants. Correspondence invited.

## RICHARD HORSTMANN,

VIENNA.

Seigmundgasse 15. Tel.-Adr.: PARATUS WIEN.

BERLIN, S. W.

Oranienstrasse 101 102. Tel.-Adr.: PARATUS BERLIN.

LONDON, E. C.

13 Charterhouse Street. Tel.-Adr.: WELLROOM LONDON

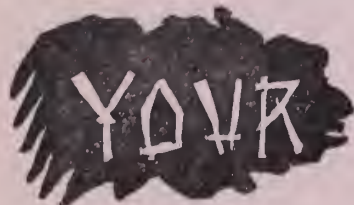

CHICAGO.—German Jewelry Exhibit, Manufactures Building, World's Fair.

GERMAN COURT OF HONOR.

Kokomo, Ind.; J. A. Thompson, Milford, Ill.; J. A. Rovelstad, Elgin, Ill.; J. H. Grubb, Clearville, Pa.; O. D. Miller, with E. J. Peck, Braidwood, Ill.; M. A. Boyer, Dinkirk, O.; P. Sommerfield, La Crosse, Wis.; Geo. H. Thoma, Three Rivers, Mich.; G. H. Phelps, Kalamazoo, Mich.; C. W. Wilson, Cameron, Mo.; L. D. de Mars, Minneapolis, Minn.; P. R. Seafar, Rockford, Mich.; F. L. Black, Willington, Kan.; John F. Bates, Philadelphia, Pa.; S. Baunian, St. Louis, Mo.; L. Burnett, St. Joseph, Mo.; A. J. Schrieber, Frankfort, Kan.; E. G. Bowyer, Algona, Ia.; R. M. Casey, Ora, Ind.; F. H. Searhols, St. Marys, O.; F. P. Huyck and wife, Swanton, O.; Henry H. Scuellberg and wife, Kansas City, Mo.; J. G. Wirt, Pittsburg, Pa.; Geo. L. Kinet, Merrill, Mich.; R. Louis and sister, Piqua, O.; H. Hartman and son Otto, Wapakoneta, O.; Arthur Waugh, Burlington, Ia.; E. A. Williams, Lynchburg, Va.; H. I. Hoyt, Bridgeport, Conn.; E. Miller, East Albany, N. Y.; G. H. Bassinger, Glens Falls, N. Y.; A. A. Shaw, Alfred Center, N. Y.; Chas. A. Wilson, Cedar Rapids, Ia.; D. N. Morgan, Bridgeport, Conn.; R. H. Peale, Schuylkill Haven, Pa.; S. O. Ecker, Mt. Clemens, Mich.; Louis F. Ott, Veedersburg, Ind.; F. W. Hunt, Burlingame, Kan.; Abram Adams, Lancaster, Pa.; G. M. Blakeslee, Lewistown, Ill.; A. S. Kreaie, Mt. Carroll, Ill.; M. D. Spayth, Toledo, Ia.; J. O. St. Arnaud, Iron Mountain, Mich.; O. L. Bryan, Ste. Genevieve, Mo.; A. Fechenbush, Rochester, N. Y.; P. A. Lindholm, Lexington, Miss.; F. W. Hauenstein, New Ulm, Minn.; C. A. Butler, Albion, Neb.; C. O. Haines, Columbus, O.; F. E. Burt, Angola, Ind.; Isaac Bitterman, New York, Tom Morris, Crookston, Minn.; L. Newcomb, Omaha, Neb.; B. M. Austin, Coudersport, Pa.; C. M. Allen, Westfield, Pa.; W. F. Hittig, Dundee, Mich.; J. E. Overton & Co., Port Jefferson, N. Y.; H. C. Milligan, Keosauqua, Ia.; J. W. Brown, Ortonville; J. H. Ward, Trenton, Pa.; W. J. Fraser, Lincoln, Pa.; J. E. Tucker, Danville, Vt.; Linwood E. Hanson, Woburn, Mass.; E. R. White, Buffalo, N. Y.; Frank Holt & Co., Newark, N. J.; Fred. Buehl, Cleveland, O.; Bogerding Bros., Louisville, Ky.; Chas. H. Schiller, Utica, N. Y.; Herman B. Lodde, Lafayette, Ind.; Maw Truby, Independence, Kan.; W. H. Wheeler, Palmyra, Ill.; W. J. Collins, Warren, Ill.; Chas. S. Sharp, Ripon, Wis.; B. Waechter & Son, Sheboygan, Wis.; Hendrickson & Lenard, Paulding, O.; N. F. Barnes, Clear Creek, N. Y.; J. H. Swearingen, Cuba, Ill.; J. W. Kennard, Fischer, Ill.; Henry Harrinon, Afton, Ia.; John Dewey, Milwaukee, Wis.; C. Tiffany, South Manchester, Conn.; A. M. Potter, Lyons, Ia.; J. H. Lentz, Chas. Reinstatler, Hy. Kotte, Wm. Witte and Aug. Rippe, Cincinnati, O.; Geo. E. Free, New York; H. T. Coffin, New Castle, Ind.; Chas. F. Schlegel, Chillicothe, O.; Jos. W. Dupont, Minneapolis, Minn.; E. W. Mitchell, Waco, Tex.; Chas. Price, Jacksonville, Ill.; H. H. Thurlby, Creston, Ia.; Geo. A. Klein, Muncie, Ind.; Clarence S. Dustin, Stillman Valley, Ill.; W. W. Schermerhorn, Stockton, Ill.; A. W. Jansen, New Orleans, La.; Mr. Surrey, Houston, Tex.; John Holt, Eau Claire, Wis.; A. E. Murdoch, Beaver Dam, Wis.; D. W. Martin, Neosho, Mo.; O. Kolstadt, Pleasant Hill, Mo.; J. A. Wiedemann, El Dorado, Kan.; Harry Copley, Omaha, Neb.

Visitors at the rooms of the Chicago Jewelers' Association last week were as follows:

Ned Keating, Watertown, S. D.; John M. Clower, Cleburne, Tex.; F. W. Hauenstein, New Ulm, Minn.; S. P. Croole, Hebron, Neb.; Gus Brown, Bayou Sara, La.; Arthur H. Pray, Boston, Mass.; J. M. Scott and J. B. Scott, Martin, Tenn.; A. H. Osborn, Flandreau, S. D.; W. W. Schermerhorn, Stockton, Cal.; E. J. Ballard, Evansville, Wis.; Mr. Wallace, Ogden, Utah; E. L. Chamberlain, Kansas City, Mo.; V. S. Mulford, New York; J. D. Howell, Livonia, N. Y.; G. Caesar, Chippewa Falls, Wis.; J. C. Baldwin, St. Joseph, Mo., and Columbus, O.; Geo. M. Seaman, St. Joseph, Mo.; C. E. Searle, Merrill, Wis.; Ernest Emier, Muskegon, Mich.; M. Weintraub, Jacksonville, Fla.; F. J. F. Weinert, St. Louis, Mo.; E. L. Proctor, Iowa Falls, Ia.; J. M. Webster, Bonne Terre, Mo.; C. A. Smith, Farmington, Ill.; H. H. Schillberg, Kansas City; G. H. Meehe, Council Grove, Kan.; Frank H. Kain and C. Henry Kain, Philadelphia, Pa.; H. G. Bergfeld, St. Louis, Mo.; C. E. Bergfeld, St. Louis, Mo.; W. H. Thorp, Beaver Dam, Wis.; S. A. Walton, Mounds

ville, W. Va.; H. W. Wood, Colfax, Ia.; F. E. Burt, Angola, Ind.; E. A. Rhodes, Eureka, Ind.; W. A. Faber, Peoria, Ill.; F. W. Hunt, Burlingame, Kan.; Geo. W. Birnbaum, Newark, N. J.; J. R. Kocher, San Jose, Cal.; M. M. Davenport, Edythe S. Farrington and Mary Robinson, Bangor, Me.; Mrs. M. A. Baxter, Portland, Me.; J. A. Edgerly, Great Falls, N. H.; H. F. Alden, Bank Center, Minn.; A. W. Henderson, Traer, Ia.; J. H. O. Brandenburg, Burlington, Ia.; Mr. and Mrs. Frank M. Chapin, New Hartford, Conn.; A. J. Browne, Kansas City, Mo.; A. J. Wood, Decatur, Ill.; H. S. Dorchester, Providence, R. I.; H. M. Hackart and wife, Springfield, Mo.; Jacob Roland, Cannelton, Ind.; C. E. Dickinson, Garden City, Kan.; A. Cross, Pierce, Neb.; Geo. B. Clary, Moravia, N. Y.; S. Carey Frantz, De Groff, O.; B. W. Moore, Stewartville, Minn.; W. J. Fraser, Lincoln, Pa.; W. K. Fraser, Lincoln, Pa.; E. W. Mitchell, Waco, Tex.; J. B. Bickle, Rochester, Minn.; H. F. Burgess, Fairfield, Me.; F. H. Carpenter, Boston, Mass.; G. A. Carpenter, Buenos Ayres, S. A.; S. Lederer, Providence, R. I.; E. P. Varian, Denver, Col.; Geo. A. Crofut, Beaufort, S. C.; H. E. Walter, Richfield Springs, N. Y.; Wm. H. Welch, Demopolis, Ala.; J. M. Duncan, New York, Carl Adler, Baker City, Ore.; Chas. W. Clifford, Bath, Minn.; Emil Hall, Media, Pa.; Geo. Yerkes, Novi, Mich.; L. Burnett, St. Joseph, Mo.; Mr. Conrad, Tecumseh, Mich.; Mr. and Mrs. M. N. Berg, Cloquet, Minn.; Mr. and Mrs. Wm. Tall, Schoolcraft, Mich.; Joseph M. Schaefer, John W. Furhee and Perk Meiers, Pittsburgh, Pa.; Thos. Quayle, Providence, R. I.; Wm. H. Ambler, Northville, Mich.; J. B. Janssen, Philadelphia, Pa.; Frank Strumpf, Stillwater, N. Y.; S. E. Dickinson, Wausau, Wis.; Geo. W. Fisher, Sharon, Pa.; F. G. Renken, Manson, Ia.; A. F. Zimmerman, Warrensburg, Mo.; B. H. Connor, Icokebury, S. C.; H. G.

Davis, Rhinelander, Wis.; J. F. Gereke, Seward, Neb.; Geo. E. James, Eureka, Ill.; S. G. Leonard, Kinsley, Kan.; I. H. Sellars, Doncaster, Eng.; K. Carson, Ballington, Tex.; C. Senner, Ellensburg, Wash.; J. Senner, Iowa City, Ia.; Mr. and Mrs. H. H. Schellberg, Kansas City, Mo.; Alex. Moffat, Brantford, Ont.; P. W. Eigner, Kent, O.; Chas. Zaumseil, Ripley, O.; Chas. W. Bechtel, Galim, O.; H. W. Kloff, Neillsville, Wis.

Frank S. Ring, Detroit, Mich., spent the past week in this city.

C. H. Angell, Juniata, Neb., is purchasing here for a store he is just starting up at that place.

Mr. Blake, of Blake & Claflin, took time from business to visit the Fair, with Mr. Sturdy of the former firm of Sturdy Bros., Attleboro.

Wm. E. Dodge, president of the Ansonia Clock Co., is in town with his wife. Mr. Dodge was interested in the Electrical Congress in session in this city the past week.

Jewelers' Council No. 316, of the National Union, held a most successful meeting at the Council rooms the evening of Oct. 7, the largest attended meeting since organization; several cabinet officers were present, four candidates initiated, and a number of applications received. After the meeting the members adjourned to the banquet hall

## REED & BARTON, SILVERSMITHS, MANUFACTURERS OF STERLING <sup>and</sup> SILVER PLATED SILVER WARE.

SALESROOMS:

37 Union Square, New York.

34-36 WASHINGTON STREET,

Venetian Building, Chicago.

FACTORIES, TAUNTON, MASS.

ONE OF THE BEST  
OF THE VERY BEST.

QUALITY IS THE  
STANDARD OF VALUE.

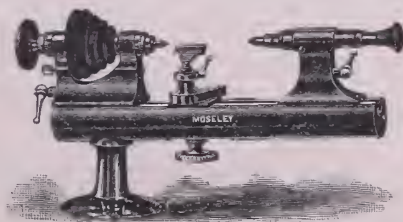

MEN INTERESTED WRITE YOUR JOBBER OR

MOSELEY & CO., - - ELCIN, ILL.

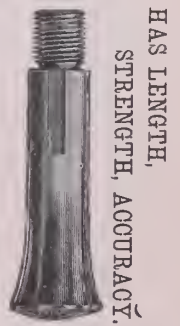

HAS LENGTH,  
STRENGTH, ACCURACY.

when a sumptuous repast was partaken of and speeches made by men prominent in the work of the council.

C. W. Thomas, of Thomas & Brand, Findlay, O., is purchasing for an optical department to be an addition to his jewelry stock.

W. B. Smith and wife, of New York, spent the past week at the Fair. The rooster in the case exhibit of B. & W. B. Smith still crows victoriously.

S. Lederer, of S. & B. Lederer, Providence, accompanied by his wife and eldest daughter, left Saturday with pleasant recollections of two weeks spent at the Fair.

E. H. Murdock, assignee for W. S. & J. B. Wilkinson, tray and case makers who recently failed, has removed the factory from 9 E. Madison to 215 Superior St.

Manager Loeb, of the Chicago office of the Wadsworth Watch Case Co., 611-613 Columbus building, left Thursday for a week with jobbers in western cities.

The entire silver service used at the great international banquet given by the Fair

directors to the foreign commissioners, recently, was of the Monarch pattern of Rogers & Hamilton Co. ware.

Four men instead of one is what G. W. Hook, the manufacturing jeweler at 149 State St., thinks he should be. And this because of a rushing business which is constantly increasing both in patrons and number of orders.

The Meriden Britannia Co. came to the front on Connecticut day at the Fair (Oct 11) with their finest and largest repoussé punch bowl filled to the brim with claret cup. Mine host Miles did the honors with becoming modesty, and many a weary traveler will keep the Meriden Britannia Co. in kind remembrance.

Jos. Wm. Alber, formerly of Augsburg and Hamburg, Germany, has established an enamel factory at 934 Lincoln Ave., this city, for the manufacture of enamels, hard and soft, for the jewelry trade. The process is Mr. Alber's own, evolved from thirty-five years experience in the business. Sixteen colors are now made, and can be furnished in any quantity.

### Indianapolis.

Wm. T. Marcy and wife have returned from a trip to New York.

Baldwin, Miller & Co. have made improvements in their clock department.

J. H. Noyes, Osgood, Ind., recently married Miss Lottie Handel, of Covington, Ky.

The stock of Wm. Haushalter, Anderson, Ind., has been moved into a handsome new store.

Julius C. Walk and family, and Robert S. Heaton, of Nichols, Pee & Co., have returned from the World's Fair.

F. S. Day has opened a new jewelry establishment in Antwerp, O. Mr. Day was formerly with Wm. H. Reeves, Angola, Ind.

Elliott Sims, of Nichols, Pee & Co., started for northern Indiana Oct. 11th. John Gardner, for the same house, is visiting the jewelry trade in eastern Indiana.

The stock of Edward Ducas, whose failure was recently published in THE CIRCULAR, has been sold to his wife, Fannie Ducas, who continues the business at the old stand.

Traveling men in Indianapolis, last week were: Jas. S. Beatty, Engelfried, Braun & Weidmann; Ernest Block, W. & S. Blackinton; C. M. Davis, New Haven Clock Co.; C. O. E. Hartung, Sussfeld, Lorsch & Co.; A. M. Thanhauser, for Ludwig Lehman; M. L. Jacoby, Providence Stock Co.; E. R. Bennett, Foster & Bennett; W. P. Hanford, H. E. Opperheimer & Co.; Louis Hirsh, A. Goldsmith & Son; Mr. Allardice, Ed. Todd & Co.; I. Freedman, Odenheimer Zimmern, & Co. and S. Levy; S. Levy & Co.

## BIG RETURNS MADE FOR OLD GOLD AND SILVER.

Check Forwarded 24 Hours After Receipt of Consignment.

### J. RATHBONE,

GOLD AND SILVER REFINER, ASSAYER AND SWEEPSMELTER,  
Nos. 1 to 9 Matthewson St., Cor. Cove, Providence, R. I.

## THE PERFECT COLLAR BUTTON, "THE BENEDICT."

PATENTED AUGUST 17TH, 1886.

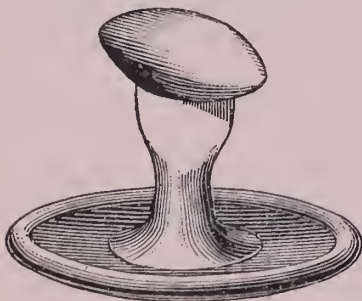

Having secured the sole right to manufacture the above buttons, they are now offered to the trade in

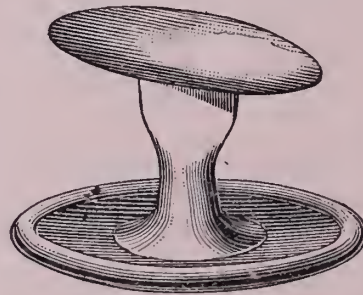

14 Kt. Gold, 10 Kt. Gold, Sterling Silver and Rolled Plate.

**ENOS RICHARDSON & CO.**  
23 MAIDEN LANE, NEW YORK.



## MUELLER'S ARTIFICIAL EYES.

\$75 per hundred; smaller lots, \$25 per dozen; \$2 each. A large assortment of eyes will be sent to any dealer to enable him to make selection, upon receipt of satisfactory references. We carry the largest stock in America.

ONLY MANUFACTURERS OF THE "DIAMANTA" SPECTACLES AND EYE-GLASSES.

Oculists' prescriptions promptly and accurately filled. Catalogue, price lists, test cards, etc., on application.

M. ZINEMAN & BRO., American Agents, 130 South Ninth St., Philadelphia.

### TO MY WATCH.

FOR seven days thou hast had for repose  
A pillow softer than the eider's down,  
Far sweeter than the balmy air that blows  
Across a field where every flower's a rose,  
And fairer than those silvery rays which crown  
The opening day, and banish night's dark brown.

Thou hast reposed within a sacred dell,  
Between two polished ivory hillocks white;  
Against her pulsing heart thou rose and fell.  
Alas! its secret love thou canst not tell;  
But O, how oft, thou measurer of time's flight,  
With reverence I've kissed thy face to-night!

—New York Sun.

## PARSONS : SCHOOL

— FOR —

WATCHMAKERS,

PEORIA, - - - ILL.

Send for Circular and Terms.

PARSONS & CO.

WHEN IN CHICAGO, VISIT THE

## Chicago Watchmakers' Institute,

SUITE, 1521-1523 B MASONIC TEMPLE.

A Modern Trade School for the Watchmaker, Jeweler and Engraver.



**Detroit.**

M. S. Smith and F. G. Smith, Jr. are in the east on business.

C. E. Hastings, of Carter, Sloan & Co., spent last week here with old friends. He traveled for the firm in this section thirteen years ago.

Maurice E. Elliot, manager of the optical department at F. G. Smith, Sons & Co., was married last week to Miss Roberts, of Pontiac, Mich.

The new company recently started here by former employes of the United States Optical Co., at 5 E. Fort St., has been named the New York Optical Co.

C. H. Smith was arrested last week at Cadillac, Mich., with a large number of gold watches and cases in his possession. He had cards marked Ionia in his grip, and it is thought that he is connected with a jewelry robbery that occurred there last Spring.

William Waldman and William Mellus were arrested last week while in the act of stealing five watches from the show case in the store of Harry Sands. They waived examination later and were bound over for trial. They are well-known crooks here.

Trade with the jobbers shows a slight but steady improvement. It is noticed principally in mail orders. The following Michigan country jewelers were here last week: Frank Nolan, Hadley; S. Blashill, Oxford; William Walthers, Wyandotte; Mr. Cohen, Traverse City; S. McGlaughlin, Wyandotte; and George Chappel, Howell.

George L. Lowe, with Kennedy & Koesler, has returned from a five weeks' trip in Upper Michigan. He reports business as

fair. It is excellent near Sault de Ste. Marie owing to the large sums being disbursed there on the government canal. H. A. Harrison, of the "Soo," is located in a tent, awaiting the completion of a building recently occupied by him and burned. He has purchased a new stock of jewelry and will start in again.

**Rockford, Ill.**

The Scandia Watch and Jewelry Co. have moved into handsome new quarters in the Royal block, on 7th St.

The jewelers of the city have signed an agreement to close their stores at 6 o'clock P. M., except Saturdays, until Dec. 1st.

After an enforced idleness of several weeks, the Rockford Watch Co. began working on full time, Oct. 16. A large number of hands were taken on and the force will be increased as circumstances warrant. An order for 1,900 watches was received recently.

Despite the dull times the Rockford Watch Case Co. have kept their full force at work, on regular time. Collections have been slow, but Manager Taft has shown good executive ability in getting along without a cut in hours, or laying off employes. Orders are coming in at a very satisfactory rate.

**Birmingham, Ala.**

Leo Schwab has gone into the jewelry business again. For years he was a leading jeweler here, but a year or two ago retired from the trade. He has fitted up an elegant store at 1916 First Ave.



With Guarantee as to Quality

FOR

SEND TO

**J. T. Scott & Co.**  
4 MAIDEN LANE,  
NEW YORK.

**ETCHING TAUGHT FOR \$10.**

Having received numerous requests for our formulas in silver etching, we have decided to give individual instruction to those desiring to do their own work and save delay and shipping expenses. Jewelers can take advantage of this offer while visiting the Fair. Printed formulae and practical instruction in their use will be given where time is limited. Refer to any jewelry firm in Chicago. All kinds of etching done for the trade.

**LYMAN & CO.,** ETCHERS AND ENGRAVERS, 96 State Street, Chicago.



HARDINGE ROLLER REMOVERS,  
THE BEST ON EARTH.

MANUFACTURED BY

**HOROLOGICAL TOOL CO.**

OFFICE: 86 N. CLARK STREET,  
Factory: 1036 Lincoln Ave., CHICAGO.

For Sale by all Jobbers.

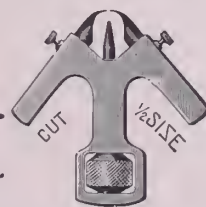

**GIBSON HOUSE,**

CINCINNATI, OHIO.

ABSOLUTELY FIRST-CLASS AMERICAN PLAN HOTEL.

\$3.00 PER DAY.

Extra Charge for Parlors and Rooms with Bath attached. The unequalled advantages in central location, liberal management, modern appointments, experienced service and perfect cuisine, have permanently established the Gibson House as The Most Popular First-Class Hotel in Cincinnati.

AMPLE VAULTS FOR THE PROTECTION OF VALUABLES.

**THE GIBSON HOUSE CO.,**

H. B. DUNBAR

President and Manager.



61 Hanover Street, Boston, Mass.

Sales made for Jewelers only in their established places of business. Can give best references of any auctioneers in America.

All communications strictly confidential.

M. E. Linnihan has removed his jewelry store to 1927 First Ave.

At Union Springs, Ala., invitations are out for the marriage of Henry Joseph Rosenstihl, a popular young jeweler of that place, to Miss Emily C. Randle, to take place Oct. 25th.

The jewelers of Birmingham are taking steps to have the law recently enacted by the Alabama Legislature in regard to pawnbrokers enforced. It compels all pawnbrokers to advertise for a fixed time goods left with them before the same are sold, and when sold it must be at public auction.

### Minneapolis and St. Paul.

H. P. Marx, Shakopee, Minn., was in Minneapolis last week purchasing his Fall stock.

Wm. Krohn, Annandale, Minn., recently sold out his business to Frank Cruikshank, formerly at Delano, Minn.

A report from Renville, Minn., says that

Dreyer & Rubin's store has been robbed of eleven watches. Slight clue.

J. Keichen until recently watchmaker for M. L. Cohen, Minneapolis, has accepted a similar position with P. F. Eagen, St. Paul.

W. F. Adams, Simpson, Hall, Miller & Co., E. E. Spalding, Lapp & Flershem; and Mr. Simpson, Otto Young & Co., were in the Twin Cities last week.

A. Weding, Minneapolis, who conducted a jewelry business at 1411 Washington Ave., for the past five years has closed up his store owing to dull trade.

P. F. Egan, St. Paul, has again embarked in business and has opened up in the store vacated by W. H. Breen on Wabasha St., between Fifth and Sixth Sts.

The following Minneapolis jewelers have gone on a ten days' trip to the World's Fair; L. D. de Mars, Reed & de Mars Jewelry Mfg. Co., R. G. Winter, J. W. Dupont, and Fred Fiske.

The wife of A. C. Arenson, who up to

1885 was the proprietor of a jewelry establishment at 209 Washington Ave. S., Minneapolis, is under arrest in Omaha on a charge of disturbing the peace. Her trouble arises from her determined pursuit of Mr. Arenson, whom she declares eloped some time ago with the sister of Samuel Banks, a jeweler of Omaha. Mrs. Arenson says that Arenson met Miss Banks in Minneapolis and shortly afterwards disposed of his business and eloped with the girl. She has since heard of him in Africa, Austria and now believes him to be in New South Wales.

The Reed & de Mars Jewelry Mfg. Co., Minneapolis, contemplate moving into larger quarters, and are advertising their lease of their present store for sale.

### Pacific Coast Notes.

R. McDonald, Tulare, Cal., has enlarged his store.

C. H. Morris, Dallas, Ore., is reported seriously ill.

J. Glick, Stockton, Cal., has made an assignment.

L. Sehuman, Portland, Ore., has given a bill of sale for \$250.

L. E. Leaven jeweler, Alameda, Cal., was recently married to Miss R. E. Farquhar.

The Orient Jewelry Co., Oakland, Cal., have gone out of business.

"For Her Sake" is the title of a new novel written by Harry Levy, of the jewelry firm of Haas & Levy, San Francisco.

Lange & Co., jewelers and watch makers Victoria, B. C., have moved to a larger store on Douglas St.

J. W. James' jewelry store, Oakland, Cal., was destroyed by fire a few days ago. Mr. James carried no insurance. Most of the valuable goods was saved.

### Lancaster, Pa.

Charles S. Franz has opened a jewelry and optical goods store at 109 E. King St.

Walter C. Herr, who recently sold his jewelry business to S. Kurtz Zook, has entered into partnership with his brother in the coal and wood business.

Among the traveling men in Lancaster the past week were: Geo. S. Melville, Acme Silver Plate Co.; J. S. Richter, American Watch Case Co.; Fred H. England, H. Z. & H. Oppenheimer; H. B. Bliss, Gorham Mfg. Co.; W. Strauss, Jacob Strauss & Sons; J. F. Dean, Reed & Barton; Alexander Conklin, Reading Spectacle Co.; U. S. Davis, H. Muhr's Sons; Chas. Van Ness, Reeves & Sillocks; John Ehlers; J. H. Thompson, Bioren Bros.; Gus. Mayer, with Geo. Mayer; E. H. Smith, Holmes & Edwards Silver Co.; Arthur Bradshaw, Meriden Britannia Co.; W. H. Bryant, T. G. Hawkes & Co.

A. B. Van Cott, Madison, Wis., has given a chattel mortgage for \$3,000 on merchandise.

# Paul Jeanne, EIGHTEENTH STREET and 4<sup>TH</sup> AVE., N. Y.

(Bradley Building.)

MANUFACTURER OF

## ≡ FINE DIAMOND JEWELRY ≡

### THE IMPROVED RIVAL FOUNTAIN PEN. Most Reliable and Guaranteed to Give Perfect Satisfaction. Over 75,000 in Use.

Send for  
Price List.



Liberal Dis-  
counts to  
the Trade.

**D. W. BEAUMEL,** Inventor and Manufacturer, REPAIRING A SPECIALTY, 17 John St., New York.

**WM. BIRMINGHAM & CO.,**  
MANUFACTURERS OF

All Kinds of Leather Spectacle and Eye Glass

**CASES,**

728 Arch Street, PHILADELPHIA, PA.

For **BADGES AND MEDALS,**

Flag Pins, Class Pins, Class Rings  
and Special Work of all Descriptions.

SEND TO **E. R. STOCKWELL,** MANUF'R,  
19 John Street, New York

# A. J. HEDGES & Co.,

— MANUFACTURERS OF —

## Variegated and Enameled Jewelry,

Black and White Enameled Goods

A SPECIALTY.

Lace Pins, Scarf Pins,

Brooches and Pendants,

Gold and Silver Garters,

Link Buttons, Bracelets,

Hat and Hair Pin Attachments.

6 Maiden Lane, New York.

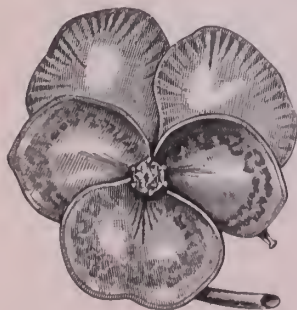

FACTORY--90 Mechanic St.,  
NEWARK, N. J.

**Providence.**

J. Graff has started in the retail business at 278 S. Main St.

F. O. Clarence has removed from 107 Friendship St., to 78 Weybosset St.

Kirkpatrick & Vickery is the style of a new retail firm at 245 S. Water St.

Theodore W. Foster, of Foster & Bailey, is at the Columbian Exposition for a few weeks.

Gourdier & Clark, 108 Friendship St., have dissolved by the withdrawal of Ira Clark.

Mr. Levy, of Levy Bros. Co., Hamilton, Ont., has been in town the past week purchasing Fall stock.

The large ring house of Ostby & Barton Co. will be represented this Fall by John A. Keane between New York and Chicago, and by D. A. Wilkinson south and west.

Ira Clarke and William Corbin have formed a co-partnership under the firm name of Clarke & Corbin, for the purpose of manufacturing jewelry, with bench room in the shop of T. P. Ide, 34 Potter St.

Secretary John F. P. Lawton, of the Gorham Mfg. Co., delivered an interesting lecture on the company's World's Fair exhibit by the aid of stereopticon views, before the Young Men's Christian Association on Friday evening last.

The will of the late Stephen Albro will be probated in the Municipal Court on the 24th inst. Alice L. Albro, a minor daughter, has petitioned the Municipal Court that her mother, Mrs. Rowena Albro, be appointed her guardian.

The co-partnership heretofore existing between William M. Patt, George H. Kettlety and Herman Kern, as Patt, Kettlety & Kern, has been dissolved, Mr. Kettlety retiring. The business will be continued by Messrs. Patt & Kern at the same address. Mr. Kettlety has returned to his trade of designer and hub cutter.

**Philadelphia.**

C. P. Shott has transferred his repair shop from 3d St. to Sansom St.

Davis & Galt have resumed full time at their Sansom St. establishment.

Harry Schrimpf's visit to Chicago has been postponed owing to the demands of business.

Jacob Muhr has been re-elected a member of the board of directors of the Trust Company of North America.

E. A. Bliss, of Meriden, Conn., arrived

at the Colonnade Friday night after a five weeks' trip through the west.

Joseph T. Bailey, of Bailey, Banks & Biddle, has returned from a visit to the World's Fair, during which he paid special attention to the foreign collections.

In quarter sessions last week Charles Nelson, a watch repairer, was sentenced to one year's imprisonment on the charge of stealing a gold watch from Elijah Dewirts and a ring from George Goldstein.

Harry Loveland, formerly employed by Bailey, Banks & Biddle, was on Thursday held in \$400 to keep the peace by Magistrate Clement. He was charged with annoying that firm. Loveland had been discharged and secured employment elsewhere. Since then he has been in the habit of visiting the store and upon being ordered out he would become abusive.

Wm. Sidley was convicted last week of burglary, in entering the store and dwelling of jeweler John F. Bates, 2403 Market St., and stealing jewelry and other articles valued at about \$200. Philip McDevitt, indicted with him, was acquitted. Sidley was sentenced to three years in the Eastern Penitentiary.

**Connecticut.**

Many employes in the Bradley & Hubbard Mfg. Co.'s factory, Meriden, are working full time.

Paul Roessler & Co., opticians, New Haven, have dissolved and been succeeded by Roessler & Co.

Hartford's city authorities have granted a permit to the Barbour Silver Co. to build a brick structure of four stories on the south side of Temple St.

Mrs. Durant, wife of J. H. G. Durant, New Haven, has returned from England. She visited her old home and family, and brought back her eldest daughter, who had been visiting relatives there for the past year.

Deacon D. C. Eaton, aged 78, who died in Meriden, Saturday, 7th, of paresis, worked in the Rogers silver plate factory, in Hartford during the war period, and then removed to Meriden, where he has since lived and was in the Britannia Co.'s employ.

A Bridgeport journal says: "Mr. Charles A. Hamilton, of Rogers & Hamilton, Waterbury, and also of the Bridgeport Brass Co., was in town yesterday, and intimated that at some future time he might come to Bridgeport to live and bring a new industry with him. He will be welcome."

**AIKIN, LAMBERT & CO.**

19 Maiden Lane, NEW YORK.

Branch, 42 & 44 East Madison St., CHICAGO, ILL.

Manufacturers and Exporters of

Gold Pens, Holders, Picks, Pencils,

Fountain Pens, etc.

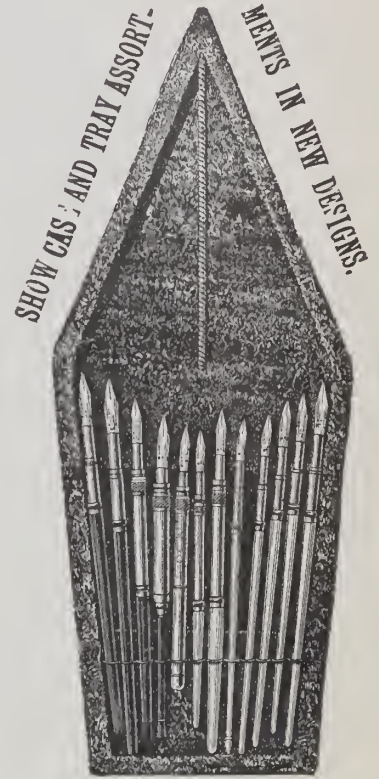

11 x 5 1/2 inches.

**PLUSH TRAY WITH EASEL BACK.**

1 Doz. 16 K. Pens and Assorted Holders, List, \$3.

1 Doz. 10 K. Pens and Assorted Holders, List, \$24

Send for Trade Discount.

**Headquarters**

FOR ELECTRIC & PORTABLE Watchman's Clocks

Lowest Prices. Latest Improvements. Patents 1886-1893. Send for Circular.

E. O. HAUSBURG, 41 Maiden Lane, New York.

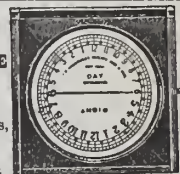

Price, Complete \$10.00

THE "ALERT."

**Brunor Plating and Jewelry Rep. Co.**

Jewelry Matched and Repaired, Engraving, Chasing and Enameling, Setting, Polishing and Lapping, Battery Gilding and Roman Coloring, Watch Cases Repaired, Polished and Gilded.

32 Maiden Lane, New York

**CROUCH & FITZGERALD**

Jewelry Trunks and Cases

161 Broadway

Bet. Cortlandt and Liberty Sts.,

688 B'way,

701 6th Ave.

NEW YORK



*Our Catalogue No 4 of Diamond Ring Mountings is ready - it is useful, send for it Waterman & Lehmann 37 Maiden Lane New York*

### Syracuse, N. Y.

Simon Lesser left Friday evening for a business trip to New York.

Wm. and Benj. Lesser returned Saturday evening from a visit to the World's Fair.

J. D. Griffin, agent of M. J. Hartigan, has disappeared with about \$200 of the firm's money.

Traveling men visiting Syracuse, the past week were: C. F. Goodwin, Wm. Rogers Mfg. Co.; A. L. Halstead, Barbour Silver Co.; Geo. L. Sweet, Hayward & Sweet; F. Vaslett, Fletcher, Burrows & Co.; F. C. Somes, Marsh & Bigney; Max Potter, J. M. Fisher & Co.; Geo. B. Kenrick, Reed & Barton; T. C. Nicholson, Flint, Blood & Co.; N. B. Eltinge, L. Sauter & Co.; A. S. Sulzberger, Sulzberger & Gunzberger; Sam Halias, J. J. Cohn; Harry Ingraham, Alling & Co.; Otto H. Wolff, Bippart & Co.; T. J. Richter, American Watch Case Co.; L. E. Van Horn, Philip Zellenka & Son; R. L. Moorhead, R. L. Moorhead & Co.; H. M. Manning, Smith & Knapp; S. Glenn Walmsley, Tenner & Baum; Wm. G. Nerpel, Nesler & Co.; Thomas F. Kelkenny, Capron & Co.; Mr. Beatty, Waite, Mathewson & Co.; Mr. McDonough, Courvoisier-Wilcox Mfg. Co.; Leon Schwab, New Haven Clock Co.; Nat. Durlach, Durlach Bros.; W. J. Miller, Seth Thomas Clock Co.; Joseph Hammerslag, Falkenau, Oppenheimer & Co.; Fred. A. Ray, John C. Wolstenholme.

### News Gleanings.

Freed & Crockin, Baltimore, Md., have dissolved.

F. Weatherford, Bradfordsville, Ky., has gone out of business.

L. Brandt & Co., Memphis, Tenn., have made an assignment.

O. H. Venner, Blue Hill, Me., has sold out to Sherman Hickley.

F. W. Clark has removed from Mohawk, N. Y., to Syracuse, N. Y.

S. T. Parsons, Odelbolt, Ia., has given a chattel mortgage for \$1,000.

A. A. Gerlach, Columbus, O., has transferred real estate for \$5,000.

The store of C. E. Frederick, Parkersburg, Ia., was burned out last week.

W. E. Whitney, Yale, Ia., has sold his jewelry stock to Mr. Harshburger.

Harry U. Rogers, formerly of Lucerne, Minn., will locate in Winona, Minn.

Chas. G. Deuble, Malvern, O., has given a borrowed money mortgage for \$600.

J. W. Lipop, Clifton Forge, Va., has moved to a new location in that town.

Geo. M. Wilkinson, Mansfield, O., has given a real estate mortgage for \$3,000.

In a fire in West Randolph, Vt., the jewelry store of N. W. Udall was considerably damaged.

A. C. Billon, Pipestone, Minn., has sold out to John Arnesen, formerly of Montevideo, Minn.

J. I. Nunteer has removed from Lewistown, Ill., to Cantor, Ill., where he has opened a jewelry store.

Herbert Swartzfiger, of Binghamton, N. Y., has opened a watch repairing establishment in Oxford, N. Y.

Frank W. Guild, of North Attleboro, Mass., has bought out Mrs. H. H. Wells' jewelry store, Holliston, Mass.

William Rushmer has opened a handsome jewelry store in the Strait Block, on S. Union Ave., Pueblo, Col.

B. L. Gates, formerly of Chicago, Ill., has opened a new jewelry store at 106 S. Phillips Ave., Sioux Falls, S. Dak.

The trustee's sale of the stock of Andrew E. Warren, Baltimore, Md., is advertised to take place Oct. 26 and 27.

In a fire in Meshoppen, Pa., the jewelry store of P. C. Frutchey, was burned out. The insurance is light.

Moses G. Wasser, Schwenksville, Pa., died last Sunday afternoon of typhoid fever. Deceased was only twenty-one years of age.

The trial of Robert J. Knox, the American charged with robbing a jeweler of the City of Mexico, of \$12,000 worth of goods, is now in progress in that city.

Wallace L. Bemis, dealer in watches, jewelry and bicycles, Spencer, Mass., has made an assignment to Luther Hill for the benefit of his creditors.

W. P. Wehrle, of Indiana, Pa., has returned from California, and will resume his optical goods business, having his office in the jewelry store of his brother, B. I. Wehrle.

Gus Lyons and F. G. Scott, of Ottumwa, Ia., have formed a partnership and will open a new jewelry store at 111 E. Main St., that city. A building at that address is being erected especially for them.

Charles W. Elbow has severed his connection with the Manhattan shirt mills of Patterson, N. J., and has gone into the jewelry business, associating himself with Leon Friedman, the Market St. jeweler.

F. D. Day, Duluth, Minn., attended the convention of Northern Pacific R. R. watch inspectors, at St. Paul last week. He has since gone to West Baden, Ind., for his health.

Jos. M. Geist, Duluth, Minn., has completed and opened the art and cut glass department in his store. It consists of an addition to the back part and enlarges his floor space to twice as much as it was before.

Claude D. Lovejoy, a well-known watchmaker, of Manchester, N. H., twenty-two years old, is missing. He was last seen in that place Oct. 7th, when he told a friend that he would take a trip to Boston. He has a wife to whom he was united in June of the present year.

### Closing Exercises of the October Class of Spencer Optical Institute.

The October class of 1893 in theoretical and applied optics of the Spencer Optical Institute, New York, held their closing exercises at the Café Columbia upon the evening of the 13th inst., at which thirteen gentlemen received their diplomas from the hands of R. H. Knowles, M. D. Geo. W. Hales, of Kensington, L. I., president of the Alumni Association, in behalf of the class, presented Dr. Knowles a Masonic emblem studded in diamonds with an appropriate inscription. The following resolutions were unanimously adopted by the class:

*Resolved*, That the October class, 1893, Theoretical and Applied Optics, Spencer Optical Institute, convened, do hereby desire to express their appreciation of the courtesy and encouragement of the Spencer Optical Mfg. Co. while the class was in New York city, and moreover, that the class desires to express their confidence in the institute, and the methods employed for properly teaching the intricate subject of refraction, and that the above house are doing a good work for all graduate opticians.

2. That the October class, 1893, desires to express their tenderest regards for Geo. W. Hales, the president of the Alumni Association, for his encouragement and presence, and his interest in the profession, especially for those who are graduates of the Spencer Optical Institute.

3. That the October class, 1893, desires to express for R. H. Knowles, M. D., their esteem and love for him and his untiring efforts and enthusiastic teaching, that his efforts in their behalf are highly appreciated, and that they will keep ever green not only the principles of optics, but the principles of manhood as well.

The resolutions were signed by R. Riles, Florida; W. P. Hoag, N. J.; Chas. F. Wood, N. Y.; W. S. Lydecker, Mo.; Silas J. Sanford, N. Y.; Henry W. Brown, Washington; John W. Carter, N. Y.; Ernest K. Farrior, N. C.; Chas. Mathews, N. Y.; Geo. D. Calder, N. Y.; Adolph Hirsch, N. Y.; S. W. Carter, N. Y.; James Findlay, Ontario.

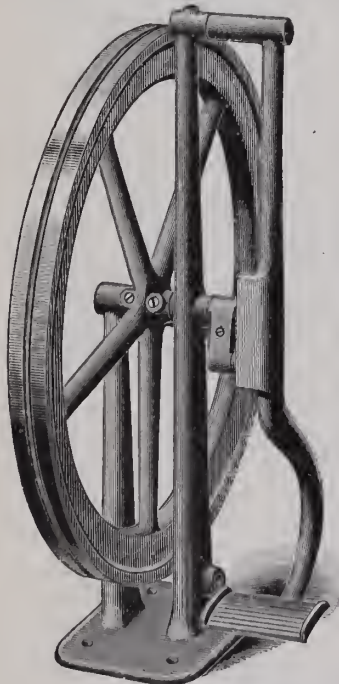

Ask your Jobber for the

**IMPROVED \* FOOT \* WHEEL.**

Diameter of wheel, 20 inches. Weight, 40 lbs.  
Inch. Total weight, 65 lbs.

**W. W. OLIVER, MANUFACTURER,**

**BUFFALO, N. Y.**

Send for our No. 10 Catalogue.

### Cincinnati.

Clemens Hellebush is east this week, buying goods.

The young thieves who burglarized the store of the John Holland Gold Pen Co., were sentenced to the workhouse. Some of the goods was recovered.

Visitors in town last week were: Charles Held, Falmouth, Ky., who is en route to the World's Fair; F. Bousky, Charleston, W. Va.; Ed. L. Feyler, Portsmouth, O.

Oskamp, Nolting & Co. last week turned over to the fund for the unemployed the sum of \$200, being one-tenth of the net receipts of the week ending Oct. 7th. This was in the retail department.

Sam Koch, manager of the Atlas Jewelry Co., is still buying goods. The concern contemplates the first of the year forming a stock company, and going more extensively into the wholesale business.

Amberg & Co. will not leave their present handsome quarters at 5th and Elm Sts., on which they have a lease. The report that they are to open at 75 Fountain Square, near their old stand, may be true, but it will only be a branch store, the headquarters being at 5th and Elm Sts.

Travelers are not selling the quantity of goods they ought to at this season, while the jobbers are not pushing for sales as they used to. The wise dealer, if he means to buy holiday goods at all, is buying them now, for he realizes that later he will not have so complete stocks to select from.

### Boston.

A. T. Sylvester, of H. T. Spear & Son, who has been ill for about a fortnight, is able to be at his place of business again.

J. E. Thompson has removed from 1382 Tremont St. to a very attractive new store near the Roxbury depot.

T. R. Marvin, formerly with Robbins, Appleton & Co., is traveling on the New England circuit for E. A. Cowan & Co.

E. H. Saxton & Co.'s new clock department has a room on the floor above the firm's present quarters and is in charge of F. H. Lincoln.

In the insolvency court last Friday, the case of Meyer I. Bornstein, Washington and Hanover Sts., came up for the third meeting, and was adjourned to Nov. 17th.

Buyers in town the past week included: N. L. Hildreth, Marlboro; J. D. Hicks, Fall River; P. A. Chisholm, Gloucester; W. B. Studley, Rockland; C. H. Nelson, Concord, N. H.; E. W. Folsom, Somersworth, N. H.

The man who laid the foundation stones for the great watch factory buildings at Waltham died in that city last Thursday. His name was Nicholas Roche, and he was one of the leading contractors in the county.

Ed. E. Hardy has the sympathy of his

many friends in his bereavement by the death of his father. Among the floral tributes at the services was a beautiful wreath from Mr. Hardy's associates in the establishment of D. C. Percival & Co.

Alvan Clark, the famous Cambridge telescope maker, has lately returned from Chicago, where he read a paper before the Science Congress. Mr. Clark has about eight months in which to finish the great lens for the Yerkes telescope now under contract.

### Canada and the Provinces.

L. Lewis, Aylmer, Ont., is about to move his business to Waterford, Ont.

E. D. Jordan, Chatham, Ont., has admitted Geo. Turner into his business as partner.

The marriage took place at Halifax, on the 10th inst., of Samuel R. Parsons, jeweler, Irwin, N. S., and Miss Margaret A. Leaver, of Birmingham, Eng.

Fred W. Wright, who has been in the employ of W. H. Mallett, jeweler, Souris, Man., for the past three years, has left for Prince Albert, where he has secured a situation as manager of a jewelry store.

The celebrated "gold dust" swindle occupied the attention of Judge Muir in the Court House, Hamilton, last week, when Samuel Levy was tried on the charge of obtaining \$2,200 and a gold watch and chain under false pretenses from young Abraham Rosenthal, of Toronto. The evidence of

the complainant was a repetition of his evidence already published. Levy was found guilty and sentenced to two months with hard labor.

A man giving his name as Davis, Adams and McManus, has been arrested in Halifax, N.S. Last week he called upon the wholesale jewelry firm of Levy & Michaels, and after inspecting the finest diamonds in stock gave an order for a ring to be set with a diamond valued at \$1,000. He also called upon C. G. Shulze, jeweler, and purchased \$700 worth of jewelry for which he was to pay the next day. The money not being paid, the goods were not delivered.

### The Receivership of E. A. Freeman Made Permanent.

HARTFORD, Conn., Oct. 13.—Mayor Wm. Waldo Hyde appeared before Judge George W. Wheeler to-day in the Superior Court and asked that the appointment of E. A. Freeman, as receiver for the E. N. Welch Mfg. Co., be made permanent. Judge Wheeler took no exception to the paper presented by Mayor Hyde, but suggested that the instructions to the receiver be made more definite in certain particulars.

Mr. Freeman's appointment as receiver was made permanent. The bonds were increased from \$25,000 to \$50,000 and he was ordered to report every six months to the court. The indebtedness of the company amounts to about \$450,000, and this amount is somewhat increased by contingent liabilities.

THE JUDGES AT THE

## World's Columbian Exposition

HAVE GIVEN US AN

# AWARD

ON OUR EXHIBIT AS MADE THERE. THIS EXHIBIT WAS MADE READY IN APRIL LAST. SINCE THAT TIME WE HAVE PRODUCED GOODS IN THE LINE OF

## Emblems, Charms AND Rings,

THAT FAR EXCEED IN BEAUTY AND ORIGINALITY OF DESIGN, MANY OF THE GOODS IN OUR CHICAGO EXHIBIT. WRITE US.

## IRONS & RUSSELL,

Providence, R. I.

**CLASSIFIED INDEX TO ADVERTISEMENTS.**

All Advertisements are entitled to one insertion under proper heading. Extra insertions, \$6.00 per annum. Extra Headings, \$12.00 per annum.

<b>Art Pottery, Bric-a-brac, Etc.</b>	Page.
Ahrenfeldt & Son, 56 Murray St., N. Y.....	48
Bawo & Dotter, 28, 30 & 32 Barclay St., N. Y. . .	55
Bing, Ferdinand & Co., 106 Grand St., N. Y. . .	46
Borgfeldt, Geo. & Co., 18, 20 & 22 Washington Place, New York.....	50,51
Bradley & Hubbard Mfg. Co., Meriden, Conn	12
Buning, F. W. & Co., 58 Murray St., N. Y. . .	54
Craighead & Wilcox, 33 Barclay St., N. Y. . .	53
Gleanzer Leon, J. & Co., 80 & 82 Chambers St., N. Y. . . . .	49
Hinrichs & Co., 29 & 31 Park Place, N. Y. . . .	54
Le Bontilier & Co., 860 Broadway, N. Y. . . . .	15
Levy, Dreyfus & Co., 9 & 11 Maiden Lane, N. Y.	4
Straus, L. & Sons, 42 to 48 Warren St., N. Y. . .	19
<b>Assayers &amp; Refiners.</b>	
Clark, J. L., Philadelphia, Pa. . . . .	45
Goldsmith Bros., Chicago, Ill. . . . .	23
Howard, S. P., 8 John St., N. Y. . . . .	56
Le Long, L. & Bro., Newark, N. J. . . . .	56
<b>Auctioneers.</b>	
French, J. H., P. O. Box 2775, New York. . . . .	9
Rathbone, J., Providence, R. I. . . . .	32
Rich, H. M. & Co., Boston, Mass. . . . .	33
Scott, De B. O., 20 Murray St., N. Y. . . . .	39
Tirrell, R. W., 14 Pembroke St., Boston, Mass.	14
<b>Badges, Medals, Etc.</b>	
Irons & Russell, Providence, R. I. . . . .	27-37
Schlechter, G. A., Reading, Pa. . . . .	14
Stockwell, E. R., 19 John St., N. Y. . . . .	34
Wilson, Chas. G., Reading, Pa. . . . .	4
<b>Chain Manufacturers.</b>	
Blackinton, W. & S., Attleboro, Mass. . . . .	24
<b>Cleaning Solution.</b>	
Quarters, W. F., Providence, R. I. . . . .	7
<b>Clocks, French and English.</b>	
Jacques, Chas., Clock Co., 22 Courtlandt St., N. Y. . . . .	56
Kroeber F., Clock Co., 360 Broadway, N. Y. . . .	22-52
<b>Cut Glass.</b>	
Mt. Washington Glass Co., New Bedford, . . .	54
<b>Diamond Cutters.</b>	
Humphrey, J. B., Boston, Mass. . . . .	56
<b>Diamond &amp; Precious Stone Importers.</b>	
Disselkoen, John N., 19 E. 16th St., N. Y. . . .	43
Eichenberg, Julius, Providence, R. I. . . . .	39
Falkenau, Oppenheimer & Co., 40 Maiden Lane, N. Y. . . . .	56
Fera, Henry, 10 Maiden Lane, N. Y. . . . .	9
Hedges, Wm. S. & Co., 170 Broadway, N. Y. . . .	42
Jeane, Paul, Bradley Bldg., N. Y. . . . .	34
Kahn, I. & M. & Co., 10 Maiden Lane, N. Y. . .	56
Kipling, R. A., Hays Bldg., N. Y. . . . .	42
Kipling, E. E. 182 Broadway, N. Y. . . . .	56
Leonhardt & Curran, 44 1/2 Maiden Lane, N. Y.	11
Lorsch, Albert & Co., 37 Maiden Lane, N. Y. .	56
Ludeck & Power, 23 John St., N. Y. . . . .	42
Nissen, Ludwig & Co., 18 John St., N. Y. . . .	42
Randel, Baremore & Billings, 29 Maiden Lane,	43
Rothschild, M. D., 41 & 43 Maiden Lane, N. Y. .	56
Scott, J. T. & Co., 4 Maiden Lane, N. Y. . . . .	42
Smith, Alfred H. & Co., 182 Broadway, N. Y. . .	42
Wolff & Gunzburger, 87 Nassau St. N. Y. . . . .	56
<b>Diamond Jewelry.</b>	
Waterman & Lehman, 37 Maiden Lane, N. Y. .	35
<b>Enamelware.</b>	
Sampson, Sophus, Chicago, Ill. . . . .	27
<b>Etching School.</b>	
Lyman & Co., Chicago, Ill. . . . .	33

<b>Fine Stationery.</b>	Page.
Parsons, Green & Co., 18 Murray St., N. Y. . .	5
<b>Fountain Pens.</b>	
Smith, H. M., & Co., 83 Nassau St., N. Y. . . .	56
The Boston Pen Co., Boston, Mass. . . . .	45
<b>Gold and Silver Plating.</b>	
Brunor Plating and Jewelry Repairing Co. . . .	
Maiden Lane, N. Y. . . . .	35
H. B., Bolstad, Plating Co., Chicago Ill. . . . .	27
<b>Gold Jewelry.</b>	
Bippart & Co., Newark, N. J. . . . .	7
Carter, Sloan & Co., 15 Maiden Lane, N. Y. . .	43
Horstman, Richard, World's Fair Grounds, . . .	30
Krementz & Co., 182 Broadway, N. Y. . . . .	12
Racine Jewelry Mfg. Co., Racine, Wis. . . . .	26
Richardson, Enos & Co., 23 Maiden Lane, N. Y.	32
Smith, C. Sydney, 191 Broadway, N. Y. . . . .	8
Street, Geo. O. & Sons, 15 John St., N. Y. . . . .	14
<b>Horological Schools.</b>	
Chicago Watchmakers' Institute, Chicago, Ill. .	32
Parson's School for Watchmakers, Peoria, Ill. .	32
Palmer & Swain, Waltham, Mass. . . . .	45
<b>Hotels.</b>	
Gibson House, Cincinnati, O. . . . .	33
<b>Improved Show Cases.</b>	
Fletcher Mfg. Co., 259 W. 27th St., N. Y. . . . .	17
<b>Jewelry Mailing Boxes.</b>	
Am. Railway Supply Co., 24 Park Place, N. Y. .	39
<b>Jewelry, Silverware and Optical Cases.</b>	
Birmingham, Wm. & Co., 728 Arch St., Phila. .	34
Troescher, A. & Co., 69 Nassau St., N. Y. . . .	42
Wiggers & Froelick, 60 Nassau St., N. Y. . . .	42
<b>Jobbers, Watches, Diamonds, Etc.</b>	
Aikin-Lambert Jewelry Co., 19 Maiden Lane. . .	8
Bowman, Ezra F. & Co., Lancaster, Pa. . . . .	45
Cross & Beguelin, 17 Maiden Lane, N. Y. . . .	11
Friedlander, R. L. & M., 65 Nassau St., N. Y. . .	14
Giles Bros. & Co., W. H. Gleason, receiver, Chicago, Ill. . . . .	29
Myers, S. F. & Co., 48 Maiden Lane, N. Y. . . .	56
Young, Otto & Co. Chicago, Ill. . . . .	28
<b>Leather and Silver Goods.</b>	
Deutsch Bros., 7 E. 17th St., N. Y. . . . .	2
<b>Musical Boxes.</b>	
Jacot & Son, 298 Broadway, N. Y. . . . .	26
<b>Optical Goods.</b>	
Kirstein, E., Sons Co., Rochester, N. V. . . . .	5
Queen & Co., Philadelphia, Pa. . . . .	5
Scheidig, John & Co., 43 Maiden Lane, N. Y. .	56
The Nous Verrons Co., Boston, Mass. . . . .	18
Zineman, M. & Bro., Philadelphia, Pa. . . . .	32
<b>Pens, Pencil Cases, Etc.</b>	
Aikin, Lambert & Co., 19 Maiden Lane, N. Y. .	35
Beaumel, D. W., 17 John St., N. Y. . . . .	34
<b>Patents.</b>	
Cox & Sons, 11 Park Row, N. Y. . . . .	39
<b>Pocket Cutlery.</b>	
Beach, H. B. & Co., Boston, Mass. . . . .	56
<b>Ring Makers.</b>	
Bryant, M. B. & Co., 10 Maiden Lane, N. Y. . .	9
Bowden, J. B. & Co., 192 Broadway, N. Y. . . .	7
Hildreth Mfg. Co., 51 Maiden Lane, N. Y. . . .	12
Larter, Elcox & Co., 21 & 23 Maiden Lane, N. Y.	14
<b>Rolled Plate Jewelry.</b>	
Dederick, J. H., 16 Maiden Lane, N. Y. . . . .	45

<b>Sample Trunks.</b>	Page.
Crouch & Fitzgerald, 161 Broadway, N. Y. . . .	35
<b>Settings and Galleries.</b>	
Blancard & Co., 36 John St., N. Y. . . . .	11
<b>Silver Mounted Ebony Goods.</b>	
Deutsch Bros., 7 E. 17th St., N. Y. . . . .	2
Provenzano, J. N., 39 Union Square, N. Y. . . .	10
<b>Silver Plated Ware.</b>	
Holmes & Edwards Silver Co., Bridgeport, Conn. . . . .	14
Pairpoint Mfg. Co., New Bedford, Mass. . . . .	5
Rogers & Bro., 16 Courtlandt St., N. Y. . . . .	16
<b>Sterling Silver Novelties.</b>	
Bachrach & Freedman, 183 Union Sq., N. Y. . .	4
<b>Sterling Silverware.</b>	
Campbell-Metcalf Silver Co., Providence, R. I. .	38
Dominick & Haff, 860 Broadway, N. Y. . . . .	3
Durgin, W. B., Concord, N. H. . . . .	13
Knowles, J. B. & S. M., Co., Silversmiths' Hall, Union Square, N. Y. . . . .	7
Ovairt & Warner, Portland, Oregon. . . . .	28
Reed & Barton, 37 Union Sq., N. Y. . . . .	31
Shiebler, Geo. W., Co., 179 Broadway, N. Y. . .	9
Towle Mfg. Co., Newburyport, Mass. . . . .	14
Wallace, R. & Sons Mfg. Co., 3 Park Place, N. Y. . . . .	6
Whiting Mfg. Co., Broadway and 18th St., N. Y.	21
Wood & Hughes, 12 John St., N. Y. . . . .	42
<b>Stem Winding Attachments.</b>	
Abbott, Henry, 2 Maiden Lane, N. Y. . . . .	4
<b>Thimbles.</b>	
Ketcham & McDougall, 198 Broadway, N. Y. . .	11
<b>Tool Manufacturers and Dealers.</b>	
Bullock, O. W., Springfield, Mass. . . . .	7
Gesswein, F. W., 39 John St., N. Y. . . . .	8
Horological Tool Co., Chicago, Ill. . . . .	33
Logan, A. J., Waltham, Mass. . . . .	45
Mosely & Co., Elgin, Ill. . . . .	31
Oliver, W. W., Buffalo, N. Y. . . . .	36
<b>Tortoise Shell Goods.</b>	
Rice & Hochster, 483 & 485 Broadway, N. Y. . .	9
<b>Trunks and Traveling Bags.</b>	
Crouch & Fitzgerald, 161 Broadway, N. Y. . . .	35
<b>Varigated and Enameled Jewelry.</b>	
Hedges, A. J. & Co., 6 Maiden Lane, N. Y. . . .	34
<b>Watch Case Manufacturers.</b>	
Goll, Henry, 17 John St., N. Y. . . . .	14
The Planchamp & Becker Co., Chicago, Ill. . . .	28
<b>Watchman's Clocks.</b>	
Hausburg, O. E., 41 Maiden Lane, N. Y. . . . .	35
<b>Watch Importers.</b>	
Hyde's, J. E., Sons., 22 Maiden Lane, N. Y. . .	39
<b>Watch Keys.</b>	
Clark, A. N., Plainville, Conn. . . . .	4
<b>Watch Manufacturers.</b>	
Baume & Co., London, England, and Syracuse, N. Y. . . . .	30
<b>Watch Repairers.</b>	
Henry, Peter, Cincinnati, O. . . . .	27

## Special Notices.

Rates 75c. per insertion for notices not exceeding 5 lines (25 words), additional words 2 cents each. If answers are to be forwarded, postage stamps must be enclosed. Two insertions, 15 per cent. off; three insertions, 20 per cent. off; four insertions or more, 25 per cent. off. Payable strictly in advance. Display cards on this page will be charged at \$2.00 per inch for first insertion, subject to same discount as above for subsequent insertions.

Under the heading of **Situations Wanted** on this page advertisements will be inserted for **One Cent a Word**. This offer refers to **Situations Wanted only**. Payable strictly in advance. If answers are to be forwarded, postage must be enclosed.

## Situations Wanted.

Notices under this heading **ONLY** are charged at one cent a word, payable strictly in advance. If answer are to be forwarded, postage must be enclosed.

**WANTED.**—A position in New York or Brooklyn, in the jewelry or optical business. Address Box 85, Dayton, N. J.

**SITUATION WANTED.**—An experienced traveler wishes a position in a first-class house. Many years on the road and well acquainted in all sections east of Omaha. Diamond house preferred. Address E. D., JEWELERS' CIRCULAR.

**I AM A GOOD WATCHMAKER** and wish a good situation. Samuel L. H. Simpson, Winona, Minn.

**WATCHMAKER AND OPTICIAN,** "experienced," wants position of responsibility. Am thorough man. No cheap houses need apply. Address T. B., 213 N. Franklin St., Delaware, O.

**A YOUNG MAN,** twenty years of age, with some knowledge of the business, wishes position where he can have practical experience at the bench. Has had experience as salesman. Best of references. Address W. S. Macmillan, 34 North Ferry St., Schenectady, N. Y.

**FIRST-CLASS WATCH REPAIRER,** jeweler, fair engraver, twenty-two years' experience. All tools. Like to hear from good houses, who appreciate a good workman. Conrad Kohler, Linden, Michigan.

**BY** a practical jeweler, and watchmaker: 10 years on complicated work; A1 references and tools; wages \$15 per week. Address B. W., care CIRCULAR.

**WANTED.**—Position by first-class watchmaker, jeweler and repairer of musical toys, etc.; can put my hand to any variety of repairing; have all my own tools; 30 years' experience; good references. Address D. H. Jaccard, Westwood, N. J.

**TO DIAMOND CUTTERS AND POLISHERS.**—A young woman desiring to learn either diamond cutting or polishing would like to become an apprentice in a shop. Compensation no object at the beginning. Address M. V., 133 St. Felix St., Brooklyn, N. Y.

**POSITION WANTED.**—By optician salesman. Clocks and jewelry repaired. Can assist in watch work. Good references. New England, Middle and Southern States preferred. Address O. S. J., care JEWELERS' CIRCULAR.

**TRAVELER** open for engagement 1st January. Twelve years on the road with watch, jewelry and diamond houses. Best of references. Address Engagement, care of JEWELERS' CIRCULAR.

**WATCHMAKER, SALESMAN.**—Eighteen years' experience. Married. Reference from employer for ability. Good habits. Permanence desired. Address Empire State, care JEWELERS' CIRCULAR.

**A GENTLEMAN,** with highest references and thoroughly acquainted with the jewelry and kindred trades, wishes to represent an eastern manufacturer in Chicago. Address Business L., Chicago Office of JEWELERS' CIRCULAR.

**WANTED.**—Situation as watchmaker by young man of twenty-four; can do all watch and jewelry repairs and script engraving; sober and industrious; good set of tools; A1 references. Address "Enterprise," 161 Dayton St., Cincinnati, O.

**SITUATION WANTED** as watchmaker, clock and jewelry repairer; over five years' experience; good references. Address A. Austin Wilmot, Salem, N. J.

**A FIRST-CLASS watchmaker** and salesman, having an excellent equipment of tools and equally good reputation, would like a position with reliable house by Nov. 1st; twenty years' experience; would prefer New York or Pennsylvania, although no objections to the South; ten years with one firm. Address H. W., care JEWELERS' CIRCULAR.

**WANTED.**—Position by an A1 watchmaker, jeweler and salesman; twelve years' experience; have full set of tools; references exchanged. Address Permanent, care Perkins & Co., Poughkeepsie, N. Y.

**BY** first-class watchmaker, eight years' experience. Best of references given and expected. Address Lock Box 207, Carterville, Mo.

**A RELIABLE** man with a fair knowledge of the retail trade and repairing; have nearly all tools; good salesman; habits and references, A1; wages \$12 per week. Address Geo. E. Metcalf, Norfolk, Conn.

## Help Wanted.

**WANTED.**—A first class engraver and designer. Send samples of work and state salary expected. Maier & Berkele, Atlanta, Ga.

**WANTED.**—A thoroughly competent WATCHMAKER and JEWELER; one who can do engraving also, preferred; none but strictly first-class workmen need apply; must be temperate, and come well recommended; a permanent place to the right man. Address "South Carolina," care JEWELERS' CIRCULAR.

**WANTED.** Experienced traveling salesman to carry a leading and well-known line of spectacles and eye-glasses, samples easily carried; liberal commission. Address Optics, care JEWELERS' CIRCULAR.

**WANTED.**—First-class jeweler and engraver; steady work; wages \$18; must come well recommended for honesty, industry and sobriety. Send sample of engraving. L. W. Blue, Atlanta, Ga.

**WANTED** in a wholesale office, a strictly honest, bright young man from eighteen to twenty-one years old; must be a good penman and correct at figures and must reside in Newark, N. J. Address with references, F. H. Dickson, P. O. Box 2927, New York.

## For Sale.

**FOR SALE.**—Jewelry stock and good will. Location the best in the city; must be sold at once. For further particulars address C. Gerlach, 5 N. High St., Columbus, O.

## FOR SALE.

### THE JEWELRY MANUFACTURING PLANT

of the late Walter E. White, located at 86 Page St., Providence, R. I., consisting of machinery, tools, fixtures, stock, good will, etc.; to parties desirous of engaging in this business the well-known popularity and standard quality of the goods always manufactured by this firm makes this an exceptional opportunity, and one that rarely offers. Apply to WM. G. HOPKINS, Administrator, 53 Clifford St., Providence, R. I.

## TRUSTEE'S SALE.

THE undersigned will sell privately upon most advantageous terms\* to purchasers, either as a whole or in such parts as may be desired, the stock of jewelry and store fixtures of James E. Tyler, 807 East Main Street, Richmond, Virginia, said stock being in point of extent, selection, quality and variety unsurpassed in the South. Arrangements can be made, if desired for the purchase of the good will of the business of James E. Tyler, who with his predecessors, John H. Tyler & Co., Mitchell & Tyler and William Mitchell, Jr., has conducted in the City of Richmond the jewelry business for the better part of this century, and has always commanded the cream of city and State custom. Richmond presents at this particular time an exceptionally fine opening to persons desiring to embark in the jewelry business under such auspices. Correspond with John Pickrell, Trustee, State Bank Building, Richmond, Va.

## To Let.

**FOR RENT** in Virginia, town of 3,000 inhabitants. No. 1 store with fixtures; good stand; no other jewelry store in the place. Owner moved to city. Address 309 Main St., Danville, Va.

## Miscellaneous.

**I BUY JEWELRY STOCKS**—Manufacturers, jobbers and retailers desiring to dispose of surplus or entire stocks of diamonds, watches and jewelry can find quick cash buyer by addressing Stephen S. Harmon, 134 East 96th St., New York city.

**WANTED.**—A few more students to learn engraving at Trowbridge's School of Engraving, Winona, Minn. Lowest rates of any school. Board to be had for a low figure. New term starting.

## DEMAGNETIZING.

**PERFECT WORK**—Watch repairing in all its branches; all work warranted. Winslow & Penney, 608 Masonic Temple, Chicago.

**A COURSE** of engraving at Trowbridge's School of Engraving, Winona, Minn., is what you want. Write for terms which are the lowest of any engraving school. Board to be had for less than in large cities.

## If Your Sales Are Not Satisfactory

ADDRESS

**DE B. O. SCOTT,**  
20 Murray Street, New York.  
AUCTIONEER.

Specialties: Watches, Clocks, Bric-a-Brac, &c.

Write for particulars and references.

## Excellent For Window Display.



Size, 6x10 Inches.

Fac-Similes of the World's Historical Diamonds, Leather Cases, Velvet Lined, each Stone nan.ed. Price complete, \$10.00.

**Julius Eichenberg,**  
Precious and Imitation Stones,  
174 Weybosset St., Providence, R. I.

**WHITE AND JOBBING STONES.**  
—SPECIAL INDUCEMENTS TO MANUFACTURERS AND JOBBERS.—



**AMERICAN RAILWAY SUPPLY CO.**  
24 Park Place, NEW YORK.

**Jules Jürgensen**  
OF COPENHAGEN.

The reputation these watches have maintained for Fifty Years has never been equalled, being made on strictly scientific principles and no expense spared to give the **Best** results in mechanism and timekeeping qualities.

SOLE AGENTS,

**John C. Hyde's Sons,**  
NO. 22 MAIDEN LANE.

## Our Traveling Representatives



Traveling representatives may consider these columns open for the publication of any news or items of interest regarding themselves or their confreres.

**A.** A. SCHNEIDER, representing Hammel, Riglander & Co., New York, returned to Chicago the past week after a successful trip west. This much was learned at odd moments while he was busily engaged taking a large order from a Chicago material house. "Nothing like merit in one's goods," quoth he.

Kansas City, Mo., will be visited by the following traveling men this week: Matthias Stratton, Jr., Jno. W. Reddall & Co.; George L. Brenning, Dennison Mfg. Co., J. W. Pierce, for G. Armenty; G. T. Seal, Maltby, Henley & Co. and the Wm. Rogers Mfg. Co.; F. J. Fife, A. F. Towle & Son Co., S. H. Linton, F. M. Whiting & Co.

R. C. Pahr, representing Ezra F. Bowman & Co., Lancaster, Pa., is visiting western jobbers and manufacturers. Mr. Pahr will go as far west as Omaha, returning via St. Louis, Louisville, Cincinnati and Pittsburgh. He reports fair trade, though customers everywhere complain of business being later than it was last year.

On the Boston list of traveling men in town the past week were: Samuel L. Howland, Eisenmann Bros.; Mr. Weil, Springfels Mfg. Co.; G. W. Barney, Middletown Plate Co.; George B. Osborn, Wm. Smith & Co.; Mr. Jeanne, Wm. S. Hedges & Co.; J. L. Sweet, R. F. Simmons & Co.; S. O. Bigney, Marsh & Bigney; Oscar Stern, Hammel, Riglander & Co.; Wm. Cobb; W. H. Tarlton, Wightman & Hough Co. George Tallman, Irons & Russell, J. M. Fisher; Mr. Miller, Seth Thomas Clock Co.; Henry G. Thresher, Waite, Thresher Co.

Among traveling men in Philadelphia, Pa., the past week were: Steve Kent, W. H. Ball & Co.; Harry Scofield, Lincoln, Bacon & Co.; G. Crowell, Howard Sterling Co.; Thos. Rogers, Hayes Bros.; Rube Thompson for Henry Glorieux; I. Whiting, S. E. Fisher & Co.; G. Hayden, Hayden Mfg. Co.; Sumner Blackinton W. & S. Blackinton; D. Levy, Levy, Dreyfus & Co.; Harry Dougherty, E. Howard Watch & Clock Co.; Wm. Mount, T. Quayle & Co.; Wm. Frazier, Hancock, Becker & Co.; Chas. Duffy, Enos Richardson & Co.; Mr. Morrow, Columbus Watch Co.; and B. Griscom, Riker Bros.

Among the commercial angels who winged their way to Chicago last week were: L. Stern, Young & Stern; Mr. Wilkinson, W. S. Hough, Jr. & Co.; Walter Shute, Day & Clark; William Harris, Geo. O. Street &

Sons; Mr. Rogers, Parks Bros. & Rogers; Wm. H. Morris, J. W. Richardson & Co.; N. D. Prentiss, Alling & Co.; A. Barker Snow, Snow & Westcott; A. Kaufman, Bruhl Bros. & Co.; Matthias Stratton, Jr., John W. Reddall & Co., Mr. Gregory, Strobell & Crane; Wm. A. Wightman, R. F. Simmons & Co.; I. L. Lehweiss, Schlichting & Smith Co.; J. A. Granbery, Reeves & Sillocks; Mr. Dorchester, Brown & Dorchester; Wm. W. Middlebrook, B. A. Ballou & Co.; Mr. Oakley, Thornton Bros.; W. H. Tarlton, Wightman & Hough Co.; M. H. Landman, Salomon Davidson; E. M. Weinberg, Low, Weinberg & Hyman; W. T. Coombs, E. F. Sanford & Co.; Mr. Bashears, W. B. Kerr & Co.; Mr. Franklin, L. Tannenbaum & Co.; E. P. Hutton, Geoffroy & Co.; Charles White, Randel, Baremore & Billings; A. Marshuetz, Spencer Optical Mfg. Co.; J. C. Nicholson, Flint, Blood & Co.; M. L. Jacoby, Providence Stock Co.; E. L. Mumford, Waite, Thresher Co.; C. W. Battey, Waite, Mathewson & Co.; J. W. Capron; C. H. Oakes; J. J. Sullivan; John A. Fleming.

Traveling men in Pittsburgh, Pa., during the last two weeks were: Mr. Platt, Foster & Bailey; Mr. Rosenberger, A. Wallach & Co.; N. McDonough, Courvoisier-Wilcox Mfg. Co.; W. Trewin, Keystone Watch Case Co.; E. T. Hopkins, Meriden Silver Plate Co.; Gus Hoffman, Ansonia Clock Co.; Cliff Booth, Hutchison & Huestis, Harry Osborne, Whiting Mfg. Co.; Lou Smith, Bippart & Co.; Samuel Hyman, Lewisohn & Co.; Jos. Beach, Wilcox Silver Plate Co.; Tom Davis, Middletown Plate Co.; Mr. Barbour, Barbour Bros. Co.; Mr. Foster, Unger Bros.; W. H. Roe, E. Ingraham Co.; Louis Lassner, Goodfriend Bros. & Lassner; Geo. Nelson Fenn, for C. Sydney Smith; Frank F. Gibson, for William Kinscherf; Geo. W. Mindel, Dubois Watch Case Co.; Stephen Woods, Leroy W. Fairchild Co.; C. A. Cuppia, Ludwig, Redlich & Co.; C. B. Burgess, F. M. Whiting & Co.; Barker Snow, Snow & Westcott; G. A. Henkel for Frank H. La Pierre; E. P. Huthen, Geoffroy & Co.; Mr. Crane, Strobell & Crane; John H. Curran, Cox, Cooper, Ward & Young; William Harris, Geo. O. Street & Sons; C. J. Suplee, Belknap, Johnson & Powell; M. Stratton Jr., John W. Reddall & Co.; Sol. Sickles, M. Sickles & Sons; and Charles E. Dorr, Gorham Mfg. Co.

An unusually large number of traveling salesmen passed through Detroit last week, among them: R. L. Moorhead, R. L. Moorhead & Co.; Mr. Fowler, Fowler Bros.; Mr. Oakley, Thornton Bros.; Mr. Gladding, Gladding & Coombs Bros.; Mr. McDonough, Courvoisier, Wilcox Mfg. Co.; Fred Pettee, Waterbury Clock Co.; Mr. Cowell, Cowell & Hall Mfg. Co.; H. W. Dickerson, Jas. Seymour, Sons & Co.; George W. White, W. S. Hicks' Sons; N. D. Prentiss, Alling & Co.; W. H. Gregory, Strobell & Crane; Maurice Powers, Powers & Mayer; Mr. Metcalf, R. Blackinton & Co.; Mr. Rogers, Parks Bros. & Rogers; Mr. Kennion, H.

D. Merritt & Co.; Henry Freund, Max Freund & Co.; Mr. Cook, Bergstein & Son; P. E. Roth, C. F. Rump & Son; J. E. Simonsen, A. J. Hedges & Co.; D. F. Dickering, Bioren Bros.; Stephen Wood, Leroy W. Fairchild Co.; G. F. Kaiser, Enos Richardson & Co.; W. T. Gough, Carter, Sloan & Co.; Walter K. Shute, Day & Clark; G. W. Bleecker, Bassett Jewelry Co.; Mr. Hopkins, Meriden Silver Plate Co.; W. F. Corey, Corey & Osmun; Mr. Swift, Charles N. Swift Mfg. Co.; E. Todd Jr., Ed. Todd & Co.; George W. Mabie, Mabie, Todd & Bard; Mr. Winship, T. B. Clark & Co.; J. B. Osthoff, Joseph Noterman & Co.; H. A. Bliss, Krementz & Co.; Charles A. Hetzel, F. Grote & Co.; C. B. Burgess, F. M. Whiting & Co.; W. R. Bristol, C. Rogers & Bros.; Joseph W. Weiss, Henry E. Oppenheimer & Co.; Mr. Wilkinson, W. S. Hough, Jr. & Co.; and Sidney T. White.

### Pittsburgh.

The jury is out in the case of B. E. Arons against M. J. Smit in a jewelry suit.

M. Mark, Braddock Ave. and John St., has had his store closed by the sheriff the past week.

Fall cleaning and general overhauling are at present making marked improvement in the rooms of G. B. Barrett & Co.

Among the out-of-town buyers in the city last week were: L. C. Brehm, West Newton, Pa., and B. Neville, Dawson, Pa.

Fred W. Koehler, Sharon, Pa., was married Oct. 11 to Miss Carrie Rhodes, daughter of Charles D. Rhodes, Cincinnati, Ohio.

### Newark.

Carl F. Bawo, of Bawo & Dotter, New York, and wife, returned from their honeymoon trip to Europe on Friday on the *Fuerst Bismarck*.

Henry A. Bodestein, the peddler of spectacles and eyeglasses, who was knocked down and robbed of \$25 worth of glasses and cash last week, has caused the arrest of Michael Kearney, whom he identified as one of his assailants.

Frederick Ehmman, 281 Summer Ave., agent for W. H. Shipman, jeweler, of Maiden Lane, New York, was arrested on Friday charged with taking jewelry from his Newark customers to be repaired and not returning it. Twelve pawntickets have been found in his possession representing watches and jewelry to the value of \$300. Ehmman was bailed for \$500 by his brother.

Abraham Sickel, a well-known citizen, died at his home, 119 Market St., on Thursday, aged sixty-six years. Forty-six years ago Mr. Sickel came to America practically penniless. He commenced business in this city by peddling jewelry, which occupation he followed for many years. He invested his earnings in real estate and successful enterprises, and amassed a fortune of \$150,000.



The Latest Patents.

ISSUE OF OCTOBER 3, 1893.

**505,823. HOLDER FOR PENS, PINS, &c.** LOTHAR W. FABER, Port Richmond, N. Y. Filed

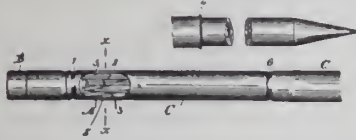

June 22, 1892. Serial No. 437,567. (No model.)

**505,835. WATCHMAKER'S PLIERS.** HENRY M. KULP, Philadelphia, Pa., and CHARLES H. LAIRD, Camden, N. J. Filed May 25, 1893. Serial No. 475,493. (No model.)

In a watchmaker's tool, the combination of handles

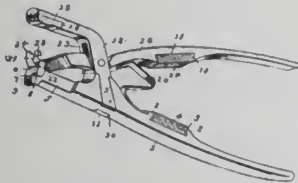

having jaws on the outer ends thereof, and a stationary elbow secured to one of the said handles and carrying a pad with which one of said jaws co-acts.

**506,010. WATCHMAKER'S STAKING-TOOL.** DAVID MENDELSON, New York, N. Y. Filed Dec 2, 1892. Serial No. 453,867. (No model.)

The combination with a punch and a guide or sleeve



for the punch, of a perforated base for supporting an article to be acted on by the punch and a jackscrew or clamp adapted to be inserted between the guide and base.

**506,012. OPERA-GLASS HOLDER.** JEREMIAH MURPHY, Chicago, Ill. Filed Apr. 24, 1893. Serial No. 471,572. (No model.)

An opera glass holder consisting of a tube, a handle secured to such tube by a yoke, a rotatable

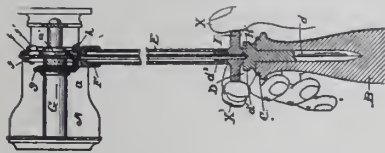

spindle extending through the tube, a thumb-wheel secured on the spindle at the lower end thereof and with in the yoke a beveled wheel secured on the upper end of the spindle, a beveled wheel intermeshing therewith secured on the rotatable sleeve of the opera glass and means for securing the holder to the opera glass.

**506,050. METHOD OF COATING CLOCK-CASES.** FLORENCE KROEBER, New York, N. Y.—Filed Feb. 15, 1893. Serial No. 462,414. (No specimens.)

The method of coating clock cases which consists in applying several coats of enamel-like material, heating

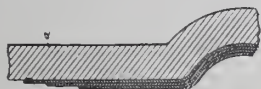

the article after each coat has been applied to a degree of temperature sufficient to render the coat viscid, and rubbing down each coat separately while in the viscid condition, whereby all roughnesses are removed and a thin even coating is left on the clock case.

**506,101. MUSICAL ATTACHMENT FOR CLOCKS.** EMILE L. CUENDET, Brooklyn, N. Y.—Filed Mar. 24, 1892. Serial No. 426,215. (No model.)

The combination with a clock having a striking mechanism of a music box mechanism, a bell crank lever between said music box mechanism and the strik-

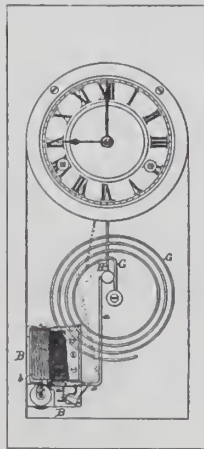

ing hammer, a detent upon the music box mechanism, a spring normally pressing said detent in contact with one arm of the bell crank lever and pressing the other arm in contact with the striking hammer whereby the hammer strikes said bell crank-lever and releases the detent to set the music box in operation.

**506,161. FRAME FOR EYEGLASSES OR SPECTACLES.** JOSEPH H. E. DE CELLES, Southbridge, Mass., assignor to Henry E. Kirstein, Rochester, N. Y.—Filed Dec. 24, 1892. Serial No. 456,216. (No model.)

In combination with a pair of lenses, a bridge spring consisting of the following elements, namely: a slide pin, yokes, mounted upon the respective extremities of

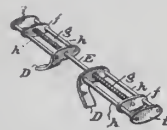

said slide pin, each yoke having a guide pin mounted in sliding engagement with it, springs mounted upon the respective extremities of the bridge and adapted to force the lenses toward each other, and a connection between each guide pin and the adjacent lens or lens frame.

**DESIGN 22,816. COIN OR MEDAL HOLDER.** THOMAS F. GAYNOR, Brooklyn, N. Y.—Filed



Mar. 24, 1893. Serial No. 497,517. Term of patent 14 years.

**DESIGN 22,818. BOX-COVER.** WILLIAM Q.

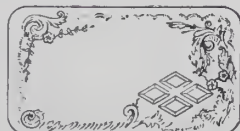

TOLMAN, New Bedford, Mass., assignor to the Pairpoint Manufacturing Company, same place.—Filed Jan. 18, 1893. Serial No. 458,839. Term of patent 7 years.

Queries By Circular Readers.

IMPORTS OF PRECIOUS AND IMITATION STONES.

NEW YORK, Oct. 11, 1893.

Editor of THE JEWELERS' CIRCULAR:

In to-day's CIRCULAR you give statistics of imports of diamonds and precious stones from January, 1893, to August 31, 1893. If convenient to you, please give us amount imported in each month from January 1, 1892, to August 31, 1892, and same months in 1893, separately. If you can comply with our request you greatly oblige,

Yours respectfully,  
KOCH, DREYFUS & Co.

As the answer to this communication may prove of interest to other dealers, besides the correspondents, we append the following table:

	1892	1893
January,	\$902,415	\$1,563,545
February,	908,035	1,294,126
March,	858,080	1,534,913
April,	910,404	1,270,925
May,	1,300,958	1,378,119
June,	1,436,811	1,016,047
July,	1,306,671	561,692
August,	1,979,968	347,200

The Death of George C. Shreve.

SAN FRANCISCO, Cal., Oct. 14.—News has been received from Mountain View, this State, of the sudden death yesterday of George C. Shreve of this city.

He had been in poor health for some months. He was the senior member of the firm of George C. Shreve & Co., the largest retail jewelry house on the Pacific coast.

St. Louis.

R. Haberman has thoroughly and beautifully remodeled his store at 602 Olive St.

A. S. Mermod, president of the Mermod & Jaccard Jewelry Co., has been elected president of the St. Louis County Sunday School Teachers' Association, and is working energetically to make the annual convention, Nov. 9th and 10th, a success.

It is said that Max Baehr, who distinguished himself by running off with \$1,300 worth of diamonds from his brother's store recently, will shortly open a jewelry store at 505 Franklin Ave., just three doors from his brother's old stand.

Traveling men in St. Louis last week included: I. Guntzburger, Max Freund & Co.; M. Rosenthal, Koch, Dreyfus & Co.; Zach Oppenheimer, H. Z. & H. Oppenheimer; Bert Sinauer, Oppenheimer Bros. & Veith; Nat Wolff, Wolff & Guntzburger.

Otto Baehr, who assigned recently, has offered to settle with his creditors at thirty-five cents on the dollar. He has issued a circular to them in which he states that he is only enabled to offer a thirty-five cent settlement by the aid of his relatives' money.

Charles D. Rood has come to the rescue of the Keating Wheel Co., Holyoke, which is financially embarrassed. He is to take a certain percentage of the capital stock, assume an active part in the management, endorse the company's notes, and furnish other financial backing.

**DIAMONDS.****Wm. S. Hedges & Co.,****Importers of Diamonds,**And Manufacturers of **DIAMOND JEWELRY.****170 Broadway, New York.**

27 Holdorn Viaduct, London.

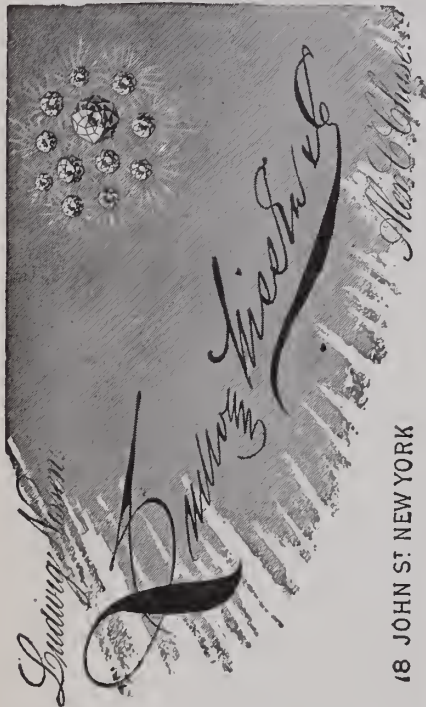
**R. A. KIPLING,**

Importer of

**PRECIOUS STONES,****21 & 23 Maiden Lane,****19, RUE DROUOT,  
PARIS.****New York.****Alfred H. Smith & Co.,****IMPORTERS****DIAMONDS**

AND

**PRECIOUS STONES,****182 BROADWAY, COR. JOHN STREET,****NEW YORK.**

33 Holborn Viaduct, London, E. C.

**CAMPBELL-METCALF SILVER CO.**170 Broadway, N. Y., Room 14. 66 Stewart St., Prov., R. I.  
Wally Bldg., San Francisco, 8th Floor, Room 1.Patent  
applied  
for.Victoria Novelties, many fancy shapes.  
Celluloid Top, Sides, Bottom and Cushions  
T. TROESCHER & CO., 69 Nassau St., N. Y.**LUDEKE & POWER,****IMPORTERS OF DIAMONDS**

AND OTHER PRECIOUS STONES,

ADOLPH LUDEKE.  
CHAS. L. POWER.**23 JOHN STREET, N. Y.****WOOD & HUGHES,  
STERLING SILVERWARE MANUFACTURERS**New York Agents for the Derby Silver Co.'s  
**FINE QUADRUPLE PLATED WARE,**  
NO. 16 JOHN STREET, NEW YORK  
206 Kearney St., San Francisco, Cal.  
HASKELL & MUEGGE, Agents.**WIGGERS & FROELICK,****60 NASSAU ST., NEW YORK.****Sample Cases and Trays  
For Watches, Jewelry, Optical Goods, Etc.****WE STRIVE TO MAKE THE BEST.****Trade Gossip.**

In prescription and special jobbing work on glasses Queen & Co., Philadelphia, Pa., claim to be unexcelled, their efforts being always toward accuracy and fine workmanship, two absolute essentials to the practical optician.

The Pairpoint Mfg. Co., New Bedford, Mass., have just issued a supplementary catalogue and price list which will be mailed on application. It contains about seventy-five handsomely illustrated pages and will be found interesting and instructive. A cover in dark green, handsomely embossed in gold, gives the book a most attractive appearance.

A Durgin spoon needs no commendation as to artistic excellence of the pattern or thoroughness of workmanship. The new "Cromwell" pattern just put on the market by W. B. Durgin, Concord, N. H., is among the best ever offered. The handsome illustrations which appear on another page, can at the best give but a faint idea of the beauty and finish of the originals. It will prove itself a good seller. Have you the "Cromwell" in your store?

A beautiful example of typography and engraving is the new Lore-Ley book of the Howard Sterling Co., Providence, R. I. It illustrates about thirty toilet articles in the artistic Lore-Ley pattern, comprising dressing and manicure sets, soap and powder boxes, jewel caskets, cigar cases, flasks, whisks, etc., etc. The book is further embellished with beautiful half tone engravings of the Lore-Ley and the history of *Lorelfelsen* on the Rhine, with the song of the Lore-Ley in the original German and in English. A price list accompanies the book, which will be sent on application.

It is naturally to be presumed that every jeweler is desirous of arranging the goods in his store to the best possible advantage, for attractive display is almost synonymous with increased business. Some systems of arrangement, it will be readily admitted, are superior to others. The "Fletcher Patent System of Trays," of the Fletcher Mfg. Co., 259 W. 27th St., New York, has many advantages over all others, and every jeweler should read the advertisement of this company on another page of this number of THE CIRCULAR, and make earnest inquiries regarding the matter therein set forth.

The great success which the fine pearl jewelry manufactured by Bippart & Co., Newark, N. J., and 19 Maiden Lane, New York, is now attaining, is in great part due to their new patent pearl fasteners for retaining whole pearls without clamps. By this device the pearls are held absolutely solid, so that there is not the slightest danger of their loosening or falling out. Jewelers fully appreciate what a great improvement this is particularly when applied to rings. The line of pearl, rococo wreathes, and sword and scabbard brooches which this firm are now introducing stands unsurpassed in workmanship and design.

### Fashions in Jewelry and Silverware.

A LADY'S RAMBLES AMONG THE JEWELERS.

The low epergnes in pierced work are lovely.

Milk jugs of glass set in perforated silver are a novelty.

Double wreaths of gold and pearls combine in brooches.

There are fascinating new card counters in perforated silver.

There is a fancy for enameled trinkets for bridesmaids' presents.

Enamel studs are desired. There is a prospect of fobs being called for by women.

There are charming fancies in silver candlesticks. A nymph holding up a flower is one.

Swords with black enamel mingling with stones are beautiful. The black gives relief to the stones.

Jewel boxes of perforated silver of the finest work have set in the tops like a dome, pincushions of the palest hued velvets.

Fancy spoons are made with handles of filigree in silver gilt. This is confined in an outside band dotted with colored enamels.

Since women have returned to parting their hair in the middle, the diamond star is a very prominent form of hair adornment.

Blue enamel divided sleeve buttons with a crumpled diamond shaped bit with a clover leaf in white enamel are delightfully feminine.

There are numerous pretty details made for the toilet table, of porcelain encased in perforated silver. The jugs for perfumery and lotions, and the boxes for pomades are very pretty.

A bracelet was seen for a silver wedding present. It was made up of two rows of diamonds set in silver. Between them were the words also in diamonds, "The Silver echo of a Golden King," which is very pretty, if one doesn't know what it means.

To the jewelers who provide their patrons with fans it may be said that everything is spangled. The painted fan unless it is a work of art is beneath a woman's consideration. The fan most chic is of black gauze with spangles of silver, or of iridescent hues.

Bonnet pins are a study. In the first place they must agree with the bonnet in tone; so it is necessary to have as many pins as bonnets. Some of the prettiest simulate flowers. Blue cornflowers have a tiny crystal among the stamens. The Neapolitan and wood violets have the same. Pink tipped daisies are charming, as are pea flowers in the natural tints. Pin heads set with crystal are effective. Moonstones set with tiny diamonds are desired for the black and white combinations now popular. When tints are used there are the many colored semi-precious stones among which some one is bound to harmonize.

ELSIE BEE.

ESTABLISHED 50 YEARS.

# RANDEL, BAREMORE & BILLINGS,

IMPORTERS OF

## DIAMONDS,

AND OTHER PRECIOUS STONES.

### FINE PEARLS A SPECIALTY.

MANUFACTURERS OF

## DIAMOND JEWELRY,

IN THE LATEST DESIGNS.

Diamonds Recut in Modern Styles or Repaired on Premises.

58 Nassau Street,  
29 Maiden Lane  
NEW YORK.

1 Tulp Straat,  
AMSTERDAM.

1 St. Andrews St.,  
Holborn Circus,  
LONDON, E. C.



TRADE MARK.

ESTABLISHED 1841.

## CARTER, SLOAN & CO.,

### MANUFACTURERS OF GOLD JEWELRY,

No 15 MAIDEN LANE,

NEW YORK.

A. CARTER, JR.  
A. K. SLOAN.  
C. E. HASTINGS.

GEO. R. HOWE.  
WM. T. CARTER.  
WM. T. GOUGH.

FACTORY, NEWARK, N. J.



## JOHN N. DISSELKOEN,

Cutter and Importer of

# DIAMONDS

FACTORY.  
76 LANGBLEEKERSPAD,  
AMSTERDAM.

19 East 16th St.,  
NEW YORK.

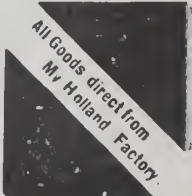

## SUGGESTIONS FOR WINDOW AND STORE DECORATION.

Members of the trade who think they have an attractive window are invited to send us a photograph, or a pen and ink or pencil sketch of the same, which will be published if we consider the window contains any originality or lesson.

### IDEAS L AND LI.

#### WINDOW DESIGN CONTEST, NO. 2.

A Prize of \$10.00 is offered by THE JEWELERS' CIRCULAR for the best design for dressing a jeweler's window. The contest is open to all members of the trade, to the clerks, salesmen and others, as well as to the dealers. Following are the conditions:

1. The design is to be submitted as a pencil or other sketch or photograph, from which a finished engraving may be made. The design may be an original conception or a copy of a window already dressed.
2. A brief description is to accompany the design.
3. The design must be appropriate for the Fall and holiday season.
4. Designs for Contest No. 2 must reach us no later than Nov. 1.

THE Window Design Contest No. 1, conditions regarding which are given above has elicited many suggestions, but we must say that none contain any marked ingenuity or beauty. Such as are practicable and appear to possess some elements

names of the prize winner will be announced at the close of the publication of the designs.

The design offered by L. E. Thomas, Wilmington, Del., is conceived for the purpose of making a small quantity of goods appear to be of much greater extent and, at the same time to produce an attractive effect. He claims that eight people out of ten would examine the window for ten minutes before they would discover that the window was double, and that they were gazing into looking glass. On the top edge of the mirror at the back lies blue plush in folds. Around the edge of the bottom mirror green plush lies in folds. Over the top of the mirror at the back of the window, is a crescent device spelling the word "Watches," timepieces being arranged in the letters. This design was embodied in the window of Harry E. Thomas & Co., Wilmington, Del.

The other design illustrated was recently employed in the window of George W. Ludwig, Chambersburg, Pa. The bottom of

window about 2½ inches. The border was made of boxes about 5 inches high and 4 inches wide. The window floor was covered with white cloth to show distinctly the "93" and the border. Watches, silver novelties and other Fall and holiday goods may be displayed in such a design.

#### PHILADELPHIA JEWELERS' WINDOWS DURING A PARADE.

The business men of Frankford Ave., Philadelphia, Pa., had their annual trade display a few days ago and as usual the

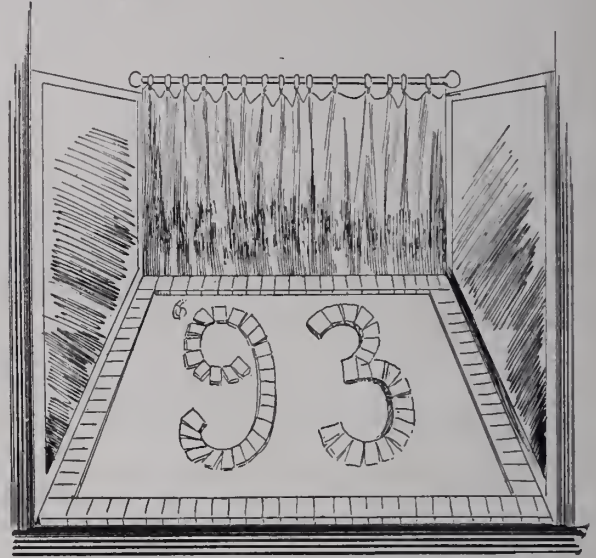

DESIGN OFFERED BY D. M. R.

jewelers' decorations were both beautiful and elaborate. Among the jewelers who had especially attractive features were the following:

A. L. Millard's store, No. 2622, was a mass of United States flags. The awning poles were strung with Chinese lanterns and enveloped in red, white and blue bunting. In the street parade Mr. Millard had a wonderful pyramid of clocks.

Taggart & Nicholas' store, No. 2606, had the window framed with red, white and blue bunting, a choice display of silverware being set off by potted plants and strings of artificial flowers.

Duckett Harman, No. 2219, had a splendid arrangement of jewelry, enhanced by a neat and tasteful exhibition of potted plants and flowers upon a miniature stage in the rear of the store, with a curtain formed of draped American flags. The front of the store and dwelling was lighted by incandescent lamps and numerous lanterns, while flags and streamers hung from every point.

I. A. Presper, No. 2307, made a creditable display of his goods. Artistically arranged lattice work, interwoven with ivy and smilax, formed a background, while electric lights heightened the effect. One of the windows contained a large and beautiful picture of the armored cruiser, *New York*, which was made for the Messrs. Cramp and loaned to Mr. Presper for the occasion. The interior of the store was arranged with palms, ferns and electric lights.



L. E. THOMAS' DESIGN.

of originality will be depicted on this page. Two designs are given herewith, and others will appear in following numbers. The

the window slants slightly. Mirrors are at the sides and a curtain at the back. The device "93" was raised from the bottom of

**Tool for Planting the Cylinder.**

IT IS a long time, says L. Choisy, in *L'Union Horlogère de France* since I made this little tool, as long ago as 1875, when I served my time with an old knight of the pivot, who stood most certainly at the height of his profession as watch repairer. It is not necessary that I should explain its contraction, as this will speak for itself, but simply the manner of its use.

After having freed the plate of all the bridges and movables other than those of the escape wheel, which remain in place, it is fastened in the copper bracket A by

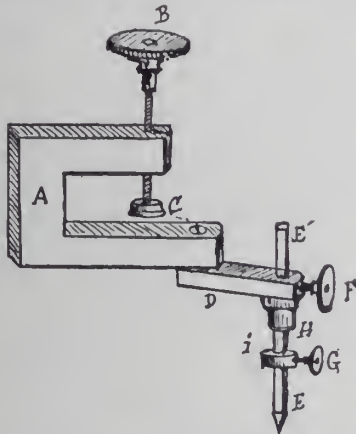

means of the washer C, which is screwed down by turning the milled button B; then, by aid of the joint D, the smooth face E<sup>1</sup> of the runner E, which is movable in the socket H, is moved to the place of the end stone of the chariot which has been unscrewed from the plate. The face E<sup>1</sup>, therefore, serves as endstone. The upper face of the sliding piece *i* is then placed against the lower face of the socket H, and secured in place by tightening the screw G.

The runner E is then raised, the chariot which is taken from its place is unscrewed and the runner E put in as substitute. It is sufficient next to shorten the staff of the lower cylinder fly to the required height; it is placed in position with the cylinder's escape wheel by resting it upon the face E<sup>1</sup>, of the runner which serves as endstone, entirely in the same manner as if the chariot were in place. The other measures are taken in the ordinary manner with the douzième gauge.

This tool will be found to be of immense assistance when repairing a flat watch, where the least incorrectness of the passage causes the watch to stop; the repairer will find that it repays him for his trouble and after a short time he would not know how to get along without it.

**Frosting Wheels.**

FROSTED wheels, when nicely and well done, are very pretty; but where one perfectly satisfactory finish of this kind is accomplished, there will be a dozen failures—that is, to a greater or lesser extent. A beautiful frosting can be made by dissolving clear white resin in alcohol. The solution does not need to be thick; the thin-

ner the solution is the finer the grain or finish produced will be. Take two wide-mouthed bottles, holding about two ounces each, and fill one about half full of resin broken into dust and small pieces; then fill the bottle with 95 per cent. alcohol and leave it stand, with an occasional shaking, for two or three days; after this pour the fluid portion into the empty bottle and fill up with alcohol.

When we wish to frost a wheel, put a piece of sharpened pegwood into the center hole, to hold it by; dip the wheel into the solution of resin and alcohol, and set it on a riveting stake to dry, letting the point go into one of the holes so that the wheel will lie flat and quiet, until dry. The wheel is then to be dipped into dilute nitric acid, prepared by mixing fifty drops of acid with one ounce of water. The wheel is allowed to remain in about two minutes, when it is removed and well washed with water. After this the resin is dissolved off with turpentine and well washed in soap and water. If the first etching is not satisfactory repeat the resin coat, dipping in acid, and the frosting will be found very even and a little coarser than the grain made by grinding.

By rubbing the wheel on a bit of flat cork with oilstone dust and benzine the dark coat produced by the acid is removed, and the surface has a beautiful steel grey appearance. A mixture of one-quarter of an ounce of alum and one-quarter of an ounce of corrosive sublimate in half a pint of water, makes a good acid solution into which to dip the wheel after the resin coat has been applied. It is to be understood that the process of frosting by acid is not to be attempted until the wheel is ground smooth and flat, and free from any deep scratches. The solution of alum and sublimate acts much quicker than the dilute nitric acid; a few seconds suffice.

**VICTOR.** ☉ ☉  
SIMPLEST FEED. ALWAYS THE SAME.  
GUARANTEED FOR ONE YEAR.

**THE VICTOR FOUNTAIN PEN**  
(Pat. Feb. 4, 1890.)

**THE BOSTON PEN CO.,**  
N. C. Whitaker & Co., Proprietors.  
363 Washington Street, - Boston, Mass.,  
Manufacturers of finest quality

TORTOISE : SHELL : AND : HORN : GOODS  
in every variety. Also Aluminum Hair Pins.  
Send for illustrated Pen Price List No. 1.

**J. H. DEDERICK, JR.,**  
— DEALER IN —  
**Roll Plate Jewelry and Chains,**  
Optical Goods and Jewelers' Supplies,  
**16 MAIDEN LANE, NEW YORK.**  
FINE GOODS & SPECIALTY

ESTABLISHED 1870.

**J. L. CLARK,**  
**SWEEP SMELTER AND REFINER OF GOLD AND SILVER.**  
Buys every kind of Gold and Silverware, Jewelry, Watches and Platinum. Full market value paid.

**No. 724 Filbert Street, Philadelphia, Pa.**  
SEND BY EXPRESS or Registered Mail. If my price is not satisfactory, I will return all articles.

**THE BEST PIVOT DRILLS IN THE WORLD.**

One Gross without charge for proof that this is not so.

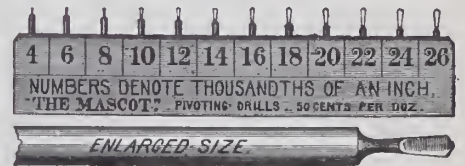

**The Mascot, 50 Cents per doz.**

By all Jobbers, or sent post-paid on receipt of price.

**Ezra F. Bowman & Co.,**  
**LANCASTER, PA.**

**Waltham Horological School,**

**PALMER & SWAIN, Props.,**  
**WALTHAM, MASS.**

**Summary of Prospectus.**

**LOCATED** in Martyn Square, in the city of Waltham, Mass. Pleasant location, hotels, boarding houses, churches, etc.

**CURRICULUM:**—Pupils are taught watch making, repairing and bench tool making complete. American and foreign systems. Special branches taught when desired.

**BRANCHES TAUGHT** include work on plates, barrels, wheels, pinions, jewels, balances, staffs, springs, screws, stem-winding parts, matching, gilding, finishing, adjusting, repairing, tool work, engraving, etc., etc. Also a thorough course in Ophthalmology by a professor of universal reputation and a course in gem cutting if desired.

**COURSE** may begin at any time and pupils are taught to make everything that enters into a watch movement. When the student has finished his course he is able to make and put together a watch complete in all its parts and properly adjusted; he is also a first-class repairer and gets such a thorough instruction in his trade as cannot be obtained in any workshop or any other school in the United States. The workshop of this School is fitted up with thousands of dollars' worth of the best watch tools and machinery, and with the capable instructors always ready to give their attention to the individual student, there being no class system, he has an advantage not to be obtained elsewhere. Materials for a watch movement will be given free to students who desire to make a watch of their own.

Send for full prospectus, terms for special branches, etc.

D. D. PALMER. EUGENE H. SWAIN.

**A. J. LOGAN,**  
MANUFACTURER OF  
**WATCH TOOLS, HAIR SPRINGS AND WATCH MATERIALS.**

◁ New Catalogue just issued, Sent on Application. ▷  
**WALTHAM, MASS.**

# Grand STREET Exhibition!

To the Jewelers . . . . .

Below you will find detail  
and to which we add con-

of the lines which we carry  
stantly the latest novelties.



**France**==BRONZES, CLOCKS OF ALL DESCRIPTIONS, SEVRES VASES, LAMPS, PORCELAINS, FINE FURNITURE.

**Germany**==ROYAL BERLIN, ROYAL BONN, NURNBERG MAJOLICA, DRESDEN VASES, DRESDEN LAMPS IN ENDLESS VARIETY, DRESDEN FURNITURE, IVORIES.

**Austria**==DECORATED GLASS, OLD VIENNA WARE, TEPLITZ GOODS, FAYENCE STATUARY, BRONZES.

**Italy**==SUPERB LINE OF CARRARA AND CASTELLINA MARBLES, NOVE AND BASSANO FAYENCE, CARVED FURNITURE.

**England**==ROYAL WORCESTER, COALPORT, TULIP GLASS, ENGLISH CHIMING HALL CLOCKS.

## Ferdinand Bing & Co.,

74 Rue d'Hauteville,  
PARIS.

106 Grand Street,  
NEW YORK.



### Remarkable Doulton Vases.

NO. 1.

IN a former article under this department treating of the World's Columbian Exposition exhibit of the Doulton Potteries, reference was made to several large pieces, each one of which presents some points of interest, and which together form a feature that has immediately arrested the attention of visitors to the Fair. It is our purpose to give fuller descriptions of these pieces and to present fine engravings of the same, so that the reader will acquire a more thorough appreciation, if need be, of the great artistic achievements of one of the foremost potteries in the world.

The tall Doulton ware ewer, 6 feet high, illustrated here, is a magnificent piece, quite novel in design and treatment, and, so far as is known, is the largest ornamental piece ever made in stoneware. It is slender in proportion, and generally light in color, except for a strong band of bluish green at the base and touches of dark blues and browns in the ornament. The necessary contrast is obtained as much in the modeling as in the color. Round the shoulder is a vigorously modeled band of ornamental scrolls springing from horses' heads. This is perforated, and forms a kind of gallery; perforated bosses set in the ornament, and the crisp modeling of the upper part and handle all supply valuable touches of dark and light. Portions of the modeling are left uncolored, and show the light brown semi-glazed surface characteristic of Lambeth stoneware. The piece was designed and worked almost entirely by Mark V. Marshall.

Silver gilt pitchers perfectly plain and lustreless, except for enamel bands at the mouth, are among the latest of novelties in enamel.

### Teacup Superstitions.

HERE are a few old superstitions regarding the ever friendly cup that cheers. If, while the tea is being made, the

some one will "drop in to tea." If a single person happens to have two spoons in his or her saucer it is a prediction that the fortunate (or unfortunate?) drinker of that particular cup will be married within a year

from that date. If you put cream into your cup before the sugar it will "cross your love," so be very careful. If a tea stalk floats in the cup it is called a "beau," and when this is seen unmarried women should stir their tea very quickly round and round, and then hold the spoon upright in the center of the cup. If the "beau" is attracted to the spoon and clings to it he will be sure to call very shortly if not that same evening; but if the stalk goes to the side of the cup he will not come.

If you want to know how many years will elapse before you may expect to be married, balance your spoon on the edge of your cup, first noting that it is perfectly dry, fill another spoon partly with tea, and holding it above the balanced spoon, let the drops of the tea gather to the tip of the spoon and gently fall into the bowl of the one below. Count the drops required to overbalance it—each one stands for a year. It is a sign of fair weather if the cluster of small air bubbles formed by the sugar collect and remain in the center of the cup. If they rush to the sides, it will surely rain before night. When toast is made, three or four thin slices of bread must be cut the whole length of the loaf, and placed one over the other. This done, they must all be cut in half by one sweep of the knife. If this is done by a young woman and the slices are not severed clean through to the plate, she will not be married within the year; if the bread parts in two even heaps, she might as well order her trousseau. On no account must she take the last piece of toast or



DOULTON WARE EWER, AT THE WORLD'S COLUMBIAN EXPOSITION.

lid, which has been removed to pour in the water, is forgotten, it is a sure sign that

bread on the plate, unless she wishes to be an old maid.

## The Connoisseur.

(Continued from page 47.)

### The Rambler's Notes.

WHAT THE RAMBLER SAW AND HEARD AMONG THE DEALERS IN ART POTTERY, CUT GLASS, BRONZES, ETC.

#### THE "ROCAILLE" LIMOGES CHINA.

IN the new lines of M. Redon's French china shown by Chas. Ahrenfeldt & Son, 52 Murray St., New York, sole American agents for this ware, the prevailing shape is now the New "Rocaille" which has been so greatly admired at the World's Columbian Exposition. A complete assortment in this shape, of all novelties handled by jewelers such as plates, comports, powder boxes, individual sugars and creams and cups and saucers, jewel boxes and trays, pin trays, fruit trays, bon bon boxes and trays, ice cream, chocolate, five o'clock tea, and tête-à-tête sets, etc., are shown in the ribbon or bow-knot, forget-me-not, violet and many other new floral decorations. Some new decorations are also shown on the novelties in the former "Columbian" shape which attained such popularity last year. The new bonbonnières in the "Rocaille" heart shape, decorated with Watteau panels, are among the prettiest novelties on the market.

#### SWAN-SHAPED PORCELAIN GOODS

One of the latest novelties in pottery shown by Hinrichs & Co., 31 Park Place, New York, is a line of swan-shaped flower holders, in Thuringia, Saxon and English china, and white bisque. As table center-pieces they are so beautiful that the craze for swan shapes has even extended to peppers and salts, mustard boats and other smaller pieces which are shown by Hinrichs & Co. in great variety. The Thuringia flower holders are in beautiful tints of green, pink, blue and orange, while the Saxon pieces are decorated *à la Meissen*. All the pieces are in a great variety of sizes.

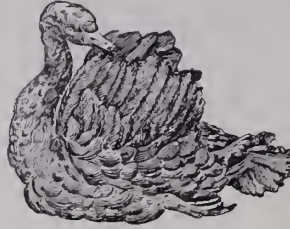

#### A BEAUTIFUL AND SALABLE LINE.

The demand for the Porcelene Pompadour clocks, introduced by the F. Kroeber Clock Co., 360 Broadway, New York, continually increases, especially since the handsome catalogue, containing ninety beautifully colored illustrations of the various styles of these clocks, has been issued to the trade. The new designs now upon the market show many exquisite styles in rich, mellow tints, having gold or silver ornamentation blending harmoniously.

The colors, blue, red, pink and green, are of the same shade as those of the finest porcelain. These clocks are of enameled iron, and so perfect is the lustre and finish that it is difficult to distinguish them from real porcelain. The patent covering this process of enameling has just been granted to the F. Kroeber Clock Co., as may be seen in the Latest Patents of this issue.

#### SMALL WARES IN WEDGWOOD.

Maddock & Co., 21 Park Place, New York, have imported a special stock of vases and small pieces in Wedgwood Jasper ware for the holiday trade. Though belonging to the less expensive lines, these pieces are exceedingly handsome and are shown in an extensive variety. Among the most popular of the smaller novelties in this ware which have been lately introduced are the Imperial peppers and salts, illustrated herewith, mustard pots, puff boxes, bonbonnières and shaving mugs.



#### BAWO & DOTTER'S AUSTRIAN GLASS.

A magnificent assortment of Austrian jewel glass is to be seen at the show rooms of Bawo & Dotter, 30 Barclay St., New York. Pin trays, fruit trays, bon bon trays and boxes, liqueur sets,

# NOTICE TO JEWELERS!

WE ARE NOW PREPARED TO SHOW YOU THE MOST EXQUISITE  
= LINE OF =

## M. REDON'S FRENCH CHINA,

WHICH HAS GAINED A WORLD WIDE REPUTATION FOR EXCELLENCE OF MANUFACTURE AND NEATNESS AND BEAUTY OF SHAPE AND DECORATION; A FULL AND COMPLETE LINE SHOULD BE CARRIED BY EVERY JEWELER.

## CHAS. AHRENFELDT & SON,

50, 52 & 54 MURRAY STREET,

NEW YORK.

AGENTS FOR THE UNITED STATES AND CANADA.



# ANNOUNCEMENT



**FALL, 1893.**

OUR Importations for the coming season are now arriving and we have on exhibition at our ware-rooms a complete assortment of exclusive

## Novelties and Specialties

SELECTED FOR THE JEWELRY TRADE.

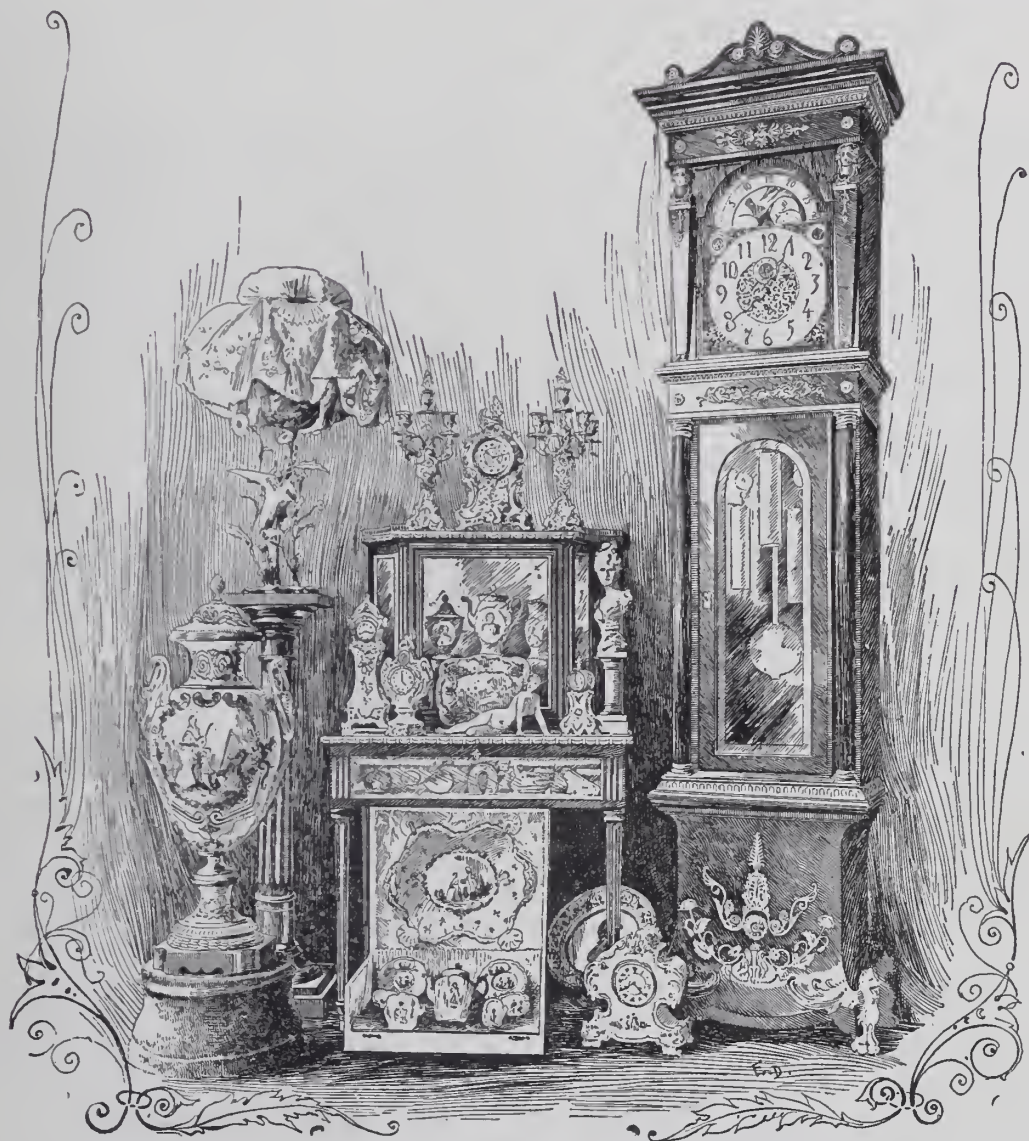

SPECIMENS OF FALL GOODS FROM THE STOCK OF LEON J. GLAENZER & CO.

Clocks, Bronzes, Sevres Vases, Fine Decorated Porcelains, Cups and Saucers, Tea Sets, Lamps and gilt and silver plated filigree Photo Frames in endless variety

# LEON J. GLAENZER & CO.,

35 Boulevard de Strassburg, Paris.

80 & 82 CHAMBERS ST., N. Y.

ice glasses, tumblers in cases, and cups and saucers are among the specialties of this firm, in which the variety of beautiful new shapes and artistic decorations is unprecedented. This and their latest line of Dresden novelties with Vienna decorations, cannot fail to be of particular interest to the jewelry trade.

THE RAMBLER.

There seems to be a return to hammered and oxidized silver. Some of the most artistic pieces seen this Fall have been of this sort. Especially conspicuous in these is the influence of Japanese design. This is in

its nature floral. A candlestick, for example, has a base of lily leaves and pods; the stem carried upward supports a flower-like receptacle in which the candle rests. A lovely vase expands like a deep tubed convolvulus.

### Spanish Glass.

THE first mention of glassworks in Spain is found in Pliny, and the next allusion to this industry is in the works of San Isidore, who lived in the seventh century. Glass was made to a great extent in the Spanish Peninsula during the Roman

period. The manufacture had ceased to exist in the seventh century. There are no specimens of Spanish glass of the Visigothic period, but from the eighth to the fifteenth century it is inferred that the industry of glass making became as important in Spain as that of pottery.

No specimens of the earlier period, however, have reached our time, and we must judge of what it was from the glass vessels belonging to the Renaissance period, which preserve their Oriental form and are of a different style to that of Venice and other localities in Europe.

## Art Corners in Geo. Borgfeldt & Co.'s Establishment.



ART ROOM NO. 1.



ART ROOM NO. 2.



ART ROOM NO. 3.



ART ROOM NO. 4.

# GEO. BORGFELDT & CO.,

18-22 Washington Place, New York.

# To Jewelers and Art Dealers:

OUR THIRD FLOOR, 100x100 FEET IS  
DEVOTED EXPRESSLY TO

Bric-a-Brac, Artistic Novelties and the Richest Productions in Art Pottery, Onyx Clocks and Pedestals, Marble Statuary, Carved Wood Furniture, Verni Martin Cabinets, Banquet Lamps in Onyx and Dresden China, etc., etc.

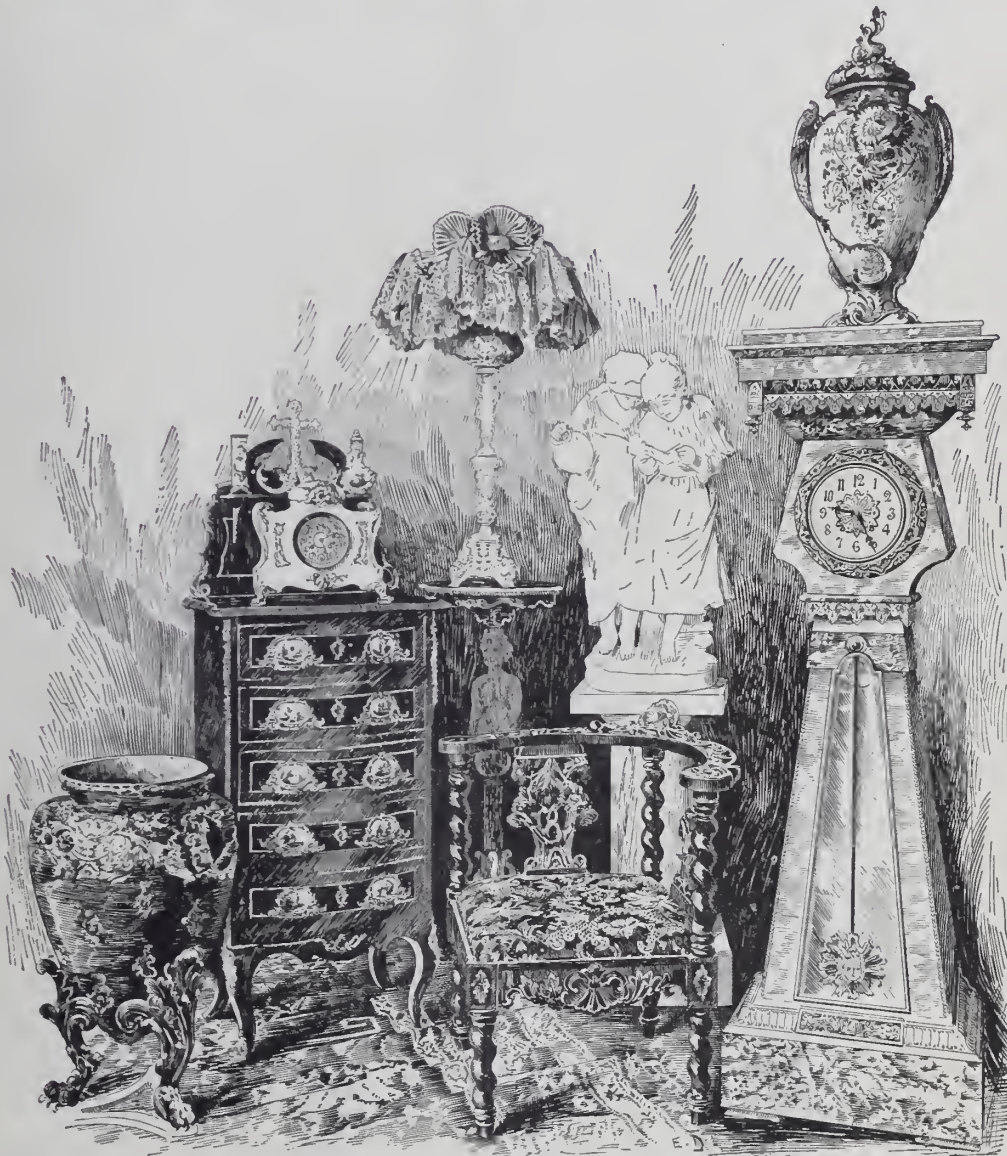

WE ARE NOW DISPOSING OF OUR SEASON'S SAMPLES AT INVOICE PRICES, PREPARATORY TO THE ARRIVAL OF OUR NEW LINES FOR 1894, THUS AFFORDING AN EXCELLENT CHANCE FOR BUYERS TO OBTAIN AT SMALL OUTLAY, A BEAUTIFUL ASSORTMENT OF CHOICE GOODS.

Very Respectfully,

**GEO. BORGFELDT & CO.,**

**18, 20 & 22 WASHINGTON PLACE, NEW YORK.**

The Other Side of Life.

THE DYSPEPTIC CAT AND THE WOODEN CUCKOO.

No. 1.

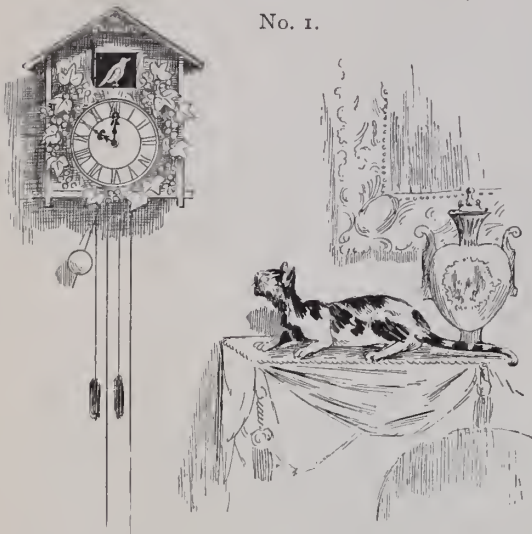

THE CAT—"I've waited for that chippy to appear for an hour. Now's my chance."

THERE WOULD BE OPPOSITION.

GAZZAM: If the vote for a national flower were to be taken now, the golden rod would not be unanimously chosen.

MADDOX: Why not?

GAZZAM: The silver States would oppose it.—Vogue.

AN HOUR GLASS — My Lady's Mirror.—  
World's Fair Puck.

ON THE EAST SIDE.

COUSIN BARNES: What d'ye call this party, a function or a swarry?

COUSIN BESS—Neither, cousin. Do you see Mr. Einstein over there, watching the ladies with diamonds? Well, this is his loan exhibition.

—Vogue.

No. 2.



THE CAT—"Ah! Ah! now I've got him!"

NEEDS WINDING.

TAGLEIGH—My stomach is as good as a watch. It always tells me when it is dinner-time.

WAGLEIGH—My stomach is like a watch, too; but it doesn't announce dinner.

TAGLEIGH—How's that?

WAGLEIGH—It's all run down.—Puck.

NOT IN IT.

He feels very blue and forlorn,

In his pocket is nary a note;

His watch and his gems are in pawn,

For he bet on the losing boat. —Ex.

No. 3.



THE CAT—"Gee whiz! How that bird does lay on my chest! After all, birds never did agree with me."

HEADQUARTERS FOR CUCKOO CLOCKS.

From

\$5.50 Up.



Brass

Movements.

THE F. KROEBER CLOCK CO.,

360 BROADWAY,

Branch: Broadway Cor. 17th Street.

NEW YORK.

# Craighead & Wilcox,

NO. 33 BARCLAY STREET, }  
NO. 38 PARK PLACE, }

NEW YORK CITY.

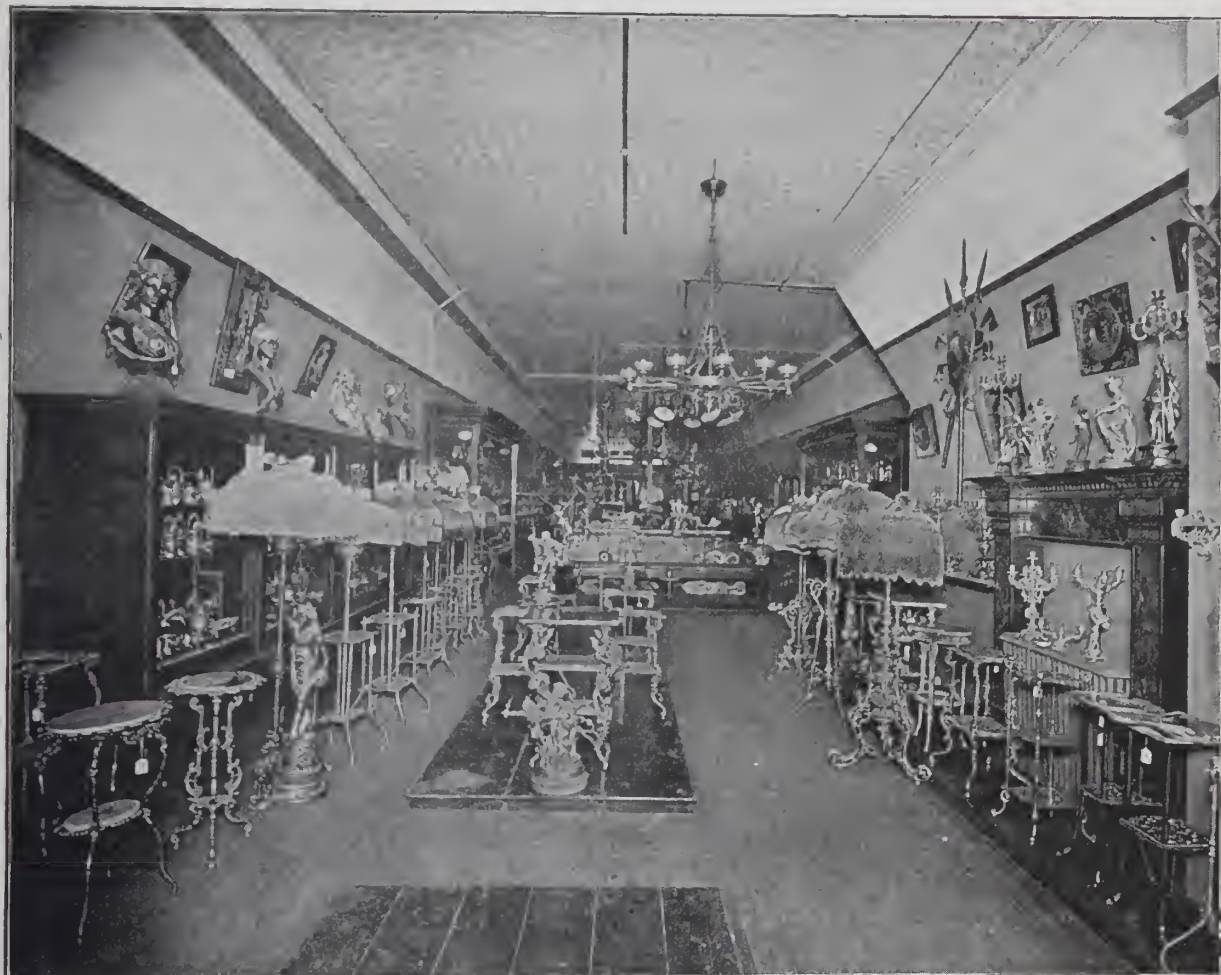

## REPRESENTING

CRAIGHEAD & KINTZ CO., Makers of Lamps and Metal Fancy Goods.

WALTER S. BERG, Maker of Silk Lamp Shades.

HARTFORD SILVER CO., Makers of Silver Plated Goods.

ALFRED HACHE & CO., Successors to HACHE, JULLIEN & CO.,

Vierzon, France, Makers of French China.

---

THE COMPLETE NEW LINES ARE NOW ON EXHIBITION AT OUR SALESROOM



ESTABLISHED 1801.

# HINRICHS & CO.,

29 &amp; 31 PARK PLACE,

Cor. Church Street,

NEW YORK.

**Art Pottery and Bric-a-Brac,**  
CUT GLASS, FANCY GLASS, CHINA.

Large Assortment of

Fine Dresden China Lamps, Glass and  
other Fancy Lamps.

THE LARGEST ASSORTMENT OF SPECIALTIES FOR THE JEWELRY TRADE, AT LOWEST PRICES.  
CATALOGUE ON APPLICATION.

## FRENCH CHINA SPECIALTIES FOR JEWELERS.

BRUSH & COMB TRAYS,  
CARD TRAYS,  
MANICURE TRAYS,  
PEN TRAYS,

PHOTOGRAPH FRAMES,  
FRUIT PLATES,  
ODD CUPS AND  
SAUCERS, ETC.

◁ SEND \* ORDER \* FOR \* SAMPLE \* ASSORTMENT. ▷

## F. W. BUNING & CO.,

58 MURRAY STREET,

NEW YORK.

### Rich Cut Glass

AND

DECORATED ART WARES.



Mt. Washington Glass Co.,

New Bedford, Mass.

RICH DISPLAY OF GOODS AT

New York Store: 46 Murray St.

When you visit Chicago do not  
fail to inspect our full line of goods  
at the new store of Pairpoint Mfg.  
Co., 224 Wabash Avenue.



GLASS CUTTER AT WORK.

### Immense Crystals.

IF somebody should find a diamond as big as a foot-ball, says the *Youth's Companion* his discovery would hardly be more unexpected than one which has recently been made in Utah, relating to a kind of crystals, however, far less precious than diamonds. The discovery referred to is that of a deposit of selenium found near the Fremont River in a mound-like elevation formed by the washing and wearing away of the clay and sand surrounding it.

Selenide crystals are formed from the rare element selenium, which is related to sulphur, and was discovered in 1817 in the refuse of a sulphuric acid factory by the celebrated chemist, Berzelius. In its vitrious form selenium is sometimes employed for optical purposes. Many years ago little medallion portraits of Berzelius were occasionally to be seen, cast in this substance which he had discovered.

Selenium has been found in small quantities in native deposits, notably at Culebras in Mexico. But hitherto, the selenide crystals obtainable have been small, being "measured by inches and weighed by ounces." Now, however, they have been obtained in the Utah deposit weighing as much as a thousand pounds!

Many tons of these crystals have been taken from the mound. Some of them are four and even five feet in length, with faces six inches broad. One huge crystal had nineteen small ones projecting out of it. As far as known this unique deposit has no rival in the world.

### The Fakir's Diamonds.

THERE was a new face among the fakirs on the water front yesterday morning—the face of a man who made diamonds, rubies and other brilliants out of old bottles, says the *San Francisco Examiner*. The color of the bottles seemed to be the factor that determined the nature of the stone. The implements were a small hammer, a little polishing wheel, and a couple of boxes that contained a powder. The fakir had a radiant portable stand somewhat larger than the contrivance that a scissors grinder carries, and at that he did a thriving business.

Through the crowd an old man pushed his way. "Here's a bottle!" he exclaimed. "Break that up into rubies for me."

"No rubies in that," replied the fakir. "It's a diamond bottle."

"Diamonds, then!" shouted the old man. "Break it anyhow! I've carried that same bottle for twenty years back, an' many's the diamond an' ruby it's cost me. Break it up and keep the diamonds for your trouble."

A colored man was bragging about his horse. "Why, bless you, man," he said, "dat ar hoss kin kick yo collar button off widout eber tichin' yo neck!"—*The Youth's Companion*.

# BAWO & DOTTER,

Manufacturers, Importers and Commission Merchants.

## ARTISTIC POTTERY

..... AND .....

### Novelties for the Jewelry Trade.



#### ETAGERES



In various sizes and designs. For placing of choice bits of Bric a Brac, they have the merit of being ornamental as well as useful.

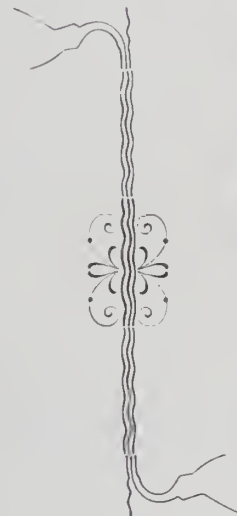
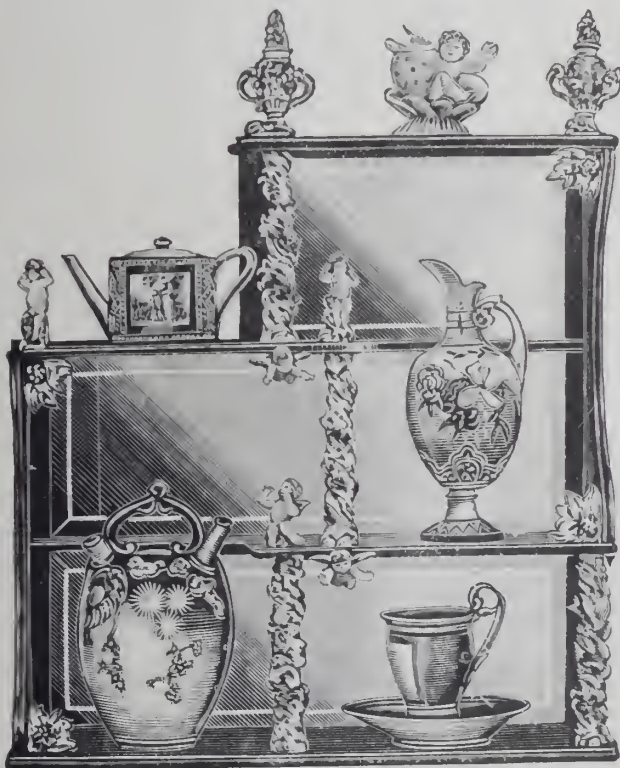

#### DRESDEN LAMPS.



In assorted decorations, including Old Saxon, Berlin, Saxon Cobalt, Pink, Sevres, Green, etc., etc.

IN **DRESDEN CLOCKS** WE SHOW A LARGE VARIETY OF DESIGNS.

A FULL LINE OF

Royal Worcester, Doulton, Wedgwood, Crown Derby, Royal Bonn, Teplitz, Leeds. Jardinieres, Etc., Etc.

Never before have we been better prepared to meet the growing demands of Jewelers for Artistic Novelties in Pottery than at the present season. All tastes can be satisfied.

NEW YORK.

WAREROOMS AND OFFICE:

28, 30 & 32 BARCLAY STREET,  
P. O. BOX, 1872,

FACTORIES:

LIMOGES,	-	-	-	FRANCE.
STEINSCHOENAU,	-	-	-	BOHEMIA.
CARLSBAD,	-	-	-	BOHEMIA.

87 NASSAU ST., (Fulton Building), NEW YORK.  
Importers of DIAMONDS,  
WOLFF & GUNZBURGER, Importers of DIAMONDS, Cor. Maiden Lane, NEW YORK.

L. & M. KAHN & CO., Importers of DIAMONDS, 172 Broadway, NEW YORK.

SAPPHIRES.

M. D. ROTHSCHILD,  
NEW YORK: 41 & 43 MAIDEN LANE  
LONDON: 15 HOLBORN VIADUCT  
PARIS: 58 RUE LAFFITTE.

S. P. HOWARD,  
Gold and Silver Assayer.  
Refiner and Sweep Smelter,  
33 MAIDEN LANE, NEW YORK.  
Smelting and Refining Works,  
28 & 30 Cumberland Street, Brooklyn, N. Y.  
Specialties: Sweepings, Gold, Silver and Platinum.

NEW! IMPROVED NEW!  
Adjustable "Eclipse" Eye Glasses.

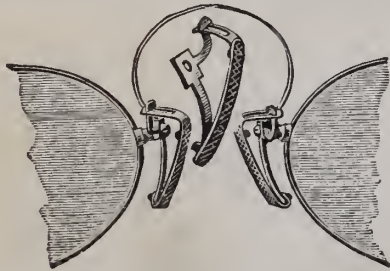

PATENT APPLIED FOR.  
We claim this invention to be the only one which combines the advantages of both the adjustable and offset guards. We will furnish these frames or guards by Sept. 1st, in either Zylonite or Cork.  
WRITE FOR CIRCULAR.  
JOHN SCHEIDIG & CO., SOLE AGENTS  
43 MAIDEN LANE, NEW YORK.

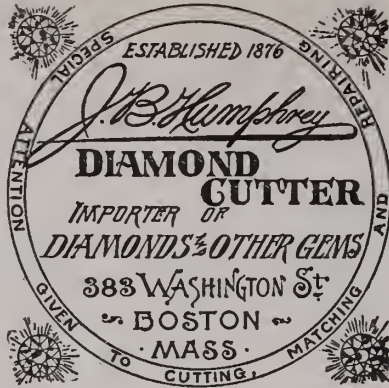

EMERALDS.

E. KIPLING,  
182 Broadway, New York.  
ELEVATOR ENTRANCE, 2 JOHN ST.

FRENCH WRITE FOR CATALOGUE. ENGLISH

CLOCKS

AND CLOCK MATERIALS.  
CHAS. JACQUES CLOCK CO., 22 CORTLANDT ST., N. Y.

L. LELONG & BRO.,  
GOLD AND SILVER  
Refiners, Assayers and Sweep Smelters,  
SOUTHWEST CORNER HALSEY AND MARSHALL STREETS,  
NEWARK, N. J.  
SWEEPINGS A SPECIALTY.

YOU CAN MAKE MONEY By Putting in a Handsome Assortment of  
FINE POCKET CUTLERY.  
We are agents for the SOUTHWEST CORNER HALSEY AND MARSHALL STREETS, NEWARK, N. J. Celebrated RAZORS and POCKET KNIVES.  
SEND FOR AN ASSORTMENT.  
H. B. BEACH & CO., 418 Washington St., Boston, Mass.

BLACK DIAMOND FOUNTAIN PEN.

Unequaled for Price.  
Send for Circular.



H. M. SMITH & Co., 83 NASSAU STREET, N. Y.

WHY S. F. MYERS & CO. sell more goods than any other Wholesale Jewelry House. BECAUSE They are the only firm in the Metropolis who carry in stock a full line of everything a jeweler requires. They give the utmost values and endeavor to please their trade in every respect. Refer to their various publications and illustrated catalogues.  
MYERS BUILDINGS, 48 & 50 Maiden Lane, NEW YORK.

ALBERT LORSCH & CO.  
37 MAIDEN LANE, NEW YORK.  
Branch, 167 Broad Street, Providence, R. I.  
IMPORTERS OF DIAMONDS,  
Rose Diamonds, Rubies, Sapphires, Emeralds, Opals, Moonstones, Fancy and IMITATION STONES, NOVELTIES.

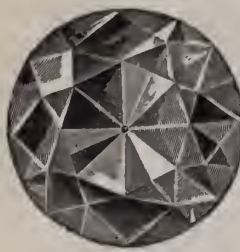

SOLE OWNERS AND IMPORTERS OF The Sumatra Gem. REG'D

IT PAYS TO KEEP IN TOUCH WITH TRADE AFFAIRS. THE JEWELERS CIRCULAR, For 4c. a Week will do it. Subscribe.



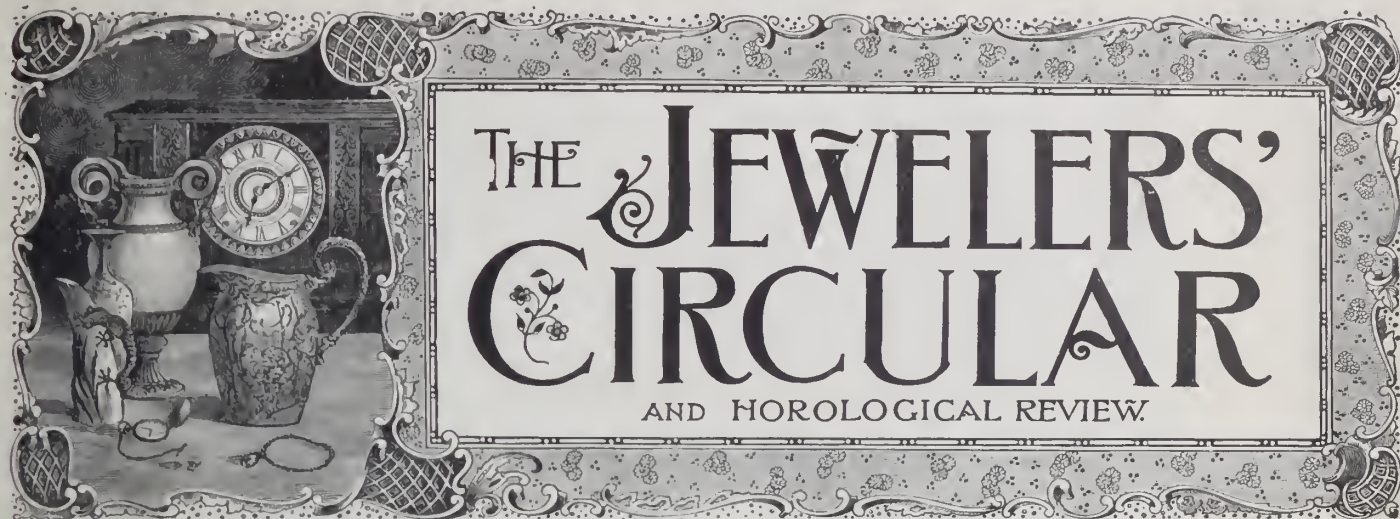

# THE JEWELERS' CIRCULAR

AND HOROLOGICAL REVIEW

Copyright, by THE JEWELERS' CIRCULAR PUB. CO.

189 Broadway, New York.

Entered at the Post Office in N. Y. as second-class matter

VOL. XXVII.

NEW YORK, WEDNESDAY, OCTOBER 25, 1893.

NO. 13.

## JEWELERS' WORK PRESENTED TO RUSSIAN OFFICERS.

PARIS, France, Oct. 13.—Admiral Avellan, commander of the Russian fleet, upon his visit to Paris, will be presented with a silver statue modeled by Coutan, one meter high, symbolizing *La Paix Armée* (armed peace), cast by Thiebaut Freres, French

tilted slightly back. At her feet is a horn of plenty, while on a scroll is engraved the motto, *Paix, Travail* (Peace, Work.)

A bronze bas-relief will be offered to each commanding officer of the ships belonging to the visiting fleet. It is a copy of Chapu's work *La Pensée*; a young woman sits on a bench in a thoughtful attitude. Her right hand points above her head to the sky, from which sun rays come through rolling clouds, lighting up the blank page of Future which she holds in her left hand. Her countenance expresses deep emotion. Smaller copies of the same bas-relief will be given to the other officers.

We reproduce here Coutan's statue *La Paix Armée*. Every Russian naval officer will also receive from the Paris Town Board a silver medal engraved by Chaplain. That to Admiral Avellan will be of gold.

Another remarkable work in marble, *La Sirène*, by Puech, a copy of which, in bronze, may be seen in Barbedienne's pavillion, at the World's Fair, has been offered to Admiral Avellan by the district board of the Var, sitting at Toulon. *La Sirène* is one of the most perfect works produced during the last two years. As seen in the illustration, the idea it symbolizes is strikingly rendered. The syren having the bust and head of a woman, the rest of the body being marine, has besides two large wings like a monster bird of prey. She carries a young man on her shoulders, and looks at him lovingly, singing to him in a soft, caressing tone. The countenance of the youth, who struggles against the influence of the bewitching music, is expressive of fear. The ensemble is of a most artistic effect, at once impressive and graceful.

For the same occasion of the fleet's visit to Toulon, Madame Juliette Adam, the most prominent of French woman writers suggested that all women and girls of France wear a trophy consisting of two

sprigs of forget-me-not in jewelry or enameled gold, showing the words *Cronstadt-Toulon*. Madame Adam suggested also that each Russian sailor of the visiting fleet, be presented with several similar jewels to take back to his wife and female relatives



LA SIRÈNE, BY PUECH.

exhibitors in the bronze department at the World's Fair. Peace is represented by a woman with outstretched wings, standing erect in a noble and dignified attitude. Her eyes look steadily yet calmly into space. Her right hand rests on a sword with ivy winding about it. She wears a helmet



LA PAIX ARMÉE, BY COUTAN.

This idea was accepted at once, and jewelers have been at work making a large amount of these trophies with colored precious stones or enameled gold.

A jury of artist-painters, presided over by Puvis de Chavannes, met the other day at Madame Adam's house and selected the

# THESE LEATHERS ARE MADE IN THE FOLLOWING ARTICLES:

Card Cases,  
 Pocket Books,  
 Photo. Frames,  
 Calendars,  
 Folios,  
 Purses,  
 Combination Books,

Desk Pads,  
 Cigar Cases,  
 Prayer Books and Hymnals,  
 Stamp Cases,  
 Watch Card Cases,  
 Marriage Registers,

Spectacle Cases,  
 Memo. Books,  
 Check Blotters,  
 Address Books,  
 Visiting Books,  
 Bill Folds,  
 Cigarette Cases,

Engagement Pads,  
 Eye Glass Cases,  
 Finger Prayer Books,  
 Telegraph Pads,  
 Chatelaine Bags,  
 Pen Wipers.

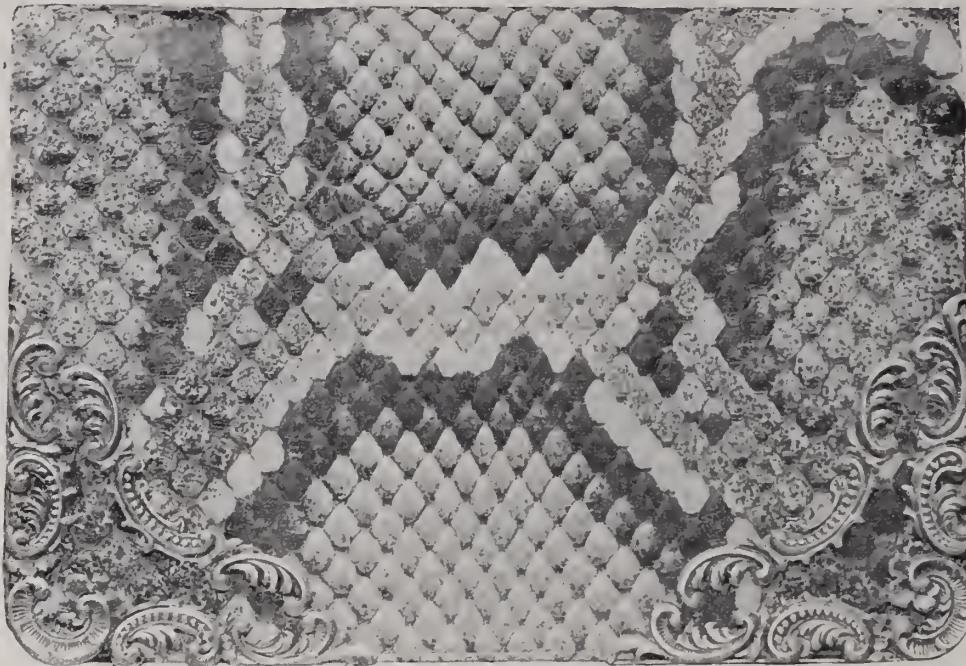

NATURAL SNAKE CARD CASE—STERLING CORNERS— ROCOCO.”

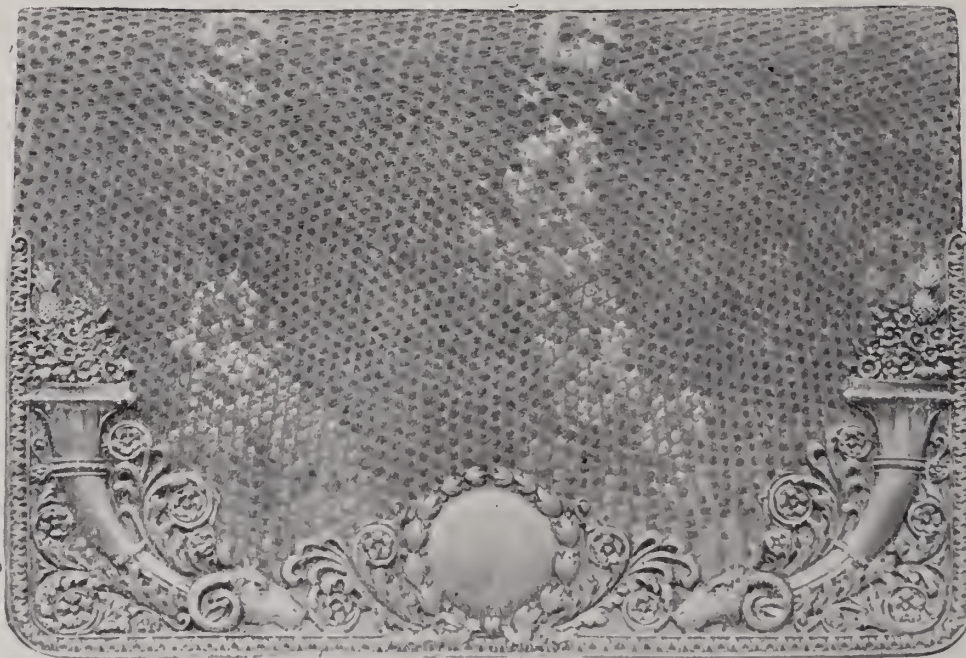

NATURAL LIZARD COMBINATION—STERLING FRONT— EMPIRE..

# DEITSCH BROS., 7 E. 17th Street, NEW YORK.

ORIGINATORS AND MAKERS OF

## NOVELTIES IN LEATHER AND STERLING SILVER COMBINATIONS,

ALSO EBONY AND SILVER COMBINATIONS IN NOVELTIES AND TOILET SETS. .

LARGEST ASSORTMENT IN THE COUNTRY.

**Dominick & Haff,**  
MAKERS OF WARES IN  
**STERLING SILVER.**

FOR THE TRADE ONLY.

Broadway & Seventeenth St.,  
UNION SQUARE, NEW YORK.

# THE "CROMWELL"

PATENTED SEPT. 12TH, 1893.

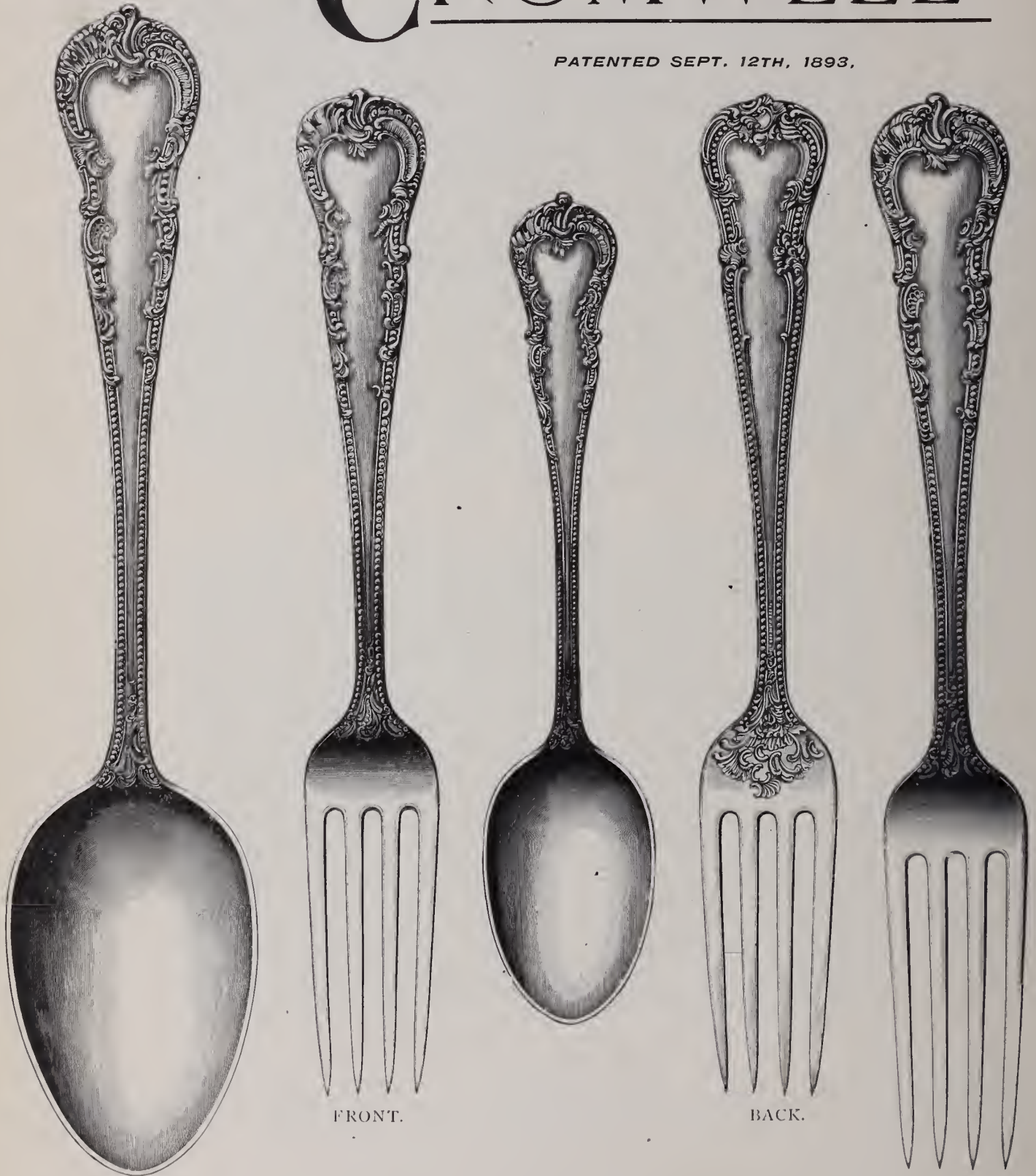

W. B. DURGIN, Concord, N. H.

*Pairpoint*

# MFG. COMPANY,

## GOLD AND SILVER PLATE, New Bedford,

### Mass.

DO NOT FAIL to see our exhibit at Columbian Exposition, Section N, Manufactures Building, and our store, 224 Wabash Avenue, Chicago.



No. 3483. Embossed Tea Caddy.



No. 927. Jewel Casket.



No. 3727. Hair Pin Box.

CHICAGO,  
224 Wabash Ave.

NEW YORK,  
20 Maiden Lane.

SAN FRANCISCO, CAL.,  
220 Sutter Street.

### LLOYD PATENT.

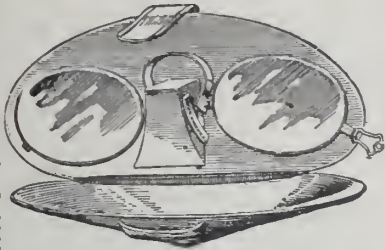

In Good **CASE** you want a send for LLOYD

H. E. KIRSTEIN & CO.,  
MANUFACTURERS,  
Rochester, N. Y.

We sell to the legitimate Jewelry and Stationery trade only.



NEW YORK CITY, U.S.A

## CHOICE PAPERS

MAKERS OF

# FINE STATIONERY

For Correspondence, Wedding and Business Use, handsomely boxed, specially suited to the Jewelry Trade.  
18 MURRAY STREET, NEW YORK.

**OPTICIANS' SUPPLIES**  
Jobbing and Prescription Work.

The "Graduate" Trial Cases, 180 lens set, \$30.00; 220 lens set, \$37.50. The "Standard" Trial Case, 220 lens set, \$65.00. All with lenses. Loring Ophthalmoscope, \$9.00. Artificial Eyes, for selection, \$1.00 each; \$50.00 per hundred. Ophthalmometer, \$30.00 to \$70.00. Queen's Standard Perimeter, \$18.50. Queen's Lens Grindling Outfit, \$3.00. Steel Frames, 15 to 30 cents each. Spherical Lenses, 25 cents per pair. Cylinders, 35 cents per pair. Lenticular Bifocals, 8 cents per pair, (all best made). Nose pieces (Rubber or Shell) German Silver, \$1.00 per dozen pairs. Total \$2.00 per dozen pairs.

**QUEEN & CO.** Opticians and  
Catalogue free. 1010 Chestnut St., Phila., Pa.

# NOVELTIES IN STERLING SILVER



No. 330. MATCH SAFE.



No. 14. PIN BALL.



No. 13. PIN BALL.



No. 325 MATCH SAFE.

Trade Mark.



No. 104. POCKET KNIFE.



No. 102. POCKET KNIFE.



No. 3. COURT PLASTER CASE.



No. 39. CANDLE HOLDER.



No. 800. NAPKIN RING.

# R. WALLACE & SONS MFG. CO.,

## SILVERSMITHS,

NEW YORK,  
3 PARK PLACE.

WALLINGFORD, CONN.

SAN FRANCISCO, 120 SUTTER ST.

CHICAGO,  
86 WABASH AVE.

most appropriate patterns among fifty specimens sent by the most prominent members of the jewelry trade. Madame Adam ordered 1,500 bracelets at Félix Duprey's, 1,500 medals at Duval & Letureq's, 130 brooch medals at Vever's, and 6 Greek crosses (to be offered to chaplains) at Desprez's.

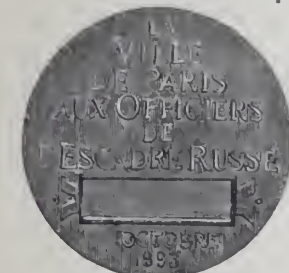

MEDAL GIVEN TO RUSSIAN SAILORS.

The bracelet pattern selected is in the shape of a hawse chain with lengthened links; one link in dead gold, decorated with engine-turned work, alternates with one in polished red gold. From the clasp hangs a gold medal, one face showing an olive branch (symbol of peace) in relief, curling gracefully

around two medallions bearing the inscription: "Cronstadt, 1891," in Russian, and "Toulon, 1893," in Latin characters. On the reverse are two sprigs of forget-me-nots, tied with a narrow ribbon, framing the words, *Souvenir des Femmes de France*.

Vever's brooch medal is of oxidized silver circled by a gold ring reminding one of the wheel of a ship. In the center is an escutcheon in relief with the inscription "Cronstadt, 1891, Toulon, 1893"; the reverse shows an anchor surrounded with a wreath of forget-me-nots. The Greek crosses reproduce the *motifs* of the medals.

Madame Adam has besides given to Potheret an order for popular *bijou souvenirs*, very small, in oxidized silver exhibiting a sprig of olives and one of forget-me-nots tied with a tricolored ribbon, an anchor showing among the flowers and foliage.

Other jewelers who hope to profit by the craze are at work introducing besides the mentioned symbols figures of Russian and French sailors holding flags, etc. JASEUR.

**HENRY ABBOTT,**

MANUFACTURER OF

**Stem-Winding Attachments FOR WATCHES,**

No. 2 Maiden Lane, NEW YORK

**Headquarters FOR ELECTRIC & PORTABLE Watchman's Clocks**

Lowest Prices. Latest Improvements, Patents 1886-1893. Send for Circular.

E. O. HAUSBURG, 41 Maiden Lane, New York.

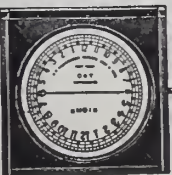

Price, Complete \$10.00

THE "ALERT."

**BIPPART & CO.,**

— MANUFACTURERS OF —

**FINE JEWELRY,**  
NEWARK, N. J.

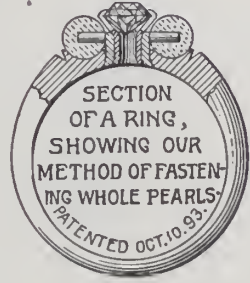

We claim our "Patent Whole Pearl Fastener"

superior to all others now in use, and absolutely secure. It enables us to make a line of Rings, Scarf Pins and Brooches unsurpassed in durability and finish.

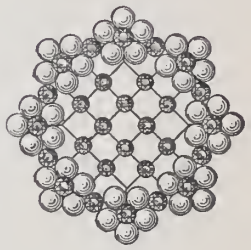

PATENTED OCT. 10TH, 1893.

New York Office, 19 MAIDEN LANE.

**THE BOWDEN SEAMLESS RING**

IS MADE ONLY BY

**J. B. BOWDEN & Co.,**

Makers of Finger Rings of every Description

COR. BROADWAY & JOHN STREET, NEW YORK.

**Aikin Lambert Jewelry Co.**  
Importers of **Diamonds**,  
Jobbers in **WATCHES**,  
Jewelry, Chains etc.  
19 Maiden Lane, New York.

SAM'L B. MANN, Treas.  
FRED. D. ILGEN, Sec'y.

**O. W. BULLOCK & CO.,**  
SPRINGFIELD, MASS.

Makers of Watch and Jewelry Tools,  
NEW CATALOGUE NOW READY.

Sent on Application. Please Mention this Paper.

**CLEAN JEWELRY SELLS QUICK.**

Quarters' Cleaning Solution removes dirt and tarnish in an instant, makes stock like new and brings up diamond and stone work to a beautiful lustre. Solution can be used over and over. Highly commended by all who use it. Send at once \$1.50 for half gallon with full directions. References.

W. F. QUARTERS ELECTROPLATER,  
139 EDDY STREET, PROVIDENCE, R. I.

# J. B. & S. M. KNOWLES CO.,

MAKERS OF

Sterling



Silverware.

FACTORY,  
Providence, R. I.

SALESROOM,  
860 Broadway, N. Y.

# C. SYDNEY SMITH,

HAS REMOVED TO

191 BROADWAY,  
New York.

FACTORY:  
PROVIDENCE, R. I.

Manufacturer of

GOLD CHAINS,  
LOCKETS AND CHARMS.



## The Warren Eye Protector

(Patented Jan. 12, 1892, Feb. 21, 1893.)

Saves the Eyes From

Dust, Wind, or Glaring Light.

Folds in a Compact Case, is

Comfortable, Durable,  
Water and Dust Proof.

Its large field does not obstruct the sight. No brittle substance to endanger face under sudden blows.

Oculists and Physicians Recommend it.

Travelers, Cyclists, Railroadmen,  
Horsemen, Motormen, Quarrymen,  
Pronounce it Indispensable for Man or Woman.

Ask your Dealer for it.

Colors, Clear, Smoke, Blue or Green. Black frames, 50c. Silver, 75c. Sent by mail on receipt of price. Manufactured solely by

**The Nous Verrons Company**

P. O. Box 3273, Boston, Mass.

### Death of W. T. Nicholson, President of the Nicholson File Co.

PROVIDENCE, R. I., Oct. 17.—William T. Nicholson, president and founder of the Nicholson File Co., died at his home in this city at 4.30 o'clock this morning, having been stricken with apoplexy shortly after rising from the breakfast table yesterday.

Mr. Nicholson was born in Pawtucket, March 22, 1834, but his boyhood was spent in Whitinsville, Mass., and it was there, at the age of fourteen, that he entered the machine shop of Paul Whitin & Sons, and learned the machinist's trade which has been the basis of his life work. He later came to this city, and in 1852 entered the machine shop of Joseph R. Brown, with whom and the firm of Brown & Sharpe, he remained for six years, having the entire management of the shop for the last two years of his service with them.

By diligent use of his evenings, which he devoted to the study of mechanics and mechanical drawing, he acquired such proficiency that he was competent to make all the drawings used in the works where he was employed.

After a short partnership with Isaac Brownell in 1858, we find him in 1859 in business alone, and in 1860 he had moved into larger quarters at 110 Dorrance St. The outbreak of the Civil War, though at first followed by dull times, soon brought the plant and resources of the young mechanic into active play to supply the machinery needed to produce the small arms required by the United States Government. Soon after he with the late Henry A. Monroe, engaged in the manufacture of the small parts of rifles, having devised several special machines in addition to carrying on his machine shop.

In the Spring of 1864 he sold the rifle branch of his business to his partner, Mr. Monroe. This left him free to give more attention to his machine shop, and to the development of his improved machine for cutting files. The successful completion of this machine soon followed and the organization of the Nicholson File Co., in 1864 was the result. The lapse of time and the achievement of success brought about no change in his labors, for the closing week of his life found him actively and earnestly working for the company's advancement.

# F. W. GESSWEIN,

39 JOHN STREET,

NEW YORK.

## ENGRAVERS' REFLECTORS

FOR OIL OR GAS, SINGLE OR DOUBLE.

The Glass Reflecting Globe magnifies and concentrates the light, and can be adjusted to cast it on any desired point.

..... Circulars and Price Lists on Application .....

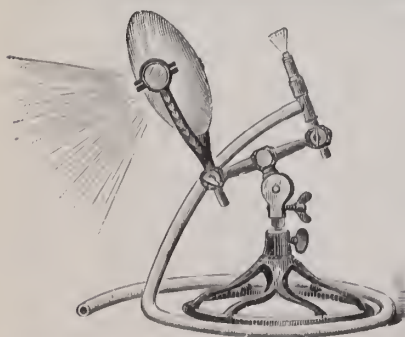



# AIKIN, LAMBERT & CO.

19 Maiden Lane, NEW YORK.  
Branch, 42 & 44 East Madison St., CHICAGO, ILL.  
Manufacturers and Exporters of  
Gold Pens, Holders, Picks, Pencils,  
Fountain Pens, etc.

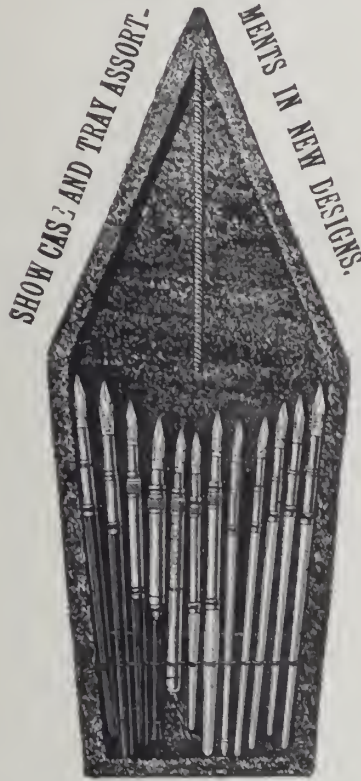

11 x 5 1/2 inches.

PLUSH TRAY WITH EASEL BACK.

1 Doz. 16 K. Pens and Assorted Holders, List, \$31  
1 Doz. 10 K. Pens and Assorted Holders, List, \$24  
Send for Trade Discount.

## Brunor Plating and Jewelry Rep. Co.

Jewelry Matched and Repaired, Engraving,  
Chasing and Enameling, Setting, Polishing and  
Lapping, Battery Gilding and Roman Coloring,  
Watch Cases Repaired, Polished and Gilded.  
22 Maiden Lane, New York.



HE HAD A  
~△ HANG-DOG LOOK, △~

BECAUSE HE BOUGHT HIS  
Gold, Silver, Steel and Nickel  
Spectacles and Eyeglasses.

Gold, Silver, Aluminum and German Silver  
THIMBLES.

— AND —

SEAMLESS, GOLD FILLED,  
SPECTACLES AND EYEGLASSES,  
BEFORE SEEING OUR LINE.

## THE WINSTED OPTICAL CO.,

MANUFACTURERS OF

The BURBANK Patent Eyeglass, SEAMLESS Gold Filled Spectacles and Eyeglasses. And all  
other goods enumerated above. WRITE US! WEST WINSTED, CT.

## Hair Pin and Eye Glass Chain COMBINED.



This illustrates the Hair Pin and  
Eye Glass Chain Combined. It is  
one of the most dressy as well as the  
most comfortable ways of securing  
the Eye Glass ever put on the market, and it is  
justly becoming very popular.

S. F. MERRITT, Manufacturer,

N. Y. Office, 194 Broadway.

SPRINGFIELD, MASS.

# MATHEY BROS., MATHEZ & CO.

21 & 23 MAIDEN LANE, N. Y., and BRASSUS, SWITZERLAND.

MANUFACTURERS AND IMPORTERS OF

Plain and Non-Magnetic Movements.

Complicated Watches a Specialty.

A FULL LINE OF 10 and 16 SIZE

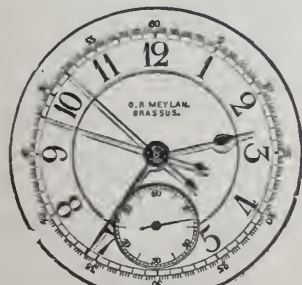

SIZE 10.

# SPLITS



10 SIZE.

# ROGERS, SMITH & CO.

UNION SQUARE,  
NEW YORK.

MERIDEN,  
CONN.



BEST QUALITY

## GOLD AND SILVER PLATE.

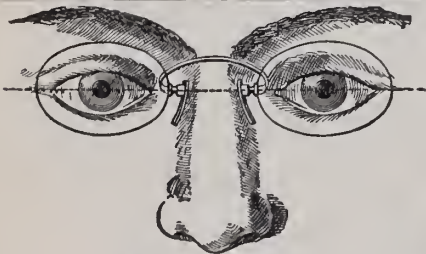

Patented Feb. 9, 1892.

**THE W. B. & E.**

Marvel Tilting Spring Eyeglass in Gold, Steel, and Frameless.

**JULES LAURENCOT & CO.,**

49 MAIDEN LANE, NEW YORK.

Sole Agents in the United States and Canada.

Sold by all wholesale dealers at manufacturer's price.

**A. N. CLARK,**  
PLAINVILLE,  
CONN.

Manufacturer of the Celebrated  
**LOOP WATCH KEY.**

The Best for the Price in the World.  
CROSBY'S JEWELING TOOLS IMPROVED.

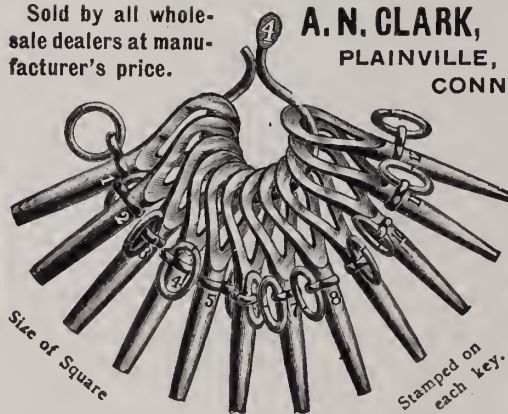

Size of Square

Stamped on each key.



Will quote royalty or price for the manufacturing of articles of real worth.

**Enterprising Jewelers Catch On!**

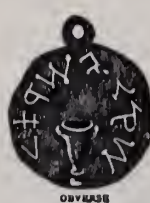

OBVERSE



REVERSE



BACK

**Jewish Sheckel, Masonic Mark or Pocket Piece.**

THE LATEST AND BEST SELLING NOVELTY.

The mark is struck in coin silver, by using either the obverse or reverse of the coin, the back being the same in either case, and permitting of the purchaser's name, blue lodge, chapter and individual mark, with date of same being engraved thereon, as shown in cut above.

Price, without engraving, ONE DOLLAR. Engraved Mark, Dates, etc., 75c. EXTRA.

Liberal Discount to the Trade.

**CHAS. C. WILLSON, MANUFACTURING JEWELER, READING PA.**

**PEARLS.**

**RUD. C. HAHN,**  
194 BROADWAY, NEW YORK.

**GARNETS.**

Mr. Nicholson has served the city as an Alderman from his ward; has been a trustee of the Providence Public Library from its organization and was for several years its treasurer; was a director of the Rhode Island National Bank and the Narragansett Electric Light Co.; a member of the Providence Board of Trade and of the American Society of Mechanical Engineers. Mr. Nicholson was married in 1857 and a widow and four children survive him.

**Mrs. George W. Luce Jointly Indicted With Her Husband.**

COLUMBUS, O., Oct. 18.—A surprise has developed in the case of George W. Luce, the jeweler charged with conducting a fence. In the indictment last week sixteen cases were presented by the Grand Jury. Of these fifteen are against Luce alone, while the sixteenth charges Luce and his wife with concealing \$90 worth of property from August Tournier.

All but three of the indictments against Luce make penitentiary charges. The three are jail cases. The one against Mrs. Luce is a penitentiary case. The court fixed the amount of Mr. Luce's bond at \$5,700, and of Mrs. Luce's at \$700.

**Two Women Neatly Fool a Long Island Jeweler.**

BROOKLYN, N. Y., Oct. 18.—Two well dressed and respectable looking women entered the jewelry store of A. Butterfield, at Rockville Center, on Monday afternoon and asked to see some rings. A tray was placed on the counter from which they selected three of the most valuable, but said they could not decide which to purchase. They suggested that the jeweler's wife might assist them to a decision. One of them claimed to be a friend of Mrs. Butterfield.

The jeweler obligingly stepped into a back room and called his wife. When he returned the women and the three rings were missing. An alarm was sent out, but the women escaped.

**The Jury Could not Agree in the Case Against C. L. Tobey.**

SCRANTON, Pa., Oct. 19.—The trial of C. L. Tobey, jeweler, charged with having received goods stolen from Conrad Luther's jewelry store was up last week. The goods were sold to Tobey by Fred Luther and Max Minnich.

Tobey denied ever knowingly purchasing stolen goods, and brought several witnesses to establish his good character. The jury were unable to agree after being out all night, and the members were discharged.

**The Jewelers' Security Alliance.**

The regular monthly meeting of the executive committee of the Jewelers' Security Alliance, was held at the Alliance office the 13th inst. There were present: H. H. Butts, chairman; president A. K. Sloan; vice-president, J. B. Bowden, Henry Hayes



**ARTISTIC METAL GOODS.**  
NEW DESIGNS,  
NEW FINISHES.

Our line of Pitchers, Vases, Tables, Candlesticks, Five O'Clock Teas, Etc., cannot be equaled.

**THE CELEBRATED "B & H" LAMP.**



BEAUTIFUL DESIGNS, particularly adapted to the Jewelry Trade.

SEE OUR LINE OF TABLE, BANQUET AND PIANO LAMPS before placing your orders. Send for our Little Book.

**BRADLEY & HUBBARD MFG. CO.**  
NEW YORK, BOSTON, CHICAGO,  
21 BARCLAY ST., 160 CONGRESS ST. 88 WABASH AVE.  
26 PARK PLACE Factories, MERIDEN, CT.

**'THE BEST BUTTON MADE.'**

THE KREMENTZ  
IN GOLD FROM KREMENTZ & CO. ONE PIECE FROM ALL JOBBERS  
IN ROLLED PLATE

**COLLAR BUTTON.**  
IS THE ORIGINAL ONE PIECE BUTTON.  
IS STILL THE BEST AND STILL UNSURPASSED

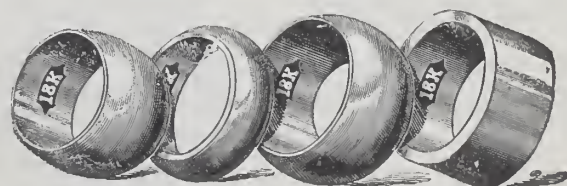

**PLAIN SOLID GOLD RINGS.**  
**HILDRETH MFG. CO.,**  
53 MAIDEN LANE, NEW YORK.

BUY ONLY THE BEST  
Electro Silver Plated Flatware,

STAMPED

★ ROGERS & BRO., A. I.

THE ORIGINAL, GENUINE AND CELEBRATED

# STAR ★ BRAND

Which has stood the test for fifty years.....

.....For sale by all first-class jobbers.

MADE ONLY BY

## ROGERS & BROTHER,

Waterbury, Conn.,

16 Cortlandt St., N. Y.

SEND FOR NEW ILLUSTRATED CATALOGUE, NOW READY.

### If Your Sales Are Not Satisfactory

ADDRESS

#### DE B. O. SCOTT,

20 Murray Street, New York.

AUCTIONEER.

Specialties: Watches, Clocks, Bric-a-Brac, &c.

Write for particulars and references.

### Excellent For Window Display.



Size, 6x10 Inches.

Fac-Similes of the World's Historical Diamonds,  
Leather Cases, Velvet Lined, each Stone  
named. Price complete, \$10.00.

#### Julius Eichenberg,

Precious and Imitation Stones,

174 Weybosset St., Providence, R. I.

WHITE AND JOBBING STONES.

—SPECIAL INDUCEMENTS TO MANUFACTURERS AND JOBBERS.—



HENRY C. HASKELL,



11 JOHN STREET,



NEW YORK.

Gold or Silver.

Samples sent on approval.  
"PREPAID."



### Watches, Diamonds,

Gold and Rolled Plate  
Jewelry.

### TOOLS AND MATERIALS.

Send for Price List.



Manufacturers of the Centennial Watches.

## CROSS & BEGUELIN, - 17 Maiden Lane, N. Y.

and David Untermeyer; treasurer, Bernard Karsch and Messrs. Kroeber, Abbott, and Geo. H. Hodenpyl, secretary.

The following were admitted to membership: Clark & Engle, Wilkesbarre, Pa.; M. L. Comfort, Owego, N. Y.; Stephen B. Dunton, Penn Yan, N. Y.; Albert Kamp, Sing Sing, N. Y.; Lewis Kaiser & Luthy, New York; E. H. Morin, Wilton, Me.; Perry & Stone, New London, Conn.; Wm. Rae & Co., Newark, N. J., and Chas. Schultz & Son, Newark, N. J.

#### Death of Rev. Sigmund Sorg, Watch-maker.

MANSFIELD, O., Oct. 19.—Rev. Sigmund Sorg, the pastor of the only Apostolic Church in the city, died Tuesday evening at 7 o'clock.

Mr. Sorg was born in Bardan, Hungary, March 16, 1840. He came to Mansfield in 1864, where he learned the trade of a watch-maker, which he followed up to the time of his death, which resulted from lung fever. A wife survives him.

#### Receiver Freeman Protects a \$35,000 Cash Loan.

NEW HAVEN, Conn., Oct. 21.—Edward H. Rogers, of New Haven, attorney for Pierce N. Welch, president of the First National Bank, of this city, made application to Judge Wheeler in the Superior Court, to-day for an order directing Edward A. Freeman, receiver for E. N. Welch Mfg. Co., Forestville, to pay over to his client checks and other papers of value, to reimburse Mr. Welch for \$35,000, which the latter loaned to the company about a year ago.

The company gave as security a lot of manufactured clocks some of which have been sold. Judge Wheeler granted the order.

#### The Jewelers' and Tradesmen's Co.'s Books to be Examined.

In the suit brought in the Court of Common Pleas by Mary Sullivan and John Y. McGrane against the Jewelers' and Tradesmen's Co. of New York, a motion was made last week to allow the plaintiffs to inspect the books of the defendant company. The plaintiffs are beneficiaries in that organization for \$5,000, on the life of the late Jeremiah D. Sullivan.

One of the defenses set up was that the company had not collected sufficient money on the assessment levied last May, to pay this benefit. The plaintiffs wished to verify this defense, and Judge Giegerich granted their motion for an order allowing W. H. Bacon, the plaintiffs' attorney, to examine all books and papers of the defendant company which relate to facts and particulars set forth in this defense.

About 1 o'clock last Monday morning, burglars entered the jewelry store of R. H. Safford, Leominster, Mass., and took two trays of jewelry and several watches, valued at \$200. The police are investigating the matter.

#### The Last Rites in Memory of George C. Shreve.

SAN FRANCISCO, Cal., Oct. 18.—George C. Shreve, the founder and head of the large jewelry house of Geo. C. Shreve & Co., this city, whose death was announced in THE CIRCULAR last week, had been ill more than a year, and his condition was such that death was not unlooked for.

The deceased was about sixty-five years of age. He was born in Salem, Mass., and after-



THE LATE GEORGE C. SHREVE.

ward lived in Saco, Me., with his sister Mrs. Calef, and was in the store of his half-brother Benjamin in that town. When a boy he shipped as a sailor aboard a coasting vessel on the Atlantic coast, with his brother Samuel. After this he was with Kingsley & Shreve, at 22 Maiden Lane, New York. He came to California by way of Cape Horn, arriving in San Francisco in 1852. The same year he went into partnership with his brother, Samuel S. Shreve, in the jewelry business. The business proved lucrative, and the firm soon became wealthy.

While on his way east, a few years later, S. S. Shreve was drowned near the Isthmus of Panama. It had been agreed between the brothers that when either died the survivor should succeed to the entire estate. Accordingly George S. became the sole proprietor of the business. Some years later he associated with him George Bonney and Albert J. Lewis, the three forming the firm of George C. Shreve & Co.

Mr. Shreve was of a kindly disposition, and was public spirited and almost the last of the old time jewelers. He had a beautiful home in this city, besides valuable country property at Mountain View, where he spent his closing days. Mr. Shreve married Mrs. Rebecca Creamer, of Salem, in 1858. He leaves a family consisting of his wife, son and daughter. The funeral took place from the family residence, on Monday morning. After the simple religious services, relatives and a few most intimate friends accompanied the body to the Masonic cemetery.

The portrait here presented is reproduced from a photograph taken over 25 years ago. However, the deceased's many eastern friends will recognize his features.

#### Custom House Broker Vandiver Held for Court.

PHILADELPHIA, Pa., Oct. 20.—Custom house broker John L. Vandiver, who was arrested last Friday, as reported in last week's CIRCULAR, charged with attempting to effect an entry of dutiable goods on a fraudulent representation, had a hearing before United States Commissioner Edmunds, Monday, and was held in \$1,000 bail for court. The charge against Vandiver is that he tried to have entered free of duty a consignment of lenses owned by T. A. Willson & Co., Reading, Pa., he alleging, it is said, that the goods were unwrought glasses.

The first witness examined by United States District Attorney Ingham was A. W. Durrell, entry clerk at the custom house. He produced records of the entry and invoice showing the goods to be nineteen cases of lenses, and an invoice entry signed by Vandiver stating that the goods were disks for manufacturing purposes, and, therefore, duty free. Examiner C. A. Eicholtz testified that the goods were examined by him and he found them lenses dutiable at 60 per cent. ad valorem, the duty amounting to \$876.60. This was paid.

To prove knowledge and attempt to defraud on Vandiver's part Mr. Ingham produced letters sent to T. A. Willson & Co., it is alleged, by Vandiver, requesting them to send the amount of duty on the goods. According to one of the letters the money was sent by the firm and received by Vandiver.

[In justice to T. A. Willson & Co. it is well to state that the report in THE CIRCULAR last week was incomplete. We should have stated that Vandiver's notification to them of the arrival of the consignment was accompanied by the usual statement of duty, a check for the full amount of which was immediately sent him by Messrs. Willson & Co. His action in declaring the goods non-dutiable was taken entirely without their knowledge. These facts entirely free T. A. Willson & Co. from any unfavorable position the incomplete report may have put them into.—Ed.]

#### The Preferred Creditors of L. Brandt & Co.

MEMPHIS, Tenn., Oct. 19.—The preferred creditors of L. Brandt & Co., whose failure was announced in THE CIRCULAR last week, are the First National Bank, note \$2,000, secured by two notes aggregating \$6,000; Henrietta Levy, note \$1,000; Manhattan Savings Bank, note \$500; First National Bank, note \$500; Mrs. R. Brandt, note \$3,500.56; Mrs. R. Brandt, note \$2,340; Mrs. R. Brandt, note \$1,000; Jennie Caro, note \$1,358.76; R. C. Snowden, rent of store \$450.

The trustee is to take possession of the property and sell the same in twelve months, liquidating the debts mentioned in the order named.

# THE "KENSINGTON,"



8, 10, 12 oz.



15, 18 oz.

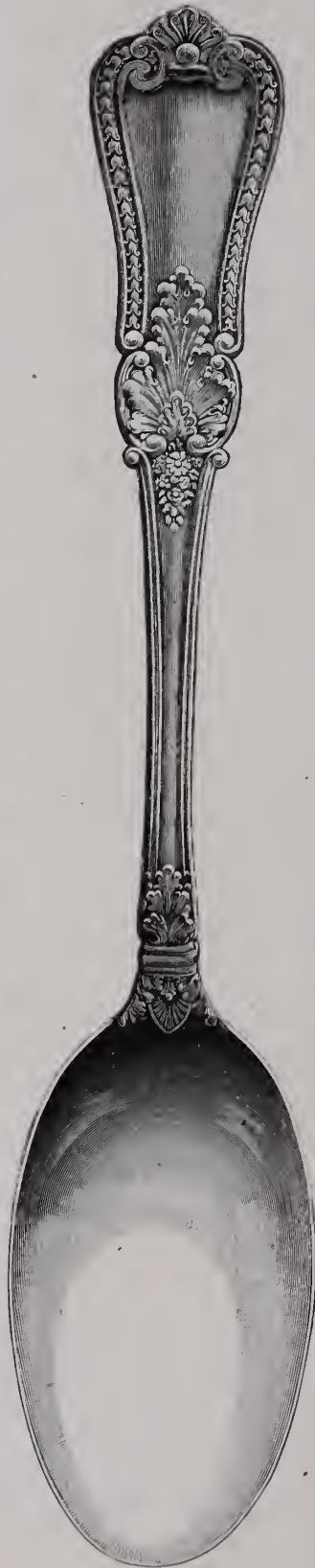

22, 28 oz.



20, 25 oz.



15, 18 oz.

GORHAM MFG. CO., SILVERSMITHS.

# GORHAM SOLID SILVER.

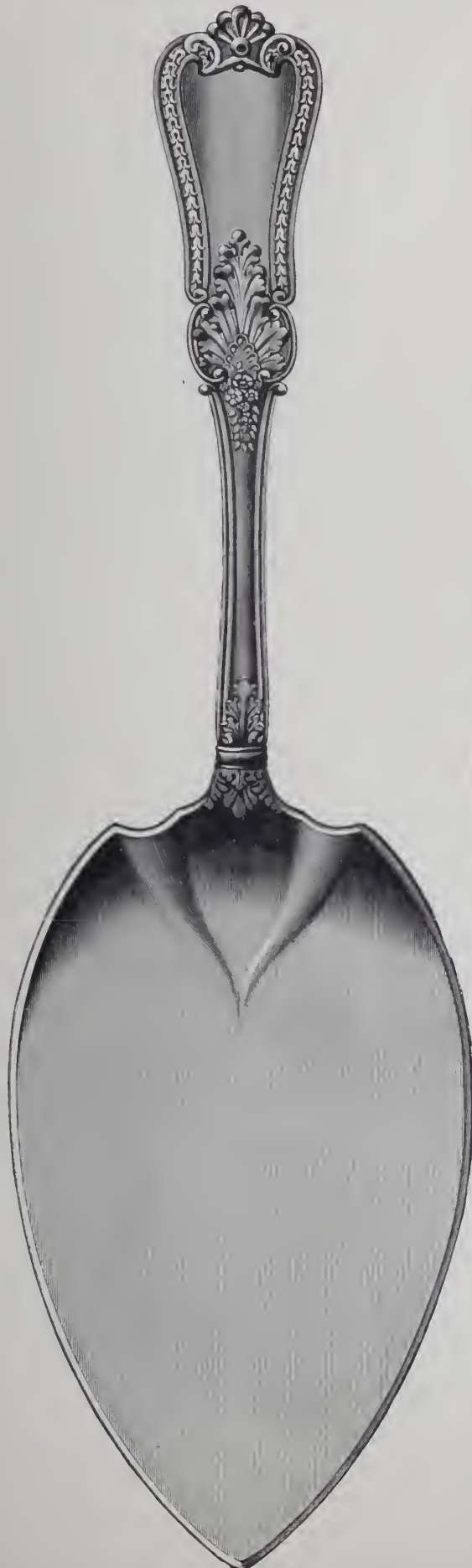

PIE KNIFE.



SUGAR

## THE KENSINGTON.

The Kensington supplies the demand of every dealer in silverware throughout the country for a plain, bright finished pattern, and appeals to the most refined and critical taste as a highly artistic design.

It is sold at such a low cost as to be perfectly suited to the wants of every market where a line of silverware is carried.

Fancy pieces as well as spoons and forks are the lowest in price ever offered by any house with a reputable Trade Mark.

Combination Chests of all sizes, up to 303 pieces, containing Kensington Ware are now ready.



NEW YORK:  
BROADWAY AND 19TH STREET.  
23 MAIDEN LANE.

CHICAGO :  
137 AND 139 STATE STREET.  
PARIS, FRANCE : 36 AVE. DE L'OPERA.

SAN FRANCISCO :  
118 AND 120 SUTTER STREET.  
WORKS : PROVIDENCE, R. I.

# Bouguereau's Great Masterpieces in Silver.

NYMPHS AND SATYR.



MATCH BOX.



COURT PLASTER.

PSYCHE AND LOVE.



MATCH BOX.

THE highest art has been attained in modeling the subjects of those great paintings in *bas relief* on Silver and Gold. The success we have made has elicited the highest expressions of approval from the famous painter **Bouguereau**, the recognized leader of the nude school, as may be seen in the following letter.

PARIS, 22 Juni, 1893.

WM. B. KERR & Co.,

MESSIEURS: Je viens vous remercier des deux boîtes en argent que vous avez bien voulu m'offrir.

J'ai pu constater par les bas reliefs, qui les ornent et qui sont faite d'après deux de mes tableaux "Nymphes et Satyre" et "Psyché et l'Amour," tous le soin que vous apportez à l'exécution de vos travaux ainsi que la recherche artistique que vous y mettez.

Je ne puis que vous encourager, Messieurs, à poursuivre dans cette voie me permettant cepedant de vous faire observer qu'a mon avis vous devez, avant de faire excécuter des œuvres d'art, obtenir la permission de l'Auteur.

Veuillez agréer, Messieurs, l'expression de mes sentiments très distingués.

PARIS, JUNE 22, 1893.

WM. B. KERR & Co.,

GENTLEMEN: I desire to thank you for the two silver boxes, which you have so kindly presented me with.

From the *bas reliefs* which ornament them, and which are reproductions of my two paintings "Satyr and Nymphs" and "Psyche and Love," I can certify with pleasure the great care shown in the execution of the work of reproduction, also the highest artistic sentiment.

I desire to encourage you gentlemen in pursuing such a path, allowing me to suggest that in so doing, that permission be obtained from the authors.

Kindly accept gentlemen the expression of my most sincere consideration.

## WILLIAM B. KERR & CO.,

Manufacturers of ARTISTIC JEWELRY IN GOLD AND SILVER,

FACTORY:  
NEWARK, N. J.

860 BROADWAY, N. Y.



# The Jewelers' Circular

AND  
HOROLOGICAL REVIEW.

PUBLISHED EVERY WEDNESDAY BY

THE JEWELERS' CIRCULAR PUB'G CO.,

189 BROADWAY, NEW YORK CITY.

A JOURNAL DEVOTED TO THE INTERESTS OF JEWELERS, WATCHMAKERS, SILVERSMITHS, ELECTRO-PLATE MANUFACTURERS, AND ALL ENGAGED IN KINDRED BRANCHES OF INDUSTRY.

Our Editorial columns will contain our own opinions only, and we shall present in other columns only what we consider of interest or value to our readers. Advertising matter will not be printed as news.

Advertising rates in THE CIRCULAR are lower, considering the number of tradesmen reached by its large circulation, than in any other jewelry journal.

Notices of changes in standing advertisements must be received one week in advance; new matter can be received up to Monday.

## INFORMATION FOR SUBSCRIBERS.

### Terms of Subscription, Postage Prepaid.

	PER ANNUM
United States and Canada, . . . .	\$2.00
Foreign Countries in Postal Union, . . . .	4.00
Single Copies, . . . . .	.10

New subscribers can commence at any time.

Payments for THE CIRCULAR, when sent by mail, should be made in a Post Office Money Order, Bank Check or Draft, or an Express Money Order or Registered Letter. All postmasters are required to register letters whenever requested to do so.

Pay money only to authorized collectors having proper credentials.

Returning your paper will not enable us to discontinue it, as we cannot find your name on our books unless your address is given.

In changing address always give the old as well as new one. Your name cannot be found on our books unless this is done.

We will continue to send papers until there is a specific order to stop, in connection with which all arrearages must be paid; but such an order can be given at any time, to take effect at the expiration of the subscription. All such orders will be promptly acknowledged by mail.

The Courts have decided that all subscribers to journals are responsible until arrearages are paid in full and an order to discontinue has been received by the publisher.

Member of the American Trade Press Association.

Vol. XXVII. Oct. 25, 1893. No. 13.

THE stocks of the jobbers are now fresh and complete and retailers who wish to make fine selections of Fall goods, should place their orders at the earliest possible moment.

AMONG the fine art notes in a recent number of a prominent New York daily newspaper was a description of a diamond corsage ornament of American production. It is a matter of satisfaction to us to note that critics are beginning to look upon goldsmithing and jewelery as a fine art and upon American jewelers as artists.

A THIEF follows his avocation in ratio to the temptation and opportunity offered him. A jeweler's show window brilliant with an array of goods, is a temptation; the shades of night and the patrolman around the corner comprise an opportunity. A jeweler of Springfield, Mass., will say yea to these statements, and every other jeweler knows the moral.

To Perpetuate **A Good Thing.** THE greatest exposition of all times will soon be a thing of the past. This is a sad contemplation, and one that makes us deeply feel the transitoriness of things mundane and the briefness of individual life itself. At present the disposition of the displays after the close of the World's Columbian Exposition, is a matter of some concern to the different exhibitors. The nature of the jewelry exhibits, especially those of the eastern manufacturers, including the collective exhibit of the New England Manufacturing Jewelers' Association, suggests a plan that appears to offer several advantages to the firms primarily interested. This plan includes the perpetuation of the displays now in the White City, in the form of a permanent exhibition. While it might not be possible to congregate all the American exhibits in the lines of jewelry, watches, silverware, optical goods, etc., it should not prove a difficult task to consolidate the exhibits of the Providence and Attleboro jewelers into a nucleus of an attractive exhibition. Such a display, kept by the various exhibitors fresh and up to date in the goods shown, would prove of great interest to both local and out-of-town buyers, as it would be an epitome of the market. New York would be the natural location for this exhibition, as the jobbers in general visit that city to purchase their Spring and Fall stocks. THE CIRCULAR respectfully submits this plan of a permanent exhibition for consideration.

### Effects of Smoke Upon Jewelry.

OF late there have been many expressions on the part of jewelers in those western cities where the excessive and almost exclusive use of soft coal in the large factories causes a prevalence of smoke in the business districts. The sulphurous element in soft coal smoke has a disastrous effect on silver and is injurious to gold. Gold 18k. fine is tarnished by smoke and thereby seriously injured. When gold of this degree of fineness is injured by smoke there must certainly be elements in the smoke which will injure almost anything. The action of smoke upon the precious metals is to form an oxide which is hard to remove and after removal the goods are not in the same condition as before cleaning. Gold is soft and it absorbs easily. Etruscan finished goods are especially susceptible to smoke. Silver of the best quality becomes copper colored when left for any length of time in contact with an atmosphere laden with smoke. One firm in Cleveland claims that their business is injured each year to the extent of at least \$2,500 on account of the smoke nuisance, while several firms are obliged to employ men to clean goods that have been affected by this agent. One of the results of the foregoing evil worked by the smoke nuisance is that many jewelers are chary of handling

the finest articles, as the goods displayed in their windows are never fit to be put back into stock except at reduced prices. The jewelers should combine with other dealers whose businesses are doubtlessly affected to their disadvantage by this nuisance, to devise some plan for its amelioration. Several cities once given over entirely to the use of soft coal are now employing natural gas with most beneficial results. Let other cities clouded with a pall of soft coal smoke follow suit when possible.

### The Week in Brief.

LAST rites were paid to the memory of George C. Shreve, San Francisco, Cal.—The death occurred of Rev. Sigmund Sorg, Mansfield, O.—John L. Vandiver, the Philadelphia Custom House broker, charged with fraud, was held for court—The store of R. H. Safford, Leominster, Mass., was burglarized—Parsons, Ide & Co., Peoria, Ill., incorporated—R. H. Ingersoll & Bro., New York, were allowed to reopen their World's Fair exhibit—The stock of the Puyallup Drug Co., Puyallup, Wash., was sold by order of the receiver—The store of F. C. Taylor, Alma, Mich., was burned out—Edwin B. Rogers, formerly a jeweler of Marshall, Mich., was killed from a fall—Jacob Lowenberg, charged with embezzlement by F. M. Sproehle & Co., Chicago, was released from jail—The H. F. Legg Jewelry Co., of Minneapolis, Minn., incorporated—The store of N. E. Gladwin, Essex, Conn., was burglarized—The monthly meeting of the American Horological Society was held—L. Strasburger's Son & Co., New York, filed a complaint against the Shader Mfg. Co., Chicago, and asked that a receiver be appointed for the company—The offer of settlement of Otto Baehr & Co., St. Louis, Mo., is being accepted by Providence manufacturers—The funeral of Wm. T. Barton, Providence, R. I., took place—A. W. Anthoine, Boston, Mass., and Lewiston, Me., is in insolvency—The Tudor Optical Co., Omaha, Neb., gave a bill of sale—The replevin suit of F. Kroeber Clock Co., New York, against Emma H. Cassal, Elmira, N. Y., was tried.—The store of J. W. Williams, King City, Mo., was burned out—The store of Geo. P. Rose & Co. was closed under a chattel mortgage.—Geo. P. Aiken, Brewer, Me., went into insolvency. The death of Zachariah Dederick, New York, occurred—An important decision in regard to design patents was rendered by the United States Court of Appeals—The store of W. S. Wager, Troy, N. Y., was robbed.

### W. H. Gleason Resigns as Receiver of Giles, Bro. & Co.

CHICAGO, Ill., Oct. 24.—W. H. Gleason resigned yesterday as receiver for Giles, Bro. & Co., and E. A. Giles was appointed in his stead. This action was taken on a bill of W. R. Alling and others to reduce expenses,

### New York Notes.

T. W. Graves has entered a judgment for \$347.93 against Edward Flatow.

Bartens & Rice have obtained a judgment for \$293.38 against Martin Disken.

The sheriff on Friday sold out the effects of Mendel Newman, 17 Ludlow St.

P. A. Frasse & Co. have obtained a judgment for \$197.56 against Emil Fox.

Geoffroy & Co. have obtained a judgment for \$269.61 against Daniel McKeever.

Justin Wertheimer has entered a judgment for \$1,100.85 against Irving L. Russell.

G. Preusser, Milwaukee, Wis., arrived from Europe last week on the *Kaiser Wilhelm II*.

The Gorham Mfg. Co. have entered a judgment for \$1,042.41 against Richard De Logerot.

Harry Lehr, 1 Maiden Lane, has given a chattel mortgage for \$1,177 on machinery to A. Chapelle.

Ann Champlain, 525 6th Ave., has given a bill of sale of jewelry fixtures to F. Shongard for \$370.

L. Strasburger, of L. Strasburger's Son & Co., arrived from Europe, Sunday on *La Champagne*.

A. J. Grinberg, of A. J. Grinberg & Co., accompanied by his wife, have been visiting the World's Fair.

Alfred Krower, of Albert Lorsch & Co., returned Saturday after a two weeks' visit to the World's Fair.

D. & K. Korones, 109 Madison St., have given a chattel mortgage on jewelry fixtures to M. Canton for \$265.

James M. Bloomfield, of R. Oliver & Bloomfield, was married last week to Miss Ann E. Lawley, of this city.

The annual dinner of the New York Jewelers' Association is announced to take place at Delmonico's, on Thursday, Nov. 23d.

The following judgments were entered last week against Tobias & Wolff by Hancock, Becker & Co. for \$171.99, and by G. Petri and others for \$384.50.

The gilt cap placed on the obelisk last week was made by Tiffany & Co., at their factory in Newark, N. J. It is of zinc heavily coated with gold leaf. It cost \$150.

The estate of the late Leroy B. Haff, who died Sept. 18th, is said to be valued at \$500,000. After two legacies amounting to about \$100,000 have been paid, the remainder is to be divided among two brothers and eight sisters.

Some thieves, who attempted to force an entrance into the jewelry store of J. A. Linherr, 103 Sixth Ave., on the evening of Oct. 17th, were frightened away by a burglar alarm, leaving their tools behind them. The thieves had forced the cellar door with a jimmy, and it is supposed that they intended boring through the floor of the store.

J. Clayton Johnson, who represented John Scheidig & Co. throughout the east and south, died suddenly in this city, Sunday, after a brief illness. The remains were

shipped to his home in Springfield, Mo., where the interment will take place.

Louis Neresheimer, of E. Aug. Neresheimer & Co., arrived from Europe Wednesday on the *Teutonic*. He reports the European diamond market to be very firm and prices on the advance.

The following judgments against Edward F. Sanford & Co. have been recorded as satisfied: By S. Greenbaum, assignee of C. Cottier & Son for \$6,240.96, entered June 27th; and by Thos. F. Gilroy, Jr., receiver of E. E. Kipling, for \$15,801.05, entered June 27th.

The suit brought in the City Court by the Columbian Time Recorder Co., against the American Watchman's Time Detector Co., which involved a disputed account for about \$2,000, has been discontinued without costs to either company. All differences have been amicably adjusted.

In group 96, Department of Manufactures, at the World's Fair, including carvings in wood, ivory and other substances, Tiffany & Co. have received an award for glass, sculptured, engraved, mounted in silver, metal carvings, chiseling in gold and silver, ornamented, carved, and stained ivory.

The suit of the Seth Thomas Clock Co. against Edward W. Curtis, which was tried before Judge Freedman in the Superior Court, Friday, resulted in a judgment for the plaintiffs for \$625.59. The action was to recover the value of goods sold in April, 1891, to Curtis, who did business under the name of the Manhattan Novelty Co.

Joseph F. Chattelier, of 860 Broadway, was married last Wednesday to Miss Frances C. Hull, of this city. The ceremony which took place at the residence of the bride's brother, in Meriden, Conn., was witnessed by only the intimate friends and relatives of the contracting parties. Mr. and Mrs. Chattelier will make their permanent residence at the Hotel Winthrop, 125th St. and Seventh Ave.

In the suit of Edward B. La Fetra, assignee of Charles Seale, against William Fair and John C. DeWolf, the motion of the plaintiff for an order compelling the defendants to give security for costs, was denied by Judge Patterson of the Supreme Court, Wednesday. The action is brought to recover \$7,500 damages, which it is alleged the plaintiff suffered from the action of the Sheriff, who acting under the defendants' instructions, seized \$7,500 worth of jewelry and other property on an attachment, while the assignee was in lawful possession.

The replevin suit instituted by the F. Kroeber Clock Co., 360 Broadway, against Emma H. Cassal, Elmira, N. Y., was tried before Judge Ingraham in Part III. of the Supreme Court, Oct. 17th, and judgment was rendered for the plaintiffs. In June and November, 1891, Chas. M. Cassal purchased two bills of goods from the F. Kroeber Clock Co. On Jan. 1, 1892, Cassal gave a bill of sale to his sister, Emma H. Cassal and the F. Kroeber Clock Co. six days later

replevied the goods. As a result of the suit the plaintiffs have entered judgment for costs amounting to \$166.97 against the defendant.

Isaac Swope & Co. last week obtained an attachment for \$573 against Wm. McKay Hoge, export and commission merchant, 35 Broadway, on the allegation that Hoge had disposed of his property with intent to defraud his creditors. Geo. H. Rosenblatt, 202 Broadway, recovered a judgment in the City Court for \$244.14 against Hoge, and an execution was issued to the sheriff. Hoge was not to be found at his office Friday. It was there stated that he had just returned from Baltimore, and would probably be down sometime during the next few days. Deputy Sheriff Young, who holds four judgments and one attachment against Hoge, has been unable to find any property on which to levy. Hoge's liabilities in the jewelry trade amount to about \$2,000.

Morris Hartman, 1631 Second Ave., reported to the police last week that he had been robbed under sensational circumstances. Among the goods stolen were some pledged diamonds worth about \$1,000, held by W. B. Lang, who, Hartman says, left them to be sold at the store against his (Hartman's) advice. Mr. Lang the following day obtained an attachment on which he seized the remaining goods. A motion to vacate the attachment was made before Judge Gildersleeve in the Superior Court, Saturday, and was granted. The police at first discredited Hartman's story, but after interviewing Benjamin Eichberg, of Eichberg & Co., by whom Hartman was employed for many years, and other jewelers of Maiden Lane who knew him, they came to the conclusion that the story was true, and will investigate thoroughly. Benjamin Eichberg, of Eichberg & Co., holds a chattel mortgage for \$1,000 on Hartman's stock.

J. M. Rossi, manufacturer of fine diamond mountings, 96 Fulton St., received a call from a loquacious young man Wednesday afternoon, who, saying that he was a dealer and had heard that Mr. Rossi did very fine work, asked to see some ring mountings. Mr. Rossi produced a tray containing rings worth about \$175. The stranger appeared well satisfied with the goods and asked to see some "made up." As Mr. Rossi started to get some rings from the other end of the room, the would-be customer grabbed the tray and rushed out of the door. Mr. Rossi quickly gave chase and would probably not have caught him had not the thief stumbled on the stairs and fell, scattering the rings. The thief then ran into an adjoining store where Mr. Rossi overtook and held him until an officer arrived. It was then discovered that the thief, Chas. Wilson, had broken his leg in falling. He was sent to the prison ward at Bellevue Hospital, Mr. Rossi recovered all but nine of his rings.

Eugene R. Muller, watchmaker with Cauey & Bradley, Batavia, N. Y., was married Oct. 21st to Miss Mary McGuinn, of the same place.

### Last Week's Arrivals.

**THE CIRCULAR** has perfected arrangements for obtaining the names and hotel addresses of all the latest buyers visiting New York, and each day posts in its office, 189 Broadway, a bulletin which every member of the trade is cordially invited to copy.

The following out-of-town dealers were registered in New York during the past week: W. Eaves, Montreal, Que., Broadway Central H.; A. E. Covell, Pawtucket, R. I., Astor H.; J. W. Gregory, Washington, D. C., Astor H.; H. S. Upson, Waterbury, Conn., Astor H.; C. Hellebush, Jr., Cincinnati, O., Imperial H.; E. M. Brandeis, buyer for J. L. Brandeis & Sons, Omaha, Neb., Broadway Central H.; H. F. Wichman, Honolulu, H. I., Belvedere H.; E. Benedict, Syracuse N. Y., Coleman H.; E. Roelm, Detroit, Mich., Broadway Central H.; J. R. Graves, Corry, Pa., Sturtevant H.; P. Lachicotte, Columbia, S. C.; J. P. Jones, buyer for J. N. Adams & Co., Buffalo, N. Y., 55 White St.; G. DeWolf, buyer for Danziger & Co., Pittsburgh, Pa., Vendome H.; M. Field, Chicago, Ill., Waldorf H.; G. Austin, Batavia, N. Y., St. Stephen H.; C. Vose, Boston, Mass., Gilsey H.; E. T. Jakeman, of Chapman & Jakeman, Norfolk, Va., St. Denis H.; W. H. Speck, Palatka, Fla., Gilsey H.; C. B. Targo, buyer for Root & McBride Bros, Cleveland, O., Marlborough H.; H. Eisenberg, buyer for Dives, Pomeroy & Stewart, Reading, Pa., 120 Franklin St.; C. Rochat, buyer for Smith & Murray, Springfield, Mass., Murray Hill H.; R. T. Polack, York, Pa., Astor H.; A. Paul, Boston, Mass., Marlborough H.; J. W. Field, Galveston, Tex., St. Denis H.; E. E. Abercombe, buyer for Coleman, Mead & Co., Murray Hill H.; J. F. Rule, buyer for D. McCarthy & Sons, Syracuse, N. Y., 258 Church St.; J. A. Haskell, San Francisco, Cal., Grand Union H.; A. H. Hilsman, Albany, Ga., Broadway Central H.; G. W. Sadtler, Baltimore, Md., Continental H.; J. C. Krull, Buffalo, N. Y., Sinclair H.; H. B. Ross, Calais, Me., St. Denis H.; C. H. Duhme, Cincinnati, O., Holland H.; W. D. Moses, Richmond, Va., Albemarle H.; J. H. Estes, buyer for Dreury, Hughes & Co., Richmond, Va., St. Denis H.; G. G. Robinson, Montreal, Que., St. Denis H.; C. E. Fisher, buyer for Wm. Donalson & Co., Minneapolis, Minn., 415 Broadway H.; C. E. Wigginton, buyer for Woodward & Lathrop, Washington, D. C., St. Denis H.; S. Caro, San Francisco, Cal., Coleman H.; T. Ryland, Lynchburg, Va., St. Denis H.; A. Field, Asheville, N. C., Astor H.

### Death of Carlos A. Hart.

HARTFORD, Conn., Oct. 24. — Carlos A. Hart, formerly of Alexander & Hart, jewelers, 8 State St., died at Providence, R. I., on Tuesday last, at the age of 60. About ten years ago he removed from this city to Providence, where he has since lived.

### Maiden Lane Jewelers Who Will Bowl.

The second series of games in the Jewelers' Bowling League, of New York, which were rolled at the Tremont Alleys, Oct. 17th, resulted in the following scores: Aikin-Lambert Jewelry Co., 394, vs. Keystone Watch Case Co., 446; Keystone Watch Case Co., 467, vs. N. H. White & Co., 527; Aikin-Lambert Jewelry Co., 467, vs. N. H. White & Co., 520. The third series were rolled last night between Jos. Fahys & Co., Hayden W. Wheeler & Co. and J. T. Scott & Co.

The schedule of games has been arranged as follows:

Oct. 31—Aikin-Lambert Jewelry Co. vs. J. T. Scott & Co., J. T. Scott & Co. vs. N. H. White & Co., N. H. White & Co. vs. Aikin-Lambert Jewelry Co.

Nov. 7—Hayden W. Wheeler & Co. vs. Keystone Watch Case Co., Keystone Watch Case Co. vs. Aikin-Lambert Jewelry Co., Joseph Fahys & Co. vs. Keystone Watch Case Co.

Nov. 14—J. T. Scott & Co. vs. Hayden W. Wheeler & Co., J. T. Scott & Co. vs. N. H. White & Co., Hayden W. Wheeler & Co. vs. N. H. White & Co.

Nov. 21—J. T. Scott & Co. vs. Jos. Fahys & Co., J. T. Scott & Co. vs. Keystone Watch Case Co., Keystone Watch Case Co. vs. Jos. Fahys & Co.

Nov. 28—Aikin-Lambert Jewelry Co. vs. Hayden W. Wheeler & Co., Aikin-Lambert Jewelry Co. vs. N. H. White & Co., N. H. White & Co. vs. Hayden W. Wheeler & Co.

Dec. 5—Jos. Fahys & Co. vs. Aikin-Lambert Jewelry Co., J. T. Scott & Co. vs. Jos. Fahys & Co., J. T. Scott & Co. vs. Aikin-Lambert Jewelry Co.

Dec. 12—Joseph Fahys & Co. vs. Keystone Watch Case Co., N. H. White & Co. vs. Keystone Watch Case Co., N. H. White & Co. vs. Joseph Fahys & Co.

Dec. 19—Hayden W. Wheeler & Co. vs. Aikin-Lambert Jewelry Co., Aikin-Lambert Jewelry Co. vs. Joseph Fahys & Co., Joseph Fahys & Co. vs. Hayden W. Wheeler & Co.

Dec. 26—Aikin-Lambert Jewelry Co. vs. J. T. Scott & Co., Keystone Watch Case Co. vs. J. T. Scott & Co., Aikin-Lambert Jewelry Co. vs. Keystone Watch Case Co.

Jan. 2—N. H. White & Co. vs. Joseph Fahys & Co., J. T. Scott & Co. vs. N. H. White & Co., Joseph Fahys & Co. vs. N. H. White & Co.

Jan. 9—Hayden W. Wheeler & Co. vs. J. T. Scott & Co., J. T. Scott & Co. vs. Keystone Watch Case Co., Keystone Watch Case Co. vs. Hayden W. Wheeler & Co.

Jan. 16—Keystone Watch Case Co. vs. Hayden W. Wheeler & Co., Keystone Watch Case Co. vs. N. H. White & Co., Hayden W. Wheeler & Co. vs. N. H. White & Co.

### The Display of Goods Tempted the Thieves.

SPRINGFIELD, Mass., Oct. 22.—L. B. Coe has been making a special window display of watches and diamonds lately and Saturday placed about \$2,500 worth of these articles in one of his show windows. He allowed them to remain there until he was about to close up, when he substituted some souvenir spoons and a number of pairs of fine opera glasses. He left them there over night.

About three or four o'clock this morning the window was smashed and the thieves walked off with twenty-two pairs of opera glasses and three souvenir spoons. The perplexing aspect of the case is as to how anyone could break a heavy plate glass window right in the heart of the city and with a policeman somewhere within a stone's throw, and not attract attention. The police have no clue to the thieves.

### Philadelphia.

J. K. Hirst visited New York last week.

H. Muhr's Sons are steadily increasing the force of men at their Broad St. factory.

E. J. Herty, 726 Chestnut St., is contemplating extensive alterations in his establishment.

P. J. Davis has made an elaborate improvement in the frontage of his Frankford Ave. store.

It is expected that L. P. White or his assignee will be in a position to render a statement of the affairs of the embarrassed house within a week or ten days.

Saverio Frolio, a watchmaker, aged twenty-five years, 920 Suffolk St., died in the Pennsylvania Hospital last Monday afternoon from the effects of a bullet wound inflicted, it is alleged, by Pasquillo Longo.

On Wednesday last, a man who gave his name afterwards as James Goddard, entered the store of Christian Kunz, 37 N. 9th St., and asked to look at a gold chain. As soon as he had it in his hand he skipped and Mr. Kunz followed in close pursuit. The man dodged into a drug store, but was caught and taken before Magistrate Pole, who held him in \$800 bail for court.

Francis P. Klemmer, jeweler, 723 S. 2d St., has been awarded \$4,000 damages against the Mt. Penn Gravity Railroad Co., of Reading, for injuries sustained in an accident on that road, Nov. 5, 1891. He sued the company for \$20,000 damages. The accident was one of the most serious in the history of mountain railroads, about twenty persons losing their lives. The crew lost control of the train and, jumping the track, it dashed into the side of the mountain. Mr. Klemmer had to have his skull trepanned, and was for a time partially paralyzed. Two of the fingers of his left hand are still in that condition, and his system has not yet entirely recovered from the shock.

### Canada and the Provinces.

J. Owens, Carberry, Man., has been closed out.

E. Scheuer, Toronto, Ont., is at the World's Fair.

Kate C. Dunn, jeweler, North Sydney, N. S., has assigned.

C. Clarkson, Rapid City, Man., has removed to Griswold, Man.

Henry P. Berg, of Montreal, has registered alone as the American Clock Co.

The stock of F. Roberts, Toronto, Ont., was sold recently and bought in by a judgment creditor.

Fred Schwob, son of M. Schwob, Montreal, and who has been connected with the New York house of Adolphe Schwob for the past year, is spending a short holiday in the Canadian metropolis.

It is announced from Ottawa that an Order in Council has been passed placing jewelers' sweeps on the free list when imported by Canadian refiners for the purpose of being refined in their factories in Canada.

### Providence.

E. O. Clarence is on an extended trip through the New England States.

The White Stone Jewelry Co. have succeeded Ettinger & Safford.

M. M. Eckstein, who recently started in business at 538 Broadway, New York, has been in town purchasing stock.

Hamilton & Hamilton, Jr., report that their business is improving and the prospects for the holidays are very encouraging.

John B. Wren, of the Jewelers' Mercantile Agency, has returned from his trip to the World's Fair.

B. L. Hall has placed an attachment amounting to \$800 upon the property of Joseph M. Briggs.

John E. Leonard, engraver, 32 Wood St., has designed a handsome and appropriate *Vigilant* souvenir spoon.

Charles H. Woodward, formerly with Herman Ockel, has started in the retail business at 5 Weybosset St.

It is currently reported that Fred. I. Marcy is negotiating to re-enter the manufacturing jewelry business.

Assignee Robert Burbank started a special sale of the stock of H. C. Whittier & Son, on the 16th inst., to be continued for two weeks.

Charles E. Hancock, of Hancock, Becker & Co., is prominently mentioned by the Republicans as a candidate for election as councilman of his ward.

R. G. Shutz, formerly salesman for J. W. Grant & Co., has accepted a position as traveling representative for Louis Mann & Co., 116 William St., New York.

Walter A. Griffith has recently been elected to the office of adjutant of the 2d Battalion, 1st Regiment of Rhode Island Uniformed Rank, Knights of Pythias.

John W. Chase has started on an extended tour through Canada and the west in the interest of the refining concern of H. F. Carpenter.

Edward E. Goff, with Tilden-Thurber Co., was married recently to Miss Helen Foillette. Among the numerous gifts was a handsome banquet lamp, from the employes of the concern.

The fiftieth anniversary of the wedding of Mr. and Mrs. Edmond Huestis was celebrated at the residence of their son, Harvey

Huestis, of Hutchison & Huestis, 49 Whitmarsh St., last Wednesday evening.

The offer recently made by Otto Baehr & Co., St. Louis, Mo., of thirty-five cents on the dollar, is being generally accepted by the creditors. Local manufacturers are interested for about \$2,500.

John Pickering, for many years in charge of the plating department of the Waite, Thresher Co., and his son, Thomas Pickering, have started in the plating business at 99 Friendship St., as The Pickering Electro Plating Co.

The funeral of William T. Barton, brother of Nathan B. Barton, of Ostby & Barton Co., and formerly connected with that firm, took place last week. He had been ill less than a week and his sudden death was a shock to his large circle of acquaintances. Deceased was thirty-four years of age, and leaves a widow and two children. Mr. Barton died on the 16th inst. at the Rhode Island Hospital.

Among those who have recently returned from business and pleasure trips through the west are: J. W. Grant, of J. W. Grant & Co.; George L. Vose, of G. L. Vose & Co.; Charles L. Kettlely, of Marden & Kettlely; S. M. Knowles, of J. B. & S. M. Knowles Co.; Isaac M. Potter, of Potter & Buffinton; Frank T. Pearce, of F. T. Pearce & Co.; Ansel L. Sweet, of G. B. Willis & Co.; Charles H. Cooke, of C. H. Cooke Co.; Everett L. Spencer, of E. L. Spencer & Co.; W. O. Clark; W. H. Waite; and William C. Gleason, of Grover & Gleason.

### Boston.

A. W. Anthoine is in insolvency.

Nathan Bear has given a chattel mortgage for \$3,000.

A. J. Applegate, Main St., Cambridgeport, is offering his creditors twenty cents on the dollar. The Boston creditors are disposed to accept.

Among the pilgrims to Chicago from the Boston trade last week were: Manager Rufus B. Carr, E. Howard Watch & Clock Co., Charles F. Morrill, Morrill Bros. Co., James C. Donnell, Ripley-Howland Mfg. Co.

J. H. French, the jewelers' auctioneer, will shortly sell the remainder of the stock of William J. Knowlton, 168 Tremont St., which has been for some time in the possession of Messrs. Humphrey and Guild, who

had claims against the concern amounting to several thousand dollars.

A. W. Authoine, jeweler, Boston, Mass., and Lewiston, Me., is financially embarrassed. His liabilities are about \$10,000, and the assets consist of stock and fixtures in Lewiston mortgaged for \$3,600, and stock and fixtures in the Boston store mortgaged for \$600, together with some book accounts.

### Newark.

On Monday last burglars entered the residence at 1,072 Broad St., of George Kremetz, of Kremetz & Co., by forcing a rear cellar window. They stole some clothes, and several small pieces of silverware. It is believed that three men were concerned in the robbery.

A. D. Selover has begun suit against the proprietors of the *Daily Advertiser*, for \$10,000 damages for publishing an article stating that he had assigned with liabilities of \$22,000. Mr. Selover states that he is perfectly solvent and that the report circulated by the *Advertiser* is groundless.

### Syracuse, N. Y.

Assignee Scott Owen has opened the sale of the bankrupt stock of Frank H. Wells.

Charles H. Seymour, of Jos. Seymour Sons & Co., has returned from a successful western trip including St. Louis and Chicago, where he visited the Fair.

Among the traveling men noticed in Syracuse the past week were: Frank E. Davis, Hayden W. Wheeler & Co.; W. H. Brown, Wilcox Silver Plate Co.; Geo. S. Pollitz, Rice & Hochster; W. S. Campbell, Day & Clark; J. D. Beacham, Carter, Sloan & Co.; E. P. Hutton, Geoffray & Co.; A. Pinover, A. Pinover & Co.; J. N. Beckwith, Jos. H. Fink & Co.; M. H. Mason, Mason Jewelry Co.; F. S. Sherry, Jos. Fahys & Co.; Mr. Simons, Stern Bros. & Co.; C. H. Carpenter, Parsons & Green Co.; C. B. Lawton, Dennison Mfg. Co.

### Springfield, Mass.

George Moore has resigned his place in E. S. Brooks' jewelry store, Palmer, to accept a similar position in Hartford.

Among the jewelry salesmen who stopped in Springfield last week were: Vincent Henderson, Enos Richardson & Co.; Mr. Medbary, F. M. Whiting & Co.; and Robert B. Wallace, R. Wallace & Sons Mfg. Co.

The watch and diamond club cases against Daly & Fitzgerald and L. B. Coe, respectively, will not come up at this term of court.

Charles S. Saxton, formerly in the jewelry business in this city, has filed a plea for divorce from his wife, Josephine, and the trial will be heard sometime during the March term of court. In his bill of complaints he charges her with adultery on various occasions; he accuses her of excessive cruelty and further of "gross and confirmed habits of intoxication from the voluntary use of opium."

\*  
SPECTACLE  
LENSES  
A  
SPECIALTY.  
\*

ALBERT BERGER & Co.,  
47 MAIDEN LANE, N. Y.

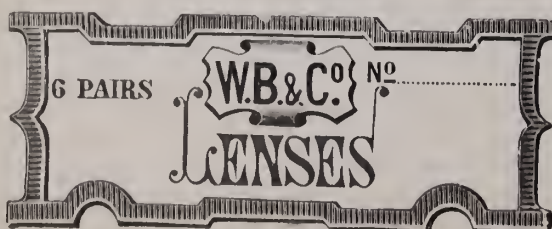

\*  
SPECTACLES  
AND  
OPTICAL  
GOODS.  
\*

As Regards

SILVER PLATE

WE BELIEVE

THAT an Honest article at an Honest price goes further toward making sales than all the advertising in Christendom,

AND WE WORK ACCORDINGLY.

MAKING and SELLING a BETTER Article for the SAME MONEY, or an EQUAL Article for LESS Money than any other concern, is the principal cause of our fast increasing business.



754.—CUP.

HOMAN & COMPANY,

CINCINNATI.

---

 Visitors to the Columbian Exposition, Remember our Complete Line is displayed at  
155 STATE STREET, CHICAGO.

---

**BAUME & CO.,** 

21 HATTON GARDEN, LONDON, ENGLAND,  
AND SWITZERLAND.

EXHIBITORS AT CHICAGO OF 

**TOURBILLION CHRONOMETER WATCH,**

WHICH HOLDS THE RECORD AT ROYAL OBSERVATORY KEW.

---

HIGH CLASS SWISS WATCHES, PLAIN AND COMPLICATED.

PATENTEES FOR SPLIT SECONDS CHRONOGRAPHS (Treble Action.)

---

AGENT FOR U. S., GEO. E. WILKINS, SYRACUSE, N. Y.

# The Wadsworth Watch Case Co.



Filled



Cases.



General Offices,  
NEWPORT, KY.

Chicago Office,  
COLUMBUS BUILDING.

## JUERGENS & ANDERSEN COMPANY,

DIAMONDS AND MOUNTINGS,

Order Work a Specialty.

125-127 State St., Chicago.

### ALBERT H. BONNET,

ONLY EXCLUSIVE WHOLESALE JEWELRY HOUSE IN OHIO.

COLUMBUS, WALTHAM, ELGIN, HOWARD AND STANDARD WATCHES,  
GOLD AND FILLED CASES, JEWELRY, CHAINS, CLOCKS.

FULL LINE OF TOOLS AND MATERIALS.

No. 24 E. SPRING STREET,

COLUMBUS, OHIO.

### THE FINEST OILS EXTANT:



\$1,000 CHALLENGE FOR THEIR EQUAL.



CHICAGO OFFICE: ROOM 308, INTER-OCEAN BUILDING.

VOL. XXVII.

CHICAGO, WEDNESDAY, OCTOBER 25, 1893.

NO. 13

FRENCH ART IN SILVER AT THE WORLD'S FAIR.

A HALF century ago Charles Christofle became the owner of the French and English patented processes of electro-chemical gilding and silvering, and established in France the electro-plate industry. The method of coating baser metals with those of greater value was at that time announced to the Academy of Sciences by J. B. Dumas, an illustrious chemist, as "a

awarded them in the expositions of 1844, '49, '55, '62, '67, '73, '78, '81 and '89. At the World's Columbian Exposition the prominence of their display arrests attention and an examination of the wares discloses a high

them being a complete table service in repoussé chased silver in the style of the seventeenth century from designs by M. Joindy. The set consists of an oval soup tureen forming the centerpiece, a six-light girandole, warmers, dishes, vegetable dishes, sauce boats, ice pail, caret jugs, bread baskets, salad bowl, cruet frame, pepper box, mustard pot, silver gilt dessert plates,



JARDINIERE IN RENAISSANCE STYLE. WORLD'S FAIR EXHIBIT OF CHRISTOFLE & CO.

new art of the greatest importance, for it conduces to render general the enjoyment of a most rational luxury."

From that day to the present the advance of the house has been one of unbroken successes. Grand prizes, gold medals, crosses and medals of honor, and knighthood were

conception in design and merit in modeling that could only be produced by eminent artists in metal work. Whether the piece be large or small the same nicety in detail is apparent.

Numerous pieces of table plate and *objects d'art* fill places of vantage, notable among

knives and forks, and several small pieces.

An attractive two-shelf tea-table was composed by Henry Zodin and modeled by Mallet. It is in silvered bronze and supports a tea service in repoussé chased silver, with tray, cake plates and cups in Sevres porcelain. Two sterling 5 o'clock tea ser-

vices of five and four pieces respectively, have each a fountain in silvered plate. One on an enameled table, is modeled in the form of the Patisson of America, the other in the form of a Brazilian gourd.

In their decoration of sweetmeat and flower vases the processes used enable the firm to reproduce in most minute detail the delicate tracery of leaves and other natural objects. By their method, plants, flowers and foliage struck on the surface of the metal print the trace of their silhouette upon it. Surfaces thus decorated are afterwards enhanced by colored gold and platina which set off all the magic of nature. Fine examples of repoussé chasing are shown in four coffee services: one in arabesque style modeled by Levillian, a Renaissance by Cheret, one with frieze of children by Carrier-Belleuse, and a Louis XVI. by Cheret. Nearby is a coffee service in solid silver and translucent enamels.

In tea services there is a Carrier-Belleuse of six pieces with decorative figures and the handles of the tray formed of two children. From other modelers are shown a tea service in the form of aranas, and one with chrysanthemums in relief on forms made by the lathe and on hammered grounds. Of special interest in plated wares are three surtouts and two glass trays supporting epergnes, etc. The surtouts are in Renaissance, Louis XV. and Regence styles. In the Renaissance the epergne is in the form of a jardiniere with friezes of children, and

illustrates the Triumphs of Gastronomy.

The two jardiniere at the end of the table have figures of Music and Dance, and the candelabra have a round of children dancing. Two figures of women form the handles of the Louis XV. jardiniere and a Louis XV. frame supports a glass tray. The candelabra have figures of athletes and the various stands and plates have groups of children. These were composed by Mallet and Mathurin Moreau. The Regence bears on the epergne the four parts of the world by Mallet, and figures by Lafrance and Moreau. The candelabra bear figures of Naiades by Hiolle and Mallet, and groups of children decorate the stands and plates. The glass trays support an epergne or jardiniere, candelabra and sweetmeat vases—one in figures and the other of celery form.

In current objects of electro-plate there are shown special designs for hotels, dining rooms and coffee houses, specimens of designs supplied to the great French and foreign navigation companies, and fifty-two patterns of spoons and forks made by Christofle & Co. for the French and foreign markets. The production of the St. Denis works is 240,000 dozen spoons and forks a year. Paul Christofle and Henry Bouilhet, directors, and Fernand Ch. de Ribes and Andre Bouilhet, co-directors, form the board of management and at the St. Denis and Paris works employment is given to 1,600 hands, 300 of whom are women.

#### World's Fair Awards to Foreign Jewelers and Silversmiths.

The awards to foreign houses in Group 98, Department of Manufactures, including jewelry and ornaments are given below. The awards of American firms have already been announced in THE CIRCULAR.

*Great Britain.*—London.—Goldsmiths' and Silversmiths' Co., gold caskets; Mappin Bros., gold caskets; Goldsmiths' and Silversmiths' Co., jewelry. Glasgow.—Nielson, Shaw & Macgregor, Highland ornaments. Dublin.—Edmond Johnson, collection of reproduction of famous gold and silver antiquities of Ireland. Belfast.—Gibson & Co., diamonds. Bantry, Ireland.—Mrs. Ernest Hart, jewelry, goldsmith's and silversmith's work.

*Italy.*—Naples.—Meriona Lubriola, cameo, lava; Rocco Marabito, jewelry, tortoise shell coral, cameo; A. Decara, jewelry, tortoise shell ornaments, canes, coral, lava, fans; Rocco Morabito, lava; Glucinto Mellilo, jewelry, reproduction of Pompeii silverware; Metteo Toledo, jewelry, cameo ornaments, coral, lava; Michael Riscione, jewelry, coral, cameo, lava; Vincent Enico, jewelry, coral, cameo. Rome.—Leopold Poliasier, jewelry of antique patterns; W. Brugo, objects of worship; P. de Felici, cameos, Roman jewelry; Negri & Co., jewelry; Fudine Fasoli, jewelry, cameo. Florence.—Pietro Tappori, jewelry; O. Caziozi, jewelry. Leghorn.—Banjani Moria, corals. Genoa.—Egisto Sivilli, silver filigree work; Nicoli Paroda, silver filigree work.

*Canada.*—Ottawa, Ont.—C. P. Willimot & Co., cut Canadian gems; C. P. Willimot & Co., Canadian agate ornaments.

*Switzerland.*—Bienne.—Adamard Chopard, engraving. Geneva.—J. Ferrere, jewelry enamel; A. Glaton, jewelry enamel.

*Siam.*—Bangkok.—Government of Siam, collection of ancient jewelry used by nobility 200 years ago; enamels, different colors; Siamese pagoda type national decoration, collection of gold ornaments.

*Denmark.*—Copenhagen.—A. Michelson, jewelry, gold and silver ware; Bernhardt Hertz, goldsmith's work. Horsens—Raamie Jensen, enamel and goldsmith's work.

*Japan.*—Tokio.—Takijiro, Kussutani, bracelet, cuff buttons, breastpin, jewelry; Manzaburo Muranatan, watch chain, gold work; T. Miyata, jewelry; M. Maramatsu, metal work, silver and gold. Toyama.—S. Mikai, metal work. Mamamoto.—H. Kugitani, gold, silver and iron watchchains; F. Tawabe, gold and silver watch chains. Tokyo.—X. Takaki, ornaments, crystals and medals.

*Germany.*—Eneuend.—Wilhelm Binder, jewelry and ornaments in silver and gold; Erhard & Sohne, jewelry and ornaments in silver and gold. Pforzheim—Carl Bornett, jewelry and ornaments in silver and gold; Carl Dilliniue, jewelry and ornaments in silver and gold; Ph. Doppenschmidt, jewelry and ornaments in silver and gold; H. P. Drews, jewelry and ornaments in silver and

## HIGHEST AWARD WAS OBTAINED

AT THE COLUMBIAN EXPOSITION

BY OUR

# Musical Boxes



## JACOT & SON,

298 Broadway, - New York.



Send Business Card for Large Illustrated Catalogue and Trade Prices.



gold. Jewelry and ornaments: Louis Fiesslen & Co., Gauss Gabruder, Ludwig Grossman, F. W. Harm, Hirschmann & Koch, J. S. Kahn, Emil Ernest Katz, August Kiehle, Louis Kuppenheim, Lauer & Binder, F. Mahln, A. Pantlen, Adolph Pegan, Paul Suedes, Ernst Unterecker, Wild & Co., Wimmer & Reith, Ed Winter & Co., Albert Wittum, Wilh. Stoeller, E. Zerrener, F. Schultz, Heinrich Schultz, O. Grosse. Hanau B. Neresheimer, Ochs & Born, Ott & Co., Schuettner C. K. Kurr, Ch. R. Kiesling, Fr. Kreueter & Co., Steinheuer & Co., J. D. Schlessner & Sohne, Gloser Gebruder, C. Hertel & Sohne, E. G. Zimmermann A. Grubener. Munich: G. Merk, Karl Blum, Rhein & Co., Gross Anheim, George Ehhi, Stuttgart: Ph. C. Fried, Keller Son. Oberstein, Peter Crauth; Hettstein, Martin Lange; Berlin, Levin Gebruder; Braunsweig, Martin Mayer; Mayence, S. Garten & Corrup, Neugruna Aritz Blaze, Schwaeb Gmuend—Gustav Hauber, Ottman Zicher, Soeryl & Stottmeyer, Ed Wochler, Ludwig Paar. Karlsruhe: Johann Georg Schulz, Birkenfeld, E. Schurmann & Co., Frankfurt; Johann Georg Schulz, Birkenfeld, agates, onyx, jasper ornaments for the person: Holerweher Schaper, Berlin, chain of office of the mayor of Strassburg; Pelge, court jeweler, Berlin, copies of pre-historical gold work, ex. in German Village.

*Norway.*—Christiana.—David Anderson, jewelry; J. Tostrup, jewelry. Bergen.—M. Hammer, jewelry.

*Russia.*—St. Petersburg.—G. Hahn, jewelry and precious stones articles; J. V. Stomin, cut gems, cut hard stones; A. K. Dalman, turquoise ware jewelry, enameled filigree. Moscow.—Cohunkoff, gems. East Katherinburg—Ovehinnikoff Bros., importers and polishers of precious hard stones. Liban—T. T. Furst, amber articles. Warsaw.—Burnstein Bros., amber. Vologda.—Vologda perpetual country industrial exhibit jewelry boxes.

*Austria.*—Vienna.—Franz Schlechta, genuine precious stones and gems; Franz Schlechta, imitation precious stones and gems; Johan Tresnak, garnet jewelry; Ben-

edict Sailer, tortoise shell and horn ornaments; Rudolf Furtner, buttons and fancy ware in mother of pearl, ivory, and tortoise shell; J. Bacher & Son, jewelry in gold and pearls; Victor J. Wachtel, specialties in mother of pearl goods; Lewis Politzer, gold and silver mounted jewelry; M. Kursch, Prague, garnet jewelry; Philip Fischer, Carlsbad, ornamental stones; Turlet & Bardach, Vienna, jewelry; Adolph Emil Langer, Landskron, Moravia, various kinds of jewelry. Prague.—Joseph R. Gerlitzky, garnet jewelry; Michael Goldschmidt, garnets; Jira Franz, garnet goods; D. Kaminsky, garnet jewelry.

*Haiti.*—Y. K. Garcia, Port au Prince, scarf pin and brooches.

*British Guiana.*—Coolie Colonist, Georgetown, gold and silver ornaments.

*Paraguay.*—Bopez, Alejandro, Ascencion, gold rings.

*Curacao.*—Curacao Commission, Curacao, gold pins, earrings, and rings.

*Ottoman Empire*—Constantinople—Tchiboukosean & Co., forty-four awards, silver-gilt photo frames, silver-gilt vase, silver-gilt cup and saucer, watch fobs, bracelets, scarf pins, brooches, cuff buttons, knife and fork, spoons, penknives, match boxes, chatelaine gilt and silver, bracelet silver gilt, chatelaine silver gilt, cuff studs, silver gilt, brooch Sultana monogram in diamonds; gold cigarette case, set in diamonds; watch stand, silver gilt; cigarette case silver gilt; cigar-

ette case, enameled Turkish coat of arms; tea set, silver ornamented china; water set, silver ornamented crystal; brooch, Turkish coat of arms; coffee cup and stand, silver gilt; teaspoon, silver gilt and enameled; brooch, silver gilt and enameled; brooch, silver gilt and enameled, two awards; scarf pins, silver gilt, two awards; pocket knife, silver gilt, two awards; one tea set, "Haindie," porcelain silver ornaments, plateau porcelain silver ornamented. B. Bargnes, porcelain silver, ornamented, pair vases, crystal ornamented silver; water set, crystal ornamented silver; cup and saucer, porcelain ornamented silver, two awards; silver gilt candle shade, silver gilt hand mirror; L. Zanotti, engraved ring stones. Province of Trebizond—Nine awards—Silver shirt studs, silver thimbles, silver filigree belt, silver scarf pins, gilt silver belt, silver bracelets, silver purse, filigree coffee cup holders. Province of Syria—Seven awards Filigree necklace, filigree scarf pin, silver earrings, silver finger rings, filigree coffee cup holder, wooden pipes adorned with gold wire, silver bracelets. Province of Diarbekir—Six awards—Silver brandy cup, filigree coffee cup holder and saucer, silver bracelet with bells, silver bracelets, filigree silver belt, silver-coated wine cup. Province of Sinope, four awards—Filigree coffee cup, holder and saucer, filigree belt, filigree bracelet, silver cuff studs. Province of Kars—Brass inlaid ebony canes.



# GIBSON HOUSE,

CINCINNATI, OHIO.

ABSOLUTELY FIRST-CLASS AMERICAN PLAN HOTEL.

\$3.00 PER DAY.

Extra Charge for Parlors and Rooms with Bath attached. The unequalled advantages in central location, liberal management, modern appointments, experienced service and perfect cuisine, have permanently established the Gibson House as The Most Popular First-Class Hotel in Cincinnati.

AMPLE VAULTS FOR THE PROTECTION OF VALUABLES.

THE GIBSON HOUSE CO.,

H. B. DUNBAR

President and Manager.

## IRONS & RUSSELL,

(SUCCESSORS TO CHARLES F. IRONS.)  
MANUFACTURERS OF

SOLID GOLD **EMBLEMS** ROLL PLATE  
PINS, CHARMS AND SOLID GOLD RINGS.

102 Friendship Street, - - Providence, R. I.



## Gold Plated Enamel Tableware,

ABSOLUTELY NEW.

control the line of Gold Plated Enamel Ware, including Coffee, Tea, and thirty varieties of larger Spoons. These are beautiful goods and at a price that places the Enamel Ware within the reach of all, for practical use. Designs and finish equal to Sterling Silver Enamel Goods. Send for samples.

## SOPHUS SAMSON,

ROOM 802, COLUMBUS MEMORIAL BUILDING,  
CHICAGO, ILL.

H. B. BOLSTAD.

J. H. NIGHTINGALE.

WATCH CASE MAKERS AND REPAIRERS.

## H. B. Bolstad Plating Co.

GOLD AND SILVER PLATERS.

DESIGNING AND ENGRAVING.

170 Madison Street, - - CHICAGO.

## JEWELERS.

We guarantee to sell you Sterling Silver Flat Ware at a less price than any other manufacturer, and give you newer designs.

We will increase your profits if you will let us. Is it not worth trying?

OVAITT & WARNER, Silversmiths,  
PORTLAND, OREGON.

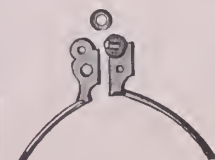

Racine Jewelry Mfg.  
CO.,  
SPECTACLE TEMPLE

WASHERS,  
Gross in a Bottle, 25c.

For Sale by Dealers in Jobbing Materials

## Chicago.

Out-of-town buyers in Chicago and visitors at the Fair last week included:

H. M. Heckart, Springfield, Mo.; Ira A. Smith, York, Neb.; Geo. W. French, Sparta, Mich.; R. H. Moorehouse, Council Grove, Kan.; E. A. James, Brandon, Wis.; Chas. M. Rowe, Corkeysville, Md.; J. C. Bradley, Camden, Mich.; Jas. S. Rice, Ashland, Kan.; Arthur M. Field, Ashville, N. C.; H. Post, Decatur, Ill.; F. E. Hall, Fulton, Kan.; J. C. Schwaller, Halbur, Ia.; Geo. B. Woodruff, Winsted, Conn.; Lew Arntz, Des Moines, Ia.; A. H. Kent, Mt. Clemens, Mich.; H. D. Burghelm, Indianapolis, Ind.; S. C. Butterfield, Elk Point, S. D.; G. A. Wettstein, Negaunee, Mich.; J. E. Overton & Co., Port Jefferson, L. I.; J. D. Taylor, Logansport, Ind.; T. O. Christian, Owosso, Mich.; L. E. Stevenson, St. Joseph, Ill.; A. S. King, Osgood, Ind.; Fred D. Van Norman, Springfield, Mass.; J. G. Leroy, Monroe, La.; G. G. Case, Jackson, Mich.; Otto Barresen, Hancock, Mich.; Frank W. Wightman, Vassar, Mich.; W. F. Clearwater, Winterset, Ia.; H. Lay, Beaven Hillsboro, Md.; W. N. Bratt, Washington, Ill.; John H. Smith, Baltimore, Md.; Ed. Dery, Kokomo, Ind.; H. Jost, Remsen, Ia.; Otto Rink, Carlyle, Ill.; Luther McCain, Delphi, Ind.; E. H. Fisher, Elyria, O.; W. J. Ett, Nebraska, O.; Chas. B. Bargman, Toledo, O.; E. C. Carpenter, Ireton, Ia.; T. I. Lewis, Moorhead, Minn.; M. H. Woodhull, Riverhead, N. Y.; Geo. A. Howell, Albany, Mo.; D. H. Grove, Tipton, Ind.; Jno. J. Stott, Osawatomie, Kan.; E. S. Fishback, Washington, C. H., O.; Neiswanger & Shambaugh, Xenia, O.; Henry A. Winn, Newman, Ill.; G. W. Bartlett, Lansing, Mich.; M. Schmitz, Parsons, Kan.; M. J. Stout, Summit Hill, Pa.; J. Bolland, St. Louis, Mo.; M. S. Weand, S. F. Myers & Co., New York; M. Scheinfeldt, Boston, Mass.; H. A. Barker, Westfield, Ind.; W. W. Hunter, Bloomington, Ill.; Lambert Bros., New York; W. E. Smith, Bellefontaine, O.; C. B. Tousey, Ft. Atkinson, Wis.; C. B. Von Kanel, Massillon, O.; C. B. Coffin, Ord, Neb.; M. H. Call, Lisbon, N. D.; J. H. Zimmermann, Prairie du Chien, Wis.; E. L. Hein & Co., St. Paul, Minn.; Nat. I. Durlach, New York; H. W. Wilson, Clay City, Ind.; A. L. Liggett, Slater, Mo.; W. H. Mudford, Sidney Centre, N. Y.; Glenn & Co., Morrilstown, Tenn.; A. H. Cathcart, Marshall, Mich.; Baumgartner Bros., Cissna Park, Ill.; R. Russell, Hamilton, Ont.; E. A. Wells, Utopia, N. Y.; Frank Abeytia, Socorro, N. M.; John A. Groh, Metamora, Ill.; William W. Fairchild, New York; Frank E. Burt, Angola, Ind.; F. F. Kraus, Cleveland, O.; Ben Salick, Plainville, Neb.; H. S. Tanner, Providence, R. I.; Mr. Young, Fort Wayne, Ind.; G. E. Twombly, Saco, Me.; Walter F. Zietz, Helena, Mont.; T. R. Pancoast, Hastings, Mich.; F. M. Thrasher, Rochester, N. Y.; Mr. Roberts, Pleasant Plain, Ia.; J. H. Ralston, Goshen, Ind.; Jesse Goldberg, with Amberg & Co., Cincinnati, O.; Larson & Co., Madison, Wis.; J. Linnenbrink, Rochester, Pa.; Allan Jillson,

Milford, Neb.; J. L. Davison, Mason City, Ill.; George Newhouse, Columbus, Neb.; J. A. Wiedemann, El Dorado, Kan.; Henry A. Bromberg, Battle Creek, Mich.; J. J. Heath, Lansing, Mich.; Straus-Grob J. Co., Belleville, Ill.; S. Joseph, Des Moines, Ia.; Louis Lange, Cincinnati, O.; P. J. Smith, Cumberland, Md.; C. S. Vail, Rock Rapids, Ia.; S. W. Brown, Beatrice, Neb.; E. B. Gregory, Washington, D. C.; Britton Bros., Lindsay, Ont.; O. G. Cady, Linnens, Mo.; Mr. Hale, Lima, O.; J. L. Hutchinson, La Porte, Ind.; Chas. W. White, Buffalo, N. Y.; C. A. Smith, Farmington, Ill.; R. B. Smith, Baltimore, Md.; P. Brunet, Quebec, Can.; John H. Keeler, New Haven, Conn.; E. A. Goodale, Lenox, Ia.; J. C. Northway, La Porte, Ind.; G. A. Lockwood, Charleston, Ia.; L. A. Herrick, Viroqua, Wis.; W. D. Spayth, Toledo, Ia.; Coris Anderson, Moorhead, Minn.; James Kearney, Medina, N. Y.; H. L. Long, Milwaukee, Wis.; J. H. Hollister, Green Bay, Wis.; Will C. Donnelly, Cumberland, Md.; I. G. Mines, Wayne, Neb.; P. K. Wiser, Mankato, Minn.; F. P. Carter, Smithbridge, Mass.; H. B. Harper, Kansas City, Mo.; J. W. Davis, Toronto, Ont.; L. T. Limpert, Ann Arbor, Mich.; E. O. Thompson, Waterville, N. Y.; J. Clifford Miller, Cincinnati, O.; J. R. Mercer, Kansas City, Mo.; J. Schwab, Hermann, Mo.; L. F. Hurd, Lee, Mass.; C. F. Hoffmann, Reynoldsville, Pa.; A. E. Richardson, Eaton, N. Y.; Will H. Beck, Sioux City, Ia.; J. W. Smith, Germantown, Pa.; C. Tiffany, South Manchester, Conn.; W. H. Replage, Shenandoah, Pa.; Hiram Chase & Son, Belfast, Me.; C. B. Jacquemine, Council Bluffs, Ia.; L. J. Korsted, Zumbrota, Minn.; Wm. Loofbourow, Monroe, Wis.; Chas. F. Hill, Middle Branch, O.; C. N. Hill, Dayton, O.; H. F. Johnson, Wittenberg, Wis.; McCain Luther, Delphi, Ind.; H. C. Leichi, Fort Madison, Ia.; C. B. Buhner, Evansport, O.; L. Burnett, St. Joseph, Mo.; Joseph J. Carr, Suspension Bridge, N. Y.; W. A. Warrington, Des Moines, Ia.; C. H. Nerbovig, St. Charles, Minn.; S. T. Crarl, Mason City, Ill.; Wm. T. Todd, Portland, Me.; F. Warren Johnson, Washington, D. C.; Henry Doelle & Son, Yale, Mich.; Ed. C. Kraehmer, Tomah, Wis.; John Marsh, Antwerp, N. Y.; John Schmid, Cincinnati, O.; S. C. Burnham & Co., Janesville, Wis.; Claude D. Lovejoy, Manchester, N. H.; J. T. Nace, Hamburg, Ia.; M. E. Cooke, Burlington, Col.; J. H. O'Daniel, Gloucester, O.; O. E. Berry, Boston, Mass.; J. W. Forney, Steubenville, O.; Mr. Gluck, Dodge City, Kan.; W. S. Evans, Hiawatha, Kan.; W. C. Davis, Elkhart, Ind.; E. F. Davis, Mitchell, Ont.; Chas. F. Wilde and Arthur B. Eglinger, Milwaukee; John Tripp, Son & Co., Leslie, Mich.; I. D. Southworth and C. F. Prescott, Batavia, N. Y.; E. H. Lawrence, Luzerne, N. Y.; L. M. Smith, Pittsburgh, Kan.; Aug. Youngerman, Davenport, Ia.; S. Sichel, of Eichberg & Co., New York; J. J. Sweeney, Houston, Tex.; Henry Horman, Jr., Madisonville, O.; Bryant & Stickle, Andover, S. D.; J. Darcy Warren, Kalamazoo, Mich.; Tom Morris, Crookston, Minn.; D. P. Young, What Cheer, Ia.; J. M. Runyan, Sabina, O.;

F. Haberl, Denver, Col.; W. H. Flower, Muir, Mich.; Myron T. Moore, Auburn, N. Y.; E. L. Hough, Ypsilanti, Mich.; C. T. Loudon, Gorham, N. Y.; Fred E. Williams, Augusta, Wis.; N. J. Eddy, Portland, Mich.; Frank N. Colwell, Matteawan, N. Y.; I. D. Rowland, Van Wert, O.; W. S. Still, Delaware, Ill.; W. A. Quinlan, Pavilion, N. Y.; T. W. Barr, Wadistown, W. Va.; R. S. Patterson, Port Huron, Mich.; W. G. Landes, Shelton, Ill.; A. Straus, New York; C. E. Dodge, Walnut, Ill.; W. E. Fenestemaker, Soloman City, Kan.; A. E. Bocks, San Jose, Cal.; J. J. Downey, Atlanta, Ill.; J. J. Carr, Niagara Falls, N. Y.; F. P. Carter, Southbridge, Man.; G. A. Wettstein, Monroe, Wis.; R. R. Ridley, Bettsville, O.; A. J. Leach, Karson, Minn.; Walter Sperling, Seneca, Kan.; J. H. Gies, Pittsburgh, Pa.; E. J. Ingersoll, Carbondale, Ill.; Isaac H. and Wm. J. Clothier, Philadelphia, Pa.; Wm. B. Joseph, Hudson, N. Y.; W. N. Coppersmith, Frankfort, Ky.; P. M. Childress, Valdosta, Ia.; E. G. Guthrie, Casselton, N. Y.; W. D. Wade, Wellsville, O.; W. A. Buehl, Sycamore, Ill.; Chas. H. Savage, Elgin, O.; Ed. J. Hirsing, Toledo, O.; Henry Reis, Davenport, Ia.; Fred Case, Plattsburg, Mo.; W. J. Spraul, Sparta, Ill.; S. D. Stinson, Elmira, N. Y.; C. F. Kleine, San Antonio, Tex.; H. T. Coffin, Newcastle, Ind.; J. C. Schmidt, Lebanon, Pa.; J. E. Tinker, Danville, Vt.; W. F. Hittig, Dundee, Mich.; L. E. Hanson, Woburn, Mass.; C. S. Dustin, Stillman Valley, Ill.; I. G. Wirt, Pittsburgh, Pa.; C. E. Searl, Merrill, Wis.; H. F. Alden, Sauk Centre, Minn.; Louis Selig, Elizabeth City, N. C.; Ned Keating, Watertown, S. D.; D. Whiteside, Liberty, Mo.; G. W. Shuman, Hobart, Ind.; J. S. Smith, Mt. Vernon, Ia.; Mack V. Ricketts, Greencastle, Ind.; Geo. W. Flanders, Marcellin, Mich.; Chas. W. White, Buffalo, N. Y.; Otto Eger, Ishpeming, Mich.; Joe White-man, Brookfield, O.; A. H. Phillips, Dunkirk, Ind.; R. E. Phillips, Montville, O.; W. V. Beresford, Amboy, Ill.; O. L. Rosencrans, Milwaukee, Wis.; C. G. Alfred, New York; C. S. Taylor, David City, Neb.; J. Castello, Socorro, N. M.; James A. Young, Watertown, Tenn.; L. H. Fondersmith & Son, Hoopetston, Ill.; O. W. Hutchinson, Barre, Vt.; Chas. Wilson and Morton L. Gould Cincinnati, O.; E. D. Kohn, Davenport, Ia.

Visitors last week to the rooms of the Chicago Jewelers' Association, seventh floor Columbus Memorial building, were as follows:

E. P. Varian, Denver, Col.; S. C. Castillo, Socorro, N. M.; J. B. Armigo, Albuquerque, N. M.; Estevan Baca, Socorro, N. M.; J. R. Kocher, San Jose, Cal.; Alex Mofat, Brantford, Can.; Quincy Smith, Canandaigua, N. Y.; S. C. Scott and Chas. F. Hickok, Saginaw, E. S., Mich.; Mr. and Mrs. C. O. Brightman, New Bedford, Mass.; B. R. Smithers, Camerou, Mo.; Smith & Newell, Harvard, Ill.; Geo. H. Thoma and wife, Three Rivers, Mich.; A. J. Leach, Kasson, Minn.; Louis Lange, Cincinnati, O.; G. H. Bassinger, Glens Falls, N. Y.; M. Weintraub, Jacksonville, Fla.; H. L. Upton, Upton, Ky.; J. H. Lentz and Chas. Reinstatler, Cincinnati, O.; Joseph A. Wilson, Kansas City, Mo.; H. Kemath, Spencer, Ia.; D. Ainley, Perry, Ia.; Mrs. H. McCurry, Pittsburgh, Pa.; J. J. Heath and wife, Lansing, Mich.; Geo. B. Woodruff, Winsted, Conn.; Mr. McCabe, Winsted, Conn.; Gustave Paul, New Orleans, La.; A. H. Pray, Boston, Mass.; Geo. W. Fischer, Sharon, Pa.; C. E. Searl, Merrill,

DALE  
CHUCKS.

Manufactured by

HOROLOGICAL TOOL CO.,  
86 N. CLARK STREET,

For Sale by all Jobbers. CHICAGO.

## THE PLANCHAMP &amp; BECKER CO.

Makers and Repairers of

## WATCH CASES,

Gold and Silver Plating —

— of Watch Cases a Specialty.

UNEXCELLED FACILITIES.

63 and 65 East Washington St., Chicago.

## HENRY J. ROHRBACH,

SILVERSMITH AND MANUFACTURING JEWELER,

GOLD, SILVER  
AND NICKEL PLATER.  
Silver and Silver-Plated Ware of all kinds  
Repaired, Refinished and Polished  
at Low Prices.  
SEND FOR PRICE LIST.

94-96 State Street,  
(Room 524,) CHICAGO.

ALL KINDS OF BRONZES  
REPAIRED AND REBRONZED.

Full facilities for manufacturing and repairing  
all classes of Jewelry for the Trade.

Remember—Room 524.

## PARSONS : SCHOOL

— FOR —

WATCHMAKERS,

PEORIA, - - - ILL.

Send for Circular and Terms.

PARSONS & CO.

WHEN IN CHICAGO, VISIT THE

## Chicago Watchmakers' Institute,

SUITE, 1521-1523 B MASONIC TEMPLE.

A Modern Trade School for the Watchmaker, Jeweler and Engraver.

Wis.; E. L. Wentworth, Minneiska, Minn.; M. Truby, Independence, Kan.; S. A. Noble, Bonham, Tex.; S. L. Sulger, Cannelton, Ind.; F. K. Sulzer, Albuquerque, N. M.; John McKinney, East Liverpool, O.; A. Aronson, Mexico; Max Bauman and wife, St. Louis, Mo.; W. W. Hendricks and wife, Crystal Falls, Mich.; H. H. Squier, Big Rapids, Mich.; M. B. McGee and wife, Crystal Falls, Mich.; Chas. F. Halbkat, Waseca, Minn.; H. Doelle and son, Yale, Mich.; J. W. Blackledge, Indianapolis, Ind.; H. Rehmke, Ellensburg, Wash.; Geo. B. Clary, Moravia, N. Y.; P. K. Wiser, Mankato, Minn.; E. L. Chamberlain, Kansas City, Mo.; J. H. O'Daniel and wife, Gloucester, O.; C. E. Dickinson, Garden City, Kan.; Ed. C. Kraemer and wife, Tomah, Wis.; Jesse Goldberg, Cincinnati, O.; C. A. Schenk and wife, Stevens' Point, Wis.; S. W. Anderson, Cleveland, O.; J. T. Nace, Hamburg, Ia.; Fred. J. Heintz, Lexington, Ky.; F. W. Koehler, Sharon, Pa.; J. M. Glenn, Morristown, Tenn.; W. F. Spurlin, Camden, Ala.; L. Burnett, St. Joseph, Mo.; F. H. Rhinehart, Alliance, O.; W. A. Blanchard, Cleveland, O.; D. M. Clement, Alliance, O.; H. F. Alden, Sauk Center, Minn.; Wm. Conrad, Tecumseh, Mich.; George Hazeltine, New York; E. F. Strickland, Benton Harbor, Mich.; W. S. Parker, Prairie City, Ia.; Lew E. and Ada O. Stevenson, St. Joseph, Ill.; F. D. Hoffman and G. H. French, N. Attleboro, Mass.; and John Wolfenden, Attleboro, Mass.

Out-of-town jewelers who visited the Retail Watchmakers' and Jewelers' Association of Illinois rooms last week included:

J. H. Gregory, Washington, D. C.; Frank Leuenthal, Hartford, Conn.; J. M. Irmen, Atlantic, Ia.; August Schliecker, Vinita, I. T.; Geo. Chambers, Mt. Clemens, Mich.; W. Codemal, Paris, Tex.; S. S. Ballard, Aspen, Col.; S. P. Crook, Hebron, Neb.; F. W. Hanenstein, New Ulm, Minn.; H. B. Potthoff, Latrobe, Pa.; Jno. M. Clower, Cleburne, Tex.; H. H. Schellberg and wife, Kansas City, Mo.; D. W. Martin, Neosho, Mo.; E. A. Rhodes, Eureka, Ind.; I. M. Martin and wife, Kewanee, Ill.; A. Kolstad, Pleasant Hill, Mo.; J. M. Paulen and wife, Fredonia, Kan.; W. J. and W. K. Fraser, Lincoln, Pa.; Will Beebe, Neosho, Mo.; H. L. Meyers, Lynn, Mass.

T. P. Smith has given a chattel mortgage for \$165.

Jacob Muhr returning to his Quaker City home, his place in social life here has been filled by the arrival of Phiz. Muhr.

Geo. B. Woodruff, assistant superintendent for the Wm. L. Gilbert Clock Co., Winsted, Conn., is taking in the Fair.

Mr. Richards, of Richards & Rutishauser, 601 Columbus building has been confined to his home for three weeks with la grippe.

Joseph Charles Dueber, of Canton, O., eldest son of John C. Dueber, stopped at the Palmer a week on a World's Fair visit.

Mr. Foster, of Foster & Bailey, with his son, stopped at the Park Gate Hotel, the past week, and returned to Providence Saturday.

Theo. Schrader reports order business as good as in any previous year, and that prospects are good because of light orders during the Summer.

Wendell & Co., silversmiths, 67 & 69 Washington St., are working on full time and report out-of-town spoon business good and jewelry business improving steadily.

Prominent among World's Fair exhibitors the past week were noted Mr. Foster, of Foster & Bailey, Chas. F. Irons, of Irons & Russell and Mr. Krower, of Albert Lorsch & Co.

J. L. Hutchinson, proprietor, and J. C. Northway, instructor, in Hutchinson's Prac-

tical School for Watchmakers, La Porte, Ind., are examining horological and other exhibits at the Exposition.

The Chicago Watch Tool Co. will remove during November from their present location, 52 Madison St., to more commodious rooms at 125-127 E. Indiana St. Increase of space was necessitated by additions of improved machinery to fill increasing orders.

At the quarterly meeting of the Retail Watchmakers' and Jewelers' Association of Illinois, held Oct. 12, the following officers to serve for the ensuing year were elected: President, F. Lorenz; first vice-president, O. G. Bryant; second vice-president, S. P. Sandmark; secretary, Frederick Correll, Jr.; treasurer, Ludwig Goll; directors, Herman Von der Heydt, Fred Scholer, Henry C. Pitz and W. A. Gustafson.

## REED & BARTON,

SILVERSMITHS,

MANUFACTURERS OF

STERLING and SILVER PLATED  
SILVER and WARE.

SALESROOMS:

37 Union Square, New York.

34-36 WASHINGTON STREET,

Venetian Building, Chicago.

FACTORIES, TAUNTON, MASS.

## RECEIVER'S SALE



ENTIRE Stock of Giles, Bro. & Co. Fourth Floor Masonic Temple, consisting of Diamonds, American and Swiss Watches, Jewelry, Silver and Plated Ware, Tools, Materials, etc. will be sold in lots to suit the purchasers at large reduction from original cost price.

An unusual chance for live Jewelers to obtain bargains.

W. H. GLEASON, Receiver.

July 14th, 1893

Mrs. M. I. Goldsmith, of Pittsburgh, Pa., whose late husband was a prominent jeweler in that city, is visiting the Fair.

A. D. Verschuur, Amsterdam agent for Juergens & Andersen Co., left for the east Friday after a week of sight-seeing here.

The manufacturing establishment of the Juergens & Andersen Co., is working full force on order business. The reputation of the house for fine work insures a constant increase.

Mr. Gladston, managing partner of Versepuy fils, Gladston & Barry, Paris connection of L. Manasse, is accompanied by his wife on a two months' visit here. Mrs. Gladston is a daughter of Mr. Manasse.

Parsons, Ide & Co., Peoria, Ill., have incorporated to conduct Parsons' Horological Institute as a school of theoretical instruction in watchmaking, jewelry manufacturing and optics, and to manufacture jewelry, special instruments, etc. The capital stock is \$120,000 and the incorporators are: James R. Parsons, Fred F. Ide and Lydia Bradley.

Robert H. Ingersoll & Bro.'s exhibit of \$1.50 watches in the Manufactures building, of the World's Fair, which was closed several weeks ago on account of the alleged sale and delivery by the firm of goods from the exhibit, has been reopened. The firm strongly denied the charge against them, and an examination by the Exposition authorities has resulted in the finding that

the rules were not violated by the exhibitors.

### Indianapolis.

J. E. Koegel has opened a new jewelry store at 173 Broadway, Fort Wayne, Ind.

G. Dold, of Brooks & Dold, Madison, Ind., has been elected treasurer of the public library of that city.

C. M. Eaton, Trafalgar, Ind., and L. C. Phillips, Carbon, Ind., were in town last week buying goods.

The following Indianapolis jewelers have just returned from the World's Fair: M. Peters, Andrew Oehler, H. O. Thomas, J. C. Sipe, Leonard Schurr, Louis Burgheim, E. Burgheim, John Gibney and Fletcher Medearis.

Indiana jewelers keep up a steady tramp to the World's Fair. Some of the most recent visitors were: J. H. Ralston, Goshen; John A. Didot, Geneva; F. H. Erichson, Laporte, J. G. Carnahan, Oxford; W. A. Huff, Rensselaer; G. J. Daum, South Bend; J. G. Ryan, Griffith; W. H. Arens, Jamestown; Frank Heller, Alexandria; A. Hawkins, Noblesville; C. P. Murphy, New Castle; J. W. Beahm, Union Mills; W. D. Doddridge, Mentone; J. H. Ellis, Le Brun; F. A. Follett, Tremont; Frank Mayr, South Bend; R. A. Bearshear, Gas City; J. Roland, Cannelton; W. J. Davisson, Farmland; Will Hazeltine, Kokoma; S. J. Ward, Michigan City; Fred Stark, Shipahewana; F. E.

Burt, Angola; E. M. Wilhite, Danville; H. B. Lodde, Lafayette; E. A. Rhodes, Eureka, and Louis F. Ott, Veedersburg.

### Pacific Coast Notes.

On Oct. 18th the stock of drugs and jewelry, fixtures, etc., of the Puyallup Drug Co., Puyallup, Wash., were sold out at auction by order of the receiver, W. L. Bray.

A bold burglary was committed in the jewelry store of L. B. Cummings, 138 Montgomery St., San Francisco, some nights ago. Mr. Cummings closed his store at 5.30, and later in the evening he was told that his plate glass show window was broken. Investigation showed that a brick had been thrown through the window, and that the thief had seized a handful of filled chains.

James H. Higgins, of Higgins & Rothkopf, 208 Sutter St., San Francisco, lost \$700 worth of diamonds a few days ago. For several days he had been carrying them in a canvas pouch in his pocket. After showing them to a possible customer he is not sure whether he put them back in his pocket or left them lying on the counter. He went to lunch soon afterwards, leaving his partner, Albert P. Rothkopf, and two trusted employes in charge of the place. When he returned the jewels were missing. He is sure his pockets were not picked, but does not suspect any of the men he left in the store.

#### NEW THROUGH TRAIN.

The Nickel Plate Road announces, that commencing Sunday, September 3d, Train No. 4, running between Chicago and Cleveland, and No. 8, running between Cleveland and Buffalo, was merged into a continuous through train; leaving Chicago at 7.35 A. M. and reaching Buffalo at 3.40 A. M. the following morning. The equipment of this train embraces standard smoking and day coaches and sleeping cars from Chicago to Buffalo. Direct connection at Buffalo for all points east.

#### GROWING.

The Nickel Plate Road on Sunday, Sept. 3d., increased their train service by the addition of a new through east-bound train by merging the Chicago and Cleveland and Cleveland and Buffalo accommodation trains, into a new through express with sleeping cars from Chicago to Buffalo. Direct connection at Buffalo for all points east.

#### HEAVY EAST-BOUND TRAVEL.

On account of growth in East-bound business, the Nickel Plate Road inaugurated a new through express on Sunday, Sept. 3d. Palace sleepers, Chicago to Buffalo, and direct connection at Buffalo for all points east.

It is a pleasure to note the addition of another through train to the already competent train service of the Nickel Plate Road. It will leave Chicago at 7.35 A. M. and reach Buffalo at 3.40 A. M. the following morning. Through sleepers Chicago to Buffalo. Direct connection at Buffalo for all points east.

#### A FACT WORTH KNOWING.

For a distance of seventy-nine miles, the Nickel Plate Road is a perfect air line. This is the longest tangent in the United States. When going east, take this rapidly growing popular road. Three superbly equipped trains daily for the east. Passenger station corner Clark and 12th Sts., Chicago.

THE JUDGES AT THE

# World's Columbian Exposition

HAVE GIVEN US AN

## AWARD

ON OUR EXHIBIT AS MADE THERE. THIS EXHIBIT WAS MADE READY IN APRIL LAST. SINCE THAT TIME WE HAVE PRODUCED GOODS IN THE LINE OF

# Emblems, Charms AND Rings,

THAT FAR EXCEED IN BEAUTY AND ORIGINALITY OF DESIGN, MANY OF THE GOODS IN OUR CHICAGO EXHIBIT.

WRITE US.

# IRONS & RUSSELL,

Providence, R. I.

J. Voss, Woodburn, Ore., has given a deed for \$150.

Walt. Mead, Albany, Ore., has received a deed for \$300.

Albert Hanson, Seattle, Wash., is holding a clearance sale.

Lester W. David, Blaine, Wash., is back from the World's Fair.

W. B. Richardson has opened a jewelry store in Oakesdale, Wash.

Chas. Esberger, Sr. has canceled a real estate mortgage for \$600.

V. E. Campbell, Mount Vernon, Wash., is selling his stock off at auction.

R. A. Morse, Seattle, Wash., will spend the Winter on his ranch in the Sauk Valley.

Tacoma and Seattle jewelers say trade is picking up somewhat, but it is quiet as compared with former seasons.

O. M. Rudd's store, Rockford, Wash., was burglarized recently of goods valued at about \$300. The robbery was the work of tramps, who have not been apprehended.

### Cincinnati.

C. Hellebush is receiving a new line of Dresden china for the holiday trade.

Amberg & Co. have opened up a temporary branch store on Fountain Square.

Lewis Braham & Son are conducting an auction sale, by order of the assignee, this week.

John Holland says the pen trade is increasing. His concern have received good orders this week.

Homan & Co. are among the busiest manufacturers in town; they have had excellent business for some time.

Duhme & Co. are getting ready to start up their watch case factory. They have had numerous calls for cases this season.

Josiah Cummings, of Josiah Cummings & Son, Boston, Mass., makers of jewelry cases and trunks, was in Cincinnati last week.

Lee Kaufman, of Gustave Fox & Co., has returned from a tour of inspection, and reports trade as depressingly dull. He opened his case at very few places.

The Wadsworth Watch Case Co. are turning out for holiday trade some of the pretty enameled cases that were so popular last season. The floral designs are exquisite. Almost all the orders coming in are for scalloped centers.

R. W. Barbour, jewelry buyer for Duhme & Co., is at the World's Fair this week. E. J. Morris, manager of the bric-à-brac and pottery department, has just returned. I. N. Laboiteux, manager of the retail department, was a delegate to the Humane Congress at the World's Fair.

William Hathaway, an engraver employed by Homan & Co., committed suicide Friday at his boarding house. He came from Rockford, Ill., several weeks ago in search of work. He was an excellent workman and was assured plenty of work at Homan's

but he was despondent. After sending his week's salary to his family at Rockford he pawned his watch and bought enough chloral with which to end his life.

### Cleveland.

Both wholesalers and retailers report a slow but steady picking up of trade.

Webb C. Ball has in his window a unique collection of "scrip." There are nearly all kinds of United States paper money, Confederate bills, wild cat currency, and specimens of foreign money.

One of the visitors to the city the past week was a Florida jeweler, H. E. Adams, of Sanford. Mr. Adams was on his way to New York after a visit to the World's Fair. He is time contractor for the J. T. & K. W., Southern Florida, O. B. and Florida Southern railroads and the Indian River Steamship Co. Mr. Adams was visiting friends in the city and called on a number of local jewelers.

### Suits and Bills Filed Against Adolph Shakman.

CHICAGO, Ill., Oct. 23.—In addition to the \$16,000 judgments entered against Adolph Shakman, wholesale jeweler, at 189 Fifth Avenue, as detailed in THE CIRCULAR of last week, Moritz Shakman filed a confession of judgment in the United States Circuit Court for \$8,561.24, making a total of over \$24,000 in preferences, in which the name of Shakman is prominent.

Oct. 17th in the same court Moritz Shakman filed a creditor's bill for receiver. Now comes a bill filed in the Superior Court, in which the Dueber Watch Case Mfg. Co., through Anthony Serewicz, agent, state they are lawfully entitled to the possession of eighty-eight gold filled and twenty silverine watch cases, valued at \$588.50, now in the possession of the sheriff and Adolph Shakman. It is currently reported that Shakman bought heavily in the Spring, but the liabilities can only be ascertained by the appointment of a receiver or an examination in court of the insolvent firm.

The firms who have refused to fill Shakman's orders the past nine months are numerous. Shakman, it is understood, places part of the responsibility for his failure as due to talk of his large purchases among traveling men.

In the Superior Court, Oct. 21, William E. Webster *et al*, brought suit in assumpsit against Adolph Shakman for \$2,500.

### SHAKMAN'S TRANSACTIONS WITH EASTERN HOUSES.

PROVIDENCE, R. I., Oct. 19.—The manufacturing jewelers of New England and especially of this city were disagreeably surprised this week by a dispatch from Chicago, which brought the information that Adolph Shakman, of that city, had confessed judgment aggregating \$13,500 and that his business was in the hands of a sheriff. Shakman owes nearly all of the manufacturing jewelers in this city in sums ranging from \$50 to \$5,000, the total amount being estimated as between \$60,000 and \$75,000. Other concerns in New England are also largely interested.

Adolph Shakman started in the jewelry business in Chicago in 1877. In 1881 he took his brother-in-law, named Lowenbach, into partnership, the latter remaining in the firm until 1890. In 1886 Mr. Shakman backed J. S. Gratz, another Chicago jeweler. Gratz failed; his creditors brought suits against him, and he was arrested. Shakman was forced to buy out Gratz and to pay all his bills, aggregating a large amount. For a time Mr. Shakman was blacklisted by the manufacturers but eventually he turned his attention eastward and built up a large trade, purchasing for cash.

Shakman commenced to buy small quantities of the eastern dealers for cash, and after a time he asked for credit, and he got it. Then he got more credit, and last Spring he came east to New York and placed orders in unlimited amounts. As the agencies gave him a good high and safe rating it was thought that he was all right, and so these large orders were taken. When, a few months later, however, he commenced to duplicate these large orders, the Manufacturing Jewelers' Board of Trade and the Jewelers' Mercantile Agency advised caution, and several of their subscribers consequently escaped from the crash.

William R. Darrah, agent for H. M. Betz, Philadelphia, Pa., has opened a store on Market St., near 6th, Chester, Pa.

The jewelry store of Sigmund Hoffman, Jefferson, Wis., was robbed some days ago of six watches.

ONE OF THE BEST  
OF THE VERY BEST.

QUALITY IS THE  
STANDARD OF VALUE.

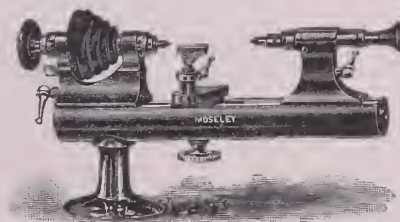

MEN INTERESTED WRITE YOUR JOBBER OR

MOSELEY & CO.,

- -

ELGIN, ILL.



## SUGGESTIONS FOR WINDOW AND STORE DECORATION.

Members of the trade who think they have an attractive window are invited to send us a photograph, or a pen and ink or pencil sketch of the same, which will be published if we consider the window contains any originality or lesson.

### IDEA LII.

#### WINDOW DESIGN CONTEST, NO. 2.

A Prize of \$10.00 is offered by THE JEWELERS' CIRCULAR for the best design for dressing a jeweler's window. The contest is open to all members of the trade, to the clerks, salesmen and others, as well as to the dealers. Following are the conditions:

1. The design is to be submitted as a pencil or other sketch or photograph, from which a finished engraving may be made. The design may be an original conception or a copy of a window already dressed.
2. A brief description is to accompany the design.
3. The design must be appropriate for the Fall and holiday season.
4. Designs for Contest No. 2 must reach us no later than Nov. 1.

THE competitive design submitted by Miss Alice M. Brady, with P. Brady, Sharon, Pa., is adapted for a Christmas window. It represents a Winter landscape. The back curtain is of gray material covered with pine and holly. By means of boxes, etc., a hill is formed, and this as well as the rest of the window is covered with white cotton sprinkled with "diamond dust." Over the top of the hill rises the full moon, made by putting a disk of waxed yellow paper on the gray curtain, and at night, setting a lamp behind it. Stuck in the cotton on the hill are short pines. In the foreground a skating pond is formed by a much scratched piece of glass set under the cotton. A tiny log hut with a candle shining from a window produces a very pretty effect. Jewelry and fancy articles show effectually against the white cotton.

#### WINDOW DECORATION NOTES.

H. A. Comstock, Indianapolis, Ind., recently had a very pretty window arrangement. Beautiful rose buds and carnations were carelessly strewn over the white window covering, and from every flower peeped a sparkling diamond, ruby or emerald. The effect was pleasing in the extreme.

H. E. Wheeler, jeweler, Lynn, Mass., displays in his window a collection of foreign and domestic coins. He also has a colonial bill of the colony of New York. It is dated Feb. 16, 1771, is five pounds in denomination and is worth \$24. This is supposed to

be the only bill of the kind in existence in New England. Mr. Wheeler's collection attracts much attention.

One of the handsomest dressed windows in Providence, R. I., is that of Jacob Far-

and a few of them have been sent to this country. They are worn upon the lapel of the coat, like a society button. They are retailed at \$75 a piece.

An ingenious idea of a bright window trimmer was recently embodied in one of the large jewelry houses of Cincinnati, O. When a man thinks of hanging gold watches and costly jewelry on the imitation of an old fence he shows a lot of originality. And the idea took, for a host of people were attracted by the novel display.

An attractive, yet simple window display



COMPETITIVE DESIGN OFFERED BY MISS ALICE M. BRADY.

ington & Co. During the past week he has had his window decorated with watches of various kinds and sizes, while in the center, on a purple raised plush dais, is a watch claimed to be the smallest ever exhibited in Providence. It is a Swiss watch, and measures but three-eighths of an inch in diameter. These watches are being quite commonly worn among the gentry of the old country,

is shown by Genicke & Caspary, Detroit, Mich. Two snow white owls, as natural as life, are perched at either end, facing the street. They wear tiny black silk ties and gold rimmed eye glasses and chains. Around their necks are strings of pearls and in the breast of each sparkles a diamond. Between them are scattered novelties, which are changed from time to time.

## Larter, Elcox & Co.

Manufacturers of Fine Gold Jewelry  
21 & 23 Maiden Lane, New York.



WE ARE READY FOR THE FALL TRADE.

### Rings, Seals, Spring Back Studs.

GENTLEMEN'S WHITE ONYX BUTTONS AND STUDS

**Detroit.**

A judgment for \$278 has been entered against Jacob M. Smit.

Edward P. Roehm, who is in New York on business, will return about Nov. 1st.

Charles Warren, formerly of Sturgeon & Warren, is in the watch department of Wright, Kay & Co.

Frank A. Rasch, secretary of the United States Optical Co., has been nominated by the Republicans for city attorney.

L. B. Colwell & Co., recently incorporated to smelt sweepings and refine gold and silver, are located at 254 Woodward Ave.

Fire last week destroyed the business portion of Alma, Mich. F. C. Taylor loses \$1,000 on his jewelry stock; insurance, \$400.

Charles Welch, son of jeweler John Welch, Stratford, Ont., arrived here last week to begin a course in the Detroit Optical Institute.

Edwin B. Rogers, formerly a jeweler at Marshall, Mich., and well known in this city, fell from a step ladder at his home in Lansing, last week and was instantly killed. He was sixty years of age.

The United States Optical Co. have started a branch office in Omaha, Neb. Mr. Bernard, of this city, will have charge. T. J. Commerford, manager, returned last Sunday from Omaha, where he made the necessary arrangements.

Peter Amerien, a Saginaw jeweler, last week reported to the police that \$112 worth of his stock was missing. Marie Trombly was arrested and the booty recovered. She took the goods while engaged in conversation with the proprietor.

The jobbers notice a steady improvement in their mail orders. Country retailers are cautiously freshening up stocks that have been allowed to run low. The following Michigan country jewelers were recently in this city: A. H. Taggart, Durand; George H. Hebblewhite, Armada; George H. Chappel, Howell; W. F. Hittig, Dundee; S. O. Ecker, Mt. Clemens, and William Ambler, Northville.

**Minneapolis and St. Paul.**

J. B. Hudson, Minneapolis, has returned from New York.

S. H. Clausin, Minneapolis, accompanied by his wife, left on the 16th on a trip to the World's Fair and the east.

B. W. Annin, until recently watchmaker for Weld & Sons, Minneapolis, has started in business for himself in room 531, Guaranty Loan building.

The following Minneapolis jewelers have returned from the World's Fair: J. F. Ellwell, J. W. Dupont, R. G. Winter, L. D. De Mars, Fred Fiske, Joseph Olson, N. P. Peterson and Wm. McCluskey.

Robert Jamison, assignee of J. W. Dupont, Minneapolis, has petitioned the court to be allowed to present his final accounting, and asks to be discharged as assignee as he has settled the estate.

Out-of-town jewelers visiting the Twin

Cities the past week were: M. H. Cull, Lisbon, N. Dak.; C. H. Hoyt, Fergus Falls, Minn.; G. S. Shimmin, Buffalo, Minn.; T. I. Lewis, Moorhead, Minn.; B. F. Ashelman, Ada, Minn.

Jacob Lowenberg, formerly manager for F. M. Sproehle & Co.'s branch house in St. Paul, who was arrested some time ago charged with embezzlement and confined in jail for several months past, was released last week, the Grand Jury failing to find an indictment against him.

The H. F. Legg Jewelry Co., of Minneapolis, have incorporated with a capital of \$50,000, and will locate in the corner store of the Medical building, corner 6th St. and Nicollet Ave. The incorporators are: Harry F. Legg, Dora V. Legg and J. N. McNaught. The company have purchased the stock of Harry F. Legg, insolvent, Judge Jamison authorizing the sale.

**Connecticut.**

Dwight P. Wileox, of the Meriden Britannia Co., has been dangerously ill, but is now rapidly improving.

The E. Ingraham Co., Bristol, are running part of their works on eight hour time, and men are being called in as fast as needed.

Colonel W. H. Stevenson has brought suit for foreclosure of a \$6,000 mortgage held on Fairfield property purchased from him by A. M. Craig, of the Craig Silver Co., Bridgeport.

A man representing himself to be an agent of H. R. Woodward, Norwich, has been selling spectacles in Voluntown, Jewett City and other places. Mr. Woodward pronounces the man an impostor.

Thomas Murphy entered the jewelry store of William Scharoff, Meriden, last Monday noon while Mr. Scharoff was in an adjoining store, and carried off several watches that were in the window. The jeweler on his return missed the watches and notified the police. Murphy was soon caught and the watches were found in his pockets.

With Guarantee as to Quality



FOR

SEND TO

**J. T. Scott & Co.**  
**4 MAIDEN LANE,**  
**NEW YORK.**

No jeweler or watch repairer should be without a copy of "WORKSHOP NOTES," a new and very useful book for the workshop. Send for circular containing a complete index of the book, and judge of its merits for yourself.

**MORE DURABLE THAN IMPORTED,**  
**CHEAPER THAN IMPORTED,**  
**SUPERIOR TO IMPORTED.**



**FOX TAIL**

**CHAINS**

MADE BY

**BLANCARD & CO.,**

**45 & 47 JOHN STREET, N. Y.**

We keep a full Stock in 14 and 10 kt. Gold also in Silver. We make to order in 18 kt. Gold, Platinum, Aluminum Composition or German Silver.

are not as busy as usual at this season of the year, still orders are coming in.

Samuel C. Hoyt, Danbury, has made an assignment.

J. Spencer, South Norwalk, has returned from the World's Fair.

Mr. and Mrs. J. G. Woodruff, of Winsted, have left for the World's Fair.

Parker & Davis, Bridgeport, are furnishing the pin for the Bridgeport High School.

Mr. and Mrs. A. B. Stockwell, Thompsonville, returned last Monday from their trip to the World's Fair.

The Winsted Optical Co., West Winsted, are having the factory at the head of the lake supplied with steam heat.

Ex-Councilman Kohn, the Hartford jeweler, fell among thieves in New York a few days ago. As the Hartford jeweler was boarding a street car, he was relieved of a four-karat diamond worth \$600, which he wore as a pin for the shirt bosom.

The Waterbury Clock Co., Waterbury, are to have an electric clock in the tower of the recently completed addition to their works which will strike the hours by electricity. The Standard Electric Time Co., of New Haven, have the contract to put up the clock and it is expected that everything will be in striking order by Nov. 1.

The burglars who robbed the jewelry store of N. E. Gladwin, in Essex, of \$150 worth of goods, a few nights ago are believed to be the same gang of thieves who have been at work in other towns in the State. The burglars would have made a bigger haul if it had not been for a hunting dog in the upper part of the building, that kept up a continuous barking.

A. A. Gerlach, Columbus, O., has sold out his business.

## CHAS. L. UHRY & Co.

N. Y. OFFICE,

189 BROADWAY.

SCARF PINS,

BROOCHES,

CHARMS,

FOBS.

HAT PINS,

HAIR PINS,

CHATELAINES.

336 Mulberry St., Newark, N. J.

## CHAS. L. UHRY & Co.

### Meeting of the American Horological Society.

CHICAGO, Ill., Oct. 20.—The regular monthly meeting of the American Horological Society was held on Oct. 16. The applications of Edward Rivett, Boston, Mass., T. O. Bounds, Jr., Wortham, Tex., Daniel O'Hara, Waltham, Mass., H. R. Platner, Toronto, Canada, P. W. Eigner, Kent, O., Henry Slusher, Danville, Ill., and F. W. Hunt, Burlingame, Kan., were reported upon and they were unanimously elected to membership.

Several designs for an emblem were submitted, in response to the offer to award a cash prize of \$10 for a design for an appropriate emblem for the society, to be used on its stationery, or as a scarf pin or button. All designs must be in the hands of the secretary by Nov. 13, 1893.

O. G. Bryant then presented the following resolution:

Resolved, That the Chair be requested to appoint a committee of three to revise the Constitution and By-laws, and report at the next meeting.

The resolution was carried, and the president appointed Messrs. Ashby, Hollands and Hazlitt as a committee. A general discussion on the merits of watchmakers' tools now on the market followed, after which the meeting adjourned to Monday evening, Nov. 13th.

### Jeweler Till Recovers a Large Amount of his Stock.

DETROIT, Mich., Oct. 20th.—On the night of Oct. 2d., burglars entered the jewelry store of W. J. Till, Columbiaville, Mich., while he was asleep over the store and stole \$900 worth of goods. They took the best of his stock, leaving only a few clocks.

Dispatches from Bay City, Mich., last night, to Detroit papers, state that he has succeeded in finding a large amount of the stolen goods hidden in a lumber yard. A notorious character, named James Mahoney, has been arrested charged with the crime.

### A Jeweler in the Role of Thief.

UTICA, N. Y., Oct. 19.—Geo. Thompson, jeweler, and Fred. Smith, a janitor in Oriskany Falls, have been arrested and held in \$600 bail. Samuel Bates and Thomas Brady, of Oriskany Falls, observed a light in the store of C. H. Malone, in that village, at an early hour Sunday morning. Investigating closer they saw Thompson and Smith helping themselves in the store.

Mr. Malone was notified, but the thieves escaped. Upon learning that they had been seen and recognized, Thompson and Smith confessed and tried to fix up the matter.



Elk, Shrine and Masonic  
Emblems a Specialty.

Badges of Every Known Order.

G. A. SOHLECHTER.

Manufacturing Jeweler,

READING, PA

### L. Strasburger's Son & Co. Want a Receiver for the Shader Mfg. Co.

CHICAGO, Ill., Oct. 21.—L. Strasburger's Son & Co., New York, have filed complaint against the Shader Mfg. Co., of this city, as defendant and James E. Moore, Augustus E. Shader, and Wm. J. Moore, and the F. E. Moore Furniture Co. as co-defendants, stating the defendant company was capitalized at \$10,000 with one hundred shares of \$100 each as follows: James E. Moore, forty-nine shares; Augustus E. Shader, fifty; Wm. J. Moore, one. James E. Moore was elected president and Shader secretary. The purpose of the organization was to manufacture and sell jewelry and precious stones.

Plaintiffs claim the firm's indebtedness to them exceeds \$1,500; that for the purpose of wrecking the company and defrauding creditors, the defendants conveyed some \$12,000 assets to the two Moores, who removed same from the office in Masonic Temple to the residence of Jas. E. Moore, and are disposing of the goods for their own benefit; that at the time of the transfer the defendant company was insolvent; that the outstanding mercantile indebtedness exceeds \$10,000 and the company have ceased doing business; that the F. E. Moore Furniture Co. have part of the assets.

In view of these statements the plaintiffs ask that an injunction issue restraining defendant's from disposing of assets or making collections, and that a receiver be appointed.

The handsome large catalogue for 1894 recently issued by Otto Young & Co., Chicago, is a complete encyclopedia of knowledge on matters pertaining to the jewelry trade and is being eagerly sought by legitimate jewelers. The word "legitimate" is advisedly used, as none but jewelers of that class can secure the valuable work. Forty pages are devoted to optical goods; forty-two are required for clocks, among which are prettily illustrated cuckoo Black Forest clocks of which the firm make large direct importations; silverware claims one hundred and fourteen pages, of which case goods, single pieces and novelties form an important part; watches are fully illustrated on sixty-two pages, chains on fifty-six, and a less number to each of the various lines which complete the immense stock, from which every taste can be easily satisfied. Nine pages of diamond mounted goods, each page containing thirty-six illustrations, are a fit ending to a volume that is invaluable to the wide-awake jeweler. In business principles the firm stand pre-eminent. The immense lines of cases, movements, watches, jewelry, diamonds, silverware, optical goods, tools, materials, etc., allow the widest latitude in selection. The house are direct importers of all foreign goods handled by jewelers, and save to customers the profits of the middle men. The motto of the house, "Honest goods at honest prices" is in itself a *vade mecum* of right dealing and the extraordinary facilities of so great an establishment are a proof positive of lowest prices consistent with honest goods.





## Our Traveling Representatives



Traveling representatives may consider these columns open for the publication of any news or items of interest regarding themselves or their confreres.

**T**HE Commercial Travelers' Club, of New York, will hold one of its celebrated smokers at the club house, 15 W. 31st St., on Saturday night, Oct. 28th. President Knott promises a good time, and says that all are welcome.

Lou Fay, with Kirby, Mowry & Co., left Chicago, Friday, for Milwaukee and thence to St. Louis.

H. M. Tenney, Lapp & Flershem, has returned from Illinois territory to Chicago, with fair trade throughout a two months' trip.

"We are receiving many orders from our Mr. Jeanneret," report Jurgens & Andersen Co., Chicago. Mr. Jeanneret is in Kansas.

Geo. B. Caldwell, with the Plainville Stock Co., says his hopes were not high on leaving the east for his present western trip, but that realization has exceeded expectation.

C. F. Whiting, Jr., of the Chicago branch of the Crescent Watch Case Co., left Wednesday last for a short trip to St. Louis, Cincinnati, Detroit and other western cities.

T. W. Wallis, representing O. W. Wallis & Co., Chicago, returned from Indiana on account of illness, but so far recovered during the past week that he was able to leave for a general trip east of Chicago.

E. A. Tyler, representing the Chicago house of the Ansonia Clock Co., in the south, has returned from a week's trip and reports good sales. Many merchants, he says, are not satisfied with the present condition of trade but they know it is bound to pick up and therefore placed their orders.

Traveling men in Boston last week included: F. S. Mills; Eugene Cox, Sussfeld, Lorsch & Co.; Sam Zimmern, Henry Zimmern & Co.; Henry G. Thresher, Waite, Thresher Co.; Chris. Morgan, Rogers & Bro.; Ed. Ackley, Unger Bros., Frank Woods, Carter, Sloan & Co.; H. Friese, Lewis, Kaiser & Luthy.

Among the traveling men in St. Louis, Mo., last week were: Samuel I. Hyman, Lewisohn & Co.; Frank T. Gibson, for Wm. Kinscherf; C. M. Davis, New Haven Clock Co.; Mr. Crane, Strobel & Crane; W. F. Corey, Corey & Osmun; A. M. Thauhauser, for Ludwig Lehmann, and G. I. Seaf, Maltby, Henley & Co.

The following in regard to Detroit, Mich., traveling salesmen will be of interest: Frank Mathauer, Kennedy & Koester, is on a four weeks' trip through Ohio; Herman John,

representing Eugene Deimel, is doing the lower part of Michigan; M. M. Dwilliard, United States Optical Co., went out last week; W. C. Spencer, who recently graduated from the Detroit Optical Institute, went on the road last week for the Johnston Optical Co. The latter firm have four men on the road and are running full force at the factory.

Some of the traveling salesmen in Indianapolis, Ind., last week were: A. R. Varian, Dennison Mfg. Co.; Wm. H. Lee, W. E. Webster & Co.; B. B. Brady, B. B. Brady & Co.; C. O. E. Hartung, Sussfeld, Lorsch & Co.; H. W. Steere, Arnold & Steere; Jos. Becker, Jos. Fahys & Co.; Chas. Roe, E. Ingraham Co.; Tom Davis, Middletown Plate Co.; Mr. Bleecker, Bassett Jewelry Co.; Sidney Ashmun, M. E. Moore Bronze and Plate Co.; Arthur Ware, Wm. Demuth & Co., and a representative of the Seth Thomas Clock Co.

The following traveling salesmen passed through Detroit, Mich., last week: Jno. J. Robinson, Holden & Knox; Mark Franklin, Louis Kaufman & Co.; Mr. Van Houten, Sumack & Sherrill; Robert Wilcox, Rogers, Smith & Co.; W. J. Kriel, Hodenpyl & Sons; H. C. Barnum, Shafer & Douglas; F. H. Richrath, for William Downey; William Harris, G. O. Street & Sons; Mr. Steele, J. B. Bowden & Co.; Mr. Cowell, Cowell & Hall Mfg. Co.; Floyd L. Needy, Alfred H. Smith & Co.; M. M. Levison, The Oneida Community; L. E. Smith, M. B. Bryant &

Co.; Stephen Wood, Leroy W. Fairchild Co.; Mr. Hopkins, Meriden Silver Plate Co.; P. E. Rath, C. F. Rump & Sons; Mr. Cook, Bergstein & Sum; Henry Freund, Max Freund & Co.; J. E. Simonson, A. J. Hedges & Co.; Chas. A. Hetzel, F. Grote & Co., and E. P. Hutton, Geoffroy & Co.

Travelers retaining their grip on Chicago trade include: Mr. Sherrill, Sinnock & Sherrill; N. D. Prentiss, Alling & Co.; Geo. B. Caldwell, Plainville Stock Co.; Wm. W. Middlebrook, B. A. Ballou & Co.; Mr. Wilkinson, W. S. Hough, Jr., & Co.; Mr. Gregory, Strobell & Crane; C. F. Irons, Irons & Russell; Mr. Oakley, Thornton Bros.; Lou Fay, Kirby, Mowry & Co.; W. H. Tarlton, Wightman & Hough Co.; M. H. Landman, Salomon Davidson; C. C. Offerman, Wm. Smith & Co.; Wm. H. Morris, J. W. Richardson & Co.; Wm. Harris, George O. Street & Sons; Fred. J. Foster, Unger Bros.; Ernest Block, W. & S. Blackinton; E. P. Hutton, Geoffroy & Co.; A. Kaufman, Bruhl Bros. & Co.; A. Barker Snow, Snow & Westcott; Wm. A. Wightman, R. F. Simmons & Co.; H. A. Bliss, Krementz & Co.; Mr. Steele, J. B. Bowden & Co.; J. E. Simonson, A. J. Hedges & Co.; Harry Osborne, Whiting Mfg. Co.; E. L. Mumford, Waite, Thresher Co.; L. Stern, Young & Stern; Walter Shute, Day & Clark; Mr. Ripley, Watson, Newell & Co.; Harry B. Kennion, H. D. Merritt & Co.; Mr. Rogers, Parks Bros. & Rogers; and M. S. Weand, S. F. Myers & Co.

# LE BOUTILLIER & Co.,

860 BROADWAY,

N. E. cor. of 17th St., - NEW YORK,

Invite an Inspection of their Novelties in

**Real Bronze Busts,**

**Decorated Lamps,**

**Cilt Mounted Faience Clocks,**

**Enameled Clocks,**

**Real Bronze Clock Sets,**

**Plaques, Bisque, Sèvres Vases,**

**Pedestals, French Bronze Busts,**

**Groups, Etc., Etc.**

**NO OLD STOCK IN THIS DEPARTMENT.**

### News Gleanings.

F. Boudette has opened a jewelry shop in Lee, Mass.

A. W. Anthoine, Lewiston, Me., is in insolvency.

George P. Aiken, Brewer, Me., has gone into insolvency.

Ed. Covill will open a jewelry store in Brockwayville, Pa.

F. S. Neilton, Martinsville, Ill., has given a bill of sale for \$160.

O. M. Campbell, Denison, Ia., has given a bill of sale for \$3,200.

George Hay, Attica, Ind., has given a real estate mortgage for \$1,000.

R. W. Creech, Rich Hill, Mo., has given a chattel mortgage for \$200.

Myron Du Bois, Little Falls, N. Y., has bought a new store in that town.

Charles O. Howe, Nickerson, Kan., has given a chattel mortgage for \$5,000.

Morris Leavey, of Morris Leavey & Son, Washington, D. C., died last week.

Eunice L. Kaiser, Rochester, N. Y., has given a chattel mortgage for \$5,948.

Geo. H. Doyle, Lynn, Mass., has mortgaged stock fixtures etc., for \$1.

The store of J. W. Williams, King City, Mo., was burned out a few days ago.

A judgment for \$127 has been entered against J. M. Balmaine, Buffalo, N. Y.

L. M. Folleth and wife, Marshfield, Wis., have given a chattel mortgage for \$150.

A judgment for \$400 has been entered against A. B. Spencer, Webster City, Ia.

In a fire last week in Fort Worth, Tex., the store of F. A. Boerner was burned out.

Thomas J. Zimmer, Jr. has started in business at 5 Garden St., Poughkeepsie, N. Y.

C. L. Herrick, of Herrick & Co., Manacelona, Mich., has given a bill of sale for \$1,936.

A. J. Applegate, Cambridgeport, Mass., has given two chattel mortgages aggregating \$1,900.

G. W. Kennedy, of Chicago, will open a new jewelry store in the Vaughan block, Richmond, Ind.

Frank M. Yerrick, Jackson, Mich., has sold out, and has discharged a chattel mortgage for \$2,873.

The proposed establishment of a silver ware manufactory in Haverhill, Mass., has been abandoned.

Two judgments aggregating \$425 have been entered against Geo. P. Crittsinger, Lancaster, N. Y.

John L. F. Janssen, Green Bay, Wis., has bought a house, which he will remodel for his jewelry business.

C. Vander Elsen, lately with H. Vander Zanden, De Pere, Wis., has opened a jewelry store in Appleton, Wis.

G. L. Edwards, of Eldorado, Kan., has moved to Wichita, Kan., where he has purchased a jewelry store.

W. E. Marter, optician, Lebanon, Pa., has suspended business and removed his goods.

Elmer Cole, of Bethel, Me., has removed to Washington, D. C., where he will engage in the jewelry business.

Olaf Schave has removed from Springfield, Ill., to Illiopolis, Ill., where he has entered the jewelry business.

N. Willis, Palmyra, Wis., has taken Joshua Hughes into partnership, and the firm name now is Willis & Hughes.

William A. Kraft, jeweler, Johnstown, Pa., was on Saturday united in marriage to Miss Josephine Green, in Sterling, Ill.

Bert Jones, Boulder, Col., has disposed of his interest in the jewelry store and with his wife has gone to Lower California.

Emille Ville, of Dreher, N. Y., moved to New York about six weeks ago and last week moved back to his farm in Pike county.

The store of Geo. P. Rose & Co., Dubuque, Ia., has been closed on a chattel mortgage, and the firm have been attached for \$490.

Elmer L. Horn, formerly employed at Mrs. J. E. Bixler's store, Easton, Pa., has opened a repair shop in the Reeder building, that city.

The jewelry store of I. P. Thompson, 394 Marietta St., Atlanta, Ga., was burglarized a few nights ago and over 100 watches were taken.

Irwin Runyeon, 426 Penn St., Reading, Pa., has sold his stock and good will to James M. Burkhart, formerly connected with G. A. Schlechter.

In a fire in Parkersburg, Ia., the jewelry store of H. A. Ogline was burnt out as well as that of C. E. Frederick as reported last week in THE CIRCULAR.

In a disastrous fire in Hattiesburgh, Miss., the jewelry business of S. O. Harris was damaged to the extent of \$150 in moving stock, etc. No insurance.

Jacob Sneider, a jeweler working for Marcus Marks, Braddock, Pa., committed suicide last Tuesday, by taking rat poison. He had been on a week's debauch.

The store of Charles F. Von Kanel, Massillon, O., was burned out completely last week; loss \$1,000. The store and contents, with the exception of the safe were fully insured.

W. C. Metzger, a New York jeweler who is out of employment, and who has been lodging at the house of Mrs. Elrich, 1303 Oak St., Kansas City, Mo., was last week accused by her of stealing \$480. He was arrested and lodged in jail, but was released after a hearing before a justice of the peace.

On Thursday, James Keenan, thought to be a professional crook, was arrested by a railroad detective on a C., H. & D. train at Lima, O. He had fourteen watch cases, one watch and a large quantity of chains on his person. He admitted to the officers that he had robbed a jewelry store at Kalamazoo, Mich.

### The Attleboros.

Chas. G. Dahlgren has given a chattel mortgage for \$148.

E. S. Horton, of Horton, Angell & Co., has bought real estate for \$1.

H. T. Regnell is the new president of the Evangelical Sunday School Association, of Bristol county.

The Prohibitionists have nominated Walter E. Sanford for councillor and G. H. Robinson for representative.

R. F. Simmons will return to Los Angeles, Cal., about Nov. 1st. The severe climate of this part of New England seriously affects Mr. Simmons' health.

James H. Sturdy, J. E. Tweedy, Wallace E. Franklin, Elton I. Fisher and E. D. Guild have returned from the World's Fair. H. M. Daggett, James F. Leary and Frank Ogilvie, salesman for H. H. Curtis & Co., have gone to Chicago.

Last Sunday, Mrs. W. D. Wilmarth, wife of the late W. D. Wilmarth, died suddenly. She was the mother of H. A. Wilmarth, E. D. Wilmarth and W. H. Wilmarth, all of whom have figured prominently in the jewelry trade. The funeral Thursday was an important one.

THE CIRCULAR correspondent interviewed several of the manufacturers during the past week on the question of business, and the substance of the replies is that trade is excellent and the number of orders received during the last ten days were in excess of any ten days for five months.

### Pittsburgh.

The suit of B. E. Arons vs. M. J. Smit resulted in a verdict of \$456 in favor of Arons.

C. T. Ahlborn is visiting friends in Kittanning. Clyde Sankey, also of the Eisner building, leaves for Chicago this week.

Heeren Bros. & Co. have already received eighty-five cases of imported goods and eighteen cases are expected in this week. The new building is assuming a decidedly finished appearance and the removal is expected to take place about Jan. 1st.

Traveling men in Pittsburgh, Pa., last week were: R. M. Hamilton, Hamilton & Hamilton, Jr.; M. Baum, Rothschild Bros.; Dick Robinson, Thos. G. Frothingham & Co.; Mr. Thornton, Wightman & Hough Co.; Mr. Stern, Stern Bros.; Mr. Kaufman, Bohl Bros. & Co.; Jacob Bennett, Jacob Bennett & Son.; Mr. Woods, Dominick & Haff; J. Weinmann, Weinmann Bros. & Co.; Sol Sickles, M. Sickles & Co.; W. E. Cattelle, H. E. Oppenheimer & Co.; Mr. Strauss, Jacob Strauss & Sons; L. C. Reissner, Ezra F. Bowman & Co.; W. S. Davis, H. Muhr's Sons; Lawrence H. Smith, Bippart & Co.; Luther Hyde, Reed & Barton; D. Skutch, Waterbury Clock Co.; H. W. Towade, N. Glauber & Co.

The Latest Patents.

ISSUE OF OCTOBER 10, 1893.

**506,268. SETTING FOR DIAMONDS AND THE LIKE.** NUTA M. SIDLITZ, Baarn, Netherlands. Filed Oct. 8, 1892. Serial No. 448,184. (No model.) Patented in England Oct. 1, 1892, No. 17,499; in France Oct. 1, 1892, No. 224,680; in Belgium Oct. 1, 1892, No. 101,573, and in Austria-Hungary, Apr. 20, 1893, No. 2,593 and No. 66,390.

The setting for small ornamental stones, pearls and the like, and for facilitating and securely fastening the



same upon ladies' dresses to ornament the same, consisting of a small cup-shaped setting provided at its back with projecting pins or prongs adapted to be passed through the material of the dresses and to be bent over onto the back of the material so as to securely fasten and lock the setting to the dress.

**506,285. PROCESS OF PLATING METALS.** CARL VATSKY, Bornheim, assignor of one-half to Edward Goll, Offenbach-on-the-Main, Germany.—Filed Jan. 11, 1893. Serial No. 458,044. (No specimens.)

The method of plating one sheet of metal with another sheet of metal, consisting, first, in covering each sheet with a layer of soft solder, the layer on the

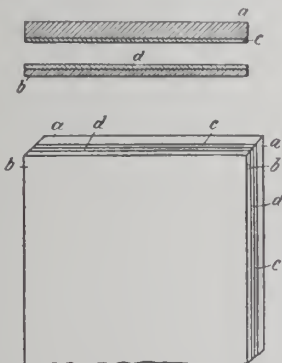

metal with the higher fusing-point being less fusible than the other layer, and second, in putting both sheets with their layers of solder together, and heating the compound-plate from the side of the metal with the higher fusing point.

**506,399. COLLAR-BUTTON.** MIKE HENRY, Wesson, Miss., assignor of one-half to Wiley E. Oliver, same place.—Filed Jan. 9, 1893. Serial No. 457,748. (No model.)

The button having tubular stem 2 provided with an indentation 3, tubular stem 4 provided on its exterior

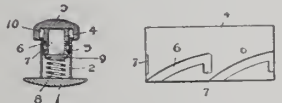

with the oblique curved groove 6 which communicates with a recess 7 and a spring to hold said projection in the recess said spring having a bearing plate 9.

**506,410. WORKMAN'S TIME-RECORDER.** HERBERT D. BENNETT, Columbus, Ohio, assignor to the National Time Register Company, same place.—Filed Aug. 20, 1892. Serial No. 443,626. (No model.)

**506,621. JEWEL-SETTING.** ACHILLE BIPPART, and JOHN H. THEBERATH, Newark, N. J., assignor to Bippart & Co., same place.—Filed May 9, 1893. Serial No. 473,532. (No model.)

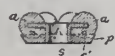

The jewel setting comprising the plate  $\beta$  having the aperture  $\sigma$  and series of cups  $\epsilon$  with radical pins  $\epsilon'$

therein, and the stud  $s$  fitted to the aperture  $\sigma$  at one end and having the pins  $d$  upon the other end.

**506,625. ALARM-CLOCK.** NORTON CASE, St. Louis, Mo., assignor of one-half to Benjamin Gratz, same place.—Filed Dec. 5, 1892. Serial No. 454,980. (No model.)

In a signal or call, the combination of the clock

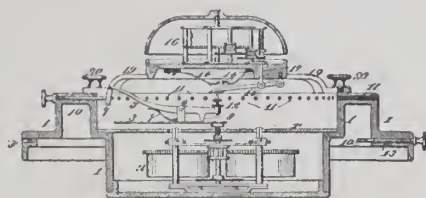

mechanism, a pivoted lever carried by the clock mechanism, removable pins adapted to engage the outer end of the lever, and an alarm adapted to be engaged by the inner end of the lever.

**DESIGN 22,829. HANDLE FOR FORKS, &C.** JOHN T. CURRAN, Brooklyn, assignor to Tiffany



& Co., New York, N. Y.—Filed Aug. 28, 1893. Serial No. 484,237. Term of patent 7 years.

**DESIGN 22,830. HANDLE FOR SPOONS, &C.** JOHN T. CURRAN, Brooklyn, assignor to Tiffany

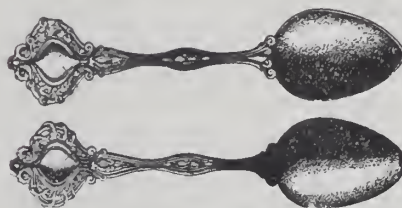

& Co., New York, N. Y.—Filed Aug. 28, 1893. Serial No. 484,238. Term of patent 7 years.

St. Louis.

R. O. Balt, with the Mermod-Jaccard Jewelry Co., assisted by C. F. Simmons, M. D. organized the biggest Sunday school in the city last Sunday at Centenary church.

F. Harker, a watch agent, has been arrested by the police for making an alleged fraudulent contract with one, Harmot Lungue.

Herman C. Grawe was nominated by the Republicans last Thursday as one of their four candidates at large for School Director. Mr. Grawe is about 40 years old and has been an active politician for some time.

A letter from M. A. Jewett, the United States Consul at Sivas, Turkey, was submitted to Judge Woerner, of the Probate Court last Monday afternoon. In the letter the Consul states that Mrs. G. E. Effendian, an Armenian who had resided in Philadelphia for some time was anxious to learn about the property of her deceased brother, Kevork Hejadarian, who was in the jewelry business in St. Louis, and left property of which her share she believes is about \$400.

The deed has been recorded by which the extensive property of the Russell & Jones Mfg. Co., Pittsfield, Mass., including considerable land and a four-story brick building, with over 100 feet frontage, is transferred to A. W. Eaton, a paper manufacturer.

Trade Gossip.

H. H. Heinrich, 14 John St., New York, has received at the World's Fair, Chicago, the highest award, consisting of a medal and diploma, for his exhibit of marine chronometers. Mr. Heinrich was equally successful at Berne, Switzerland, in 1858 and at Paris in 1889. With the above indorsements jewelers can safely depend upon the excellence of Mr. Heinrich's chronometers either new or second hand.

Steiner, Davidson & Co., the well-known importers of fine fans and fancy goods, 547 Broadway, New York, are now showing a complete line of the latest Paris and Vienna novelties in fans. Those with the Empire and Renaissance decorations are exceedingly handsome, especially when ornamented with exquisite paintings of figures. Their beauty and quality make them a particularly desirable line for the jewelry trade to handle.

The 1894 catalogue of Lapp & Flershem, Chicago, will come from the press about Nov. 1st, and contain in its 864 pages, illustrations and descriptions of every article required by the retail trade. A class of goods yet finer than those of previous seasons characterizes the book, and a result of Mr. Lapp's personal conduction of the work is noticed in the unapproachable selection of lines. The issuing of the work will be looked forward to with pleasure by jewelers who are abreast of the times.

The title page of the September number of the *New York Jeweler*, a monthly publication issued by S. F. Myers & Co., is ornamented with two engravings, one representing a gladiator of ancient times shattering pillars labeled "Old Fogyism," "High Prices," "Exclusive Lines," "Cheap Credits," "Big Profits," and "Ancient Business Methods"; and another showing the same gladiator erecting a new temple with foundation stones appropriately named "Principle," and "Economy"; then "Pluck," "System," "Brains," "Capital," and capping it with "Success." Nothing can be more appropriately said of this enterprising firm, than what is told by these copyrighted and pointed cartoons. The grand army of friends and customers of the house have been and is growing daily. The new stores and salesrooms, covering seven immense floors of the twelve in the Myers Building, show a wonderful array of everything required by the jeweler and they will miss an opportunity who fail to pay a visit to S. F. Myers & Co.'s establishment, 48 & 50 Maiden Lane, New York.

One of the biggest successes of the season, particularly in leather and silver combinations, is the line of reptile skin articles with magnificent silver decorations lately introduced by Deitsch Bros., 7 E. 17th St., New York. These leathers are either of lizzard or snake skin in their natural colors, and are made in an extensive variety of articles among which are card cases, pocket-books, photo frames, calendars, folios,

# CLASSIFIED INDEX TO ADVERTISEMENTS.

All Advertisements are entitled to one insertion under proper heading. Extra insertions, \$6.00 per annum. Extra Headings, \$12.00 per annum.

<b>Art Pottery, Bric-a-brac, Etc.</b>	Page.	<b>Gold Jewelry.</b>	Page.	<b>Show Cases.</b>	Page.
Ahrenfeldt & Son, 56 Murray St., N. Y.....	44	Bippart & Co., Newark, N. J.....	7	Smith, B. & W. B., 220 W. 29th St., N. Y.....	52
Bing, Ferdinand & Co., 106 Grand St., N. Y..	42	Carter, Sloan & Co., 15 Maiden Lane, N. Y....	39	<b>Silver Mounted Ebony Goods.</b>	
Borgfeldt, Geo. & Co., 18, 20 & 22 Washington		Kremetz & Co., 182 Broadway, N. Y.....	11	Deitsch Bros., 7 E. 17th St., N. Y.....	2
Place, New York.....	47	Racine Jewelry Mfg. Co., Racine, Wis. ....	25	<b>Silversmith.</b>	
Bradley & Hubbard Mfg. Co., Meriden, Conn	11	Smith, C. Sydney, 191 Broadway, N. Y.....	8	Rohrbach, Henry J., 94-96 State St., Chicago, 26	
Buning, F. W. & Co., 58 Murray St., N. Y....	50	Street, Geo. O. & Sons, 15 John St., N. Y.....	51	<b>Silver Plated Ware.</b>	
Gleanzer Leon, J. & Co., 80 & 82 Chambers		Uhry, Chas. L. & Co., Newark, N. J.....	32	Homan & Co., Cincinnati, O.....	21
St., N. Y.....	45	<b>Horological Schools.</b>		Pairpoint Mfg. Co., New Bedford, Mass.....	5
Haviland & Abbott, 29 Barclay St., N. Y.....	49	Chicago Watchmakers' Institute, Chicago, Ill.	26	Rogers & Bro., 16 Courtlandt St., N. Y.....	12
Hinrichs & Co., 29 & 31 Park Place, N. Y.....	50	Parson's School for Watchmakers, Peoria, Ill.	26	Rogers, Smith & Co., Meriden, Conn.....	10
Le Boutillier & Co., 860 Broadway, N. Y.....	35	Palmer & Swain, Waltham, Mass.....	41	<b>Sterling Silverware.</b>	
Leonard, P. H. 76 & 78 Reade St., N. Y.....	48	<b>Hotels.</b>		Campbell-Metcalf Silver Co., Providence, R. I.	38
Maddock & Co., 21 Barclay St., N. Y.....	50	Gibson House, Cincinnati, O.....	25	Dominick & Haff, 860 Broadway, N. Y.....	3
Vantine, A. A., & Co., 877 Broadway, N. Y....	46	<b>Jewelry Mailing Boxes.</b>		Durgin, W. B., Concord, N. H. ....	4
<b>Assayers &amp; Refiners.</b>		Am. Railway Supply Co., 24 Park Place, N. Y.	52	Gorham Mfg. Co., Broadway & 19th St., N. Y. 14, 15	16
Clark, J. L., Philadelphia, Pa.....	41	<b>Jewelry, Silverware and Optical Cases.</b>		Kerr, Wm. B. & Co., 860 Broadway, N. Y.....	16
Howard, S. P., 8 John St., N. Y.....	52	Birmingham, Wm. & Co., 728 Arch St., Phila.	51	Knowles, J. B. & S. M., Co., Silversmiths'	
<b>Auctioneers.</b>		Borgzinner, S. & A., 82 & 84 Nassau St., N. Y.	49	Hall, Union Square, N. Y.....	8
Comrie, A. J., P. O. Box 2493, New York....	51	Jackson, S. C., 180 Broadway.....	50	Ovaïtt & Warner, Portland, Oregon.....	25
Scott, De B. O., 20 Murray St., N. Y.....	12	Troeschler, A. & Co., 69 Nassau St., N. Y.....	38	Reed & Barton, 37 Union Sq., N. Y.....	27
Tirrell, R. W., 14 Pembroke St., Boston, Mass.	51	Wiggers & Froelick, 60 Nassau St., N. Y.....	38	Shiebler, Geo. W., Co., 179 Broadway, N. Y. ...	51
<b>Badges, Medals, Etc.</b>		<b>Jobbers, Watches, Diamonds, Etc.</b>		Towle Mfg. Co., Newburyport, Mass.....	51
Irons & Russell, Providence, R. I.....	25-28	Aikin-Lambert Jewelry Co., 19 Maiden Lane..	7	Wallace, R. & Sons Mfg. Co., 3 Park Place,	
Schlechter, G. A., Reading, Pa.....	32	Bonnet, Albert H., Columbus, O.....	2	N. Y.....	6
Stockwell, E. R., 19 John St., N. Y.....	51	Bowman, Ezra F. & Co., Lancaster, Pa.....	41	Wood & Hughes, 10 John St., N. Y.....	38
Wilson, Chas. G., Reading, Pa.....	10	Cross & Bequelin, 17 Maiden Lane, N. Y.....	12	<b>Stem Winding Attachments.</b>	
<b>Cleaning Solution.</b>		Giles Bros. & Co., W. H. Gleason, receiver,	27	Abbott, Henry, 2 Maiden Lane, N. Y.....	7
Quarters, W. F., Providence, R. I.....	7	Chicago, Ill. ....	27	<b>Tool Manufacturers and Dealers.</b>	
<b>Clocks, French and English.</b>		Myers, S. F. & Co., 48 Maiden Lane, N. Y....	52	Bullock, O. W., Springfield, Mass.....	7
Jacques, Chas., Clock Co., 22 Courtlandt S.,		<b>Leather and Silver Goods.</b>		Gesswein, F. W., 39 John St., N. Y.....	8
N. Y.....	52	Deitsch Bros., 7 E. 17th St., N. Y.....	2	Horological Tool Co., Chicago, Ill.....	26
Kroeber F., Clock Co., 360 Broadway, N. Y....	48	<b>Musical Boxes.</b>		Logan, A. J., Waltham, Mass.....	41
<b>Diamond Cutters.</b>		Jacot & Son, 298 Broadway, N. Y.....	24	Mosely & Co., Elgin, Ill.....	29
Humphrey, J. B., Boston, Mass.....	52	<b>Optical Goods.</b>		Oliver, W. W., Buffalo, N. Y.....	51
<b>Diamond &amp; Precious Stone Importers.</b>		Kirstein, E., Sons Co., Rochester, N. Y.....	5	<b>Tortoise Shell Goods.</b>	
Disselkoen, John N., 19 E. 16th St., N. Y.....	39	Laurencot, Jules, 49 Maiden Lane, N. Y. ....	10	Potter, W. K., Boston, Mass.....	37
Eichenberg, Julius, Providence, R. I.....	12	Queen & Co., Philadelphia, Pa.....	5	<b>Trunks and Traveling Bags.</b>	
Falkenau, Oppenheimer & Co., 40 Maiden		The Nous Verons Co., Boston, Mass.....	8	Crouch & Fitzgerald, 161 Broadway, N. Y....	51
Lane, N. Y.....	52	Winsted Optical Co., Winsted, Ct.....	9	<b>Watch Case Manufacturers.</b>	
Hahn, Rud. C., 194 Broadway, N. Y.....	10	<b>Pens, Pencil Cases, Etc.</b>		The Planchamp & Becker Co., Chicago, Ill... 26	
Hedges, Wm. S. & Co., 170 Broadway, N. Y..	38	Aikin, Lambert & Co., 19 Maiden Lane, N. Y.	9	The Wadsworth Watch Case Co., Newport,	
Juergens & Andersen Co., Chicago, Ill.....	22	Beauniel, D. W., 17 John St., N. Y.....	51	Ky.....	22
Kahn, L. & M. & Co., 10 Maiden Lane, N. Y.	52	Smith, H. M., & Co., 83 Nassau St., N. Y.....	52	<b>Watchman's Clocks.</b>	
Kipling, R. A., Hays Bldg., N. Y.....	38	The Boston Pen Co., Boston, Mass.....	41	Hausburg, O. E., 41 Maiden Lane, N. Y.....	7
Nissen, Ludwig & Co., 18 John St., N. Y....	38	<b>Patents.</b>		<b>Watch Importers.</b>	
Randel, Baremore & Billings, 29 Maiden Lane,	39	Cox & Sons, 11 Park Row, N. Y.....	37	Hyde's, J. E., Sons., 22 Maiden Lane, N. Y... 52	
Scott, J. T. & Co., 4 Maiden Lane, N. Y.....	31	<b>Pocket Cutlery.</b>		Mathey Bros. & Mathez Co., 21 & 23 Maiden	
Smith, Alfred H. & Co., 182 Broadway, N. Y.	83	Beach, H. B. & Co., Boston, Mass.....	51	Lane, N. Y.....	9
Wolff & Gunzburger, 87 Nassau St. N. Y.....	52	<b>Ring Makers.</b>		<b>Watch Keys.</b>	
<b>Diamond Jewelry.</b>		Bryant, M. B. & Co., 10 Maiden Lane, N. Y..	52	Clark, A. N., Plainville, Conn.....	10
Waterman & Lehman, 37 Maiden Lane, N. Y.	38	Bowden, J. B. & Co., 192 Broadway, N. Y....	7	<b>Watch Manufacturers.</b>	
<b>Enameled Tableware.</b>		Haskell, Henry C. 11 John St., N. Y.....	12	Baume & Co., London, England, and Syracuse,	
Sampson, Sophus, Chicago, Ill.....	25	Hildreth Mfg. Co., 51 Maiden Lane, N. Y....	11	N. Y.....	21
<b>Eye Glass Holders and Chains.</b>		Larter, Elcox & Co., 21 & 23 Maiden Lane,	30	<b>Watch and Clock Oils.</b>	
Merritt, S. F., Springfield, Mass.....	9	N. Y.....	30	Nye, Wm. F., New Bedford, Mass.....	22
<b>Fine Stationery.</b>		<b>Rolled Plate Jewelry.</b>			
Parsons, Green & Co., 18 Murray St., N. Y....	5	Dederick, J. H., 16 Maiden Lane, N. Y.....	41		
<b>Gold and Silver Plating.</b>		<b>Sample Trunks.</b>			
Brunor Plating and Jewelry Repairing Co....		Crouch & Fitzgerald, 161 Broadway, N. Y....	51		
Maiden Lane, N. Y.....	9	<b>Settings and Galleries.</b>			
H. B., Bolstad, Plating Co., Chicago Ill.....	25	Blancard & Co., 76 John St., N. Y.....	31		

## Special Notices.

Rates 75c. per insertion for notices not exceeding 3 lines (25 words), additional words 2 cents each. If answers are to be forwarded, postage stamps must be enclosed. Two insertions, 15 per cent. off; three insertions, 20 per cent. off; four insertions or more, 25 per cent. off. Payable strictly in advance. Display cards on this page will be charged at \$2.00 per inch for first insertion, subject to same discount as above for subsequent insertions.

Under the heading of **Situations Wanted** on this page advertisements will be inserted for One Cent a Word. This offer refers to **Situations Wanted only**. Payable strictly in advance. If answers are to be forwarded, postage must be enclosed.

## Situations Wanted.

Notices under this heading **ONLY** are charged at one cent a word, payable strictly in advance. If answer are to be forwarded, postage must be enclosed.

**SITUATION WANTED.**—An experienced traveler wishes a position in a first-class house. Many years on the road and well acquainted in all sections east of Omaha. Diamond house preferred. Address E. D., JEWELERS' CIRCULAR.

**I AM A GOOD WATCHMAKER** and wish a good situation. Samuel L. H. Simpson, Winona, Minn.

**WATCHMAKER AND OPTICIAN**, "experienced," wants position of responsibility. Am thorough man. No cheap houses need apply. Address T. B., 213 N. Franklin St., Delaware, O.

**A YOUNG MAN**, twenty years of age, with some knowledge of the business, wishes position where he can have practical experience at the bench. Has had experience as salesman. Best of references. Address W. S. Macmillan, 34 North Ferry St., Schenectady, N. Y.

**FIRST-CLASS WATCH REPAIRER**, jeweler, fair engraver, twenty-two years' experience. All tools. Like to hear from good houses, who appreciate a good workman. Conrad Kohler, Linden, Michigan.

**BY** a practical jeweler, and watchmaker: 10 years on complicated work; A 1 references and tools; wages \$15 per week. Address B. W., care CIRCULAR.

**WANTED.**—Position by first-class watchmaker, jeweler and repairer of musical toys, etc.; can put my hand to any variety of repairing; have all my own tools; 30 years' experience; good references. Address D. H. Jaccard, Westwood, N. J.

**TO DIAMOND CUTTERS AND POLISHERS.**—A young woman desiring to learn either diamond cutting or polishing would like to become an apprentice in a shop. Compensation no object at the beginning. Address M. V., 133 St. Felix St., Brooklyn, N. Y.

**POSITION WANTED.**—By optician and salesman. Clock and jewelry repairer. Can assist in watch work. Good references. New England, Middle and Southern States preferred. Address O. S. J., care JEWELERS' CIRCULAR.

**TRAVELER** open for engagement 1st January. Twelve years on the road with watch, jewelry and diamond houses. Best of references. Address Engagement, care of JEWELERS' CIRCULAR.

**WATCHMAKER, SALESMAN.**—Eighteen years' experience. Married. Reference from employer for ability. Good habits. Permanence desired. Address Empire State, care JEWELERS' CIRCULAR.

**WANTED.**—Situation as watchmaker by young man of twenty-four; can do all watch and jewelry repairs and script engraving; sober and industrious; good set of tools; A 1 references. Address "Enterprise," 161 Dayton St., Cincinnati, O.

**SITUATION WANTED** as watchmaker, clock and jewelry repairer; over five years' experience; good references. Address A. Austin Wilmot, Salem, N. J.

**POSITION WANTED** in New York or Newark by stone-setter; close pearl work preferred; good references. W. O. Bush, Garfield, N. J.

**SITUATION WANTED** by a young man twenty-two, with three and a half years' experience on watch, clock and jewelry repairing; owns own tools; American lathe and bench. Address A. E. Anderson, Milwaukee, Wis.

**WANTED.**—Position by an A 1 watchmaker, jeweler and salesman; twelve years' experience; have full set of tools; references exchanged. Address Permanent, care Perkins & Co., Poughkeepsie, N. Y.

**BY** first-class watchmaker, eight years' experience. Best of references given and expected. Address Lock Box 207, Cartersville, Mo.

**A RELIABLE** man with a fair knowledge of the retail trade and repairing; have nearly all tools; good salesman; habits and references, A 1; wages \$12 per week. Address Geo. E. Metcalf, Norfolk, Conn.

**ENGRAVER OF JEWELRY**; first class letter and monogram; can do copper plate work; six years' experience in large city; good reference. Box 74, Comanche, Iowa.

**A GENTLEMAN**, first-class designer, seeks engagement as manager or assistant in a silverware factory. Address O. P., care JEWELERS' CIRCULAR.

**GOOD WATCHMAKER** and jeweler wants situation at once; own tools; plain engraver; diamond setter; best references. "G. A.," care H. Oppenheimer & Co., Kansas City, Mo.

**POSITION AS TRAVELING SALESMAN** for a responsible house in the diamond, watch, clock, jewelry or optical business. Wideawake single man, a practical jeweler, diamond setter, graduate optician. Best references. Address U. S. Standard, Houston, Texas.

**SITUATION WANTED** as watchmaker, clock and jewelry repairer. Have my own tools and first class references. Address A. 34, care JEWELERS' CIRCULAR.

**WATCHMAKER**—Seven years' experience, own tools, good references—wants position. Address A. F. Diener, Burlingame, Pa.

**SITUATION WANTED** by a first-class watchmaker and jeweler, with good tools; 13 years' experience; can furnish first-class references; will work for \$15 a week. Address T. H. W., care JEWELERS' CIRCULAR.

**I AM** 20 years old; have had 4½ years' experience in watch, clock and jewelry repairing; can also wait on trade, and do plain engraving; do not use tobacco nor liquor; can come at once, recommended. Mac, 95 Main St., Burlington, Vt.

## Help Wanted.

**WANTED**—A first class engraver and designer. Send samples of work and state salary expected. Maier & Berkele, Atlanta, Ga.

**WANTED.**—First-class jeweler and engraver; steady work; wages \$18; must come well recommended for honesty, industry and sobriety. Send sample of engraving. E. W. Blue, Atlanta, Ga.

**WANTED** in a wholesale office, a strictly honest, bright young man from eighteen to twenty one years old; must be a good penman and correct at figures and must reside in Newark, N. J. Address with references, F. H. Dickson, P. O. Box 2927, New York.

## To Let.

**FOR RENT** in Virginia, town of 3,000 inhabitants, No. 1 store with fixtures; good stand; no other jewelry store in the place. Owner moved to city. Address 309 Main St., Danville, Va.

## For Sale.

**FOR SALE.**—Jewelry stock and good will. Location the best in the city; must be sold at once. For further particulars address C. Gerlach, 5 N. High St., Columbus, O.

**FOR SALE.**—Well established jewelry stand, the finest in the State; good business; will sell cheap for cash. Geo. W. Weaver, 86 Main St., Lockport, N. Y.

**FOR SALE OR LET ON ROYALTY.**—Patent Safety attachment for Brooches and Hairpins. Can be applied to any kind of Jewels, old or new, at trifling cost. This is one of the best, simplest and cheapest arrangements for preventing jewels from being lost or stolen ever offered for sale. Patented in this country, England, France and Belgium. Address, Wm. Walthie, Worcester, Mass.

**FOR SALE.**—Stock of jewelry and fixtures; cheap; in healthy Colorado town; population 2,500; good opening; small competition; reasons for selling. Lock Box 53, Fort Collins, Col.

## FOR SALE.

### THE JEWELRY MANUFACTURING PLANT

of the late Walter E. White, located at 86 Page St., Providence, R. I., consisting of machinery, tools, fixtures, stock, good will, etc.; to parties desirous of engaging in this business the well-known popularity and standard quality of the goods always manufactured by this firm makes this an exceptional opportunity, and one that rarely offers. Apply to WM. G. HOPKINS, Administrator, 53 Clifford St., Providence, R. I.

## TRUSTEE'S SALE.

**THE** undersigned will sell privately upon most advantageous terms to purchasers, either as a whole or in such parts as may be desired, the stock of jewelry and store fixtures of James E. Tyler, 807 East Main Street, Richmond, Virginia, said stock being in point of extent, selection, quality and variety unsurpassed in the South. Arrangements can be made, if desired, for the purchase of the good will of the business of James E. Tyler, who with his predecessors, John H. Tyler & Co., Mitchell & Tyler and William Mitchell, Jr., has conducted in the City of Richmond the jewelry business for the better part of this century, and has always commanded the cream of city and State custom. Richmond presents at this particular time an exceptionally fine opening to persons desiring to embark in the jewelry business under such auspices. Correspond with John Pickrell, Trustee, State Bank Building, Richmond, Va.

## Miscellaneous.

**I BUY JEWELRY STOCKS**—Manufacturers, jobbers and retailers desiring to dispose of surplus or entire stocks of diamonds, watches and jewelry can find quick cash buyer by addressing Stephen S. Harmon, 134 East 96th St., New York city.

**WANTED.**—A few more students to learn engraving at Trowbridge's School of Engraving, Winona, Minn. Lowest rates of any school. Board to be had for a low figure. New term starting.

## DEMAGNETIZING.

**PERFECT WORK**—Watch repairing in all its branches; all work warranted. Winslow & Penney, 608 Masonic Temple, Chicago.

**A COURSE** of engraving at Trowbridge's School of Engraving, Winona, Minn., is what you want. Write for terms which are the lowest of any engraving school. Board to be had for less than in large cities.

**WANTED, TO RENT SPACE.**—A first-class Watchmaker and Jeweler, with good tools and A 1 references— or will work on commission. Address, W. H. T., care of JEWELERS' CIRCULAR.

## AWARD AT WORLD'S FAIR, CHICAGO, 1893.

The Providence Shell Works.

**W. K. Potter,**  
346 Westminster St., Providence, R. I.



Tortoise Shell Goods, Combs, Hair Ornaments, Jewelry, Etc.

Shell Work made to order on contract. Repairing for the trade in all its branches.

**SOLICITORS OF AMERICAN & FOREIGN PATENTS**

FOR DESIGNS INVENTIONS & TRADE MARKS

SEARCHES MADE & INFRINGEMENT PROSECUTED OR DEFENDED

THE WILL SAVE TIME AND MONEY BY HAVING THEIR PATENTS TAKEN BY

**COX & SONS 11 PARK ROW, N.Y.**

**DIAMONDS.**

**Wm. S. Hedges & Co.,**  
Importers of Diamonds,

And Manufacturers of DIAMOND JEWELRY.

170 Broadway, New York.

27 Holdorn Viaduct, London.

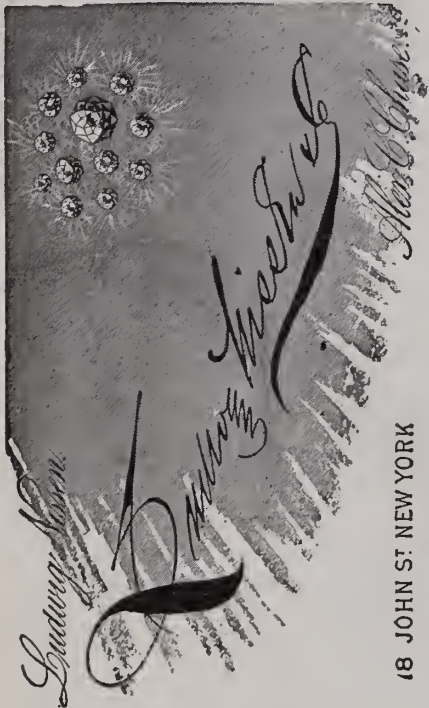

18 JOHN ST. NEW YORK

**R. A. KIPLING,**

Importer of

**PRECIOUS STONES,**

21 & 23 Maiden Lane,

19, RUE DROUOT,  
PARIS.

New York.

**Alfred H. Smith & Co.,**

IMPORTERS

**DIAMONDS**

AND

**PRECIOUS STONES,**

182 BROADWAY, COR. JOHN STREET,

NEW YORK.

33 Holborn Viaduct, London, E. C.

**CAMPBELL-METCALF SILVER CO.**



176 Broadway, N. Y., Room 14. 66 Stewart St., Prov. R. I. Mills Bldg., San Francisco, 8th Floor, Room 1.



Patent applied for.

Victoria Novelties, many fancy shapes. Celluloid Top, Sides, Bottom and Cushions A. TROESCHER & CO., 69 Nassau St., N. Y.

*Our Catalogue No 4 of Diamond Ring Mountings is ready - it is useful, send for it Waterman & Lehmann 37 Maiden Lane New York*

**WOOD & HUGHES.**  
STERLING SILVERWARE MANUFACTURERS  
New York Agents for the Derby Silver Co.'s FINE QUADRUPLE PLATED WARE,  
NO. 16 JOHN STREET, NEW YORK  
206 Kearney St., San Francisco, Cal.  
HASKELL & MUEGGE, Agents.

**WIGGERS & FROELICK,**  
60 NASSAU ST., NEW YORK.  
Sample Cases and Trays  
For Watches, Jewelry, Optical Goods, Etc.  
WE STRIVE TO MAKE THE BEST.

purses, desk pads, cigar cases, prayer books, hymnals, stamp cases, spectacle cases, memo. books, check books, bill folds, cigarette cases, pen wipers etc., etc. By an inspection of these goods the jeweler will readily appreciate the reason of their popularity.

Rice & Hochster, 483 Broadway, New York, have received at the World's Columbian Exposition, a medal and diploma as the highest award on tortoise shell hair pins, Spanish combs, lorgnettes, side combs, daggers and all other articles of this material. Their magnificent exhibit, already described in THE CIRCULAR, well merited this distinction.

One of the first of the firms to import French specialties as clocks, bronzes, bisque, chinaware, etc., into this country on a large scale, was Shepard, Le Boutillier & Co., now LeBoutillier & Co., 860 Broadway, New York. They introduced the first of these goods in 1872 and continued to carry them until a few years ago when they dropped that line to devote all their energies to the famous English wares in which they soon became recognized as leading dealers. In addition to importing these lines, they have now resumed the importation of French goods on a larger scale than before and intend to be on top in this as well as in their other lines. Many surprises may be expected by the trade among the original novelties which this firm are introducing. Their warerooms are replete with only the newest and finest goods, no old stock of any kind being shown. LeBoutillier & Co. are selling their goods at very low prices and they invite jewelers to visit their handsome showrooms whether they purchase or not.

Following the dainty and beautiful "Mazarin" pattern of sterling silver flatware comes from the same manufacturers, Dominick & Haff, 860 Broadway, New York, a pattern which promises to actively rival its predecessor in the great popularity it has enjoyed. This new pattern, the "Tudor", seems to reflect the qualities of the great dynasty of monarchs after whom it is christened, for in its conception it is the quintessence of refined and chaste simplicity. Though rich in graceful curves, no attempt whatsoever has been made to produce elaborate effects. The pattern, therefore, appeals to persons of the most artistic instincts, as well as to those who, desiring an attractive article, demand simplicity in its design. The handle is peculiarly adapted to allow of the engraving of a crest on its surface, and thus, as may be inferred, the pattern appeals also to the most exclusive class of customers. The production of a new pattern in sterling silver flatware is a lottery, but Dominick & Haff have been eminently successful in this respect, as evidenced by the production of the previous notably popular designs, the "Mazarin," "Trianon," "Louis XIV." "Rococo," and "Cupid," recently illustrated in THE CIRCULAR, and their latest artistic work, the "Tudor."

**Fashions in Jewelry and Silverware.**

A LADY'S RAMBLES AMONG THE JEWELERS.

Alexandrite which is green by day and red by night is a woman's stone.

A turquoise tinted bowl with a flat cover of enamel is a pretty salt cellar.

A couple of English walnuts with a jagged opening, reproduced in silver, are designed for salt cellars.

A pearl necklace instead of a clasp is made to cast in a single loop a diamond with a pearl beneath finishing the ends.

In time golf will be celebrated among the decorative sports. A match box is a golf caddie as he stands waiting on golf players.

The yachts are having their turn. Most beautiful match boxes have enameled portraits of the yachts.

Some pretty new letter clips have been introduced. The lower end is a wreath and a bow knot, while streamers combine to make the upper part.

One of the prettiest novelties in enamel is a tiny globe shaped lamp hung from an exquisite little standard of wrought iron. The enamel is transparent and the lamp glows like a jewel.

Golden cornelian is heard much of. Abroad it appears in everything from match boxes to brooches. It looks well as the center of heart shaped brooches or pendants, being of course, enclosed in a rim of jewels to light it up.

A new smoking set had for the cigar holder the model of a wood house without a roof; a rustic well was for cigarettes; the match-holder was a hollow log with an axe laid across. Similar suggestiveness in ornament attracts many people.

The tendency of a woman's belt and skirt to part company gives a new opportunity to jewelers. A woman was seen on Broadway who had established permanent connection between these two articles of dress by means of a long gold bar. It was richly chased and showed to advantage.

An interesting back comb has a series of conventional rays in gold marked with jewels at intervals. These are intended to suggest fruit bearing branches, for coiled around the stem and swinging a curling tail is a jeweled serpent in the act of biting at a diamond that he mistakes for an apple.

The new photograph frames and little articles of bijouterie show a certain sportiveness. A silver frame had a birch bark aspect. Thrust above the opening was a deer's head. Against one side leaned a paddle; on the other side was a rifle and game bag. Another frame in which was a girl's head had a tennis racket and ball puffed up in the side. Croquet mallets are found on other frames; likewise bows and arrows. The deer seems to be a favorite device and enters into many ornaments.

ELSIE BEE.

ESTABLISHED 50 YEARS.

**RANDEL, BAREMORE & BILLINGS,**

IMPORTERS OF

**DIAMONDS.**

AND OTHER PRECIOUS STONFS.

**FINE PEARLS A SPECIALTY.**

MANUFACTURERS OF

**DIAMOND JEWELRY,**

IN THE LATEST DESIGNS.

Diamonds Recut in Modern Styles or Repaired on Premises.

58 Nassau Street,  
29 Maiden Lane  
NEW YORK.

1 Tulp Straat,  
AMSTERDAM.

1 St. Andrews St.  
Holborn Circus,  
LONDON, E. C.



TRADE MARK

ESTABLISHED 1841.

**CARTER, SLOAN & CO.,**

**MANUFACTURERS OF GOLD JEWELRY.**

No 15 MAIDEN LANE,

NEW YORK.

A. CARTER, J<sup>r</sup>.  
A. K. SLOAN.  
C. E. HASTINGS.

GEO. R. HOWE.  
WM. T. CARTER.  
WM. T. GOUGH

FACTORY, NEWARK, N. J.



**JOHN N. DISSELKOEN,**  
Cutter and Importer of  
**DIAMONDS**

FACTORY.  
78 LANGELEEKERSPAD,  
AMSTERDAM.

19 East 16th St.,  
NEW YORK.

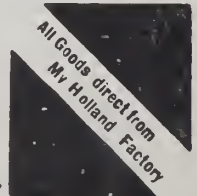

### A Decision of Great Interest to the Jewelry Trade.

A decision handed down Oct. 17th by the United States Circuit Court of Appeals, in the case of Henry Untermeyer *vs.* Max Freund & Co., is one which will be found to be important in all branches of the jewelry trade, as it is the first interpretation of the act of February, 1887, relating to design patents. The suit is over a star design for watch cases, patented by Henry Untermeyer, of Keller & Untermeyer, July 1, 1884, and which was used on watch cases made by Max Freund & Co. in the Fall of 1886.

A suit for damages was then commenced in the U. S. Circuit Court by Untermeyer against Freund. A motion for a preliminary injunction to restrain Freund & Co. from using the design was denied in January, 1887. Two years later when the suit was tried before Judge Coxe, the case was decided in favor of the plaintiff and referred to Samuel H. Blatchford as Master in Chancery to determine the amount of damages to be awarded.

He found that between July 1, 1884, and Jan. 24 1889, the defendants sold and received pay for 275 watch cases bearing the patented design, of which eighty-two were sold before Feb. 4, 1887, and one hundred and ninety-three were sold after that date, that the evidence failed to show what, if any, part of the net profit received by the defendants from the sale before Feb. 4, 1887, or after that date, was due to the patented design, and failed to show that the entire net profit of sales, after Feb. 4, 1887, was due to the patented design. He found that the entire net profit made by the defendants, on watches sold after that date, was \$1,139.02, which was \$881.02 in excess of \$250, and that nominal profits or nominal damages only could be found upon the sales made before that date. The final decree adjudged that the defendants pay to the complainant \$1,139.02, the Master's fees and costs.

Prior to February, 1887, in suits of this kind, the plaintiff could only recover such an amount as he proved accrued from the use of his design patent, but the act of 1887 provided that the defendant might be liable for at least \$250, and in case the total profit on the articles having the infringed design exceed \$250, he shall be further liable for the excess of such profit, over and above that sum.

When Judge Coxe confirmed the report of the Master in Chancery, the defendants through their attorney, Fredrick H. Betts, of Betts, Atterbury, Hyde & Betts, took an appeal to the U. S. Circuit Court of Appeals, attacking the decision, in regard to the validity of the patent, the construction of the act of 1887 by the court below and also the constitutionality of that act. They also claim that as the bill was filed Dec. 3d, 1886, the complainant was not entitled to the total profits, as the act of 1887 allowed.

In the salient parts of the decision of the Circuit Court of Appeals, which is written

by Judge Shipman, the court says after reviewing the testimony:

"If the patented design consisted in a transfer of an old form which had existed upon something else to a watch case, or in the mere adaptation by imitation of a pre-existing form to a watch case, it would not have been an invention. If the adaptation 'is more than the exercise of the imitative faculty, and the result is in effect a new creation, the design may be patentable' (Smith *vs.* Whitman Saddle Co., 148 U. S., 674). In this case, the patented design was not a copy of an old form or an adaptation of the same pre-existing form to a watch case. The elements of the patented design, viz., conventional stars, with or without ornaments, and stars of leaves and projections of various kinds between the leaf points, existed, but arranged and combined in a different manner and producing a resulting appearance and effect which differed materially from the patented design. Its combination was peculiar to itself and had a characteristic grace of its own. While other combinations were graceful and were effective for the purpose for which they were designed, this combination, which seems adapted to ornament a small surface, produced its own effect."

In speaking of the defenses relating to the Act of 1887, it says, after deciding the act constitutional:

"The defendants next insist that, under a proper construction of this statute, all the profits which resulted to the infringer from the sale of the infringing article after February 4, 1889, cannot be allowed, but that his liability extends only to the amount of profits which the complainant can show were due to the use of the patented design.

"The well-settled doctrine of the Supreme Court was and is that the profits to be assessed, under Section 4921 of the Revised Statutes, in suits in equity, for the infringement of a patent, are those only which are properly attributable to the patented feature, and that the evidence of the patentee must 'apportion the defendant's profits and also the patentee's damages between the patented and unpatented feature' (Garretson *vs.* Clark, 111 U. S., 129).

"The manifest purpose of Congress in passing the Act of February, 1887, was to enlarge the remedy against infringers of design patents and to declare that the measure of profits recoverable on account of the infringement should be considered to be the total net profits upon the whole article.

"A construction which should limit a recovery above \$250 to the amount which the complainant could clearly establish to be the value which the design had contributed to the infringing carpets would be at variance not only with the apparent legislative intent, but with the language of the statute. The rule which Congress declared for the computation of profits was the total profit from the manufacture or sale of the article to which the design was applied, as distinguished from the pre-existing rule of the profit which could be proved to be attributable to the design.

"The defendant next insists that inasmuch as the bill was filed December 30th, 1886, the complainant is not entitled, as to sales which were made after February 4th, 1887, to the total profits in the absence of proof that the entire profits were attributable to the use of the design.

"Upon an accounting for an infringement commenced before the bill was filed and continued afterwards, the complainant is entitled to recover the profits derived by the defendant from his infringement to the date of the accounting. 'The practice saves a multiplicity of suits, time and expense,' (Latham *vs.* Lawber, 4 Blatch., 86; Rubber Co. *vs.* Goodyear, 9 Wall., 788; Marsh *vs.* Nichols, 128 U. S., 605). This was also the rule in an accounting under a decree of foreclosure (Robinson *vs.* Bland, 2 Burr., 1086; Holabird *vs.* Burr, 17 Bonn., 593).

"In this case the infringement continued after the bill was filed and after the Act of 1887 went into effect. Under the decree which sustained the patent and found an infringement and directed an accounting, it was the duty of the Master to take an account during the entire period of infringement in conformity with the statutes as they existed at the respective dates when the infringement was committed. The cases of Williams *vs.*

Leonard, 9 Blatch. 476, and Sarven *vs.* Hall, *Id.*, 524, are not applicable. The decision in those cases was based upon the language of Section III. of the Act of July 8, 1870, which limited the remedial provisions of the act to suits and proceedings commenced after its passage.

"Neither is it necessary to consider the rules of equity pleading in regard to amendments relative to circumstances which occurred after the filing of the bill, for there was no necessity for an amendment or for a supplemental bill.

*The decree of the Circuit Court is affirmed with costs.*"

Rowland Cox, the plaintiff's attorney, told a CIRCULAR reporter that he considered this the most notable decision since that of Gorham *vs.* White. Max Freund and his attorneys have an appeal to the United States Supreme Court under advisement.

### Death of Zachariah Dederick.

Zachariah Dederick, a well-known retired assayer and refiner, formerly of Dederick, Sears & Co., 18 Maiden Lane, New York, died suddenly of heart disease, Thursday, while in the office of Lawrence Levy, 62 John St.

Mr. Dederick was born in Catskills, N. Y., March 30th, 1821, and from his boyhood was connected with various branches of the jewelry trade. He first started in business as a pencil case maker, and later as a watch case manufacturer. In 1853 he went into the refining business, and with his brother, J. H. Dederick, and H. B. Sears, formed the firm of Dederick, Sears & Co., now Dederick & Co. He retired from business about nine years ago, and since then has devoted his time to his property interests.

At the time of his death Mr. Dederick lived at the Hotel Balmoral, New York. The funeral services took place Saturday evening.

### Jeweler W. S. Wager Reports that His Store was Robbed.

TROY, N. Y., Oct. 19.—W. S. Wager, 99 Congress St., reported this morning that his store had been broken into last night and the safe robbed of between forty and fifty watches left by customers to be repaired. The doors of the store had both been locked last night and both were found locked this morning. The fan-light over the door was open.

Mr. Wager could not tell the exact number of watches missing or the names of the customers to whom they belong. He estimates his loss at about \$2,000.

MR. WAGER'S STORE CLOSED BY THE SHERIFF.

TROY, N. Y., Oct. 21.—W. S. Wager's store was closed last evening by Deputy Sheriff Yadeau, on an execution in favor of Belle McKee and Alvin H. Cipperly, who obtained judgments against Wager for \$1,114.

The Tudor Optical Co., Omaha, Neb., have given a bill of sale for \$7,500.

Sam Bauman, of the Bauman-Massa Jewelers' Supply Co., St. Louis, spent a few days in Chicago on business.



## The Chemical Composition of the Diamond.

UNTIL lately, all the books of instruction as well as scientific works taught that the diamond consisted of pure carbon crystallized in the shapes of the regular system. Henri Moissan, well-known in the world of science by reason of his experiments for producing diamond artificially, full descriptions of which have appeared in THE CIRCULAR, published in a recent number of the *Comptes rendus* the results of his exhaustive experiments concerning the chemical composition and peculiarities of the diamond. The numerous specimens of this gem examined by him, came from the Cape as well as from Brazil, and after combustion left traces of ashes, which invariably contained silicium and iron, the presence of which could be proved; only one Brazilian diamond, of a greenish color, contained no iron. Many specimens also contained calcium (lime).

As concerns the peculiarities of the diamond, Mr. Moissan could establish that its temperature of combustion stands in a certain ratio to its degree of hardness, the height of the former increasing with the latter. The limits between which the temperature of combustion moves are 760° C. (1,400° F.) and 875° C. (1,600° F.) provided the combustion is effected in chemically pure oxygen. The experiments of Mr. Moissan on the influence of other gases and vapors upon the diamond at an increased temperature are interesting. According to his findings, sulphur vapor acts upon the black variety, the so-called carbonado, even at the relatively low temperature of 900° C. (1,652° F.) thereby forming carbon disulphide. The paler varieties, however, are by sulphur vapor attacked only at a temperature above 1,000° C. (1,832° F.). An influence of dry chlorine and dry hydric chloride could not be proved even at the temperature of 1,200° C. (2,192° F.).

As regards the metals, sodium (natrium) even in the form of vapor, combines in no wise with the diamond, while platinum forms an homogeneous enamel with it. The behavior of iron is of a special interest; at its temperature of melting an energetic reaction takes place, and a product is formed from which graphite separates after cooling. In highly heated potassium or sodium carbonate, the diamond dissolves rapidly, forming carbonic oxide. Since the escape of hydrogen could not be proved Mr. Moissan concludes that the diamond contains neither free hydrogen nor hydro carbons. The oxidizing combinations (iodic acid, potassic chlorate, and potassic hydrate) are in a fused condition, not capable of attacking the pale varieties of the diamond; the carbonado, however, is attacked by the last two mentioned combinations.

**Steel Rouge.**—In mixing steel rouge, only the smallest quantity of oil should be used, just enough to get the rouge into a stiff paste working it fine with a knife blade

on a hardened steel lap. Alcohol can be used with diamantine, but is open to the objection that it dries rapidly. Steel rouge if properly prepared and used gives the finest black polish.

## Cleaning Mainsprings of French Clocks.

VERY frequently the entire cause of French clocks stopping lies in the mainspring and barrel. The old and dried oil has been allowed to accumulate until it is thicker than tar, and prevents the mainspring from uncoiling. The best method is to remove the spring and cleanse it thoroughly with benzine. The great difficulty attending this method is in getting the spring back into the box or barrel. A large mainspring winder is the tool experience has taught us to be the best; but they are expensive, and but few jewelers have them; still they are an essential tool when one gets many French clocks to repair. The taking out and putting in of mainsprings in these barrels with one's fingers is reprehensible, as it always puts a twist in them, so that when free from the barrel it will stand cone-shaped. If you have no mainspring winder, put a large amount of fresh oil in the barrel, and wind up the arbor several times. Then soak the barrel and spring in benzine, shaking it about until the old oil is well washed away.

After the benzine has all evaporated and the spring looks clean, apply fresh oil. Some expert workmen will take out a spring by holding the arbor in the bench vise, and put the spring, bound with wire, back in the same way. This method is not so very easy to learn, even with some one to show you; but to describe it intelligibly would take a great deal of space, and it is not so very much better than the benzine process, anyway.

## VICTOR. ⊗ ⊗

SIMPLEST FEED. ALWAYS THE SAME.  
GUARANTEED FOR ONE YEAR.

## THE VICTOR FOUNTAIN PEN

(Pat. Feb. 4, 1890.)

THE BOSTON PEN CO.,

N. C. Whitaker & Co., Proprietors.

363 Washington Street, Boston, Mass.,

Manufacturers of finest quality

TORTOISE : SHELL : AND : HORN : GOODS

in every variety. Also Aluminum Hair Pins.

Send for Illustrated Pen Price List No. 1.

## J. H. DEDERICK, JR.,

— DEALER IN —

## Roll Plate Jewelry and Chains.

Optical Goods and Jewelers' Supplies,

16 MAIDEN LANE, NEW YORK.

JET GOODS A SPECIALTY

ESTABLISHED 1870.

## J. L. CLARK,

SWEEP SMELTER AND REFINER OF GOLD AND SILVER.

Buys every kind of Gold and Silverware, Jewelry, Watches and Platinum. Full market value paid.

No. 724 Filbert Street, Philadelphia, Pa.

SEND BY EXPRESS or Registered Mail. If my price is not satisfactory, I will return all articles

## THE BEST PIVOT DRILLS IN THE WORLD.

One Gross without charge for proof that this is not so.

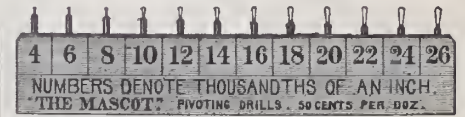

## The Mascot, 50 Cents per doz.

By all Jobbers, or sent post-paid on receipt of price.

Ezra F. Bowman & Co,  
LANCASTER, PA.

## Waltham Horological School,

PALMER & SWAIN, Props.,  
WALTHAM, MASS.

## Summary of Prospectus.

**LOCATED** in Martyn Square, in the city of Waltham, Mass. Pleasant location, hotels, boarding houses, churches, etc.

**CURRICULUM**:—Pupils are taught watch making, repairing and bench tool making complete. American and foreign systems. Special branches taught when desired.

**BRANCHES TAUGHT** include work on plates barrels, wheels, pinions, jewels, balances, staffs springs, screws, stem-winding parts, matching, gilding, finishing, adjusting, repairing, tool work engraving, etc., etc. Also a thorough course in Ophthalmology by a professor of universal reputation and a course in gem cutting if desired.

**COURSE** may begin at any time and pupils are taught to make everything that enters into a watch movement. When the student has finished his course he is able to make and put together a watch complete in all its parts and properly adjusted; he is also a first-class repairer and gets such a thorough instruction in his trade as cannot be obtained in any workshop or any other school in the United States. The workshop of this School is fitted up with thousands of dollars' worth of the best watch tools and machinery, and with the capable instructors always ready to give their attention to the individual student, there being no class system, he has an advantage not to be obtained elsewhere. Materials for a watch movement will be given free to students who desire to make a watch of their own.

Send for full prospectus, terms for special branches, etc.

D. D. PALMER.

EUGENE H. SWAIN.

## A. J. LOGAN,

MANUFACTURER OF  
WATCH TOOLS, HAIR SPRINGS AND  
WATCH MATERIALS.

< New Catalogue just issued, Sent on Application. >  
WALTHAM, MASS.

# Grand STREET Exhibition!

To the Jewelers . . . . .

Below you will find detail  
and to which we add con-

of the lines which we carry  
stantly the latest novelties.



**France**==BRONZES, CLOCKS OF ALL DESCRIPTIONS, SEVRES VASES, LAMPS, PORCELAINS, FINE FURNITURE.

**Germany**==ROYAL BERLIN, ROYAL BONN, NURNBERG MAJOLICA, DRESDEN VASES, DRESDEN LAMPS IN ENDLESS VARIETY, DRESDEN FURNITURE, IVORIES.

**Austria**==DECORATED GLASS, OLD VIENNA WARE, TEPLITZ GOODS, FAYENCE STATUARY, BRONZES.

**Italy**==SUPERB LINE OF CARRARA AND CASTELLINA MARBLES, NOVE AND BASSANO FAYENCE, CARVED FURNITURE

**England**==ROYAL WORCESTER, COALPORT, TULIP GLASS, ENGLISH CHIMING HALL CLOCKS.

## Ferdinand Bing & Co.,

74 Rue d'Hauteville,  
PARIS.

106 Grand Street,  
NEW YORK.

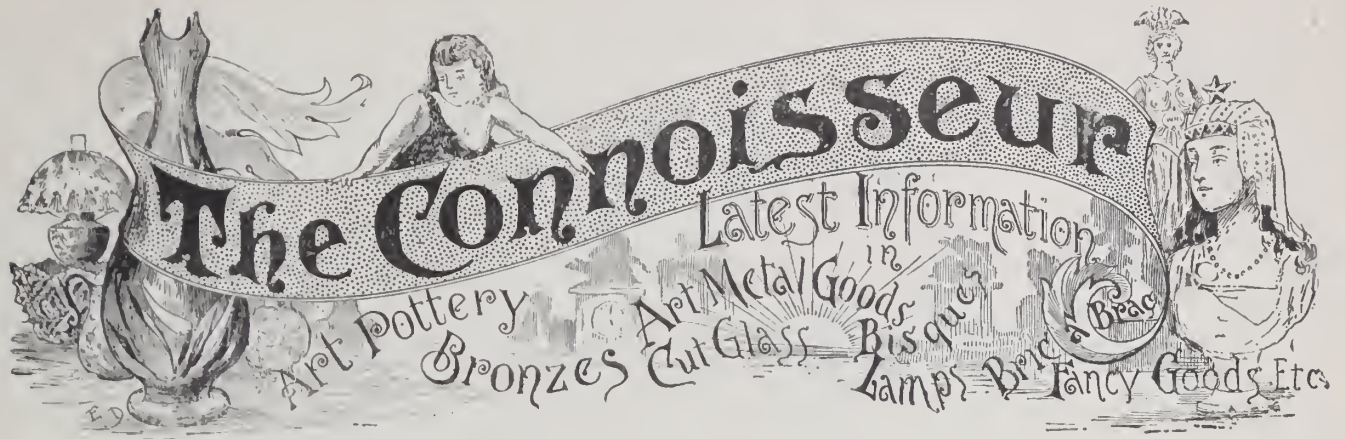

## Remarkable Doulton Vases.

NO. II.

MR. TINWORTH'S "History of England" vase in the exhibit of Doulton & Co., at the World's Fair, is a noble piece standing 4 feet 4 inches high. The form was doubtless suggested by the large Grès de Flandres tankards produced in the seventeenth century by the potters of the Low Countries. The whole was designed and modeled by George Tinworth, and fired in the open stoneware kiln, the figures and niches being left the natural color of the stoneware, and the mouldings and ornamental portions being painted in Doulton ware colors. Round the widest part of the body is a succession of niches, twenty in number, containing little groups representing leading incidents in English history, and round the neck is another series of twenty single figures representing different monarchs.

The selection of incidents, the inscriptions and occasional comments, are all Mr. Tinworth's own. The upper row contains the following figures:—Caractacus, Boadicea, Cæsar, Prince Vortigern, King Alfred, Canute, Edward the Confessor, Henry II., Richard I., Henry III., Edward II., Edward III., Queen Philippa, Richard II., Henry IV., Henry V., Richard III., Henry VII., Queen Anne, George I.

The groups comprise:—The Early Britons, Human Sacrifice—In the Dark, Roman Invasion B. C. 55, King Alfred and Bishop Asser, William the Conqueror and his Sons, King John signing Magna Charta—First Step towards Freedom, Edward I. presenting First Prince of Wales to the Welsh, Henry VIII. and Wolsey, Good King Edward VI. going Home, Cruel Queen Mary at Prayers, Queen Elizabeth giving the ring to Lord Essex, James I. and Guy Fawkes, Charles the First near the end of his trouble, Oliver Cromwell, Protector, tasting the Misery of Power, Charles II. and the Duke of Buckingham, James II. escaping from Whitehall—Not Wanted, William III. landing

in England, George III. and Nelson, George IV. and Queen Caroline, William IV. the Honest Sailor, and the Queen and Prince Albert—Better Times. Altogether the vase is an epitome of English history.

the displays from the various countries at the World's Fair. As to the relative position of the various countries, it is a matter of fine discrimination to judge. Each has its points of special excellence and each bears a distinctiveness all its own. The English wares are beautiful in designs and colorings, the French artistic in both shapes and decoration. Germany with her finely modeled Royal Berlin and Royal Saxon wares is entitled to a high position. Belgium and the Netherlands place Delft in the foreground. Austria presents pleasing work and Japan and China are characteristic. Japan is specially to be commended for her cloisonné. A glance at the United States pottery exhibit reveals articles of utility, and shows a promise of higher art with the advancement to a broader experience.

Japan is rich in finishes and designs, the principal effects being in human forms, flowers and birds. The shapes are unusual and often ugly; the large majority of pieces are of this class; but in cloisonné enamels, the Jap is very much at home, and produces rich results. Chrysanthemums, storks and gods are favorites in ornamentation. The Chinese decorate in bright colors, on wares of shapes the very opposite of Grecian and Roman modeling, and show great eccentricity in their physiological measurements. But there is a wealth of design in forms and flowers.

In English wares the Royal Worcester breakfast, tea and dessert services are choice examples of the potter's art. Likewise the vases and ceramic wall decorations of the Doulton exhibit, a prominent feature being the old-ivory finish, which in the Burslem room of the Doulton pavilion is seen in its greatest excellence. The Royal Worcester old ivories have a reddish tint; the old ivory of the Doulton Columbus and Diana vases, as well as in numerous smaller pieces,

is simply perfect. Solon's *pâte-sur-pâte* decoration in the A. B. Daniell & Son's exhibit, is worthy close attention as high art in ceramic decoration, and in this connection the sculptured glass of the same firm should be



THE "HISTORY OF ENGLAND" DOULTON VASE.

## Critique on the World's Fair Pottery Exhibit.

THE amateur interested in porcelains has found much that is instructive in

**The Connoisseur.**  
(Continued from page 43.)

examined by all connoisseurs.

The Coalport and Cauldon chinas are well represented in choice decorations. Looking over the English exhibit as a whole, had the Connoisseur but one hour to devote to this section it would be given entirely to the Burslem pottery of the Doulton exhibit.

In the Limoges court of the French section is found a most salable line of porcelain and china. The court is rich in vase exhibits, with Emil Levy as a leader in art decoration of larger pieces. In smaller vases it is difficult to decide as to the relative merits of the competing firms, but particular attention is directed to the underglaze effects in new colorings shown in Ch. F. Haviland wares. *Pâte-sur-pâte* on French china is shown only by M. Redon; \$2,000 vases are shown by Bawo & Dotter and Leon J. Glaenger & Co., the latter having a fine display of smaller vases. In table services the three great firms of E. Gerard, Dufraissex & Co., M. Redon and J. Pouyat have commanding places. The products of the Manufacture Nationale de Sèvres occupy a room with the Gobelin tapestries and this room is a paradise to the connoisseur.

First in Germany comes the Royal Berlin and then the Royal Saxon porcelain. Both have a rival for public attention in the beautiful paintings on Dresden porcelain.

In the American exhibit there are two

displays of particular merit. These are the Belleck china of the Willets Mfg. Co., of Trenton, N. J., and the Lotus ware of Knowles, Taylor & Knowles, East Liverpool, O. Each ware is shown in white and decorated.

**Bogus Porcelain.**

**I**F there is anything more degrading to human nature than another it is bogus pottery, says the *Pottery Gazette*, and those who sell it and those who make it are equally culpable. Staffordshire potters, as well as foreign houses, are copying the old Derby and Coalport, these grand specimens in keramic art, in lustre gold and children's penciling on seconds ware; they are sold in bogus china shops with furniture and the like, at a price absurdly high for what they are; but, of course, very much lower than what they are intended to be an imitation of.

People should be more wide-awake than to buy them, said a seller to us. So they should; but if we apply the same argument to a counterfeit shilling upon this assumption, does it prevent the issuer having "six months' hard"? One thing is consoling, it will not last long, for its gold and colors are evanescent; still that people should be robbed by this style of bogus pottery is a disgrace to the potter as well as dealer; both are culpable. Laws are made to protect the silly from the lawless; yet we do not see how the law can touch this question.

**The Rambler's Notes.**

WHAT THE RAMBLER SAW AND HEARD AMONG THE DEALERS IN ART POTTERY, CUT GLASS, BRONZES, ETC.

**P.** H. LEONARD, 76 Reade St., New York, has issued DRESDEN SPECIALTIES FOR JEWELERS.

to the trade an attractive advertising sheet, illustrating in natural colors many of the principal novelties in the firm's new line of Dresden specialties for jewelers which were mentioned in this column three weeks ago. The illustrations are very artistic and give almost as perfect idea of the beauties of this line as an inspection of the pieces themselves.

\*

NEW SHAPES IN COLONIAL LAMPS.

Many beautiful new shapes are now shown in Colonial banquet and princess lamps in the warerooms of the Mount Washington Glass Co., 46 Murray St., New York. The decorations in this ware seem to become handsomer with each assortment introduced. Among the latest goods, the banquet lamps of opal glass with embossed scroll borders number many varieties. With these are shown several new ball-shape and dome-shape shades which are unusually attractive. Some new princess lamps have full thick bodies, an entirely new shape, and are decorated with delicate forget-me-nots on a white ground. An at-

**NOW IS THE TIME  
TO SELECT YOUR GOODS.**

**China, Glass,  
Bric-a-Brac,  
Etc.**

**If you want  
Novelties  
Especially  
Adapted to  
The Jewelry  
Trade, Come  
And See Us.**



**CHARLES AHRENFELDT & SON,**

50, 52 and 54 Murray St.,

New York.

# ANNOUNCEMENT



**FALL, 1893.**

OUR Importations for the coming season are now arriving and we have on exhibition at our ware-rooms a complete assortment of exclusive

## Novelties and Specialties

SELECTED FOR THE JEWELRY TRADE.

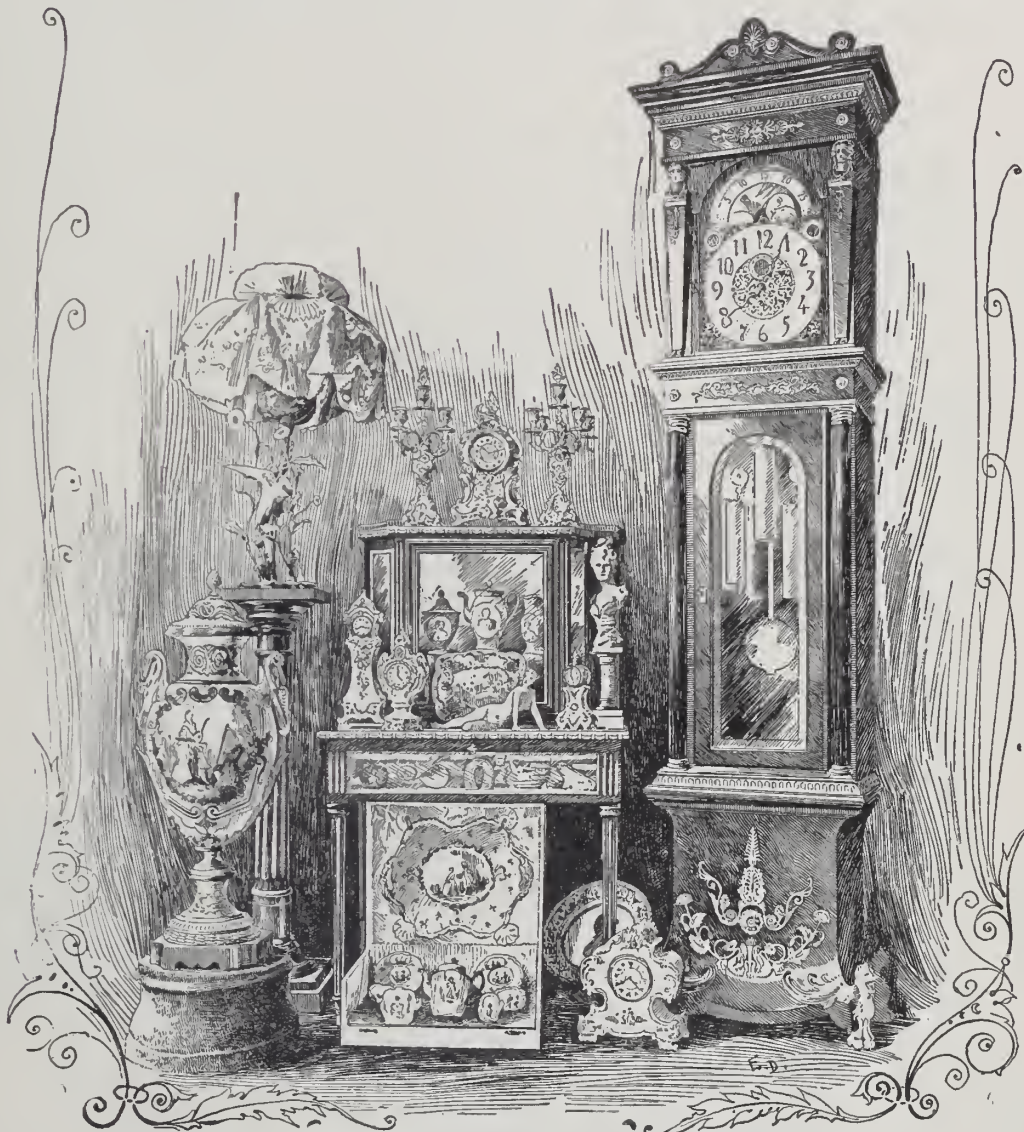

SPECIMENS OF FALL GOODS FROM THE STOCK OF LEON J. GLAENZER & CO.

Clocks, Bronzes, Sevres Vases, Fine Decorated Porcelains, Cups and Saucers, Tea Sets, Lamps and gilt and silver plated filigree Photo Frames in endless variety

# LEON J. GLAENZER & CO.,

35 Boulevard de Strasburg, Paris.

80 & 82 CHAMBERS ST., N. Y.

tractive Royal Flemish princess lamp has just been introduced.

\*

**POPULAR FRENCH CHINA PHOTO FRAMES.**

French china photo frames are among the novelties

which are at present enjoying great popular favor. In the fine assortment of Limoges frames in new shapes and with new decorations, which can be seen at the showrooms of F. W. Büning & Co., 58 Murray St., New York, the prevailing styles have either a white or cream yellow ground, with gold edge, and violet, pansy spray, relief gold, or Cupid decorations. Others are in cobalt and lighter blue with bronze edges, and with relief gold or floral decorations. Some ro-cocco shapes, just introduced, are exquisite.

\*

**THE BEAUTIES OF HELIOTROPE GLASS.**

A new line of Heliotrope glass ware has been

opened by Levy, Dreyfus & Co., 11 Maiden Lane, New York. The pieces are principally flower holders and vases, used for table decoration. The ornamentation consists of a crystal band entwined around the body of the piece. The variety of sizes shown in this beautiful but inexpensive line is exceedingly extensive.

\*

**A QUICK SELLING CLOCK SET.**

Probably the most popular of the smaller pieces introduced

and controled by the Chas. Jacques Clock Co., 22 Cortlandt St., New York, is the gilt

and china clock set of which an illustration appears in the advertising columns of this issue of THE CIRCULAR. The set is in Louis XV. style and is shown in three styles, pink, blue and ivory. The shapes are exceedingly handsome, and the decorations artistic. These characteristics and the low price at which the set is offered, are among the reasons for the well merited popularity it enjoys.

THE RAMBLER.

**Curious Timepieces.**

**A**FTER describing some curious clocks, among them a timepiece recently described in THE CIRCULAR, to which journal the author gives due credit, L. A. Maynard, in the *Christian at Work*, proceeds as follows:

A clock of some historic interest was recently sold at auction in Carlisle, Mass. It stood in a house at Lexington at the time the shot was fired which was heard "round the world." The British set fire to the house, but the clock escaped in some way, and has just turned up again after the lapse of a century in perfect running order. It was purchased by a resident of Lexington, and is now performing its daily round of duties in its old home. It bears the date 1774 and is supposed to be remotely connected to that other "ancient timepiece," which to the poet seemed always to be saying

Forever—never—  
Never—forever.

A novel form of clock has recently been designed by an English artisan. The face has the form of a tambourine decorated with a wreath of twelve flowers at equal distances apart. These mark the hours, and over them glide two gayly painted butterflies, one larger than the other. These are the hands, the larger indicating the minutes, the smaller the hours. The works are concealed behind the tambourine, and the motions of the butterflies, which are made of magnetic metal, are produced by magnets carried on the arms forming the real hands of the clock.

But one of the most wonderful and beautiful arrangements for marking the flight of time of which I have ever read or heard could have been seen some years ago in a garden in the French quarter of New Orleans. It was nothing less than a clock made up of flowers. It is a well-known fact to all who are acquainted with the habits of flowers that each has its appointed season of awakening to a new day. In fact Linnæus, the great botanist, arranged a list of the waking and sleeping hours of plants, beginning with the morning glory, which opens at about two in the morning, and giving one for every hour thereafter until eight o'clock in the evening, at which time the night-blooming cereus generally opens its petals.

The owner of the garden in New Orleans appears to have improved upon the list given by Linnæus and found plants which bloom up to midnight, among the latter

**A. A. VANTINE & CO.,**

877 & 879 BROADWAY,  
NEW YORK.



200 & 202 MADISON STREET,  
CHICAGO.

JAPAN, CHINA, INDIA, PERSIA, TURKEY.



**W**E are showing the most exquisite line of Metal Novelties for Christmas trade and specimens of the highest art of Japan.

White Metal Ash Trays, round, square and fancy Repousse Gold Lacquer, Raised Designs in Silver, assorted, dozens at \$2.25 per doz.

Oblong Fancy Metal Pen Trays, Mythical Designs, thoroughly original, 12 inches long, at \$6.00 per doz.

Bronze, Mottled Lacquer Stamp Boxes, 12 assorted shapes, at \$2.40 per doz.

Bronze, Mottled Lacquer, Bon Bon Ring and Jewel Boxes, at \$4.50 per doz.

**VINAIGRETTES, \* CHATELAINES, \* PUFF BOXES,**  
IN DECORATED BRONZE, OF THE BRILLIANCY OF SILVER.

Match Boxes in Odd Designs, Highly Ornamented in Oxide Metals, at \$3.00 per doz.

Cloisonné in Vases, Koros, &c., Richest Enamel Decorations. Specimens at \$3.00 and upwards.

Royal Satsuma Cabinet and Mantle Specimens. This is the Highest Art Pottery known. Specimens range from \$4.00 each.

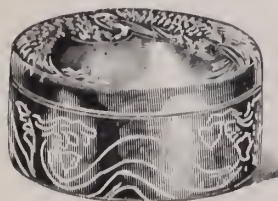

# To Jewelers and Art Dealers:

OUR THIRD FLOOR, 100x100 FEET IS  
DEVOTED EXPRESSLY TO

Bric-a-Brac, Artistic Novelties and the Richest Productions in Art Pottery, Onyx Clocks and Pedestals, Marble Statuary, Carved Wood Furniture, Verni Martin Cabinets, Banquet Lamps in Onyx and Dresden China, etc., etc.

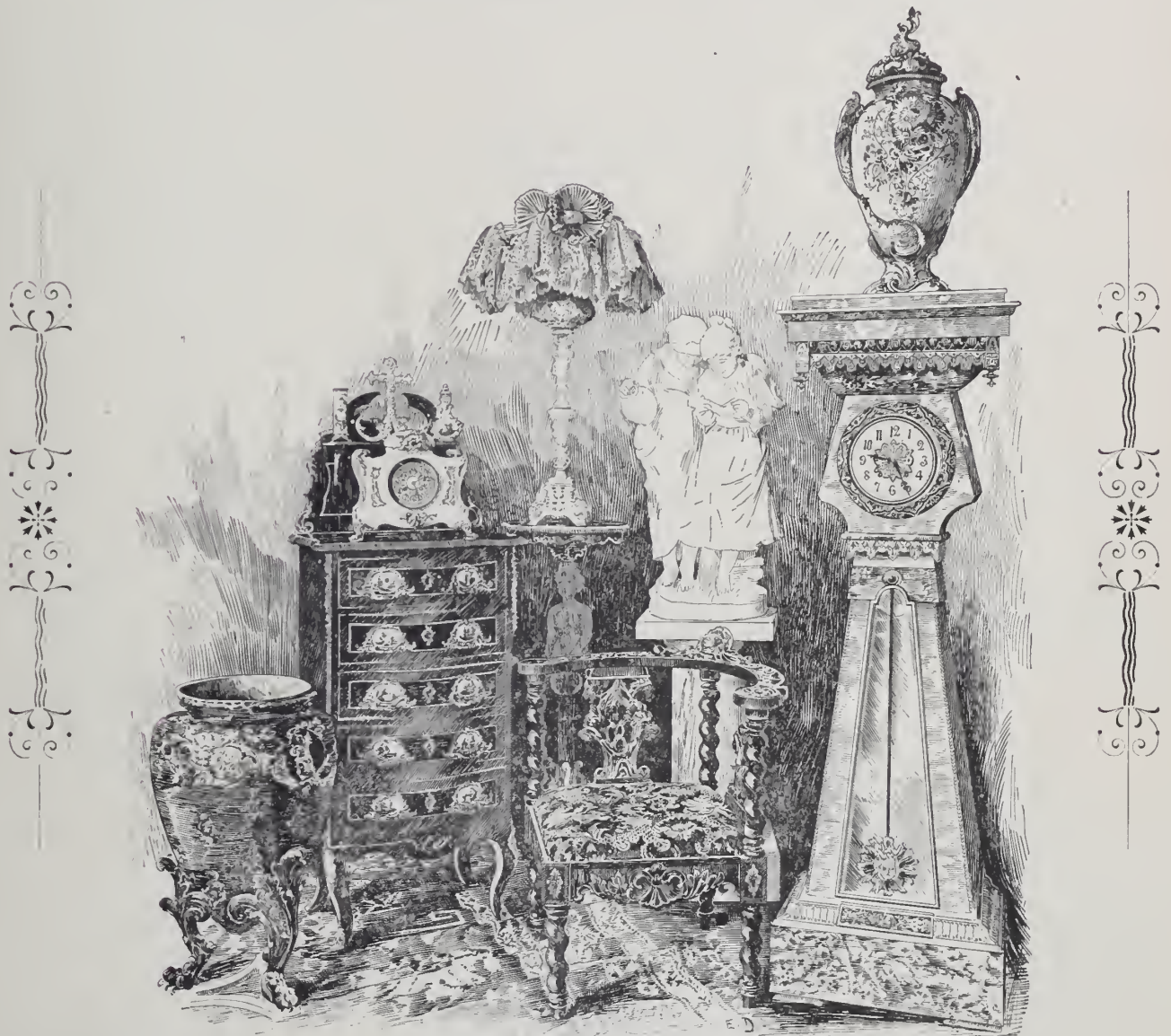

We are now Disposing of our Season's Samples at Special Prices, Preparatory to the Arrival of our New Lines for 1894, thus Affording an Excellent Chance for Buyers to Obtain, at Small Outlay, a Beautiful Assortment of Choice Goods.

**GEO. BORGFELDT & CO.,** 18, 20 & 22 WASHINGTON PLACE, NEW YORK.



# ROYAL DRESDEN DECORATIONS.

ELEGANT COLLECTION OF ITEMS IN THE  
ABOVE LINE FOR THE

## JEWELRY • TRADE.

WRITE FOR SAMPLE ASSORTMENT.

**P. H. LEONARD,**

76 & 78 Reade Street, New York.

FOREIGN OFFICES.

LIMOGES, FRANCE.

DRESDEN, SAXONY.

FINE CHINA FOR JEWELERS.

ones being several varieties of cacti. Enough plants were found, at all events, to form a circle in the shape of a dial-face, with a plant for each of the twenty-four hours. Among the plants for the latter hours of the day he had the garden nitigo, which opens at five in the afternoon; the geranium triste at six; the evening primrose at seven. Opposite eight o'clock he had the bona nox, and nine o'clock the nocti flora. At ten o'clock he had a cactus; at eleven another kind of the same plant, and at twelve a variety of night-blooming cereus. The plants opposite one and two in the morning were cacti; and at three was planted the common salsify; and at four the chickory; at five snow-thistle; and at six the dandelion.

Such a timepiece as this could hardly be depended upon for catching trains or making business appointments "at ten o'clock sharp." But the idea of measuring time by the opening of flowers is very beautiful and suggestive. Almost anyone could bear to grow old by such chronology. If I mistake not, it is Longfellow who has said—

"Ah! well I mind the calendar  
(Faithful through a thousand years)  
Of the painted race of flowers—  
Exact to days, exact to hours,  
Counted on the spacious dial  
Yon brodered zodiac girds.  
I know the pretty almanac  
Of the punctual coming back,  
On their due days, of the birds."

Chrysopraxe is having great vogue abroad.



EUROPEAN

CLOCKS

— AND —

ART

GOODS.

LOW PRICES

TO SUIT THE TIMES.

360

BROADWAY,

— ALSO —

BROADWAY, Cor. 17th St.,

NEW YORK.

**F. KROEBER CLOCK CO.**



**Points of Law.**

**VALIDITY OF MORTGAGE AS TO CREDITORS.**

A mortgage by a debtor to secure certain creditors is not fraudulent where there is no combination with the mortgagees, and the debtor, before executing it, proposed to the objecting creditors to include them as mortgagees, and they declined the proposition.

*Monaghan Bay Co. v. Dickson, Supreme Court of S. C.*

**ACTION AGAINST PRINCIPAL FOR SALES TO AGENTS.**

In an action against a principal to recover the value of goods sold to an agent for use in a hotel, the burden is on him to show that the goods sold are of such character as the nature of the business authorized the agent to purchase.

*Wallis Tobacco Co. v. Jackson, Supreme Court of Alabama.*

**INDEBTEDNESS BY HUSBAND TO WIFE.**

Where a husband receives from his wife money inherited by her, and uses the same in his business, there is an implied promise on his part to repay her, and, as between them, a valid indebtedness from him to her is created.

*Riley v. Vaughn, Supreme Court of Missouri.*

**WHAT CONSTITUTES CONVEYANCES IN DEFRAUD OF CREDITORS.**

Where one who was largely in debt, and whose creditors were pressing him, conveyed with great secrecy his entire stock of goods and the bulk of his land to his father-in-law who knew that he was in failing circumstances, pending the transfer he told his creditors that he would make no conveyance of the property and though he owed his father-in-law, it was clear that he never expected to be called on for payment, and, in furnishing statements of his financial condition, as a basis for credit, he made no mention of such indebtedness, such transaction was a fraud on creditors.

*Younger v. Massey, Supreme Court of S. C.*

**ACTION TO SET ASIDE CONVEYANCE TO CORPORATION.**

Two partners and a third person formed a corporation under an agreement by which the partners were to put in their business and the third person certain money. The fact that the third person obtained his money from the partner having the smaller interest in the firm, and that they together, having a majority of the stock, combined to take the control of the business from the other party constitutes no ground for an action by the latter to set aside the conveyance of the partnership property to the corporation, there having been no misrepresentations.

*Baumgarten v. Nichols, Supreme Court of New York.*

**JEWELRY—CASES,  
TRAYS.**

**Jewelers' Findings.  
Chamois Bags.**

**SILVERWARE—CASES.**

**S. & A. BORGZINNER,**

**82 & 84 Nassau Street,**

**NEW YORK.**

WE HAVE IMPORTED FOR THIS SEASON AN EXTRA LINE OF

**Fine Silk Velvet Cases.** Our prices are so low that you can buy them in place of Plush Cases.

Write us for Prices.

Samples Mailed Free.

OURS IS THE  
**CH. FIELD HAVILAND**  
LIMOGES CHINA.

FABRIQUE FONDÉE EN 1797.  
**E. GERARD, DUFRAISSEIX & CIE.,**  
SUCCESSIONS :

WHITE WARE.  
**CFH**  
**GDM**  
FRANCE  
TRADE MARK.

DECORATED.  
**CH. FIELD HAVILAND**  
LIMOGES  
TRADE MARK



SOMETHING ABSOLUTELY NEW IN CERAMICS, FURNACE FIRE COLORS.

**HAVILAND & ABBOT,**

AGENTS FOR THE UNITED STATES,

29 Barclay Street,

NEW YORK.

ESTABLISHED 1801.

**HINRICHS & CO.,**29 & 31 PARK PLACE,  
Cor. Church Street, NEW YORK.**Art Pottery and Bric-a-Brac,**  
CUT GLASS, FANCY GLASS, CHINA.

Large Assortment of

Fine Dresden China Lamps, Glass and  
other Fancy Lamps.

THE LARGEST ASSORTMENT OF SPECIALTIES FOR THE JEWELRY TRADE,

AT LOWEST PRICES.

CATALOGUE ON APPLICATION.

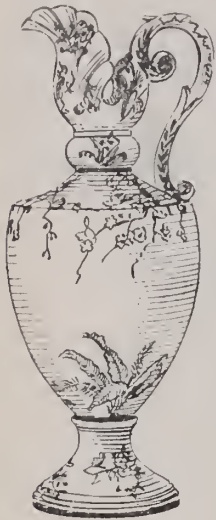
**FRENCH CHINA SPECIALTIES FOR JEWELERS.**BRUSH & COMB TRAYS,  
CARD TRAYS,  
MANICURE TRAYS,  
PEN TRAYS,PHOTOGRAPH FRAMES,  
FRUIT PLATES,  
ODD CUPS AND  
SAUCERS, ETC.

◁ SEND \* ORDER \* FOR \* SAMPLE \* ASSORTMENT. ▷

**F. W. BUNING & CO.,**

58 MURRAY STREET,

NEW YORK.

Send for Our Illustrated List

— OF —

**WEDGWOOD JASPER,****WITH PRICES.**It will pay you to Handle These  
Goods for**HOLIDAY TRADE.****MADDOCK & CO.,**  
IMPORTERS,

21 Barclay St., NEW YORK.

**S. C. JACKSON,** 180 BROADWAY, NEW YORK.

MANUFACTURER OF

Fine \* Cases \* for \* Jewelry, \* Silverware, \* Etc.

ALSO SHOW CASE TRAYS AND FANCY HARD WOOD WORK.

Samples sent on application. Estimates furnished.

**The Other Side of Life.**

The first earrings of women were merely interrogation points which she hung in her ears when she went out to gather the news.  
—*Galveston News.*

"What do wedding rings cost?" "Oh, about eight dollars apiece in New York, or about seventy-five dollars a dozen in Chicago." —*Kate Field's Washington.*

T'WAS AUBURN.

HE.—Her hair looks like spun gold.

SHE.—(not liking to hear her rival praised).

—Yes; fourteen carot. —*Vogue.*

"There's a woman in Brooklyn whose watch goes splendidly."

"Marvelous."

"And she attends to it most carefully."

"There may be such a watch, but I'm sure there's no such woman." —*Raymond's Monthly.*

PRESERVING THE PARITY.

BINKERTON.—Come over to the house to-night, old man. We're going to celebrate our silver wedding.

PILGARIC.—Your silver wedding! Ain't you a little previous? Why, you've only been married fifteen years!

BINKERTON.—That's all right; but silver is away below par now, you know. —*Puck.*

The smart young man had a slight scratch on his cheek, which he seemed rather anxious that people should see. Finally some one asked him how he got it.

"Tried to kiss a pretty girl," said he, "and her earring scratched me."

"Must have been a real diamond," was the comment of one listener. —*Indianapolis Journal.*

**The Ghost of Watchmaker Diet.**

THERE is a house on the main thoroughfare of Rockville Center, N. Y., said to be haunted by the ghost of Martin Diet, who was a watchmaker and lived in the house about a year ago. He suddenly disappeared. Since then several families moved into the house but have all left in a short while, claiming that they were disturbed by strange noises. A constable moved into the house a week or so ago. A few days since he carted his things away in a hurry. The constable is unnerved by his experience.

"Every night we heard mysterious noise," he said. "My wife wanted to move away, but I told her I could not afford to do so. The night we moved, though, a white figure came and stood at the foot of the bed and waved its arms above its head as though cursing somebody. We gathered up the children and sat in the kitchen all night."

YOU CAN MAKE MONEY By Putting in a Handsome Assortment of

**FINE POCKET CUTLERY.**

We are agents for the SOUTHINGTON CUTLERY CO.'S Celebrated RAZORS and POCKET KNIVES.

SEND FOR AN ASSORTMENT.

H. B. BEACH & CO., - 418 Washington St., Boston, Mass

**"Old English"**

Coffee Spoon.



DESIGN PATENTED.

Towle Mfg. Co.,

MANUFACTURERS OF

**STERLING SILVERWARE.**

NEWBURYPORT: No. 214 Merrimack St. CHICAGO: Nos. 149 & 151 State St.



SPECIAL SALESMAN OF

**WATCHES, DIAMONDS,**

Bric-a-Brac  
and Art Goods

FOR

**Established Jewelers.**

WRITE FOR PARTICULARS.

Communications Strictly Confidential.

References given in all parts of the United States from Retailers and Jobbers

**THE IMPROVED RIVAL FOUNTAIN PEN.**

Most Reliable and Guaranteed to Give Perfect Satisfaction. Over 75,000 in Use.

Send for Price List.



Liberal Discounts to the Trade.

**D. W. BEAUMEL,** Inventor and Manufacturer, REPAIRING A SPECIALTY, 17 John St., New York.

**WM. BIRMINGHAM & CO.,**

MANUFACTURERS OF

All Kinds of Leather Spectacle and Eye Glass

**CASES,**

728 Arch Street, PHILADELPHIA, PA.

For **BADGES AND MEDALS**

Flag Pins, Class Pins, Class Rings and Special Work of all Descriptions.

SEND TO **E. R. STOCKWELL,** MANUF'R,

19 John Street, New York.

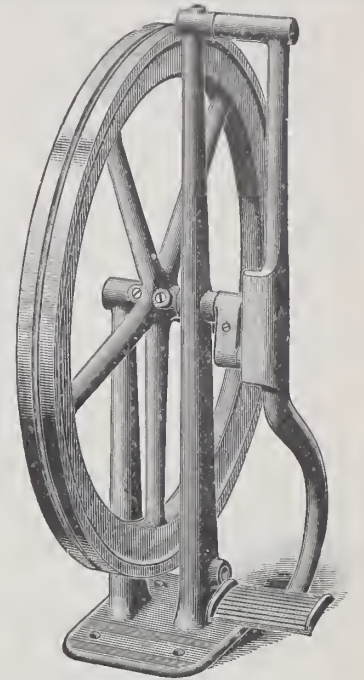

Ask your Jobber for the

**IMPROVED \* FOOT \* WHEEL.**

Diameter of wheel, 20 inches. Weight, 40 lbs. full. Total weight, 65 lbs.

**W. W. OLIVER,** MANUFACTURER,

**BUFFALO, N. Y.**

Send for our No. 10 Catalogue.

**R. W. TIRRELL.**  
THE

**JEWELERS AUCTIONEER.**

**114 PEMBROKE ST. BOSTON, MASS.**

**MY METHODS ARE SUCCESSFUL**

**REFERENCES NUMEROUS. TERMS REASONABLE.**

**ALL CORRESPONDENCE CONFIDENTIAL.**

ESTABLISHED 1837.

**GEO. O. STREET & SONS,**

MAKERS OF

**Fine Rings, Lockets, Seals, Sleeve Buttons and Links,**

**15 John Street, NEW YORK.**

**CROUCH & FITZGERALD,**

Jewelry Trunks and Cases.

**161 Broadway**

bet. Cortlandt and Liberty Sts.,

**688 B'way,**

**701 6th Ave.,**

**NEW YORK.**



FALKENAU, OPPENHEIMER & Co.

DIAMONDS  
40 MAIDEN LANE NEW YORK

# B. & W. B. SMITH.

220 WEST 29TH ST.,

NEW YORK CITY.

AT THE

## WORLD'S FAIR, CHICAGO,

OUR EXHIBIT IS IN THE

Manufactures and Liberal Arts Building, Section Q, Block One.

CALL AND SEE US AT OUR OFFICE IN NEW YORK.

### WHY

S. F. MYERS & CO.  
sell more goods than any  
other Wholesale Jewelry  
House.

### BECAUSE

various publications and illustrated

MYERS BUILDINGS, 48 & 50 Maiden Lane, NEW YORK.

They are the only firm in the Metropolis who carry  
in stock a full line of everything a jeweler requires.  
They give the utmost values and endeavor to  
please their trade in every respect. Refer to their  
catalogues.

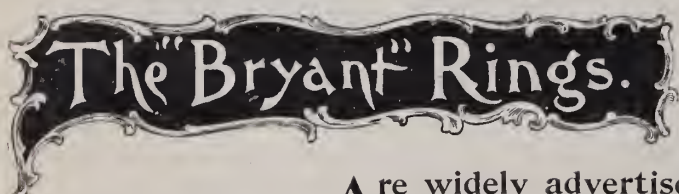

Are widely advertised and will sell  
when anything will, therefore  
every Retail Jeweler should buy them.

IF NOT CALLED UPON BY OUR TRAVELERS  
ORDER DIRECT FROM

M. B. BRYANT & CO.,

10 MAIDEN LANE, N. Y.

OLDEST RING MAKERS IN AMERICA.



AMERICAN RAILWAY SUPPLY CO.  
24 Park Place, NEW YORK.

Jules Jürgensen  
OF COPENHAGEN.

The reputation these watches have maintained for  
Fifty Years has never been equalled, being made  
on strictly scientific principles and no expense spared to  
give the Best results in mechanism and timekeeping  
qualities.

SOLE AGENTS.  
John C. Hyde's Sons,  
NO. 22 MAIDEN LANE.

### BLACK DIAMOND FOUNTAIN PEN.

Unequaled for Price.

Send for Circular.



H. M. SMITH & Co.,

83 NASSAU STREET, N. Y.

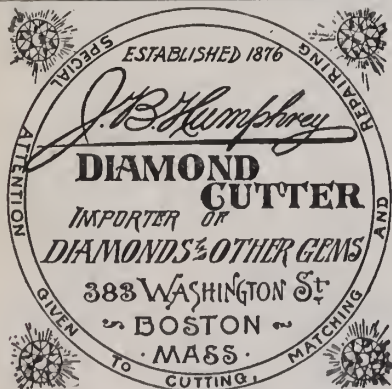

S. P. HOWARD,  
Gold and Silver Assayer.  
Refiner and Sweep Smelter,  
33 MAIDEN LANE, NEW YORK.  
Smelting and Refining Works,  
28 & 30 Cumberland Street, Brooklyn, N. Y.  
Specialties: Sweepings, Gold, Silver and Platinum.



GILT AND CHINA SET, 2040/1,  
Clock 13 inch. High - in three decorations.

15 Day Fine French Movement Time, Set, \$14.50, cash with order.  
" " " Gong Strike, " 18.00, " "

CHAS. JACQUES CLOCK Co.,

22 CORTLANDT ST.,

NEW YORK.

### IT PAYS

TO KEEP IN TOUCH WITH TRADE AFFAIRS.

THE JEWELERS CIRCULAR,

For 4c. a Week will do it. **Subscribe.**

WOLFF & GUNZBURGER, Importers of DIAMONDS, 87 NASSAU ST., (Fulton Building), NEW YORK.

L. & M. KAHN & CO., Importers of DIAMONDS, 172 BROADWAY, Cor. Maiden Lane, NEW YORK.



