

M. MANUTCHEHR-DANAI

DICTIONARY  
OF GEMS  
AND  
GEMOLOGY

Second Edition



 Springer

Mohsen Manutchehr-Danai  
**Dictionary of Gems and Gemology**

Mohsen Manutchehr-Danai

# Dictionary of Gems and Gemology

2nd extended and revised edition

With approx. 25 000 entries, 1 500 figures and 42 tables

 Springer

**Author****Professor Dr. Mohsen Manutchehr-Danai**

Dr. Johann-Maier-Straße 1  
93049 Regensburg  
Germany

Library of Congress Control Number: 2004116870

ISBN 3-540-23970-7 Springer Berlin Heidelberg New York

This work is subject to copyright. All rights are reserved, whether the whole or part of the material is concerned, specifically the rights of translation, reprinting, reuse of illustrations, recitations, broadcasting, reproduction on microfilm or in any other way, and storage in data banks. Duplication of this publication or parts thereof is permitted only under the provisions of the German Copyright Law of September 9, 1965, in its current version, and permission for use must always be obtained from Springer. Violations are liable to prosecution under the German Copyright Law.

**Springer is a part of Springer Science+Business Media**

springeronline.com

© Springer-Verlag Berlin Heidelberg 2005

Printed in Germany

The use of general descriptive names, registered names, trademarks, etc. in this publication does not imply, even in the absence of a specific statement, that such names are exempt from the relevant protective laws and regulations and therefore free for general use.

Cover design: Erich Kirchner, Heidelberg

Typesetting: Camera ready by the author

Production: Luisa Tonarelli

Printing and binding: Stürtz, Würzburg

Printed on acid-free paper 30/2132/LT – 5 4 3 2 1 0

# Preface to the Second Edition

The worldwide acceptance of the first edition of this book encouraged me to extensively revise and extend the second edition. The book was of value to readers of widely ranging interests as demonstrated by the letters received from scientists, students, mining engineers, editors of periodical papers and teachers.

This revision comes five years after the publication of the first edition. Many entries have been improved and now include new data. In total it includes about 25 000 entries, 1 500 graphic figures and 42 tables.

The first edition was criticized by readers who felt that some entries were not related to respective materials: but I would like to emphasize that many minerals are described in the form of references necessary for determining other gemstone materials.

In this edition chapters on light, color and colorant are dealt with in more depth, a large section introduces new terms applying to these areas.

If you have criticisms or suggestions please feel free to contact the author.

*Mohsen Manuthehr-Danai  
Regensburg, Germany, January 2005*

# Acknowledgements (Second Edition)

I appreciate the time and effort of Ms. Pamela Krimsky, Meshed/Iran for proof the manuscript of the second edition. I was very pleased with her conscientious and reliable work.

I appreciate the criticism of Mr. Michel J. C. Sandillon, France, as well as his time and effort. He provided me with some new and exact information about diamond localities in India.

I appreciate the time and effort of Professor Hofmeister from the Institut für Edelsteinforschung, University of Mainz, Germany for helping me to find some special books and for much useful information.

I appreciate the time and effort of Dr. G. Niedermayr of the Naturhistorisches Museum Vienna, Austria, who willingly gave me additional new information about references to jade.

I would like to thank my beloved son Human who is worthy of far more acknowledgments than I have space for. He was always standing beside me.

I cannot finish without gratefully acknowledging the help and support of Dr. Christian Witschel of Springer-Verlag, Heidelberg.

My thanks go again to my friend and attorney Mr. Karl Abt for his support and professionalism.

I would like to thank Mr. Michael Schmidt for his great help in resolving computer problems.

# Preface to the First Edition

Since World War II the amount of information generated in the science of Gemology has increased tremendously. Therefore this book “Dictionary of Gems and Gemmology and related terms” was written with the aim of providing a “relatively” complete dictionary to assist all students, hobbyists, scientists and interested parties in the fields of gems and gemology.

The forerunner to this book was called “Dictionary of Gems and Gemmology” (English-Persian, Persian-English, published in Tehran-Iran in 1997) and was written with the aid of more than thirty reference books relating to gemology. In response to the effort required to clarify the terms within, I decided to compile a book that brings all the relevant terms into one book. This new book eliminates the use of different reference books and compiles nearly all the relevant terms into a one-stop useful text. It took twenty five years to collect the terms and the information so as to present a complete and functional lexicon.

The text is supported by nearly 170 illustrations and 21 tables to provide detailed and succinct information.

I hope and trust that this book will reach the high standard of other gemological dictionaries. If you have criticisms or suggestions please feel free to contact the author.

*Manutchehr-Danai, Mohsen  
Los Angeles, Tehran, Regensburg*

# Acknowledgements (First Edition)

The author acknowledges all those who were of valuable assistance during the writing and publishing of this book.

My thanks go to my good friend Professor Dr. Farhad Rahimi of Meshed University, Iran for pioneering my first book in English-Persian, Persian-English and for his further work on my current book.

I appreciate the time and effort taken by my good friend Mr. Bozozrgmehr Vakhshoori who spent a great deal of time helping with the preparation of this book and by Mr. William Ohara for his indefatigable effort in publishing this book.

I am grateful to my proof reader Eleanor Gorman, B.A. Communication, Australia.

I would like to thank my beloved son Human who is worthy of far more acknowledgments than I have space for.

My grateful appreciation goes to my good friend Mr. Dr. Hassan Parvizinia for his skillful graphic work.

I appreciate the support and professionalism from my friend and attorney Mr. Karl Abt.

I cannot finish without gratefully acknowledging to Dr. Heinz Sichert, Rechenzentrum of the University of Regensburg, Mrs. Heidi Krinner and Mr. Hannes Völkli from Pustet Company, Regensburg.



# Abbreviations and Symbols Used in the Text

Å	Ångström	Nanometer	$10^{-9}$ meter
$a$	cell edge in the $x$ direction	nm	nanometer
Ab	albite $\text{NaAlSi}_3\text{O}_8$	$\omega$	ordinary ray in uniaxial crystal. Refractive index
Abbr.	abbreviation	Or	orthoclase $\text{KAlSi}_3\text{O}_8$
$\alpha, \beta, \gamma$	the three refractive indices in biaxial crystal from least, intermediate to greatest	Pa-sec	Pascal-second
Adj.	adjective	Port.	Portuguese
An	anorthite $\text{CaAl}_2\text{Si}_2\text{O}_8$	RI:	generally refractive index, also for cubic and amorphous substance
Ångström	0.1 nanometer	RI;	refractive indices of $\omega$ : ordinary ray, $\epsilon$ : extraordinary ray in uniaxial crystal
$b$	cell edge in the $y$ direction	RI;	refractive indices of $\alpha$ : alpha, $\beta$ : beta, $\gamma$ : gamma in biaxial crystal
Birefringence	in uniaxial crystal is the difference between $\omega$ and $\epsilon$ . In biaxial crystal is the difference between $\alpha$ and $\gamma$	Russia	formerly Soviet Union
$c$	cell edge in the $z$ direction	SG	specific gravity
$^{\circ}\text{C}$	degrees Celsius, a unit of temperature, known as centigrade	Sri Lanka	formerly Ceylon
ct(s).	carat(s) or metric carat(s)	SWUV light	short-wave ultraviolet light
Diaphaneity	transparent or translucent, or opaque	Thailand	formerly Siam
$\epsilon$	extraordinary ray in uniaxial crystal. Refractive index	X [ ]	X represent the number of formula units per unit cell
Fa	fayalite $\text{FeSiO}_4$	$x, y, z$	crystallographic axes
Fo	forsterite $\text{MgSiO}_4$	Zimbabwe	formerly Rhodesia
H	hardness on the Mohs's scale	$\ominus$	optically negative, when $\epsilon$ is greater than $\omega$ in uniaxial crystal. In biaxial, when intermediate refractive index $\beta$ is near to $\gamma$ than $\alpha$
Hz	hertz SI unit of frequency ( $c/s$ )	$\oplus$	optically positive, when $\omega$ is greater than $\epsilon$ in uniaxial crystal. In biaxial, when intermediate refractive index $\beta$ is near to $\alpha$ than $\gamma$
Lat.	Latin	$\rightarrow$	see
LWUV light	long-wave ultraviolet light		
Malagasy	formerly Madagascar		
Mt.	Mountain		
Myanmar	formerly Burma		
N.Y.	New York		

# Source of Illustrations

**De Beers (CSO):** 1-fire rose cut, 2-dahlia cut, 2-marigold cut, 4-sunflower cut, 5-zinna cut.

**Eppler,** *Praktische Gemmologie:* Highlight brilliant cut, king cut, magna cut and royal 144 cut.

**Liddicoat (GIA),** *Diamond Dictionary:* American brilliant cut, baguette cut, rondelle cut, tapered cut, Trielle cut and whistle cut.

**Maier,** *Brillianten und Perlen:* Situation of facets, modified brilliant cut, Peruzzi cut.

**Miller and Sinkankas,** *Standard Catalog of Gems:* Honeycomb cut, refraction of light, star and step brilliant cut.

**Vollstädt and Baumgärtel,** *Edelsteine:* Prismant.

**Webster and Read,** *Gems:* Cross rose cut, blades of tortoise shell.

# A a

**a**; a symbol for one of the three crystallographic axes. With subscript 0, as  $a_0$ . The letter “a” usually appears in italics.

**A**; the first line of Fraunhofer lines, in the deep red of the solar spectrum. Its wavelength is 760.60 nm caused by oxygen in the earth’s atmosphere.

**α**; alpha: symbol for denoting the major allotropic form of a substance.

**α**; alpha: a radiation consisting of helium nuclei.

**α**; alpha: a symbol for optical rotation.

**α**; alpha: a symbol for phase constant.

**Å**; an abbreviation of Ångström and Ångström unit. Also spelled A or ÅE.

**A**; same as Å.

**ÅE**; same as Å.

**Aaron’s Breastplate**; same as breastplate of the Jewish High Priest.

**abacus**; a Mexican term used for stone wash trough.

**Abadia do Dourados**; a city in Minas-Gerais region, Brazil.

**Abadia do Duorados Diamond**; a clear pale brown diamond of 104 cts, found around 1938/39 in Brazil. Present location unknown.

**Abadia do Duorados Lilac Diamond**; a clear lilac diamond of 63 cts, found in 1939 in Brazil. Previously sold to an African, the present owner is unknown. Also, called Abadia do Duorados Lilac Diamond.

**Abadia do Duorados Rose Diamond**; a natural rose colored diamond of 33 cts, found in 1936. Present location unknown.

**Abaeté Brilliant Diamond**; an uncut diamond of 144 cts. Found in 1791 in the Abaeté River, Minas Gerais, Brazil. Present location unknown.

**Abaeté-Diamond**; a rose pink rough diamond of 238 cts, found in 1926 in the Abaeté River, Minas Gerais, Brazil. Present owner unknown.

**Abaeté Rose Diamond**; a pink rough diamond of 118 cts. Found in 1929 in the Abaeté River, Minas Gerais, Brazil. Present location unknown. Also known as the Cross of the South Diamond.

**abalone**; term for a marine gastropod, *mollusc haliotis* of the genus *Haliotidae*. A species of ear shell, also called ormer, from which mother-of-pearl is produced. Other pearl-bearing shellfish from *abalone* genus is the *ormer shell* or *haliotis tuberculata*, which live in shallow waters. *Haliotis rufrescens* is a reddish member of the abalone family. Colored baroque pearls produced by abalone have the same iridescence as the interior of

the shell. These shellfish originate in the waters of California, Mexico, New York, Japan, and are also found in the Atlantic Ocean. Abalones in New Zealand are known as *paua shell* and in Japan *Awabi shell*. → *Haliotis*, *paua shell*.

**abalone pearl**; usually small iridescent salt-water pearls, with a high quality nacre. Usually abalones produce blister pearls of various shapes classified as baroque, flattened button, irregular pear, and elongated. These are true pearls found occasionally in Mexico, Japan, and California. Many of them are hollow. These pearls are usually of pronounced green, yellow, blue, pale green or pink hues. The iridescence is only skin-deep.

**abalone shell**; a member of the salt-water mollusk family.

**abandon**; to leave, to give up or stop excavating a mining site due to unprofitable or unsafe business conditions.

**Abàsi**; correctly spelled Abbassi from Abbass. An old Persian weight for pearls. Weighing 2.66 troy grains. Also spelled Abbassi.

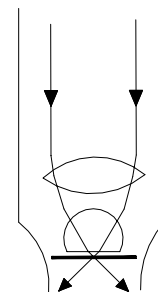
**abate**; to carve or produce a relief figure using hammer.

**abatement**; a term used in cutting for waste produced a cut stone to a specified size.

**Abbas-Mirza-Diamond**; an Indian rose diamond of 130 cts. In 1832, it appeared at the capture of Abbas-Mirza Crown-Prince of Iran. Now in National Jewel Treasury of Iran, Tehran?

**Abbassi**; → Abàsi.

**Abbé condenser**; an eyepiece or lens system placed below the stage of a microscope, which corrects the



Abbe condenser

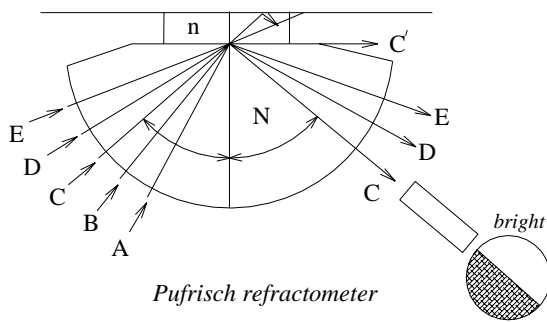
aberration of rays. It is known as an Abbé substage condenser and consists of two or three lenses, and has a wide aperture.

**Abbé number**; same as reciprocal dispersion.

**Abbé refractometer**; an optical device, which is used to measure the refractive index of minerals, gemstones, and liquids. Its function is based on the measurement of the variation of the critical angle in a hemicylinder of highly refractive glass.

**Abbé-Pulfrich-totalrefractometer**; an optical device used for the measurement of the refractive indices of

gems and minerals. Made by Abbé and Pulfrich (1840-



Pulfrich refractometer

1905). → Abbé refractometer.

**Abbé theory;** a theory which states that to obtain a true image of an object, the lens used (in a microscope or other instrument) must be suitably large as to permit the transmission of the entire diffraction pattern.

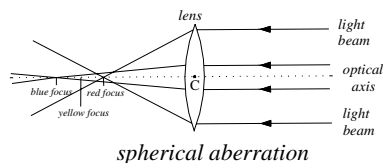
**abbot's ring;** usually a gold ring, set with a single stone, traditionally worn by an abbot on the third finger of the right hand.

**Abdollah-Giw turquoise;** a misnomer for the chrysocolla from Abdollah-Giw by Meshed, Iran.

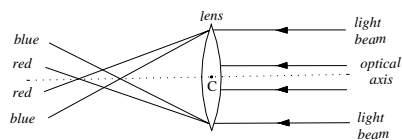
**Abdul-Madjidi;** a term used in Nishabur turquoise mine for fine dark color but not pure and soft. → Turquoise classification in Nishabur, Iran.

**Abernethy Pearl;** a fresh-water pearl of 43.60 grains and 11.50 mm in diameter, found in Scotland. Belonged to Abernethy Pearl, now on display at the establishment of Cairncross in Perth, Scotland. Also called Little Willie Pearl. It was known as Bill's Pearl.

**aberration;** failure of an optical or electronic lens or mirror to bring light into focus. When aberration is due



spherical aberration



chromatic aberration

to the form of the lens or mirror, it is called *spherical aberration*. When aberration is due to a change in the refrangibility of light of different colors, it is called *chromatic aberration*. Aberration in magnifiers often causes an inaccurate diagnosis of flawlessness or color of gems. There are various types of aberration, such as chromatic aberration, coma, spherical aberration, astigmatism, and distortion. Also called optical aberration.

**aberration, chromatic;** → aberration.

**abies balsamica;** same as *abies canadensis*.

**abies canadensis;** a genus of gymnosperm fir trees from which Canada balsam is obtained. Also called *abies balsamica*. → Canada balsam.

**ablation;** the removal away of rock debris, as by erosion or weathering.

**abortive ova theory;** a brilliant cell in the center of freshwater mussels marine oysters when opened show an equal size of ova of the same oyster, which formed upon the external surface of this ovum. A theory from Everard Home.

**abrade;** to wear away by friction, as in, to abrade rocks. → Abrasive.

**abraded culet;** a term applied to a culet of diamond, when scratched by other stones or when it has been faceted.

**abrasax;** same as *abraxas*.

**abraser;** a term used for a device to wear resistance surfaces of a substance or specimen by rubbing.

**abrah;** a Farsi term used for mottled turquoise stone with two colors. → Turquoise classification in Nishabur, Iran.

**abrasion;** the wearing off of a part of the earth's surface by moving water, ice, gravity, waves or wind. Often diamonds are tumbled or rubbed with other fragments in river or in the sea.

**abrasion;** sometimes polished diamonds abraded or scratched, by contact with other diamonds. → Abraded culet, paperworn diamond.

**abrasion test;** → abrasive test.

**abrasive;** any natural or artificial hard substance suitable for grinding, cutting, polishing, honing, lapping and pressure blasting. Diamond, emery, silica, oilstone, garnet, pumice, and diatomite powder are naturally abrasives. Artificial abrasives include borazon, silicon, carbide, aluminum oxide, and boron carbide powder.

**abrasive;** any minute, hard-cornered fragment of rock or mineral that is active in the abrasion of the earth's surface and rock material.

**abrasive grain;** tough refractory particles, which are used as abrasive material. → Abrasive material.

**abrasive material;** hard, and sometimes brittle, natural or artificial substances used for grinding, polishing, or scouring. Also called abrasive matter. Varieties of abrasive materials are: *a-carbonado*, which consist of microcrystalline diamond and amorphous carbon. *b-Hailstone borate*: containing alternate sheets of diamond and other substance. *c-Framsite*, which is more granular than carbonado and contains less diamond. *d-Stewartite*: similar to carbonado but also contains of some magnetite. *e-Ballas*: microcrystalline diamond, usually free of inclusions. Also termed shot

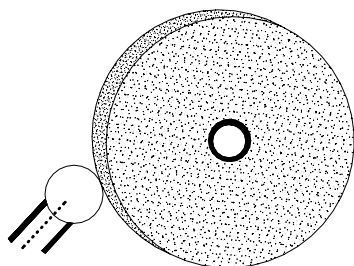
boart. Found in diamond mine areas. → Abrasive, ballas.

**abrasive matter;** → abrasive material.

**abrasive point;** abrasive or grinding point in different forms, set on a shank, used by dentists and also for metal removal.

**abrasive test;** this test employs a rotating grinding wheel or plate, charged with diamond powder, against which gemstones are held. The test sample is abraded for a given number of revolutions. The loss of weight of the gemstone is a measure of the abrasion resistance of the material. Also called abrasion test. → Attrition milling.

**abrasive wheel;** wheels, which are provided with



*abrasive wheel machine*

abrasive materials such as diamond or emery set on a shank.

**abraxas;** an invented word or symbol. An ancient charm word engraved on gemstones composed of seven Greek letters, which when converted to numerals, totaled 365 (the number of heavens by Gnostic sect). Originally believed to have magical powers and inscribed on amulets, etc. From second century A.D. on, personified by Gnostics as a deity, the source of divine emanations. An abraxas is usually engraved with a lion or a cockerel head, a human body, etc. Also spelled abraxas, and abraxax.

**abraxas;** same as abraxas.

**abrir a cor;** → opening the color.

**abruki;** a trade term used in India for shade of smoke in emerald.

**absite;** a term used in South Australian for a mineral containing titanium, rare earth, uranium and thorium, which occurs in pegmatitic association.

**absolute perfect;** → perfect.

**absolute scale;** same as absolute or Kelvin temperature scale. → Absolute temperature.

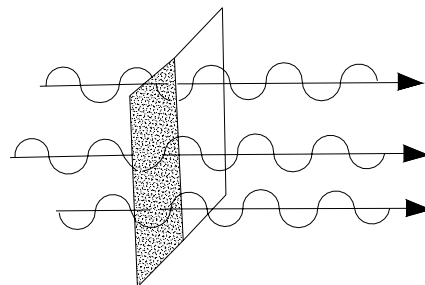
**absolute temperature;** temperature measured from the absolute zero, which is used mainly for thermodynamic work. Absolute zero or zero Kelvin is equal to  $-273.16^{\circ}\text{C}$  on the Celsius scale, or  $0^{\circ}\text{C} = 273.16^{\circ}\text{K}$  on the Kelvin scale, or  $459.69^{\circ}\text{F}$  on the Fahrenheit scale. Also called Kelvin temperature scale.

**absorbance;** same as transmission density. Former term:

### *abrasive matter – absorption spectrum*

optical density.

**absorption;** in optics, the reduction of the light intensity in transmission through an absorbing substance



*light wave and absorption*

(medium) or in reflection from a surface, in crystals, minerals and gems. Absorption may vary with wavelengths of vibration in the direction of the transmitted light or ray (color). Also called light absorption.

**absorption bands;** narrow dark zones or lines in the absorption spectrum of a given substance due to certain electromagnetic wavelengths in the spectrum being selectively absorbed, on passing through a medium. Known as absorption lines. → Absorption spectra.

**absorption differential selective;** → pleochroism.

**absorption filter;** this filter absorb the unwanted regions of the spectrum by which the energy is usually converted into heat. Such filters are made from glasses, plastics, crystals, liquids and gelatins and containing substances with selective absorptions as transitional metal ions. → Color filter.

**absorption lens;** an eyepiece, which absorbs certain wavelengths of electromagnetic radiation.

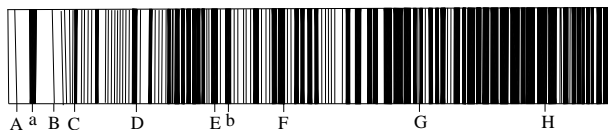
**absorption line;** narrow dark line of wavelength or frequency in the electromagnetic spectrum, caused by the absorption of a gaseous element. Also called hair lines. → Absorption bands.

**absorption, selective;** the absorption of certain colors from incident light, when passing through a colored gem (medium).

**absorption spectra;** → absorption spectrum.

**absorption spectrum;** arrangement of spectrum lines or bands obtained, when white light is transmitted through a colored gemstone, this is because certain colored stones have certain wavelengths, which will be absorbed more readily than others. When the spectrum is passed through a medium into a spectroscope, the colors most strongly absorbed may appear as dark bands or finer lines. This interrupts the *continuous spectrum* or *Newtonian spectrum* in characteristic positions, which is known as an absorption spectra. The spectrum from the light of the sun is called the *solar spectrum* or, *Fraunhofer spectrum*. The use of the

absorption spectrum is instrumental in gemological identification. → Emission spectrum, Fraunhofer lines,



continuous sun absorption spectrum

bright-line spectra.

**absorption state level;** → inverted population level.

**Abu-Eshaghi;** a Farsi term used in Nishabur turquoise mine fine dark color with high brilliant and quasi pure. → Turquoise classification in Nishabur, Iran.

**abyssal rocks;** rocks occurs in very great depth, which is a synonym for plutonic rocks.

**abyssinian gold;** imitation gold or a variety of brass resembling gold used for costume jewelry. Consisting of approximately 91% Cu, 8% Zn, or 86% Cu, 12% Zn, and 1% Sn. Also called gold shell or Talmi gold.

**Ac;** a chemical symbol for the element actinium.

**acacia gum;** same as gum arabic.

**Acaeté Diamond;** a rough diamond of 161.50 from Brazil, Found in 1971. The current owner is unknown.

**accabar;** → accarbaar.

**accarbaar;** a name applied to black coral or *King's Coral* or *Antipathes spiralis*, in southeastern Asia and the Indian Ocean region. Also spelled accabar, accarbar or akabar.

**accarbaar item;** the highest trade quality black-coral in southeastern Asia.

**accarbar;** → accarbaar.

**accelerated erosion;** erosion taking place more rapidly than geologic norm.

**accelerator;** a gigantic machine developed for increasing the kinetic energy of substance particles or atomic nuclei, in which the particles spiral inside two flat, D-shaped, hollow metal electrodes, under the effect of a strong vertical magnetic field. Particles gain energy by high-frequency voltage, applied between the electrodes. Often used to change the color of diamond green, and dark tourmaline is to green, yellow, or reddish-brown. → Electron accelerator, cyclotrone diamonds.

**acceptor;** in molecular structure an attraction between ions of opposite charges, one of which is an electron donor, and the other an electron acceptor

**acceptor;** in Type I diamonds, the presence of aluminum

atoms as impurities increases the number of holes in semiconductor such as diamond, which act as acceptors and nitrogen or boron atoms in Type II diamonds as donors. Also known as acceptor impurity.

**acceptor impurity;** → acceptor.

**accessory elements;** same as trace elements.

**accessory mineral;** the opposite of essential mineral. Term applied to any mineral occurring in small quantities in a rock, and whose presence or absence does not affect its analysis.

**accidental inclusion;** a mineral present, or fragments of a crystal, having no genetic connection with the igneous rocks, in which they occur. Also called exogenous inclusion, exogenous inclusion, enallogene of lacroix allothigenous ejectum, foreign inclusion, accidental xenolith and xenolith.

**accidental pearl;** the genuine natural pearl as distinguished from the cultured pearl, which is artificially induced.

**accidental xenolith;** → accidental inclusion.

**Accra;** metropolis of Ghana, Africa.

**Accra Diamond Company;** one of the diamond companies in the metropolis of Ghana, Africa, licensed by their government to buy diamonds from native miners.

**Accra Diamond Market;** a diamond market in Accra, which has the sole right to purchase diamonds produced by native diggers, and bears authority from the government of Ghana.

**accretion;** filling-up of a river due to wave action.

**accretion;** gradual deposition of land on a shore because of wave action.

**accretion;** gradual buildup of material around or along the walls of a cavity.

**accretion limestone;** limestone formed by the slow accumulation of organic remains.

**accumulative rock;** those igneous rocks formed by accumulation of crystals, which elected out from magma mass by action of gravity. Also called cumulate.

**acentela;** Spanish name for rock crystal.

**acetate;** a colorless, corrosive liquid with a pungent odor, of a salt or an ester of acetic acid, consisting of monovalent ion  $\text{CH}_3\text{COOH}$  or the group  $\text{CH}_3\text{COO}^-$ . Contained in vinegar. Used in the manufacture of cellulose acetate and artificial resins or plastics and fibers.

**acetate of copper dye;** a term used for heat-treated beryl (or quartz), by which the stone after heating will plunged into a bath of bright green acetate of copper, verdigris, indigo, or copper salts. Due to cracking and upon cooling the dye color drew within the recesses and give suitable color to it. Dyeing with acetate of

copper.

**acetic acid;**  $\text{CH}_3\text{COOH}$ , a clear, colorless, corrosive liquid used undiluted for testing. Used also as adhesive for plastics. Miscible with water, alcohol, and acids.

**acetone;** an organic, colorless, volatile, flammable, sweet smelling liquid form of  $\text{CH}_3\text{COCH}_3$ . Miscible with water, alcohol and ether. Soften cellulose plastics and therefore useful in their distinction. RI:1.361.

**acetylene;** a colorless, flammable, poisonous gas of  $\text{CHCH}$ , with a disagreeable odor, soluble in alcohol, acetone, and water. Used with oxygen or air for welding and melting metals.

**acetylene tetrabromide (tetrabromoethane);** a yellowish, heavy liquid, the formula of which is  $\text{C}_2\text{H}_2\text{Br}_4$ . Used for specific-gravity determination and for the separation of gemstones. RI:1.63. SG:2.964 at 20° C. Miscible with water, alcohol, ether and xylene. Also called sym-tetrabromoethane.

**Achaemenian Jewelry;** artifacts articles of gold jewelry, including ear-rings, finger rings, bracelets, and anklets from the Achaemenid dynasty, of Cyrus the Great, in Persia (559-330 BC). Exhibited in Schmuckmuseum, Pforzheim, Germany.

**Achat;** German name for agate.

**achate;** second stone at Jewish High Priest Breastplate. → Breastplate.

**achates;** an ancient name for agate.

**achirite;** a Buchara merchant, Achir Mehmèd. An obsolete name for diopside.

**achite;** a Hebrew term for agate. Also spelled achite.

**achito;** same as agate.

**achlusite;** a green altered topaz resembling steatite. Cloudy and misty in appearance.

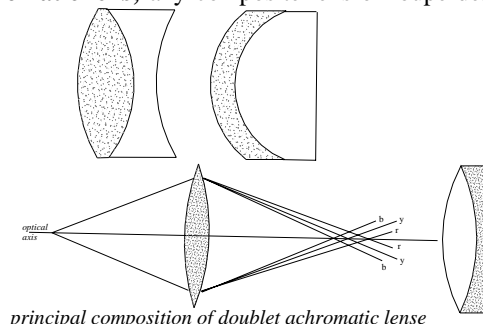
**achroite;** a colorless variety of tourmaline, used as a gemstone.

**achromatic;** without color, such as many colorless gemstones

**achromatic;** capable of reflecting or refracting light without chromatic aberration.

**achromatic color;** white, black or any nuance of gray, devoid of hue.

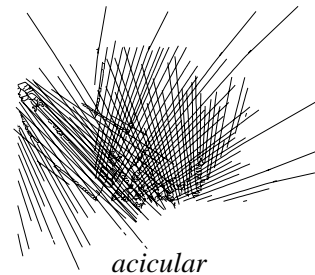
**achromatic lens;** any composite lens or loupe designed



to minimize chromatic aberration usually made of crown and flint glass.

**achromatic loupe;** → achromatic lens.

**achromatic triplet;** a corrected loupe for chromatic aberration. → Achromatic lens.



**acicular;** needle-like in form, referring particularly to crystals, such as rutile needles in quartz

**acicular;** a particle whose length is more than its width.

**acicular crystals;** crystals or minerals consisting of fine, needle-like, crystal forms such as natrolite or rutiled quartz. Also called acicular habit.

**acicular habit;** same as acicular crystal.

**aciculate;** needle-shaped, or needle-like.

**acid and solvent;** acids, particularly diluted hydrochloric acid, are of great value in testing gems. They serve a variety of purposes, for example, any carbonate, such as calcite, when dyed can be used as imitation jade, coral, shell, smithsonite, rhodochrosite, pearl, malachite, etc. The original nature is revealed by the process of pronounced effervescence, where a drop of dilute hydrochloric acid is placed on the surface.

**acid cleaning;** same as acidizing, or acidizing. Mounted diamonds are sometimes boiled in sulfuric acid to remove the dirt and other residue from the girdle.

**acidizing;** treating a diamond with acids (usually hot) to clean it after mining or cutting, especially to remove oxides or polishing residue from surface fissures.

**acidizing;** a method for cleaning and removing the color coating from rough diamonds, in a solution consisting of hydrofluoric acid.

**acid dye;** an azo dye with acid constituents such as nitro acid, carboxy acid, or sulfonic acid. Used as dyes. Also called anionic dye.

**acidic;** applied to igneous rock and magma rich in silica, where silica forms more than 2/3 of the mass or consisting of at least 65% of the rock.

**acid polishing;** a process of polishing cut decorations on glass articles by immersing the specimen in an acid bath for several minutes, rinsing in water, and brushing out the cut parts.

**acid rocks;** a subdivision of igneous rocks. Applied to rocks rich in silica to the extent, where silica forms more than 2/3 of the mass. Generally of light color and

*acid test - adamantine*

oversaturated with silica, so that free silica or quartz, is present. Chief types are granite, syenite, rhyolite, dacite and pegmatite.

**acid test;** acids used for testing noble metals such as nitric acid.

**acid test;** a process whereby small bubbles of gas escape from a mineral's surface, when acid is dropped on it. Especially as a result of chemical action such as carbonate, minerals are the result of such chemical action.

**acid test;** acidizing.

**acier;** a French term for steel.

**aciform;** needle-shaped or needle-like.

**acira;** a Sanskrit word for diamond and sun.

**acmite;** same as aegirine.

**acquamarine;** an Italian term for aquamarine.

**acquamarine se Siam;** an Italian misleading term for blue zircon.

**acquamarine crysolide;** an Italian misleading term for peridot.

**acrolein;** a colorless to yellowish liquid with disagreeable odor of  $\text{CH}_2\text{CHCO}$ . Soluble in water, alcohol and ether used as polyester resin. Very toxic.

**acronym;** a term formed from the syllables or initial of other words.

**acrylic jewelry;** → acrylic resin (plastics).

**acrylic resin (plastics);** a clear glass-like synthetic material (polymethyl-methacrylate), which can be suitably colored. It is used widely in scientific and optical instruments. It has been used for the production of molded faceted imitations of sapphire, amethyst, ruby, emerald, topaz, garnet and for the cores of solid bead imitation pearls. RI:1.485-1.50. SG:1.18. H:2. It is better known to the English under the name Perspex and to Americans as lucite.

**actinolated quartz;** rock crystals, which include fibrous-like crystals of green variety of actinolite known as byssolite.

**actinolite;** a member of the amphibole family of minerals. This mineral is an end member of the tremolite-actinolite series. Green occurs as fibers, and microscopic inclusions in *sagenitic quartz*. A tough, compact variety that supplies the mineral of commerce known as nephrite. The fibrous variety is known as asbestos.

System: monoclinic.

Formula:  $2[\text{Ca}_2(\text{Mg}, \text{Fe})_3(\text{Si}_4\text{O}_{11})_2(\text{O}, \text{OH})]$ .

Luster: vitreous, often with silky shining to dull.

Colors: white to green.

Diaphaneity: transparent to nearly opaque.

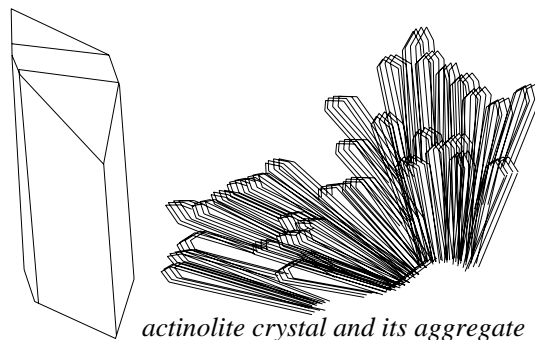
Streak: none or colorless.

Cleavage: {110} good, {100} parting.

Fracture: uneven to subconchoidal. Brittle.

SG: 2.90-3.20.

H: about 5.5.



*actinolite crystal and its aggregate*

Optics;  $\alpha$ :1.619-1.622,  $\beta$ :1.632-1.634,  $\gamma$ :1.642-1.644.

Birefringence: 0.022-0.026.  $\ominus$ .

Found in all countries.

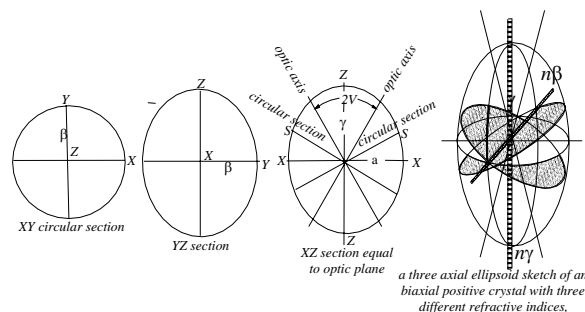
**activators;** crystals with large band-gap known as activators. → Idiochromatic, nitrogen, sensitization.

**active mine;** a profitable mine

**acute;** sharply pointed, needle shaped

**acute;** an angle less than  $90^\circ$ .

**acute bisectrix;** in crystallography the line, which



*acute bisectrix of a positive crystal*

bisects the acute angle between the optic axes in biaxial crystals.

**adamant;** the term was formerly used for diamond, and sometimes for corundum.

**adamant;** a very hard stone, mineral, metal or material, real or imaginary.

**Adamant Research Laboratory;** a subdivision research laboratory of Diamond Research Laboratory, Johannesburg of South Africa to make commercial production of synthetic and industrial diamond. Founded by De Beers-Anglo-American company.

**adamantean;** a poetical term for diamond or adamantine.

**adamantine;** a term used to describe typical diamond luster. Diamondlike. → Luster.

**adamantine;** hardness associated with diamond, zircon, demantoid and some diamond imitations.

**adamantine compound;** a chemical compound with the same tetrahedral covalent crystal structure an arrangement of atoms as the diamond.



**adamantine luster;** a term used to describe typical diamond luster. Possessed only by minerals of high refractive index. → Luster.

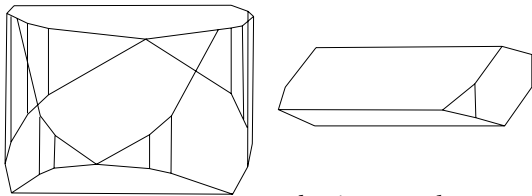
**adamantine spar;** a term applied to silky dark grayish-brown variety of corundum or sapphire, chiefly to dull opaque corundum from India, used as polishing agent.

**adamas;** an ancient Gr. name for diamond.

**adamellite;** a plutonic rock consisting of plagioclase, orthoclase and quartz with tiny biotite, hornblende, apatite, zircon and some oxides. Also called quartz monzonite.

**adamellite;** a synonym for a granite consisting of 2/3 of the total feldspars from which 1/3 is plagioclase.

**adamite;** a rare transparent to translucent mineral. Colorless, yellow, green, rose and purple pleochroism.



*adamite crystals*

Vivid green luminescence under SW and LW light. Rarely cut as faceted gems but prized by collectors.

System: Orthorhombic.

Formula:  $4[\text{Zn}_2(\text{OH})\text{AsO}_4]$ . Frequently Co, Cu.

Luster: vitreous.

Color: colorless, light yellow, light green, greenish, rose and pink, parti-colored.

Streak: colorless.

Diaphaneity: transparent to translucent.

Cleavage {011} perfect.

Fracture: subconchoidal to uneven. Brittle.

SG: 4.32-4.48

H:  $3\frac{1}{2}$ .

Optics;  $\alpha$ :1.71-1.712,  $\beta$ :1.735-1.736,  $\gamma$ :1.758-1.76.

Birefringence: 0.041-0.049. ⊕.

Dispersion: strong.

Found in Italy, Mexico, Greece, Chile, Turkey, Algeria, Nevada, California, and Utah (USA).

**adamite;** a commercial term for artificial corundum powder, manufactured for abrasive purposes. Compare alundum.

**adamsite;** an obsolete term for greenish-black variety of muscovite mica.

**adco;** a commercial term for certain types of turquoise imitation made by ceramics or of glazed, fired clay.

**adder stone;** colored glass beads, worn in medieval times, for their protective or curative powers as charm. → Toadstone

**adder stone;** a stone with absorbent qualities, once set

*adamantine luster - Adiel Topaz*

in finger rings and used as amulets. Also called serpent's stone.

**additional facets;** in diamond cutting, so as to create new and fashionable variations, occasionally cutters add symmetric facets to a standard-cut. These added facets are not blemishes and are not to be confused with extra facets.

**additive coloration;** a term used in optics to process of producing or reproducing color by excessive addition of color centers to the crystal structure by exposing a crystal to excessive metal such as fluorite exposing to hot calcium vapor. Addition of color centers to the crystal structure can done by using electrodes to a heat fluorite crystal when an electric passing through it. → Additive primary colors, subtractive color process.

**additive color process;** a process of producing or reproducing color by mixing additive primary or three different colors in various proportions. → Additive primary colors, subtractive color process, additive coloration.

**additive primary colors;** a term used in optics to three different colors usually red, green and blue, which are mixed together in a additive process, proportion is determine the color will obtained. → Additive color process, subtractive color process, additive coloration.

**adorned;** a term used for turned or set figures back to back as adorned pieces on a coat of arms.

**adductor muscle;** in bivalve mussel, a muscle passing across one valve to another, valve and connecting the two valves or halves.

**Adelaide ruby;** a local and misleading term for the blood-red almandine or pyrope (garnet), from Adelaide, Australia.

**ADEX;** an acronym for Australian Diamond Exploration Joint Venture.

**adhesion;** intermolecular attraction which hold matter together, particular contiguous surfaces, such as liquid in contact with a solid.

**adhesive;** substances which hold materials together by surface attachment, such as liquid glues, cements, dry film, etc.

**ADIA;** an acronym for American Diamond Industry Association.

**adiabatic;** a term used in thermodynamic and other test of minerals in which no heat enters or leaves.

**adiabatic piezoelectric;** → adiabatic pressure.

**adiabatic pressure;** a term used in thermodynamic to the relationship of pressure and volume in which no heat enters or leaves. In an adiabatic operation, compression caused rising of temperature and expansion in a system.

**adiabatic pyroelectric;** → adiabatic pressure.

**Adiel Topaz;** a dark-blue, irradiat Brazilian topaz of 4kg

*adinole – aerosiderolite*

or 20.000cts. It was cut from a rough stone of 7.8kg. Found in 1987. Sold to unknown Japanese.

**adinole**; a German term meaning compacts. A greenish-gray fine-grained, felsitic, contact-metamorphic or metasomatic rock, rich in quartz and albite. Adinoles are formed by reaction following the intrusion of silicified diabase, or porphyries, into shale or slate (compare spilosite; desmosite). In German, the term is Schalstein.

**adit mining**; a miner term used for a mine with a horizontal entrance.

**adjusting microscope**; same as focusing microscope.

**ADM**; an acronym for Accra Diamond Market, Argyle Diamond Mines, LTD.

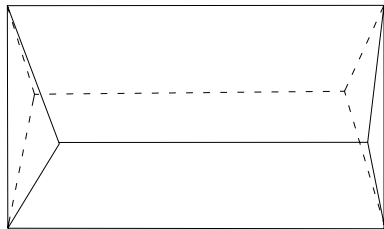
**adobe**; a term applied in Mexico and Southwestern USA for a heavy-textured, clayey and silty substance used for sundried bricks.

**adornar con diamantes**; a Spanish term meaning to adorn with diamonds.

**adular**; → adularia.

**adularescence**; a milky-white or bluish sheen, seen when a gemstone is held in a certain direction. Usually adularia, a moonstone feldspar display this property, when it is turned under light, and its effect is caused by diffused reflections of light in the gem and due to parallel intergrowths of another type of feldspar with a slightly different refractive index of that of the main mass of adularia. It is often called schiller. → Adularia, schiller, labradorescence.

**adularia**; named after the Adular mountains in



*adularia crystal*

Switzerland. A pure colorless to milky variety of orthoclase feldspar, often with silky shining. Same as precious moonstone. Sometimes spelled adular. Valencianite is a local term for adularia from Valencia, Mexico.

Formula:  $4[\text{KAlSi}_3\text{O}_8]$ .

System: triclinic, pseudo-orthorhombic.

Luster: vitreous

Colors: colorless, white to milky.

Streak: white or colorless.

Fracture: uneven to conchoidal. Brittle.

Diaphaneity: transparent to translucent.

cleavage, {001} perfect, {010} less perfect.

SG: 2.54-2.57.

H: 6.

Optics;  $\alpha$ :1.519,  $\beta$ :1.523,  $\gamma$ :1.525.

Birefringence: 0.006.  $\ominus$ .

Dispersion: 0.014.

Principally from Sri Lanka.

**adularia-moonstone**; same as precious moonstone.

**adularization**; introduction of or replacement by mineral adularia.

**adventitious**; a term used for non-accidental pearl, which occurs not naturally, in contrast to accidental pearl.

**adventurine**; obsolete term for aventurine.

**adventurine feldspar**; obsolete term for aventurine feldspar.

**adventurine glass**; obsolete term for aventurine glass.

**adventurine quartz**; obsolete term for aventurine quartz.

**ÅE**; → Å. Ångström.

**aegirine**; an acicular or fibrous crystal of the clinopyroxene group. Its intense green color, which is related to jadeite. Cabochon is rarely cut because of the chatoyance effects. Varieties are acmite, which display the chatoyance effect, and aegirine-augite. Also called aegerite.

System: monoclinic.

Formula:  $4[\text{NaFe}(\text{Si}_2\text{O}_6)]$ .

Luster: vitreous to resinous.

Colors: green, greenish-black, greenish-brown.

Streak: yellowish-gray, green.

Diaphaneity: opaque to translucent.

Cleavage: {110} good, {010} parting.

Fracture: uneven. Brittle.

SG: 2.50-3.60.

H: 6-6½.

Optics;  $\alpha$ :1.76,  $\beta$ :1.785,  $\gamma$ :1.806. For aegirine-augite  $\alpha$ :1.740-1.748,  $\beta$ :1.76-1.767,  $\gamma$ :1.78-1.79.

Birefringence: 0.046.  $\ominus$ . For aegirine-augite: 0.040-0.042.  $\ominus$ .

Found in Arkansas, Colorado, New Jersey (USA), Montreal (Canada), Greenland, Norway, Brazil and Portugal.

**aegirine-augite**; → aegirine.

**aegirite**; same as aegirine.

**aeoline rocks**; rocks or placer, which has accumulated by wind action. → Eolian, eolian placer, eolian marble.

**aeoline deposit**; same as aeolian rocks.

**aeolotropic**; → crystal anisotropy.

**aeolotropy**; → crystal anisotropy.

**aeroide**; a term for used by Pliny for pale sky-blue aquamarine beryl.

**aeroides**; a local American term for pale sky-blue aquamarine beryl.

**aerolites**; → meteorite.

**aerosiderolite**; → stony iron meteorite.

**aetites**; → eaglestone.

**Affenrücken**; a German term meaning monkey-back. Also, an alluvial area, which produces diamonds in South-West Africa owned and operated by Consolidated Diamond Mines of South-West Africa.

**Afghanistan amber**; a misleading term for orange to orange-brown, semi-translucent thermosetting or thermoplastic amber imitation from Afghanistan or Middle East, which named as prayer beads and also called Egyptian amber.

**Afghanistan lapis**; a deep blue, top quality lapis lazuli from Fizabad of Badakhshan, Afghanistan. Russian lapis is of the same high quality.

**Afghan turquoise**; a misleading term for stained magnesite.

**African amber**; a term applied to yellow, opaque, oblate or barrel-shaped amber imported from Baltic area to Africa, which were worn by natives with colorful glass beads.

**African amber**; a misleading term for copal amber.

**African Diamond Diggers' Association**; formerly, a union of independent Nigerian Diamond Miners in Ghana, Africa, now inactive.

**African Diamond Winners' Association**; formerly, a union of independent Grannies Diamond Miners in Ghana, Africa, now inactive.

**African blue marble**; a less brilliant blue, marble, from Kenya, Africa.

**African emerald**; a misleading term for green fluorite from South-West Africa.

**African emerald**; a misnomer for green tourmaline from Africa.

**African emerald**; yellowish green emerald from the Transvaal of South Africa. Optics;  $\omega$ :1.593,  $\epsilon$ :1.586. SG:2.75. Also, found in Zimbabwe.

**African jade**; a misleading term for a green, compact variety of grossular garnet from Africa. Also called Transvaal jade, or South African jade.

**African nephrite**; a misleading term for Transvaal jade.

**African pearl**; a natural pearl, fished off the east coast of Africa, between Zanzibar and Inhambane.

**African star coral**; a misleading term for a precious opal of the genus *Allopora nobilis* from Africa.

**African tourmaline**; a commercial term for all yellowish-green to bluish-green tourmalines, of any origin, the same as Transvaal tourmaline.

**African tourmaline**; frequently used for fine, nearly emerald-green tourmaline from South West Africa.

**African Yellow Diamond**; the yellow cut diamond of 112 cts, which historically noted in 1882. Present owner unknown.

**africita**; Spanish for black tourmaline (schorl).

**Afro-American Enterprises**; a company in Accra,

Ghana, licensed by its Government to buy diamonds from native miners in Ghana, Africa.

**Afro-West Mining, Ltd.**; an Australian diamond corporation operating mines in Western Australia.

**afterglow**; a luminescent glowing effect after the induced energy has disappeared. Many diamonds, show an afterglow effect (phosphorescence). Also called persistence.

**Ag**; a chemical symbol for the element silver (argentum).

**Aga Khan III Diamond**; the flawless, pear-shaped diamond of 33.13 cts, which had been recut from a 38 cts, pear-shaped stone. Named after Aga Khan III, it was most recently sold in 1988.

**agalite**; a fine fibrous variety of talc, which is pseudo-morphosed after enstatite.

**agalite**; a synonym for asbestine.

**agalmatolite**; a soft, waxy, silica-rich and compact mineral or stone such as painite, pyrophyllite, and steatite of a greenish, grayish, yellowish and brownish color. RI:1.552-1.600. SG:2.80-2.90. H:1-1½. Consequently, it has a greasy touch. Used by Chinese for carving small images, miniature pagodas, and other objects. Some agalmatolites are steatite  $Mg_3Si_4O_{10}(OH)_2$  or pyrophyllite  $Al_2Si_4O_{10}(OH)_2$ . Synonym: figure stone, pagodite, lardite, pagoda stone, lard stone, figured stone. Sometimes loosely called soapstone or soap rock.

**agalmatolite**; sometimes incorrectly called to jade.

**agmatite**; a migmatite in which introduced xenolithic materials.

**agmatite**; fragmental plutonic rocks which are embedded in granitic cement.

**agaphite**; named after the scientist Demetrios Agaphi. A vitreous variety of Persian turquoise from Nishapur, Iran.

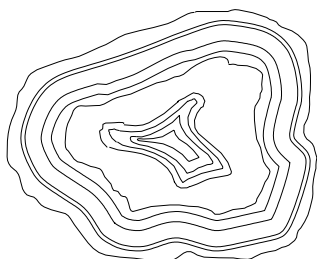
**agaric chalk**; synonym for sepiolite.

**agaric mineral**; synonym for moon milk.

**Agastimata book**; an Indian ancient book before the 10<sup>th</sup> century A. D., which treatise gemstones and recognize 8 categories of emerald.

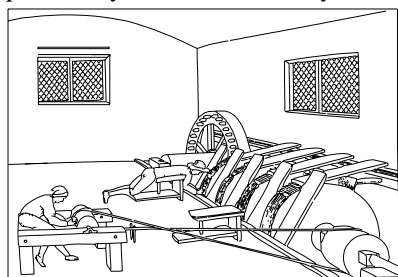
**agate**; a subvariety of chalcedony of varying shades or, translucent to semitransparent cryptocrystalline varieties of quartz. Often, variegated chalcedony, alternates with opal. This type is characterized by colors arranged in alternating stripes or bands as in banded agate, sometimes with onyx. In the translucent form agate shows irregular cloud-like shapes with mossy or dendritic inclusions (moss-agate), frequently creating the impression of landscape or vegetation. Found in virtually all colors, and usually of low intensity, it commonly occupies vugs in volcanic rocks, and cavities in certain other rocks. Most gray-banded agate is dyed to improve its color. Often used for

gemstones, cut cabochon, beads, pendants and for



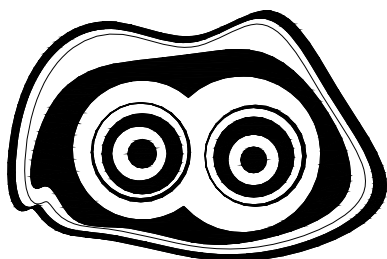
*section through an agate with partly concentric varicolored bands*

carving objects, and for example clock cases. Agate varieties are found in India, Brazil, Hungary, Malagasy, Mexico, Namibia, Uruguay, Germany, and the USA. The different classification of agate, jasper, and chalcedony are based upon its transparency. Jasper is the opaque variety, while chalcedony is translucent.



*a historical agate working center in Idar-Oberstein, Germany. After Vollstaedt & Baumgaertel*

Many translucent and bright colored stones are known as agate: → Banded agate, clouded agate, moss agate,



*typical concentric rings on polished surface of agate*

scenic agate, lace agate, fire agate, shell agate, Turritella agate, and onyx.

**agate bead**; an agate bead resembling coral in color.

**agate glass**; a type of glass of various colors, which resembles agate. → Agate ware.

**agate, inclusions in**; → fibrous of quartz in agate.

**agate jasper**; an impure mixture of jasper containing veins of chalcedony occur. It occurs in many colors, what is now called jasper agate, was once known as *jaspe fleuri*. Also called jaspagate.

**agate like**; similar to agate.

**agate mortar**; a bowl-shaped vessel made from agate, in which hard brittle substances, principally glass and minerals, are ground into powder.

**agate, onyx**; same as onyx agate.

**agate opal**; misleading term for either opal or agate. It is mineralogically impossible for a stone to be both. Also called opal agate. → Opalized agate.

**agate shell**; from the agate snail, a large land snail, of no gemological interest.

**agate thunder egg**; → thunder eggs, star-shaped core.

**agate ware**; in pottery, a variety of Wedgwood, veined and mottled in colored, and marked to resemble agate. Clay bodies are formed by blending different colored clays, or by coloring surfaces with different colored slips.

**Agathis australis**; → copal.

**agathocopalite**; → kauri, kauri copal.

**agatiferous**; term meaning to produce agate, or containing agate.

**agatine**; term meaning pertaining to agate, or agate-like.

**agate**; term meaning to convert into, or cause to resemble, agate.

**agatized coral**; same as fossil coral. Used as cabochon and sometimes dyed blue or pink.

**agatized wood**; chalcedonic pseudomorphic wood or, a variety of silicified wood, which may resemble any of the agates. Also, called silicified wood, petrified wood, or wood agate. → Mineralization.

**agaty**; a miners term used in Australia to a mixture of potch and colored clay which gives a banded effect to the stone. Also called agatey potch.

**agatey potch**; → agatey.

**aged**; → stress cracks in amber.

**age of gymnosperms**; → Mesozoic.

**age of reptiles**; → Mesozoic.

**agglomerate**; a chaotic assemblage of coarse, angular, pyroclastic fragments embedded in an ashy matrix, as the result of explosive volcanic activity, which united by action of heat, as opposed to a conglomerate.

**agglomerate**; uncoated or loosely-attached pyroclastic fragments.

**aggregate**; (lat.: corporate, collective), a cluster or group of minerals. A mass of units or parts somewhat loosely associated one with the other by a natural binding agent, which is separable by mechanical means. → Mineral aggregate, crystalline aggregate.

**Agilulf, King**; → Crown of King Agilulf.

**agmarine**; a French term for aquamarine.

**agmatite**; migmatite looking like a breccia.

**agnostogenic**; rocks or minerals of unrecognized origin.

**Ago Bay**; a major center in Japan for culturing pearls, are farmed in Mie Prefecture, Honshu, Japan.

**Agra Diamond**; the rose, cushion-shaped diamond,

possibly of Indian origin. Said the Baber (1483-1530) the first Mogul Shah from India possessed this diamond at one time and named it after the city of Agra. It was smuggled to Europe, and bought by Duke of Brunswick in 1844, after having been recut in Paris, reducing its weight from 46 cts, to 31.50 cts. Again sold in 1904 by Christie's, to the CIBA Corporation of Hong Kong, China.

**agrostemma flos jovis**; equivalent Latin term for flower of jove used by Pliny.

**AGS**; an acronym for American Gem Society.

**AGS color grading system**: the AGS color system, which has eleven grades, from colorless to yellow designated as 0, 1, 2, 3, 4, 5, 6, 7, 8, 9, and 10. The steps are broader than the traditional scale. Often called the American system. See appendices.

**Agstein**; a German term for jet.

**aguacate cut**; a drop-cut form like avocado, polished without facets used as pendant.

**Agua Suja Mine**; a diamond mine near the Bagagem River in Minas-Gerais, Brazil, famous for its gem-quality diamonds.

**Agulhas**; Brazilian miner's term for titanium oxide, associated with diamonds found in Brazilian Diamond mines.

**aguamarine**; Spanish spelling for aquamarine.

**agua-marinha**; Portuguese spelling for aquamarine.

**agua-marinha de São**; a Portuguese misleading term for aquamarine colored zircon.

**ahlāmāh**; a term for the ninth stone of Aaron, the biblical High Priest Breastplate. Generally associated with amethyst and engraved with the name Dan. In Hebrews, Dan means *dream*.

**Ahmed-Abad Diamond**; an Indian diamond, bought by Tavernier who had recut it in Paris, reducing its weight from 157.25 cts, to 94.50 cts. It sold once in Persia. It has been recut since.

**Ahrens Prism**; a modification of calcite, or the Nicol prism. A transparent calcite prism used for production plane, and for polarized light to obtain a more economical use of calcite.

**ahtet-kya**; a Burmese term used for fourth class corundums which are known as ahtet-kya and graded into two categories. → Corundum classification in Myanmar.

**ahtet-kya**; a Burmese term with the means fallen from the top. A term used for mixed corundum stones of the above grades therefore little defective in shape and water. Parcels of lower grade stones. → Corundum classification in Myanmar.

**Ahura**; → Ahura-Mazda.

**Ahura-Mazda**; → asura.

**Aichal diamond mine**; (Russ.: glory), the mine digging the kimberlitic pipe of diamonds occurring in the

Jaccutian district of Siberia, the Russian Federation, CIS. Also spelled Aikhhal.

**Aichal pipe**; a kimberlitic pipe of diamond, which occurs in the Aikhhal district of Siberia, the Russian Federation, CIS.

**aigrette**; an ornament, or piece of jewelry in the form of a plume of feather, used as a hair ornament. Also called aigrette jewel. → Jeqa.

**aigrette jewel**; → aigrette.

**aigue-marine**; French name for aquamarine.

**aigue-marine chrysolite**; a French misleading name for aquamarine colored peridot.

**aigue-marine de Siam**; a French misleading name for aquamarine colored zircon.

**aigue-marine orientale**; a French misleading name for aquamarine colored sapphire.

**aigue-marine**; French name for aquamarine.

**ajkaite**; → ajkrite.

**Aikhhal**; same as Aichal.

**Aikal pipe**; → Aichal pipe.

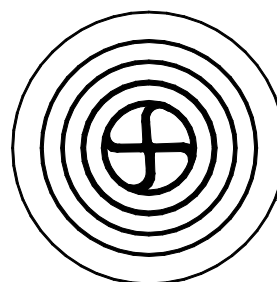
**aikinite**; a mineral of  $PbCuBiS_3$ . Orthorhombic crystal. Gray to black color. Metallic luster. Streak black. Needle-shaped crystals. SG:7.07. H:2. Found in Russia and Idaho, USA. It is of interest to gem collectors. Also called needle-ore, patrinite and belonite.

**air etching**; small cavities or etch marks formed on the surface of minerals or crystals during weathering process.

**air void**; same as air pore or air interstice.

**airy disc**; a bright spot of light that can be seen around the diffraction rings, which produces a clear point while an optical lens system can not produce a point image, due to the nature of waves of light. This diffraction pattern is known as *antipoint*.

**Airy's spiral**; an optical interference effect which can be seen in a twinned uniaxial crystal such as quartz or



*Airy's spiral interference figure of quartz crystal*

particularly in amethyst in which the brushes intersecting similar to black cross at the center but the ends of crosses are curved in a spiral form and do not cross the color rings. Also called Airy's spiral interference.

**Airy's spiral interference**; → Airy's spiral.

**A-jade;** a term applied to some jades, treated or coated with wax or paraffin.

**Ajerlaut;** a fancy term for the sea-green diamonds from Borneo, Indonesian.

**ajkite;** a pale-yellow to dark reddish-brown, sulfur-bearing fossil resin found in brown coal. Synonym: ajkaite.

**Ajmer-Merwara Emerald Field;** an emerald field in south Rajasthan, India with fine crystal of Precambrian in calc-silicate rocks, quartzites, limestones, and schists.

**à jour;** a French term which literally meaning to allow light to penetrate. Used to describe an open style setting for gems mounting which permits a view of its pavilion. Most modern mounts are of this type, unlike the earlier closed setting.

**AK-1 Pipe;** → Argyle Kimberlite Number 1.

**akabar;** or accarbaar, a name applied to black coral found in the southeastern Asia and the Indian Ocean regions.

**akaganeite;** a natural mineral of goethite family or beta-FeO(OH), occurring at the Akagane mine, Japan. → Goethite.

**Akbar Shah;** → Akbar Shah Diamond.

**Akbar Shah Diamond;** a famous Indian diamond, believed to have once been set as one of the eyes of the Peacock Throne, named after Shah Akbar and Shah Jehan. When Nadir Shah of Persia invaded India in 1739, he retrieved this diamond and brought it back to Persia. In 1866, it was sited again in Constantinople where it had been renamed as Shepherd Stone Diamond. It was recut into a drop shape in London, reducing its weight from 116 cts, to 73.60 cts. Also known as The Akbar shah or Jahan Akbar Shah. Its present owner is unknown.

**akerite;** a term used for blue spinels, found in marbles in Aker, Norway.

**akerite;** an augite-bearing syenite rock from Aker Norway, containing microcline, oligoclase, and augite.

**akerite;** fine-grained, leucocratic essexite and normarkite.

**akerite;** an augite-bearing syenite rock from Aker Norway, containing microcline, oligoclase, and augite.

**Akim Concessions, Ltd.;** a Ghanaese diamond company that works an alluvial deposit in Ghana, Africa.

**akori coral;** a horny, porous, blue variety of coral (*Allopora subiroleca*), which was used in ancient times for jewelry. It was collected, fashioned and prized by the black people of the West African coast and in Samoa. Also called blue coral

**akori coral;** the name has been recently applied to substitutes such as pearl, glass, coral, and rock. → Black coral.

**Akoya-Gai;** a Japanese term for the *Pinctada martensii* mollusk, used for cultivating pearls.

**Akoya-oyster;** a Japanese term for the *Pinctada martensii* (silver-lipped or gold-lipped), *Pinctada maxima* (black-lipped), *Pinctada margaritifera* (black-winged) mollusk used for cultivating pearls.

**aku-vamarin;** Turkish name for aquamarine.

**Akwatia;** an alluvial diamond mine, on the east bank of the Birim River in Ghana, Africa.

**akyan-the;** a Burmese term used for like asa-yo but for smaller corundum stones. → Corundum classification in Myanmar.

**akyaw-the;** a Burmese term used for pale, minute corundum stones of good quality. → Corundum classification in Myanmar.

**Al;** a chemical symbol for the element metallic aluminum.

**alabandine;** alternate pronunciation for almandine. → Almandine garnet.

**alabandine ruby;** a misleading term for alabandine garnet (contain Mn) from the ancient district of Alabanda, Asia Minor.

**alabandine ruby;** a misleading term for now sometimes used to refer to violetish-red spinel.

**alabandite;** an old term for almandine, from Alabanda, in Asia Minor.

**alabaster;** a firm very fine-grained, massive ornamental variety of gypsum. Usually snow-white and translucent but sometimes, delicate shades with yellow, gray, brown, red, or orange. Because its soft, it is used in interior decoration, also, widely used for ornamental purposes and for statues. Optics;  $\alpha$ :1.5207,  $\beta$ :1.5230,  $\gamma$ :1.5299. Birefringence: 0.010.  $\ominus$ . SG:2.32-2.33. H:2. Found in Italy, and England, where it is known as *pink Welsh alabaster*. It may be dyed. Also spelled alabastron.

**alabaster;** sometimes also incorrectly referred to is the beautifully banded form of stalagmitic calcite occurring in Algeria, and in Egypt. → Gypsum, onyx marble, Egyptian alabaster, Oriental alabaster. The alabaster of ancients was calcite, but what we now call alabaster is massive gypsum. Also called alabastrite.

**alabaster glass;** a special opalescent glass used for imitation pearls. Not to be confused with true alabaster.

**alabaster-jade;** a misleading term used for amazonite.

**alabaster onyx;** incorrect name for a colorless, banded travertine or stalagmitic calcite, or marble.

**alabaster of ancient;** a misleading term for alabaster, Oriental.

**alabaster, Oriental;** a misleading term for stalactite and stalagmitic varieties of calcite, consisting of straight or parallel bands of calcite of alternating shades. Also miscalled *Algerian onyx*, *alabaster of ancient*.

**alabaster pearl;** alabaster beads, coated with a pearl-like surface.

**alabastrite;** another term for alabaster.

**alabastron**; an earlier and misleading term for calcite-marble.

**alabastron**; another spelling for alabaster.

**alacolite**; same as diopside.

**Aladdin Mine**; an opal mine operating in Thackaringa Hills, Queensland, Australia, founded in 1878 by Paddy Green.

**alagite**; a dull red, or green, altered rhodonite.

**alajites**; a Mexican name for altered rhodonite.

**alalite**; a local term for the green variety of diopside from Ala Valley, Piedmont, Italy. Also, found in Brazil, and Austria.

**almandine**; same as almandine.

**Alamasi Ltd.**; → Almasi Ltd.

**alambre**; a Portuguese term applied to Amber.

**Ala mine**; a small grossularite garnet deposit of brilliant hyacinth-red color from Ala, Turin, Italy.

**alaqueca**; Spanish pronunciation for hematite.

**alargan**; a German alloy of aluminum and silver, used as a substitute for platinum in jewelry, and in making commercial handicrafts.

**Alaska black diamond**; a misleading term for hematite.

**Alaska diamond**; a misleading term for a transparent rock crystal from Alaska.

**Alaska jade**; an incorrect name for pectolite.

**Alaskan amber**; Alaskan amber is found in Cretaceous strata.

**alaskite**; a leucocratic, granite, which contain quartz and feldspar, when it consisting mostly of quartz; it is a transitional phase between alaskite and quartz.

**alaskite-quartz**; an acidic quartz-feldspar rock, containing mostly quartz; it is a transitional phase between alaskite and quartz.

**alasmoden pearl**; a freshwater pearl of the best quality, found in the *Alasmodon margaritifera* mollusk in Nova Scotia, Canada, and in Chinese rivers.

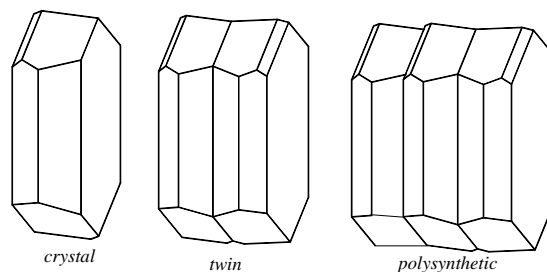
**alberene stone**; a commercial term for a dense gray soapstone, known as polyphant stone. found in Albermarle County, North Carolina, USA.

**alberene**; a trade name for a dense gray soapstone, occurring in Albermarle County, North Carolina, USA.

**albertite**; a jet-like mixture of hydrocarbonate or asphalt mineral. Albertite have an adamantine luster and a conchoidal fracture. RI:1.55. SG:1.097. H:2. Occurs in veins in oil bearing strata. Insoluble in most organic solvents. Used for carving and as imitation jet. Found in Albert County, and New Brunswick, Canada.

**albite**; an end member of the plagioclase series of the feldspar group. A transparent to translucent mineral. Varieties are *albite moonstone*, and *peristerite*, which is also called *pigeon stone*. Albite sometimes display adularescence and chatoyancy effects. Some albite or oligoclase is the source of weak sunstones. When albite

or oligoclase inclusions are exsolved in microcline or orthoclase feldspars, and they are visible to the naked eye this is called *perthite*. Albite moonstone, sunstone



*albite crystal and polysynthetic twinning*

and aventurine feldspar are varieties. → Feldspar, perthite feldspar, antiperthite.

System: triclinic.

Formula:  $4[\text{NaAlSi}_3\text{O}_8 + n\text{CaAl}_2\text{Si}_2\text{O}_8]$ .

Luster: vitreous.

Colors: white to colorless, occasionally reddish, bluish, yellowish, greenish, gray, gold, or brownish-pink.

Diaphaneity: transparent to translucent.

Fracture: uneven or conchoidal. Brittle.

Streak: white or colorless.

cleavage: {001} perfect, {010} nearly perfect, and {110} imperfect.

SG: 2.60-2.63.

H: 6-6.

Optics;  $\alpha$ :1.527,  $\beta$ :1.531,  $\gamma$ :1.538.

Birefringence: 0.011. ⊕.

Dispersion: 0.012.

Found: widespread.

**albite as inclusion**; in some topaz albite feldspar can be seen as inclusion.

**albite-epidote-hornfels**; a hornfels rock, which contains albite and epidote. Also called albite-epidote rock.

**albite-epidote rock**; same as albite-epidote-hornfels.

**albite moonstone**; a rare variety of albite feldspar-plagioclases, which exhibits a silvery sheen.

**albite porphyrite**; → albitite.

**albite twin law**; refers to a type of twin law seen in albite feldspar with orientation of alternate lamellae, in which the twinning plane is brachypinacoidal and is common in albite. → Albite.

**albitite**; a coarse-grained porphyritic igneous rock containing phenocrysts of albite in groundmass. Common accessory minerals are quartz, garnet, muscovite, apatite and opaque oxides. Also called albitophyre, albite porphyrite.

**albitophyre**; → albitite.

**albolita**; a plastic cement consisting mainly of silica and magnesia. Also spelled albolith.

**albolith**; → Albolita.

**albumen**; a substantial part of the corozo nut or the

*alcohol – alexandrite-like*

white of an egg. It is a water-soluble, albumin protein.

**alcohol**; especially ethyl alcohol. A transparent, colorless, aromatic volatile liquid. Composition  $C_2H_5OH$ . Used for diluting certain heavy liquids and as an immersion liquid in microscopy. RI:1.36. Also called ethanol.

**aldehyde**; formula:  $CH_3CHO$ , it has a pleasant smell. Used essentially for synthetic resins. Also called aldehyde resins (plastics).

**aldehyde resins (plastics)**; same as aldehyde.

**aldur**; same as pollopas.

**alexandrita**; Spanish pronunciation of alexandrite.

**Alençon diamond**; a misleading term for smoky rock crystal from Alenon, France. The French spelling is Pierre d' Alenon.

**Alenoon diamond**; a misnomer for rock crystal.

**Aleppo stone**; same as eye agate. → Cyclops agate.

**alexandrine turquoise**; another spelling for Alexandrian turquoise. Also called Egyptian turquoise.

**Alexander Bay**; named for the German geologist who it in 1926, discovered the southern lip of the diamond-bearing district at the mouth of the Orange River in Namaqualand, Africa.

**Alexander Bay Development Corporation**; a diamond company, operated the alluvial deposits south of Alexander Bay, on the west coast of South Africa. Now called Alexcor.

**alexandrite**; a smart misspelling of *alexandrite*, which has been deceptively used for alexandrite-like synthetic sapphire, or synthetic spinel.

**Alexandrian turquoise**; a commercial term for Sinai Peninsula, Egyptian turquoise. From Sinai. Also known as Egyptian turquoise.

**Alexandria shell**; also called Egyptian shell, synonym for mother-of-pearl.

**alexandrine**; a misleading term for synthetic alexandrite-like sapphire, which changes color. Also called synthetic alexandrite.

**alexandrine sapphire**; a misleading term for a sapphire, which is blue in natural daylight. But changes to violet, purple or reddish under most artificial light, same as alexandrite. Synonym: alexandrite-like sapphire.

**alexandrite**; named after Russian Tsar Alexander II. A highly dichroic, rare variety of chrysoberyl. Emerald green in natural daylight, reddish in violet by artificial light, due to its unusual absorption properties. One of the hardest and most important gemstones. A fine variety is the *night stone*. Iron-rich varieties are yellow, green and brown in color, and are inert under UV light or X-rays. Only alexandrite exhibits a weak, red luminescence under SWUV light. Synthetic alexandrites are produced by the Czochralski, the pulling method, the flux process, and the floating-zone method.

System: orthorhombic.

Formula:  $4[Al_2BeO_4]$ .

Luster: vitreous.

Colors: emerald green in daylight, reddish to violet by artificial light.

Streak: none or White.

Diaphaneity: transparent.

Cleavage : {110} distinct, {010} imperfect, {001} indistincts.

Fracture: conchoidal to even. Brittle.

S.G. : 3.75 0.10.

H: 8 .

Optics;  $\alpha$ :1.746,  $\beta$ :1.748,  $\gamma$ :1.756.

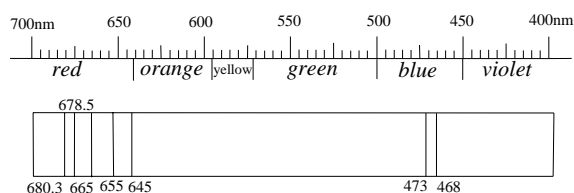
Birefringence: 0.009-0.012.  $\oplus$  may be also  $\ominus$ .

Dispersion : 0.015

From Sri Lanka, Brazil, China, and Russia.

**alexandrite**; a misleading trade term for imitation alexandrite, which is made from certain other synthetic stones, such as vanadium colored synthetic corundum, or spinel. Mistakenly named *synthetic alexandrite*. → Twinning in chrysoberyl.

**alexandrite absorption spectrum**; contains a broad absorption band at 580 nm for chromium, while alexandrite is strongly trichroic and has a different



*alexandrite absorption spectrum*

spectrums in different direction. → Alexandrine.

**alexandrite cat's-eye**; a chatoyant variety of alexandrite, with parallel inclusions. Cut en cabochon, it has a light cat's-eye effects.

**alexandrite-colored sapphire**; → alexandrine sapphire.

**alexandrite cut**; mostly for yellow stones used mixed cut, step cut and also cut cabochon, accentuates cat's-eye effects.

**alexandrite doublet**; a misleading term for both suitably colored synthetic sapphire and spinel, which are used to create alexandrite doublet.

**alexandrite garnet**; a misleading term for a garnet, which display color change.

**alexandrite inclusions**; needles of actinolite and goethite, mica, apatite, quartz, displaying two or three phases of inclusions.

**alexandrite-like sapphire**; → alexandrine sapphire.

**alexandrite-like synthetics**; suitably-colored, synthetic sapphire and spinel, used to imitate alexandrite. → Alexandrine sapphire, synthetic alexandrite.



**alexandrite-like tourmaline;** synonym for chameleonite.

**alexandrite twinning;** commonly twinned pseudo-hexagonal, as trillings, *cyclic twin* or *flowers* exist in some Russian alexandrite.

**alexandrium;** an artificial gem comprised of lithium aluminum silicate and made in a variety of colors. neodymium as a coloring agents yields pink lavender colors. A vivid, laser blue variety blue is colored by copper.

**Alexcor;** → Alexander Bay Development Corporation.

**alexite;** a misleading term used by manufactures for synthetic or imitation diamonds such as YAG, in the USA.

**alfrax;** electrically fused alumina (Al<sub>2</sub>O<sub>3</sub>), which is used as a refractory.

**algae;** dark brown, wavy patterns characteristic of algae. Same as seaweed.

**algal marble;** a marble containing remains of fossilized algae. → Coralline marble.

**algam;** in Wales, a common word for the metallic element, tin.

**Algeiba Star;** the yellow, cushion shaped diamond of 133.03 cts, probably from South Africa. Formerly named as Mahjal, it was sold in 1983. Present whereabouts unknown.

**Algeiba Star Diamond;** a yellow, cushion-shaped diamond of 133.03 cts, from South Africa. It was recut from a stone of 139.38 cts, which was known as the Mahjal Diamond (an India Maharajah of Kapurthala, Punjab). Sold by Christie's in 1983. Also called Mahjal Diamond.

**Algemene Diamantbewerkerbond van Belgie;** an organization of diamond cutters in Belgium.

**Algemene Nederlandsche Diamantbewerkerbond;** an organization of diamond cutters in the Netherlands.

**Algerian coral;** a trade classification for a medium-quality coral from the coast of Algeria, Africa. → Coral,-trade classification of.

**Algerian onyx;** a misleading term for a stalagmitic variety of calcite, characterized by beautifully banding. Also known as Alabaster Oriental or Oriental Alabaster, Algerian onyx (marble). → Alabaster.

**Algerian onyx (marble);** → Algerian onyx.

**algerite;** an alteration of scapolite mineral, usually related to painite.

**algodonite;** a silver white to steel gray, opaque, copper arsenate (Cu<sub>6</sub>As) with a hexagonal system. It's metallic luster, which quickly tarnishes on contact with air. SG:8.38. H:3-4. Found in Chile, the Czech Republic, Iran, and Michigan. Sometimes cut as cabochon. → Domeykite, mohawkite.

**alignment of facets;** → facet alignment.

**Alice Roosevelt Aquamarine;** same as Roosevelt Aquamarine, Alice.

**align properly;** in a triplet stone sometimes inclusions are seen in the crown which may are not similar to the inclusions of pavilion or do not align properly with it.

**alizarin;** an orange-red crystal natural and synthetic dyes C<sub>6</sub>H<sub>4</sub>(CO)<sub>2</sub>C<sub>6</sub>H<sub>2</sub>(OH)<sub>2</sub>. Soluble in aromatic solvent, hot methyl alcohol, ether and very less in water. Used as indicator and dyes.

**alizarin red;** an orange-red crystal natural and synthetic dyes. Soluble in aromatic solvent, hot methyl alcohol, ether and very less in water. Used as indicator and dyes.

**alizarin yellow;** a compound contain an azo group and the most important natural and synthetic dyes, prismatic or needle form aggregate, yellow brown powder. Soluble in water, used as indicator and dyes. Also called madder, turkey red, C.I. 75330, and C.I. natural red.

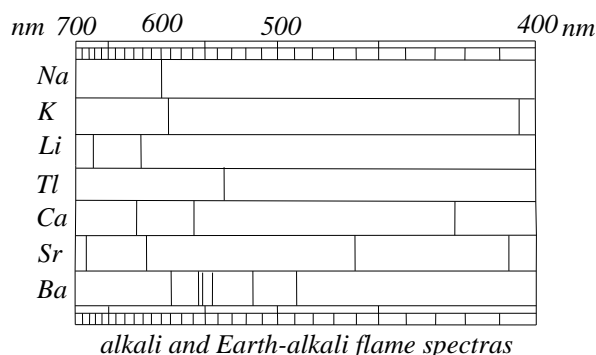
**alkali;** a substance, which dissolves in water to form an alkaline solution found in arid and semi-arid regions.

**alkali;** hydroxides of sodium (NaOH) and potassium (KOH) and lithium (LiOH) are known bases.

**alkali;** any bitter-tasting salt, composed of sodium or potassium carbonate

**alkali;** a general name for an alkali metal.

**alkali and earth metal spectrums;** spectrums of alkali and earth metal are seen below.



**alkalic;** a solution containing alkali cation. Igneous rocks with more alkali elements than average for their class, with less than 51% alkali-lime index.

**alkali earth metals;** the bivalent and strongly basic metal in group IIA of the Periodic System, comprising of beryllium, magnesium, calcium, strontium, barium, and radium. → Alkali and earth metal spectrums.

**alkali-etchants;** potassium hydroxide used for etching crystals, minerals, gemstone, etc. → Alkali.

**alkali feldspar;** an alkali-bearing feldspar such as orthoclase, microcline, albite, sanidine, adularia, and anorthoclase, which contains very little calcium.

**alkali garnet;** a term for a member of the sodalite group, closely related chemically and crystallographically to the garnets.

*alkali granite - allopheane*

**alkali granite;** an acidic, coarse-grained rock, containing free quartz, and characterized by a great excess of alkali-feldspar over plagioclase.

**alkali metals;** the monovalent metal in group IA of the Periodic System, namely, lithium, sodium, potassium, rubidium, cesium and francium.

**alkaline;** having the qualities of a base, synonym for basic.

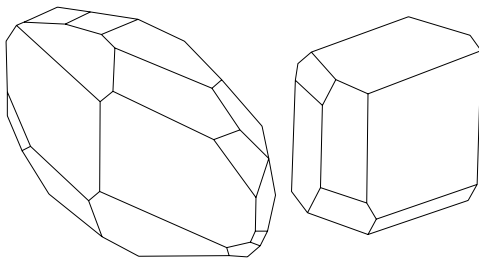
**alkaline;** substance which have PH greater than 7.

**alkaline earth;** the oxides of barium, strontium, calcium, beryllium, magnesium, and radium.

**alkalinity test of beryl;** alkaline reaction of moistened crushed of calcined beryl family on litmus paper while uncalcined beryl do not react.

**alkali spinel;** green, gray and black, isometric varieties of spinel, containing minute amounts of the alkalis, K<sub>2</sub>O and Na<sub>2</sub>O 1.31% and 1.38%. Found in northern Sweden.

**alladinite;** an artificial thermoplastic resin. Used to produce imitation gemstones.



*allanite or orthite crystals*

**allanite;** a cerium-bearing mineral of epidote group. Radioactive, it is of interest to gem collectors. Synonym for orthite.

System: monoclinic.

Formula:  $2[\text{Ca}, (\text{Ce}, \text{Th})_2(\text{Mg}, \text{Fe}^{+3}, \text{Fe}^{+2})\text{Al}_2(\text{O})\text{OH}|\text{SiO}_4|\text{Si}_2\text{O}_7]$ .

Luster: semimetallic to vitreous,

Colors: reddish, greenish, brown to black,

Streak: none or white.

Diaphaneity: Semitranslucent to opaque,

Cleavage: none.

Fracture: conchoidal to even. Brittle.

SG: 3.00- 4.20.

H: 5 -6.

Optics;  $\alpha$ :1.640-1.791,  $\beta$ :1.650-1.815,  $\gamma$ :1.659-1.828.

Birefringence: 0.013-0.036.  $\oplus$  may be also  $\ominus$ .

Dispersion: 0.019 similar to epidote.

From Saxony, New York, New Jersey, Norway, Finland, Ural and Sweden.

**allcharite;** same as goethite.

**Allende meteorite;** → heteronuclear intervalence charge transfer.

**allexite;** commercial term for synthetic alexandrite grown by the Czochralski technique, and made by Diamonair Company of Liton Airtron.

**Allmana Avensk, ElektriKA Aktiebolaget;** a Swedish corporation, which, since 1953 produces synthetic diamonds. Abbreviation: A.S.E.A.

**allocation;** a scope of rough diamonds, selected by the Central Selling Organization, for each sightholder.

**alochroite;** a calcium-chromium garnet, the light brown variety of andradite.

**alochromatic;** a term which refer to those gemstones or minerals, which in their purest state, are colorless but colored by a minor impurities of coloring agent added to their chemical composition of minerals. Opposite of idiochromatic. → Allochromatic minerals.

**alochromatic crystals;** → allochromatic minerals.

**alochromatic gems;** → allochromatic minerals.

**alochromatic minerals;** the term referring to minerals, which in their purest state are perfectly colorless or white. Because the major elements consisting minerals do not produce characteristic color, if the mineral is pure it will be colorless or white when transparent. By chance, these are colored by submicroscopic impurities, or inclusions, of other minerals. Generally a metallic oxide, which has no essential part in the chemical composition of a particular mineral, such as corundum, which when pure, is colorless (white sapphire). When it containing titanium oxide the result is a blue color (sapphire). A trace of chromium oxide yield a red (ruby), while iron gives green and yellow (green and yellow sapphire). The opposite is an idiochromatic mineral. Same as allochromatic gems or allochromatic crystals. → Idiochromatic stones.

**alochromatic transitional elements;** → transitional elements.

**alochthonous;** term meaning not formed or occurring in the place where it is found. Drifted, transported. Not *in situ*. → Autochthonous.

**aloclastic breccia;** a breccia formed by volcanic activity, composed of nonvolcanic rock in a volcanic matrix.

**allogene;** an allogenic mineral or rock is not formed on the spot, which is derived from pre-existing rocks and transported to the present spot such as a xenolith in an igneous rock or a detrital mineral in a placer deposit. Also called allothigenous, allothogenic or allothigenic. → Authigene.

**allomerism;** same as isomorphism.

**alломorph;** same as pseudomorph.

**alломorphism;** different crystalline forms of the same chemical composition.

**alломorphite;** barite mineral which is pseudomorphous after anhydrite.

**al-opal;** a term applied to formation rich in opal.

**al-opal;** an inferior type of jelly opal with almost transparent patch color.

**allopheane;** an amorphous clay mineral of Al<sub>2</sub>O<sub>3</sub>.SiO<sub>2</sub> or

hydrous aluminum silicate gel with various colors such as colorless, snow white, blue, green, brown, or yellow. Often occurs in incrustations and rarely as stalactitic masses.

**allophane**; → kandite.

**allothigenic**; → allogene.

**allothigenous**; → allogene.

**allothigenous ejectum**; same as exogenous inclusion.

**allothogenic**; → allogene.

**allotriomorphic**; → anhedral.

**allotriomorphic-granular**; same as xenolith-granular. → Anhedral.

**allotrope**; term meaning one of the different crystal forms of a particular substance that displays allotropism, such as diamond and graphite, which are both allotropes of carbon. → Polymorphism.

**allotropic**; the name applies to the phenomenon shown by some chemical compositions or elements, which exist in different metastable forms, over a given temperature range, such as carbon, which from which diamond, charcoal or graphite may be formed.

**allotropy, allotropism**; the capability of some substances to exist in more than one form, different characteristics at different temperatures. → Allotrope.

**alloy**; an intimate confusion of two or more metallic elements with nonmetallic elements, such as steel.

**alloy**; a mixture of two or more metallic elements such as bronze, which is an alloy comprised of copper and silver. Electrum is a naturally alloy. Alloys are produced to achieve other characteristic properties such as greater durability, strength, hardness, etc.

**alluvial**; pertaining to, or having the character of, alluvium; meaning deposited by the action of waves or of running water. Used for valuable minerals, such as gold, diamond, and ruby, which are associated with an alluvial placer, such a secondary deposit is known as an alluvial deposit. Synonym: alluvium. → Deposit.

**Alluvial**; an obsolete term for tertiary.

**alluvial cone**; a low, outspread, relatively flat to gently sloping mass of rock material, shaped like an open fan or segment of a cone, deposited by a stream. Also called debris cone, and dejection cone. → Alluvial fan.

**alluvial deposit**; unconsolidated, or loose, secondary deposits of valuable minerals, which have been deposited by rivers and are found in their dried-up beds. → Alluvium.

**alluvial diamond**; diamond found associated with waterworn material.

**alluvial diamond-bearing gravel**; loose particles of diamond, which have been brought down by rivers and are found in gravel.

**alluvial digging**; same as alluvial mining.

**alluvial fan**; a low, outspread, relatively flat to gently

sloping mass of rock material, shaped like an open fan or a segment of a cone, deposited by the action of a stream. Sometimes called prism. → Alluvial cone.

**alluvial gold**; gold fragment found associated with waterworn material.

**alluvial gold-digging**; a term applied to mining of diamond in placer.

**alluvial gold-gravel**; loose deposits of gold, which have been brought down by rivers, and are found in their dried-up beds.

**alluvial gravel**; loose deposits of valuable minerals, which have been brought down by rivers, and are found in their dried-up beds. Also called gem gravel. → Alluvium, alluvial deposit.

**alluvial laterite**; a white to cream to red residual clay produced in humid tropical and subtropical conditions of good drainage by the weathering of igneous rocks, usually of basic composition. Contains some silica, particularly of iron oxides and hydroxides and aluminum hydroxides. It is related to bauxite and found in alluvial deposit.

**alluvial mining**; the process of exploration of alluvial placers, or deposits, such as gold, gemstones, rare earths, platinum. Recovered by hydraulicking, by dredging or by shallow drifting and sometimes panning. Also called alluvial digging.

**alluvial ore**; loose particles of valuable minerals, which have been brought down by rivers and are found in their dried-up beds.

**alluvial placer**; concentration of valuable alluvial minerals such as gold, diamond, and ruby on the surface, chiefly of fluvial origin. Recovered by hydraulic washing, dredging, and sometimes panning. → Alluvial deposits, alluvial ore.

**alluvial quartz**; loose particles of quartz minerals, which have been brought down by rivers.

**alluvial sand** small fragment of detrital rock, which have been brought down by rivers. Mostly composed of quartz.

**alluvial sorting**; same as alluvial stone; for example alluvial diamond deposits in South Africa on the west coast of Namibia.

**alluvial stone**; natural sorting of gemstone or minerals which have been transported and deposited by streams.

**alluvial tin**; tin fragment found associated with waterworn material.

**alluvial values**; recoverable from mineralized alluvial beds such as gold, diamond, cassiterite, rutile, monazite, platinum and other gemstones.

**alluvion**; → alluvium.

**alluvium**; mixture of clay, silt, sand, gravel and other unconsolidated rock materials. Deposited during comparatively recent geologic time, by running or flowing water, as sorted and semisorted sediment, in

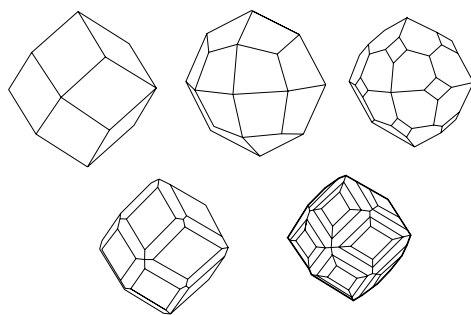
*almagra - alomite*

the bed of a stream or, on its flood plain. Known as alluvial deposits and alluvion. → Alluvial.

**almagra**; a dark red ocher from Andalusia, Spain, similar to Indian red. Used for polishing glass and metals, and as pigment.

**almagre**; red ocher from Mexico.

**almandine**; term applied to the iron-aluminum group of garnets, a red to purple gem quality, which occur in mica-schist, and other metamorphic rocks. Usually a hollow cabochon, cut to lighten the color, is known as a carbuncle. Sometimes this is seen as a weakly formed of four-pointed or six-pointed star can be seen. Such stones are known as star almandine. These four-rayed and 6-rayed star almandine occur due to fine needles inclusions. Almandine is practically opaque to X-rays.



*almandine crystals*

Sometimes the word almandine is used as a prefix, which is a misnomer, for example, almandine spinel, etc. or Cape garnet. Alabandite is an obsolete term. Also called almandite, noble garnet, precious garnet, oriental garnet. Also spelled almandine. → Garnet, almandine spinel.

System: cubic.

Formula:  $8[\text{Fe}_3\text{Al}_2(\text{SiO}_4)_3]$ .

Luster: vitreous to resinous.

Streak: white.

Colors: purplish to deep red, violet-red and black.

Diaphaneity: transparent.

Fracture: conchoidal to even. Brittle.

Cleavage: none.

SG: 3.80 - 4.20.

H: 7-7.

RI: 1.75-1.83.

Birefringence: none.

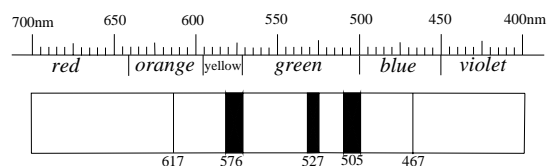
Dispersion: 0.024-0.027.

From many localities.

**almandine absorption spectrum**; the three main bands are due to ferrous iron, at 576 nm in yellow, 526 and 505 nm in green. A weak line is displayed at 617 nm in orange, and at 462 nm in blue.

**almandine cut**; → almandine.

**almandine garnet**; same as almandine.



*almandine absorption spectrum*

**almandine, inclusion in**; → inclusion in almandine garnet.

**almandine spinel**; a misnomer for the reddish-purple to purple red color of gem spinel. → Ruby spinel.

**almandite**; a misleading trade term for synthetic almandine spinel.

**almandite**; a mineralogical name for almandine

**almandite**; a misleading term for synthetic reddish to violet colored spinel.

**almandite ruby**; an incorrect name for reddish to violet spinel.

**almandite sapphire**; an incorrect name for bluish to violet spinel

**almashite**; a local, Rumanian name for the green or black amber from Almash, Moldavia, that is poor in oxygen. It shows fluorescence qualities.

**Almasi**; → Alamas Ltd.

**Almasi, Ltd.**; a small diamond-mining company in Tanzania, Africa. Also spelled Alamas or Alamas Ltd.

**almaz**; a term for uncut diamonds, in Russian or Slavic languages.

**Almaz Export**; the marketing agency of Russian diamonds, Almaz Rossii-Sakha. Under contract to De Beers, it sells rough diamonds, which are exported to the Central Selling Organization.

**Almaz Juvelier Export**; a Russian corporation, controls Russian diamonds and gemstones, located in Antwerp, Belgium.

**Almazni Fund**; one of the world's most famous museums of gems, diamonds, and jewelry, in the Kremlin, Moscow, Russia. → Russian Diamond fund.

**Almaz Rossii-Sakha**; meaning Diamonds, of Russia and Sakha. This diamond agency, which operates in Sakha (Yakutia) through Yakutalmaz. The production of rough material is marketed through, this agency's Almazexport subsidiary. Also known as Diamonds of Russia and Sakha.

**almeria ore**; a Spanish name for hematite.

**almond rock**; same as amygdaloid.

**almond-shaped cavity**; same as amygdaloidal cavity.

**almond stone**; a synonym for almandine garnet.

**alomite**; named after Charles Allom. A commercial term

for blue sodalite, from Bancroft, Canada. An ornamental stone, also called princess blue. Used for ornamental objects.

**alowitz;** trade name for fused aluminum oxide ( $\text{Al}_2\text{O}_3$ ).

**aloxite;** a commercial term for an abrasive material made of synthetically produced aluminum oxide, or artificial corundum ( $\text{Al}_2\text{O}_3$ ) powder.

**alpha amyrene;** a major part of resin obtained from species of angiosperms a kind of flowering trees.

**alpha chalcosite;** same as digenite.

**alpha decay;** spontaneous radioactive disintegration of an unstable atomic nuclei or change of one nuclide into one or more different isotopes by the emission of an atomic particle. Also called radioactive disintegration. → Alpha ray.

**alpha diamond;**  $\alpha$ -C, a stable, cubic diamond.

**alpha disintegration;** → alpha ray.

**alpha index;** the lowest index in biaxial minerals or gemstones.

**alpha irradiation;** the exposure of certain pale or poorly colored gemstones or diamonds to alpha rays, to enhance their color. → Alpha ray.

**alpha particle;** a positively charged particle emitted by certain radioactive materials during radioactive decay, which has two neutrons and two protons. Hence, it is identical with the nucleus of a helium atom. Also called  $\alpha$ -ray, alpha radiation.

**alpha particle treatment;** → cyclotron-treated diamonds, cyclotron diamonds.

**alpha quartz;** polymorphic quartz, stable below  $573^\circ\text{C}$ , which has formed in veins, geodes and large pegmatites. Its vertical axis has three-fold symmetry, and the three horizontal axes have two-fold symmetry. It has a higher refractive index and birefringence than that of beta quartz. Also called low quartz and spelled  $\alpha$ -quartz.

**alpha radiation;** → alpha ray.

**$\alpha$ -ray;** a less-preferred synonym for alpha particle. → Alpha ray.

**alpha ray;** a less-preferred synonym for alpha particle. Also spelled  $\alpha$ -ray, alpha particle, alpha radiation.

**alpha zircon;** in mineralogy an obsolete term for any high quality zircon. Optics;  $\omega$ :1.920-1.940,  $\varepsilon$ :1.970-2.010. Birefringence: 0.036-0.059.  $\oplus$ . Dispersion: 0.039. SG:4.67-4.70. Alpha zircon is the only type of zircon, which used in jewelry. Also called high zircon. → Low zircon, zircon.

**alpine cleft;** a name used for the cave features in the rock of European Alps where the rocks are folded and distorted by movement of the earth's crust, in which several fine minerals are found.

**alpine diamond;** an incorrect name for pyrite, from the Alps.

**alshedite;** a variety of titanite, or sphene, containing yttrium. Named after the parish of Alsheda in Sweden.

**alstonite;** synonym for bromilite. Not to be confused with bromellite

**alstonite;** a double carbonate composed of calcium and barium.

**alteration;** in mineralogy, the change in the chemical and mineralogical composition of a rock or mineral, since its original formation. It implies changes to new minerals or new rocks textures. → Altered rock.

**altered diamond;** same as treated diamond.

**altered mineral;** a mineral that has undergone some changes in its chemical and mineralogical composition to varying degrees.

**altered rock;** a rock that has undergone some chemical change under geological action.

**altered stone;** natural stones are frequently altered in a manner that may have an important bearing on their value. Any stone, of which the appearance, especially the color, has been changed by any artificial means, whatsoever. Such changes may be either external or internal.

**alternant system;** a term used for organic colorants with non-significant variants or allomorphs such as resonance of benzene. → Resonance.

**Alto Ligonha Beryl;** a pink and blue beryl crystals forming sometimes large aggregate until 200 tons are quarried found in Mozambique.

**Alton Noel;** an analyzing refractometer from Noel Alton. A refractometer employing the polarizing system to analyze the nature of the birefringence of gemstones.

**alum;** a hydrous, double sulfate of aluminum and potassium.

**alum;** in chemistry, any one of a group of salts, which are hydrous, double sulfates of aluminum, chromium, iron, or manganese, and one of the alkali metals.

**alum;** in Mineralogy a group of minerals consisting of hydrous, double sulfates of aluminum, chromium, iron, or manganese, and one of the alkali metals such as alum, kalinite, mendozite, soda alum and ammonalun (tschermigite).

**alunag;** a commercial term for colorless synthetic spinel, used as a diamond simulant.

**alumina;** an important constituent of aluminum oxide ( $\text{Al}_2\text{O}_3$ ) occurring as the minerals corundum and emery, and in hydrated forms, as bauxite

**alumina;** any silicate, in which aluminum oxide is an important part of the composition, such as feldspar, mica, feldspathoid, etc.

**alumina ceramic;** any ceramic white ware, in which aluminum oxide is the essential, crystalline part.

**aluminatchromite;** → Alumo-chrompicotite.

**aluminite**; any mineral or constituent of aluminum oxide.

**aluminium**; British spelling for aluminum.

**alunioelbaite**; a suggested name for elbaite-schorl mixture of tourmaline.

**alunobuergerite**; a suggested end-member of tourmaline.

**alunino-silicate**; same as aluminum silicate.

**aluminum**; a light, silver-white, ductile, malleable metal, with a high electrical conductivity and good resistance to corrosion. Its chemical symbol is Al. Used in jewelry, for costume jewelry and junk jewelry.

**aluminum as impurity in quartz**; the color of smoky quartz is probably caused by natural defect color centers produced by impurity of aluminum and irradiation. For producing smoky color in quartz is an unpaired electron necessary this will happen by trivalent aluminum ion replacing tetravalent silicon ion. This replacement needed an alkali element (monovalent) such as sodium ion or a hydrogen ion for electrical balance. During irradiation of such quartz with an impurity of aluminum one of a pair of electrons may be thrown off its position such as an oxygen ion adjacent to an aluminum. This action leaves the other electron unpaired which giving rise to a hole color center.

**aluminum enamel**; a porcelain enameled specifically composed with aluminum oxide.

**aluminum gold**; an alloy containing 22 % aluminum and 78 % gold, with a ruby red color. Its melting point is 1060° C.

**aluminum minerals**; minerals which contain aluminum oxide, such as alunite, andalusite, bauxite, corundum, cyanite, sillimanite, topaz, spinel, turquoise, amblygonite, etc.

**aluminum oxide**; a white or pink powder, of natural or synthetic corundum, used as a polish and abrasive also used in ceramic bodies. Also called alumina, diamantite, diamontine. Linde A. compound is a sapphire or ruby powder. Emery is an intimation mixture of alumina and magnetite, or hematite, bauxite, diaspor, and gibbsite.

**aluminum powder**; aluminum in the form of powder, is used as a pigment in paints, inks, etc., usually, after coating with a lubricant, to gain luster and leafy appearance.

**aluminum silicate**; a chemical compound, which containing varying proportions of silica and alumina, in some cases with water or hydroxyl, such as feldspar, mica, etc. Also called alunino-silicate.

**aluminum solders**; an alloy of gold, silver, copper, and zinc; used for soldering aluminum brass.

**aluminum spinel**; an isometric, synthetic crystal of aluminum spinel (Al<sub>3</sub>O<sub>4</sub>).

**alunoberezkite**; members of the spinel group, from chromite, with the composition (Mg,Fe)(Cr,Al)<sub>2</sub>O<sub>4</sub>. → Alunoberezkite.

**alunochromite**; members of the spinel group from magnesiochromite, with the composition (Mg, Fe)(Cr,Al)<sub>2</sub>O<sub>4</sub>. Synonym: alunochromite. → Alunoberezkite.

**alunocalcite**; a variety of opal, with alumina and lime impurities, from Australia.

**alunogel**; an amorphous, aluminum hydroxide of indefinite composition, forming the constituent of bauxite. Used as an abrasive.

**alun rock**; a basic hydrous, double sulfate of aluminum and potassium.

**alundum**; the registered, commercial term for an abrasive material made of synthetically produced aluminum oxide or artificial corundum (Al<sub>2</sub>O<sub>3</sub>) powder.

**alurgite**; a manganiferous, rich variety of mica or biotite of purple color.

**alveolar**; abalone pearl having a small cell-like or pitted surface, like of a honeycomb.

**alveolar structure**; a term used for some kind of abalone pearl of hollow nature without concentric nacreous layers like oriental pearl.

**alveolar structure**; same as honeycomb structure.

**Am**; a chemical symbol for the element americium.

**amakusa**; the Japanese equivalent of china stone.

**amalgam**; an alloy composed of mercury with one or more other metals. Used for gilding metals. Known as fire gilding, or mercury gilding.

**amalgam gilding**; → amalgam.

**amargosite**; a commercial term for bentonite.

**amarantsteen**; a rarely used Dutch term for aquamarine emerald.

**amarud**; French term for aquamarine emerald.

**Amarillo Starlight Diamond**; the diamond of 16.37 cts, found in 1975, at the crater of Diamonds State Park, Arkansas. Is named after Amarillo a town in Texas, USA.

**amarillo stone**; a term applied to figured chalcedony, from Texas.

**amaryl**; a commercial term for light green, synthetic corundum, named as such become similar to leaves of an amaryllis. In South Africa, named belladonna lily.

**amas**; a Japanese term for girls who dive to fish pearl oysters.

**amas**; a Middle Farsi or Pahlavi term for diamond.

**Amati Diamond**; a diamond weighing 31 cts, which once belonged to Mrs. N. Coffin (Maiden name was Amati), stolen in 1949.

**amatista**; Spanish pronunciation for amethyst.

**amatista mosquito**; Spanish name for mosquito amethyst.

**amatiite**; a manufactured of synthetic imitation of diamond, such as YAG in USA

**amatrice**; a commercial term for the concretions variety of variscite, found in the reddish, gray or brownish matrixes of chalcedony, or quartz, or both together. Frequently found with wardite, or/and variscite. SG:2.60. H:5-7. Also called amatrice, variscite quartz.

**amatrice**; a green, gem variety of variscite, cut as cabochon, with its surrounding matrix, from Utah. Also called Utah matrix.

**amatrice**; name applied to a mixture of variscite, with reddish or brownish quartz (or chalcedony) from Ely, Nevada. Cut cabochon. SG:2.60. H:5-7, and which found in Stockton, Utah, USA. Once called American matrix. Also called amatrice.

**amause**; another term for strass, a metaloxide, colored glass or enamel.

**amausite**; a fine, crystalline quartz, or devitrified glass. Also called petrosilex.

**amazonite**; a bright green, to blue-green, laminated variety of microcline-feldspar. An ornamental stone, cut en cabochon or used for tumbled gems. Synonym for amazon stone. → Perthite feldspar, antiperthite, bareketh.

System: triclinic.

Formula:  $4[\text{KAl}(\text{Si}_3\text{O}_8)]$ .

Luster: vitreous.

Streak: white.

Colors: light green to white-green.

Diaphaneity: semitransparent to opaque.

Fracture: uneven. Brittle.

SG: 2.56-2.58.

H: 6-6½.

Cleavage: 001 perfect, 010 perfect.

Optics:  $\alpha$ : 1.514-1.529,  $\beta$ : 1.518-1.533,  $\gamma$ : 1.521-1.539

Birefringence: 0.008-0.010.  $\ominus$ .

Dispersion: 0.012.

Found in Russia, Virginia, Pike's Peak, Colorado and other sources.

**amazonite cut**; cut en cabochon as ovals, and tumbled.

**amazonite jade**; a misleading term, applied to the bright green, laminated variety of microcline-feldspar. Sometimes referred to as Amazon jade, which is a misnomer.

**amazonite luminescence**; yellow-green under LWUV. Inert under SWUV. Under X-rays green.

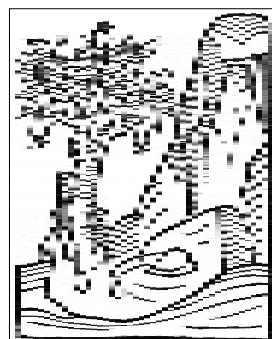
**amazonite rough**; rough material is obtained from Virginia, Colorado (USA), Ontario (Canada), South Africa, Norway and Finland.

**amazon jade**; a misleading term for amazonite jade.

**amazon stone**; same as amazonite, also written amazonstone.

**ambar**; a Spanish term applied to Amber. Also spelled ambeur.

**amber**; a Farsi (Persian) term for transparent, to translucent, to opaque fossil resin of hydrocarbons, from extinct varieties of certain pines, particularly the *Pinis succinifera* (succin mean sap or gum), which flourished in Oligocene times, more than 60 million years ago. Chemically amber is an isoprene unit ( $\text{C}_5\text{H}_8$ ) which is found in natural resins. Amber is warm to the touch, light in weight, and induces negative static electricity when rubbed. Sometimes in it embedded are remains some extinct insects, plants or other organic or inorganic material, from prehistoric times and or, *stress marks*, which resemble crackling. Opaque or cloudy amber can be clarified and change in color, when boiled in capable oils, such as colza oil or rape oil. After treatment frequently some crack-like marks resembling *nasturtium* leaves and are known as *sun spangled* can be seen can be seen. *Pressed* or *reconstructed*, amber is made by melting small fragments of the material and



*exuded  
amber drops  
from the tree.  
From Hortus  
1507*

compressing it into blocks by hydraulic pressure. Since Bronze age, it has been used as ornament and talisman cut cabochon, for beads, rosaries, and carved objects. Rarely is faceted. Sea amber occurs along certain shores, while pit amber (distinguished it from sea amber) is mined from Oligocene gravels in Myanmar (Burma) and Sicily. A variety is called muntenite from Rumania, and the variety gedanite from Poland, and Mexico. Imitations are made from kauri gum, copal, ambroid, glasses, and plastics. Amber can be distinguished from imitations by its lighter specific gravity and characteristic odor of pine, when heated or burned. Electrum was an obsolete ancient Greek term for amber. In northern of Europe amber was known as gles. Amber of Chinese is calling hu-p'o, meaning soul of tiger. → True amber, block amber, gedanite, burmite, rumanite, simetite, bastard amber, almashite, amberggris, kauri gum, copal.

System: amorphous.

Formula:  $\text{C}_{10}\text{H}_{16} + \text{H}_2\text{S}$ .

Luster: resinous.

Streak: white.

Colors: It is usually yellowish or brownish but may also be red, orange, black, whitish, greenish, bluish, or violetish or be stained

various colors. Red color caused by oxidation, rarely penetrates deep.

Diaphaneity: transparent, semitransparent to opaque. Cloudy variety is called bastard amber.

Fracture: uneven to conchoidal. Very brittle.

SG: 1.05-1.08.

H: 2-3.

Cleavage: none.

RI: 1.539-1.545.

Source: from southern shores of the Baltic Sea in Poland, shores of East Germany, Sicily, Mediterranean Sea of Sicily, Upper Myanmar (Burma), Canada, Mexico and Rumania.

**amber;** a term applied to orangey-yellow color opal, as in amber. Also called amber glass and amber opal.

**amber;** a term applied to any natural formed resin of amber from prehistoric trees which was similar in all regions have taken place in different epochs. Variation of amber is in present or absence of succinic acid. → Amber resins.

**amber acid;** same as succinic acid.

**amber against evil-eye and witchcraft;** amber was used as a safeguard for immortality and powerful protection against evil-eye and against witch craft such as amber heart, amber phallus and flat mound amber.

**amber aging;** artificially by heating at low temperature can be produce aging of amber.

**amber antique;** imitation beads made of celluloid resembling amber. Also called celluloid imitation amber.

**amber beach rider;** riders were sent out to prevent the loose ambers washed to the shore after storm.

**amber Beach Master;** a term was used in 14<sup>th</sup> centuries in Amberland for all collecting of amber which done under supervision of a Beach Master.

**amber bead;** a term used for beads made of amber color.

**amber bead;** a misleading term for beads made from coral of amber color.

**amber blood coagulation;** same as amber blood stilling.

**amber blood-stilling;** a believing of magical properties of amber is when a piece of amber placed on the nose it will stop or coagulated the excessive bleeding. Also called amber blood coagulation.

**amber boar;** a symbolic figure of goddess of Balts folks made of amber, a sacred animal of Celtic tribes of ancient Britain. Also called lucky pig amber.

**amber boron nitride;** same as borazon.

**amber burning glass;** a piece lens made of transparent amber in 16<sup>th</sup> centuries for providing fire.

**amber button;** a small lens-shaped button of Baltic amber with a perforated cone-shaped hole for attaching on the cloths of Neolithic Age. Sometimes is decorated with dots chiseled in lines and pits.

**amber,-care of;** for stringing of amber beads used silk or lined thread with knot between each beads. Amber pieces should not be stored with other gemstones or metal objects, but in soft velvet or flannel cloths or pouches. Do not bring amber in contact with hot water, soap, detergents, perfumes, kitchen substances, hairspray or ammoniac. For cleaning and removing dust wiped with soft flannel cloth moistures with clean lukewarm water. Stroked with clear olive oil, then cleaned with a soft cloth to remove excess the oil. → Stringing.

**amber catcher;** a device was made in Germany for prevent amber from being washed back to sea. Also called in German amber Kascher or amber Schöppen.

**amber,-classification of;** classification of amber is based on degrees of transparency and color shades. Generally, ambers are classified in two categories: (a) clear or transparent amber, (b) cloudy amber that is subdivided in several degrees such as semi-transparent to opaque.

**amber,-clear;** → clear amber.

**amber,-cloudy classification in trade;** → trade classification of cloudy amber.

**amber colophony;** same amber pitch.

**amber, comb-shaped;** a small comb-shaped piece made of Baltic amber wearing women and men as pendant may used as protection from 900-1200 A.D.

**Amber, Crown of;** a crown carve from a single piece of Baltic amber by Danzig Guild, which was presented to the King of Poland (ca. middle 1600).

**amber cuirasse;** same as amber pouch.

**Amber, Cup of;** a cup made of a single piece reddish-golden Baltic amber of Bronze Age. Found in a tomb in Dorchester with measures 6.2 cm high and 8.7 cm wide.

**amberdan;** (a Farsi or Persian name), tests indicate that this is not a true amber, but a suitably colored, synthetic plastic material, closely resembling true Baltic amber in appearance; produced in rectangular blocks.

**amber disc;** peculiar Baltic amber disc carved in ancient times in Sambia as symbol of sun-worship culture. Sometimes is decorated with dots chiseled in lines and pits.

**amber drop;** a name describing the usual drop shape in which amber occurs.

**amber doublet;** a composite material consisting of a piece of genuine amber used as a base, upon which is placed an insect, which is then covered with a material like copal resin.

**amber ear;** carved amber in form of ear or corn of fruit in Aquileia, Italy with the believing of magical properties.

**amber electrical properties;** amber electricity is strongly negative, attracting small pieces of paper or



straw when rubbed on fur or velvety.

**amber eyeglasses;** eyeglasses made of transparent amber in 16<sup>th</sup> centuries for spectacles.

**amber fish;** carved fish-shaped amber from Myanmar made in China because of believing of long life and good future during fifth century.

**amber fluorescence;** amber has blue, green, yellow, orange and frequently white fluorescence. Also called fluorescence of amber.

**amber forest;** a forest whose trees yielded the resin that fossilized into amber such as cedars, pines, palms, oaks, sequoia, redwoods, olives, chestnuts, camellias, cypress, magnolias, leguminous tree *Hymenaea*, cinnamon trees and *Thuja occidentales* (similar to white cedar or *Arbor vitae*).

**amber fruit;** carved amber in form of bunches of fruit corn or ear in Aquileia, Italy with the believing of magical properties.

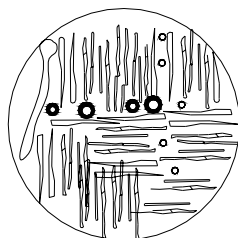
**amber glass;** → amber (opal).

**ambergris;** an opaque, grayish white, yellow or black waxy substance, with a strong odor, consisting mainly of cholesterol, found floating in tropical seas or washed ashore. It is a morbid secretion of the sperm whale *Physeter catodon*). Used in the manufacture of perfumes, but rarely in jewelry. Often popularly confused with amber. French amber jaune.

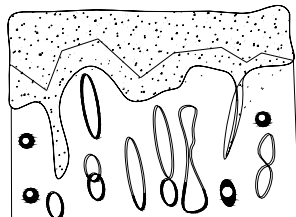
**amber heart;** carved amber in form of heart from Baltic folks because of believing of magical properties and protecting against the evil eye, witchcraft and keep their love free from harm.

**amber horse;** carved amber in form of horse or wild horse from Baltic area of Neolithic Age.

**amber, imitation;** transparent amber imitation made from kauri gum (formerly kauri pine), copal resin, ambroid, glasses, acrylic, styrene, celluloid, polyester



bubble inclusions in bemat resin



bubbles in different forms in imitation amber from synthetic resin

two different imitation ambers

resin, and plastics, which contains plant and or insect inclusions or sun-spangle fissures similar to naturally amber. → Imitation amber, plastics amber imitation.

**amber, imitation plastics;** same as plastics amber imitation.

**amber in astrology;** a believing of magical properties of amber from ancient till today which have relation to

celestial bodies were the bodies impart their power to amber such as of its golden color association with sign of Leo. Used as birthstone as amulet bringing good future and protect its wearer. Also, it is related to the name Anne.

**amber incense;** amber emitted a pleasant resinous odor of pine, because of this amber set out to fire as incense in temples in Middle and Far East.

**amber, inclusion in;** → inclusion in amber.

**amberine;** a local misleading commercial term for yellowish-green chalcedony or moss agate, from Death Valley, California, USA.

**amber in medicine;** was thought amber possess curative power therefore powdered amber was mixed with honey and oil of rose for curing ear problems or dimming eyesight. Amber powder or amber oil was used in medicine in Ancient Times. Powder of amber used for curing the stomach diseases. Amber oil resembling turpentine used against asthma and whooping cough. White powder of amber used in cordial medicine, which is known as Gascion's powder. As bezoar or bezoar stone used as mixed white powder as ingredient with other materials. Syrup of amber is mixture of succinic acid and opium was used in China as sedative, anodyne, etc. → Amber blood-stilling.

**amberite;** another term for ambrite.

**amber islands;** a term was used in Roman times perhaps for Frisian Island. Also was spelled Elektrides.

**amberita;** a term was used in Lithuanian and may other Baltic countries for amber.

**Amber Kascher;** same as amber catcher.

**amber lac;** a commercial term for amber pitch powder dissolved in turpentine or linseed oil. Also called amber varnish.

**amberland;** a term used to amber-bearing countries along the Baltic Seashore, Europe.

**amber lord;** a term was used in 15<sup>th</sup> century because the value of amber increased which became esteemed to made rosary beads and controlled whole marketing.

**amber mica;** same as phlogopite.

**amber morphology;** common forms of natural amber are drop-shaped and stalactites, which was exuded from prehistoric trees during of production of resins.

**amber mushroom;** carving amber in form of mushroom because believing of magical properties such as a symbol of fertility in Europe.

**amber name;** amber is a Farsi (Persian) term (not Arabic) derived from the ambar or anbar a name for ambergris in Farsi for anbar-mahi or anbar-fish same as whale with a curiously waxy excrement substance in form of lumps which was used in essences and perfumes industries.

**amber oath;** a swearing celebration was taking place

*amberoid - ambrite*

every third years in Samland for any fishermen to protect the state's interest for amber.

**amberoid**; another term for ambroid.

**amber oil**; a reddish-brownish oil, distilled from small pieces of amber. Also called oil of amber.

**amber opal**; a yellowish-brown variety of opal, similar to amber, stained by iron oxide. → Amber (opal).

**amber, phallus made of**; a symbol was used in northern Europe for powerful protection against evil eye and against witchcraft.

**amber pitch**; a residual product from the distillation process of the oil of amber.

**amber poking**; a term used for raking amber from the sea bottom with dragnets. Also in German called Bernsteinstechen.

**amber pouch**; a basket attached to the chest of amber fishermen for stowing amber. Also called amber cuirasse.

**amber resins**; there are more than 20 fossil amber resins, similar to succinite with different geological age, some of them are used as gem.

**amber resin trees**; → amber forest.

**amber rock**; a term applied to small granular of resin.

**Amber Room**; a room was made of amber in 18<sup>th</sup> century for Fredrick the Great was presented to Czar Alexander of Russia. Present whereabouts unknown, Russia? Also called Amber Chamber.

**amber salt**; same as succinic acid.

**Amber Schöppen**; Schöppen is German term for amber catcher.

**amber sorting, rough**; rough amber were sorted in three categories according to color, form and dimension: (I) large piece, flat and mostly cloudy with the name *tiles* and *plates*, used as smoking artifacts. (II) Round piece, opaque *tears*, frequently flattened bottom used to make smoking artifacts and gems. (III) Fine and clear pieces with the name *pouches* or shelly amber, some pieces contains organic remains inclusions such as insects, plants used for gems, museum specimens and other collectors.

**amber sorting, finished**; finished (cut and polished) articles of amber were sorted in four categories according to usage: (I) used as gem such as pendant, necklace, earring, finger ring, brooches, etc. (II) Make smoking artifacts such as cigar-holder, cigarette-holder, pipe, etc. (III) Artistic articles such as jewelry case, carving, cup, dish, inlay pattern, mosaic picture, ornamental pieces, etc. (IV) Different objects or articles such as sacred figures, rosaries, etc.

**amber striped sands**; another term for amber banded sands.

**amber talismanic**; a believing of protective and curative power of amber pieces such mouthpiece or mixed curing the stomach diseases, etc. → Amber

blood-stilling, amber in medicine.

**amber tear**; a name describing a shape in which amber occurs.

**amber topaz**; an amber colored topaz from Brazil with chatoyancy effect because of several parting parallel to the c-axis. → Topaz chatoyancy.

**amber treatment**; → amber.

**amber trees**; → amber forest.

**amber varnish**; same as amber lac.

**ambery**; another term for amber-like.

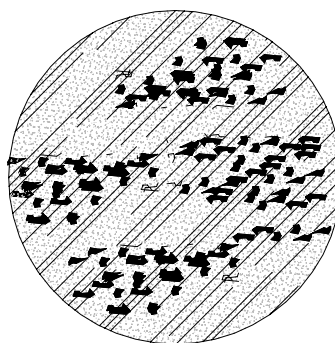
**ambetti**; a type of glass, containing small, opaque specks. Also spelled ambitty.

**ambeur**; a Spanish term applied to Amber.

**ambitty**; another term for ambetti.

**ambivalence**; simultaneous existence of double valences.

**amblygonite**; a natural, fluorophosphate, of aluminum



*quasi parallel  
crystal needles  
with cloudy  
inclusions in  
Brazil yellow  
amblygonite*

and lithium. Suitable for use as gemstone, faceted or cut cabochon. Sometimes called hebronite, montebrasite (OH exceeds F), natromontebrasite (Na exceeds Li).

System: triclinic.

Formula:  $4[(\text{Li},\text{Na})\text{Al}(\text{OH},\text{F})\text{PO}_4]$ .

Luster: vitreous to greasy, pearly on cleavage.

Streak: white.

Colors: white to grayish, colorless, yellowish, greenish and bluish.

Fracture: conchoidal to even. Brittle.

Diaphaneity: transparent to translucent.

Cleavage: 100 perfect, 110 good, {011} distincts.

SG: 3.12-3.03.

H: 5-6.

I.R;  $\alpha$ :1.591,  $\beta$ :1.605,  $\gamma$ :1.612 .

Birefringence: 0.020-0.022.  $\ominus$ . Montbrasite may be also  $\ominus$ .

Dispersion: 0.014-0.015.

Found in Black Hill, USA, Brazil and Africa.

**ambra**; Italian pronunciation for amber.

**ambre antique**; amber imitation from celluloids.

**ambre jaune**; → ambergris.

**ambre**; French pronunciation for amber.

**ambrite**; a yellowish-gray, subtransparent fossil resin of retinite or amber, occurring in large masses in several coal mines of New Zealand. Formula of  $\text{C}_{40}\text{H}_{66}\text{O}_5$ .

**ambroid**; a reconstructed amber, made by heating and compressing small flakes of poor quality genuine amber often with the inclusion of other resins at a high temperature of 180° C, pressure 100.000 pounds per square inch, air is excluded. May be artificially colored. Resembles natural amber in appearance and has similar physical properties. It is to be distinguished by embedded, elongated bubbles and visible fusion lines. Also called pressed amber, reconstructed amber. Also spelled amberoid, reconstructed amber.

**ambrosia**; a Greek term for immortality drink in cognate to amber.

**ambrosine**; a yellowish to brownish variety of amber found in the phosphate beds near Charleston.

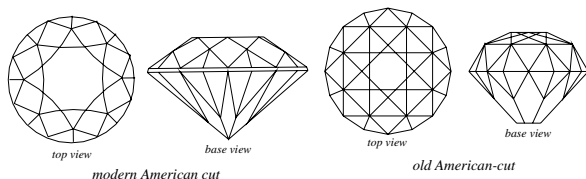
**amelan**; a term applied to a rock without colored minerals.

**Amelia Mine**; location of spessartite garnet in California, USA.

**amerhiste basaltine**; a misnomer for pale reddish violet beryl.

**American blue topaz**; → super American blue topaz, super blue topaz, Swiss blue topaz.

**American brilliant cut**; a modification of the brilliant cut diamond was devised in America in 1919 calculated by Tolkowsky, which achieved some popularity, in which the width of the table was reduced to about one third of width of the stone, and the height of the crown



compair of modern American-cut and old American-cut

is increased to be about two-thirds of the pavilion instead of one to two. Therefore total number of facets in the crown up to be 40, and 1 table. → American cut, Tolkowsky brilliant cut.

**American cut**; a modification of cutting round diamond brilliant, according to proportions and calculation by Marcel Tolkowsky, which provided the maximum brilliancy consistent with a high degree of fire. It was worked out by trial and error by master American cutters. Also called ideal cut. → American brilliant cut, Tolkowsky brilliant cut.

**American diamond**; a misleading term for synthetic cubic zirconia. Used as a fancy yellow diamond simulant.

**American Diamond Industry Association**; a trade organization funded in New York City. Abbreviation:

ADIA.

**American Diamond Mining Corp.**; a company that mines and sells the diamonds from Arkansas diamond deposits.

**American emerald**; a term used for Colombian emerald.

**American emerald**; a misleading term used in the past for Brazilian beryl or aquamarine.

**American Gem Society**; a non-profit professional organization of jewelers funded by Robert Shipley in 1934. Headquarters for this society are located at: 2960 Wilshire Boulevard, Los Angeles, California 90010, USA. Abbreviation of AGS.

**American Gemological Institute**; same as Gemological Institute of American. New Headquarters for this society are located at: the Robert Mouawad Campus, 5345 Armada Drive, Carlsbad, California 92008, USA. Abbreviation: GIA.

**American Golden Topaz**; a Light-yellow cut topaz of 4.58kg. Cut from a rough stone of 11.8kg. Found in 1970 ? Now on display at Smithsonian Museum, USA.

**American green jade**; a Chinese commercial term (Mei Kuo Lu) for a variety of light green jade, which because of its cheapness, became very popular with American tourists and exporters in China. The name was heard after World War I.

**American ideal cut**; same as American brilliant cut.

**American jade**; nephrite from Wyoming, USA.

**American jade**; a misleading term for massive green californite a jade-like variety of vesuvianite or idocrase.

**American jet**; jet found in Colorado and Utah, after polishing is full of cracks. Inferior to Whitby jet.

**American matrix**; → amatrix.

**American Museum of Natural History**; a famous museum contains large collections of human and its cultures in New York, USA.

**American pearl**; pearl fished from American shores

**American pearl**; a term, which refers to freshwater pearl of North America.

**American ruby**; a misleading term for red garnet (pyrope) from Arizona and New Mexico, USA

**American ruby**; a misleading term for rose quartz from Arizona and New Mexico.

**American setting**; an open (à jour) setting with a particularly high mount for diamond or other transparent gemstones.

**American System**; → A.G.S. color grading system.

**American turquoise**; a pale blue to bluish-green or greenish-blue turquoise from southwestern of States of America. Also known as Mexican turquoise. → Los Cerrillos turquoise.

**americium**; a transuranic element with the symbol Am. A long life  $\alpha$ -particle emitter, free of critical hazards

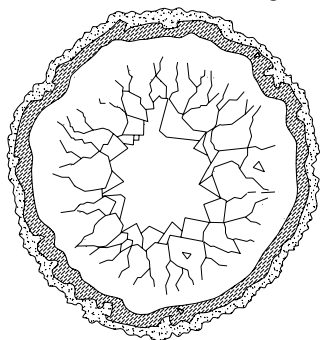
*ame-the* – *amethyst, color*

and  $\gamma$ -radiation.

**ame-the**; a Burmese term used for corundum stones of average 0.20 for five pieces. → Corundum classification in Myanmar.

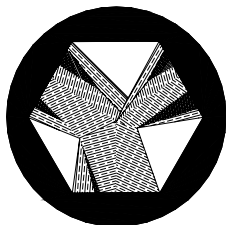
**amethyste basaltine**; a French misleading term for pale amethyst colored apatite.

**amethyst**; a pale violet to purple or violet, transparent variety of quartz, the color being due to present of  $\text{Fe}^{+2}$  or  $\text{Fe}^{+3}$  and traces of manganese, owing to irregular



*amethyst geod  
surrounded by  
chalcedony rings.*  
After Sinkankas 1967

color zoning. Pale lilac shades of amethyst are known as *rose of France*, reddish-violet as *Uruguayan stone*, and reddish-mauve as *Siberian stone*. When amethysts are heated or irradiated the color changes to light yellow to dark yellow, which is frequently is misnomered as citrine. Amethyst containing  $\text{Fe}^{+3}$  before irradiation changes to yellow, when contain  $\text{Fe}^{+2}$  the color turns green, which is called *prasiolite*. When the stone is heated to 350-400° obtains a parti-color of amethyst-citrine known as *ametrine*. It is dichroic blue violet for ordinary ray and reddish-violet for extraordinary ray. Stones from Brazil turns to green. It occurs lining vugh or in cavities. Synthetic amethyst is



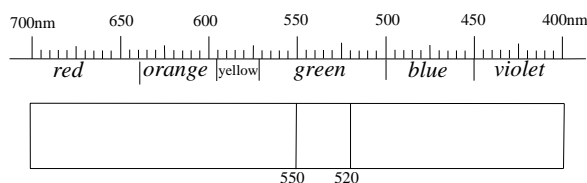
*cross section through amethyst-crystal  
perpendicular to c-axis under  
microscope by crossed-Nicol*

made from colorless synthetic quartz, when the iron-rich crystals are irradiated by gamma rays. Mostly imitation amethyst is made from glasses, synthetic corundum, which is incorrectly named as *amethyst*. Used as a gemstone, cut as beads, pendants and those with goethite or other needle inclusions shows cat's-eye effect, when cut cabochon. Found in Siberia, Brazil, Uruguay and other sources. Also called soldier's stone, bishop's stone, violet quartz.

**amethyst**; a color designation, same as amethystine.

**amethyst**; a misleading term for synthetic purple sapphire.

**amethyst absorption spectrum**; absorption spectrum of amethyst is not distinctive but two in the yellow-



*absorption spectrum of amethyst*

green seen at 520 and 550 nm.

**amethyst basaltine**; a German misleading term for pale amethyst colored apatite.

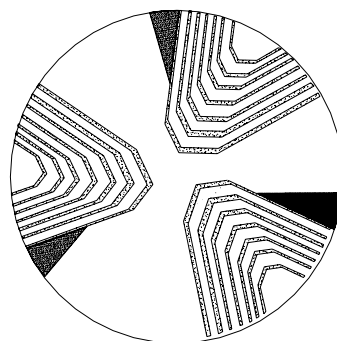
**amethyst basaltine**; a misleading term for pale amethyst colored apatite.

**amethyst basanite**; a pale yellow reddish beryl.

**amethyst basanite**; a color designation meaning violet or purplish.

**amethyst-citrine**; a rock crystal containing both minerals with both colors. Also called *ametrine* or *trystine*. Heat treatment of amethyst can produce similarly stone.

**amethyst, color interference of**; frequently color interference bands caused due to twinning can be seen in naturally quartz or amethyst by using of thins section



*colored interference  
bands seen in  
natural quartz or  
amethyst due to  
twinning through in  
the direction of  
optic axis by  
crossed Nicols*

and crossed Nicols under microscope.

**amethyst, color of**; a pale violet to purple or violet, transparent variety of quartz. The color being due to present of  $\text{Fe}^{+2}$  or  $\text{Fe}^{+3}$  and traces of manganese, owing to irregular color zoning. When amethysts are heated to 350-400°C under reducing conditions or irradiated the color changes to light yellow to dark yellow, which is frequently is misnomered as citrine. Amethyst containing  $\text{Fe}^{+3}$  before irradiation changes to yellow, when contain  $\text{Fe}^{+2}$  the color turns green, which is called *prasiolite* or *greened amethyst*. When the stone is heated to 350-400° C obtains a parti-color of amethyst-

citrine known as *ametrine*.

**amethyst cut;** cut as faceted gemstones in various sizes, cabochon, or are tumbled.

**amethyst imitation;** a violet barium-glass. SG: 2.80. RI: 1.542.

**amethyst inclusions;** → inclusion in amethyst.

**amethystine;** a variety of quartz or glass with patchy amethyst coloring.

**amethystine chalcedony;** light violet to gray-purple variety of amethyst-chalcedony from Arizona, USA, which is commercially known as *damsonite*. → Chalcedony.

**amethystine quartz;** a massive quartz with patchy amethyst coloring.

**amethystine sapphire;** same as violet to purplish sapphire.

**amethystizants;** the fiery red hue passes at the edges into amethyst violet color.

**amethyst, name of;** the term is derived from the Greek name *amethystos* meaning not drunken refer to a supposed power to mitigate alcoholic excess. In Farsi (Persian) gemast (not drunken).

**amethyst quartz;** a commercial term to designate badly cabochon fashioned from amethyst quartz, especially those from amethystine quartz

**amethyst quartz;** a variety of banded amethyst, in which milky quartz or agate is included.

**amethyst lithia;** a misnomer for lilac spodumene.

**amethyst oriental;** a misnomer for violet corundum.

**amethyst point;** hexagonal amethyst crystal from an amygdaloidal geode.

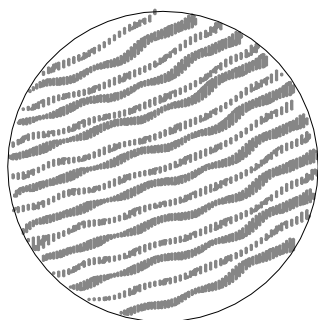
**amethyst quartz;** a variety of banded amethyst, in which milky quartz or agate is included.

**amethyst quartz;** a commercial term to designate badly cabochon fashioned from amethyst quartz, especially those from amethystine quartz.

**amethyst, synthetic;** → synthetic amethyst.

**Amethystus;** sixth stone at Jewish High Priest Breastplate. → Breastplate.

**amethyst, zebra stripes in;** a typical liquid-filled ducts



*zebra or tiger stripes in amethyst*

inclusion in parallel arrangement with a structure appear as striations similar to zebra or tiger stripes,

### *amethyst cut - ammonite*

which may occur due to some kind of growth disturbance or pressure may caused internal shearing.

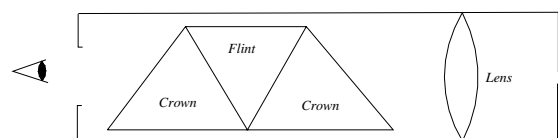
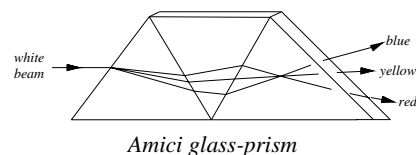
**ametrine;** a combined term used for violet and yellow striped amethyst-citrine, which grows together, found only in Anahi Mine, Bolivian. Used as a gemstone.

**amherst stone;** → blue stone.

**amianthus;** ancient name for long, fine silky fibered variety of asbestos such as chrysotile.

**amiantoid;** an olive-green, coarse fibrous variety of asbestos.

**Amici glass-prism;** a lens system that is integral in some direct-vision spectroscopes consisting of two or



*an Amici compound prism in a spectroscope*

three or more layers of glass of differing refractive indices to give zero deviation at yellow wavelengths. The lens in the middle of the system is from lead glass (flint) and both of the end are potassium-glass (crown glass). This lens system is arranged to give dispersion without deviation of the yellow color.

**amicroscopic structure flaw;** deviation from an ideal crystal lattice in unit of  $10^{-7}$  to  $4 \times 10^{-7}$  cm

**AMICUT;** → Diaminir, Ltd.

**amino group;** the radical (NH<sub>2</sub>)- in organic chemistry.

**aminobenzene;** same as aniline.

**aminoplastics resin;** the name applied to the urea and thiourea or melamine in formaldehyde condensation products. They are synthetic resins of the *bakelite* type. Dyed and used as gemstone imitation. RI:1.55-1.62. SG:1.50. H:2. Transparent to translucent.

**Amiti Diamond;** a stolen diamond of 31 cts, was owned by Mrs. N. Coffin, her girl's name was Amiti from Bedford, Massachusetts, USA.

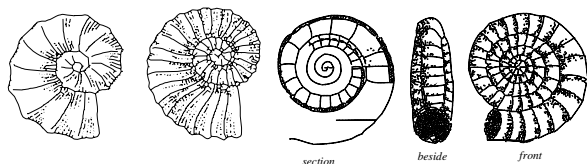
**ammolite;** a term used for doublet made from lumachelle, a fossiliferous fire marble usually ammonites or baculites. → Ammonite.

**ammonalaun;** a mineral of alum group with chemical formula:  $\text{NaH}_4\text{Al}(\text{SO}_4)_2 \cdot 12\text{H}_2\text{O}$ . Also called tschermigite.

**ammonite;** an iridescent gem material derived from aragonite-nacreous layer of ammonite fossils. The polished surface shows closely patches with play-of-color similar to that of black opal. Worn as brooch or pendant. Found in Alberta, Canada. Sometimes it is

impregnated in plastic to prevent damage and marketed as *korite*. → *Korite*, fire marble, lumachelle

**ammonite**; an explosive substance, which contains 70-



three ammonite forms from Trias, Cretaceous and Jurassic

95% ammonium nitrate.

**amorphism**; the state or quality of being amorphous, such as absence of crystalline structure.

**amorphous**; a term applied to minerals or gem materials, which have no definite internal arrangement of the atoms or molecules, and hence no external crystal form. Sometimes its properties are the same in all directions such as amber and glass. The term exclude the existence of any degree of order. Non-crystalline. → Crystalline.

**amorphous**; a term formerly used to describe rock occurring in a continuous mass, which is not divided into parts.

**amorphous mineral**; a mineral with no definite crystalline structure.

**amorphous zircon**; zircon, which has suffered a breakdown from crystalline form to an amorphous zircon. Common in minerals containing radioactive elements. The name applied to the low zircon, which has decomposed into nearly amorphous  $\text{SiO}_2$  and  $\text{ZrO}_2$  from the normally full crystalline zircon mineral. Also called metamicts.

**amosite**; an iron rich anthophyllite a variety of asbestos in yellow color from Transvaal, South Africa.

**amourant**; a commercial term for doublet or composite stone made of synthetic white sapphire top and strontium titanate on the bottom.

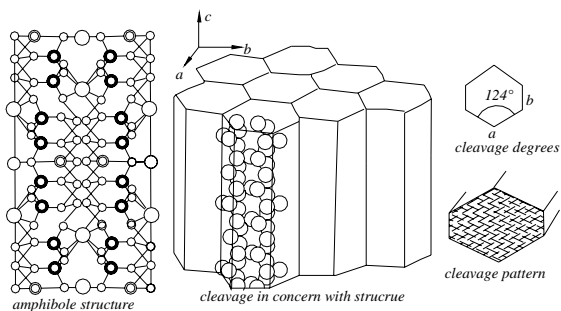
**ampangabeite**; same as samarskite.

**ampelite**; an old and obsolete term for shale containing bituminous carbonaceous

**ampelite**; another term for cannel coal, carbonaceous schist.

**amphibole**; the name applied to a dark colored group of ferromagnesium silicate minerals whose physical and chemical characters serve to link them together in one family of inosilicates with double chains and chemical formula of  $\text{A}_2\text{B}_5(\text{Si},\text{Al})_8\text{O}_{22}(\text{OH})_2$ . Where  $\text{A}=\text{Mg}, \text{Fe}^{+2}, \text{Ca}, \text{or Na}$ , and  $\text{B}=\text{Mg}, \text{Fe}^{+2}, \text{Fe}^{+3} \text{ or Al}$ . They are silicates of magnesium, iron, calcium, sodium and

sometimes potassium. The minerals are characterized by prismatic columnar or fibrous crystals. Hornblende,



amphibole structure and cleavage

asbestos, and nephrite are essential amphibole minerals. Crocidolite is a blue member of asbestos amphibole mineral, which changed by oxidation to a fine golden-brown, is known as *tiger's-eye* or *tiger-eye*. Occasionally has been silicified (pseudomorph) without alteration of the blue color, it is known as *sapphire-quartz*, *azure-quartz*, *siderite*, or *hawk's-eye* or *falcon's-eye*.

**amphibole**; a mineral of the amphibole group such as hornblende, actinolite, anthophyllite, cummingtonite, arfvedsonite, rebeckite, tremolite, glaucophane. Also called amphibole group.

**amphibole group**; same as amphibole.

**amphibolid**; → amphibolite.

**amphibolite**; a crystalline, coarse-grained rock, consisting of amphiboles, those from Malawi, South East Africa. Contain corundums and sapphires. Also called amphibolid, amphibololite.

**amphibololite**; → amphibolite.

**amphigene**; same as leucite.

**amphisilene shale**; a polishing slate with menilite concretions and imprints of amphisile fishes from Eocene Age. Used as decoration.

**amphoteric**; having both function as either a base or an acid.

**amplitude**; the maximum displacement from its main position in connection with vibration.

**ampullar pearl**; natural pearl formed in the shape of an ampullar or epidermis of the oyster, which is distinguished from cyst pearl and muscle pearl.

**Amsterdam**; very important diamond-cutting center in the Netherlands.

**Amsterdam Black Diamond**; a pear-shaped diamond of 33.74 cts, was cut from an opaque, rough stone weighing 55.85 cts. It was exhibit at 700th anniversary celebration of the city Amsterdam in 1975. Also called Amsterdam Diamond.

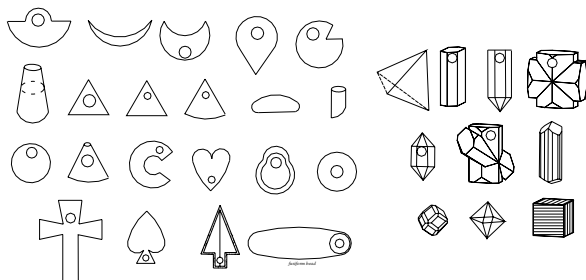
**Amsterdam brilliant cut**; → Amsterdam cut.

**Amsterdam cut**; a brilliant cut same as European cut. Synonym: Amsterdam brilliant cut.

**Amsterdam Diamond;** same as Amsterdam Black Diamond

**Amsterdam rose;** same as Holland rose.

**amulet;** a charm, or talisman such as brooch, bracelet, finger ring, or gemstone worn by a superstitious person to prevent disease or misfortune and to ward off evil. Gems are so worn and may have been before man used them for adornment. Some amulets were made in the form of boxes, cases or of carved animals and pendants.



*some modern amulets cut or rough from crystals*

In China, the examples were made of jade, in Egypt of glass. Believed that talisman has more and wider positive power than amulet. → Abraxas, talisman.

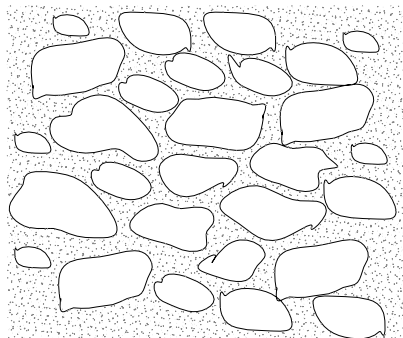
**amulet case;** a small hollow container in form of cylinder or other shape of gold or silver usually set with gemstones, in which was kept an amulet.

**amulet scarab;** carved scarab mostly from gemstones may be worn as a protective amulet or talisman, usually the scarab is invested with powder and at bottom is engraved image of Holy Isis. Used as brooch, bracelet, finger ring, and pendant.

**amygdale;** → amygdule.

**amygdaloid geode;** → amygdaloidal.

**amygdaloid;** any vesicular or cellular igneous rock, in which the vesicles have been filled partly or completely with secondary minerals such as calcite, quartz,



*amygdale aggregate*

epidote, zeolite, native copper and etc.

**amygdaloid;** an almond-shaped and sometimes engraved gemstone.

**amygdaloidal;** containing amygdules. Like or pertaining to an amygdaloid, or a geode, this has formed in an

### *Amsterdam Diamond - analcime*

amygdaloid. Also called amygdaloid geode.

**amygdaloidal diabase;** diamonds from Africa have reportedly been found in a fine-textured, dark-gray to black igneous rock of medium silica content, which was formed by rapid cooling and contain minute vesicular or cellular.

**amygdaloid geode;** same as amygdaloidal.

**amygdaloidal cavity;** an elongated, almond-shaped cavity. Also called almond-shaped cavity.

**amygdaloidal marble;** a misleading term for gray-green, dark red or mixed color flattened almond-like shaped marble pebbles.

**amygdule;** a round, small or almond-shaped cavity or vesicle in volcanic rocks or lava, which later filled partly or completely with secondary minerals such as calcite, quartz, chalcedony, epidote, set as beads and engraved gems

**amygdule;** pebbzeolite, or native copper, etc. Also spelled amygdale. Ules, which consist of agates.

**amyl acetate;** an organic, colorless, flammable, pear-like odor liquid having formula of  $\text{CH}_3\text{-COOC}_5\text{H}_{11}$ . RI:1.37. SG:0.862-0.866. Dilute with water, alcohol, and ether. The liquid is useful as a test for cellulosic plastics, which soften under its influence. Also called pear oil and isoamyl acetate.

**Anabar River;** an alluvial diamond mining north of Mirnyi of Sakha, Yakutia, the Russian Federation, CIS.

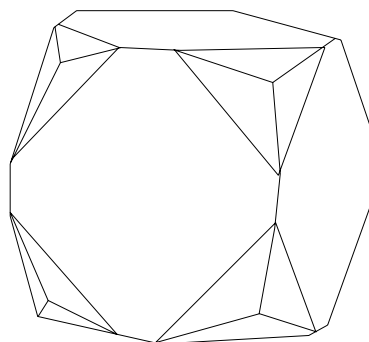
**Anacreon Emerald;** among Hope Collection was an emerald of 16 x 14 mm engraved an owl with a human face. Now on display at Townshed Collection of the Victorian Albert Museum, London.

**anacona ruby;** a misleading term for rose quartz.

**anaglyph;** same as cameo.

**Anakie sapphire;** a prolific gem district of about 20 square miles near Anakie, Queensland, Australia. The sapphire from here are dark blue, often green, frequently yellow, purplish or pink. → Queensland sapphire.

**analcime;** a white or slightly colored zeolite. A



*analcime crystal*

collector's mineral and faceted as a gem. Also called analcite.

System: cubic.

*analcite - andalusite*

Formula:  $16[\text{NaAlSi}_2\text{O}_6 \cdot \text{H}_2\text{O}]$ .

Luster: vitreous to greasy.

Colors: white to grayish, colorless, yellowish, pink and greenish.

Streak: white.

Diaphaneity: transparent to translucent.

Cleavage: 001 indistinct.

Fracture: subconchoidal. Brittle.

SG: 2.22-2.29.

H: 5-5.

RI: 1.479-1.493.

Found in all countries.

**analcite**; another term for analcime.

**analogous pole**; a term used in crystallography for negative end of the *c*-axis with polar symmetry.

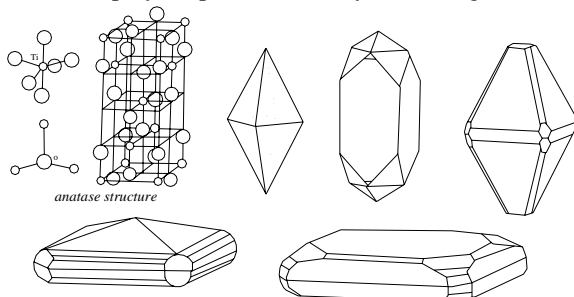
**analyzer**; same as a Nicol prism or polarizer disc, which transmits only plane polarized light, is placed above the objective in a polarizing microscope. → Polariscope.

**analyzer quartz-lamp**; a quartz lamp used to measure the luminescence of gems under ultraviolet ray.

**anamesite**; an obsolete term for fine-grained basaltic rock, which has a texture between fine-grained basalt and coarse-grained dolerite. Used as cladding material.

**Ananda**; a Chinese term used for Buddha figure carved on jade as Teacher and discipline. → Chinese ritual and symbol jades.

**anatase**; a rare transparent to opaque mineral. One of the three polymorphous naturally occurring form of



*anatase structure and crystals*

crystalline titanium oxide: rutile, and brookite. Cut into cabochon or faceted gemstones and prized by collectors. Synonym: octahedrite and oisanite.

System: tetragonal.

Formula:  $4[\text{TiO}_2]$ .

Luster: adamantine to metallic-adamantine.

Colors: various shades of brown to deep blue or black, green and pale lavender.

Diaphaneity: transparent to nearly opaque.

Fracture: subconchoidal. Brittle.

Streak: colorless to pale yellow.

Cleavage: {011} perfect, {001} perfect.

SG: 3.28-3.97.

H: 5 -6.

Optics;  $\epsilon$ : 2.493,  $\omega$ : 2.554 .

Birefringence: 0.061.  $\ominus$ .

Dispersion: strong.

Found in Brazil, France, Austria, Switzerland, Russia, Colorado (USA), and other countries.

**anatasia**; Spanish term for anatase.

**anatexis**; the partial or incomplete melting of a pre-existing rock due to increasing of temperature at constant pressure such as formation of basalt due to partially melting of peridotite.

**anbardan**; a Farsi (Persian) name, which means amberbox. In Iran used for a box in which amber is deposited. → Amber.

**ancillary**; gems or minerals colored by iron.

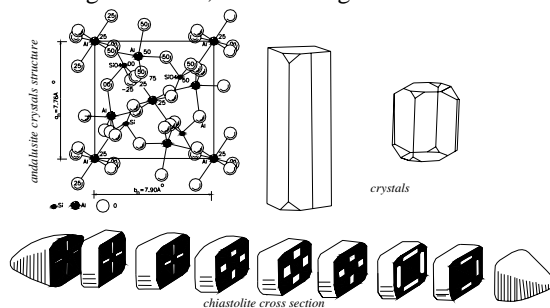
**ancillary test**; a test to appoint the gemstones, which will be treated.

**anatherie pearl**; → anitari pearl.

**anatherie**; same as anitari. Sri Lankaese commercial term for slightly lower quality of pearl than ani.

**Ancona ruby**; a local misleading term for a reddish or brownish quartz (rose quartz), colored by iron from Ancona, Italy. → Rubasse.

**andalusite**; it is trimorph with kyanite and sillimanite. It is strong dichroic, resembling alexandrite. Some



*structure and crystals of analusite*

specimens show chatoyancy, when cut cabochon because of streaky inclusions. Cut as faceted gems, when translucent. Variety known as chiastolite, which exhibits cruciform pattern of carbonaceous impurities, when viewed in cross section. Also called viridine and sometimes named as hard spar.

System: orthorhombic.

Formula:  $4[\text{Al}_2\text{SiO}_5]$ .

Luster: vitreous to subvitreous.

Colors: usually pink, reddish-brown, rose red, rose whitish, grayish, yellowish-white, violet.

Streak: white, colorless.

Diaphaneity: transparent to nearly opaque.

Fracture: uneven to subconchoidal. Brittle.

Cleavage: {110} distinct, {11-0} vary, {100} indistinct.

SG: 3.13-3.16 .

H: 6-7. (chiastolite 3 - 4).

Optics;  $\alpha$ : 1.629-1.640,  $\beta$ : 1.633-1.644,  $\chi$ : 1.638-1.650.

Birefringence: 0.007 - 0.013.  $\ominus$ .

Dispersion: 0.016.

Source: Brazil, Canada, Andalusia (Spain), Sri Lanka,



France, Chile, Myanmar (Burma), Australia, Bolivia, USA, and Russia.

**andalusite**; a commercial misleading term for brown variety of tourmaline.

**andalusite absorption spectrum**; deep green andalusite from Brazil has absorption spectrums at 553.5, 550.5, 547.5, 518, 495, and 455 nm for manganese and a narrow band at 436 nm in Sri Lanka samples.

**andalusite pleochroism**; frequently strongly pleochroitic, resembling alexandrite with a brownish-red, brownish-orange and brownish-green to yellow-green.

**Andamooka**; location of opal mining area in Australia.

**Andamooka matrix**; a pale colored matrix, which frequently can be appeared similar to a black opal.

**Andamooka Opal**; a brilliant fire, oval cabochon cut white opal of 203 cts. It was cut from a rough stone of 850 cts, (170 grams). Found in 1949 at Andamooka, South Australia. Was presented in 1954 to Queen Elizabeth II of England. Now it is mounted in a necklet with 180 diamonds and 2 other opals. Some gray to creamy colored inferior quality opals from Andamooka are artificially dyed black.

**Andelibi**; a term used in Nishabur turquoise mine for milky stone but lesser than Soliemani. → Turquoise classification in Nishabur, Iran.

**Anderson liquid**; same as Anderson-Payne refractometer.

**Anderson and Payne liquid**; a standard contact liquid composed of sulfur and di-iodoform (C<sub>2</sub>I<sub>4</sub>) with the high refraction RI:1.81. Solved in methylene-iodide.

**Anderson-Payne refractometer**; a special model, which the prism incorporating synthetic spinel, blend and diamond.

**Andes crown**; →crown of the Andes.

**Andes diorite**; a quartziferous diorite from Argentine Andes containing augite as principal mafic mineral. Frequently used as decorative or cladding stone.

**andesine**; a member of plagioclase feldspar group with the composition ranging Ab<sub>70</sub>An<sub>30</sub> to Ab<sub>50</sub>An<sub>50</sub>. Also called pseudo-albite. Frequently cut into cabochon.

System: triclinic.

Formula: 4[NaAlSi<sub>3</sub>O<sub>8</sub>. with nCaAl<sub>2</sub>Si<sub>2</sub>O<sub>8</sub>].

Luster: vitreous to resinous.

Colors: colorless, white, gray sometimes jade-green.

Streak: white.

Diaphaneity: transparent to opaque.

Fracture: uneven. Brittle.

SG: 2.66-2.68.

H: 6-6.

Optics; α: 1.543, β: 1.476-1.548, γ: 1.551.

Birefringence: 0.008. ⊕ or ⊖.

Source: California, Utah, and Colorado (USA), Greenland, Norway, France, Italy, India, and south

Africa.

**andesine jade**; a misleading term for jade-green andesine.

**andesinite**; a coarse-grained, phenocrystalline igneous rock composed primarily andesine. Frequently used as decorative or cladding stone.

**andesite**; a fine-grained, dark-colored, igneous extrusive rock composed chiefly of andesine and some mafic minerals. Frequently used as decorative or cladding stone.

**andesite glass**; an natural andesitic glass. Frequently used as a gemstone.

**Andhra Pradesh diamonds**; Andhra Pradesh is a state in Central India with some diamond locations: Golconda, Wajrakarur, Krishna River. City of Hyderabad is capital of the Andhra Pradesh State.

**Andrada Mine**; an alluvial diamond-bearing deposit in northeastern Angola, Africa.

**andradite garnet**; a mineral of garnet group, which includes the varieties demantoid, a brilliant green and topazolite in yellow to pale green. All garnet minerals are *birthstones* for January. The stone once was named as *allochroite*. Also called *andradite*. Other varieties, of which are: titanium-rich *melanite* in black, bright green variety is known as *demantoid*. *Topazolite* is a misleading term for transparent yellow, greenish-yellow variety of andradite, pyreneite, schorlomite, aplome and bredbergite. *Succinite garnet* is a pale yellow amber-colored variety of andradite.

System: cubic.

Formula: 8[Ca<sub>3</sub>Fe<sub>2</sub>(SiO<sub>4</sub>)<sub>3</sub>].

Luster: vitreous to resinous.

Colors: green, yellowish-green, yellow, gray-green or black.

Streak: white.

Diaphaneity: transparent to opaque.

Fracture: uneven. Brittle.

Cleavage: not determined.

SG: 3.81 - 3.87.

H: 6 - 7 .

RI: 1.856-1.895 .

Birefringence: none.

Dispersion: 0.057.

Source: Garnet Hill, Calaveras County, San Benito, Arkansas (USA), Cornwall (England), Piemont (Italy), Greenland, Norway, Sweden, Switzerland, Romania, Russia and Uganda.

**andradite absorption spectrum**; a strong line at 443 nm, sometimes when demantoid contains Cr at 701, 693, 640 and 622 nm.

**andradite cut**; cut en cabochon

**andrewsite**; a bluish-green mineral with the chemical composition of (Cu,Fe<sup>+2</sup>)Fe<sup>+3</sup>(PO<sub>4</sub>)<sub>3</sub>(OH)<sub>2</sub>. SG:3.475. H:4. Optics; α: 1.813, β: 1.820, γ: 1.830. Birefringence: 0.017. ⊕ . Luster silky. Found in Cornwall, England. It

is a mineral with associated turquoise and rashleighite.

**angel skin;** same as angel's skin coral.

**angel's skin coral;** same as pelle d'angelo.

**angelite;** a term applied to anhydrite of bluish gray color.

**Angelo pearl;** a new or recent imitation pearl consisting of mother-of-pearl beads and covered with layers of essence d'orient or plastics.

**angle;** any shape formed by two meeting planes or lines, commonly measured in degrees or radians.

**angle cutter;** same as angular cutter.

**angle of contact;** → contact angle.

**angles of crystal;** the interfacial angles by convention the angles between the normals of two crystallographic faces and not the outside angle formed by them.

**angle of deviation;** → deviation method.

**angle of extinction;** when a thin section of an anisotropic crystal is revolved between crossed Nicols in a polarizing microscope the light does not transmit, when the mineral planes of vibration are parallel to a Nicol plane.

**angle of faces;** in crystallography, interfacial angles are determined from angles between two normals.

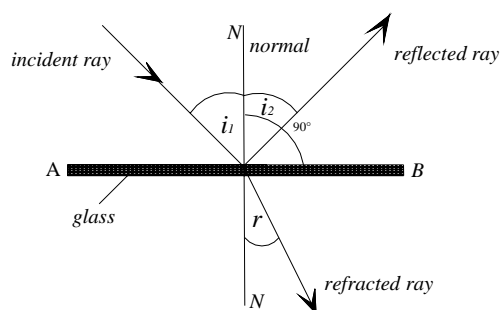
**angle of friction;** the greatest angle between the horizontal and the plane surface of contact between two bodies, when the upper body is just about to slide over the lower. Also called angle of repose, angle of static friction.

**angle of incidence;** the angle, at which a ray of energy or light strikes the surface of mineral or an object, makes it normal to the surface or boundary. → Angle of refraction.

**angle of minimum deviation;** → minimum deviation.

**angle of polarization;** the angle of reflected light from a plane surface, at which the light is polarized. The plan of vibration light being at right angles to the plane of incidence.

**angle of reflection;** the angle of the reflected ray of light or energy, measured from a perpendicular (called the



refraction and reflection angles of light

normal) to the surface, from which the ray is reflected. It is symbolized by  $\theta$ . Also called reflection angle, reflexion angle, angle of reflexion. Same as

Bragg angle. → Angle of refraction.

**angle of repose;** same as angle of friction.

**angle of refraction;** in optics, the angle, at which a refracted ray of light or ray, upon leaving the surface of a mineral, makes with perpendicular (called the normal) to that surface. Also called refraction angle. → Refractive index.

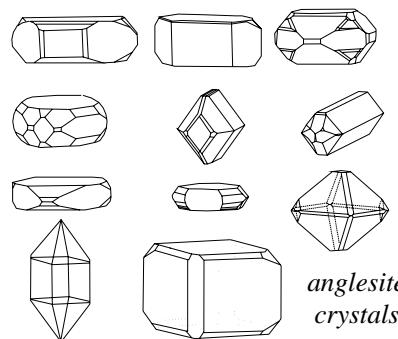
**angle of static friction;** same as angle of friction.

**angle of total reflection;** same as critical angle.

**angles;** bright fissures seen in metamict or low zircon.

**angles;** plural of angle.

**anglesite;** a white orthorhombic mineral. A collector's



mineral. Also called lead spar, lead vitriol.

System: orthorhombic.

Formula:  $4[\text{PbSO}_4]$ .

Luster: Adamantine, vitreous to resinous.

Colors: White, green, yellowish and pale shade of green or blue.

Streak: white or colorless.

Diaphaneity: transparent to opaque.

Cleavage: 001 good, 210 distinct, and {010} indistinct.

Fracture: conchoidal. Brittle.

SG: 6.30-6.39.

H: 2-3.

Optics;  $\alpha$ : 1.8771,  $\beta$ : 1.8826,  $\gamma$ : 1.8937.

Birefringence: 0.0166. ⊕.

Dispersion: 0.044.

Found in the USA, Morocco, Tunisia, Mexico, Russia, Australia, and Scotland.

**angle stone;** a term used by Australian miners for coarse, lenticular and silicified layer variety of sandstone or clay, which is found just above the opal bearing strata. The obtained rock often contains cracks, which are filled with precious opal. Also called guardian-angle stone, walnut stone.

**angel stone;** a term used by Australian miners for hard semi-spherical pieces of porcellanite, which is formed within the clay shale with potch opal along their joint. Also called walnut potch, yowah nut. → Yowah nut.

**angel stone;** a term used by Australian miners in Ridge, for a stone formed within the opal level.

**Anglo-American corporation of South Africa, Ltd.;** a corporation of capital and holding company for control

of diamond mines and industries. Concerned with De Beers Consolidated Mines, Ltd.; Consolidated Diamond Mines of South-West Africa, Ltd.; New Jagersfontein Mining & Exploration Co., Ltd.; Premier (Transvaal) Diamond Mining Co., Ltd.; and Williamson Diamonds, Ltd.

**Angola;** an important diamond-bearing country in central, Africa.

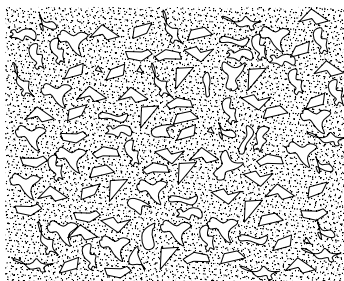
**Angola diamond;** diamonds from the Angola district of Africa.

**angoshtari;** a Farsi or Persian term meaning stone for finger ring which is a sky blue turquoise without dendrite (matrix). → Turquoise classification in Iran. Also spelled angushtary.

**Ångström; or Ångström unit;** named after the Swedish physicist A. J. Ångström, (1814-1874). One billionth of a meter, one tenth-millionth of a millimeter, (1 Å: 10<sup>-7</sup> mm), or one hundred-millionth of a centimeter; the unit is used for smallest measurements required in the electro-magnetic spectrum, the wavelength of visible light waves, and X-rays. The standard international (SI) unit for the measurement of short-wavelengths is the nanometer (nm). 1 nm: 10 Å. Å or A, seldom, ÅE is a abbreviation for the Ångström and the Ångström unit. → Millimicron.

**Ångström unit;** → Ångström.

**angular;** the particles having sharp angles, borders, or



*angular  
sand  
pebbles*

corners.

**angular cutter;** a milling cutter, on which the cutting face is at an angle, greater or lesser than 90, with regard to the axis of the cutter. Also called angle cutter.

**angushtary;** another spelling for angoshtary.

**anhedral;** → anhedral crystals.

**anhedral crystals;** crystals which do not show good, outward form, or, have an abnormal external shape, in contrast to euhedral. Also called anhedral, subhedral or allotriomorphic.

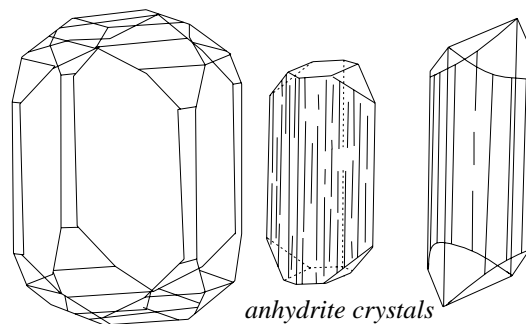
**anhedron;** an anhedral crystal.

**anhydrate;** same as dehydrate.

**anhydric;** free of crystallization water. Not containing hydrogen, or water, in its composition.

**anhydride;** a compound derived from another compound (such as an acid), by the elimination of a water molecule.

**anhydrite;** calcium sulfate, without water, CaSO<sub>4</sub>.



*anhydrite crystals*

Usually massive. Orthorhombic system. Transparent. Colorless to slightly color. Optics;  $\alpha$ :1.570,  $\beta$ :1.5754,  $\gamma$ :1.616. Birefringence: 0.044. ⊕. Dispersion: 0.013. SG:2.98. H:3. Found in Italy, and Mexico. *Vulpinite* is a scaly, granular variety of anhydrite. Also called cube spar. Used for ornamental purposes.

**anhydrous;** without water, not containing hydrogen, or water, in its composition. Often applied to salts without water.

**ani;** a Sri Lankan (Ceylonese) commercial term, for pearls of fine orient, almost perfectly spherical in shape.

**anidiomorphic;** same as xenomorphic.

**ani-gyi;** a Burmese term used for second water corundum of pale red-crimson which are graded due to weight, for sample ani-gyi stone of 2-6 cts. → Corundum classification in Myanmar.

**anil;** a basic compound derived from an aromatic aniline amine.

**anil dye;** an anil compound which used as dye.

**aniline;** an organic, colorless, oily composition of C<sub>6</sub>H<sub>5</sub>-NH<sub>2</sub>, a liquid used in microscopy as an immersion medium. It turns brown on exposure on air. Soluble in alcohol, ether, benzene and to some degree in water. RI:1.58. Also, used as a coloring agent. Highly poisonous. Also called aminobenzene.

**aniline purple, synthetic;** a term applied to first synthetic dyestuff, which known as mauvein. Also called Perkin's mauve.

**animal calculi;** a term applied to stone-like concretion consists of minerals and salts found in hollow organs of animal body, which used in the past as medicine.

**animals;** carved animals from jade are as Chinese religion symbols are ever-present. Small carving of animals was used as tomb pieces as guardians symbols. → Chinese ritual and symbol jades.

**animals in amber;** → insects in amber.

**animal turquoise;** same as odontolite.

**anion;** a negatively charged atom, ion or radical, opposite of cation.

**anionic dye;** same as acid dye.

**anisodesmic;** a crystal or compound, in which the ionic

bonds have unequal strengths, such as in nitrate.

**anisole**; the organic composition  $C_6H_5OCH_3$ , a colorless, toxic liquid, with an aromatic odor, used in microscopy, as an immersion medium, RI: 1.516. Soluble in alcohol, ether, acetone, and benzene, but not in water. Also called methyl phenyl ether, and methoxybenzene.

**anisometric**; not isometric, having unsymmetrical parts, applied to crystals with three unequal axes.

**anisometric**; a term applied in petrology to a texture of a rock in which the grains are different sizes.

**anisotropic**; → crystal anisotropy.

**anisotropy**; → crystal anisotropy.

**anitari pearl**; Sri Lankan commercial term for a slightly lower quality of pearl than ani. Also called anatherie pearl.

**ani-te**; a Siamese term used for third water corundum stones of bright light-crimson known as ani-te or bombaing, which are graded due to weight of 2-6 cts, they were fancied in India. → Corundum classification in Myanmar.

**ani-the**; a Burmese term used for mixed minute corundum stones of second water and fine quality. → Corundum classification in Myanmar.

**ankaramite**; a Malagasy name for an olivine-bearing basalt, containing pyroxene and olivine phenocryst.

**ankerite**; a mineral related to dolomite, it is associated with iron ores. Frequently cut cabochon and prized by collectors. Also called ferroan dolomite, claet spar. → Dolomite.

System: hexagonal.

Formula:  $3[(Ca,Fe,Mg)(CO_3)_2]$ .

Luster: vitreous to pearly.

Colors: colorless, white, grayish, pale brown, greenish, pinkish.

Streak: colorless.

Diaphaneity: translucent to subtranslucent.

Cleavage: {1011} perfect.

Fracture: subconchoidal. Brittle.

SG: 2.97.

H:  $3\frac{1}{2}$ - $4\frac{1}{2}$ .

Optics;  $\omega$ : 1.728,  $\epsilon$ : 1.531.

Birefringence: 0.187.  $\ominus$ .

Source: Algeria, the Czech Republic, Hungary, USA and throughout other countries.

**ankerite luminescence**; orange, creamy white, blue, green, pale brown under SWUV. Orange, blue, creamy white, green, pale brown under LWUV.

**ankh symbol**; an ancient Egyptian symbol for life, which is in the form of a tau cross.

**ankle ring**; same as anklet.

**anklet**; an ornament of gold or any other noble metals, such as a ring, chain, or band, worn around the ankle by women in Egypt, Greece, and Rome. Also known as an *ankle ring*.

**annealing**; the method, by which metals or glass are heated to high temperature, and then slowly cooled, to give more tenacity, make then less brittle eliminate various stresses and weaknesses

**annealing**; annealed diamonds are diamonds changed in color from the green of reactor-treatments to yellow-orange, or brown (between  $200^\circ C$  to  $800^\circ C$  or  $392^\circ F$  to  $1,472^\circ F$ ).

**annealing**; in the glass industry the heating and slow cooling of glass to reduce stress.

**Anne of Austria**; the circular, rose cut diamond of 14 cts, or the Rose d'Angleterre, which once belonged to Anne of Austria or the Queen of France. It is one of the 50 diamonds that the Cardinal Mazarin (1602-1661); a cardinal, statesman, and prime minister under Louis XIV, bequeathed to the French Crown.

**Anne of Brittany's Ruby**; an irregular polished ruby of 105 cts. Now on display at the Museum in Louvre, Paris, France.

**Annex Kleinzee**; an alluvial diamond deposit in the northern part of Namaqualand, Southwest Africa. → Kleinzee.

**annite**; an iron-rich variety of biotite or mica. Also called hydroxyl-annite.

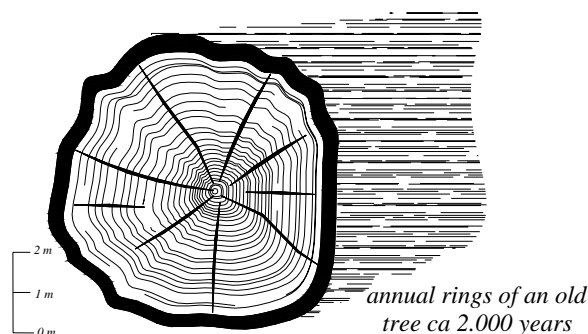
**anniversaries**; same as wedding anniversaries.

**Anniversary Diamond**; the pear-shaped diamond of 65 cts, from South Africa cut from a rough stone, which weighing over 200 cts, by Baumgold in 1951 to celebrate the 75<sup>th</sup> anniversary of the Baumgold company. The present owner is Canadian.

**anniversary ring**; same as eternity ring.

**annular**; having the shape of an unbroken circle, or ring.

**annual ring**; a term used for rings of wood, which indicate one year's growth of stem of a tree. Similar to



that can be seen in some stones such as coral. → Conchiolin coral.

**anode**; positive electrode, used in a plating bath.

**anode polishing**; same as electrolytic polishing.

**anodizing**; a method of color covering aluminum, aluminum alloys, magnesium, and a few other metals in an electrolytic treatment bath.

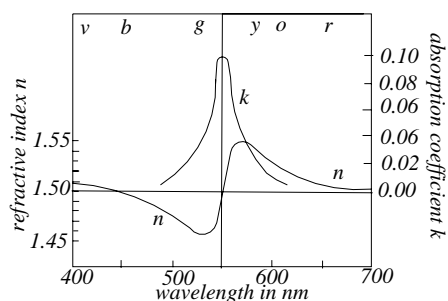
**Anodonta cygnea**; a kind of freshwater pearl-bearing

mussel found in ponds near Turin, Italy. Also called swan mussel.

**anodyne necklace;** a charm necklace, used to ward off pain or illness in 18<sup>th</sup> century.

**anomalous birefringence;** anomalous double refraction.

**anomalous dispersion;** anomalous behavior of refractive index versus wavelength being abnormally high on the longer wave side of the band and



anomalous dispersion. After Nassau 1983

abnormally low on the other side, it means absorption spectrum create by a prism is not in its normal order. This effect frequently can be seen in violet crown glass, which has an anomalous band at 550 nm. Also can be seen in fuchsine.

**anomalous double refraction;** double refraction in a normally, single refraction stone, caused by internal stresses. Found in stones, such as almandine garnet, diamond, synthetic spinel, due to rapidly cooled glass, or cubic minerals. Seen through irregular extinction, when a substance is observed between crossed Nicols, or crossed filters, of a polariscope, as in synthetic spinel and sometimes in garnet. Known as *tabby extinction*, when the effect is alternate light and dark striping. Synthetic spinel show always displays the anomalous effect, and presence of peculiar *strain knots* or pseudo-interference, is a helpful feature in its identification. Also called anomalous birefringence. Anomalous extinction (anomalous double refraction) always appears at irregular intervals and is rarely orientated at 90°. Also called extinction position. → Polariscope, strain, tabby extinction.

**anomalous double refraction in garnet;** → anomalous double refraction.

**anomalous double refraction in glass;** anomalous double refraction in glass is seen due to the suddenly cooling of the mass. → Anomalous double refraction.

**anomalous double refraction in synthetic spinel;** → anomalous double refraction.

**anomaly;** deviation from the normal, or average, or expected, or unusual or irregular.

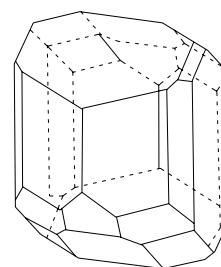
**anomite;** a term used to a variety of biotite, which differs from biotite only in optical orientation.

**anophorite;** → hornblende.

**anorthic system;** same as a triclinic system, crystals having unequal, oblique axes.

**anorthite;** a basic and endmember of the plagioclase feldspar series, Ab<sub>10</sub>-An<sub>90</sub> to Ab<sub>0</sub>-An<sub>100</sub>, with the chemical formula: CaAl<sub>2</sub>Si<sub>2</sub>O<sub>8</sub>. It consists of calcium-aluminum silicate and contains no sodium. Triclinic system. Colorless, white, gray, reddish. Transparent to translucent. White streak. Cleavage: {001} perfect, and {010} nearly perfect. Fracture: conchoidal to uneven. Brittle. Optics;  $\alpha$ :1.577,  $\beta$ :1.585,  $\gamma$ :1.590. Birefringence :0.013.  $\ominus$ . SG:2.74-2.77. H:6-6½. Cut as faceted gems for collectors. Also Called calcicase, Ca-spar, calcium feldspar, lime feldspar.

**anorthoclase;** a triclinic feldspar, closely related to the orthoclase group. Mainly a soda-potash feldspar K(AlSi<sub>3</sub>O<sub>8</sub>)-Na(AlSi<sub>3</sub>O<sub>8</sub>). Colorless, white, greenish, yellowish, gray, reddish. Transparent to translucent. White streak. Cleavage: {001} perfect, and {010}



anorthite crystal

perfect. Fracture: uneven. Brittle. Optics;  $\alpha$ :1.518-1.526,  $\beta$ :1.522-1.532,  $\gamma$ :1.522-1.534. Birefringence: 0.005.  $\ominus$ . SG:2.56-2.60. H:6-6½. Found in Australia, Germany, USA, Kenya, and Nigeria (Africa).

**anorthosite;** a coarse-grained, igneous rock, containing almost plagioclase, near labradorite (Ab<sub>63</sub>-Or<sub>37</sub>), which invert to monoclinic system when heated, and containing minor amounts of pyroxene, and olivine. Found in the Canadian Shield. Also called soda microcline, anorthose.

**anoxic;** deficiency of oxygen or without oxygen.

**Antarctica;** a common beryl deposit of greenish-blue in quartz veins worked out near Commonwealth Bay, Adélie, Australia.

**antelope jade;** a term used by the Chinese to describe a particular color of jade.

**antero aquamarine;** same as Colorado aquamarine.

**anthill garnet;** an early pyrope mine in New Mexico, Arizona and Utah, USA were large ants and scorpions were constructed the sites by using of garnets.

**anthill scorpion;** an early garnet mine in New Mexico, Arizona and Utah, USA were large ants and scorpions were constructed the sites by using of garnet grains.

**anthocyan;** same as anthocyanin.

**anthocyanin;** a flavonoid plant colorant of red, pink,

*anthochromacy – Antilles pearl*

and blue colors in leaves and fruits of plants seen as glycosides pigments. Water-soluble. Used as dyes. Also called anthocyan. → Flavone, cyanidin.

**anthochromacy**; → metachromacy.

**anodite**; gypsum or aragonite that occurs in caves, as radiating, needle-like, or hairlike crystals, from a common base.

**anthosiderite**; a pseudomorph of quartz and hydrated iron oxide (goethite), after cummingtonite.

**anthophyllite**; a silicate mineral of the series anthophyllite gedrite in the amphibole group and a variety of asbestos. Occurring as massive, lamellae or radiation fibers in metamorphic rocks. Dark violet fluorescence under SWUV and LWUV light. Cut gems exhibit sparkling iridescence and frequently cat's-eye effect. Also called bidalotite.

System: orthorhombic.

Formula:  $4[(\text{Fe}^{+2}, \text{Mg})_7(\text{Si}_8\text{O}_{22})(\text{OH}, \text{F})_2]$ .

Luster: silky to vitreous, pearly on fresh cleavage.

Color: clove-brown, yellowish-brown to yellowish green, light green, light yellow.

Streak: colorless to light gray.

Diaphaneity: transparent to translucent inclined to opaque.

Cleavage: {110} perfect, {010} imperfect, and {100} imperfect.

Fracture: not determined.

SG: 2.85-3.57.

H: 5½.

Optics;  $\alpha$ :1.587-1.694,  $\beta$ :1.602-1.71,  $\gamma$ :1.613-1.721.

Birefringence: 0.013-0.028.  $\ominus$  or  $\oplus$ .

Found in Canada, Greenland, Norway, USA, Italy, Austria, and the Czech Republic.

**anthophyllite cat's-eye**; a red-brown to clove-brown variety of anthophyllite, it occurs as fibrous which exhibit a sharp cat's-eye effect after cut cabochon.

**anthracite**; a compact, dense, brittle, glassy or semimetallic luster coal of black color like jet, in which carbon content is 92%-98%. Conchoidal to uneven fracture. H:2-2.5, SG:1.32-1.37. Ignites with difficulty and burns with a short blue flame and much less smoke. It is of the highest metamorphic rank. Found in China, Russia, USA and South Africa. Used as jet imitation for small ornaments. Also called hard coal, stone coal, black coal, kilkenny coal.

**anthraconite**; a stone emits an odor when rubbed or broken such as bituminous limestone or brown dolomite.

**anthrakion**; a term used by Theophrastus for carbuncle garnet from Orchomenos in Arcadia, Troezen and Corinth.

**anthraquinone**; a yellow needle crystal  $\text{C}_6\text{H}_4(\text{CO})_2$   $\text{C}_6\text{H}_4$ . Soluble in alcohol, ether, and acetone. Insoluble in water. Used as dyes. Also known as C.I. vat blue 4.

**anthrax**; a red gemstone referred to by the ancients, probably carbuncle, garnet, ruby or other perhaps red

stones.

**anthrax**; a Greek term for incombustible or cannot be burnt, in contrast to charcoal.

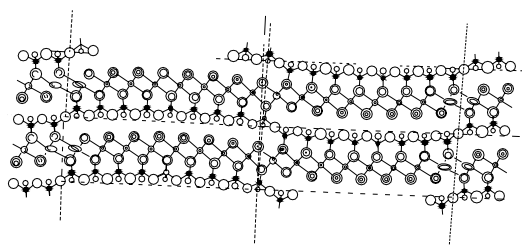
**Anthrax**; a biblical term for the fourth gemstone in the Aaron's Breastplate comparative to nephew. Translated as ruby (carbuncle) or probably an almandine garnet or emerald, also hematite. The stone is engraved with the word *Judah*. Also spelled nophech, nophak.

**anti**; → corozo nut.

**antibiotic aureomycin**; a combat agent against mortality of oysters, by which the nucleus are dipped in the agent.

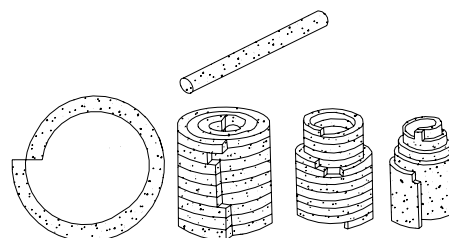
**antidote to poison**; powder of emerald it token before the poison spread all over the body. Alternatively, once a fossilized object consisting of the petrified fish tooth or parallel bone occasionally worn as a protective or curative power, charm or an antidote to poison. Set in finger rings as an amulet. Also called poison antidote, *virtuous stone*, when it is made from gemstones. → Toadstone, garalari.

**antigorite**; a soft, platy or lamellar, mineral variety of the serpentine group, with a pale green color.



*structure of antigorite-serpentine. After Kunze, G*

Resembles jade in appearance. Occurring as lamellar because of intense shearing stress as in dislocation-metamorphism. Monoclinic system. Chemical formula:  $2[\text{Mg}_3\text{Si}_2\text{O}_5(\text{OH})_4]$ . Optics;  $\alpha$ :1.560,  $\beta$ :1.566,  $\gamma$ :1.571. Birefringence: 0.011-0.014.  $\ominus$ . SG:2.61. H:2½-3½.



*spiral-cylindrical structure of antigorite.*

*After Grimm, R.E.*

Synonym: picrolite, and baltimorite. Found in Valle d'Antigorio, Piedmont, Italy.

**Antilles pearl**; a misleading term for imitation pearl, cut as beads, from the iridescent, mother-of-pearl of the turbo sea snail. It has a pearly appearance on surface, but a yellowish, non-nacreous bottom. Also called oil pearl.

**antilogous pole**; a term used in crystallography for positive end of the *c*-axis with polar symmetry.

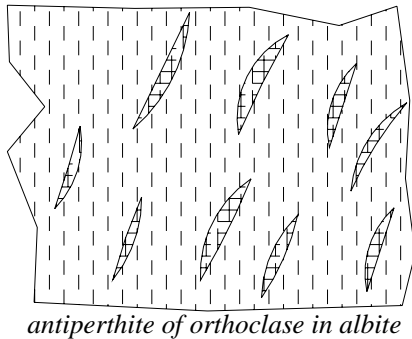
**antimonite**; an obsolete name for stibnite.

**antimony**; a trivalent, and pentavalent, metalloid element of the group VA of Periodic System. It is metallic, silvery-white, crystalline, and brittle, with the Symbol Sb. Used as an alloy, in pewter.

**antimony glance**; an obsolete name for stibnite.

**Antipathes spiralis**; → king's coral, accarbaar.

**antiperthite**; microcline or orthoclase inclusions exsolved in albite, or oligoclase feldspars. Found in parallel or subparallel intergrowth formed during the



slow cooling of magma, and visible to the naked eye.  
→ Perthite feldspar.

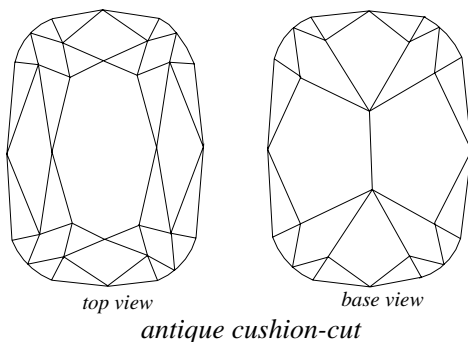
**antipoint**; → airy disc.

**antique amber**; antique amber can produce by heat-treatment which become rich brown color. Amber will embedded in heated colza or rape-seeds oil in an iron vessel 30-40 hours. Also called antiqued amber, toasted amber. → Heat treatment of amber.

**antique amber beads**; antique amber beads are often golden-orange in color because of exposure to air, those fresh amber are yellow-gold in color.

**antique cut**; → cushion cut.

**antique cushion brilliant**; named for any of the modifications of the brilliant cut, either in outline and in the number of facets. More or less rectangular, or



square in form, with rounded corners, and slightly curved sides. → Cushion-shaped brilliant.

**antiqued amber**; same as antique amber.

*antilogous pole – Antwerp rose*

**antique glass**; same as cathedral glass.

**antique reproduction**; copy made from the design of ancient jewels.

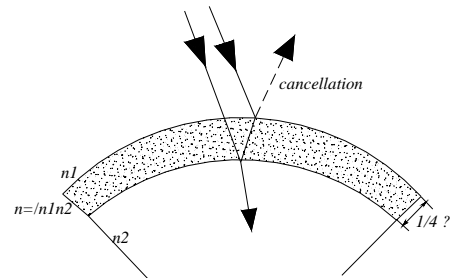
**antique shape**; a gemstone shaped with rounded ends.

**antiquing**; metals or other materials made by objecting them to atmospheric corrosion, after long exposure, or being chemically treated, so that they take on color, such as naturally occurs on copper and bronze which achieves a green film or discoloration, to protects the metal from further oxidation. Gold may be darkened by a black chrome. → Patina.

**antireflection coating**; same as anti-reflex-film.

**antireflex coating**; same as anti-reflex-film.

**antireflex film**; a thin, coating of some substance such as cryolite  $\text{Na}^3\text{AlF}_6$  or  $\text{MgF}_2$ , on the surface of gems or



*After Nassau 1983*

imitation gemstones, which gives no reflecting properties to the stone. Also called antireflection coating, antireflex coating.

**Anton Dunkels Diamond**; the black, drop-shape diamond set in a brooch, named after the diamond merchant Dunkels.

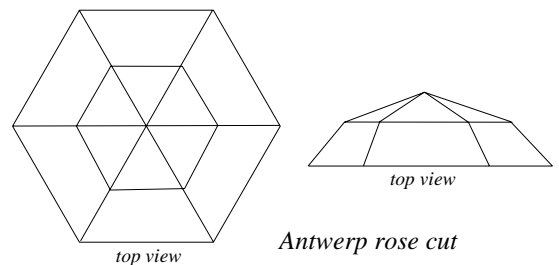
**antozonite**; a dark violet to black semiopaque variety of fluorite from Wölsendorf Germany, which emits a strong odor when crushed.

**Antwerp**; the most important diamond-cutting center in the world, Antwerp, Belgium.

**Antwerp Diamond**; the diamond of 47.50 old cts. King Philip the II of Spain, bought this diamond in 1559, for his third wife.

**Antwerp qualities**; a commercial term for diamonds cut in Antwerp.

**Antwerp rose**; a cut which has fewer than the usual sixteen and namely twelve, triangular and trapeze-



### Antwerp rose - aperture

hedron tin shape. Also called Brabant, Dutch rose cut, Antwerp rose cut.

**Antwerp rose cut;** → Antwerp rose.

**anyan;** a Burmese term used for mixed common water-worn spinel. → Corundum classification in Myanmar.

**anyan-nat-thew;** a Burmese term used for rose spinel of octahedron crystal and perfect luster. → Corundum classification in Myanmar.

**anyan-seinche;** a Burmese term used for small spinels of quality of anyan-nat-thew. → Corundum classification in Myanmar.

**anygyi;** a Burmese name, applied to second-water rubies.

**anyolite;** a green, zoisite rock, containing black hornblende and large, opaque ruby crystals. Used as ornamental rock. It is an absorption spectrum band is at 455 nm. Found in Tanzania. Also called Masai anyolite.

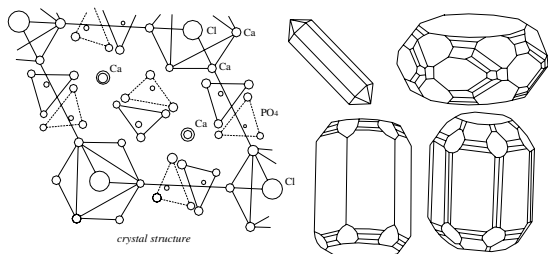
**anyum;** a Myanmar (Burmese) name employed to denote first quality, two-carat rubies.

**anyun;** a Burmese term used for corundum stones of 2 cts., and over. → Corundum classification in Myanmar.

**Apache tears;** a tear-shaped, , pebble-like, rounded nodule of obsidian. Translucent, iridescent, light to smoky, dark-gray to gray-brown color. The occasional presence of silky striations give it a cat's-eye effect, when cut en cabochon. Supposedly named after their resemblance to the tears of Apache Squaws. Occurs in Maricopa and Pinal Counties, Arizona, California, and Nevada, USA. Used by Indians for arrowheads.

**apanica;** a Sanskrit term for emerald.

**apatite;** a group of variously colored minerals. Varieties: the blue-green is named as *moroxite*, the colorless, known as *francolite*, the yellow-green called *asparagus stone*, a fine deep-green, from Canada, is named *trillium*, a sky-blue mixture of lapis lazuli and apatite from Siberia, Russia is known as *lazurapatite*,



crystal structure and crystals of apatite

and the blue with chatoyant effect, is called *apatite cat's-eye*. Dahlite is a carbonate-apatite. Used as gemstones. Also called calcium phosphate, somberite and formerly called phosphorite.

System: Hexagonal.

Formula:  $2[\text{Ca}_5(\text{PO}_4)_3(\text{F}, \text{Cl}, \text{O}, \text{OH})_3]$ . May contain didymium.

Luster: resinous to greasy.

Colors: Colorless, white, rose, orange, yellow, red, pink, purple, green, yellows and pale shade of green or blue.

Streak: white.

Diaphaneity: transparent to semitransparent.

Cleavage: 0001poor, 1010 fair.

Fracture: irregular. Brittle.

SG: 3.16 - 3.22.

H: 5.

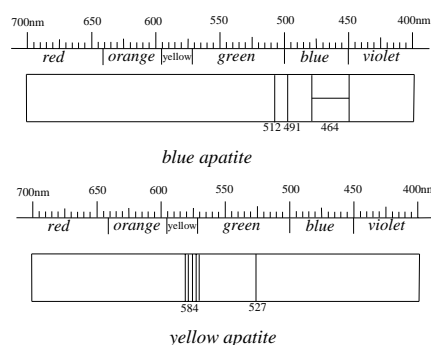
Optics;  $\epsilon$ : 1.632-1.649,  $\omega$ : 1.628-1.642.

Birefringence: 0.002-0.013.  $\ominus$ .

Dispersion: 0.013.

Found in Sri Lanka, Myanmar (Burma), Saxony, Bohemia, Russia, Sweden, Norway and Maine (USA).

**apatite absorption spectrum;** blue apatite has broad



absorption spectrum of blue and yellow apatite

bands, at 631, 622, 525, 512, 507, 491, and 464 nm.

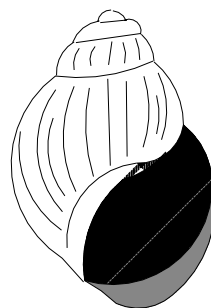
**apatite cat's-eye;** blue apatite with a cat's-eye effect, used for the cabochon cut.

**apatite cut;** colored apatite especially the blue one is cut as a gemstone.

**apatite pleochroism;** strong pleochroism in blue stones, in blue and yellow. Yellow apatite, pinkish-purple under SWUV and LWUV.

**aperiodic balance;** a balance, which reads or measures the magnetic attraction placed on a stone, the weight can be read directly on the scale.

**aperture;** the diameter of the circular opening of a lens or mirror system through which light enters an optical



aperture of a shell

system.

**aperture of shell;** the hole of the quasi circular opening



of a shell.

**apex;** the top or highest point of a vein, relative to the surface.

**apex;** the highest point of a landformation.

**apex of shell;** the highest or uppermost point of a shell



*apex of shell*

organ or structure body.

**apex stone;** the highest ornament stone in a building. Also called saddle stone.

**aphaniphyric;** → cryptocrystalline.

**aphanite;** any fine-grained compact rock of diorite composition, whose components are not distinguishable with the unaided eye. Also called felsite, kryptomere.

**aphanite;** same as fine-grained. Also called cryptomere, aphanite, felsitoid.

**aphanitic;** very fine-grained igneous rock or groundmass or related to aphanite. The obsolete term felsitic was for light-colored rock with aphanitic texture.

**aphinite;** → aphanite.

**aphrite;** a foliated, lamellar, scaly, chalky variety of calcite, having a white, pearly luster. Synonym: earth foam, foaming earth, foam spar foam stone.

**aphrizite;** a local term, for a black variety of tourmaline, containing iron.

**aphrodisiac properties;** a believing that pearl have aphrodisiac properties?

**aphroseline;** in Greek, same as adularia.

**aplanachromatic lens;** a lens corrected for both chromatic aberration and spherical aberration. → Aplanachromatic lens.

**aplanachromatic loupe;** a loupe containing an Aplanachromatic lens.

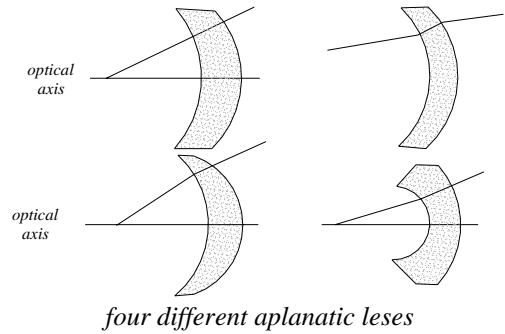
**aplanatic;** an optical system, which produces an image free from spherical aberration.

**aplanatic lens;** a lens, which is corrected for spherical aberration and coma.

**aplanatic triplet;** an aplanatic lens system, made of three pieces cemented together, to produce an image free from spherical aberration. A more popular name for this term is triple aplanat.

**aplite;** white to gray, fine-textured granitic dike rock, consisting mainly of quartz, potassium feldspar and

*apex - apophyllite*



*four different aplanatic leses*

acidic plagioclase. Used for carving statues and enamel in glass industry. Also calling haplite.

**aplitic;** having the fine-grained texture of haplite.

**aplome;** the yellowish-green, brownish-green to dark-green varieties of andradite or manganese garnet. Same as haplome.

**apobsidian;** an old, devitrified obsidian.

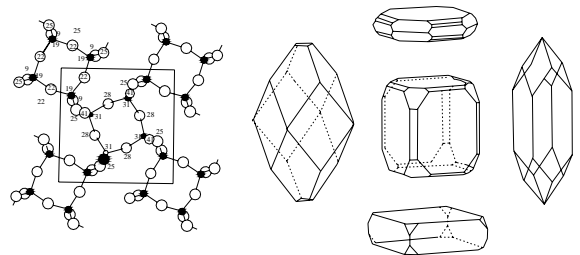
**Apocalypse gems;** a term used for an emerald (a variety of beryl), which used in High Priest Breast Plate and in the Apocalypse.

**apochromatic lens;** a high quality lens, which has been corrected for both spherical and chromatic aberration. → Aplanachromatic lens.

**apogranite;** a term used a in Russia for high-albite (which is sodium-rich) granite enriched in beryllium, lithium, niobium, tantalum, zirconium etc.

**apogrit;** same as graywacke.

**apophyllite;** a phyllo-silicate mineral. Cut as gems and prized by collectors. Also, called fish-eye stone variety



*apophyllite structure and crystals*

of apophyllite is called ichthyophthalm. Apophyllite is a secondary mineral and occurring with zeolites in geodes in igneous rocks and absalts.

System: tetragonalic.

Formula:  $4[\text{KCa}_4(\text{F},\text{OH})(\text{Si}_4\text{O}_{10})_2 \cdot 8\text{H}_2\text{O}]$ .

Luster: mother-of-pearl. Sometimes with fish-eye effects.

Colors: colorless, white, reddish-white, gray, yellowish, greenish, flesh-red and brown.

Streak: colorless.

Diaphaneity: transparent to semitransparent.

Cleavage: {001} highly perfect, {110} imperfect.

Fracture: uneven. Brittle.

SG: 2.30-2.40.

H: 4-5.

Optics;  $\omega$ : 1.537,  $\epsilon$ : 1.535.

Birefringence:  $\pm 0.002$ .  $\ominus$  or  $\oplus$ .

Found in Harz (Germany), Mexico, India, Sweden, Transylvania, Switzerland, Brazil, New Jersey (USA), and Broken Hill (Australia).

**apophyllite fish-eye**; the fish-eye variety of apophyllite is called ichthyophthalm.

**Apostles, gem symbols of Twelve**; jasper; Peter, sapphire; Andrew, chalcedony; James, emerald; John, sardonyx; Philip, sard; Bartholomew, chrysolite; Matthew, beryl; Thomas, topaz; James the Less, chrysoptase; Jude, hyacinth; Simon, amethyst; Judas.

**apparent density**; an obsolete term for bulk density. The weight of an object or mineral, divided by its exterior volume, less the volume of its open pores.

**apple jade**; a term used by the Chinese to describe a particular color of jade.

**applied geology**; the application or studies of geological appearance, economic geology, hydrogeology, engineering geology, reconnaissance geology or military problems.

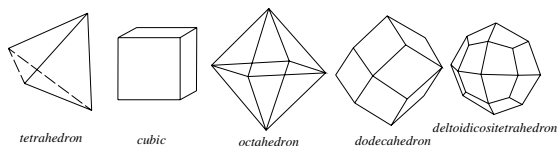
**applied mineralogy**; the application of various mineral to economic, engineering, technical mineralogy or military problems.

**appliqués work**; a type of decoration made by affixing. Gemstone appliqués made from jade, lapis lazuli, and other stones are much rarer than inlays or overlays. An example of a famous appliqué object is the Chinese Coromandel room-divider screen.

**appraisal**; an estimation or the fixing a monetary value on anything, such as a gemstones or jewelry. It differs from valuation and evaluation.

**appraiser**; one who estimates moderately quality and value of an opal mine or deposit.

**appearance**; the external geometrical forms or shapes, in which a crystal occur, such as cube, hexagonal,



some crystallographic appearances in cubic system

tetragonal, etc. Also called tracht. → Single form, closed form, opens form.

**approval selection**; the largest quantity of cut gems of the trade, which are prepared and to be sent out for approval and selection, also single gems.

**apricotine**; commercial term for the yellowish-red apricot-colored garnet or quartz pebbles from Cape May, New Jersey, USA.

**apsaras**; a Chinese term for an attendance Buddhist figure in form of celestial musician and dancers made of jade.

**Apukan River**; a district of alluvial diamond deposit in the Danau Seran area of southern Kalimantan, Indonesia.

**apya**; a Burmese term used for flat corundum stones of fine quality. → Corundum classification in Myanmar.

**apya-kya**; a Burmese term used for apya-sa a term for flat corundum stones of second class. → Corundum classification in Myanmar.

**apya-sa**; same as apya-kya.

**apyazone**; a Burmese term used for flat corundum stones of third quality. → Corundum classification in Myanmar.

**apyrite**; a term sometimes used for peach-bloom colored tourmaline or peach-colored tourmaline.

**apyu-the**; a Burmese term used for small corundum stones of pale, inferior quality and rough. → Corundum classification in Myanmar.

**aqiq**; a Hebrew term for agate. Also spelled achite.

**aqua aura quartz**; a commercial, misleading term for a bluish-green to pale-blue, iridescent colored, natural quartz crystal, which is in fact a colorless stone but takes on color when coated with pure gold, silver, or platinum.

**aqua aura topaz**; a commercial misleading term meaning coated topaz with a very thin layer of gold which is used to become a pale blue color topaz, or to improve the color of stone.

**aqua fortis**; same as concentrated nitric acid.

**aquagem**; a commercial, misleading term for a light blue synthetic spinel.

**Aquamarijn**; Dutch term for aquamarine.

**Aquamarin**; German term for aquamarine.

**Aquamarin**; German misleading term for pale blue apatite.

**Aquamarin**; German misleading term used rarely for pale blue topaz.

**Aquamarin Achter**; German misleading term used rarely for pale blue topaz.

**Aquamarin Chrysolit**; German misleading term used rarely for pale blue apatite.

**aquamarine**; a pale blue to light green variety of the gem quality of beryl. It is a dichroic gemstone, with so-called *twin colors*. The term aquamarine is misleadingly used as a prefix, such *aquamarine chrysolite* which is a greenish-yellow beryl, *aquamarine emerald* a triplet, made of colorless beryl, and *aquamarine topaz* a bluish topaz. Most often, the

sky-blue aquamarine in the trade, are heat treated green yellow or brown yellow stones which has been exposed to temperatures of 250-500° C, sometimes as high as 700° C, or Indian and Brazilian green beryls. The chatoyancy effect is frequently seen in some aquamarines. Usually cut as a brilliant, or step cut. *Synthetic aquamarine* is a misleading term for synthetic spinel. Aquamarine means water of the sea according to its color. → Goshenite, inclusion in aquamarine.

System: Hexagonalic.

Formula:  $2[Al_2Be_3Si_6O_{18}]$ .

Luster: vitreous.

Colors: shades of blue or blue-green to light green.

Streak: white, colorless.

Diaphaneity: transparent to semitransparent.

Fracture: uneven to conchoidal. Brittle.

Cleavage: 0001 less distincts.

SG: 2.68-2.71, seldom 2.73.

H: 8.

Optics;  $\omega$ : 1.570-1.580,  $\epsilon$ : 1.575-1.586.

Birefringence: 0.0055-0.006.  $\ominus$ .

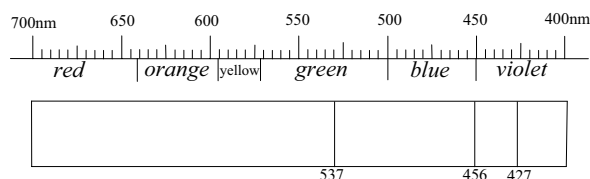
Dispersion: 0.014.

Found in Brazil, Madagascar, Russia, Sri Lanka, California (USA), and other locations.

**aquamarine**; sometimes the term is used as a color designation, meaning blue to light bluish green. → Goshenite.

**aquamarine**; a misleading term for aquamarine blue colored synthetic spinel. → Goshenite.

**aquamarine absorption spectrum**; aquamarine display violet at 427 and 456 nm, and green at 537 nm. Heat-



*aquamarine absorption spectrum*

treated aquamarine is inert.

**aquamarine, Brazilian**; a misleading term for blue topaz.

**aquamarine chrysolite**; misleading term for the greenish-yellow variety of beryl.

**aquamarine colored sapphire**; a misleading term for pale blue sapphire like aquamarine.

**aquamarine cut**; faceted in the usual cut for emerald or step cut; also brilliant cut, in all sizes.

**aquamarine emerald**; a misleading commercial term

for genuine beryl or aquamarine triplet.

**aquamarine eyeglass, Nero's**; a fable about aquamarine eyeglass, beryl eyeglass and emerald eyeglass used by Emperor Nero (37-68 A.D.) to see the gladiatorial fights in ancient Rome, which was cut as a lens. Some authorities supposed to have been light green or light beryl or perhaps jasper.

**aquamarine filter**; a filter made from aquamarine to test gems.

**aquamarine glass**; light blue, or greenish-blue colored glass, regardless of physical properties, or chemical composition.

**aquamarine imitation**; imitations that are made from aquamarine-colored synthetic spinel, colored by cobalt which can be distinguished by means of a Chelsea filter. Imitations show red, while true aquamarines show green. Synthetic spinel has a refractive index of 1.728. Also commonly used blue topaz, with RI: 1.61 and 1.62. Some imitations are made from aquamarine blue glass but they are distinguished readily by their single refractive index on the refractometer.

**aquamarine imitation**; to imitate colored transparent aquamarine added cobalt oxides to an antimony glass.

**aquamarine, inclusion in**; → inclusion in aquamarine.

**aquamarine sapphire**; a term for pale blue sapphire.

**aquamarine, Siam**; a misleading term for heat-treated blue zircon.

**aquamarine, synthetic**; a misleading term for pale-blue or greenish-blue synthetic corundum, or spinel.

**aquamarine test filter**; the colored Chelsea filter is used for rapid testing of aquamarines to distinguish them from synthetic material. Nearly all true aquamarines show greenish-blue under Chelsea filter.

**aquamarine topaz**; a misleading term for greenish-blue topaz.

**aquamarine tourmaline**; a misleading term for pale blue, and greenish to pale blue tourmaline.

**aquamarine triplet**; a genuine triplet, made from beryl or aquamarine, is used to imitate emerald. It is often called emerald triplet.

**aquamarinfluss**; a German misleading term for pale blue fluorite.

**aquamarinfluss**; a German misleading term for pale blue topaz.

**aquamarinschorl**; a German misleading term for pale blue beryl.

**aqua regia**; a highly corrosive mixture of nitric and hydrochloric acids, in the proportion of one part nitric to two parts hydrochloric acid. Used as a solvent for metals, including gold, and platinum, and for testing high karat gold.

**aque marine**; another Spanish spelling for aquamarine.

**aque marine**; another French spelling for aquamarine.

**aqueous**; of water, watery or pertaining to water, made from, with, or by means, of water. Partly consisting of water. Dissolved in water.

**aqueous humor**; the part of eye after cornea, consisting of transparent, dilute slightly saline liquid filling the anterior chamber of the eye, by which light passing through pupil, the opening in the adjustable iris, and the lens reaching the aqueous humor. → Eye.

**aqueous opal**; another term for hydrophane a white-yellow, brown to green variety or common opal. It becomes more translucent when immersed in water.

**Aquileia amber manufacture**; a city in Italy in Roman times which become main center of decorative carving and cutting amber of bunches of fruit, animal and vegetable figures.

**Ar**; a chemical symbol for the element argon.

**arabescato marble**; a misleading term for pale-pink to grayish, brecciated limestone, with patterns of swirling lines, resembling Arabic script, found in Bergamo, Italy.

**arabesque**; ornamental work, in the Arabian style used in decorative design for flat surfaces. The style uses interlocking curves, which may be painted, inlaid or carved. Arabesque style can be seen in some jewelry, especially of the Renaissance period for example in designs of virgil solis.

**arabesquitic**; a style of decoration, using Islamic motifs, composed of geometrical outlines, and curved lines, with flowers and fruits. Applied to the surface texture to give luster properties, on the apparently, homogeneous, groundmass, such as on clocks, ornaments, intarsia, etc.

**arabi**; a term used by turquoise cutter in Iran for flat stone (in Arabic: mossatah), a cut-form preferred by Arabs. → Turquoise cut in Iran.

**arabi**; a Farsi or Persian term for pale colored, patched, or dendritic turquoise, from Nishapur, Iran. → Turquoise classification in Iran.

**Arabian beads**; roughly fashioned, coral pieces of a natural shape, string into beads, bored through the center and used for ornamental purposes, with turquoise.

**Arabian diamond**; → Arabic diamond.

**Arabian luster**; the original formula, an extremely thin-layered paint on-glaze, used by the Moors since the 9<sup>th</sup> century, for the decoration of pottery.

**Arabian magic diamond**; → Arabic magic diamond.

**Arabic diamond**; a misleading term for a colorless quartz from Saudi Arabia, which is fashioned in Thailand. Also called Arabian diamond, Quisumah diamond, Quasima diamond, and Khasumi diamond.

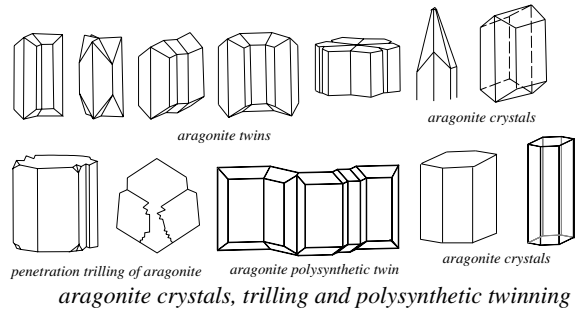
**Arabic magic diamond**; a misleading term for a colorless or, pale-yellow, synthetic sapphire. Used as a diamond simulant. Also called Arabian magic

diamond.

**Arabij**; an Arabic term for pale emerald from Arabia.

**aragon spar**; → aragonite.

**aragonite**; a relatively unstable, white, yellowish, or grayish calcium carbonate. Trimorphic with calcite and



vaterite. Aragonite is not a gemstone but it is the principal constituent of pearl, in concentric sheets and in coral. Synonym aragon-spar. Egyptian onyx is a misleading term. Occasionally faceted for collectors. → Korite.

System: orthorhombic.

Formula:  $4[\text{CaCO}_3]$ .

Luster: vitreous to resinous.

Colors: colorless, white, yellowish, gray, green, reddish, brown, pale to deep lavender.

Streak: white or colorless.

Diaphaneity: transparent to translucent.

Cleavage: 010 distincts. {110} indistinct, {011} indistincts.

Fracture: uneven. Brittle.

SG: 2.947.

H: 3-4.

Optics:  $\alpha$ :1.530,  $\beta$ :1.681,  $\gamma$ :1.685.

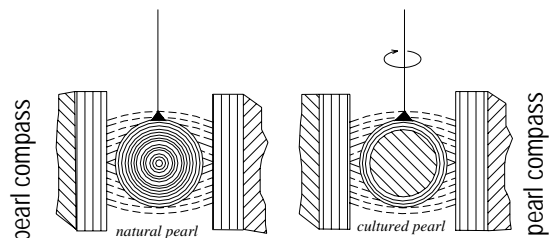
Birefringence: 0.155.  $\ominus$ .

Dispersion: 0.015.

Found in Germany, Hungary, England, Spain and the USA.

**aragonite**; a misleading term for bright-yellow stalagmite, calcite from Namibia, South-West Africa. → Korite.

**aragonite group**; a mineralogical classification, to which belong aragonite, bromelite, witherite, strontianite and cerussite.



*natural and cultured pearl in a magnetic pearl compass. magnetic field therefore pearl moves*

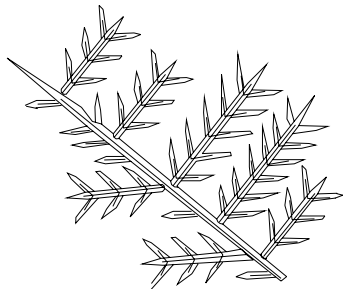
**aragonite susceptibility in pearls;** susceptibility action of natural and cultured pearl in a magnetic pearl compass. Natural pearl has no turning or moving while cultured pearl because parallel layers of nucleus tend to turn or oriented themselves in line with the magnetic field.

**arandisite;** an attractive rare mineral, which is used for cut gems with limonite. System: amorphous ? Chemical formula:  $3\text{SnSiO}_4 \cdot 2\text{SnO}_2 \cdot 4\text{H}_2\text{O}$  ? Apple green, with surrounding brown limonite. RI:1.70. SG:4.00. H:5. Found in the Arandis Tin Mine, Swakopmund District, South-West Africa.

**aranjados;** a Mexican name for cherry or honey opal from Querétaro, Mexico.

**araphite;** a very dark basalt, containing about 50% magnetite.

**arborescent;** generally the same as dendritic. The state of being tree-like, or branch-like, in form and



*arborescent  
aggregate.*

*After Sinkankas 1967*

appearance. → Dendritic.

**arborescent agate;** same as dendritic texture. In mineralogy for mineral having a branching treelike form. → Dendritic agate.

**arborescent texture;** same as dendritic agate.

**Arc Diamond;** the diamond of 381 cts, found 1921 in South Africa. Its present location is unknown.

**Archaean;** obsolete term for Archaeozoic.

**Archaean era;** the oldest part of the Precambrian era. Equivalent to the *pre-Cambrian era*.

**archaeological gemology;** the application of experimental procedures, especially of solution of problems. Archaeological gemology is a part of archaeological mineralogy, which studies discovery and production of stones used in man life as ornaments or personal properties.

**archaeology;** the study of human past cultures by scientific recovery and analysis of their remained materials.

**Archaeozoic;** of or formed in the early pre-Cambrian era.

**archaic;** pertaining to an earlier period. In gemology archaeological pieces of gem, this studies discovery and production of stones used in man life as ornaments or personal properties.

**archaic;** pertaining to an earlier period. For ancient

Chinese jades mean up to Wei Dynasty.

**archaistic;** a term used for jade production in ancient style.

**Archduke Joseph Diamond;** a finely colored, elongated, cushion shaped diamond of mixed cut of 78.54 cts. Once belonging to the Archduke Joseph of Austria, it was sold by Sotheby's in London in 1961. Its present owner is unknown.

**Archduke Maximilian of Austria Diamond;** (1459-1519) a traditional diamond engagement ring, made for his fiancée, Mar of Burgundy. A copy of this ring is in the Kunsthistorische Museum in Vienna. → Maximilian Diamond.

**archer ring;** a carved ring in form of an archer's bow made of jade frequently worn by Chinese instead as *kueh*. → Chinese ritual and symbol jades.

**Archimedes principle;** a law of physics stating that the apparent weight, loss of an object, or body, totally immersed in a fluid or water, is equal to the weight of the displaced fluid.

**Archipelago Islands;** a group of islands separates Greece from Aegean Sea (Turkey) in Mediterranean Sea.

**arciscuro;** same as carbonetto. In Italian, a color grade classification for very dark red coral.

**Arcot Diamonds;** two pear-shaped diamonds, together weighing 57.35 cts, (33.70 and 23.65 cts.). They were presented to Queen Charlotte, the consort of King George III of England, by the Nawab of Arcot from Madras, India, in 1777. In 1959, they were sold to Harry Winston, through Sotheby's, London. Present owners are unknown.

**Arctic Ocean amber;** along the shore of Arctic Ocean has been found amber which is dark in color and brittle used as substitute for ladanum or labdanum in perfumery industry and fixative. Plant of this amber was Old World Plants a *Cistus* genus known as rock rose.

**arculite;** crystallites grouped in a bow-shaped aggregate.

**Ardon ruby;** synthetic rubies, made by the Ardon Association Inc., in Houston and in Dallas, USA, which has marketed flux-grown rubies since the mid 1960s, under the name Chatham-Created ruby, and Kashan synthetic ruby.

**Area G.;** an historic local name, for five alluvial deposit districts, located along the Namibian coast, Africa. A gem-diamond bearing area, located to the north of the mouth of the Orange River.

**Area H.;** an abbreviation for Affenrücken, a gem-diamond-bearing area in Namibia, Africa, located along the north shore of Area G.

**Area K.;** an abbreviation for Kerbehuk, a gem-diamond-bearing area in Namibia, Africa, located along the northern shore of Area G.

**Area M.;** an abbreviation for Mittag, a gem-diamond-bearing area in Namibia, Africa, located along the northern shore of the town Oranjemund.

**Area U.;** an abbreviation for Uubvley, a gem-diamond-bearing area in Namibia, Africa, located along the northern shore of Area G.

**AREDOR;** an acronym for Association Pour la Recherche et L' Exploitation du Diamant et de L' Or.

**AREDOR Diamond;** the rough diamond of 181.77 cts, found in 1988 in the AREDOR in Guinea, Africa. Its present location is unknown.

**AREDOR Mine;** the alluvial diamond deposit in Guinea, Africa, near the borders of Sierra Leone and Liberia.

**arendalite;** a dark-green, massive, or crystalline epidote, from Arendal valley, in southern Norway

**arendalite;** a French name for garnetiferous rock.

**areng;** a Bornean term for a yellowish gravelly earth, sometimes containing diamonds.

**arenite;** same as psamite.

**arfvedsonite;** soda hornblende.

**argentan;** same as German silver.

**argentiferous;** a term applied to a substance which contains or pertaining silver.

**argentiferous galena;** galenite which contains more than 1 % silver.

**argentine;** a lamellar variety of calcite, with a pearly-white luster or essence d'orient.

**argentine;** containing or pertaining to or resembling silver.

**argentine plate;** → German silver.

**argentite;** an opaque mineral of  $2[Ag_2S]$ . Dimorphous with acanthite. Cubic crystal. Metallic luster. Black to lead-gray. Streak: lead-gray. Fracture subconchoidal. Very sectile. H:2-2.5. SG:7.2-7.4. Cleavage: (110) and (011). Found in Chile, Mexico, Bolivia, Germany, Czech Rep., England, Russia, USA and Norway. Also called silver glance, argyrite, argyrose, henkelite. Prized by collectors.

**Argentinean Gemmological institute;** → Primer Instituto Gemologico Latin Americano.

**argentoparcylite;** same as boléite.

**argillaceous;** a term applied to all substances or rocks, consisting of, or containing a notable proportion of clay in their composition. Argillaceous is recognized by the peculiar odor, emitted when breathed on it, which in mineralogy is known as argillaceous odor. Synonym argillic, argillous, clayey, pelolithic.

**argillaceous limestone;** same as argillocalcite.

**argillaceous marble;** same as clay-marble.

**argillic;** pertaining to clay, or clay minerals. → Argillaceous.

**argilliferous;** a term applied to abounding in clay.

**argilliferous;** a term applied to a produced clay.

**argillite;** a term applied to a massive, fine-grained, slate-like, rock from British Columbia. Also called haida slate and spelled as argylite.

**argillite;** a term applied to a massive hardened mudstone without cracks.

**argillous;** same as argillaceous.

**argon;** a colorless, odorless, monatomic, zero-valence, noble gas element, with the symbol Ar.

**argon laser;** same as argon ion laser. → Laser.

**Argyle Diamonds Mines Ltd.;** the world's largest diamond mine in north-western Australia, founded in 1894. In 1986, 29.2 million carats, were carried and in 1990, 35 million carats from Argyle.

**Argyle Kimberlite Number 1;** → AK-1 Pipe.

**Argyle Pink Library Egg;** an egg shaped object, set with ca. 20,000 diamonds, 348 cts, rose diamonds, and 15 kilograms (33 pounds) of gold. Inside, it is fashioned to look like a miniature library and portrait gallery. It was created for the Argyle Diamonds Mines Ltd.

**argylite;** a synonym for argillite

**argylite;** an obsolete term for orthoclase.

**argyrite;** same as argentite.

**argyrose;** same as argentite.

**arid erosion;** erosion or wearing away of rock due to the wind, which occurs in arid climates.

**ariolite;** an acronym for a mica-cordierite-hornfels rock.

**Arizona diamond;** a local, misleading term for a variety of quartz crystal, from Arizona, USA.

**Arizona peridot;** a variety of peridot, from Arizona, USA, found in small pieces.

**Arizona ruby;** a local, misleading term for the deep-red variety of pyrope garnet, from Navajo County, Arizona, and Utah, USA.

**Arizona spinel;** a local misleading term for the deep-red variety of pyrope garnet, from Arizona and Utah, USA.

**Arkansas Diamond;** the octahedron diamond crystal of a yellowish color weighing 17.00 cts, found in Arkansas. Now on display in the Smithsonian Institution, Washington, D.C., USA.

**Arkansas Diamond;** → Searcy Diamond.

**Arkansas diamond;** a local, misleading term for a colorless variety of quartz from Arkansas, USA.

**Arkansas diamond;** any diamond found in Murfreesboro, Arkansas any of in four pipes one of which is known as *the Crater of Diamonds*.

**Arkansas Diamond Co.;** a corporation producing diamonds, from Arkansas Diamond Mines.

**Arkansas Herkimer diamond;** a misleading term for a colorless quartz, from upstate New York, USA.

**Arkansas pearl;** a fresh-water pearl, from sweet-water rivers in Arkansas.

**Arkansas stone;** a whitish, gray, novaculite rock used

for sharpening tools, and as abrasive powder, from Ozark, Arkansas, USA. Used as a whetstone.

**arkansite**; a brilliant, iron-black variety of brookite, from Arkansas, USA.

**arkelite**; the cube phase of  $ZrO_2$ .

**Arkhangelsk**; the location of several kimberlite diamond deposits, on the White Sea, in the Russian Federation, CIS. Also spelled Arkhangel or Arkhangel'sk.

**arkose**; a pink or reddish or gray, coarse-grained, feldspar-rich sandstone, composed of angular to sub-angular grains, which may be either poorly or moderately well sorted. It derived from rapid disintegrations of acidic rocks with high-grade feldspars. The rock containing quartz and more than 25% feldspar. The feldspar is easily destroyed because chemical change or transportation.

**arkose-quartzite**; same as arkosite.

**arkosite**; a well cemented arkose or a quartzite with a notable amount of feldspars. Used as cladding stone.

**arkosite**; a well cemented arkose or a quartzite without interlocking grains. Also called arkose-quartzite. Used as cladding stone.

**arlequines**; from the French word, harlequin. In Mexico: precious opal.

**Armenian stone**; same as Lapis lazuli.

**Armenian stone**; an old term for azurite (copper hydrocarbonate).

**armlet**; an ornamental band, or bracelet, worn tied around the upper arm, produced in various forms, of different elements, possibly decorated with enameling and gems. → Bazu band

**Aroe pearl**; pearls from the Aroo Island, south of Dutch New Guinea. They are less silvery white as Australian pearls. Also spelled Aroo pearl or Aroo pearl.

**Aroo pearl**; → Aroe pearl.

**Arran**; locality for brown quartz, from Island Arran, England.

**arrojadite**; a dark-green phosphate of iron, manganese, etc. from Brazil. → Dickinsonite.

**arrow-head**; same as belemnite, thunder-stone.

**arrow points**; pointed Indian arrowheads, were mostly made from quartz, rarely of crystalline quartz, such as obsidian or other crystalline grained rock.

**arsenic**; a chemical element, existing in three allotropic forms; gray metallic or  $\gamma$ -arsenic, black or  $\beta$ -arsenic, and yellow or  $\alpha$ -arsenic. Chemical symbol: As.

**arsenical bloom**; same as pharmacolite.

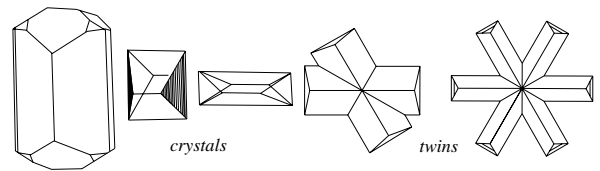
**arsenical iron**; same as arsenopyrite.

**arsenical pyrite**; same as arsenopyrite.

**arsenopyrite**; a fine, silver-white, or tin-white, to steel-gray mineral of  $FeAsS$ . Monoclinic pseudo-orthorhombic. Opaque. Metallic luster. Grayish-black

### *arkansite – artificial treatment*

streak. Twinned crystals are similar to staurolite, and in the form of cross. SG:5.92-6.22. H:5½-6. Frequently used ornamentally. Also called mispickel, white pyrite,



*arsenopyrite crystals and twins*

arsenical pyrite, arsenical iron, white mundic, bronce blanco, mispickel.

**artefact**; English spelling of artifacts.

**Artemicia dracunculus**; sometime beryl is engraved with an eagle or Artemicia dracunculus plants for magical spirits.

**Artha-Sastra**; ancient Sanskrit term for diamond.

**arthropods**; → trilobite.

**articulite**; an obsolete term for itacolumite.

**artifact**; English spelled of artefact

**artifacts**; any articles shape or made by human such as work of art, especially primitive tool and weapons of archeological interest. English spelled artefact.

**artificial coloration**; → artificial treatment of gem stones.

**artificial coloration of beryl**; artificial treatment or coloring of gemstones due to oiling, copper salts, acetate of copper, doping, or improving, etc.

**artificial corundum powder**; a commercial term for adamite.

**artificial crystal**; same as synthetic crystal.

**artificial gems**; same as artificial mineral.

**artificial heavy spar**; → blanc fixe.

**artificial ivory**; any substitute for ivory.

**artificial mineral**; a mineral formed artificially (synthetically) in the laboratory, as distinguishes it from a natural mineral. Same as artificial stone.

**artificial pearl**; same as imitation pearl.

**artificial pearl essence**; molded plastics, such as perspex or polystyrene, often used in the manufacture of inexpensive imitation pearls.

**artificial resins**; → resins,-artificial.

**artificial rock**; a term applied to synthetic rock.

**artificial spherulite**; a term applied to synthetic spherulite.

**artificial stone**; a stone formed artificially (synthetically), or imitated, in the laboratory. Same as artificial mineral. → Imitation, synthetic.

**artificial treatment of gemstones**; certain gems and

*Aru pearl - asmagarva*

ornamental stones treated to alter the color to made them more attractive, by means of heat, stain, chemical treatment and, the effects of exposure to radium emanations. For example, diamonds artificially pile-treated turn green, brown, and yellow. By treatment, the neutrons are uncharged particles in a cyclotron. Yellow and brown topaz are changed to pink, and brown zircons to blue, by heat treatment.

**Aru pearl;** → Aroe pearl.

**aruppukarans;** the gold-washing caste in Madras, India.

**As;** a chemical symbol for the element arsenic.

**asah;** a Myanmar (Burmese) name for third-water rubies.

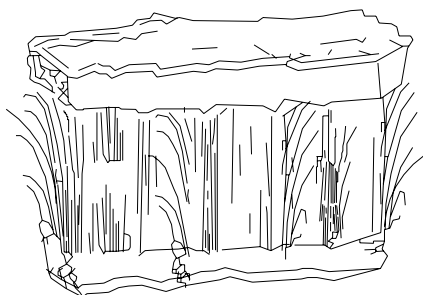
**asamm;** an Arabic term used by Masudi for fourth grade of emerald, which means matt or dull-emerald with pale color and less luster. → mor, bahri, and magrebi.

**asa-yo;** a Burmese term used for inferior mixed deep colored corundum stones up to 6 cts. → Corundum classification in Myanmar.

**asa-yo kya;** a Burmese term used for corundum inferior than asa-yo. → Corundum classification in Myanmar.

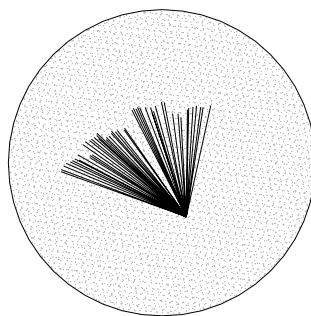
**asbestiform;** formed like, or resembling asbestos, a fibrous mineral.

**asbestos;** a commercial term applied to a group of



*asbestos. After Sinkankas 1967*

natural minerals, which can be separated into thin, long, flexible, heat-resistant fibers, such as actinolite, tremolite, chrysotile, and other amphiboles. Only



*asbestos as horsetail inclusions*

actinolite varieties are of gemological interest. The fine fibred asbestos found in green-gray quartz as an

inclusion has a cat's-eye effect, and containing crocidolite, a greenish-blue, fibrous variety of asbestos, is known as tiger's-eye. Synonyms: asbestus, amianthus, earth flax and mountain flax. → Tiger's-eye, cat's-eye.

**asbestos as an inclusion;** asbestos needles can be found as inclusion in garnets as horsetail.

**asbestus;** → asbestos.

**aschentrecker;** the original Dutch term, for tourmaline, given to the first imported minerals to Holland, from Sri Lanka. Meaning *ash puller*. This refers to the capacity for attracting ashes when being heated or cooled. Also called ash drawer, spelled aschtrekker, aschentrekker. → Pyroelectricity.

**aschentrekker;** → aschentrekker.

**aschistic rock;** usually a dike rock, with the same composition as the parent magma.

**aschtrekker;** → aschentrekker.

**ASEA;** an acronym for Allmana Svenska Elektriska Aktiebolaget.

**ash;** fine gray, dusty inclusion in diamonds.

**ash;** → volcanic ash.

**ash drawer;** same as aschentrecker.

**Ashberg Diamond;** the amber to light-yellow cushion diamond of 102.50 cts, (from South Africa ?), which once belonged to the Russian Crown. It was sold in 1959, in Stockholm, to Ashberg, a Swedish banker. In 1981, it was again sold by Christie's in Geneva. The present location is unknown.

**Ashoka Diamond;** the colorless, internally flawless, cushion-shaped modified brilliant-cut diamond, of 40.45 cts, from Golconda (now Hyderabad), India, named in honor of the King Ashoka Maurya, who ruled India from approximately 268-233 BC. The present owner is Harry Winston, New York, who purchased it in 1947.

**Ashover spar;** a local term, for full, yellow fluorspar, from Ashover, Derbyshire, England.

**Ashton Exploration Joint Venture;** the consortium formed in 1976, to prospect diamonds in Australia.

**Ashton Mining Ltd.;** the mining corporation with an interest in the Argyle Diamond Mines of Australia.

**ashtrays;** the simplest types of ashtrays used certain sorting stones, are merely slabs of rough stones, with unpolished top surfaces. Half-polished, completely polished or crudely, faceted tops are variations.

**asmagarba;** a Sanskrit term used in past in India for emerald.

**asmagarbhajam;** a Sanskrit term used in past in India for emerald.

**asmagarbham;** a Sanskrit term used in past in India for emerald.

**asmagarva;** a Sanskrit term used in past in India for



defect grading of sapphire. → Sapphire, defects of in Hindu.

**asmer**; an old Egyptian term used in past for transparent green stone or emerald?

**asoka tree**; a Hindu term for a kind of showy tree *Saraca indica* of the family *Leguminosae* with orange flower from tropical Asia, the leaf of this tree compare with a kind of spinel in Indian with the name sangandhike.

**asparagolite**; same as asparagus stone.

**asparagus stone**; a variety of transparent yellowish green apatite, found in Murcia province, Spain. Also called asparagolite, yellow-green apatite.

**asperolite**; a variety of chrysocolla, containing more water than usual chrysocolla.

**asphalt**; a general name for a dark-brown to black solid bituminous substances of natural occurrence formed in oily bearing strata by wearing away, usually through evaporation of the volatiles, consists almost entirely of hydrocarbonates. Some of them are used as an ornament stone. Asphaltum is a variety of asphalt.

**asphalt**; a viscous dark-brown to black liquid derived from distillation of oil.

**asphaltite**; a general term for a dark-brown to black colored, solid, naturally organic compounds such as albertite, anthraxolite, libolite, uintaite, gilsonite, grahamite, imposite and wurtzite. Some of them are used as an ornament stone.

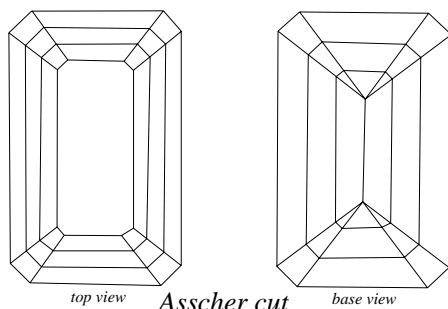
**asphaltum**; a variety of asphalt.

**assay**; to examination the proportion of a mineral or gem for composition, purity, weight and other properties of commercial interest.

**assaying**; analyzing the purity of a substance, such as an ore, or an alloy, by chemical analysis and other methods. Determination of the gold, silver or platinum content by percentage, by a standard.

**Asscher cut**; an emerald cut with wide corners.

**Asscher Diamond**; the colored, emerald-cut diamond of 12.97 cts, reported to have been cut by Asscher of



Amsterdam, Holland.

**Asscher Diamond Company**; → Royal Asscher Diamond Company.

**Asscher Diamond Maatschappij**; → Royal Asscher Diamond Company.

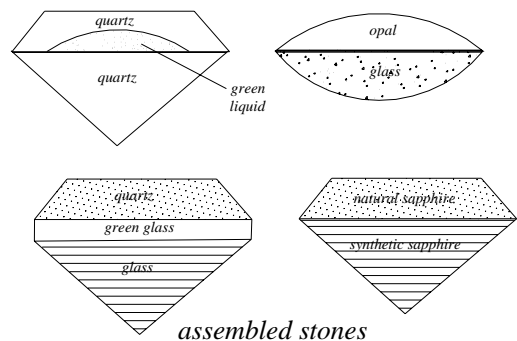
**Asscher, Joseph**; the world famous Dutch diamond cleaver from Amsterdam, who cleaved the Cullinan Diamond in 1908 and the Excelsior Diamond in 1903.

**Assegai**; a small alluvial diamond mine in South Africa.

**assembled cameos**; cameos, made of two or more pieces of natural stones, cemented together.

**assembled imitation cameos**; cameos, made of two or more pieces of imitation material, such as glass or plastic, which have been cemented together.

**assembled stone**; a gem, constructed of two or more pieces of material, which may genuine crystal, or simulated crystal, cemented or otherwise, joined together. Generally described as doublets, and triplets.



Also called composite stone.

**assimilation**; incorporation of foreign material such as wall rock in magma. Partial or entirely melting may occur at contacts which causing changes in composition of the original magma. Such magma may lead to hybrid or contaminated rocks. Also called digestion, dissolution, magmatic assimilation, magmatic dissolution, magmatic digestion.

**assize**; a term applied to a cylindrical block of stone which forming part of a column.

**Associação Brasileira de Gemologia**; Headquarters for this Society are located at: Caixa Postal 18154, San Paulo, S.P., Brazil.

**association**; to link or connect for formation of groups of molecules in a chemical bond or in a gemstone.

**Asociación Española de Gemología**; Headquarters for this Society are located at: Paseo de Gracia, 64 Ent. 02A, Barcelona, Spain.

**Association Française de Gemmologie**; Headquarters for this Society are located at: 17 Rue Cadet, 75009, Paris 9, France.

**Association pour la Recherche et l'Exploitation du Diamant et de l'Or (AREDOR)**; an organization with intrests in the diamonds and gold of Guinea.

**assynite**; a foyaitic plutonic rock consisting largely of orthoclase and pyroxene, rich in sphene containing augite, sodalite, nepheline and apatite among the

accessories.

**asteria**; a precious stone, which, when cut *cabochon* in the correct crystallographic direction displays a four, six, or twelve-rayed star by either reflected or transmitted light, due to asterism. Star ruby, star sapphire, rose quartz, garnet are samples. Also called star stone.

**asteriated**; like a star. A mineral or gemstone that exhibits asterism.

**asteriated agate**; same as star agate.

**asteriated beryl**; a variety of beryl having asterism in thin sections. Star beryl is a misnomer.

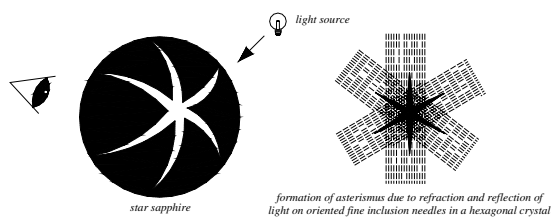
**asteriated quartz**; a variety of quartz, having whitish, or colored radiations.

**asteriated sapphire**; same as star sapphire.

**asteriated stone**; a stone, which exhibits a star, by either reflected or transmitted light. Star ruby, star sapphire, rose quartz, petrified wood-star and garnet star are examples.

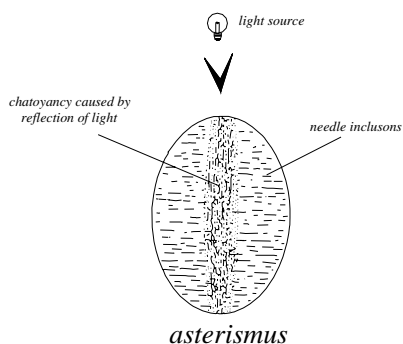
**asteriated topaz**; a misleading term for asteriated, yellow corundum. Wrongly called oriental topaz.

**asterism**; an optical phenomenon where-by starlike rays of reflected light are observed on the surface of some gems or minerals, when cut *cabochon*, and viewed in reflected or transmitted light, from a certain direction.



formation of asterism and star sapphire

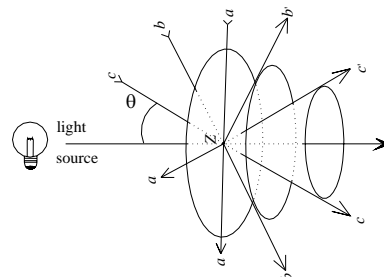
Caused by the presence of minute, almost microscopic, inclusions, arranged in a regular (generally in three identical crystallographic directions as hexagonal) series, parallel to the prism face, in some varieties of



asterism

gemstone referred to as *silk*. A cabochon cut from such a stone exhibits a ray of light on the surface of mineral

perpendicular to each parallel set of inclusions. This three cut directions with chatoyancy effect known as asterism such as in rubies and sapphires. In rubies and sapphires, the microscopic rutile inclusions are responsible for these effects are arranged in two or more intersecting bands of light, which radiate from a bright center. In the case of the 6-rayed *star*, it is the



forming of asterism on surface of a gemstone due to conical reflection of light

presence of fine parallel fibers or crystal inclusions or channels at 60° angles to each other. The star can be observed when the stone is cut cabochon, with the top of the dome perpendicular to the included structure, viewed from a certain direction using a strong, single, reflected light source. The stars display 4-ray, 6-ray, 8-ray or 12-ray figures, which are observed in some gemstones, especially in the star ruby, and star sapphire. Some almandine display asterism with 6-rayed star. Pale rose or rose quartz sometimes exhibits asterism because of tiny sillimanite or other included needles, which are oriented 120° by hexagonal system. Phlogopite a brown variety of mica exhibits a 6-rayed star (sometimes 12-rayed) in transmitted and reflected light because of oriented rutile needles. Any gemstone that shows asterism is known as an asteria. → Epiasterism and diasterism.

**asteriated stone**; stone with a star effect, when cut cabochon. → Asterism.

**asterite**; a French term for star quartz.

**astite**; an acronym for mica-andalusite-hornfels.

**A. Steyn Diamond**; the diamond of 141.25 cts, found in 1912 on the Vaal River, Cape Province, South Africa. The present location is unknown.

**Astor Sancy Diamond**; → Sancy Diamond.

**Astoria diamond**; a small diamond mine in the Orange Free State of South Africa.

**Astoria Sancy Diamond**; → Sancy Diamond.

**Astrakhan**; a fine marble, from Astrakhan, the Russian Federation, CIS.

**astralite glass**; same as aventurine glass or goldstone, which is produced artificially.

**astridite**; an ornamental stone of dark green, chrome-rich, jadeite, intergrown with picotite, quartz, opal, and limonite from New Guinea. SG:3.35. Named after

Astrid of Belgium.

**astrilite**; a commercial term for the artificial diamond simulant lithium niobate.

**astrology and gemstones**; most of gemstones and some rocks have been related astrological signs from ancient times and partly today. Believingly celestial bodies were or are considered to impart their powers to certain stones such as birthstones. A gemstone that has been associated, by superstitions and religious tradition as appropriate to the time or month of one's birth.

**astrumite**; a commercial term for gray-green Tibet stone.

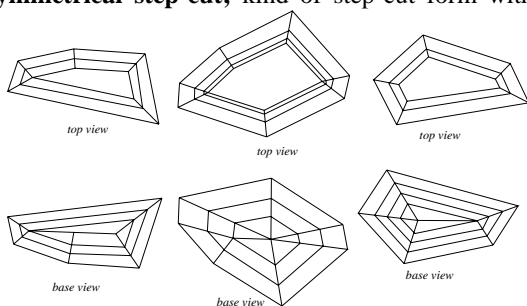
**astryl**; a commercial term for synthetic rutile, a diamond simulant.

**asura**; an old Sanskrit term for demon, nearly the same word in old Persian, Ahura or Ahura-Mazda, means God.

**asymmetrical**; same as not symmetrical. Meaning irregular crystal or, without the proper proportion of parts, such as in triclinic crystals.

**asymmetrical crystal**; an irregular crystal or, without the proper proportions of parts, such as triclinic crystal system, referred to three axes of different lengths.

**asymmetrical step-cut**; kind of step-cut form without



*asymmetrical step-cuts. After Fischer 1989*

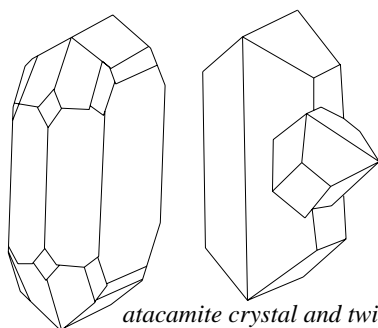
any symmetry actually belonged to the fancy cuts.

**asymmetric class**; the class of crystal, which form without any symmetry.

**asymmetric system**: → triclinic system.

which are not to right angles to each other.

**atacamite**; an emerald-green, dark-green, orthorhombic mineral  $\text{Cu}_2\text{Cl}(\text{OH})_3$ . Dimorphous with paratacamite.



*atacamite crystal and twin*

Vitreous to greasy luster. Transparent to translucent.

*astrilite – atomic plane*

Emerald-green streak. H:3-3.5. SG:3.80. Cleavage (010) imperfect. Stalked aggregate. Formed by weathering of copper lodes. Found in Chile, Italy, South West Africa and Australia. Also called remolinite.

**Atahualpa Emerald**; the emerald from the Andes crown, weighing 45 cts, set in the central arch beneath the apex. → Crown of the Andes.

**Atax ypsilophorus**; a minute parasite worm, which may cause irritation in a mollusk and form a *blister*, when introduced between the shell and mantel, or, a *pearl sac* which produces a *cyst pearl*, when introduced into the mantle. Also, the trematode worm has the same effect.

**athaibouk**; a Myanmar (Burmese) term applied to  $\frac{3}{4}$  cts, rubies.

**Atharva-Veda**; → Veda.

**Atlantis stone**; same as larimar.

**atlas ore**; a misleading term for malachite.

**atlas pearl**; a misleading, commercial term for beads made from white satin spar (or atlas spar), from Alston Moor, Cumberland, USA.

**atlas spar**; same as white satin spar. Fibrous variety of calcite, aragonite and gypsum, which can be, stained various colors. Also called atlas stone.

**atlas stone**; same as white satin spar.

**atmospheric pressure**; the pressure per area unit exerted at the surface of the Earth. One atmosphere is equal to the pressure exerted by a 760 millimeter column of mercury.

**atom**; according to atomic theory, the smallest particle of an element, which remains unchanged during all chemical reactions. The smallest particle of an element, which enters into the composition of a molecule. Although partly composed of electrical units, such as electrons, protons, etc. Complete atoms are electrically neutral.

**atomic bond**; the attraction exerted between atoms and ions, formed by the interaction of valence electrons from each.

**atomic diamonds**; diamond, synthetically colored by bombardment with atomic particles, or nuclear rays.

**atomic distance**; the distance between two atoms from center to center.

**atomic configuration**; → configuration of atoms.

**atomic number**; the number of protons (the positively charged mass units) in the nucleus of an atom of each element. Used in the periodic classification of the elements. Atomic number is denoted by the letter Z.

**atomic particle**; one of the fundamental components of which an atom is constituted, such as an electron, neutron or proton.

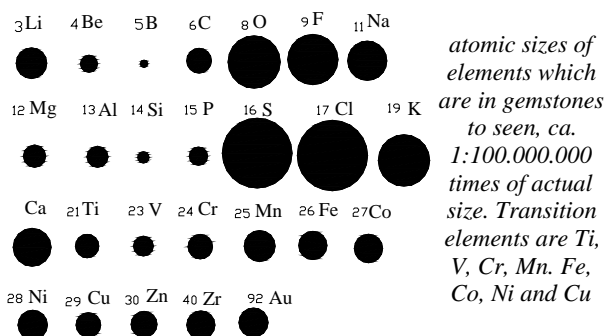
**atomic pile**; former name for nuclear reactor.

**atomic plane**; any plane formed during the growth of a

*atomic radius - augite*

solid crystal atoms arranged themselves in an orderly pattern.

**atomic radius;** the radius of an atom, or, the average



distance from the center, to the outermost electron, of a neutral atom.

**atomic reactor;** → nuclear reactor.

**atomic structure;** the arrangement of atoms in a substance, as in crystal in minerals. → Crystal structure.

**atomic volume;** the space occupied by a quantity of that element, as compared with the atomic weight. Measured by atomic weight of an element, divided by its density. Also called specific volume.

**atomic weight;** the average atomic weight of an element, a standard, compared with the weight of an atom of oxygen, taken as 16.00.

**atom physics;** a branch of physics science which primary devoted to the study of the structure and energies of atoms and molecules and interaction of radiant energy with matter. Industry enhancement of gemstones is caused by irradiation by atomic physics.

**atoms, impurity;** same as impure atoms.

**atramental stone;** an obsolete term for vitriol. Same as ink stone.

**atramentum (stone);** an obsolete term for vitriol. Same as ink stone.

**attached crystal;** a crystal or mineral, attached to the its mother rock.

**attal;** a term applied to reject rocks or accumulated waste.

**attraction, magnetic;** also called magnetic attraction. → Magnetism.

**attapulgitite;** same as palygorskite.

**attractiveness;** having the qualities to influencing the interest, pleasure, and affection senses of the observer.

**attrition;** reduction process by which detrital pieces of stone are wearing down during transportation.

**attrition milling;** a size reduction process, by which pieces of diamonds placed in rotating drums, with water and pebbles, or steel balls, after a certain time they are reduced in size. Also known as ball milling. → Abrasive test.

**atwe;** a Burmese term used for impure and rough corundum stones. → Corundum classification in Myanmar.

**Au;** a chemical symbol for the element gold. (Latin: Aurum).

**aubergine purple;** a ceramic color containing manganese, used for under glaze decoration.

**Aubrey's miscellanies;** a crystal gazing expert (1696) who describes such a crystal must be a perfect sphere in diameter of clear crystal material.

**Aucamp Weiveld;** a small location of an alluvial diamond mine in the Cap Province of South Africa.

**Auchas;** a small location of an alluvial diamond mine on the Orange River in Namibia, Africa.

**Auckland Diamond;** the cone-shaped diamond of 36 cts, from India ? Named after George Eden Auckland, Governor General of India from 1836-1842. Its description is identical to the Holland Diamond. → Bantam Diamond.

**Auckland shell;** a variety of pearl-oyster, with a green-edge nacre, from Auckland, Pacific Ocean.

**audio conduction detector;** → conduction detector, audio.

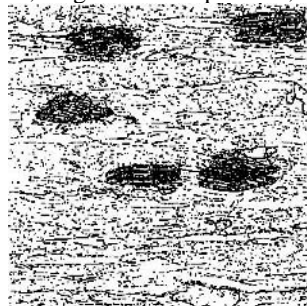
**auganite;** a term applied to augite-andesite.

**augelite;** a rare, massive, transparent, colorless, white to pale red, or yellow mineral. Chemical formula:  $\text{Al}_2(\text{PO}_4)(\text{OH})_3 \cdot 3\text{H}_2\text{O}$ . Monoclinic system. Vitreous, pearly luster. Optics; a:1.574, b:1.576, g:1.588. Birefringence: 0.014-0.020. Å. SG:2.70-2.75. H:5. A collector's gemstone. Found in USA, Sweden and Bolivia.

**Augen;** a German term for eyes, referring to eye-like structures, inclusions, or crystals, in minerals.

**Augen agate;** same as Aleppo stone.

**augen-gneiss;** a general term for a coarse crystalline rock, of granitic composition, containing of eye-shaped



*augen gneisses*

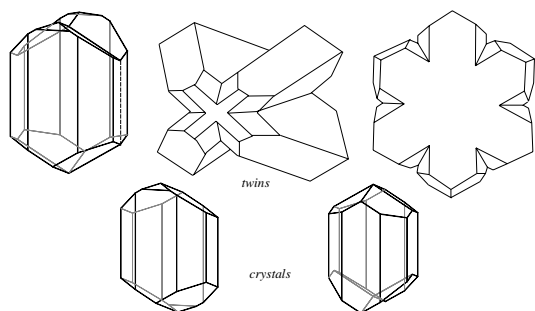
feldspar, or quartz minerals, embedded in a finer groundmass.

**augite;** one the family of inosilicates (single-chain) minerals of the pyroxene group. Cut as faceted gems and prized by collectors. An obsolete term for basaltine. System: monoclinic.

Formula:  $4[(\text{Ca},\text{Na})(\text{Mg},\text{Fe},\text{Al})(\text{Si},\text{Al})_2\text{O}_6]$ .

Luster: vitreous to dulls.

Colors: pale brown to dark brown, or purplish brown, greenish to black.



*augite or pyroxene crystals and twins*

Streak: none or colorless.

Diaphaneity: translucent to nearly opaque.

Cleavage: {110} good, {100} parting {010} distinct but variable.

Fracture: uneven to conchoidal. Brittle.

SG: 3.23-3.52.

H: 5-6.

Optics:  $\alpha$ : 1.671-1.735,  $\beta$ : 1.672-1.741,  $\gamma$ : 1.703- 1.761.

Birefringence: 0.018-0.033.  $\ominus$  or  $\oplus$ .

Found in all localities. Also called basaltine.

**augites**; a term used by Pliny some authorities believes it mean a variety of beryl.

**Augustus the Strong**; a Duke of Saxony (1670-1733), who has of a large historic collection, which included the Dresden Green, Dresden White, and many others, were supposedly more than 7000 old carats in weight. Augustus the Strong started the collection. They are now on display in the Green Vaults (Grüne Gewölbe) in Dresden, Germany.

**auhunga**; a Maori term for pale-green variety nephrite between kawakawa and inanga from New Zealand. → Pounamu.

**auralite**; altered iolite.

**Aurangzib Topaz**; Tavernier reported from an Indian cut topaz of 157.25 Florentine carats. Belonged to Aurangzib, son of Shah-Jahan, India? It was seen by Tavernier in 1631-1668.

**auras of energy**; → lithotherapy.

**aureole**; a decorative, almond-shape, or halo-like shape, around a sacred person or figure. Also called mandorla.

**aureomycin antibiotic**; → antibiotic aureomycin.

**aresina marble**; a misleading term for a monochromatic, grayish-colored fossilized marble, from Istria, Croatia.

**aureus**; same as golden, which is used for golden beryl.

**aureus color**; same as golden color that means golden beryl, which is in fifth place with the symbolic Leo.

**auric**; same as auriferous.

**auriferous**; containing gold. Gold-bearing ore. Synonym aurigerous.

**auriferous aluvium**; same as alluvial gold.

*augites – Australian opal*

**auriferous deposit**; gold bearing lodes, placer, and sediment such as sand, gravel, etc.

**auriferous gravel**; same as alluvial gold.

**auriferous placer**; same as alluvial gold.

**auriferous pyrite**; a misleading term for pyrite, meaning carrying gold, probably in solid solution, no of commercial value

**auriform**; shell-shaped, like the human ear.

**aurigerous**; same as auriferous.

**aurora**; → corona.

**Aurora Australis**; → north light, Aurora Borealis.

**Aurora Borealis**; a commercial term for glass, which has been coated with a very thin, iridescent layer, usually of fluoride, sputtered on in a vacuum, to create a colorful effects. In Roman times, it was called white nights. Also called Aurora Borealis stone, nature's neon signs.

**Aurora Borealis**; same as north light.

**Aurora Borealis stone**; Rhinestone whose color is produced by an extremely thin iridescent layer on its facets. → Aurora Borealis.

**Aurora collection**; the collection of 244 colored diamonds, amassed by diamond dealer Alan Bronstein, named after the Aurora Borealis. It is on exhibit at the American Museum of Natural History, New York City, USA.

**auroral displays**; → Aurora Borealis.

**aurora red**; a term described the color of yellowish-orange to brownish-red.

**aurous**; containing gold. Gold-bearing ore. Same as auriferous.

**Australia**; the island-continent, southeast of Asia with the world's major diamond production since 1851. Nearly the entire production is of industrial quality.

**Australian Diamond Exploration Joint Ventura**; the diamond exploration corporation if Australia, managed by Ashton Mining, Ltd. Abbreviation: ADEX.

**Australian emerald**; any light-green beryl, or dark variety of emerald, from Emaville, New South Wales, few of fine color have been found. Also from Poonah, Western Australia, and other localities.

**Australian Gemmological Association**; → Gemmological Association of Australia.

**Australian jade**; a misleading term for jade-green variscite from Brisbane, Queensland, Australia. It is also found in Spain.

**Australian jade**; a misleading term used for jade-green chrysoprase.

**Australian jade**; a misleading term used for jade-green chalcedony. Also called Queensland-jade.

**Australian jasper**; a jasper with red-speckles light gray flecked, from Australia.

**Australian opal**; any opal from Australia, but usually

the term is restricted to only black opal. Usually, cut in flat, polished slabs, with beveled or perpendicular sides, instead of in cabochons. SG: 2.12.

**Australian pearl;** a commercial grade, including, a fine, silvery white from both; (a) the *Meleagrina margaritifera*, which is found in the waters of Australia, and (b) the *Meleagrina maxima*, of the northwest coast of Australia, which yields most of the Broome pearls. All these pearls are much whiter and have less orient, than the Celebes pearls, the Manila pearls and others, from Australia.

**Australian pearl;** a geographical classification: any pearl from Australian waters, including the yellowish Shark's Bay pearl.

**Australian ruby;** a misleading term for a reddish variety of garnet.

**Australian sapphire;** an olive green, or bluish-green, sapphire from Australia. The blue variety is usually very dark-greenish or blackish.

**Australian sapphire;** a commercial term for dark-blue or blackish sapphire.

**Australian turquoise;** a misleading term for variscite, from Brisbane, Queensland, Australia. Also, found in Spain.

**Australian zircon;** a red, brown and yellowish gemstone quality of zircon from Queensland, Australia.

**australite;** jet-black glass, or tektite pieces, usually button-shaped or lensoid, found in southern Australia (New South Wales), Victoria and Tasmania. → Tektite, queenstownite, darwinite, billitonite.

**Austrian Diamond;** same as the Florentine Diamond.

**Austrian emerald;** cloudy to opaque, green to dark-emerald green, or light green in color, sometimes irregularly distributed. Rarely used as gems. Occurrence and inclusions are similar to Russian emeralds. Found near Salzburg, Austria.

**Austrian Gemmological Association;** → Erste Österreichische Gemmologische Gesellschaft.

**Austrian Imperial Crown;** a gold circular crown, made in 1602 in Prague for Rudolph II, King of Hungary and Bohemia. The crown is mounted with number of precious stones, including diamonds, sapphires, pearls, etc. Now on display in the Schatzkammer of the Hofburg at Vienna.

**Austrian Yellow;** → Austrian Yellow Diamond.

**Austrian Yellow Brilliant Diamond;** the citron-yellow, oval gem cut similarly in style to a rose cut. Not to be confused with the famous yellow Florentine Diamond. There are no historic records of this brilliant. → Austrian Yellow Diamond.

**Austrian Yellow Diamond;** same as *Tuscany* or *Florentine Diamond*. the citron-yellow diamond of 137.27 cts, in weight, from India, it was cut in the form of a nine-rayed briolette, passed into the possession of

the Austrian Royal House in 1743, through marriage and then disappeared, at the time last Emperor went into exile. Not to be confused with Austrian Yellow Brilliant Diamond. Also called Austrian Yellow.

**authigene;** any mineral, formed or occurring, in the place found.

**authigenic minerals;** minerals, formed on the spot, within sediments or sedimentary rocks, during or after their deposition.

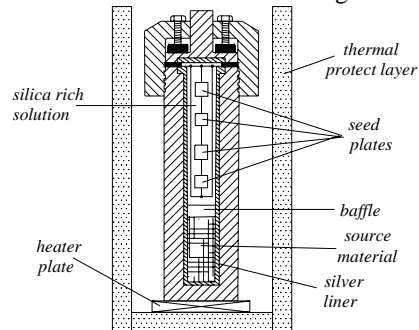
**authigenic overgrowth;** growing of a certain crystal over the surface of another crystal of not similar composition within sediments or sedimentary rocks, during or after their deposition. → Distaxy, epitaxy, Lechleitner synthetic emerald.

**autochrome;** a color photographic glass plate for photography used starch particles dyed red, green, and blue coated with a layer of dye, which looked as a transparency.

**autochthonous;** formed or occurring in the place where it is found. *In situ*. → Allochthonous.

**autogenetic inclusions;** those inclusions formed from the same magma, or mother-liquor, as the enclosing stone. Also called cognate inclusion, cognate xenolith.

**autoclave;** a thick-walled, steel vessel, usually silver-lined built to withstand high temperatures and



*sketch of a silver-lined autoclave for production of hydrothermal grown quartz.*  
After Webster 1994

pressures, mostly used in the hydrothermal method of producing synthetic crystals.

**autolith;** an inclusion formed from the same magma or mother-liquor as the enclosing rock. Also called cognate inclusion, cognate xenolith.

**automatic blocking machine;** a stone holding device, used in gem cutting for placing the table and 8 facets, on a diamond of brilliant cut, four on top, four on the bottom. → Blocking.

**automatic bruting machine;** a machine for producing the girdle of round brilliant. A rondisting machine. → Bruting.

**automatic dop;** a semi-automatic, grinding machine, with a mechanical stone holder. Used mostly for polishing small gemstones. → Automatic blocking machine.

**automatic polishing machine;** an automatic polishing machine, for faceting round brilliants. Also used for

blocking, cross-work, brilliandeer, and polishing the table. → Blocking, bruting, polishing, and fashioning.

**autometamorphism;** changes in the chemical composition of igneous minerals or rocks, due to falling temperatures created by the action of its own volatiles, such as the serpentinization of peridot, the spilitization of basalt.

**autometasomatism;** changes occurring in a solidified igneous rock due to residual water-rich, liquid fraction, from the parent magma, trapped within the recently crystallized rock, generally, by an impermeable, chilled border.

**automolite;** a dark, to nearly black variety of gahnite (spinel).

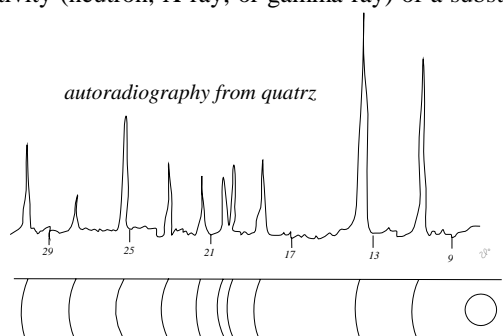
**automorphic;** synonym for idiomorphic. → Euhedral.

**automorphic crystal;** same as euhedral crystal.

**autopneumatolysis;** autometamorphic changes at the autopneumatolitic station of a cooling magma to 400-600° C.

**autoradiograph;** → autoradiography.

**autoradiography;** a method of scanning the radioactivity (neutron, X-ray, or gamma-ray) of a substance,



where the specimen is placed on a sheet of photographic, sensitive plate. The picture serves to locate the position of the radioactive element or composition. → Radiograph.

**autotrophs;** → photosynthesis.

**aventurin;** German spelling for aventurine.

**Avarka;** a Sanskrit term used in past in India for defect grading of sapphire. → Sapphire, defects of in Hindu.

**Ave;** each group of ten, minute beads made of gemstone or other materials, on a rosary, used for counting prayers Ave Maria. Also called a decade.

**aventurescence;** the term used to describe the effect of internal plates, or flakes of mica, hematite, or other minerals, in aventurine, aventurine feldspar, etc.

**aventurin;** German spelling for aventurine.

**aventurine;** some translucent gemstone containing coarse, very thin, opaque, sparkling particles of foreign minerals which exhibits bright or colored overall glittery effect or aventurescence, from minute, crystals, platelets, flakes, or scales of other minerals such as aventurine quartz, aventurine feldspar, bloodshot and

### *autometamorphism - aventurine*

labradorite feldspar which contains elemental copper. The name was derived from Italian term for accident or change, may dropped some copper platelets in vat of molten glass known as *goldstone* glass. When the inclusions are of very thin as hematite flakes or goethite or both with metallic sheen known as *sunstone*. Also spelled *avanturine*, *adventurine*. Synonym: *aventurine quartz*. Frequently called *regal*. → *Aventurine quartz*, *aventurine feldspar*, *bloodshot labradorite feldspar*.

**aventurine;** a venturine feldspar (oligoclase feldspar), due to the inclusion of red, orange, or green, very thin flake crystals of hematite, or goethite, or both, which causes the specular reflection of golden or brownish-red color. Also spelled *avanturine*, *adventurine*. Found in Norway and Russia. Frequently called *regal*. → *Aventurine quartz*, *aventurine feldspar*.

**aventurine feldspar;** a gemstone variety of feldspar (oligoclase, albite, andesine or adularia) characterized by a reddish luster, produced by fiery, golden reflections, or fire-like flashes of color, from numerous, thin, small but visible, disseminated mineral particles (such as flakes of hematite), oriented parallel to structurally defined planes, and probably formed by exsolution. It is usually cut cabochon. Also called *sunstone*. → *Aventurine*.

**aventurine glass;** a glass mass, containing tiny, platelike, copper crystals, to produce (melted under special conditions), an imitation of the yellow and red aventurine quartz. An alternative name for this imitation is *gold stone*. Now made in a blue color.

**aventurine glazes;** transparent glazes, containing thin platelike (green or gold), crystals or spangles, in a glassy matrix. Ferric, chromium and copper oxides are used in these glazes, to imitate sunstone and sometimes lapis lazuli, when made of blue, opacified glass. Also called *goldstone glaze*.

**aventurine quartz;** an opaque to translucent, green, gray, reddish-brown, or golden-brown variety of quartz, exhibiting a schiller. Contains small flaky crystals of either mica, or iron-oxide impurities. Some green of



*copper scales in aventurine-glass*

those colored minerals are similar in appearance to green jade and others to malachite. They are most

*Avicula* – axis of symmetry

frequently cut cabochon, and used for rings, brooches. Opaque, larger pieces are carved into vases, bowls, etc. The green-colored stone, resembling malachite or jade, is hence sometimes misleadingly termed *Chinese jade* or *Indian jade*, and mostly carved in China. Found in Brazil, Spain, Chile, Russia, Germany, China, India, and elsewhere. → Aventurine, aventurine feldspar.

**Avicula**; a pearl-bearing genus of salt-water, bivalve's mollusks.

**Aviculidae**; a family of pearl-bearing, salt-water, bivalve mollusks with pearly interiors, found in warm water. → Pteriidae, Malleidae.

**aviolite**; a type of mica-cordierite hornfels, from Monte Aviole, Italy.

**avocado cut**; a drop-cut form similar to avocado, polished without facets used as pendant.

**Avoirdupois, weight**; the system of weights use in English-speaking countries used other than for gemstones and precious metals, equivalent to 28.35 grams or 141.75 cts.

**ivory**; a commercial term for a cryptocrystalline, cellulose, polymer, used as an ivory imitation.

**awa**; a Burmese term used for large and defect corundum stones. → Corundum classification in Myanmar.

**awabi**; → awabi pearl.

**awabi pearl**; a Japanese term for a single-shelled, vividly colored, green, blue, and yellow-colored abalone pearl. Found in the *Halitidae univalve* salt-water mussel, off the Gulf of California, along the coasts of Florida (USA), Queensland (Australia), Korea, and Japan. This may produce iridescent, vividly-colored, baroque pearls. Also called awabi.

**axe god**; any artifact, fashioned of translucent jade, or axe stone, in pre-Columbian jewelry, most often, used as a pendant.

**axe stone**; a synonym for nephrite axe material from New Zealand, which the natives call *punamu*, sometimes spelled *pounamu*. Also called New Zealand greenstone, Maori jade, or Maori stone. → Mere, hei tiki.

**axes**; (plural of axis) crystallographic directions through a crystal. Lines of reference, intersecting at the center of a crystal, around which a body or system is considered to rotate. → Crystallographic axis, axis of symmetry.

**axial angle**; optical angle in crystallography.

**axial color**; same as extreme color.

**axial plane**; a plane of the optical axes of in optically biaxial crystal, which includes two of the axes.

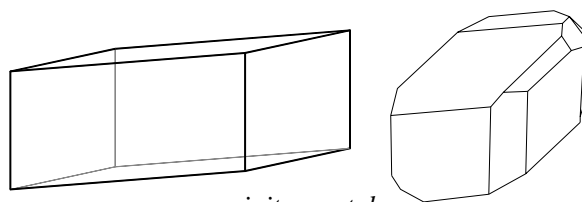
**axial symmetry**; same as axis of symmetry.

**axinite**; a rare, complex, borate, silicate mineral. Rarely cut as gems or carved, but prized by collectors.

System: triclinic.

Formula:  $4[\text{Ca}_2(\text{Fe}, \text{Mg}, \text{Mn})\text{Al}_2\text{B}(\text{OH}, \text{O})(\text{Si}_2\text{O}_7)_2]$ .

Streak: none.



*axinite crystals*

Colors: colorless, brown, honey-yellow and violet.

Luster: vitreous.

Diaphaneity: transparent to translucent.

Fracture: uneven to conchoidal. Brittle.

Cleavage: 010 distincts.

SG: 3.3.

H: 6-7.

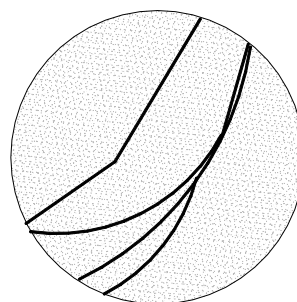
Optics;  $\alpha$ : 1.677,  $\beta$ : 1.684,  $\chi$ : 1.687.

Birefringence : 0.010-0.012.  $\ominus$  may be also  $\oplus$  if contain Mg.

Dispersion : highly.

Found in France, Brazil, Tasmania (Australia), Ottawa (Canada), Pennsylvania, New York, and California (USA), and Mexico.

**axinite inclusion**; in some samples there are seen



*goethite needles in axinite*

needles of goethite.

**axiolite**; a variety of elongated spherulite arranged at right angles to a central axis.

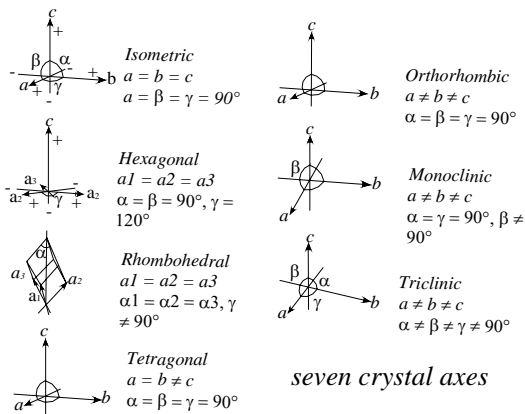
**axis**; → crystallographic axes.

**axis of a crystal**; same as crystallographic axes. → Axis of symmetry.

**axis of symmetry**; an imaginary line, passing through the center of a crystal, about, which the crystal is symmetric. The term applied to all crystal classes, while the 7-crystal system is based upon the axes. Symmetry of axes are: *Twice*; two-fold, half-turn or diagonal axis. *Three times*; three-fold, one-third-turn or trigonal axis. *Four times*; four-fold, quarter-turn or tetragonal axis. *Six times*; six-fold, one-six-turn or hexagonal axis. Also called symmetry axis, axial



symmetry.



**auxochromes;** a radical or group of atoms added into dye compounds to increase the coloring properties. Its presence enabled a colored organic substance to be retained of matters.

**axon;** a process of nerve fiber of a neuron that conducts impulses from the nerve cell body. → Eye

**ayan nat thwe;** a Myanmar (Burmese), term, for the perfect octahedral crystal of spinel, found in Mogok.

**ayr stone;** a soft, fine-grained stone, used in the form of a flat lap in polishing marble, and giving a fine surface to metalwork, especially made of brass and steel, or other non-ferrous metals. It is a whetstone. Also called scotch stone, bluestone.

**ayr stone;** also known as fluorite, which is found in Ayrshire of Great Britain. It has a roughly shape.

**azabache;** a term used in Spanish language for jet which may be is a Farsi name (an Iranian term for Azara-Padegan or Azar-Pad, where the eternal fire for Zoroastrian adherent was protected and also made fire from this coal-variety, also the term means fire protector ?). Also in different part of Spain is spelled as azebiche, acabaig. In Portuguese called azeviche.

**azabache;** a Spanish-Mexican term for jet.

**azabache compacto;** a term used in Spain for jets sale to tourist in Santiago for good luck charms.

**Azar-Pad;** an old Farsi (Persian) term meaning fire protector.

**Azara-Padegan;** an old Farsi (Persian) term meaning fire protector.

**Azhari;** a term used in Nishabur turquoise mine for fine and dark color but not like Abu-Eshaghi. → Turquoise classification in Nishabur, Iran.

**azo-dye;** a term used for a large group of an organic dyes, which have  $-N=N-$  as a chromophores group. Obtained from amino compounds by diazotization and coupling. It is subdivided as monoazo, diazo, trisazo and tetrazo.

**azorite;** an altered term, sometimes used for zircon.

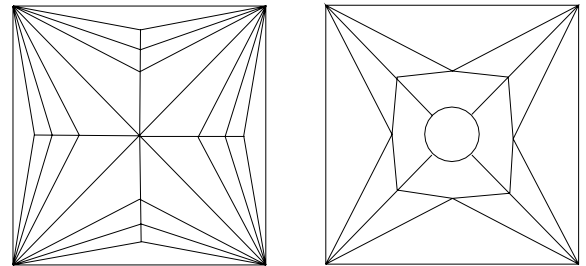
**azotic;** containing nitrogen or nitrogen-bearing. A

French term for nitrogen.

**Aztec cut;** a modified square cut with four rayed step star on the crown. 28 facets on the crown and 16 facets with a circular culet on the pavilion.

**Aztec Eagle Opal;** same as the El Aguila Aztec Opal.

**Aztec jewelry;** jewels made by the Aztec Indians in the era of pre-Colombian jewelry. Common Aztec articles are: gold necklaces decorated with precious stones,



*Aztec square-cut. After Schmitz*

gold animals, gold fish, bracelets, ear-rings, and other ornamental pieces.

**Aztec stone;** a local term for greenish smithsonite.

**Aztec stone;** a local term for green turquoise.

**Azul Macauba marble;** a misleading term for white marble, veined with a vivid blue. Found in Brazil. Blue color is due to sodalite.

**azules opal;** a term applied to the pale, water opal that has a few red and green flecks.

**azulinhas;** Brazilian term for small, cloudy sapphires found with diamonds.

**azulite;** a translucent, pale-blue variety of smithsonite. Found in Greece and Arizona, USA.

**azurchacedony;** chalcidony, colored blue by chrysocolla. Used for gems.

**azure;** same as lapis lazuli.

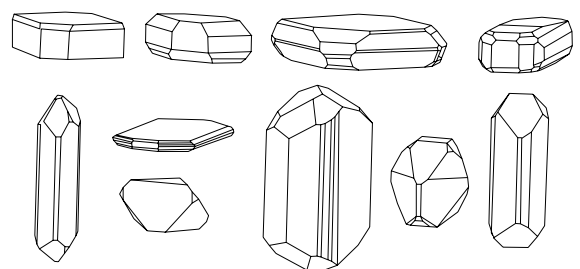
**azure blue;** → cobalt blue.

**azure malachite;** same as azurmalachite.

**azure quartz;** a confusing term for a blue variety of quartz, sapphire quartz, or crocidolite. Also called siderite.

**azure spar;** same as lazulite.

**azurite;** a semitransparent, to opaque, blue hydro-



*azurite crystals*

carbonate of copper. It occurs in botryoidal, or

*azurite - azurstone*

stalagmitic masses, and is often intimately associated with malachite. Cut cabochon or as flat topped gems. Burnite is a rock, composed of a mixture of malachite, azurite and cuprite. Also called chessylite. The mixture of azurite and malachite from the Copper World Mine in Barstow, Las Vegas, USA is given the name *royal gem azurite*. Pleochroic in blue under LWUV and SWUV.

System: monoclinic.

Formula:  $4[\text{Cu}_3(\text{OH})_2(\text{CO}_3)_2]$ .

Luster: vitreous.

Colors: blue, dark blue to violetish-blue.

Streak: blue.

Diaphaneity: semitransparent to opaque. Pleochroism.

Fracture: conchoidal. Brittle.

Cleavage: 011 perfect, {100} fairly, and {110} in trace.

SG: 3.75 - 3.89.

H: 3 - 4.

Optics;  $\alpha$ : 1.730,  $\beta$ : 1.758,  $\gamma$ : 1.836.

Birefringence : 0.110.  $\oplus$ .

Found in Russia, Chile, Congo, Mexico, South-West Africa, New Mexico and Arizona (USA).

**azurite**; a commercially misleading term for blue smithsonite.

**azurite**; a misleading term for synthetic blue spinel.

**azurite**; a misleading term sometimes used for blue malachite, to distinguish it from normal, or green malachite.

**azurlite**; same as azurhacedony. Chalcedony, colored by chrysocolla, found in Arizona.

**azurite malachite**; same as azurmalachite.

**azurmalachite**; an ornamental stone consisting of intergrowths of concentric bands of azurite and malachite in a compact form.

**azuromalachite**; same as azurmalachite.

**azurstone**; same as lapis lazuli.

# B b

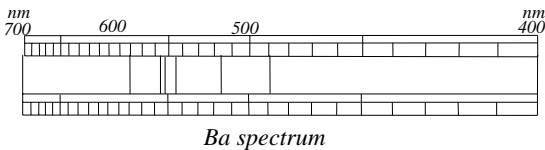
*b*; a symbol for one of the three crystallographic axes, with the subscript 0, noted as  $b_0$ . The letter “*b*” usually appears in italics.

**b**; abbreviation for a bar, a unit of pressure.

$\beta$ ; beta, symbol for phase constant.

**B**; a chemical symbol for the element boron.

**B**; one of the Fraunhofer lines in the red area of the solar spectrum, its wavelength is 687.00 nm, due to absorption by the earth’s atmosphere.



**Ba**; a chemical symbol for the element barium.

**Babel quartz**; a variety of quartz, named for its fanciful resemblance to the successive tiers of the Tower of ancient Babel. Also called Babylonian quartz.

**Babylon beryl**; a variety of beryl produced in ancient Babylon of pale green color, but not as fine as Indian beryl. Also called Babylonian beryl.

**Babylonian beryl**; same as Babylon beryl.

**baby**; a slang, digger’s term for a rocking sieve used for separating diamonds and gold from worthless material, invented by Babe, Jermoe L. Also called Yankee baby, baby rocker.

**baby rocker**; → baby.

**Baby Rose Diamond**; → Premier Rose Diamond.

**Babylonian quartz**; also called Babel quartz.

**bacalite**; a variety of amber from Baja, California and Mexico.

**bacillite**; a rodlike, crystallite, composed of a number of parallel, longulite aggregates.

**back**; in gemology, same as pavilion.

**backing**; diamonds, those pale colored or inferior quality gemstones are backed with colored foil or thin metal leaf, to impart or improve color, brilliancy or both. Same as chatons. Also called imitation, foil-back, foilback.

**backing beryl**; foil backing of beryl with highly

polished green foil to improve or heighten the color. Green foil is made from an alloy of fine copper 10 carats, silver 6 carats and gold one carats. → Imitation, foil-back, foilback.

**backing gemstones**; same as backing.

**back off**; a modern drilling technique, which consists of an automatic device and a double drill. Both drills are introduced from opposite ends and work towards the center. When one drill reaches a certain distance from the other it will back off/reverse to make it possible for the opposite drill to continue drilling without collision/encountering the other drill.

**back ornament**; an ornament made from a human skull, by the Mixtec Indians of Mexico during the Aztec era. The skull was covered with a mosaic of turquoise, lignite, shell, pyrites, etc. and worn by men.

**bacon stone**; an old term for a variety of steatite, alluding to its greasy appearance.

**bacon stone**; a term used in Bristol, England, for calcite, colored with iron oxide.

**bacor**; a Russian, corundum-zirconia refractory most often used in the glass industry. Also spelled bakor.

**Bactria**; an ancient country of SW Russia, NE of Persia.

**Bactria emerald**; according to Theophrastus emerald from Bactria, (an ancient country of SW Asia, NE of Persia) because emerald was imported from Ancient Izumrud in Scythian or Bactria to other locality of ancient world, also to Egyptian. Also spelled Bactrian emerald. → Emerald,-names of.

**Bactrian emerald**; same as Bactria emerald.

**Bactria stone**; according to ancient Egyptian records, a term for emerald from Bactria (an ancient country of SW Asia, NE of Persia).

**baculite**; a term applied to a crystallite which appears as a dark rod.

**bad**; a term used for a gem of inferior quality or having some feature that causes blemishes.

**Badakhshan**; a district of Afghanistan. Also called ballas, Belagius.

**Badakhshan lapis**; deep, violetish-blue, to green lapis lazuli from Faizabad, the Badakhshan district, Afghanistan. Also from Khorg and Russian Badakhshan. → Afghanistan lapis.

**bad back**; a term applied to a stone of opal that has no sufficiently back, which may be cracking and crumbling caused by over cutting of stone, rock or potch.

**baddeleyite**; a naturally stable counterpart of cubic zirconia. The synthetic cubic zirconia is used as a diamond imitation and marketed as djevalite, in Russia, as phainite or phainitex, and, in England, as Windsor Gem. A fibrous variety is known as brazilite.

System: monoclinic.

Formula:  $4[\text{ZrO}_2]$ . It may contain some titanium, hafnium, thorium and iron.

Luster: greasy to vitreous.

Color: colorless, pale yellowish, green, brown red and black.

Streak: white to brownish by dark crystals.

Diaphaneity: transparent to translucent.

Cleavage: {001} perfect, and {010} imperfect.

Fracture: subconchoidal to uneven. Brittle.

SG: 5.74-5.82.

H:  $6\frac{1}{2}$ .

Optics;  $\alpha$ :2.130,  $\beta$ :2.190,  $\gamma$ :2.200.

Birefringence: 0.070.  $\ominus$ .

Dispersion: 0.060.

Found in Brazil, South Africa, Sri Lanka, Italy, USA, Austria, Russia, Canada, and Zaire (Africa).

**Baden Solitaire Diamond**; the diamond of 30 cts, which belonged to the Austrian Royal Family, at the time they went into exile. It was mounted in the clasp of a necklace, which contained 114 pear-shaped diamonds.

**Bad Hope**; a small, alluvial diamond mine in the Cape Province, South Africa.

**bad-sandstone**; a term used by Australian miners for sandstone by which experienced miners due to certain geological properties recognized little or no valuable opals. The contrast term is good or good-sandstone.

**Baffa diamond**; a local, misleading term for a variety of quartz crystal from the island of Cyprus.

**baffle**; a metal plate in an optical instrument, which is inserted into a wave-guide. It control, which is reduced the cross-sectional area when filtering waves for conversion purposes. Also called baffle plate.

**Bagagem**; location of diamond deposit in southwest Diamantina, Minas Gerais, Brazil. The Star of the South, which weighed 261.24 cts, and was from Bagagem.

**Bagillion cut**; a rectangular baguette with a brilliant-cut pavilion.

**Bagos de Arroz**; a Spanish-Brazilian term for a class of long, flat and thin, rough diamonds. Literally it means bag of rice.

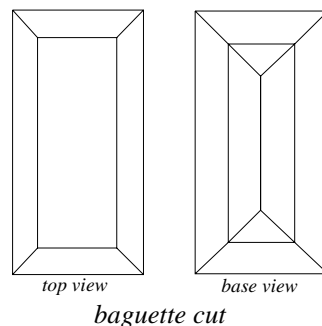
**bagshot diamond**; misleading term for quartz crystal, from England.

**bague**; French term for a ring.

**baguette**; a French term for rod, or a long stick of bread. A style of step-cutting used for small, narrow, rectangular-shaped gemstones, principally used for small diamonds and emeralds.

**baguette**; a term often applied to a cushion-shaped cut, by dealers in the colored stone trade. Also spelled baguette cut and called baton.

**baguette cut**; a modern cut for small-trap stones set next to rectangular-shaped stones with parallel facets. Also



called baton and baguette.

**bahamite**; fine-grained, high purity, massively bedded limestone without abundant fossils from Bahamas, USA.

**bahani**; a Hindu term for concealing the flaws by gem cutters or by setters. The word meaning improvement?

**Bahia**; a gem-bearing district in Brazil.

**Bahia**; also, a term for diamonds from this districts.

**Bahia amethyst**; a local term for a variety of amethyst from Bahia, Brazil.

**Bahia emerald**; a term applied to a light yellowish-green variety of beryl, from Bahia, Brazil.

**Bahiahini**; one of the diamond companies in the Metropolis of Ghana, is licensed by the government of Ghana to buy diamonds from native miners in Ghana, Africa.

**bahiaite**; a pyroxenite, containing amphibole, orthopyroxene, olivine and a small amount of ceylonite.

**bahias**; a term sometimes used for diamonds, of inferior, color grade or form from Bahia, Brazil.

**bahri**; an Arabic term used by Masudi for second grade of emerald, which means sea-emerald (aquamarine color), with the color of young leaves which grow upon the tip of stems of myrtle. → Asamm, mor, and magrebi.

**baht**; a weight unit for precious metals, used in Thailand equivalent to 15.29 grams.

**Baikal lapis**; deep, violetish blue to green lapis lazuli from Baikal, the Russian Federation, CIS. → Badakhshan lapis.

**baikalite**; a dark-green variety of diopside, found near the Baikal Lake, the Russian Federation, CIS.

**Baja amber**; a source of fossil resin amber in California, USA.

**bajadèrs**; Indian term for small ribboned pearls.

**Bajhur**; an Indian term used for green and black color stone which frequently mistaken for epidote or zabarjad and emerald from Egyptian.

**bajhur**; a term was used in Egypt for a green stone mixed with black, mistakenly believed to be zaberjad or emerald.

**bajoobund**; a corrupt spelling of bazu band.

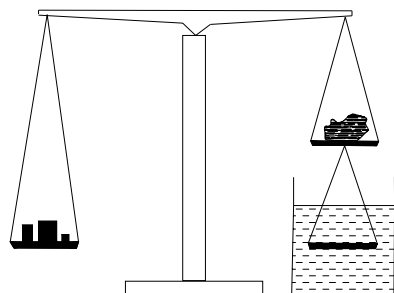
**bakelite**; a colorless, synthetic resin or plastic, made of phenol or cresol, sometimes used in the imitation of gems and jet. It can be stained various colors. Bakelite is non-flammable, not dissolved in common solvents. It is not as hard as some other plastics, and it is marketed as an amber simulant. There are two types of bakelite; (a) a condensation product of phenol (carbolic acid) and formaldehyde. RI:1.54-1.70. SG:1.25-2.00, clear types 1.25-1.30. (b) The other is known as amino plastics. Where urea replaces phenol in the composition it is transparent and accepts dyes of various colors. RI:1.55-1.62. SG:1.55. H: 2. It is easy to distinguish by its smell, when a hot needle is pressed against it.

**Bakerville**; a small alluvial diamond mine, in the Lichtenburg area, Transvaal, South Africa.

**bakor**; same as bacor.

**Bakwanga**; alluvial diamond-bearing area of the Lubilash River, in Zaire. → Lubilash, Mbuji-Mayi.

**balance**; a scale or an instrument used to determine specific gravity and to weigh gemstones. Primary



a common hydrostatic balance

function is to compare two masses. Some examples of balances are in use: Westphal, Hanneman, aperiodic, diamond, chemical, etc.

**balance bucket**; a container used by Australian miners for balancing so that he is able to raise or lower himself in the shaft. Now moderately used ladders and winches.

**Balas**; an old local name (Balascia) for Badakhshan Region, Afghanistan.

**Balas**; a local term for a red, rose-red, or sometimes an orange variety of spinel, from the Badakhshan district, Afghanistan, where the gem is found. Same as Balas ruby.

**balas**; a Brazilian term for parti-colored tourmaline, from which the outer layers have been removed, to improve the color and clarity.

**Balas ruby**; a misleading term for red, rose-red or sometimes an orange variety of spinel, found in Balas or Badakhshan (or Balascia) in northern Afghanistan. It is too easy to distinguish from ruby, by its single refraction and lack of dichroism. Sometimes spelled Ballas or misnomered as Balas. → Balas, ruby spinel, pink spinel.

**Balboa Topaz**; a medium-blue, irradiated, pear-shaped Brazilian topaz of 4500 cts. It was cut from a rough stone of 10.715 cts. Now on display at Sa Diego Museum, USA. Found in 1978.

**Bal de Feu**; a commercial term for synthetically formed strontium titanate, which is used as a diamond simulant.

**bal ironstone**; same as nodular iron ore.

**Bali**; a Myanmar (Burmese), weight equal to 58.18 cts, (64 ratis).

**balias ruby**; an old misleading French term for ballas ruby.

**ball bracelet**; bracelet of one or two strands of hollow beads or spheres. Also used for earring designs.

**ball chain**; a chain, made of tiny hollow metal beads or spheres, linked together.

**ball ear-ring**; → ball bracelet.

**ball jasper**; brown to red jasper, found in spherical masses.

**ball jasper**; jasper appearing in concentric bands of red and yellow.

**ball pearl**; the round pearl, found in inland rivers of the USA.

**ballam (pearling ship)**; a Farsi term for pearl-fishing boat in the Persian Gulf.

**ballas**; alternate spelling for balas ruby.

**ballas (diamond)**; the term ballas, was first applied to stones from Brazil, however diamonds of similar structure known as Cape, and African ballas, are found. An important, very hard, industrial variety of multicrystalline diamond. The stones are spherical aggregates of minute, diamond crystals, arranged more or less radially. They have no well-defined cleavage planes and thus, have great resistance to abrasion. Found in Brazil and Africa. Spherical white, or grayish diamonds, which have cleavage planes are often also called *ballas* although a more correct term for them is *bort*. Used in industry as an abrasive and for rock drills. Also called bort beads, spherical bort, shot ballas, shot boart, round bort.

**ballas (diamond)**; an incorrect term for a round, single-crystal form diamond.

**ballaur**; another spelling of the Farsi (Persian) term bolur for quartz.

**ballerina setting**; the term is derived from the effect, which takes place, when radially mounted baguette diamonds surround a central stone in a setting. It has an effect of the dressing-gown, or skirt of a ballerina.

**ball-and-stick**; → illustration of crystal structure.

**ball lightning**; a slowly moving luminous ball nearly in a foot diameter, sometimes can be seen during a thunderstorm.

**ball milling**; same as attrition milling. → Abrasive test.

**balsam of fir**; same as Canada balsam.

**ballur**; another spelling of the Farsi (Persian) term bolur for beryl.

**ballur**; another spelling of the Farsi (Persian) term bolur for quartz.

**balstone**; a nodule, or large, crystalline mass, of fine, unstratified limestone, containing coral in the position of its growth, surrounded by shale and impure, bedded limestone, such as the limestone of Shropshire.

**Baltic amber**; a commercial jewelry term for succinite, from the shores of all countries on the Baltic Sea, which contain at least 3-8% succinic acid.

**Baltic amber coast**; the shores of all countries on the Baltic Sea, which contain succinite ambers. The wave's action on the shoreline cliffs loosened amber particles and carried away to the sea and buried in the seabed.

**baltic red**; same carmen red.

**baltimorite**; a grayish-green, fibrous, silky, splintery antigorite (serpentine), from Maryland. Synonym: picrolite.

**bamboo**; a cane-colored, porcelain biscuit.

**bamboo coral**; a commercial term for coral suitable for jewelry, which is fished from the waters of Tasmania, Australia and has a similar structure to bamboo.

**bamboo pearl**; a misleading term for tabasheer found in certain species of bamboo.

**bamboo shoots**; across the expanse of Siberia, emerald forms in cracks, which have the appearance of bamboo, shoots.

**bamboo ware**; yellow-colored, wedgwood ware similar in color to bamboo.

**banco**; a Spanish term meaning sandbank. A term applied to the plane charge caused by a stream channel in a flood plain, cut from hillsides, which the emerald mines of Colombia are located. Same as shoal bench, sandbank.

**Banaganapalle conglomerate**; a village of old working diamond mines found in the conglomerate basal member of the sedimentary.

**band**; stripes of a different color, and thus, of a different composition in a rock. Banded rocks exhibit these patterns, usually uniformly. Occasionally ornamented.

**band**; a term applied to a wedding rings.

**band**; in spectroscopy, compactly-packed, spectral lines that appear like a continuous band. → Band spectrum.

**band**; sometime applied to bracelets.

**band**; a term used by Australian miners for opal-bearing sandstone stratum which containing some opal above and below of them.

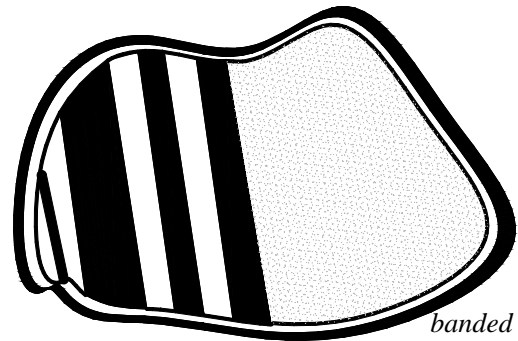
**band boulder**; a term used by Australian miners for opal-bearing band boulder, which can be found at the bottom of sandstone in Queensland opal pipe.

**bandeau**; a type of jeweled ornamental band, worn by women around the head.

**banded**; the appearance of a mineral or a rock having alternating thin and nearly parallel bands of different colors, perhaps of different materials. Also called banded mineral or banded rock.

**banded**; the appearance of a patch opal in alternating of tow thin and nearly parallel bands of different colors, most frequently black and white.

**banded agate**; in banded agate, various colors are arranged in delicate, parallel, alternating bands or stripes. these may occur in various thicknesses. these



*banded agate*

bands readily take different artificial dyes. Sometimes straight, but often are wavy, or zigzag, occasionally the bands are formed in concentric circles. The bands may be sharply demarcated or blend imperceptibly into one another. Banded agate occurs in silica-rich environments, such as in irregular cavities of rocks, where they take on concentric forms. → Agate, onyx, chalcedony and chalcedony onyx.

**banded hematite-quartzite**; a term used in Australia and India for iron formation. → Banded quartz-hematite.

**banded ironstone**; a term applied in South Africa for the appearance of an iron oxides and chert formation having alternating nearly parallel bands of brown, red and black colors.

**banded jasper**; a term applied to a variety of jasper, showing a banding similar to agate, frequently in brightly distinct colors. Also called striped jasper, jasponyx, ribbon jasper.

**banded limestone**; a term used for a parallel limestone, with frequently irregular, colored bands.→ Banded.

**banded marble**; a term used for a parallel marble, with frequently irregular, colored bands.→ Banded.

**banded mineral**; → banded.

**banded obsidian**; a term used for obsidian, with frequently irregular, colored bands.

**banded opal**; a term applied to a variety of layered opals of different colors or opal alternating with any other matrix or minerals.

**banded quartz-hematite;** same as itabirite. → Banded hematite-quartzite.

**banded rhodochrosite;** rhodochrosite is usually banded as stalactitic, stalagmitic aggregate. Attractively banded



*banded rhodochrosite under microscope*

in various shades of pink and white. It occurs together with braunite and bixbyite found in Kalahari Desert, Cape Province, South Africa. Cut cabochon, and into bead-like articles..

**banded talc;** banded talc or marble frequently used in Thailand as the nuclei of cultured pearls.

**Bandeirantes;** a Brazilian term for the gold diggers, who first discovered diamonds, close to Diamantina, Minas-Gerais.

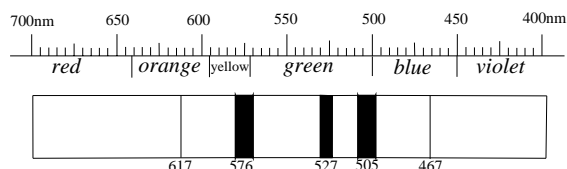
**bandelette;** a type of ribbon, jeweled with pearls, coral, amber, etc. worn by women in their hair.

**band gap;** a term used for energy difference between two bands of electron energy in some metals. Also called energy gap.

**band-gap impurity color;** including blue diamond due to boron, yellow diamond, green diamond due to nitrogen.

**Bandjermasin;** a city in Borneo, Indonesia, where there are some minor diamond deposits.

**band matrix;** a term used by Australian miners for opal-bearing band matrix, which occurs with band boulder opal and mixed with ironstone, found in Queensland.



*a band spectrum of almandine*

**band spectrum;** a molecular optical spectrum that appears to be a number of bands. This is because of the array of intensity values in the spectrum, which occurs over broad ranges of wavelengths of the ordering

variable. An optical band spectrum arises mainly in molecular transitions. Continuous spectrum. Also called molecular spectrum. The band spectra sometimes are called *swan spectra* according to spectra, which when arise from molecules. A band spectrum consists of fine lines, which are wide apart at one end and closer at the other end so that they appear to be one dense line at the head.

**bandstone;** a term used by Australian miners for hard thin banded ferruginous siliceous material from White Cliff, Australia containing more or less opal. Also called casing, cement, cement band, concrete, steel band.

**band theory;** a quantum-mechanical theory of the moving or delocalizing of free electrons within crystals, metals or solids that predict certain bands of the energies of metal electrons. Bands are caused by conversion of atomic orbitals (minimum four atoms), into molecular orbitals or bands, which is called conduction bands. → Band theory in metals.

**band theory in metals;** electrical conductivity of metals is a quantum-mechanical theory which assumed that the valence electrons of the atoms in a metal were able to move electrons freely through entirely of metal, acting as a *free electron gas*. Also called *Drude theory*, who introduced this theory and later *Drude-Lorenze theory*. → Band theory.

**Banffshire;** the name of a locality, which is the source for serpentine in England.

**Bangkok;** good quality rubies, mostly darker in color than Myanmar (Burmese), stones, found near Bangkok.

**Bangal amethyst;** a misleading term for violet corundum. Purple sapphire.

**bangle;** a hollow or solid wire bracelet.

**Banjan Diamond;** the Indian diamond of 48.50 cts, bought by Tavernier, a French traveler and jeweler who visited in India in 17<sup>th</sup> century, it was later sold to a Dutch Sea Captain.

**Banjarmasin;** location of diamond deposits in the state of Kalimantan, Indonesia.

**Banjarmasin Diamond;** the octahedron diamond of 70 cts, from Banjarmasin, Indonesia (1836), which was taken to Holland in 1859 and cut into a 40 cts, squared brilliant. Now belongs to the Rijksmuseum in Amsterdam.

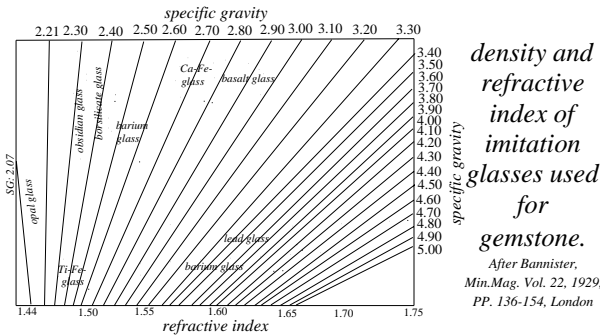
**Bank Kha Cha sapphire mine;** a sapphire gem bearing district in Chanthaburi province of Thailand.

**banks;** → paar (oyster beds).

**Bannister's graph;** a chart for determining the composition of imitation, glass gems. Bannister's graph is based upon the relation of the constant of a given glass, to that of silica glass. It identifies the composition of a glass using its refractive index and, specific gravity

or density.

**bantam**; a term used by South African diggers for any



mineral that indicates the presence of diamonds found in that area. → Bantams.

**Bantam Diamond**; a name of the diamond that Tavernier the French traveler reported having seen in 1648 in India, mounted on the dagger of Radja Bantam. Weight unknown. It may be The Holland Diamond. → Auckland Diamond.

**bantams**; small pebbles of banded garnet-quartz rock. They are usually associated with diamonds as they are obtained frequently when washing diamond-bearing gravel from the Vaal River, South Africa. → Bantam.

**Banya Irang**; location of an alluvial diamond deposit in the Danau Seran swamp, Indonesia.

**hapabolam**; a Sanskrit term used in past for emerald beryl.

**bar**; a term used by Australian miners for solid pieces of opal color, which crossed through patch.

**bar**; a C.G.S. unit of pressure equal to  $10^6$  dynes/sqcm or  $10^5$  Pascal's, approximately 750 mm Hg (mercury) or 0.987 atmosphere.

**barchan**; → barkhaneh.

**barranca**; may be a Farsi (Persian barran-câr, barran-câve) name for rain-water cut or in England chine. And the term cavidan meaning excavate, to dig.

**baprabalam**; a Sanskrit term used in past for emerald beryl.

**baraket**; same as bareketh.

**baraketh**; same as bareketh.

**Barbados earth**; a deposit of fossil radiolarians from Island Barbados of West Indies.

**Barbara beryl**; beryl from near Barbara, in the northeastern Transvaal, South Africa.

**Barbara Heliodora**; the topaz of 62.75 cts, named in honor of Barbara Heliodora.

**Barber's Diamond**: same as Koh-i-Nûr Diamond.

**Barbertonite**; a dimorphous mineral with stichtite.

**barchane dune**; → barkhaneh.

**barchaneh**; → barkhaneh.

**barkhaneh**; a Farsi (Persian), term meaning sandy

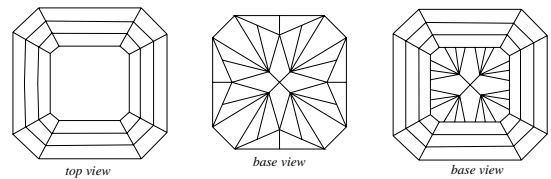
stone (size), of intermediate quality, sky-blue dendritic turquoise, from Khorassan, in NE Iran, which is divided into four categories, mostly used for inlaying and incrusting jewelry, *bazu band* (armlets), trappings, water-pipe, etc. Another spelling is barchaneh, barkhan or barchane. → Turquoise classification in Iran.

**Bardiglio marble**; a blue Italian limestone obtained near Montalto, on the southern borders of Carrara, Tuscany also known as bleu belge marble and bleu turquin marble, a French terms which are for Bardiglio marble.

**bareket**; same as bareketh.

**bareketh**; a biblical term meaning lightning bolt, which refers to the third stone in the breastplate of the High Priest. Generally, equivalent with the emerald or beryl, but more common possibly could refer to amazonite, a green feldspar. Engraved with the name Levi. Also spelled bereketh, baraketh, barket, baraket, and called carbuncle, flashing stone.

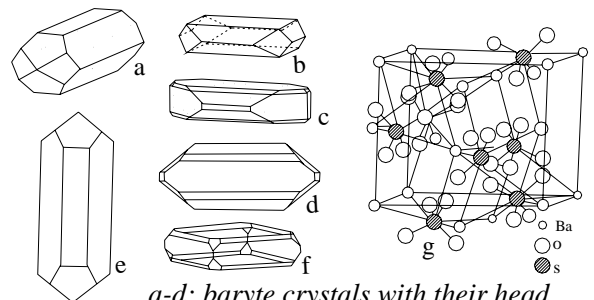
**Barion cut**; a modern style of a fancy square-shaped, mixed cut. The fancy name of a diamond style designed and introduced in 1971 by Basil Watermeyer. It was



*Barion cut or square step-cut with two different pavilion*

derived from a full emerald-cut crown, and brilliant-cut pavilion, with 62 facets (culet included), which has 4 half-moon facets, parallel to the girdle, and 4 smaller facets, that form a cross on the pavilion, when viewed through the table. It was intended to improve the brilliance and retaining maximum weight. The term was formed from the name **Basil** and that of his wife **Marion**.

**barite**; a soft mineral, rarely used for faceted gems, and



*a-d: baryte crystals with their head forms and f: crystal structure*

of a little interest to collectors. Frequently, light blue or



green it has phosphorescent and fluorescent effects under UV light. Also spelled barytes, barytine, barytite, and called barium sulfate, heavy spar. → Barite rosette.

System: orthorhombic.

Formula:  $4[\text{BaSO}_4]$ .

Luster: vitreous to resinous.

Streak: white.

Colors: colorless, white, gray, reddish, pale-yellow, brown, greenish or blue.

Diaphaneity: semitransparent.

Cleavage: {001} perfect, {210} distinct, and {010} imperfect.

Fracture: uneven. Brittle.

SG: 4.30-4.60.

H: 3-3.

Optics;  $\alpha$ :1.636,  $\beta$ :1.637,  $\gamma$ :1.648.

Birefringence: 0.012. ⊕.

Dispersion: 0.016.

Found in Colorado, Missouri, South Dakota, the USA, British Columbia, Ontario (Canada), the Czech Republic, and England.

**barite cut**; a soft mineral, rarely used as faceted gems which is of little interest to collectors, but, brown stalagmitic or stalactite, varieties with a concentric structure, are fashioned as an ornamental objects. Some massive minerals have a slight chatoyancy.

**barite luminescence**; white or blue-green under SWUV ray. Greenish-white, cream-white pinkish-white under LWUV ray.

**barite pleochroism**; pleochroism is weak. Brown crystal shows yellow, straw, vein-yellow and violet. Yellow crystal: weak yellow and yellowish-brown. Green crystal: colorless, violet and weak-green.

**barite rose**; same as barite rosette.

**barite rosette**; a rosette-like cluster aggregate of large, tabular, sand-filled barite crystals. Usually formed in sandstone and in the desert. Frequently prized by collectors. Synonyms are barite rose, rosette, and petrified rose.

**barium**; a silvery-white, heavy metallic element of the alkaline earth's (II group), of the Periodic System with the symbol Ba.

**barium aluminate**; the gray, powdery, mass with the chemical formula  $3\text{BaO} \cdot \text{Al}_2\text{O}_3$ , is soluble in water. Used in the ceramics industry.

**barium carbonate**; same as witherite.

**barium chromate**; a heavy, yellow, crystalline powder with the chemical formula  $\text{BaCrO}_4$ . Used in ceramics manufacturing.

**barium crown glass**; an optical glass, containing a substantial quantity of barium oxide.

**barium feldspar**; the collective name for barium-bearing feldspars, such as celsian and hyalophane.

**barium flint glass**; an optical glass, containing a

substantial quantity of barium oxide. Used rarely in the manufacture of imitation stones.

**barium fluoride**; the chemical composition  $\text{BaF}_2$  melts at  $1280^\circ \text{C}$ . Used as a flux and as an opacifier, in enamel frit and spectroscopy.

**barium glass**; a highly refractive glass, in which the BaO replaces part of CaO formula in ordinary lime soda glass, so as to increase the specific gravity and brilliance.

**barium platino-cyanide**; a paper coated with barium platino-cyanide, which was once used in laboratory experiments of X-rays.

**barium sulfate**; same as barite.

**barium titanate**;  $\text{BaTiO}_3$ , this light-gray chemical composition is made synthetically by the Czochralski method. Cubic, also tetragonal and hexagonal in system. RI:2.40. SG:5.90. H:6-6. Sometimes cut as gemstone, or used as a transducer in ultrasonic cleaning instruments, or in a ferro-electric ceramics.

**bark**; the outside or skin portion of elephant tusk.

**barkan**; a Chaldeic term for emerald.

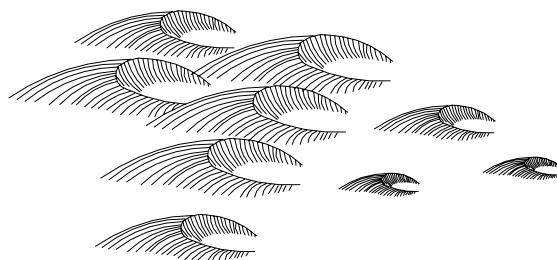
**barket**; same as bareketh.

**barkta**; a Chaldeic term for emerald.

**barkhan**; → barkhaneh.

**barkhaneh**; a Farsi (Persian) term for sky-blue dendritic turquoise, from Khorassan, NE Iran. Another spelling is barchaneh, barkhan or barchane.

**barkhaneh**; a term applied to barchane dune a concave



*barchan of sand dune*

to leeward form. Also spelled barchan, barchaneh.

**Barkly Breakwater Diamond**; the diamond of 109.25 cts, found in 1905, at Barkly West, South Africa, during the construction of a breakwater. Named after Henry Barkly, Governor of the Cape of Good Hope (1815-1898). Present whereabouts unknown.

**Barkly Mine**; location of small, narrow, nearly vertical, kimberlite fissure, in Barkly West, South Africa.

**Barkly West**; a city in Cape Province, South Africa where numerous alluvial diamond deposits are located. Famous diamonds such as Barkly Breakwater Diamond, and the Broderick Diamond were found here. → Klipdrift (Canteen Kopje).

**Barkly West Group;** → Klipdrift (Canteen Kopje), Barkly West.

**barnach stone;** a building stone, obtained from the Lincolnshire limestone.

**Barnato;** Barnett Isaacs Barnato (1852-1897). Originally, an entertainer in the diamond field who become a diamond dealer. He founded the Barnato Mining Company Ltd. in 1873.

**Barnato Mining Company Ltd.;** a diamond Mining Company, founded in 1873 by the brothers, Barnett Isaacs and Henry Isaacs, in Kimberly, South Africa.

**barnesite;** a trademark for a rare earth oxide, containing ca. 45-48 % CeO<sub>2</sub>. Used in glass polishing.

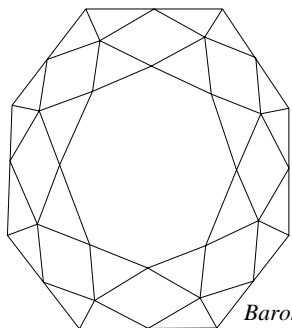
**barock pearl;** same as baroque pearl.

**Baroda gem;** a commercial term for a foil-backed, colorless glass, used as a diamond imitation.

**baroid;** a term for a weighting material, made from selected barite, which is added to drilling material to increase the unit weight of mud.

**baroite;** a term applied to a rock composed of barite or celestite.

**Baroness Cut;** a trade term for fancy octagonal shape

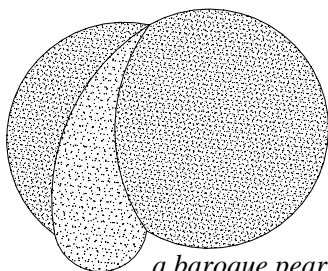


*Baroness Cut*

gem-cut, with 65 facets. It is derived from an oval-cut.

**baroque;** term meaning curved and exuberant in form, or irregular in shape, to distinguish from symmetrical, cut gemstones. A pearl or tumble-polished uncut gem, irregular in shape, such as baroque pearl, and baroque stone.

**baroque pearl;** a term applied to pearls, both natural and cultured, which are irregular in form. It is formed



*a baroque pearl*

by a pearl oyster, with some irregular-shaped intrusion. Baroque pearls are used as pendants and brooches

sometimes created in animal form or shaped like other figures. Also, known as barok pearl, barock pearl, or wart pearl. Baroque fresh-water pearls are found in rivers of Europe, America, and Asia. → Baroque, The Pearl of Asia.

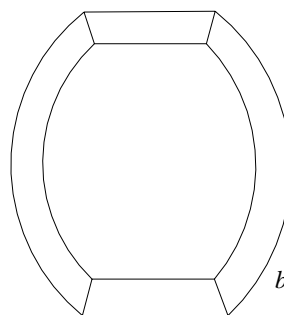
**baroque stone;** the production of baroque-shaped stones, by the tumbling process. → Baroque.

**barragtu;** an Assur or Egypt term for emerald. Also spelled barraktu.

**barraktu;** same as barragtu.

**barrel polishing;** another term for tumbling.

**barrel process;** a process of extracting gold or silver when it is placed in a revolving barrel with mercury,



*barrel cut*

chlorine, cyanide solution, or other reagent.

**barrel quartz;** a term applied to a certain type of gold-bearing quartz, which occurs in the form of corrugated veinlets. Found in Nova Scotia, South East Canada.

**barrel shaped;** a gemstone, which has the shape of a barrel.

**barrel shaped pearls;** an old term for barrel-shaped pearls found in well-worn necklaces due to wear.

**barren;** a geological term meaning without fossils.

**barrok pearl;** same as baroque pearl.

**barry;** a term used by Australian miners for those opal pertaining to bar of potch, which can be found, with the bars of precious opal.

**barysphere;** the heavy interior core of the earth inside, beneath the lithosphere. Thus include both the mantle and core, which probably consisting largely of iron. Also called centrosphere, bathysphere, nicke-iron mass.

**baryte;** → barite.

**barytes;** → barite.

**barytine;** → barite.

**barytite;** → barite.

**barytocalcite;** synonym for bromlite. Not to be confused with bromellite.

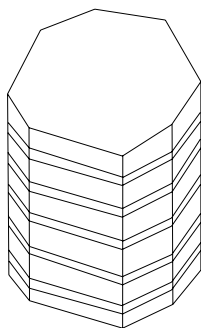
**barytocelestite;** a term used for a mixture of barite and celestite. Prized by collectors.

**basal;** same as basal plane.

**basal cleavage;** a break sometimes seen, parallel to the basal pinacoid of a crystal, this is perpendicular to its

long axis. Also called pinacoidal cleavage.

**basal parting:** splitting or separation of stones or rocks

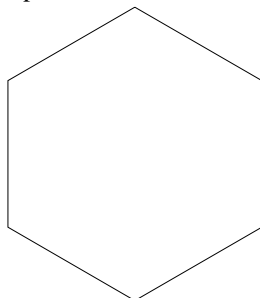


*parting in  
enstatite on  
the basal  
pinacoid*

along certain definite weak basal plane such as lamellar twinning planes, which are not true cleavage planes but resembling cleavage such as sphene, pyroxene, or corundum. Also called pseudo cleavage. Same as false cleavage.

**basal pinacoid;** → basal.

**basal plane;** a term applied to the parallel faces representing the basal pinacoid of a crystal that can be seen in all the crystal systems excluding the cubic systems. A direction perpendicular to the principal axis of the prism, to its *c* axis such as in hexagonal {0001}.



*basal plane  
of  
hexagonal*

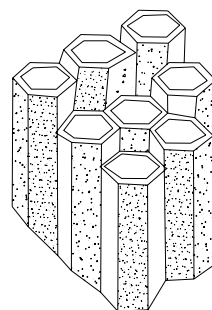
Synonym for base. Also called basal pinacoid.

**basal reef;** gold-bearing reef in South Africa, in the Orange Free State.

**basalt;** a general term for dark-colored, fine-grained, mafic, extrusive igneous rock, composed chiefly of calcic plagioclase, clinopyroxene and magnetite, without or with olivine.

**basalt columnar;** a particular structure seen mainly in dykes commonly in basic rocks such as basalt and dolerite which consists of a close-packed series of hexagonal prisms forming at right-angles to the upper and lower surfaces.

**basalt glass;** a semi-transparent to opaque, gray-brown to black and blue, glassy form of natural basalt, containing 50% silica. RI:1.58-1.65. SG:2.7-3.0. H:6. Conchoidal fracture. Usually cut cabochon in various, dark colors. Found in Flinders River, Queensland, Australia. Also called tachylite or tachylite, sideromelane, basalt obsidian, jaspoid, wichtisite,



*columnar  
structure  
of basalt*

hyalobasalt.

**basalt hornblende;** a black to brown, ferric iron variety of hornblende, found in volcanic rock basalt or other volcanic rock. Also called oxyhornblende, basaltic hornblende, lamprobolite, basaltine.

**basalt obsidian;** → basalt glass, sideromelane, tachylite.

**basalt (rock);** a fine-grained, compact, dark to medium-dark-colored, mafic (basic), commonly extrusive, igneous rock, originating from lava or a minor intrusion (locally as dikes). Composed chiefly of calcic plagioclase, and clinopyroxene in a glassy or fine-grained groundmass, which was used by the Egyptians as a gemstone. Miners use the name trap rock. Also called basaltine rock.

**basalt (rock);** a general term for fine-grained, compact, dark to medium-dark-colored, mafic (basic) rocks, originating from lava such as basalt, diabase, dolerite, and dark-colored andesine.

**basalt (rock);** a term, loosely used for dark colored, fine-grained igneous rocks used for brooches or pendants.

**basaltese black;** same basalt black.

**basaltese spatous;** a term may applied to emerald, such as by Cronstedt.

**basaltic;** containing or resembling basalt, or pertaining to basalt. Also called basaltine.

**basaltic hornblende;** same as basalt hornblende.

**basaltin;** a Spanish misnomer for pale violet beryl.

**basaltin amatista;** an Italian misnomer for pale violet beryl.

**basaltine amethyste;** a French misnomer for pale violet beryl.

**basaltine rock;** same as basalt (rock).

**basaltine;** same as basalt hornblende.

**basaltine;** an obsolete term for augite. → Basaltic.

**basaltine amethyste;** a French term for pale violet beryl. Basaltine amethyst.

**basalt ware;** an unglazed, black-body variety of wedgwood, used for relief plaques, portraits, etc. Often called Egyptian black, basaltese black.

**basanite;** a fine-grained, extrusive, basalt rock, characterized by olivine, calcic plagioclase, augite,

feldspathoid, such as nephelinite, leucite, or analcite. Without olivine, the rock is named as tephrite.

**basanite**; a fine grained, black jasper or fine crystalline quartzite from California, used to test the purity of noble metals, and alloys, by examining the streak remaining on the stone. Also, called touchstone, and Lydian stone, lydite, in ancient times.

**Bas-Congo-Katanga Railroad**; the diamond exploration company with works washing the gravel of the Sasatchie River.

**base**; same as the pavilion of a cut stone. The part of a cut stone, below the girdle flat.

**base**; the basal plane of a crystal.

**base**; the quality value of a pearl is called base. → Base price of pearl.

**base coat**; the coating over the base of the gems.

**base metal**; opposite of a noble metal, also any of the nonprecious metals, such as zinc, copper, lead, or tin. Metals, to which a coating or plating is applied, such as a porcelain enamel because they oxidize and corrode easily. Also called nonprecious metal.

**base mineral**; mineral which occurs as dominant constituent of rock such feldspar, quartz, amphibole, pyroxene, mica and olivine.

**base of crystal**; same as crystal base or base of a crystal.

**base price**; the price for each metal, below, which it can not fall, without putting the average producer out of business. Also called basic price. → Base price of pearl, calculation of the price of gemstones.

**base price of pearls**; in the gemstone trade, usually the price of a single pearl is computed by squaring its weight in carats or grains, and multiplying the result by a base rate, however the shape and quality of the pearls is considered the value of larger pearls increases as the square of their weight. For example: in a pearl weighing 5 grains, if the base rate, is \$ 15, the result is \$ 375.00. The grains are squared, ( $5 \times 5 = 25$  grains), known as the *once* then we multiply it by a \$ 15 base = \$ 375.00. The prize of pearl is computed using the monetary units of all countries. Also called base unit, basic price. → Calculation of the price of gemstones.

**base-relief**; same as low relief.

**base unit**; → base price of pearl.

**Basel Baptismal font**; a cruciform twin of staurolite, used as an amulet in Basel, Switzerland.

**basic**; refers to igneous rocks, with a low-free quartz content.

**basic diamolite**; simply constructed, diamolite or diamonlite.

**basic dye**; an azo dye with basic constituents such triphenylmethane dye. Used as dyes. Also called cationic dye.

**basic flux**; in metallurgy, same as base material, such as

limestone or dolomite, used as a flux.

**basic igneous rock**; the term is rarely used in lithology. An igneous rock containing chiefly dark-colored minerals.

**basic igneous rock**; a name applied to igneous rocks with less than 52% silica, free or combined.

**basic igneous rock**; an igneous rock containing minerals, low in silica, and rich in a metallic base, such as amphibole, pyroxenes, biotite, and olivine. Also called basic rock.

**basic lava**; lava, poor in silica ( $\text{SiO}_2$ ), (less than 52%), distinct from acidic lava, or intermediate lava. Basic, lava rocks are typically dark colored. → Basic magma, basic igneous rock.

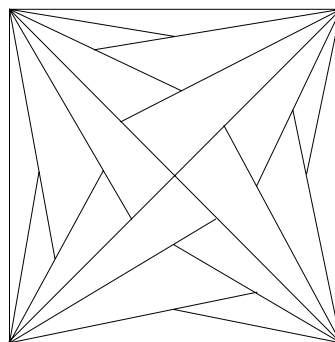
**basic magma**; that magma-rich in iron, magnesium, and calcium. → Basic lava, basic igneous rock.

**basic price**; → base price.

**basic rocks**; an igneous rock, with less than 52% silica, free or combined. → Basic igneous rock.

**baskets**; sieves made of brass, used in Sri Lanka for separating pearls of slightly different sizes. → Peddi.

**basket-work cut**; a modified square cut form made



*basket-work square*

similar to triangle diagonal fleche basket.

**basanite**; a white mineral composed of hydrated calcium sulfate with the formula  $\text{CaSO}_4 \cdot \frac{1}{2}\text{H}_2\text{O}$ , which is a pseudomorph of gypsum. Also called viberite.

**bast**; a rough diamond with a frosted surface, from the Dutch term meaning tree bark, or rind.

**bastard**; anything abnormal in shape, size, appearance, etc.

**bastard**; an inferior or impure mineral that contains a high proportion of a substance with uncommercial value.

**bastard**; a hard and massive boulder or rock.

**bastard**; an unusual make, or proportion of abnormal shape.

**bastard**; an ore, which gives misleading assays.

**bastard amber**; another term for cloudy amber, where the appearance and effect caused by the inclusion of a vast number of minute air bubbles.

**bastard ashlar**; hard and massive stones, intended for

ashlar work.

**bastard cut;** fashioned stone, which does not conform to the recognized typical forms, or, which shows some slight departure from the *pure*, standard style. The term applies only to those stones that have a regular and symmetrical arrangement of facets. Should they be irregular or deviate from an appreciated, standard form, the term *cap cut* is used. Also called bastard cut gemstone. It means a fashioned stone, with irregular and haphazard facets. → Asymmetrical step-cut.

**bastard cut gemstone;** same as bastard cut.

**bastard diamond;** a misnomer for quartz crystal from England.

**bastard emerald;** a misnomer for green peridot, a transparent variety of olivine.

**bastard emerald;** a misnomer for green colored quartz.

**bastard emerald;** a misnomer for any green stone resembling emerald.

**Bastard Smaragd;** a German misnomer for any green stone resembling emerald such as quartz, peridot.

**bastard ivory;** an intermediate quality of softer ivory, from Thailand, Asia, suitable for working.

**bastard jet;** a misleading term for a soft variety of Canadian jet.

**bastard jet;** a misleading term used by England jet worker for French jet.

**bastard quartz;** a miner's term for rounded boulder, of white, glassy quartz, found unassociated with other minerals.

**bastinite;** same as huréaulite.

**bastion agate;** → fortification agate.

**bastite;** an opaque, olive-green, blackish-green, or brown variety of serpentine, resulting from the alteration of ortho-pyroxenes, especially enstatite, and bronzite. It is characterized by a schiller of metallic or pearly luster. SG:2.5-2.7. H:3-4. n= 1.57-1.58. Found in the Harz in Germany. Used for carving small objects and cut cabochon. Also known as schiller spar. → Enstatite.

**ba stone;** a Chinese term for precious stone, gemstone.

**Basurehi Mine;** an alluvial diamond mine, in India.

**Basutoland;** former name for Lesotho, Southern Africa.

**Basutoland Diamond Corporation;** a diamond-digging company that holds the exclusive mining license for Lesotho, Southern Africa.

**batea;** a Brazilian term, for the wide, shallow washing pans used by early gold and diamond prospectors.

**bathochrome;** a radical, which shifts the red absorption spectrum of stuff towards a longer wavelength of the red end of spectrum.

**bathochromic;** same as red shifting. → Bathochrome.

**batholite;** another spelling for batholith.

**batholith;** a geological term, for a large domed body of

intrusive, igneous rock, frequently granite. Also spelled bathylith, batholite, bathylite. Also called intrusive mountain.

**Bath stone;** a soft, creamy, oolitic limestone, easily quarried, and used for building purposes. Found in the Great Oolite near, Bath, England.

**Bathurst (diamond);** the diamond found in 1851, on the Turon River, near Bathurst, Australia.

**bathvillite;** an opaque, fawn-brown, amorphous, very brittle, woody resin found in porous lumps in torbanite, a type of boghead coal, at Bathvillite, Scotland.

**bathylite;** another spelling for batholith.

**bathylith;** another spelling for batholith.

**bathysphere;** same as barysphere.

**bati xaga;** a Pomo Indian term, meaning the type of obsidian used for arrows by the Indians of California. It is not as hard as dupa xaga.

**batman;** → indicator minerals.

**baton;** similar to the baguette cut in diamonds, or other gemstones, but longer.

**Battershill Diamond;** the diamond of 65 cts, named for the Governor of Tanzania, in 1945. Present location unknown.

**battledore;** a device used in the glass industry for sharpening the base of wine glasses. Also known as palette.

**battu-uji;** a Malaysian term, for touchstone.

**batu;** a term used in Malaysian for an opaque, yellow to brown or very dark, variety of a hard semifossil dammar resin derived from any of certain coniferous Pinaceous trees of the genus *Agathis* with resinous odor. Found in south East Asian. Sometimes called cat's-eye resin. Used for varnishes, lacquers, sometimes as amber imitations, or melted with amber, and often containing real or imitation insects. Become sticky, when rubbed briskly. → Copal, black dammar, white dammar, kauri copal.

**batu kawi;** a Sumatran term for a red stone, which is supposed to be an infallible sign of gold.

**Baumgold Brilliant Diamond;** white brilliant of 55 cts, which was again recut to 52 cts, from South Africa. Its rough weight was 167.25 cts, Present owner unknown. → Baumgold Pear Diamonds.

**Baumgold Pear Diamonds;** two pear-shaped brilliants of ca. 50 cts, each. Both were cut from the Baumgold Rough Diamond, which weighed 609.25 cts, from South Africa.

**Baumgold Rough Diamond;** a bluish-colored diamond, of 609.25 cts, found in 1922, at the Wesselton Mine in South Africa. The Baumgold Brothers, Inc., cut it into 14 stones. The two largest stones are pears-cut brilliants of 50 cts, each. Present whereabouts are unknown. → Baumgold Pear Diamonds.

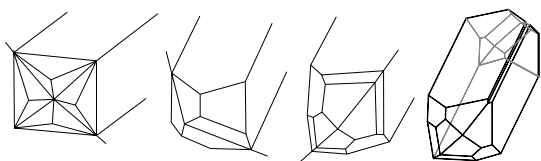
**Baumstein**; a German term for mocha stone.

**bauxite**; off-white, grayish, brown, yellow, or reddish-brown rock, composed of aluminum hydroxides.  $\text{Al}_2\text{O}_3 \cdot 2\text{H}_2\text{O}$ . The principal ore for aluminum and alumina. Colorless corundum, synthetic rubies, and sapphires are composed from powdered alumina. Original spelling is *beauxite*. → Alundum, laterite.

**Bavarian cat's-eye**; a variety of quartz, with actinolite inclusions, which, when cut en cabochon, resembles a cat's-eye. Found in Hof and other locations in Bavaria, which produces only a few stones of fine quality. Other qualities are incorrectly sold as Hungarian cat's-eye. Quartz cat's-eye from Bodental, in the Harz mountains, Germany, is sometimes sold as Bavarian cat's-eye.

**Bavarian Imperial Treasury**; famous Bavarian Residenz Museum in Munich, Germany, in which many gemstones and precious objects from members of ruling Wittelsbacher family are on display.

**Baveno twin law**; an unusual twin crystal can be seen



*Baveno twins of feldspar*

in feldspar consists of two individuals with the twin plane and composition surface are (021).

***b*-axis**; one of the crystallographic axes, used as a reference in crystal description. The axis is oriented horizontally, right-to-left. In an orthorhombic or triclinic crystal, it is usually the macro-axis. In a monoclinic crystal, it is the orthoaxis, with the subscription 0 as *b*0. Also called *b*-direction.

***b*-axis**; the lateral axis in a monoclinic crystal system, which has two fold symmetry and/or is perpendicular to the mirror plane of symmetry. Also called orthoaxis.

**bayadère**; a style of twisted seed pearls necklace made of several strings usually are colored.

**bayadère**; a French term for a style twisted seed pearls assembled of numerous strings of seed pearls, which are twisted together. The strands may be of contrasting color pearls and designed in a rope-like fashion.

**bayat**; a local name for a brown, ferruginous variety of jasper, from Cuba. Also spelled bayate.

**bayate**; same as bayat.

**bayerite**; a dimorph of gibbsite of  $\text{Al}(\text{OH})_3$ , used in the flux-melting process of synthetic corundum and sapphire.

**bayerite**; a dimorph of gibbsite of  $\text{Al}(\text{OH})_3$ , used to produce imitation turquoise together with copper phosphate. It is sold as *neolite*.

**bayldonite**; a mineral with an aggregate of mammillary concentric, fibers with the chemical formula of  $4[(\text{Pb,Cu})_3(\text{AsO}_4)_2(\text{OH})_2]$ . Monoclinic crystal. Grass-green, black-green, and greenish. Pale green streak. Resinous luster. Subconchoidal fracture. Optics;  $\alpha:1.95$ ,  $\beta:1.97$ ,  $\gamma:1.99$ . Birefringence: 0.040. ⊕. Dispersion: ? SG:4.35. H:4. Found in Namibia (Africa), Uzbekistan (the Russian Federation, CIS), and Cornwall (England). Cut as gemstone.

**bay salt**; a kind of commercial solar salt obtained by evaporating seawater in shallow bays, lagoons, pits, basins or ponds by the heat of the sun.

**Bazaruto**; genuine pearls, fished off the Bazaruto Island, near Zanzibar, Africa.

**bazu band**; an Iranian or Farsi term for upper arm ornaments (armlets), made of gold or other noble metals, decorated with enameling and gems, and worn around the upper arm. Also corruptly spelled bajoobund.

**Bazu Band Emerald**; an Indian upper arm ornament (armlet) made of three engraved Columbian emeralds, set with diamonds.

**Bazu Diamond**; the Indian diamond of 104 cts, obtained by Tavernier, and sold to a Dutch merchant, who had it cut into smaller pieces.

**bazzite**; a transparent, azure-blue, hexagonal mineral: it is the scandium-containing part, or analogue of beryl,  $\text{Be}_3(\text{Sc,Al})_2\text{Si}_6\text{O}_{18}$ . SG:2.77-2.82. H:6½. Optics:  $\omega:1.627$  and  $\varepsilon:1.607$ . Birefringence: 0.027. ⊖. Found in Italy, Russia, Kazakhstan, Switzerland and Austria.

**BCK**; same as Bécéka. → Société Minière du Bécéka.

**bdellium**; a biblical term for an unknown substance, mentioned in Genesis probably a mineral: „and the gold of that land is good; bdellium and the onyx stone . . . (II. 12)“. Various ascribed by different authorities to be pearl, a red stone, opal, a resin, or no stone at all, but manna.

***b*-direction**; same as *b* axis.

**Be**; a chemical symbol for the element beryllium.

**beach mining**; the extraction and concentration of beach placer ore, or, heavy minerals such as zircon, monazite, rutile, ilmenite, and gold. Also called foreshore mining, inshore mining, sea mining.

**beach ore**; the extraction and concentration of heavy ore or minerals, on a beach, by the selective action of the surf. Bearing useful minerals such as diamond and gold.

**beach placer**; the placer deposit on a beach put there by selective action. Bearing useful minerals such as diamond and gold.

**beach rock**; a friable to well-cemented sedimentary rock made of calcareous skeletal debris mainly consisting of sands and/or pebbles, which is cemented together by calcium carbonate.

**bead cut**; a globular, double-rose cut.

**beading**; same as bead setting.

**beading board**; a table on which the women threading the beads of jet or other stone.

**bead men**; who worked only in making beads from jet.

**beads**; small globules of precious stone, glass, wood or metal, with or without facets, but always with a hole drilled through the center. The form of beads varies from cylindrical, to polyhedral, oblate, or, irregular. Beads are made from gold, silver, other metals, glass, porcelain, wood, coral, bone, jet, amber, and other organic or inorganic substances. Used as personal adornment, ornamental objects or talismans, ear-rings, necklaces, bracelets, brooches, rosaries, etc.

**beads**; in the blowpipe analysis of minerals, a glassy drop of flux material, such as a borax bead, used as a solvent for color testing various metals.

**beads**; beads made of hollow metals are made into necklaces or bracelets.

**beads**; a referring term for the central part of a pearl.

**beads**; the best material for creating a nucleus in cultured pearls is a mother-of-pearl bead, which is not foreign to the animal. It is inserted in the shell of a mussel, which coats it with nacre, to produce a cultured pearl. Also known as the bead nuclei for pearl.

**bead nuclei for pearl**; → beads.

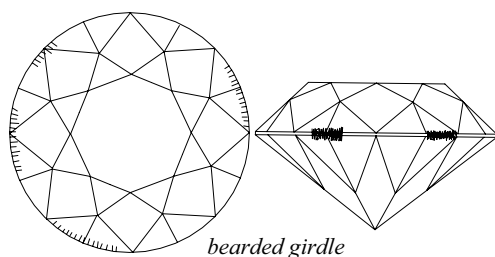
**bead setting**; a style of setting gemstones, or diamonds consisting of a row of beads, which are pressed into metal.

**beam**; an optical effect of scattered light, from an internal reflection, caused by particles of matter in the path of the light, making a visible beam.

**beam balance**; same as Westphal balance. A balance, in which the weight of the heavy liquid and gemstone contributes to the balance of the moments of a beam about a central fulcrum.

**beard**; same as bearded girdle.

**bearded girdle**; a series of imperfections, caused by the



*bearded girdle*

too-rapid polishing on diamond girdle, which produces

very fine hair-like fractures or lines on or within the girdle. The lines are fuzzy, the diamond without the normal, smooth and waxy polish. Also called fuzzy girdle, feathered girdle, fringed girdle.

**bearing**; a thin, metal groove, in which a gemstone is supported.

**beaten gold**; same as leaf gold.

**beaten metal**; same as leaf metal such as copper.

**beaten silver**; same as leaf silver.

**beat the dirt out**; an informal term used by Australian miners for some who dig carelessly with risking to damage opals. Who is without experience to dig. Nowadays this term refers to process of digging.

**Beauharnais Brooch**; a brooch of a gold and silver setting, with diamonds and rubies. It was once owned by Empress Josephine, first wife of Napoleon. Later it becomes the property of Prince Eugène de Beauharnais, the Viceroy of Italy.

**Beaumont Diamond**; the diamond of 273 cts, in the rough, found near Windsorton, South Africa. Present owner unknown.

**Beau Sancy (Diamond)**; → Little Sancy Diamond.

**beauty**; beauty an extensible term because the beauty is in the eye of the beholder. To one beholder, beauty may be in the color, to others, it may be transparency, brilliancy, luster, cut-form or fire. The beauty of most gemstones are a combination of two or more characteristic features. For example diamond it rests in clarity, colorless, fire, hardness, etc. Turquoise rests primarily in color.

**beauxite**; → bauxite.

**Bebit**; an Egyptian term for country of grottoes where turquoise mined from 5300 B.C. Now is named as Wady Maghareh with meaning Valley of Caverns.

**beccarite**; alpha zircon, from Sri Lanka. Olive-green color. RI: 1.93-1.98, SG: 4.7.

**Bécéka**; → Société Minière du Bécéka.

**béche de mer**; same as sea cucumber.

**Bechuanaland**; former name of Botswana.

**Becker amber**; a misleading term for stantienite, jet or retinite having very high oxygen content. Also called black amber of Whitby.

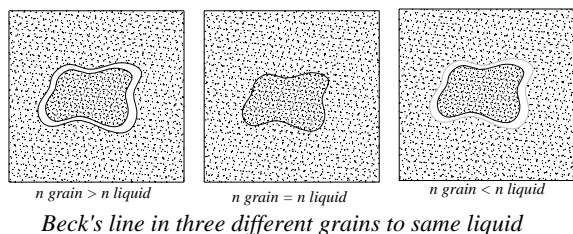
**beckerite**; an opaque or cloudy, dark brown, soft fossil resin, of retinite, with a very high oxygen content, (23%), occurring with amber. Found in Baltic Area. Among miners known as brown resin.

**beckite**; an ancient term, but an incorrect, spelling of beekite.

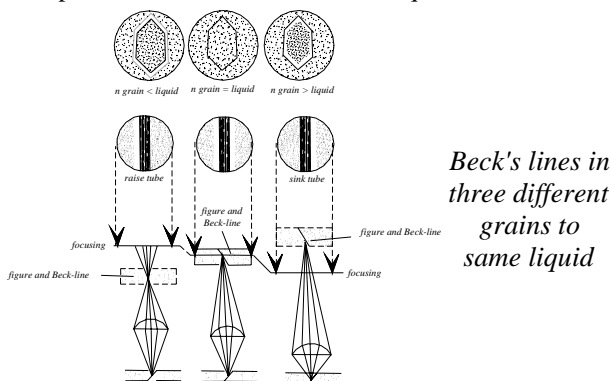
**Beck line**; a method of determining the refractive index of minerals in a thin section, in which a narrow, bright line of light can be seen under a microscope, at the junction of two minerals of different refractive indices.

→ Beck line method, Wild method, immersion method.

**Beck line method;** in microscopy, a method of testing



the relative refraction indices. A bright line separates substances of different refractive indices. A faceted, transparent stone is immersed in a liquid of a known,



refractive index and viewed through the microscope. The faceted edges of the stone travels from light to dark, when focusing down, from the liquid into the gem, hence the refractive index of the stone is higher than that of the liquid, and inverted. Mainly suitable for small fragments. → Beck line, Wild method

**Beck test;** a method of refractive index determination. → Beck line method.

**Becquerel ray;** a term used before the terms alpha, beta, and gamma rays were introduced, for the particles emitted during radioactive decay.

**bed;** layered detrital or sedimentary material as a stratified series, which is known as stratum.

**bedded chert;** layered chert.

**bedding cleavage;** cleavage that is parallel to the bedding.

**Bedford limestone;** a commercial term for spargenite, from a Mississippian limestone quarried in Bedford. Sold for building purposes. Also called Indiana limestone.

**bediasite;** a brownish to black, jet-like tektite, from Texas. Named after the Bidai (Bedias) Indians of the Trinity River Valley, USA. → Tektite.

**bedrock;** rock of relatively great thickness, under deposits of gravels, silt, sand, soil, etc.

**beef;** a name used to describe fibrous calcite, similar in

habit to satin spar.

**beef blood ruby;** a term used in England for a blood-red ruby, darker than pigeon's blood, from Myanmar.

**beekite;** a variety of chalcedony chert, often pseudomorphous after coral skeletons of red color, shells, or other fossils. A silicified coral.

**beekite;** a white, opaque, concretion form of calcite, commonly found in small rings on the surface of fossil shell, coral, and sponge, as a replacement for organic matter. Found in Aden, Asia. Misleadingly spelled backite.

**beer-bottle;** same as carbon amber.

**beer-bottle;** a not recommended term for amber-colored patch opal.

**beer-bottle glass;** a term used for brown-colored glass by adding sulfur compounds such as sulfide or sulfates (iron sulfides  $\text{Fe}^{2+}$  and  $\text{Fe}^{3+}$ ), with charcoal and other organic compounds. Also is called carbon amber glass.

**beetle;** same as septarium.

**beetle articles;** variously colored enameled, gold-coated metal beads, in the form of a beetle, made in China.

**beetle stone;** an old term for turtle stone. Coprolitic nodules, which, when broken open, give a fanciful resemblance to a fossil beetle.

**beggar beads;** quartz, agate, jasper, carnelian, moss agate, and chalcedony beads, from India, used to make necklaces of graduated or combined shapes, sizes and colors.

**bei;** a Chinese term for cup made of jade.

**Beilby layer;** a vitreous, amorphous or a thin flowing layer of ultramicroscopic depth, which is produced by recrystallization during the polishing of some gemstones, other than diamond. There are 4 types of Beilby layers: (a) a layer which is rapidly recrystallized, like its underlying material, such as quartz or corundum, (b) some are only abrasion layers, where the melting point of the crystal is too high, for example as in a diamond, (c) where the molten layer remains amorphous as on certain surfaces requiring a lengthy heating time, such as kyanite, (d) where the layer remains amorphous on all surfaces, such as on spinel or zircon.

**Beilstein;** a German term for Nephrite (axe stone).

**Beiragahr;** → Wairagah working.

**bekko ware;** a yellow-brown, spattered Japanese pottery. It resembles tortoise shell.

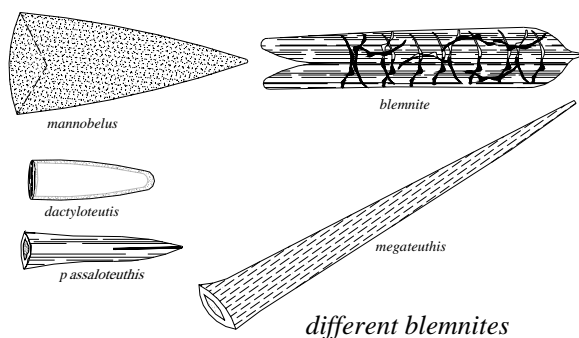
**Belagius;** another spelling for Badakhshan, Afghanistan.

**belbaite;** a term used for hypothetical tourmaline molecules of elbaite with a prefix b.

**belcher setting;** a type of setting used for stones in finger rings, in which the stones have been secured by prongs or claws that are cut into the shank. These do not extend above the shank.



**belemnites**; any extinct member of cephalopod fossils, being cigar-shape or cylindrical, which are used to set



in jewelry, unpolished or polished. Also called thunderstone, arrow-head, finger-stone, arrow-point.

**belemnite marl**; gray, calcareous clays, with plentiful belemnites, in England. → Plenus marl.

**Belgian black marble**; same as black marble.

**Belgian Congo**; former name for Zaire.

**Belgian Diamant Nijverheid**; an organization of diamond manufactures in Belgium.

**Belgian Gemmological Society**; → Société Belge de Gemmologie.

**Belgian rouge-et-gris**; → rouge-et-gris, Belgian.

**belgite**; same as willemite.

**Belgavia Mine**; a small diamond pipe deposit, in Kimberly, South Africa.

**Bella, La**: a hyacinth of 416 cts, which was purchased in 1687 by Leopold I, from the Hungarian royal family. It is mounted to form the breast of a gold Imperial double eagle in the crown. Now on displaying in the Schatzkammer, of the Hofburg, Vienna, Austria.

**Belleck porcelain**; a very thin porcelain from Belleck, Ireland, which is decorated with a pearly, luster enamel, laid over the glaze, suggesting the interior of shells.

**bell metal**; any high tin-bronze alloy, with 20% tin and 80% copper, used as a lap and polishing item with rouge, etc.

**bell pearl**; another term for a drop-shaped pearl.

**Bellsbank**; important kimberlite diamond mine consisting of two fissures: Bobbejaan and Bellsbank, near Barkly West, Cape Province, South Africa.

**belly**; the central part of a pear-shaped, or marquise diamond, when viewed from above.

**belly**; enrichment of an ore deposit. Also called bulge.

**belly shield**; → blond shell.

**beloelite**; a granular plutonic rock containing a high proportion of sodalite, and less potassium feldspar.

**belomorite**; a commercial term for a variety of moonstone, from the White Sea, North Russia.

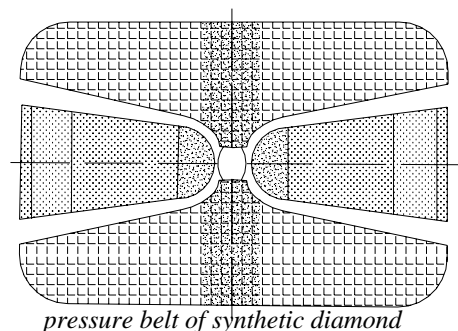
**belonite**; an aggregate of small rod-shaped, or elongated, globulite crystallites, which appear as the

texture in glassy, igneous rocks or obsidian, (natural glass), when examined under microscope. Acicular crystallite, has rounded ends, and is known as *globulite*, and those, which are bead-like strings, are called as *margarites*.

**belonite**; same as aikinite.

**belt**; a broad strip encircling or girdling something.

**belt of synthetic diamond pressure**; a modern device



for producing synthetic diamond and in mineral industry. → Synthetic diamond.

**belt sander**; an electrical portable, abrasive belt for sanding. sand-paper is carried in a conveyor belt-like manner over two rotary rollers.

**bemenite**; an incorrect name for danburite.

**bemenite**; a grayish-yellow, to grayish-brown manganese silicate mineral.

**bemiscite**; a salmon-colored feldspar, from Bemis, Tennessee, USA.

**bench**; any horizontal, wide, stepped terrace along which material is worked in an open pit.

**bench**; any long, narrow, horizontal surface used for solid work.

**bench digging**; same as bench placer.

**bench mining**; one system of working in open pit and underground mining. Same as open bench mining.

**bench placer**; gemstones-, diamonds-, gold- or other ore-bearing, terrace gravels, which are mined at, or near, the surface. Also called bench digging, terrace mining, terrace placer. → Alluvial terrace-mining.

**bench shears**; a heavy device used for cutting metals and splitting minerals, rocks and stones.

**bench terrace**; more or less, an embankment of earth, with a flat top, between steep risers, graded down into a hillside.

**bending phenomenon**; → electron diffraction, neutron diffraction.

**Benedictine Abbey Emerald**; a emerald green fluorite of 12.90kg was given to Benedictine Abbey at Reichenau, Switzerland by Charlemagne 742-814. William Cox saw the stone suppose that it is a green fluorite, not emerald. Also called Charlemagne

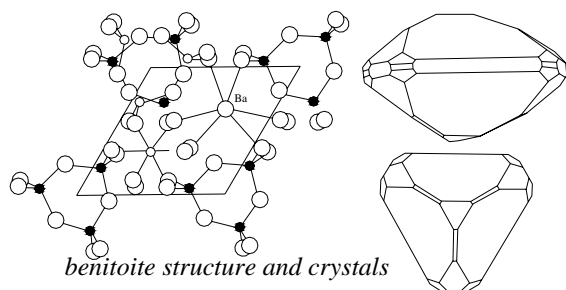
Emerald. Also called Reichenau Abby Emerald.

**Benedito Valadares Diamonds I, II, III;** the diamond of 108.25 cts, from the Corrego Coro River, Minas-Gerais, Brazil, found in 1940. It was purchased by the Birnbaum Brothers, who fashioned it into 3 emerald cuts, weighing 30, 20, and 8 cts. Also called Governador Valadares Diamond.

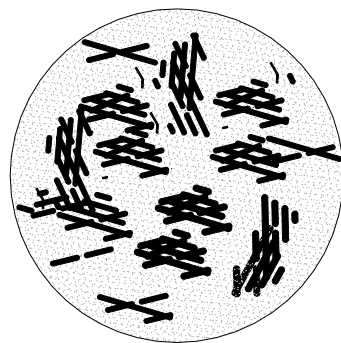
**Bengal amethyst;** a misleading term for purple sapphire, from Bengal.

**benitier;** → *Tridacna gigas* linné.

**benitoite;** a rare pale blue to deep-blue, or colorless, gem mineral. Strongly dichroic, in blue and white. Blue



luminescence, only under SW light. In color, it resembles sapphire, but it is easily distinguished because of its inferior hardness and higher dispersion.



*confused natrolite needles in benitoite,*

Bluish fluorescence under short-wave ultraviolet light. Strong pleochroism. Rarely cut as faceted gems because the crystals flaw badly. Prized by collectors. Also called sky stone.

System: hexagonal.

Formula:  $2[\text{BaTi}(\text{Si}_3\text{O}_9)]$ .

Luster: vitreous.

Streak: colorless.

Colors: blue, pale blue, purple, pink, white, colorless.

Diaphaneity: transparent to translucent.

Cleavage:  $\{1011\}$  indistinct.

Fracture: conchoidal to uneven. Brittle.

SG: 3.64-3.68.

H: 6-6.

Optics:  $\omega$ : 1.757,  $\epsilon$ : 1.804. Distinctly different dichroic colors.

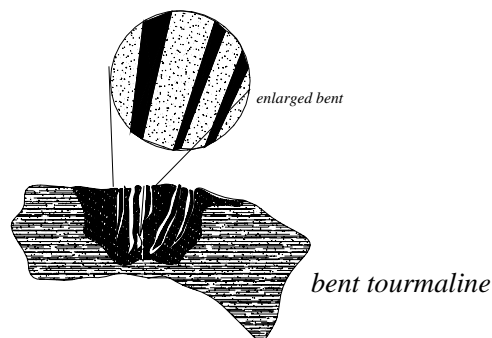
Birefringence: 0.047.  $\oplus$ .

Dispersion: 0.039-0.046.

Found only in San Benito County, California, USA.

**benitonite inclusions;** sometimes can be seen confused short natrolite needles.

**bent crystal;** a typical feature can be seen in some crystal such as elbaite tourmaline from San Diego



which is bent but not twisted. In which *c*-axis and sometimes healed fracture are present, material of healed fracture is fibrous tourmaline or may be quartz fibers. This part of bent and fractured crystals is so-called *in line* within their host.

**benitonite;** a general term applied to montmorillonite clay minerals derived from volcanic ash. Also called amargosite, taylorite (obsolete).

**benitonite;** same as Retinite.

**benzene;** a colorless, aromatic, volatile, flammable liquid of hydrocarbon  $\text{C}_6\text{H}_6$ . Used chiefly as a solvent for heavy liquids of organic origin, and in organic synthesis. RI:1.50. SG:0.88. Soluble in water, ether, and acetone. Care should be taken as it is highly flammable and a carcinogenic liquid.

**benzenoid cycle;** the last group of polyene is based on benzenoid cycle system, the structure is similar to benzene ring with three double bonds between six carbons. *Crystal violet* and phenolphthalein are sample for these colorants are used as dye malachite green.

**benzin;** another spelling for benzene.

**benzine;** a colorless, clear, highly flammable, volatile, organic liquid mixture of aliphatic hydrocarbons with a peculiar pungent odor, which derived from petroleum. Used as immersion liquid and solvent. Also called petroleum benzene, petroleum ether, and spelled benzin.

**benzol;** a commercial term for a chemical form of benzene, (80% benzene, 20% toluene and xylene).

**benzopyrone;** → coumarin.

**benzyl benzoate;** a commercial term for the colorless, oily, organic liquid,  $\text{C}_6\text{H}_5\text{CH}_2\text{OCC}_6\text{H}_5$ , used to distinguish amber from plastic imitations. SG:1.17. Insoluble in water, but soluble in alcohol and ether.

**berakta;** a Chaldeic term for emerald.

- berala**; an old Greek term for emerald.
- berall**; an old Greek term for emerald.
- Berbice River**; an alluvial diamond deposit in Guyana, South America.
- Berchem, Ludwig van**; → Berquem, Louis de.
- bereket**; → bareketh.
- beresofite**; synonym of crocoite.
- berel**; an old Ethiopian term for beryl. → Beryl,-names of.
- berg crystal**; another term for rock crystal.
- Berghem, Ludwig van**; → Berquem, Louis de.
- Berglen diamond**; the brown diamond of 416.25 cts, found 1924 in Transvaal, South Africa. Present location unknown.
- bericle**; an old French term for beryl, which may derive from besicles. → Beryl,-names of.
- bericle**; an old French term for eyeglass. → Beryl,-names of.
- berigem**; a commercial term for chrysolite-colored, synthetic spinel. A copyrighted gem.
- beril azul**; same as kyanite.
- beril de oro**; a Spanish term for golden beryl.
- beril de Saxe**; a French misnomer for apatite from Saxony, Germany.
- beril feuilleté**; a French term for beryl. → Beryl,-names of.
- berilio**; the Italian spelling for beryl, or another spelling for berilo. → Beryl,-names of.
- berilio**; a Portuguese spelling for beryl, or another spelling for berilo. → Beryl,-names of.
- berilio amarelo**; a Portuguese term for golden beryl. → Beryl,-names of.
- berilio olho de gato**; a Portuguese term for cat's-eye beryl.
- berill**; an old term used for beryl. → Beryl,-names of.
- berille**; an old German term used for beryl. → Beryl,-names of.
- berille**; a German term used today for eyeglass. → Beryl,-names of.
- berillia**; a white, powdery, refractory material, with a melting point of about 2.570° C. Formula: BeO. Used in preparation of beryllium, and in ceramics. Also called bromelite, beryllium oxide.
- berillo**; an Italian term for beryl. → Beryl,-names of.
- berillo aureo**; an Italian term for golden beryl. → Beryl,-names of.
- berillo azzuro**; an Italian term for aquamarine or blue beryl. → Beryl,-names of.
- berillo bocade fogo**; a Portuguese and Spanish name meaning *fire-mouth beryl*, a yellowish-red variety of beryl, from Santa Maria do Suassui, Minas Gerais, Brazil.
- berillo giallo**; an Italian term for yellow beryl. → Beryl,-names of.
- berillo**, -names of.
- berillo occhio di gatto**; an Italian term forcat's-eye beryl. → Beryl,-names of.
- berillo rosa**; an Italian term for morganite or rose beryl. → Beryl,-names of.
- berillos**; an old German term for beryl. → Beryl,-names of.
- berillus**; an old Latin term for beryl. → Beryl,-names of.
- berilo**; Portuguese and Spanish spelling for beryl. Also called berilio. → Beryl,-names of.
- berilo**; a misnomer for green apatite. → Beryl,-names of.
- berilo amarillo**; a Spanish name for golden beryl. → Beryl,-names of.
- berilo alterado**; a Spanish term for pseudo emerald. → Beryl,-names of.
- berilo ojo de gato**; a Spanish name for cat's-eye beryl. → Beryl,-names of.
- berilo rosado**; a Spanish term for morganite or rose beryl. → Beryl,-names of.
- berilo verdemar**; a Spanish name for aquamarine. → Beryl,-names of.
- berkeyite**; a blue, transparent gem quality variety of lazulite, from Brazil.
- Berlin blue**; another term for Prussian blue.
- berlinite**; a transparent to translucent, colorless to rose-colored mineral, with the formula  $AlPO_4$ . It has an isomorphous structure with quartz, nearly the same interference figure, and it exhibits left- and right-handed effects like quartz. Tetragonal system. Vitreous luster. Conchoidal fracture. Optics;  $\omega$ :1.5235,  $\epsilon$ :1.529. Birefringence: 0.007.  $\oplus$ . SG:2.64. H:6-7. Found in Sweden. Cut cabochon and as beads. Synthetic berlinite is made.
- Berman balance**; a sensitive, torsion-spring balance, used for rapidly and accurately determining the specific gravity of stones weighing less than one-third cts.
- bernat**; a synonym for bernite.
- bernite**; an amber imitation, made of plastic, which contains plant and insect inclusions. It has a similar refractive index to amber. RI:1.50, and a higher specific gravity than amber, SG:1.23. Also called bernat.
- Bernstein**; a German name for amber.
- Bernsteinstechen**; same as amber poking.
- Berquem, Louise de**; → Berquen,-Louis de.
- Berquen, Louis de**; the diamond cutter from Belgium who was thought to have lived in the middle of the 15<sup>th</sup> century. It is said he improved the surface reflections of diamonds by increasing the number of facets, or that he also discovered how to polishing diamonds using diamond powder. It is now known that he predated that era. Also spelled Berquen, Louis de; Berghem, Ludwig van; Berchem, Louise de, van Bercken, Lodewyk. Not

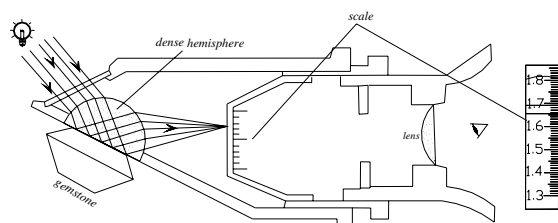
to be confused with Berquen,- Robert de.

**Berquen, Louis de;** → Berquen,-Louis de.

**Berquen, Robert de;** a French jeweler who wrote *Marvels of Western and Eastern India*, in 1661. Not to be confused with Berquen,-Louis de.

**Bertrand lens;** the lens, used in a polarizing microscope, for correcting the focal plane position of the optical axis, which can be put in or taken out, and applied, when viewing interference figures using convergent, polarized light.

**Bertrand refractometer;** the first, direct-reading refractometer for gems, which was designed by



*Bertrand-refractometer*

Bertrand in 1885. → Refractometer, Herbert Smith refractometer, Tully refractometer, Rayner refractometer, Erb & Gray refractometer, Duplex refractometer.

**beruj;** an Indian term for a light colored variety of emerald. → Beryl,-names of.

**berula;** a Syriac term for beryl. → Beryl,-names of.

**berulo;** a Syriac term for beryl. → Beryl,-names of.

**beryl;** a transparent to semitransparent, cyclo-silicate mineral species. Varieties of beryl are emerald, aquamarine, heliodor or golden beryl, bixbite, goshenite, maxixe, and morganite. Rare spelling: berylline. Sometimes showing chatoyancy and exhibiting star effects. It is dichroic. Usually step cut, or cut as ovals, hearts and brilliants. → Beryl,-names of, lattice vibration.

System: hexagonalic.

Formula:  $2[\text{Be}_3\text{Al}_2(\text{Si}_6\text{O}_{18})]$ .

Luster: vitreous.

Streak: colorless.

Colors: blue, pale blue, grass-green (emerald), sea-green (aquamarine), blue, violet, yellow (heliodor or golden beryl), pink (morganite), colorless (goshenite).

Diaphaneity: transparent to translucent.

Cleavage: {0001} less distincts.

Fracture: conchoidal to uneven. Brittle.

SG: 2.67 - 2.79. Average: 2.73.

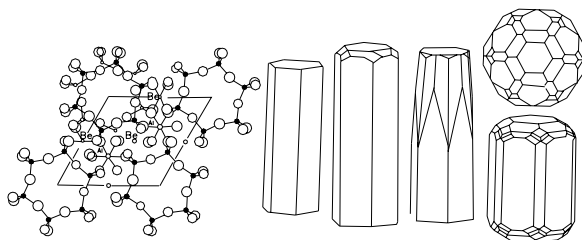
H: 7.

Optics;  $\omega$ : 1.566-1.602,  $\epsilon$ : 1.562-1.599.

Birefringence: 0.005-0.009. Stone from Zambia 0.010.  $\ominus$ .

Dispersion: 0.014.

Found in Brazil, Egypt, the Ural, South Africa, Namibia, India, Pakistan, Malagasy (Madagascar),



*left: beryl crystal structure, four crystal forms and head form of a beryl crystal*

Zimbabwe, Zambia, the USA and Sri Lanka.

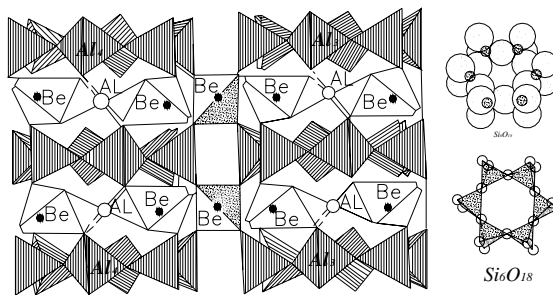
**beryl;** a misleading term for variety of yellow sard and deep brown carnelian sometimes carved and engraved into intaglios. → Beryl,-names of.

**beryl absorption spectrum;** for green beryl or emerald at 683-680, 662, 646, 637, 630-594, 477 and 472 nm. For aquamarine at 427, 456 and weak at 537 nm. For red Beryl at 425, 480, and 560-580 nm. For maxixe beryl at 695, 654, 628, 550 and 581 nm.

**beryl carving;** → carved beryl.

**beryl cat's-eye;** beryl, with parallel inclusions, which cause a cat's-eye effects.

**beryl channel structural;** tube or tabular-shapes occurred when Si-O rings in a silicate structure such as beryl aligned over each other, by which produced



*crystal structure of beryl*

openings are in form of channels parallel to *c*-axis and may occupied with ions. These can be seen in figure below. Also called channels in cells.

**beryl cut;** → aquamarine cut, emerald cut.

**béryl de Barbara;** a French commercial term for beryl Barbara mine, South Africa.

**beryl doublet;** → doublet, beryl.

**beryl first order prism;** → first order prism of beryl.

**beryl glass;** a fused beryl, which, thereby, loses its crystalline structure, and takes on the character of glass. Colored by various coloring agents as chrome, which gives emerald glass its color, cobalt for blue glass or didymium oxide for pink glass. RI:1.50-1.52. SG:2.41-

2.49. H:6-6 softer than emerald. Used sometimes for green and blue imitation gems, but readily distinguishable. Also called fused emerald, fused beryl, scientific emerald. → Beryllium glass.

**beryl, inclusion in;** → inclusion in beryl.

**beryl, inclusion in star;** → inclusion in beryl.

**béryl jaune;** a French term for yellow beryl. → Beryl,-names of.

**berylite;** a commercial misnomer for rose-colored, synthetic spinel. A copyrighted name.

**berylite;** a term used for a variety of beryl. → Beryl,-names of.

**beryll;** a German misnomer for apatite or carnelian. → Beryl,-names of.

**Beryllcarneol;** a German misnomer for carnelian. → Beryl,-names of.

**beryllia;** → glucinum.

**beryllfluss;** a German misnomer for fluorite.

**berylline;** → beryl. → Beryl,-names of.

**beryllion;** a Coptic term for beryl. → Beryl,-names of.

**beryllkristall;** a German misnomer for quartz crystal.

**beryllium;** a steely, uncorrodible, white metallic element, in the group II of the Periodic System, with the chemical symbol Be. Used as an alloy.

**beryllium;** a term frequently used for beryl mineral. → Beryl,-names of.

**beryllium;** → glucinum.

**beryllium detector;** same as beryllimeter.

**beryllium diadochus;** a term sometimes used for aquamarine. → Beryl,-names of.

**beryllium glass;** a colored green glass, with chrome oxide, and a blue colored glass with cobalt. Either consists of the same chemical composition as natural beryl or glass generally, but not in the crystalline form. → Beryl glass.

**beryllium gold;** an alloy of beryllium and gold, containing 0.5-5 % beryllium, which hardens the gold.

**beryllium minerals;** the gemstones emerald, aquamarine, and chrysoberyl, are natural minerals of beryllium silicate, and oxide.

**beryllium omphax;** a term seldom used for aquamarine. → Beryl,-names of.

**beryllium oxide;** → glucinum

**beryllium petalite;** an included synthetic mineral, which occurs during the process of creating synthetic emeralds with chemical formula  $\text{Be} \cdot \text{Al}_2\text{O}_3 \cdot 8\text{SiO}_2$ .

**beryllium quick test;** → field test of beryl.

**beryllium scorillods;** a term seldom used for aquamarine. → Beryl,-names of.

**berylloid;** some crystal of other chemical composition has similar crystal form to common beryl "dihexagonal pyramid".

**beryllonite;** a very rare transparent gem mineral. Rarely

cut as faceted gems but prized by collectors. In the trade, sometimes mistakenly called synthetic topaz.

System: monoclinic. Pseudo-orthorhombic.

Formula:  $12[\text{NaBe}(\text{PO}_3)_2]$ .

Luster: vitreous, pearly on perfect cleavage.

Streak: uncolored.

Colors: colorless, white, pale yellow.

Diaphaneity: transparent to translucent.

Cleavage: {001} perfect, and {101} indistinct.

Fracture: conchoidal. Brittle.

S.G: 2.84.

H: 5-6.

Optics;  $\alpha$ : 1.551,  $\beta$ : 1.558.  $\gamma$ : 1.561.

Birefringence: 0.010.  $\ominus$ .

Dispersion: 0.010.

Found in Finland, Zimbabwe, Stoneham, New Jersey regions, Oxford C., and Maine, USA.

**beryllos;** an old German term for beryl. → Beryl,-names of. → Beryl,-names of.

**beryllosodalite;** a synonym for tugtupite.

**Beryllschorl;** a German misnomer for dark to black beryl. → Beryl,-names of.

**beryl luminescence;** under Chelsea-filter mostly emeralds show a red color, also seen in synthetic emeralds. Under SWUV some emerald exhibits green and rarely red color, while synthetic emeralds seen partially red. Sometimes morganite exhibits weak lilac luminescence.

**Beryll, unecht;** a German term for fluorite or quartz crystal. It means untrue beryl.

**beryllus;** twelfth stone at Jewish High Priest Breastplate. → Breastplate.

**beryllus;** an old Latin term for beryl. → Beryl,-names of.

**beryllus chitim;** a Latin term for chrysolite. → Beryl,-names of.

**beryllus hexagonus;** a term rarely used for beryl, because of its crystal form. → Beryl,-names of.

**beryllus misnicus** an old Latin term for beryl. → Beryl,-names of.

**beryllus oleginus** an old Latin term for oil-colored beryl. → Beryl,-names of.

**beryllimeter;** a popular term for a portable field detector used to detect and analyze ores containing beryllium, which works with the isotope antimonu-124 as the gamma radiation source. Also called beryllium detector.

**beryl, names of;** beryl in Sanskrit is called *vaidurya* also for pearl, in Pali *veluriya* for beryl and pearl. In Assyrian or Syriac *belura*, *brulo*, *burallu*, in Chaldecic *burla* or *birla*, in Iranian *bulur*, *bolur*, *balur*, *ballur* for beryl and crystal, also term besady is seen in Iranian terminology for beryl. In Aramaic billurin. In Greek

berala, berall, beryllus, and in Latin beryllus. Believed the Greek term is derived from Syriac name *belura*. In Hebrew *belur* and *belura*. In Ethiopic *berel*. Later from term, *berill* or *beryl* with the meaning shining derived the term *brilliance*. Because of transparency of beryl, also, the name eyeglass derived from it such as in German *Brille* in French *bericle* for eyeglass, window panes or as *eye-loupe* which was derived from it.

**berylscope**; an instrument containing colored glass dichromatic filters. Using it genuine emerald and some other true gems appear reddish to violetish, while glass imitations and some natural gems, (such as Brazil emerald), appear green. Acting similarly to the Chelsea color filter. Same as emerald glass. → Walton filter.

**béryl pierreux**; a French term for common beryl.

**beryl pleochroism**; aquamarine: blue to colorless. Emerald: bluish-green, bluish-yellow to green. Red beryl: orange-red and purplish-red. Morganite: dark bluish-purple to pale pink. Heliodor: brownish-yellow to rose-yellow.

**beryl quick test on the field**; → quinalizarin.

**béryl rose**; a French term for morganite or rose beryl.

**beryl schorlacé**; a term frequently used for beryl.

**beryl schorlacé**; a misleading term for pycnite a massive columnar, light pink variety of topaz.

**beryl schorliforme**; a term frequently used for beryl.

**beryl schorliforme**; a misleading term for pycnite a massive columnar, light pink variety of topaz.

**beryl surface growths features**; some feature on the beryl crystal faces as etch figures are shallow raised areas with the name hillocks. It can be seen when looked by magnification and side lighting. Spiral or Screw dislocations, strongly corroded growth on the prism faces are seen. In some transparent greenish-blue aquamarine crystals from Spitzkopje, South Africa, growth accessories such as hillock on the terminal can be seen.

**beryl triplet**; a name for a triplet, made from two portions of green, bluish or colorless beryl, with an adhesive, (cement), layer of a green colored substance between them. Sometimes incorrectly called an emerald triplet. → Aquamarine triplet.

**besad**; same as bosad.

**besady**; Keferstein, C. 1849 believed it is a Persian name for beryl? The term *besady* may be a corrupt term of *bosady* a term derived from *bosad* for coral, which here means coral-colored material or beryl. In some Farsi literature, the term *bosad* is spelled as “*besad*”.

**best cleavage**; a grading term for a diamond block, or cleavage, of good quality, color, and shape.

**beta (β)**; in crystallography, the intermediate index in biaxially mineral, or gemstone. Also called the beta index.

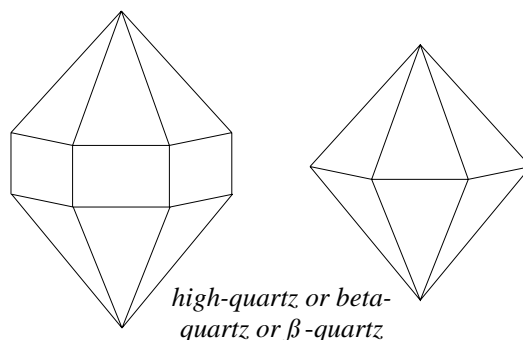
**beta diamond**; the polymorph of diamond that is stable at 1500 K. A pseudocubic crystal. β-diamond.

**beta index (β)**; in crystallography the intermediate index in a biaxially mineral or gemstone.

**beta mineral**; one of two, or more, closely related minerals, termed alpha for low temperature, and beta for high temperature, which can specify a particular physical structure as such a polymorphous modification. That unstable modification displayed at high or intermediate temperature is between those of alpha and gamma, such as beta cristobalite or written β-cristobalite.

**beta particle**; an elementary particle, as an electron or positron, emitted from an atomic nucleus during radioactive decay, which is physically identical to a fast moving electron. It may be either negatively or positively charged. If the beta particle is positively charged, it is called a positron. If beta particle is negatively charged, it is called negatron. Less used synonym: beta ray. Used to irradiate diamond stones but, due to absorption, only the surface color is changed.

**beta quartz**; the polymorph of quartz that is stable between 573° C and 870° C. The most common examples are bipyramidal quartz crystals. This crystal has a vertical axis of six-fold symmetry and six horizontal axes of two-fold symmetry. It has a lower refractive index and birefringence than alpha quartz. Found as phenocrysts, in quartz porphyries, granite pegmatite, and graphic granite. Also called high quartz and spelled β-quartz.



**beta rays**; a term applied to a stream of beta particles.

**beta wollastonite**; same as pseudowollastonite.

**beta zircon**; in mineralogy an obsolete term for any zircon, with properties between high zircon (alpha) and low (gamma) zircons. In heat processes used to change the color of zircons, the properties of beta zircon are converted into those of alpha zircon. Also called intermediate zircon. → Zircon, alpha zircon, gamma zircon.

**betafite**; a brownish, uranium-rich variety of pyrochlor from Betafo in Malagasy. Also called hatchettolite,

ellsworthite, blomstrandite.

**betel nut jade;** a Chinese term for jade with the particular color of betel nut.

**Bethersden marble;** same as shelly marble. A blue-gray to reddish-brown marble, consisting of silicified shells of freshwater snails (*paludina carinifera*). The marble is known as *paludina limestone*, or *Purbeck limestone*. The fossil shells in Bethersden marble are of a larger species of snail.

**betrothal ring;** usually, a solitaire, diamond finger ring, a standard finger ring given as a token of betrothal by a man to his fiancé. Also called engagement ring.

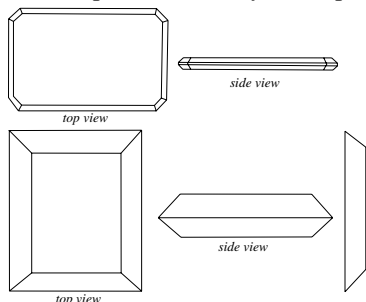
**bevel;** one inclined surface that meets another, at an angle, other than a right angle. Also called cant.

**bevel;** to cut a bevel on.

**bevel;** an angle to be cut or made by a bevel.

**bevel;** slant or inclination of a bevel.

**bevel cut;** any style of cutting a gemstone having a very large table and a pavilion. It may be step cut, brilliant



portrait-cut, bevel-cut or thin-cut

cut or cut in any other style. Mostly used for opaque stones, and often with intaglios. Bevel cut shapes include: round, square, cushion, rectangular, oblong, oval, pendeloque, navette, heart, diamond, horseshoe, shield, pentagon, lasque and hexagon shapes. Used predominantly for less valuable gems. When facets below the girdle are identical with facets above the girdle, it is called a double bevel cut. Also called portrait stone, lasque diamond, table cut and biseau cutting.

**bewijs;** a Dutch term for natural, used by cutters.

**bexoid;** a commercial term for synthetic cellulose acetate, a thermo-plastic, used for imitating amber, turquoise, ivory, tortoise shell, etc. RI:1.47-1.50. SG:1.27-1.37. H:1 rising to 2.00. Commercial terms used for other cellulose acetate plastics: celanse, celatoid, cellmomid, erinoflex, isoflex, lumarith, plastacele, rhodoid, tenite, ulitex, and widolite.

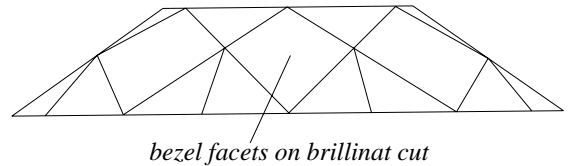
**Beyla;** a district in Guinea, from which diamonds are mined. → Kerouane, Guinea.

**bezeel;** same as bezel.

**bezel;** that part of a brilliant-cut gem above the girdle.

**bezel;** another term for crown.

**bezel;** more specifically, the sloping kite-shaped facets or main facets between the girdle and the table, or only



a small part, (the so-called *setting edge*), of the sloping surface just above the girdle. All lozenge-shaped facets having their apex touching the girdle. The French name is *chaton*.

**bezel;** in a brilliant-cut stone the bezel is a table facet and the 32 surrounding facets. Also spelled *bazil*, *bezeel*, *bezil*, *bizel*.

**bezel-angle gauge;** → diamond-angle gauge.

**bezel facets;** or top main facets. The term applies to four of the eight large, four-sided facets surrounding the table on the crown of a round brilliant-cut stone. In Scandinavian, they are known *upper main facets*. The upper points join the table and the lower points (apex) join the girdle. An alternative name is *templet*. If the stone is a cushion-shaped brilliant, four of these bezel facets are called *corner facets*. In the round brilliant cut, the 8 bezel or quadrilateral facets on the crown have two names four are *quoins* and the other four are called *templets*. Also called kite facets and top main facets.

**bezel-main facets;** same as top-main, or bezel facet.

**bezil;** same as bezel.

**bezoars;** a Persian or Farsi term, spelling: *pâd-zahr*, literally counter-poison.

**bezoar stone;** a solid concretionary secretion found in the stomach of certain animals, especially ruminants, believed to have curative powers, particularly against poisoning. Also used gems, minerals, rocks or other materials as anti-poison such as beryl, emerald, talk, turquoise, etc.

**bhasma;** an Indian term for ash, which used as therapy when first calcined (burning) and take it with other suitable medicine together.

**bho-kyeit;** a Burmese term used for the third class ruby with dark hot pink termed as *bho-kyeit*. → Corundum classification in Myanmar.

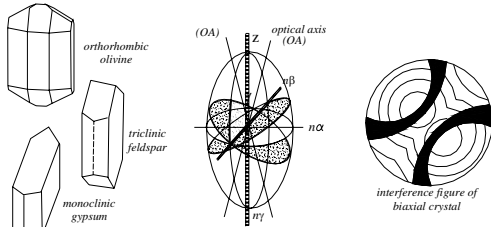
**Bi;** a chemical symbol for the element bismuth.

**Bi;** in some books used for birefringence.

**bi;** a Chinese term for a circular disc made of jade used in the worship of the god of the heaven.

**bianco**; an Italian classification, for white coral of gem quality, valued in Orient.

**biaxial**; the term describes a crystal having two optical



*a three axial ellipsoid of an biaxial crystal with three different refractive indices,  $n\alpha$ ,  $n\beta$  and  $n\gamma$  and three different biaxial crystal systems*

axes, and three main indices of refraction, belonging to the orthorhombic, monoclinic, and triclinic systems. Also written biaxial. Opposite of uniaxial. Also called biaxial crystal. → Birefringence, biaxial stone.

**biaxial crystal**; same as biaxial stone.

**biaxial stone**; stone having three main indices of refraction and two optical axes or directions, in which each direction is singly refractive. → Biaxial.

**biaxial**; → biaxial.

**bieberite**; same as cobalt vitriol.

**Biblical gemstones**; nearly 62 gemstones are mentioned in the bible, although sometimes by a terms different from those by which they are known by today. → Breastplate of the Jewish High Priest.

**Biblical lapidaries**; allegedly first book about precious stones of bible written about 4<sup>th</sup> century by Epiphanius Bishop of Constantia in Cyprus (310?-402 A.D.), who noted Breastplate stones. Also Albertus Magnus described the Breastplate stones, and Wright, R.V. and Chadbourne, R.L. written the book Crystals, Gems and Minerals on the Bible, 1970.

**BIBOA**; an acronym for: Fédération Internationale des Associations de l'industrie, de l'artisant et Du Commerce des Diamants, Perls et Pierres Précieuses, de Bijouterie, Joaillerie, Orfeverrie et Argenterie 1 Noordeinde, Den Haag, Holland.

**bicarbonates**; the acidic salt of carbonic acid  $H_2CO_3$ . A salt containing metal and the carbonic acid.

**Bic'c'hava**; an Indian term used for an emerald or beryl fragment, which is inseparably joined may leads to baleful diverse diseases. → Emerald colors and superstitious in Indian.

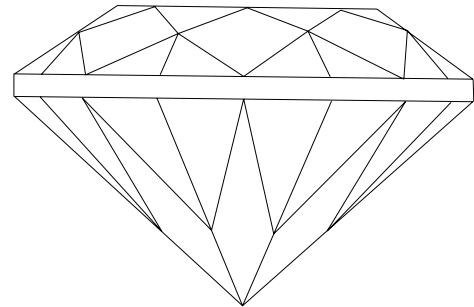
**Bicker-Carteen Diamond**; the white diamond of 56 cts, believed to have once been bought in 1958 by Aga Khan. Present owner unknown.

**bicolor tourmaline**; a tourmaline crystal composed of two colors, such as green and red, etc. → Tourmaline.

**bicong**; a Chinese term for a disc with tube made of jade used as a present from feudal prices to an emperor.

**biconvex lens**; a term applied to a lens, which is convex on both surfaces. Also called double-convex lens.

**bicycle tire cut**; a misleading, slang industry term for the thick girdle a of brilliant-cut diamond.



*bicycle tire cut*

**bidalotite**; same as anthophyllite.

**bieberite**; a rose-red mineral with the formula  $CoSO_4 \cdot 7H_2O$ , occurring in crusts and stalactites. Also called cobalt vitriol, red vitriol.

**big**; an informal term used by Australian miners for a rich strike of opal but not necessarily in large stones.

**Big Five**; the five, big, diamond bearing mines in South Africa: Bultfontein diamond mine, De Beers diamond mine, Dutoitspan diamond mine, Kimberley diamond mine, and Wesselton diamond mine.

**Big Hole**; the most recent name for the open pit at the Kimberley Mine, South Africa.

**Big Rose Diamond**; same as Premier Rose Diamond.

**Biggs jasper**; a silicified volcanic ash or jasper, from Bigg's Columbia, USA.

**big toe**; an informal term used by Australian miners for a drive in which a digger who digs far as possible but without success. Most frequently called long toe.

**bijouterie**; a French term, for jewelry, esteemed for the delicacy of its workmanship, rather than for the value of the materials.

**bijouterie**; a collection of such jewelry.

**bike**; same as boke.

**bikitaite**; a hydrous-spodumene, with the formula:  $2[LiAlSi_2O_6 \cdot H_2O]$ .

**billitonite**; a button-shaped, natural, jet-like glass, (tektite), or moldavite, from Belitung Island (formerly Billiton Island), in Indonesian, near Sumatra. → Tektite.

**Bill's Pearl**; same as Abernethy Pearl.

**billurin**; an Aramaic term for beryl, which may means transparent, quartz crystal-like, or similar to beryl.

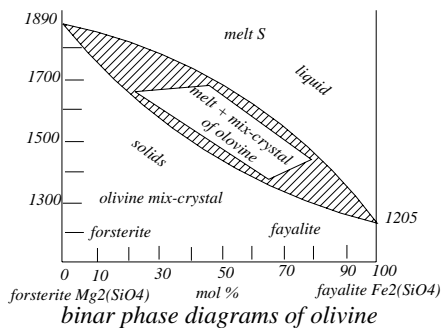
**Bimsstein**; a German spelling of pumice.

**binary**; consisting of two elements or components. → Binary system.

**binary system**: a chemical system, containing two components, such as  $Al_2O_3 \cdot SiO_2$ , or alloys formed by



two metals. Or olivine formed by two minerals,



forsterite and fayalite.

**binarite;** → marcasite.

**Bingara;** a diamond deposit area in the state of New South Wales, Australia.

**Bin Hai Mine;** the large kimberlite diamond mine near Fu Xian, Liaoning Province, China. Reported to have produced the Fenggu No.1 diamond of 60.60 cts.

**binghamite;** a chatoyant quartz, from Minnesota, USA. Its goethite fibers inclusions are fine and its chatoyancy greater than most quartz. Also called chatoyant quartz with goethite inclusions.

**biochrome;** any naturally obtained color from plants or animals. → Biological coloration, schemochrome.

**binocular head loupe;** same as head magnifier.

**binocular microscope;** a compound-microscope fitted with an optical instrument for use with both eyes, consisting of two, small telescopes joined together and mounted on the microscope. A stereo, binocular microscope presents a separate picture to each eye where there are two objectives mounted, each is coupled to its eye piece.

**bioclastic rock;** a rock, consisting of fragments or calcareous remains of organisms, such as some marbles, which contain fossils of shells.

**bioclastic rock;** a rock consisting of fragments of pre-existing rock, which was formed by the action of living organisms.

**biocrystallization;** → biomineralization.

**biogenesis;** formation by the action of organisms, such as coral, pearl, coal, etc.

**biolite;** a group of minerals or rocks, formed by biologic action or organic material. Also called biolite mineral. → Biogenesis.

**biolite mineral;** → biolite.

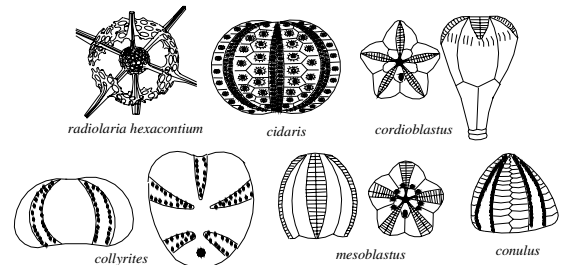
**biolith;** a rock formed by biologic action. → Biogenesis.

**biological coloration;** four major categories of coloration found in biological system: pigments, scattering, interference and diffraction. Biological colors are divided into two grade, *biochromes*, and *schemochromes* or *structural colors*.

**bioluminescence;** the emission of visible light by living

organisms, resulting from catalytic chemical reactions of decay or from oxidation of certain chemical compositions in the substance. Also called chemiluminescence. For example in fire-flies, glow-worms, deep-sea fish, and some fungi.

**biomineralization;** hard fragments of organic animals and seaweeds due to physical, chemical and biological

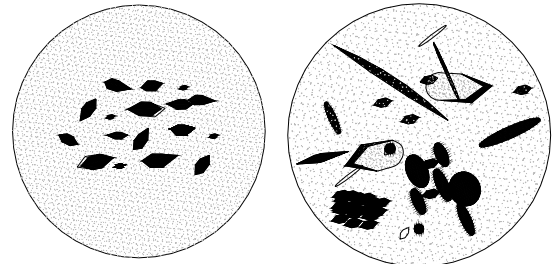


*biocrystals or biominerals*

processes formed carbonate minerals, biomineralization can forced by chemical substances such as collagen, conchiolin, chitin, etc. → Carbonate rock and spongiform.

**bion;** other spelling of byon.

**biotite;** a dark, brown, greenish-black to black colored mica. Varieties of biotite mica are annite, or hydroxyl-annite iron-rich forms such as lepidomelane,



*biotite scales in peridot*

*biotite in emerald from Zambia*

*biotite scales in peridot and emerald*

manganiferous, such as alurgite. Found as inclusion in several gemstones, such as emerald, zircon, garnets, etc. Also called black mica.

System: monoclinic.

Formula:  $2[K(Mg,Fe)_3(Al,Fe)Si_3O_{10}(OH,F)_2]$ .

Luster: splendent, submetallic, also vitreous, often pearly.

Colors: black, dark shade of brown, reddish brown, green rarely white.

Streak: uncolored.

Diaphaneity: transparent to nearly opaque.

Cleavage: {001} highly perfect, {110} perfect, and {010} imperfect.

Fracture: flexible laminae to brittle.

SG: 2.70-3.40.

H: 2-3.

Optics;  $\alpha$ : 1.565-1.625,  $\beta$ = $\gamma$ : 1.605-1.696.

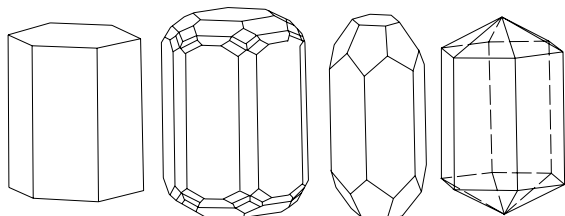
Birefringence: 0.140.  $\ominus$ .

Found: widespread.

**biotite as inclusions;** in some gemstones may can be found scales or small crystals such as in peridot or in Zambia emerald.

**BIPC;** an acronym of: **B**ureau d'**I**nformation des **P**erls de **C**ulture, Paris.

**bipyramid;** same as dipyramid. In crystallography, a closed crystal form of double-ended pyramids so that



bipyramidal crystals

appear as mirror images across the plane of symmetry. Each pyramid is built of triangular faces, 3, 4, 6, 8, Or 12 in numbers.

**bipyramidal crystal;** → bipyramid.

**bipyramid etch marks on beryl;** etching effect on the both ends of bipyramid hexagonal of morganite beryl from Brazil exhibit orientated trumpet feature with the *c*-axis. → Trumpet etching marks on beryl.

**biquartz plate;** a type of compensator in a polarizing microscope, used to accurately detect the position of extinction of a crystal or mineral. Two pieces of quartz, one right-handed and one left-handed, are cut perpendicular to their axis and are cemented side by side and used as a Nicol prism, to study polarized light.

**bird's brain;** a Chinese term for opaque, dark yellow amber. In Chinese called Chio-Naio.

**bird's-eye;** a spot, tube, or irregular patch of sparry calcite, commonly found in limestone and some dolomites. Also called calcite eye.

**bird's-eye limestone;** a very fine-grained limestone, containing speckles or pipes of crystalline calcite. Also called dismicrite.

**bird's-eye marble;** a marble, in which the beauty of the markings have the appearance of a bird's-eye, caused by crinoids or sea-lily fossils. Varieties are Hopton marble, Derbyshire fossil marble, Belgium marble. Bird's-eye marble in Belgium is known as petite granite marble, because of the granularity of the stone and its resemblance to granite.

**bird's-eye pearl;** pearls from fresh-water mussels with dark, eye-like rings.

**bird's-eye porphyry;** a fine-grained igneous porphyric rock, having small phenocrysts of quartz, which resemble a bird's-eye.

**bird's-eye quartz;** a colored jasper, containing small spherulite particles usually of colorless quartz resembling a bird's-eye.

**bird's-eyes;** term applied by American fishermen to pearls, which have slight imperfections on a top quality surface.

**Bird of Paradise;** the precious Australian opal, purchased by the late J. Pierpont Morgan for the Morgan Collection.

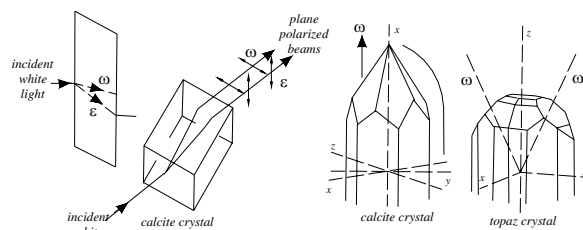
**bird of paradise agate;** fine, translucent, plume agate, (chalcedony), from Mexico.

**bird-wing pearl;** fresh-water, or, salt-water baroque pearl, which is wing-shaped.

**bireflectance;** some crystals are able to split a ray of ordinary light into tow beams of unequal velocities, other than those of the isometric crystal system. The difference between the greatest and least indices of refraction of a crystal is positive or negative. → Birefringence, single refraction, double refraction. Also called reflection pleochroism.

**birefraction;** same as birefringence.

**birefringence;** the ability of crystals to split a beam of ordinary light, into two beams of unequal velocities,



birefringence in minerals

which vibrate in two planes, at right angles to each other, known as orthogonal polarization. This property occurs in anisotropic crystals at different velocities in different directions. Uniaxial minerals have one direction, where double refraction does not occur, but biaxial crystals have two directions. The difference between the greatest and the least indices of refraction in a biaxial, crystal (for example in calcite, where two images can be seen), is expressed by numbers such as 0.006 for danburite:  $\alpha$ :1.630 and  $\gamma$ :1.636. Synthetic rutile has the highest birefringence 2.87. In some gems in which birefringence is strong, when viewed through the table, a doubling of the of the pavilion facets are visible to the naked eye. Also called double refraction, birefraction. → Biaxial, double refraction.

**birefringence blink;** a term used for optical properties of massive rhodochrosite may show a spot birefringence blink from 1.60 to upward of the refractometer. This effect may be seen in coral.

**birefringence filter;** a filter is made from crystal plates of a birefringence substance such as quartz.

**birnite;** same as burmite.

**Birim River Valley;** an alluvial diamond deposits in Ghana (Gold Coast), Africa.

**Birne;** a German term for boule or pear-shaped.

**Birmingham Diamond;** the octahedron, yellow diamond of 4.25 cts, found in 1900, near Birmingham, Alabama, USA. Now in the American Museum of Natural History, New York City.

**Biron hydrothermal synthetic emerald;** an early hydrothermal technique used to color synthetic stones by means of metal oxides of vanadium. Now they are colored by both vanadium and chromium, and chlorine. Optics;  $\omega$ :1.567-1.571,  $\epsilon$ :1.577-1.578. Birefringence: 0.007-0.008. SG:2.67-2.70. The same method used by Emerald Pool Mining Company in Australia, where stones contain gold fragments, phenakite crystals, needle-like structures, two phase inclusions, etc. Synthetic pink beryl is made by the same method, when  $Ti^{+3}$  are added. → Synthetic emerald.

**birthstone;** a gemstone that has been associated, by superstitions and religious tradition as appropriate to the time or month of one's birth. The modern list as issued:

table 1: birthstones

MONTH	COLOR	STONE
January	dark red	garnet
February	purple	amethyst
March	pale blue	aquamarine, bloodstone
April	White	diamond, quartz
May	pale green	emerald, chrysoprase
June	cream	pearl, moonstone
July	red	ruby, carnelian or onyx
August	pale green	peridot, sardonyx
September	deep blue	sapphire, lapis lazuli
October	various	opal, tourmaline
November	yellow	topaz or, citrine
December	sky-blue	turquoise or zircon

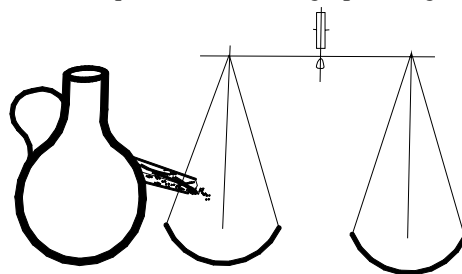
It is to be noted major changes have been made replacing alexandrite is given as a stone for June, lapis-lazuli with zircon for December, and moonstone with pearl, for June. There are also *birthstones* for days, hours, signs of the zodiac, and seasons. Also called natal-stone.

**birthstone alternate;** in association with tradition as appropriate to the time or month of birth exist different stones from different authorities which are in constant change as they are in especial books issued.

**birthstones origin;** the begin of the use of the stones in

relation with birth month and twelve apostles or twelve zodiacal signs is unclear but due to Kunz who mentioned that the origin of the use of stone wrote for first time by Flavius Josephus, the Jewish historian (1<sup>st</sup> century A.D.) and later by St. Jerome in the early of 5<sup>th</sup> century. Both authorities proclaim the association with tradition as appropriate between time or month of birth and twelve stones.

**Biruni's specific-gravity balance;** a historical balance was developed from Iranian scientist about 973 to 1050, a technique for determining specific gravity of



*Biruni's balance, after Khazeni's mizan-al hakama. Redraw from author*

irregular shaped gemstones according to exploiting Archimedes' principle. Biruni reported precise specific gravity of 15 gemstones, 8 metals, and 6 liquids. The balance drowns after Al-Khazini's, mizan-al hakama, Tehran, 1968.

**biscuit;** an unglazed, ceramic ware that has been fired in a biscuit oven. Also spelled bisque.

**biscuit;** a term used by Australian miners for a brittle crumbly band biscuit like of colored stone, lies immediately under the sandstone. Also called biscuit band.

**biscuit band;** same as biscuit.

**biseau cutting;** another term for bevel cut.

**bisectrix;** in a biaxial crystal, the line that bisects the angle, formed between the optic axes.

**Bishfota;** an Indian term means avoid to wear an emerald with yellow spots, which will bring death. → Emerald colors and superstitious in Indian.

**bishop's head;** when an octahedral crystal of diamond is being saw, usually it is divided across the natural girdle. The result is two brilliant-cut stones, with the name „bishop's head“.

**bishop's ring;** a modification of a gold finger ring worn by a bishop during the celebrations, set with an unfaceted or unengraved stone, usually a sapphire or an amethyst. Also called episcopal ring.

**bishop's stone;** another term for amethyst.

**Bismarck Sapphire;** the dark blue sapphire of 98.60 cts, from Sri Lanka, set in a pendant. It was presented by Mona Bismarck to the Smithsonian Institution, Washington, D.C., USA.

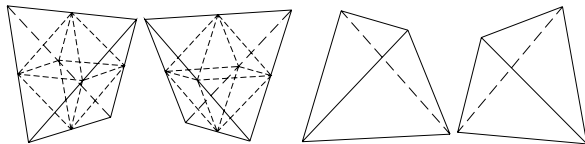
**bismuth**; a white, brittle, metallic element in group V of the Periodic System. It has a reddish tinge and the symbol Bi. Used in alloys and solder.

**bismuth germanates**; an orange, synthetic stone from less important. Crystal system: cubic. Chemical composition:  $\text{Bi}_4\text{Ge}_3\text{O}_{12}$  or  $\text{Bi}_{12}\text{GeO}_{20}$ . RI:2.07. SG:7.12. H:4½.

**bismuth silicate**; a colorless, brown to orange synthetic stone from less important. Crystal system: cubic. Chemical composition:  $\text{Bi}_{12}\text{SiO}_{20}$ . RI 2.00.

**bismutotantalite**; a massive mineral,  $(\text{Bi,Sb})(\text{Ta,Nb})\text{O}_4$ . Orthorhombic crystal. Adamantine to submetallic luster. Brown to black. Streak: yellow to black. Optics:  $\alpha$ :2.387,  $\beta$ :2.402.  $\gamma$ :2.427. Birefringence: 0.040.  $\oplus$ . SG:8.84. H:5. Found in Uganda, and Brazil. Sometimes cut as gems.

**bisphenoidal crystal**; a crystal form that consists of four



*bisphenoidal crystals*

faces triangular shape; those at right-angles to one another are a chisel-like.

**bisque**; same as biscuit.

**bit-crown metal**; same as diamond matrix.

**bitellos**; in Brazilian a term used for large diamonds.

**bit matrix**; same as diamond matrix.

**Bitner templates**; known in the jewelry trade a template, made by Bitner. → Templates.

**bitter spar**; a pure, crystalline variety of dolomite.

**bitumen**; a term used for a nonmineralized substance such as coal, lignite, etc., which occurring naturally as solid or semi-solid of hydrocarbons in black or dark color with a peculiar pitch odor. Also, a group name for waxes, asphalts and related substances.

**bituminous gypsum**; a gypsum which is high in hydrocarbons matter or asphalt.

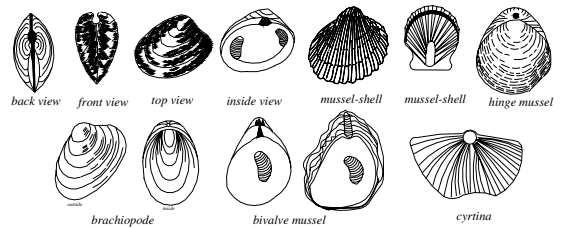
**bituminous limestone**; a limestone, which is naturally impregnated with asphalt.

**bivalent**; → divalent.

**bivalve**; a mollusk, having two equal or subequal shells that open and shut, such as oyster, mussel, and clam. Also called pelecypod. → Bivalve mollusk.

**bivalve mollusk**; a mollusk having two equal or subequal valves, that are slightly hollow on the inner

side and hinged along one edge, controlled by adductor



*bivalve mussels, brachiopods and oysters*

muscles, such as oyster, clam, and mussel. → Bivalve.

**Biwa pearl**; a variety of non-nucleated, cultured, fresh-water pearl, grown at Biwa-Ko (ko means lake), Honshu, Japan, which is the largest fresh-water lake in Japan and the center of its fresh-water pearl-farming industry. Such pearls are grown by the insertion of a fragment of mantle from a fresh-water mussel into the host. The non-nucleated product is typically brown to salmon colored, and rarely white, oval or baroque in shape, has an attractive luster, and is about 3 x 6 millimeters in size. Most of those that are bright white in color are bleached. The host is the fresh-water mussels *Hyriopsis schlegeli*, which in Japanese, are called *ike-chogai*, or *Cristaria plicata*. SG:2.67-2.70. → Non-nucleated cultured pearls.

**bixbite**; a misleading term rarely used for a manganese-rich, gooseberry-red, gem-variety of beryl, from Thomas Mountain, Utah, USA.

**bixbite**; a manganese mineral of  $16[(\text{Mn,Fe})_2\text{O}_3]$ , which occurs together with braunite and variously-colored rhodochrosite, found in the Kalahari Desert, Cape Province, South Africa.

**bixie**; a Chinese term for carved mythical beast similar to unicorn made of jade used as amulet to ward off evil influence.

**bizel**; same as bezel.

**bizen**; a Japanese term for a hard, unglazed pottery.

**bizet**; in gem cutting, the part of a brilliant between the table and girdle, occupying one-third of its depth and having 32 facets.

**B-jade**; a commercial acronym for bleached jade. Also called *grade B-jade*.

**Bk**; a chemical symbol for the element berkelium.

**Blaauwboschkuil**; a minor alluvial diamond mine in Transvaal Province, South Africa.

**black**; a term used by Australian miners for a dark color opal such as black, dark-blue, dark opal.

**black**; a term used by Australian miners frequently for potch in which black opal is found.

**black alexandrite**; a misleading term for a type of synthetic sapphire, with a pseudo-pleochroism effects.

**black amber;** a misleading term for stantienite, jet or retinite having very high oxygen content. Also called black amber of Whitby.

**black amber;** a term for black amber mixed with white a variety of osseous having organic material as inclusions because decayed botanical particles of carbonized wood appeared black. Sometimes carbonized wood is as black specks in amber to seen.

**black amber;** a misleading term for an artificially dyed black fossil resin or amber.

**black amber of Whitby;** a misleading term used for jet or retinite from Whitby, England. Also called Becker amber, stantienite, black amber.

**black and gold marble;** a dark-gray to black, siliceous dolomitic limestone, which is traversed by golden-yellow veins, from Port Veneer, Isle of Palmeria, Italy.

**black and white amber;** → black amber.

**black and white onyx;** onyx with alternating white and black stripes. The black (or colored) bands are sometimes artificially colored. Many cameos or intaglios are cut from this stone.

**black andradite garnet;** same as melanite, a variety of andradite. Also called black garnet, and black andradite garnet.

**black beryl;** a variety of beryl from Mozambique and Malagasy probably contain numerous inclusions and due to manganese as impurities.

**black blende;** same as pitchblende.

**black-centered stone;** same as dark-centered.

**black chalcedony;** another term for black onyx.

**black chalk;** a bluish-black, chalky clay, shale, or slate containing carbon.

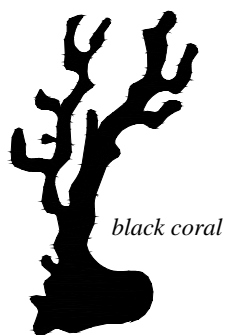
**black chert;** carbonaceous chert occurring in South Africa.

**black chert;** a term used in England for flint.

**black clam pearls;** → black pearl.

**black coal;** same as anthracite.

**black coral;** a coral, consisting mainly of conchiolin of a black to dark-brown color. Horny to dull luster. It is



used in beads, bracelets, art objects, etc. and highly regarded by the natives of the East Indian Islands.

SG:1.37. H:2-3. Source: northern coast of Australia, Malaysia, Red Sea, Bermuda, Hawaii and the Mediterranean. It is also wrongly called *King's coral* and *akabar*. Known as *Antipathes spiralis*. → Blue coral, akori.

**black cultured pearl;** a misleading term for artificially black stained cultured pearl. → Dyed pearl, pearl staining.

**black dammar;** an opaque, black or very dark resin from the Philippines. Often it is included with copals. Also called damar hitam. → Dammar.

**black diamond;** a very dark, gray to black, blue, green, or brown gem-quality diamond, the color of which is due to microscopic, black inclusions. Also called framesite.

**black diamond;** a synonym for carbonado, a form of industrial grade diamond.

**black diamond;** a misnomer for a dense, black variety of hematite.

**black diamond;** a misleading term for anthracite that takes a polish, like metal.

**black diamond;** a synonym for coal.

**Black Diamond of Bahia;** the black diamond of 350 cts, from Bahia, Brazil. Present location unknown.

**black-dyed opal;** a type of Australian opal, which has been stained black, to enhance the play of color. In this process, the stone is impregnated with a sugar solution or glucose, and then, it is treated with sulfuric acid, which produces a black background, due to the carbonization of sugar; this is known as *carbonizing*. → Opal dyeing, black opal.

**black-edged shell;** a variety of green nacre shell nearly as large as the Australian pearl-oyster, scattered around the southern Pacific Ocean.

**black Egypt ware;** fine-grained, dark-colored basalt, from Egypt.

**black enamel;** an enamel similar to black glass which is harder than jet. Used as jet imitation.

**blackened culet;** a culet that has a spot of black paint or was blackened by pitch, a practice of some earlier cutters.

**blackened opal;** an inferior quality opal, with small specks of color, such as *pinfire opal*, that have been blackened by treatment, with black plastic or sugar-sulfuric acid. Also called black-treated opal.

**black fellow's buttons;** small, rounded pieces of glass, of meteoritic origin (extra-terrestrial tektite). Found in Australia. Also called black men's buttons.

**black garnet;** same as melanite, a variety of andradite.

**black glass;** ordinary glass, containing manganese or ferric oxides.

**black glass;** black glass can produce by adding transitional element colorants as cobalt and nickel.

Used as jet imitation.

**black gold;** a placer gold, coated with a dark-brown or black film, oxide of manganese.

**black gold;** maldonite, a bismuth-gold mineral.

**black granite;** a commercial term for granite (or diabase, diorite or gabbro), that, when polished, is dark gray to black.

**black hematite;** a misnomer for romanechite, because this mineral contains no iron.

**Black Hill Beryl;** a giant size beryl of 60 tons in weight, quarried from Ingersoll quarry, Black Hill, USA.

**black iron oxide;** same as magnetite. → Turnbull's blue.

**black jack;** → black-jack.

**black-jack;** a popular term for dark-colored sphalerite, or zinc blende. Also spelled blackjack. Also written black jack.

**black jade;** a misnomer for olive green nephrite, from Crooks Mountain, Wyoming, USA.

**Black Jade River;** a jade source in Khotan, eastern Turkistan with the name Kara-Kash (Black Stone).

**black jasper;** another term for basanite.

**black-lipped shell;** a variety of pearl-oyster *Pinctada margaritifera*, which is somewhat black at the lip of the shell. Found near the Australian coast and in the Persian Gulf. Fished for mother-of-pearl, which is known as Bombay shell.

**black lamp;** a type of ultraviolet lamp, which produces a large spread of UV light.

**black lava glass;** a massive, jet black, natural obsidian glass occurring at Mt. Helca, Iceland and Yellowstone National Park, USA and elsewhere.

**black lead;** a commercial term for graphite.

**black light;** a portable instrument that produces ultraviolet light.

**black light;** a miner's and prospector's term for ultraviolet light, used to detect fluorescent minerals.

**black magnetic rouge;** a polishing and grinding material, consisting of 99% magnetite ( $\text{Fe}_3\text{O}_4$ ).

**black malachite;** an incorrect name for chalcedony, with the inclusions of black manganese mineral, (psilomelane), arranged in bands. Also called crown of silver, or psilomelane chalcedony.

**black manganese;** same as pyrolusite, psilomelane, and hausmannite.

**black marble;** black marble, often veined with white marble, mostly obtained from Namur, Belgium, and known as *noir Belgé* or Belgian black marble. Tournai marble one is variation.

**black marble;** same as Porto marble.

**black matrix;** a kind of turquoise with black patches of matrix found in Nevada, USA.

**black men's buttons;** small rounded, pieces of glass,

found in Australia and Tasmania, thought to be of probable volcanic or meteoric origin. Also called black fellow's buttons.

**black mica;** same as biotite.

**black moonstone;** a misnomer for colorless, transparent, labradorite feldspar, which is a dark color because of needlelike inclusions, and has a bluish play, and to some degree a cat's-eye effect, when cut cabochon. It exhibits wavy luminescence under UV light, and is light green under X-rays. Found in Malagasy, Africa.

**blackmorite;** a reddish-yellow variety of opal, from Mount Blackmore, Montana, USA.

**black ocher;** same as wad.

**black onyx;** the popular, but incorrect term for black colored agate, or chalcedony, which is usually artificially colored. The stone is impregnated in a sugar ( $\text{C}_{12}\text{H}_{22}\text{O}_{11}$ ), or glucose solution, then treated with sulfuric acid, which removes the water from the sugar and produce a black colored stone. Often called black chalcedony. Used as a jet imitation.

**black opal;** a rare variety of iridescent, precious opal of dark-gray, rarely, black or some other very, dark color, almost opaque. Its internal reflections are usually red or green when displayed against a dark bodycolor. Black opal consists of small, iridescent, opal spheres, which causes a play of color, due to diffraction of light. True black opals are found only at Rainbow Ridge field, in Nevada, USA. Fine Australian blue opal, with flame-colored flashes, is also typically found in Lightning Ridge. Imitations, made from inferior opals are impregnated with sugar solution or glucose that is treated with sulfuric acid, which produces a black background, due to the carbonization of sugar. This is known as *carbonizing*. → Australian opal, white opal.

**black opal cut;** cut cabochon, rarely carved, faceted or engraved.

**black opal doublets;** oval or rounded cabochons, with thin layer of opal on top, from Australia.

**Black Orloff Diamond;** the black, cushion-shaped diamond of 67.50 cts, from India. It weighed 195 cts, rough. Named after the Russian Princess Nadia Vyegin-Orloff. Also known as the Eye of the Brahman Diamond, it was privately sold in 1997. Also spelled Black Orlov Diamond.

**Black Orlov Diamond;** same as Black Orloff Diamond.

**black pearl;** a commercial term for grayish, brownish, bluish-green, or greenish black pearls found in the Gulf of Mexico and certain Pacific Islands. The cause of the color is not clear but thought to be due to the nature of the water, in which the mollusks live. RI:1.53-1.69. SG:2.61-2.69. Usually, black pearls are artificially colored, by polishing spheres of hematite. Black clam pearls are not nacreous.

**black pearl**; a misleading term for polished, hematite spheres, similar to black pearl, but they have greater hardness and specific gravity and, a red streak on unglazed porcelain.

**Black Prince Ruby**; a misleading term for the famous, large, red spinel estimated to be 170 cts, which is set in the front of the British Imperial State Crown, once thought to be a ruby. The stone has never been cut, polished it is of irregular shape, its weight is unrecorded, and is 5 cm long. Sometimes called Balas Ruby.

**black sand**; an alluvial or beach sand, of heavy, dark minerals or rocks, of ilmenite, megnebite or other dark heavy minerals, associated sometimes with gold, cassiterite and platinum.

**black sapphire**; black or very dark color blue, brown, purple and green varieties of sapphire.

**black seed pearl**; very small pieces of blackish, or dark-colored pearl, from the *Pinna mollusc*.

**black shorl**; another term for black tourmaline.

**black silver**; a synonym for stephanite.

**black spinel**; a variety of spinel found in Monte Somma, Vesuvius, Italy and in Thailand, where locally it is known as *nin*. The attractive, dark greenish, black spinel from Sri Lanka is called *ceylonite* or *pleonaste*.

**black spot**; a small spot of black color which can be seen on the culet or foil of the of most 18<sup>th</sup> century glass stones, when viewed through the table. This caused by a pitch-like paint. This also can be seen on some diamonds and other gemstones from the 18<sup>th</sup> century.

**Black Star of Africa Diamond**; the black colored diamond of 202 cts, after cutting. Found in Zaire, Africa. It is believed to be the largest colored diamond in the world. Present owner unknown. Was exhibited in 1971 in Tokyo, Japan.

**Black Star of Queensland (Sapphire)**; the asteriated sapphire of 1,165 cts, in the rough found in 1948 in Anakie, Queensland, Australia. Cut as an oval-shape, it still weighs 733 cts, and has a fine star. The Kazanjian Foundation of Pasadena, California, to the Smithsonian Institute, presented Washington, D.C., USA, where it is on display this stone, together with those of Presidents Lincoln, Washington, Eisenhower and Jefferson, as a gift to the American people in 1957. → Washington Sapphire, Eisenhower Sapphire, Jefferson Sapphire, Lincoln Sapphire.

**blackamoor**; the head or bust of a young male or female black African, cut as cameo or as an ornament, set in a pendant, brooch, or worn as hat-pin or used as a seal. Usually made of black onyx or black-dyed chalcedony.

**black tin**; same as cassiterite.

**black tourmaline**; another term for shorl.

**black turquoise**; a misnomer for jet.

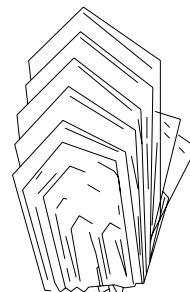
**black turquoise of Whitby, the**; a misleading term used for jet or retinite from Whitby, England.

**black treated opal**; same as blackened opal.

**black whale**; same as sperm whale. → Sperm-whale ivory.

**bladed aggregate**; → blade aggregate.

**blade aggregate**; a mineralogical term, used for a mineral in the form of an aggregate of flattened,



*bladed aggregate of stilbite. After Sinkankas 1967*

bladelike, or elongated crystals such as stilbite.

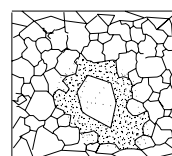
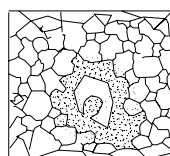
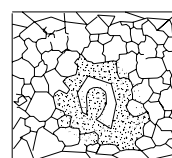
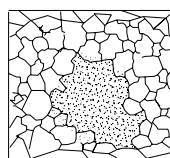
**blanc de chine**; a brilliant white glaze, over a fine white, porcelain body.

**blanc fixe**; a synthetic white powder, of barium sulfate, used in the paint industry, as a pigment extender and for polishing. Also called permanent white, terra ponderosa, artificial heavy spar.

**Blanche of Anjou Emerald Crown**; a crown belonged to the wife of King James II of Spain (late 13<sup>th</sup> and early 14<sup>th</sup> centuries), set with numerous of emerald.

**blast**; same as eruption.

**blastic growth**; a dynamothermal metamorphism process, formed by recrystallization from previously



*blastic growth of beryl crystal in a pematite, After Grigor'ev 1975*

existing minerals, which are elongated perpendicular to the direction of greatest pressure such as new beryl mineral.

**blastocyst**; nuclear forming of an embryo in a mussel.

**blauw grond**; same as blue ground.

**bleached**; a mineral or sand, which has become pale, due to bleaching by nature.

**bleached jadeite**; in order to remove a brown color, a

stone is put in hydrochloric acid, or impregnated with opticon and paraffin wax, or other polymers can appear. Commercially it is termed as *B jade*, or, *grade B jade*.

**bleached pearl;** a dark-colored pearl of unattractive appearance, (due to dark conchiolin), which has been lightened by placing it in a warm, weak solution of hydrogen peroxide. Generally, sunlight has a bleaching effect of pearls. → Over-bleached pearl.

**bleaching gemstone;** a mineral, which has become pale, due to natural bleaching.

**bleaching gemstone;** bleaching of brown tiger-eye to pale brown by chemical treatment, and then it possibly recoloring to a desired hue.

**bleaching gemstone;** when skin oils darken turquoise it can be restored by bleaching.

**bleaching gemstone;** ivory, which has absorbed oil can be restored by bleaching, like turquoise.

**bleaching gemstone;** same as bleached pearl.

**bleaching of cultured pearls;** cultured pearl after opening and removing are washed free from slime and mucus and dried. Most of cultured pearls are greenish or darker in color when they fresh extracted and most of this lost their color when bleached with hydrogen peroxide solution. Generally, sunlight has a bleaching effect of pearls.

**bleak fish;** a small fish of *Alburnus lucidus* with a silvery scales essence caught in the river Seine, France, and recently Sardine herring, which resembles the luster and orient of natural pearl. The material, which is crystalloids of *guanine 2-aminohypoxanthine* is grounded, suspended in a solvent in ether-amyl-acetate solution, and mixed with a nitrocellulose lacquer to make a paint substance. The material is used to paint the interior of a glass bead or the exterior of a bead of glass, mother-of-pearl, or other material.

**bleb;** a small, usually rounded inclusion.

**blebby;** consisting of bubbles, cavities or vesicles.

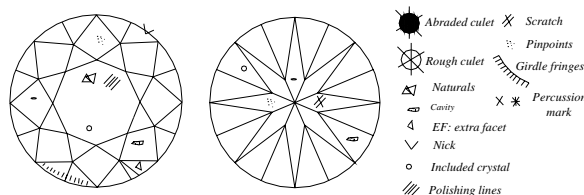
**bled;** a term used in India, for sapphire, which changes color in different lights. → Sapphire.

**bleeding of color;** deep, blood-red colored, spot-like depressions, fractures, and fissures on the surface of a diffused corundum.

**belgé black marble;** same as noir belgé.

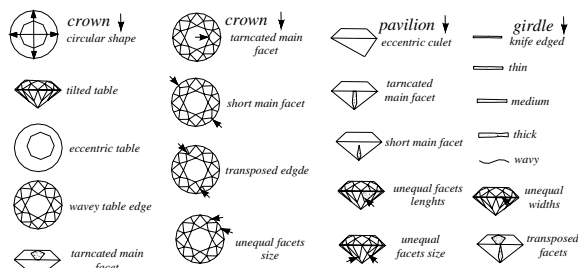
**blemish;** a term used for an imperfection on the surface of a fashioned diamond as distinguished from an internal imperfection or flaw. The main external blemishes of diamonds are: 1. Scratches, 2. Chips and nicks, 3. Pits or cavities, 4. Flats on the girdle, 5. Naats on the surface, 6. Polishing lines, 7. Burn marks, 8. Natural or naif, 9. Rough girdle, 10. Rough or broken culet, 11. Twinning lines or naat. A blemish is to be distinguished from a flaw, which is an internal imperfection.

## blemish symbols of external symmetry; imperfections



blemishes on facet diagram or polting symbols

on the surface of a fashioned diamond depending on the



blemishes symbol of external symmetry of brilliant

symmetry of cut stone.

**blende;** same as zinc blende or sphalerite.

**blende;** any metallic-sulfide minerals, with a somewhat bright or resinous, but nonmetallic luster such as sphalerite.

**blended pearls;** this term refers to pearl necklaces, which are blended according to size, hue, tone and intensity of the color of the beads. → Matched pearls

**blendous;** containing or pertaining to blende. Also called blendy.

**blendy;** same as blendous.

**bleu belgé marble;** a soft, gray-blue marble, from Belgium. → Bardiglio marble.

**bleu persan;** a form of pottery, in which a white pattern is painted over a dark blue background. Used in Persia for turquoise colored beads.

**bleu turquin marble;** same as Bardiglio marble.

**blibe;** elongated bubbles in glass, larger than a seeds.

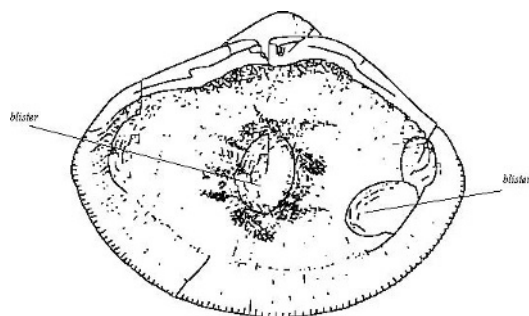
**blink;** a term used in refractometer measuring by spot method, when spot appears to move up and down rapidly in the scale of refractometer, which may appear never to be half and half for example the spot may move or blink from outermost dark at 1.63 to outermost light at 1.65, therefore the average of refractive index is approximately 1.64.

**blinking;** a term used to gem quality chalcedony between crossed polaroids transmit enough light, become an aggregate-type reaction, therefore coarse crystalline varieties show a typical blinking reaction



because of doubly refractive stones.

**blister pearl;** a variety of pearls, usually hollow and irregular in shape, which have been formed over an irritant, such as parasites,



*covered blister pearls in mussel*

the mollusk, which caused it to secrete nacre over the irritant. When the pearl is removed from the shell the pearl has a hemispherical, or irregular form and a rough back, not covered by nacre. This generally has a flat underside and is covered by the setting. Sometimes a parasite gets into the shell, which causes the mussel to form a protective secretion around the parasite or shell-boring animal. This is not a true pearl. Also called chicot pearl or wart pearl. → Pearl, pearl doublet.

**blister pearl;** a misleading term for imitations of blister pearls made from mother-of-pearl, in which the beads are covered with oriental essence.

**bloagrün topaz;** a Swedish misleading term for beryl.

**block;** a term used by Australian miners frequently for an area of opal mining found in with gold.

**block amber;** natural, dropped sea amber, in the form it has been found in, to distinguish it from pressed amber. The pieces are too large enough for fashioning into gems or ornaments.

**block caving;** the current method of continuously mining diamond pipes by blasting underground caves in the kimberlite. The roof, of the caves breaks up and the pipe is drawn out by crushing.

**blocker;** a diamond cutter who puts in the table, culet, (if any), and 16 other main facets. On the top he puts in the table the four bezels, and four top-corner facets. On the base he puts in eight pavilion facets, (four pavilion and four bottom-corner facets), and the culet, (if any). The four facets above and four facets below the gemstone are called a four-square or a cross. Also called diamond cross-worker, cross cutter, lapper, or eight-square stone. → Blocking.

**blocking;** synonym for cross work. The process of placing the first 17 or 18 facets on a diamond brilliant. Also called lapping.

**blocking;** a mixture of silicon carbide, grit and water, which is used in lapidary, as an abrasive. Also called

mud lapping.

**blocking off;** a technique used to prevent conjugation between two colors such as yellow dye molecule  $D_1$  and a blue dye molecule  $D_2$ . Whereas each dye molecule act separately from other one in acidic medium such as phenolphthalein  $[(C_6H_5OH)_2C_2O_2C_6H_4]$ , when molecules are in alkali medium they produce a deep-red dye. This color change happens due to structure change and named as halochromism.

**block out;** a term used by Australian miners for dividing of an area of opal dirt into blocks for transporting.

**block talc;** a term used for any mass of talc or saponite that can be worked by machines.

**blocky;** a term used by Australian miners for a dark colored, crumbly iron-stained variety of opal.

**blocs;** large parting fragments of diamond.

**Bloemhof;** a minor alluvial diamond deposit in Transvaal, South Africa.

**Blomstrandite;** → betafite.

**blonde shell;** a variety of plain, orange-yellow, tortoise-shell or hawksbill turtle sea turtle, (*Chelone imbricata*), which is obtained from the belly shield or plastron. Commercially called yellow belly. Used as an amber imitation, and to make into hair combs and beads.

**blood agate;** flesh-red, pink, or salmon-colored agate, from Utah.

**blood agate;** another term for hemachate. Also called bloody agate.

**blood coral;** a term sometimes used for intense precious red coral.

**blood drops;** waterworn, alluvial pebbles of red spinel.

**blood ironstone;** another term for hematite.

**blood jasper;** another term for bloodstone, or heliotrope.

**bloodshot iolite;** a flesh-red variety of cordierite, from Sri Lanka. The color comes from small, thin hexagonal plates of hematite or goethite, which sometimes causes pseudo-dichroism.

**bloodstone;** a massive, semitransparent, leek to dark green variety of chalcedony, known as plasma, consisting of speckles red or brownish-red jasper, resembling drops of blood. Also called heliotrope and bloodstone jasper. Often used in signet rings, for carved objects and amulets. Found in Brazil, Australia, India, and USA.

**bloodstone;** also, an obsolete term for hematite.

**bloodstone jasper;** same as bloodstone.

**bloody agate;** same as blood agate.

**bloom;** a lump or mass of molten glass.

**bloom;** a surface film, produced by weathering.

**bloom;** efflorescence, a variety of fluorescence of altered, metallic salt at the surface for example a cobalt bloom.

**bloom;** a coating of film, given to the surface of a lens, prisms, or filter, in order to minimize reflection.

**bloomed;** a term used by jet jewelry for counteract the beads with French glass. Also called bloom finish, coated.

**bloomed finish;** → bloom.

**blooming;** some pastes are bloom, like camera lenses. This film is made of substance with low refractive index.

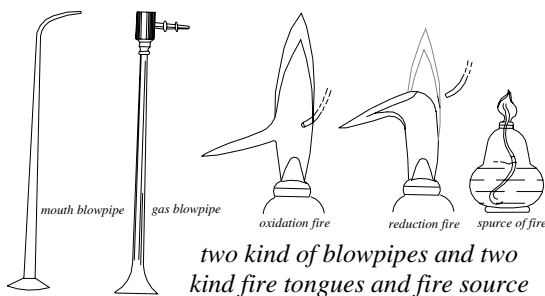
**blotched;** spotted effect, especially on a mineral, (heliotrope), rock and marble.

**blotting paper;** when studying the surface of an imitation pearl, which has been coated with essence d'orient with a hand loupe, the surface has the appearance of blotting paper, which is not seen in natural or cultured pearls.

**blowing-iron;** same as blowpipe.

**blown sand;** sand, which is transported by wind. Same as dune sand. → Sand dunes.

**blowpipe;** a small, laboratory device, in the form of a tube, to carry a stream of air to a Bunsen burner flame, in order to get a rapid determination of the approximate composition (merely qualitative) of minerals and ores.



Also used in soldering and flame tests. Also called blowing-iron, in the glass industry.

**blue amber;** a variety of opaque amber with vast number of microscopic gas bubble inclusions, which also caused variations of color and brittleness. Also, glauconite is responsible for blue and greenish-blue colors.

**blue alexandrite;** a misleading term for alexandrite-like sapphire.

**blue amber;** a misleading commercial term for a very rare variety of osseous amber, with a bluish tone, which is probably due to the presence of calcium carbonate or vast number of microscopic gas bubble inclusions which caused variations of color and brittleness.

**Blue Aquamarine;** a dark blue aquamarine of 6 kg. Now on display at American Museum of Natural History in New York, USA.

**Blue Aquamarine;** an aquamarine of 737.00 cts. Now on display at American Museum of Natural History in

New York, USA.

**Blue Aquamarine;** an aquamarine of 400.00 cts. Now on display at American Museum of Natural History in New York, USA.

**Blue Aquamarine;** a step-cut aquamarine of 144.51 cts. Now on display at American Museum of Natural History in New York, USA.

**blue asbestos;** a variety of hydrous crocidolite, amphibole riebeckite, silicate of sodium and iron, occurring asbestos, found in South West Africa, and elsewhere.

**blue carbonate of copper;** same as azurite.

**blue-bottle;** an informal term used by Australian miners for transparent blue potch associated with Queensland boulder opal.

**blue chalcedony;** a term applied to naturally or artificially, colored blue chalcedony, which is misleadingly called sapphire.

**blue chalcocite;** synonym for digenite.

**blue chrysoprase;** colored chalcedony, with natural inclusions of chrysocolla or stained chalcedony. Also called chrysocolla quartz, azurite, and azurchalcedony.

**blue compact chrysocolla;** synonym for demidivite.

**blue copper carbonate;** same as azurite.

**blue copper;** synonym for azurite.

**blue coral;** same as akori coral.

**blue corundum;** a synonym for sapphire.

**blue corundum;** a misleading term for amethyst.

**blue diamond;** a fancy blue, diamond.

**Blue Diamond of the Crown;** another term for the French Blue Diamond. → Tavernier Blue Diamond.

**blue dye indigo;** same as indigo.

**blue dyed jasper;** a misleading German term for colored jasper. Also called German lapis.

**blue earth;** a blue-green, fresh, kimberlite agglomerate, which fills diamond-bearing pipe. Also called blue ground.

**blue earth;** greenish-blue, glauconite sand, in which amber is found, on the Baltic coast. The greenish-blue color is caused by glauconite. Also called greensand.

**blue frit;** the material composed of copper, cobalt, and iron oxide, used for making blue-colored glass. Additional minerals occasionally found in blue frit are malachite, calcite, quartz, and sodium carbonate. Used for carving small objects.

**blue flash;** filled fractures of diamond shows interference by testing by rotation the stone into a position when the background seen bright, these flash effect can be seen in untreated fractures of stones. → Revealing fracture filled diamond.

**blue gueda;** a Singhalese term used for a semitransparent to sub-translucent sapphire with powder-blue color or with light diesel effect in

transmitted ray. → Geuda.

**Blue Giant of the Orient;** the blue sapphire of 486 cts, from Sri Lanka. No further information available.

**blue glass;** cobalt oxide, added to a soda lime glass, used as a lapis lazuli imitation.

**blue gold;** a gold of bluish color, made with 25% arsenic, steel, or iron as an alloy.

**blue granite;** synonym for larvikite.

**blue ground;** synonym for blue earth.

**blue gray;** in color nomenclature, a color between vivid blue and neutral gray.

**blue green;** in color nomenclature, a color between blue and green.

**blue ground;** a decomposed, unoxidized, slate-blue or blue-green, kimberlite agglomerate, which fills diamond pipes in South Africa, and Brazil. Also known as *blauw ground*, which weathers by oxidation, at the surface to become *yellow ground*. Same as kimberlite. An early digger's term was „*the blue*“.

**blue halite;** synonym for blue rock salt.

**Blue Heart Diamond;** the dark-blue, heart-shaped, Indian cut diamond of 31 cts. It was cut from a rough stone weighing 112.50 cts. Tavernier purchased it in India and sold it to Louise XIV of France. It was stolen in the robbery from Grand Meuble in 1792. Purchased by Cartier in 1911, it was sold again in Buenos Aires, Brazil. Last sold in 1960.

**blue indicolite;** same as blue indigolite.

**blue indigo;** same as indigo.

**blue iron earth;** same as vivianite.

**blue iron ore;** same as vivianite.

**blue ironstone;** same as crocidolite, or blue asbestos.

**blue ironstone;** another name for vivianite.

**blue jade;** same as Lao Kan C'hing jade. Also called bluish jade.

**blue jager;** a color grade of diamonds, with faint blue bodycolor, in daylight.

**blue jasper;** same as Swiss lapis.

**blue john;** a popular term for a massive, fibrous, or columnar banded, blue, violet, purple or reddish variety of fluorite, containing film-like inclusions of petroleum found near Castleton in Derbyshire, England. It had been used for carved vases in Roman times, and now is still used principally for carving vases and other objects. Synonym for derbystone, Derbyshire spar, cand, cann.

**blue lace agate;** same as lace agate.

**Blue Lili Diamond;** a dark blue, trap-cushioned brilliant-cut diamond of 30.06 cts. Named after the wife of William Goldberg, New York, USA. Present whereabouts unknown.

**blue malachite;** a misleading term for azurite.

**blue moonstone;** a misleading term, used as a synonym

for blue chalcedony.

**blue moonstone;** also incorrectly applied to chalcedony stained blue.

**blue moonstone;** a term frequently used for bluish moonstone.

**blue needles;** term applied to grading quartz crystals which denotes bluish-white, needlelike inclusions, often oriented. → Blue quartz.

**blue onyx;** a misleading term for blue-colored agate, or chalcedony.

**blue opal;** a precious, blue opal from Queensland, Australia.

**blue opal;** a misnomer, used as a synonym for lazulite.

**blue peach;** a slate blue, very fine-grained tourmaline.

**blue pearl;** a natural variety of dark-colored to silver-gray pearl, the color of which is caused by a layer of conchiolin near the surface or by the formation of the pearl around a center of mud or silt, which is called *mud center*. Other causes, may be a conchiolin-filled center of the pearl, or possibly, various impurities in the aragonite or calcite. → Mud pearl, mud center pearl.

**blue pearl;** a term applied to the dark-blue colored, Pinna pearl, found in La Paz and Panama, South America.

**blue pearl;** a commercial misnomer for larvikite.

**blue pearl;** a commercial misnomer for light colored labradorite.

**blue point pearl;** pearls obtained from *Quadrula undulata* shells.

**blue quartz;** same as sapphire quartz.

**blue quartz;** a pale blue, milky-blue, plum-blue, smoky-blue, or lavender-blue variety of quartz, containing very fine, needle-like inclusions of rutile. Found as grains in metamorphic and igneous rocks.

**blue quartz;** sometimes misnamed as siderite.

**blue remover;** hydrochloric acid, or a mixture of equal parts of sulfuric and hydrochloric acids used for whitening steel after color tempering.

**blue river;** a misnomer, for blue-white color, in diamond color grading, which corresponds to the color of river.

**blue rock;** lapis lazuli from California.

**blue rock salt;** synonym for blue halite.

**blue sapphire;** same as sapphire.

**blue schorl;** same as blue tourmaline.

**blue schorl;** the earliest term for octahedrite mineral.

**blue shifting;** → hypsochrome.

**blue spar;** another term for lazulite.

**blue spinel;** spinel, with blue colored spinel.

**blue stone;** a commercial term for sodalite, mixed with creamy-white, onyx marble, used for inlay, also is termed Canadian blue stone and princess blue.

**blue stone;** same as chalcantite.

- blue stone;** a name used for various building or paving stones of bluish-gray color.
- blue stone;** a feldspathic sandstone, of dark-blue to gray color, which readily splits into thin slabs, used as flagstones or inlay.
- blue stone;** same as Ayr stone.
- blue synthetic quartz;** same as synthetic, blue quartz, colored by cobalt oxide.
- blue synthetic spinel;** synthetic blue spinel, that is used to counterfeit blue zircon, aquamarine, alexandrine, sapphire, or even diamond, and occasionally, doublets.
- blue talc;** a misleading term, used as a synonym for kyanite or cyanite.
- Blue, Tavernier Diamond;** → Tavernier Blue Diamond.
- blue, the;** an early digger's term for blue ground.
- blue topaz;** blue, natural, topaz-like aquamarine.
- blue tourmaline;** same as indicolite, a variety of tourmaline.
- blue vitriol;** same as chalcantithite.
- blue Wesselton;** a confusing, misleading term for those diamonds, which appears blue because of transmitted white light or when viewed against a white background. The term used to compare to *top Wesselton*, since this grade falls just below the *river-to-light-yellow* diamond color-grading system. → Top Wesselton.
- blue white;** a confusing name, and one often wrongly applied, for a diamond of highest-quality, whose color grade is between the top grade, which appears colorless in transmitted light, or against a white background, (appears blue or bluish in transmitted white light), and the grade with a yellowish tinge, the difference between which is not apparent to an average inexperienced purchaser. In the United States, it is prohibited for use this term for any diamond, which, in natural light shows any color, other than a trace of blue. Also called blue-white diamond.
- blue white diamond;** a misused term for color-grading scale of diamond without body color, which is strictly classified as a „*jager*“. → Blue white.
- blue white tresselton;** an obsolete and incorrect name for a *top tresselton*, in the diamond color grading, in comparison to finest white.
- blue white Wesselton;** incorrect name for a *top Wesselton*, in the diamond color grading, in comparison to *top Wesselton*, since this grade falls just below the *river-to-light-yellow* diamond color-grading system.
- blue wood;** → indigo.
- blue zircon;** blue zircon like aquamarine.
- blue zircon;** a misnomer for those zircons, which have been heated to change their color, from uninteresting brown, grayish color to blue, sometimes golden, or white.
- blue zircon;** a misleading term for synthetic, greenish-blue spinel.
- blue zircon;** a misleading term for blue tourmaline from Thailand.
- blue zoisite;** a blue variety of zoisite from Tanzania.
- blue-point mussel;** a fresh-water mussel, known as the blue-point of the genus *Quadrula undulata* or *Quadrula plicata*, which is also known as a *three ridge mussel*, one of the most desirable species. They are fished for both pearls and shells, which are used in the manufacture of pearl buttons.
- blue point pearl;** pearl from the blue-point mussel of the genus *Quadrula undulata*, one of the most desirable species. Also known as a three-ridge mussel.
- blue-violet;** in color nomenclature, a color between blue and violet.
- bluejack;** same as blue vitriol.
- bluff stones;** a trade term used by Thailand gem dealers for a fine color of Lai-Thai ruby with good glance but poor clarity by viewing the stone closer.
- bluish gray;** in color nomenclature, a color between blue-gray and natural gray.
- bluish green;** in color nomenclature, a color between green and blue-green.
- bluish jade;** same as Lao Kan C'hing jade. Also called blue jade.
- bluish violet;** in color nomenclature a color between blue-violet and violet.
- bluish white;** in color nomenclature a color which is whiter than blue-white.
- blunt hexagonal barrel brilliant cut;** a gemstone, which has the shape of a hexagonal barrel, used for beads.
- blunt hexagonal barrel faceted gems;** gemstone, which has the shape of a hexagonal barrel, used for beads.
- blythite;** a variety of manganese garnet with chemical formula  $Mn_3^{2+}Mn_2^{3+}(SiO_4)_3$ . → Garnet, garnet species and varieties.
- Blyvooruitzicht;** a small location of an alluvial diamond mine, in the Transvaal, South Africa.
- boakite;** a local term for brecciated, greenish-red jasper from, Nevada, USA.
- Boa River;** a river in Liberia, Africa, where very small diamonds are found.
- boards;** a local term used in England for the final polishing on a wheel.
- boar ivory;** tusks of the boar, or wild hog of genus *Vertebrate animals*, which are used as ivory.
- boart;** same as bort.
- boat shape;** same as navette.
- boat-shaped rose cut;** a rose style cut has a pointed, dome-shaped crown, with 24 triangular facets, (the number of facets in the crown, however, may vary), a

flat base and, an elliptical or boat-shaped girdle outline.

**boat-shaped brilliant cut;** same as marquise.

**Boa Vista Mine;** location of a diamond deposit, near Minas Gerais, Brazil.

**Bobbejaan;** → Bellsbank.

**bobbing compound;** an abrasive material, composed of a type of tripoli used as a fine abrasive, usually before polishing.

**Bob Craig Diamond;** the diamond of 100.50 cts, found in 1917, in Vaal River, South Africa. Present location unknown.

**Bob Grove Diamond;** the diamond of 337 cts, found in 1908, in Vaal River, South Africa. Present owner unknown.

**Bobrovska garnet;** a green, demantoid garnet, from the Bobrovska River, near Swerdlowsk, Russia. → Uralian emerald.

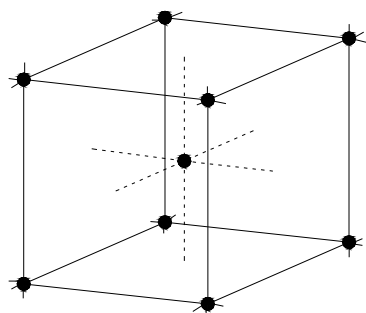
**boco de fogo;** a Brazilian term, for a green tourmaline with a pink center, known as watermelon tourmaline.

**bodgie;** an informal term used by Australian miners for top level or top.

**bodgie;** same as bottom.

**body appearance of gemstones;** an optical effect, same as a sheen, which can be seen in translucent to opaque minerals, caused by the gems internal structure, for example laminations, or numerous small and widely-distributed inclusions, or fractures.

**body-centered cubic crystal;** a crystal unit-cell in the cubic system, in which one atom is located at each



*body centred cubic crystal*

corner and one is found at the center of each cube. Also called body-centered lattice.

**bodycolor;** actual color of a gemstone or diamond, which be seen, when brilliance and dispersion are not concerned. Bodycolor can be observed, when viewed from above the table of the stones crown by entering the light into the stone deeply below the surface. Also spelled body color. → Surface color.

**body color;** another spelling of bodycolor.

**body colors of pearl;** to be judged accurately, the body color of a pearl must seen in north daylight, when the pearl is placed on a white paper. Body color is basic

underlying color, which is usually white to cream to light yellow. Body color is changed by a second component with the name overtone. A third component may or may not add to body color with the name orient, an iridescent effect. → Pearl, overtone, iridescent, orient.

**body mold;** in manufacturing glass, that part of a mold, which gives shape to the outer surface of pressed ware.

**boea;** a term used by native in Indonesia or Philippine for a stage of hardness form of fossilized copal which is gathered three months after tapping the trees. → Melengket, pontianak.

**boehmite;** a grayish, brownish, or reddish  $\text{AlO}(\text{OH})$ , mineral, dimorphous with diaspore. Orthorhombic system. Vitreous luster. Optics;  $\alpha$ :1.702,  $\beta$ :1.722,  $\gamma$ :1.750. Birefringence: 0.048.  $\oplus$ . SG:3.4-3.7. H:3. Used rarely as a gem or for the imitation of turquoise components. Also spelled bohemite, böhemite.

**Bogenfels;** location of diamond deposits, near Lüderitz, Namibia, Africa.

**bog oak;** a semifossiled, dark-brown to blackened wood, resembling ebony, which was used during the Victorian era for carved objects and for an inexpensive mourning jewelry replacing jet. Does not take a good and high polish, which has a matt surface. Found in Ireland. → Bog wood.

**bog wood;** a shiny, semifossiled and blackened wood resembling ebony, which was used in the Victorian era for carved objects and as an inexpensive mourning jewelry substitute for jet. → Bog oak.

**Bohemian aquamarine;** a misleading term for yellow topaz.

**Bohemian chrysolite;** a misleading term for moldavite, from the Czech Republic.

**Bohemian crystal glass;** → Bohemian diamond.

**Bohemian diamond;** a misleading term for a variety of quartz crystal from Bohemia, in the Czech Republic.

**Bohemian diamond;** often misleadingly refers to colored lead glass. Also called Bohemian crystal glass.

**Bohemian emerald;** a misleading term for fluorite from Bohemian, Czech Republic.

**Bohemian garnet;** a term for the reddish-yellow to dark red variety of pyrope garnet from Bohemia. Often loosely used to mean for any intense, dark-red garnet. Used as rose-cut gems.

**Bohemian gemstones;** included are the following list of gem minerals: pyrope, ruby, topaz, quartz, almandine garnet (generally), yellow quartz (citrine), and rose quartz.

**Bohemian glass;** potash-lime glass made in the Czech Republic, used for hollow ware or inexpensive gem imitations.

**Bohemian ruby;** a misleading term for red-to-rose

colored quartz, when cut as a gem. Occurs in the Czech Republic.

**Bohemian ruby**; a misnomer for pyrope garnet.

**Bohemian topaz**; a misleading term for yellow quartz or citrine, when cut as a gem.

**Bohemian topaz**; sometimes misapplied to yellow fluorite.

**bohemite**; → boehmite.

**Boin-Taburet Diamond**; the faceted diamond of 8.75 cts, believed to have belonged to the Mazarin. Present owner unknown. → Mazarin diamonds.

**bois durci**; a synthetic material used as jet imitation which is made of very fine wood-flour mixed with albumen from either egg or blood and stained black with soot.

**boke**; a Japanese term for pale-rose colored coral, from Japan.

**boléite**; prized by collectors. Synonym: argentoparcylite.

System: cubic.

Formula:  $12[\text{Pb}_9\text{Ag}_3\text{Cu}_8\text{Cl}_{21}(\text{OH})_{16}\cdot\text{H}_2\text{O}]$ .

Luster: weakly vitreous, pearly on cleavage.

Colors: indigo blue.

Streak: blue with greenish tinge.

Diaphaneity: translucent.

Cleavage: {001} perfect, {101} good, and {100} poor.

SG: 5.05.

H: 3-3½.

RI: 2.04-2.09.

Found in Boleo, Santa Rosalia, California (USA) and Mexico.

**boley gauge**; a Vernier slide gauge.

**Bolivian jasper**; a reddish jasper, from Bolivia.

**bolivarite**; variscite from Spain.

**Bolley's gold purple**; a color once used on porcelain.

**Bologna spar**; same as Bologna stone.

**Bologna stone**; a local term, for a barite mineral, found in nodular or roundish, concretionary masses. It is composed of radiating fibers and is phosphorescent, when calcined with charcoal, probably due to impurities of alkaline earth sulfide. Found in Bologna, Italy. Also called Bolognan stone, Bologna spar, radiated baryte, radiated sulfate of baryte.

**bolster crystal**; round, long, rough diamond-crystal shaped like an elongated pillow.

**boltonite**; a greenish or yellow colored of forsterite, an end member of olivine from Bolton, Massachusetts, USA.

**bolus alba**; same as kaolin.

**bombaing**; same as ani-te.

**bombarded diamond**; → diamond bombarded.

**Bombay**; a major diamond marketing center, in the city of Bombay, on the west coast of India.

**bombay**; a local term, used in Bombay, India retaining

the maximum diameter of a cut stone.

**Bombay bunch**; same as Bombay Bunch of Pearl.

**Bombay Bunch of Pearl**; after pearls are drilled in the orient, they are sorted, and strung, according to quality and size in Bombay. Those groups suitable for necklaces are string together with silver wire and blue silk, and are known as a *Bombay bunch*.

**Bombay pearl**; usually, an oriental cream rosé pearl, from the Persian Gulf. The Red Sea or other origins marketed in Bombay, on the west coast of India.

**Bombay shell**; a variety of *Pinctada margaritifera* shell, from the Persian Gulf fished for mother-of-pearl, which has rose to yellow green margins.

**bombite**; an amorphous, blackish-gray rock, from Bombay, India. Same as Lydian stone or basanite.

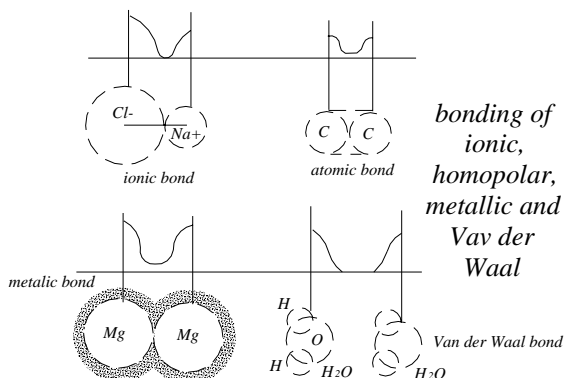
**bonamite**; a misleading, commercial term for an apple-green, gem variety of smithsonite, resembling chrysoprase in color. Found in Kelly, New Mexico, USA. Frequently used as a jade imitation.

**bonanza**; refers to a rich body of ore.

**bonded turquoise**; mineral particles of turquoise, are bonded together with a styrenated alkyd form of resin or synthetic plastic. It has lower specific gravity than natural turquoise.

**bonded turquoise**; several types of imitation turquoise matrix are produced. Some are of a plastic material, which has a low specific gravity, 2.40-2.65.

**bonding**; the attraction or force of atoms, ions, and molecules to form homopolar (atomic), metallic, ionic,



and Van der Waal bond with the peculiar structure in three dimensional regularly repeating atomic arrangement.

**body angle**; in crystallography the acute angle between a given line of crystal structure formed due to crystal structure defect or dislocation. Also called border angle.

**bone**; the dense material composing the skeletons or framework of mammals, sometimes used in the simulation of ivory, for carving objects, beads, rosaries, finger ring, seals, pins, etc. Most often being made

from the long bones of oxen and the mandibles of whales. bone material is distinguished from ivory by the differences in structure seen through microscopical observation of a thin section, or peeling. RI:1.54-1.56. SG:1.94-2.10. H:2¾. Today plastics are commonly substituted for bone.

**bone;** naturally fossilized bone, naturally or artificially colored, is known as odontolite.

**bone;** a tough, very fine-grained, gray, white, or reddish quartz.

**bone;** a term used by Australian miners for bone opal.

**bone amber;** a nearly opaque, cloudy, whitish brown amber, resembling ivory or dried bone. It is softer than other ambers and does not polish as well. Also called bony amber, osseous amber.

**bone breccia;** accumulated mass of bones or bone fragments of extinct animals found often cemented with sand, earth and calcium carbonate in caverns and fissures. Used as ivory imitation. Also called bony breccia, osseous breccia.

**bone chert;** a weathered, residual white, or reddish chert that appears chalky and is particularly porous.

**bone opal;** a term used by Australian miners for a quartz bearing rock with colors of opal or may be infusion of some opal. It is not a true opal matrix. Also called bone.

**bone turquoise;** a misleading term for *fossil bone* or tooth, naturally-colored deep-blue by vivianite, an iron phosphate, used as an imitation for turquoise, however, it loses its color in the course of time. Sometimes, artificially colored bones or teeth are substituted. Also called odontolite, fossil turquoise.

**bone turquoise;** any natural or artificial bone, or tooth, used as a substitute for turquoise, such as the long-bones of cows or other animals. Natural bone needs the special preparation of *degreasing*, before use.

**Bonsa Diamond Field;** location of an alluvial diamond deposit, along the Bonsa River in Ghana, Africa.

**bony amber;** → bone amber

**bony;** a term used by Australian miners for a white powdery variety of potch because presence of bony remain of marine animals.

**bony breccia;** same as bone breccia.

**book;** same as mica book.

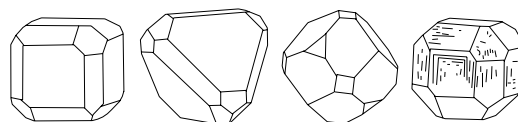
**book clay;** a term used for a clay, which is deposited in thin leaf-like layers. Also called leaf clay.

**boort;** same as bort.

**boothite;** a blue mineral of  $\text{CuSO}_4 \cdot 7\text{H}_2\text{O}$  of melantrite group. Monoclinic crystal. Transparent to translucent. SG≈2.10. H:2-2½.  $\alpha$ :1.48,  $\beta$ :1.48,  $\gamma$ :1.49. Birefringence: 0.020. ⊕ or may ⊖. Cleavage: {001} imperfect. Found in the USA and France. Prized by collectors.

**Boot's de Anselmus;** who declared that pearls and shells have similar structure (1600).

**boracite;** a boron mineral of inferior gem quality.



*boracite crystals*

Frequently faceted as gems. Luminescence weak under SWUV.

System: orthorhombic below 268° C, above 268° C cubic.

Formula:  $4[\text{Mg}_3(\text{ClB}_7\text{O}_{13})]$ .

Luster: vitreous.

Colors: colorless, blue, grayish, greenish. Strongly pyroelectric.

Streak: uncolored.

Diaphaneity: transparent to translucent.

Cleavage: none.

Fracture: conchoidal to uneven. Brittle.

SG: 2.90-3.00.

H: 7-7½.

Optics;  $\alpha$ : 1.662,  $\beta$ : 1.667,  $\gamma$ : 1.673.

Birefringence: 0.011. ⊕.

Dispersion: 0.024.

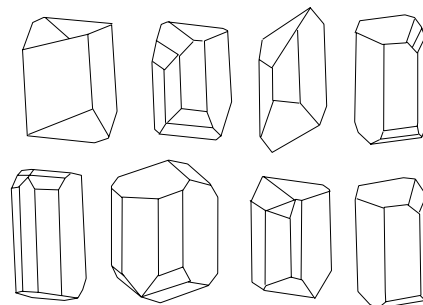
Found in California, the USA, England, France and Germany.

**bosad;** a Middle Farsi (Persian) term for coral. Also spelled besad.

**borat;** same as bort.

**borate;** same as bort.

**borax;** a boron mineral of inferior gem quality.



*borax crystals*

Frequently faceted as gems. Soluble in water.

System: monoclinic.

Formula:  $4[\text{Na}_2\text{B}_2\text{O}_5(\text{OH})_4 \cdot 8\text{H}_2\text{O}]$ .

Luster: vitreous.

Colors: colorless, greenish, bluish or grayish.

Streak: white.

Diaphaneity: transparent to opaque.

Cleavage: {100} perfect, {110} less perfect, {010} in trace.

Fracture: conchoidal. Very brittle.

SG: 1.720.

H: 2-2½.

Optics: a: 1.447, b: 1.469, g: 1.472.

Birefringence: 0.025. ⊖.

**borax**; a misleading term for a yellow, white, blue, green, or gray boron mineral deposited by evaporation of the water of the alkaline lakes or lacustrine mud, inferior jewelry merchandise.

**borax**; the stores sell this mineral at high prices or by unethical methods.

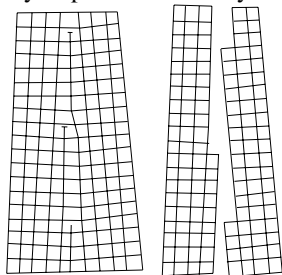
**borax bead**; same as tincal bead.

**borazon**; a commercial term for the synthetical composition of BN, which has the same the structure as diamond. It may be black, brown, dark red, yellow, white or gray. SG:3.45. H:10. Used as an abrasive material. Also, called amber boron nitride, cubic boron nitride, white graphite. Manufactured by General Electric of America.

**border angle**; same as body angle.

**border contrast effect**; same as border effect.

**border effect**; a term used in optics for a faint dark line between a lightly exposed and heavy exposed border.



*border angle*

Also called border contrast effect.

**boreizeh**; same as maadjun-e-chini.

**borko**; → emerald,-names of.

**Borneo**; an alluvial diamond deposit on the island of Borneo, in the Malay Archipelago, southeast Asia.

**Bornholm diamond**; a misleading name for quartz concretion, from Laesaa and Olenaa, Denmark.

**bornite**; a mineral of inferior gem quality. When it tarnishes it becomes iridescent and is known as peacock ore, variegated copper ore, erubescite, phillipsite, purple copper, horse-flesh ore. Cut cabochon.

System: tetragonalic.

Formula:  $8[\text{Cu}_3\text{FeS}_4]$ .

Streak: uncolored.

Luster: metallic.

Colors: copper red or bronze, tarnish iridescent purplish.

Diaphaneity: opaque.

Cleavage: {111} in trace.

Fracture: conchoidal to uneven. Brittle.

SG: 4.90-5.00.

H: 3.

Found in Arizona and Virginia, in the USA, and Germany.

**boron**; an amorphous, yellowish-brown element, of atomic number 5, with the chemical symbol of B. It has semi-conductive properties and a blue color, in Type IIb diamond, instead of aluminum. The resulting of boron impurity in diamond in the band gap is missing of an electron, or creating a hole, which is called acceptor. → Acceptor.

**boronatrocaltite**; same as ulexite.

**boron carbide**; an artificially prepared high, quality abrasive, black, crystalline substance of the composition  $\text{B}_4\text{C}$ . SG:3.45. H:9½-9¾. Ranking next to diamond in hardness, harder than silicon carbide or carborundum.

**boron nitride**; → borazon.

**borosilicate crown glasses**; → borosilicate glasses.

**borosilicate glass**; colorless to pale blue, very hard glass of sodium, boron, silica glass. RI:1.47-1.51, SG:2.30-2.41. H:6½-7. Used to imitate gems, especially aquamarine. Also called borosilicate crown glass.

**Borsa Diamanti D'Italia**; Italian diamond bourse, in Milan. A member of the World Federation of Diamond Bourses.

**bort**; granular to very fine imperfect crystalline, diamonds, or fragments, produced during cutting diamonds. Occurring in spherical form with no distinct cleavage and with a rough exterior.

**bort**; a natural diamond of the lowest quality, badly flawed, or discolored crystals suitable only for use as abrasive powder, for industrial processes. Also called industrial diamond. The varieties of bort are: ballas or shot boart, hailstone boart, carbonado, stewartite, and framsite. Also spelled borate, boort, boart, bortz, and bowr. → Abrasive material.

**bort**; a name used as a synonym for carbonado.

**bort beads**; same as ballas.

**bortz**; same as bort.

**Boshhoek**; location of a small alluvial diamond mine in Kimberly, South Africa.

**Bosnian Meerschaum**; same as Bosnian sepiolite.

**Bosnian sepiolite**; a misleading term for magnesite, from Bosnia. Also called Bosnian Meerschaum.

**boss**; a term applied to protuberant ornament.

**botch**; a worthless opal, the term is possibly a variant of potch.

**botryoid**; same as cave coral.

**botryoidal**; having the form of a bunch of grapes. In mineralogy, usually applied to mineral aggregates, in which the spherical shapes are composed of radiated



needle-like crystals. Grapestone.

**botryoidal form**; same as botryoidal.

**botryoidal stalactite**; same as grapestone.

**botryolite**; a radiating, columnar variety of datolite mineral with a botryoidal surface.

**Botswana**; the Republic of Botswana formerly called Bechuanaland, lies between Zimbabwe, Southern Africa, and South-West Africa. It has many kimberlitic diamond pipes and in the present-day producing for industry. The quality and quantity of gems found there, is consequential.

**Botswana Diamond Valuing Company, Ltd.**; a diamond producing company, in Botswana, Africa.

**bottle glass**; the glass used for manufacture of common bottles is sometimes used for imitation stones, made from calcium-glass. Ironoxide, and titan oxide are the color agents. RI:1.51-1.54. SG:2.44. H:5.½.

**botticino**; a misleading term for a cream to yellow fine-grained marble, from Italy.

**bottle stone**; synonym for a gem cut from green moldavite, a variety of tektite, occurring in Bohemia and Moldavia. Also called bouteillenstein, also, misnomered as water-chrysolite, pseudo-chrysolite.

**bottom**; a term used by Australian miners for an opal mine, being worked in under-ground below a horizontal stratum layered hard stone.

**bottom**; a term used by Australian miners for lowest of several level of an opal mine. Also called bodgie.

**bottom**; same as pavilion.

**bottom break facets**; → break facets.

**bottom corner facets**; → pavilion facets.

**bottom half facets**; → girdle facets.

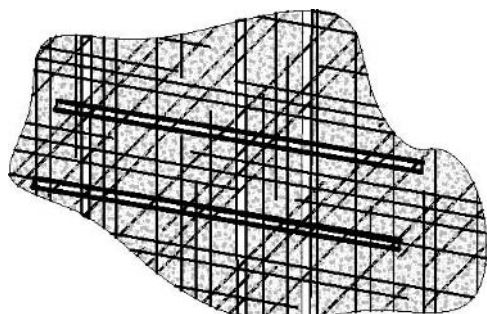
**bottom main facets**; → pavilion facets.

**boulder**; a term applied to any pieces of rock, which is too heavy to be lifted readily by man. Also spelled bowlder.

**boulder**; another term boulder bed.

**boulder bed**; a term used by Australian miners for an opal-bearing layer of sandstone boulders, usually near the bottom of overlaying sandstone. Also called bowlder.

**boulder bed**; a term used by Australian miners for an



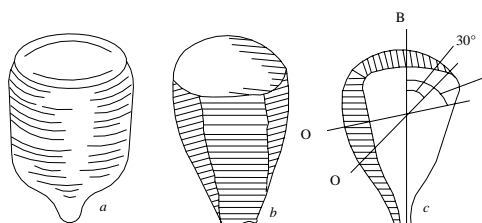
*boulder with ice scratcher*

opal occurring in the thin vein or on hard gray or brown ironstone boulders, usually near the bottom of overlaying sandstone. Also called bowlder.

**boulder opal**; a miner's term, applied in Quilpie, Queensland, Australia to brown, hard, siliceous colorful, limonite nodules, containing thin veins of precious opal.

**boulder scratcher**; the scratching, grooving, grinding, polishing, etc. by movement of soil or rock by the action of moving ice of a glacier. Also called glacial bowlder, glacial abrasion, glacier erosion, ice bowlder.

**boule**; a French term for a ball. The elongated pear- or carrot-shaped, cylindrical drop, masses of ruby,



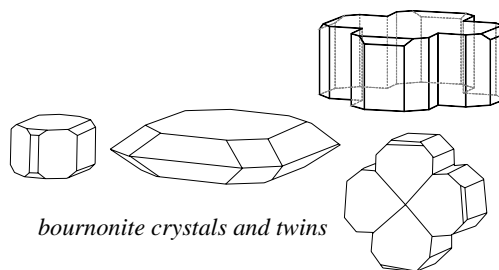
*a: synthetic ruby boule, b: cut a part of boule and c: cross section of synthetic ruby boule with axes and angles*

sapphire, corundum or spinel that forms during the production of synthetics in the Verneuil process, which forms on a candle.

**Boungou River**; there are alluvial diamond deposits, along Boungou River, Central African Republic.

**bouquet agate**; a translucent, cloudy, grayish variety of chalcedony, with bright colored inclusions, arranged in the form of a bouquet.

**bournonite**; a steely-gray to black mineral  $PbCuSbS_3$ . Orthorhombic crystal. Metallic luster. Opaque. Streak:



*bournonite crystals and twins*

gray. SG:5.7-5.9. H:2.5-3. Very interesting fourling. Prized by collectors.

**Bourguignon pearls**; a term for wax-filled, imitation pearls. Imitation pearls made of hollow glass beads, which coated with essence d'orient, (fish essence), may filled with wax. Sometimes written: Bourquignon pearls.

**Bourquignon pearls**; → Bourguignon pearls.

**bourse**; → diamond bourse.

**bouteillenstein**; a French-German term, for bottle stone.  
→ Water chrysolite.

**bouton**; French term for button pearl.

**bouton pearl**; a French term for button pearl.

**bowenite**; a translucent, fine-grained, massive variety of serpentine-antigorite, resembling nephrite, a variety of jade. Bowenite may be stained. Also called *bowenite jade* and marketed misnomerly under the name *new jade*, and *serpentine jade*. A dark green variety is used by the Maoris of New Zealand, to make ornamental objects called *tangiwaite*. Also called sang-i-yashm. Also, incorrectly called *Korea jade*.

System: monoclinic.

Formula: same as serpentine.

Luster: vitreous.

Streak: uncolored.

Colors: greenish, grayish-green, greenish-white to yellowish-green.

Diaphaneity: transparent to translucent.

Cleavage: {001} perfect.

Fracture: conchoidal to uneven. Brittle.

SG: 2.58-2.59.

H: 5-5½.

Optics:  $\alpha$ :1.560,  $\beta$ :1.566,  $\gamma$ :1.571.

Birefringence: 0.011.  $\ominus$ .

Found in China, Afghanistan, New Zealand and India.

**bowenite jade**; a misleading term for bowenite.

**bowing effect**; the figure of bowing the table and the adjoining star facets, on a fashioned, brilliant-cut diamond.

**bowing method**; extending the bowing effect, in relation to table size and the adjoining star facets. There are three methods of bowing: straight, bows in, and bows out.

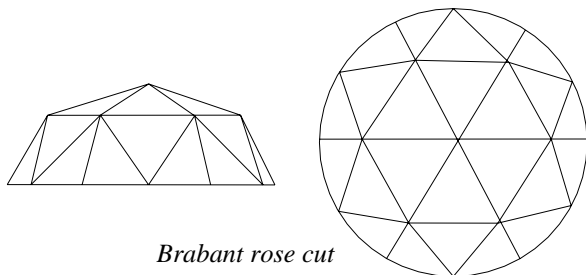
**boulder**; same as boulder.

**bowlingite**; same as saponite.

**Bow River Mine**; location of a diamond-bearing deposit, in southwest Kunumurra, Western Australia. It is operated by Normandy Poseidon.

**bowr**; same as bort.

**bow tie**; a darkened, bow-tie shape which can be seen through the table of marquise, oval, heart-shaped, and



*Brabant rose cut*

pear-shaped, polished diamonds, resembling a bow-tie.

**bow tie effect**; → bow-tie.

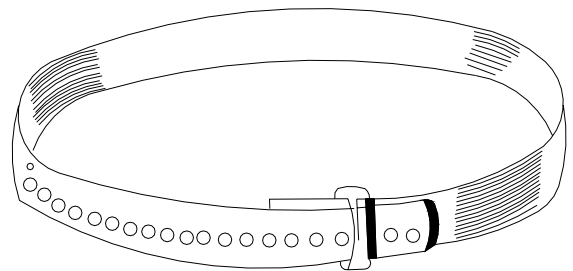
**Br**; a chemical symbol for the element bromine.

**Brabant rose cut**; same as Dutch rose, Holland or Antwerp rose cut, except in the Brabant rose cut, the pyramid is flatter than in others.

**bracelet**; any circular ornament, worn by men or women on the wrist or arm, made of gold, silver or other materials, frequently set with jewels.

**bracelet gauge**; a circular device for measuring the diameter of wrist or arm.

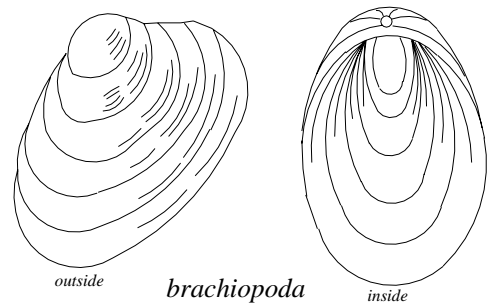
**brachy axis**; same as lateral axis. The shorter of the two,



*bracelet gauge*

unequal-length, lateral axes in crystals with orthorhombic, monoclinic, and triclinic systems. The longer axis is called the macro axis.

**brachiopod**; any hard shell, solitary marine invertebrate of Phylum brachiopoda, characteristic by a lophophore



and two symmetrical valves, which consists of carbonate and conchiolin. It ranges from lower Cambrian to present. Prized by collectors.

**brachy pinacoid**; a pinacoid, parallel to the vertical axis and the brachy diagonal, in orthorhombic or triclinic crystal.

**brachy pyramid**; when the intercept on the brachy axis in a pyramid is more than one.

**Brady Diamond**; the rough diamond of 330 cts, found in 1902, at Brady's farm at Vaal River, South Africa. Present location unknown.

**Braganza Diamond**; the rough diamond of 144 cts, found in 1791, in Brazil. Also called Portugal Diamond. → Braganza Topaz

**Braganza Diamond**; incorrect name for Braganza

Topaz.

**Braganza Diamond;** a misnomer for tourmaline.

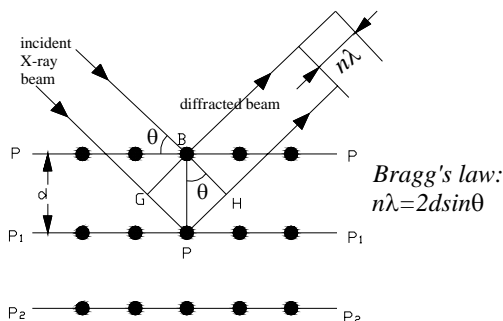
**Braganza Stone;** same as Braganza Topaz.

**Braganza Topaz;** the large colorless topaz of 1640 cts, of unusual beauty and clarity belonging to Portuguese regalia. It was found in 1740 or 1797?, in Abaete, Minas Gerais, Brazil, when Brazil was a colony of Portugal. Had been erroneously reputed to be diamond. Also called Braganza stone and erroneously called the King or Regent of Portugal Diamond. Present whereabouts unknown.

**Bragg diffraction of light;** the exhibition of a spectrum of colors, seen from different angles, in opals is due to the arrangement of spheres and voids, in the 3-dimensional cubic structure, which causes a 3-dimensional diffraction scattering, which is known as Bragg's diffraction of light.

**Bragg lattice;** the quasi-parallel orientation of thin layers of the spheres are present in opal, which cause iridescent diffraction and interference at those layers. This effect can also be seen in tiny crystals of mica, which are covered completely on both sides with sheets of titanium oxide, an anatase, so that both materials are uniquely spread in pyroxylin. The nearly-parallel orientation of layers causes an effect of iridescence and interference of light in thin layers of some synthetic material. → Synthetic fish-scale essence.

**Bragg's Law;** Bragg pointed out that, although X-rays are indeed diffracted by crystals, the diffracted X-rays



act as though they were reflected from planes within the crystal:

$$n \lambda = 2d \sin \theta$$

Where  $n$  is an integer (1, 2, 3, . . . ,  $n$ ),  $\lambda$  the wavelength of the X-rays,  $d$  distance between successive parallel planes, and  $\theta$  the angle of incidence and reflection of the X-ray beam from the given, an atomic plane.

**Bragg's method;** a method of determining the crystal structure, using a beam of X-rays, used successfully by Bragg.

**Brahmani River;** a river in Golconda, India, where

early diamond mines were located. → Golconda, Hyderabad.

**Brahmin emerald;** a term used in Indian for emerald of Sirish flower or Albizzia procera.

**brait;** same as rough diamond.

**Brakfontein;** location of a small, alluvial diamond deposit, in Cape Province, South Africa.

**brance;** a term applied to a brass ball or pyrite concretion.

**branch;** same as arborescent which appears tree-like in gemstones as inclusions. → Arborescent.

**branching agate;** same as arborescent agate.

**Brandewynskuil;** location of a small, alluvial diamond mine in Transvaal province, South Africa.

**brass;** a large class of alloys of copper and zinc, frequently containing some quantity of aluminum, iron, manganese, nickel, tin, or lead. Used as gilding metal, and for costume jewelry.

**brass;** an English name, for iron pyrites, (pyrite and marcasite), or *Welsh gold*, found in coal or coal seams. Also called brasses, and brazil.

**brass ball;** same as brance.

**brass-colored pearl;** fancy, colored pearls, of brass or black color, without iridescence obtained from *Malleus mussel*, found on the Pacific coast of America, SG: 2.21-2.66.

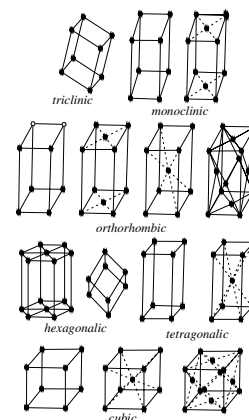
**brasses;** same as brass.

**braunite;** a brittle manganese mineral of  $8[\text{Mn}^{+2}, \text{Mn}^{+3} | \text{O}_8 | \text{SiO}_4]$ . Tetragonal system. Brownish black. Submetallic luster. SG:4.72-4.83. H:6-6½. occurs together with bixbyite and vary-colored rhodochrosite, found in Kalahari Desert, Cape Province, South Africa.

**Braun's liquid;** a term used in Germany, same as methylene iodide.

**Braunschweiger clear amber;** a German, commercial grade amber, of a dark yellow color.

**Bravias lattice;** any one of the 14 fundamental distinct, (repetitive), lattices, which can be formed by the array



14 Bravias crystal lattices or unit cell

of representative points, in a three-dimensional crystal

structure. Also called direct lattice in comparison with the reciprocal lattice, crystal lattice, space lattice, unit cell, parallelepiped, parallelogram, primitive cell.

**brazil;** an English slogan for iron pyrite, which is associated with coal. Also called brass, brasses, brassil, brazzle.

**Brazil;** an important diamond source since 1725 from Minas-Gerais, Mato Grosso, Bahia. Sources of less importance are So Paulo, Para, Goyaz, Maranhao, and Rio Branco. Principally they produced from gravels in the rivers valleys.

**Brazil aquamarine;** → Brazilian aquamarine.

**Brazil emerald;** → Brazilian Emerald.

**Brazil nut;** a flattened, triangular-shaped nut, which is as large as a hen's egg. → Corozo nut.

**Brazil tourmaline;** a commercial term for bottle-green tourmaline, from Brazil.

**Brazil twin law;** a type of twin law existing in quartz, in which the twin plane is perpendicular to one of the crystallographic axes.

**Brazil twin;** same as Brazil twin law.

**Brazilia diamond;** the light blue diamond of 176.20 cts, from Abadia do Dourados River, Minas-Gerais, Brazil, found in 1944. The present location is unknown.

**Brazilian amethyst;** any purple to violetish amethyst from Brazil (Bahia, Brejinha mine, and Rio Grande do Sul). Also, from Minas-Gerais, Santo Goyaz, Espirito, and Diamantina.

**Brazilian amethyst;** a commercial term used in the USA, for purple to brownish amethyst, sometimes, with patchy or streaky color.

**Brazilian aquamarine;** any fine, blue aquamarine from Minas Novas, in the state of Minas-Gerais, Brazil.

**Brazilian aquamarine;** an incorrect term for the greenish bluish topaz resembling aquamarine, from Minas Novas in the state of Minas-Gerais, Brazil. The color quality of the Brazilian is not as fine a blue as Madagascar aquamarine.

**Brazilian cat's-eye;** same as chrysoberyl cat's-eye, from various gem-bearing districts of Minas-Gerais, Brazil. Inferior to Sri Lankan cat's-eye. Also called chrysoberyl cat's-eye.

**Brazilian chrysoberyl;** fine, greenish-yellow chrysoberyl, from the state of Minas Novas, Brazil.

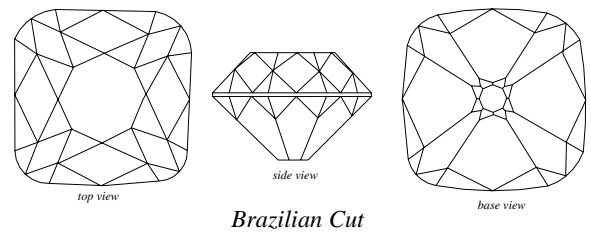
**Brazilian chrysolite;** a misleading term for chrysoberyl, from Brazil.

**Brazilian chrysolite;** sometimes a local misnomer for a green variety of tourmaline.

**Brazilian cut (brilliant);** a modified, cushion-shaped brilliant or old-mine cut, with 8 additional facets around the culet, making a total of 66 facets. Also called old-mine cut.

**Brazilian Diamond;** the diamond of 90 cts, in the

rough, from Brazil, found in 1825. After it was



brilliant-cut it weighed 31.75 cts. The owner unknown.

**Brazilian diamond;** any diamond from any of the diamond-bearing districts of Brazil.

**Brazilian diamond;** a misleading term for quartz crystal from, Brazil.

**Brazilian emerald;** pale, yellowish green variety of beryl, from various gem-bearing districts of Minas-Gerais and Bahia, Brazil. Those from Bahia, and from most other mines are too light to be gemologically classed as emerald, because the spectroscopically color agent, chrome does not exist in them.

**Brazilian emerald;** a local and incorrect name for green tourmaline from Brazil, used as a gemstone. Also called taltalite, zeuxite.

**Brazilian emerald;** a misleading term for yellowish-green synthetic spinel.

**Brazilian Gemological Association;** → Associação Brasileira de Gemologia.

**Brazilian gems;** includes any gems from Brazil, which produces chrysolite, yellowish-green tourmaline, green tourmaline, emerald, beryl, ruby, rose spinel, blue tourmaline, and blue sapphire.

**Brazilian onyx;** a commercial, misleading term for banded calcite or onyx marble, from Argentina.

**Brazilian pebble;** a misleading term for rock crystal, used in the form of spheres, for crystal-gazing, lenses, etc.

**Brazilian peridot;** a local misleading term for light yellowish-green tourmaline.

**Brazilian peridot;** a local misnomer for chrysoberyl from Brazil.

**Brazilian Princess Topaz;** a light-blue topaz of 4.20kg. It is cut from a rough stone of 35kg. Now on display in the American Museum of Natural History, New York, USA. Present whereabouts unknown.

**Brazilian Princess Topaz;** a light-blue topaz of 6.93kg, which is only carved. It is cut from remaining of Brazilian Princess 1.

**Brazilian ruby;** a misleading term for a few pink or reddish minerals resembling ruby in appearance and occurring in Brazil, such as pink to rose-red, or deep-

red to pink topaz, either natural or artificially heated.

**Brazilian ruby;** a misleading term for light, rose-red spinel.

**Brazilian ruby;** a misleading term for reddish tourmaline.

**Brazilian sapphire;** a local misleading term for a transparent blue variety of tourmaline occurring in Brazil, used as gemstone.

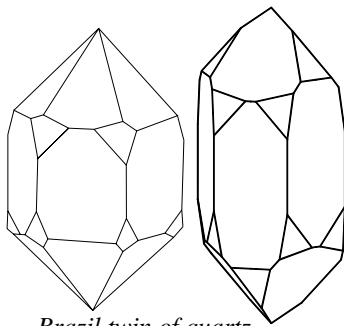
**Brazilian sapphire;** a misleading term for light-blue to greenish topaz from Brazil.

**Brazilian topaz;** a jeweler term for topaz in the range of colors, from pure white to blue, from Brazil.

**Brazilian topaz;** sometimes, an incorrect term for citrine.

**Brazilian twin law;** → Brazilian twins.

**Brazilian twins;** a type of twin, in a hexagonal system of quartz, in which the twin plane is perpendicular to



Brazil twin of quartz

one of the crystallographic axes. This occurs when one individual is a right-handed and the other a left-handed.

**brazilianite;** a rare, transparent to translucent, hydrous phosphate of aluminum. The transparent minerals are faceted, and the opaque variety, cut cabochon. Obsolete synonym is wavellite.

System: monoclinic.

Formula:  $4[\text{NaAl}_3(\text{PO}_3)_2(\text{OH})_4]$ .

Colors: colorless, pale yellowish to yellowish green.

Streak: colorless.

Luster: vitreous.

Diaphaneity: transparent.

Cleavage: {010} good.

Fracture: conchoidal to uneven. Brittle.

SG: 2.983 - 2.988.

H: 5½.

Optics;  $\alpha$ : 1.602,  $\beta$ : 1.609,  $\gamma$ : 1.622.

Birefringence: 0.020. ⊕.

Dispersion: 0.014.

Found in Brazil, New Hampshire, and North Grafton, USA.

**brazilite;** a synonym for a fibrous variety of baddeleyite.

**brazilite;** a term applied to a mixture of zircon, altered zircon and baddeleyite.

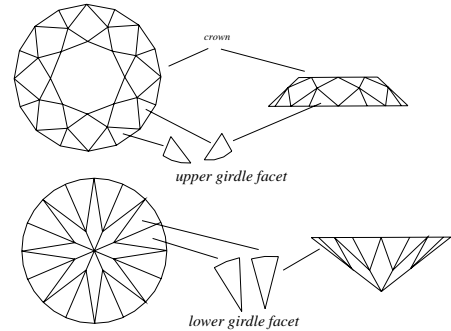
**brazilite;** a term applied to an oil shale.

**brazing;** the process of joining metals, by high-temperature, with brass or other hard alloys.

**brazing;** to cover or ornament with brass and zinc.

**bread crumb;** a group of dust-like or bread crumb inclusions of tiny acmite or cryolite are seen in some hydrothermal synthetic amethyst.

**break facets;** an old, collective term, applied, in one of nomenclature, to the 16 small triangular facets on the crown and edging of the girdle, and to the 16 similar



situation of break facets on crown and pavilion

facets on the pavilion of a brilliant cut. Now the 16 facets above are called *upper girdle facets*. Once known as top break facets, upper break facets, skill facets, or half facets or halves. The 16 facets below are called *lower girdle facets*. These were once called bottom break facets, or lower break facets. → Girdle facets and girdle facet.

**breaks;** same as girdle facets.

**breast ornament;** same as pectoral.

**Breastplate of the High Priest;** same as Breastplate of the Jewish High Priest.

**Breastplate of the Jewish High Priest;** Aaron was the first high priest of the temple at Jerusalem, to have worn this breastplate, several centuries before Christ.

3 Smaragdus Leui	4 Carbucul Iuda	5 Saphirus Zabulon
2 Topazius Simeon	9 Amethystus Asfer	6 Iaspis Isachtar
1 Sardiud Raaben	10 Chrisolitus Nephtholim	7 Lincurius Isan
12 Beryllus Beniamin	11 Onychinus Ioseph	8 Achates Gad

Breastplate of the Jewish High Priest

Later worn by High Priests, when he was presented, in the Holy Place, in the names of the Children of Israel. The stones of the breastplate appear, as one of three lists of gems, in the Bible. In Ezekiel 28:13, in Revelations 21:19-20, and in Exodus 28:17-20, are lists

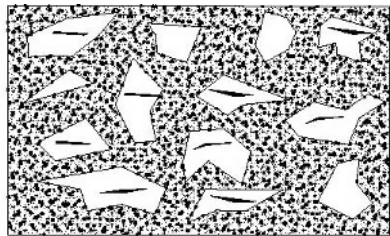
of the twelve foundation stones. The authorized list is: 1. red jasper (sardius), 2. citrine quartz (topaz), 3. emerald, 4. ruby (carbuncle), 5. lapis lazuli (sapphire), 6. rock crystal (diamond), 7. golden sapphire (ligure), 8. blue sapphire (agate), 9. amethyst, 10. yellow jasper (chrysolite), 11. golden beryl (onyx), 12. chrysoprase (jasper). The Hebrew names of these twelve stones are: 1. Odem, 2. Pitdah, 3. Bareketh, 4. Nophek, 5. Sappir, 6. Yahalom, 7. Leshem, 8. Shebo, 9. Ahlamah, 10. Tarshish, 11. Shalom, 12. Yashpneh. Also called Aaron's Breastplate or Breastplate of the High Priest. According to Exodus 28:17-20, twelve stones are listed in four rows, each containing three stone as in the table:

table 2: Breastplate of the Jewish High Priest stones

row	name		
1	Odem	Pitdah	Bareketh
2	Nophek	Dappir	Yahalom
3	Leshem	Shebo	Ahlamah
4	Tarshish	Shoham	Yashpneh

**breath test;** when the surface of a diamond is breathed on, the film on the surface will evaporate much more rapidly than on the surface of any imitation stone. The effect is caused, because diamond has a much larger thermal conductivity.

**breccia;**  
of  
from



*breccia, coarse-grained clastic and angular-broken rock fragments in a fine-grained matrix*

a number of formations. Examples are brecciated agate, jasper, marble, serpentine, etc. The upper parts of kimberlite and lamproite pipes are generally filled with breccia. Often carved as cameos. Also called rubble rock.

**breccia d'Aleppo marble;** a misleading term for a light-colored limestone, found in northern Italy.

**breccia di Serravezza marble;** a misleading term for purple, gray-white, brecciated marble, from Serravezza in north-east Italy.

**breccia marble;** same as brecciated marble.

**breccia polychroma;** a misleading term for a light-colored limestone, found in northern Italy.

**breccia porosity;** a term used for interparticle porosity in a breccia rock.

**brecciated;** resembling a breccia. A rock structure marked by an accumulation of angular fragments, which have been naturally embedded or cemented.

**brecciated agate;** any agate, composed of irregular and angular fragments, recemented into stone.

**brecciated jasper;** any jasper, composed of irregular and angular fragments, recemented in the stone. In them, patterns appear, as mosaics. Such rocks have been cut and polished for ornamental purposes such as bookends and spheres. Occurrences are widely distributed. Also called creolin.

**brecciated marble;** any marble, composed of irregular and angular fragments, and recemented in stone. Also called breccia marble.

**brecciated Mexican agate;** mosaic agate, composed of irregular and angular fragments from Mexico.

**brecciated serpentine;** fine-quality, dark green, brecciated serpentine from Casambala, a few miles north-east of Larissa, in Thessaly, Greece. It was misnomerly called *verde antico*, known to the Romans as lapis atracius, and was obtained near the ancient town of Atrax.

**breccioid;** any rock resembling a breccia or having the appearance of a breccia.

**breche rose marble;** a misleading term for pale pink and white marble, from Norway.

**breche universelle;** a misleading term for dark green-colored limestone, found in Egypt.

**bredbergite;** a variety of andradite garnet containing magnesium.

**breeding pearl;** a fanciful statement of pearl, which said that pearl increased in size and number after a period of time when it is enclosed in rice grains. Also called germination.

**breithauptite;** a copper-red to reddish-brown, nickel antimonide mineral, (NiSb). Hexagonal. Metallic luster. SG:7.59-8.63. H:5½. Found in Sardinia, Germany, Canada, and the USA. A collector's stone, which has been cut as gemstone.

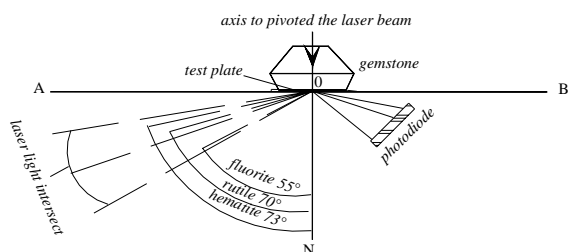
**breloque;** a small charm, suspended from a chain.

**Brewster's angle method;** the angle, at which unpolarized light is incident upon a dense medium so that it acquires the maximum plane polarization. This depends upon optics; the substance and RI:  $\tan \theta$ . Also called Brewster's law, and polarizing angle.

**Brewster's law;** the condition of the complete polarization of a monochromatic light, reflected from a surface. Or the Optics of a crystalline substance equal to the tangent  $\theta$ . → Brewster's angle.

**Briançon diamond;** a misleading term for rock crystal from Briançon, France. Also erroneously called

Dauphiné diamond.



RI measurement of gemstones by using of Brewster angle of polarization. Laser light is vertically polarized therefore Brewster angle the reflected beam incident on the photodiode drops to a minimum.

**brick**; a term used in crystallography for a unit cell, which has the shape of an ordinary brick with the three edges at right angles but of different lengths.

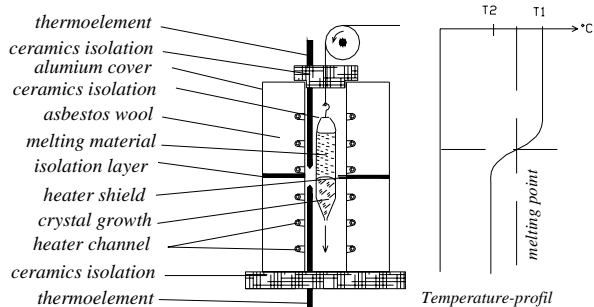
**brick-pipe**; a term used by Australian miners for a cylindrically shaped section up to about 1502.4cm or five feet in length, that is filled with hard siliceous material and in which may common found opal.

**bridal crown**; a crown, usually made of silver and glass beads worn by a bride at her wedding ceremony.

**bridal parure**; a set of jewels made of one type of gemstone, consisting of a necklace, bracelets, earrings, aigrettes, buckles, and brooch, worn by a bride at the wedding ceremony.

**Bridgman, Percy W.**; who successfully carried out experiments on diamond synthesis under high pressure and at high temperatures for General Electric, in 1955.

**Bridgman-Stockbarger technique**; a process for synthesizing gemstones, by Bridgman-Stockbarger, in which a crucible, containing the pure melt, is slowly



Bridgman-Stockbarger method. After Straebel 1977

lowered into the cooler part of a special furnace. Crystals begin to grow as the temperature falls. The method is used to make laser crystals, and, frequently gemstones.

**briefca**; same as diamond parcel paper.

**Briggs' scale**; a scale used to measure the toughness of brittle minerals, by pressing a fragment of one mineral against another, until one breaks. The one first broken is the weaker. Carbonado is the toughest on the scale.

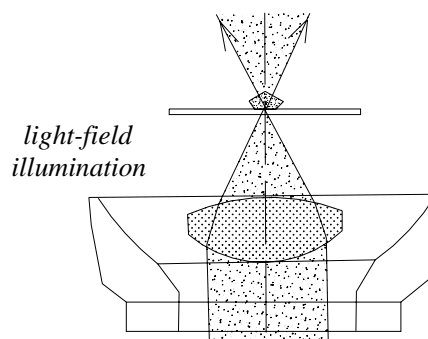
**bright**; the appearance of a gem in light or the ability to

reflect light in great quantity.

**bright brass yellow**; a pale yellowish brass color.

**bright carbuncles**; a term applied by Callistratus to transparent carbuncles garnet, in opposite of cloudy carbuncles.

**bright-field illumination**; a kind of illumination, in which a device incorporated in certain diamond and other gemstones microscopes with a diffusible strong transmitted light. This effect is created by passing light through a condenser from the side, while the specimen is viewed against a bright background. It shows inclusions that appear dark and stand out clearly and reduces confusing surface reflections. In optical microscopy, having a bright lightened background. In optical mineralogy, a device whereby transparent or



uncolored gem or mineral is made to appear as dark particles on a bright background. Also called light ground illumination, bright-ground illumination. → Dark-field illumination.

**bright finish**; a highly polished surface, or a mirror-like, polished surface.

**bright gold**; a term used for pure silver.

**bright-ground illumination**; same as bright-field illumination.

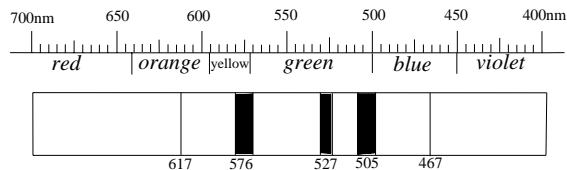
**bright ivory**; same as hard ivory. Hard, or bright ivory is distinctly harder to cut and is glassier than soft ivory.

**bright-line method**; same as bright-line spectra.

**bright-line reading on refractometer**; some coated natural stones or pastes does not show a shadow edge on the scale. For this purpose the covering shield of the refractometer is removed and the window of light is blocked. By using a suitable light source to provide light at a level, which gazes on the stone, it is placed on the refractometer, immersed in liquid. Usually a bright line is visible, crossing the dark scale, at the position where the refractive indices of the gemstone appear. → Beck line method, bright-line spectra.

**bright-line spectra**; observation, the red flames from lithium and strontium salts which seen through a prism shows a different bright-line spectrum particular to each one. Caused by the emission spectrum, of bright

lines on a dark background, the emission and absorption spectra of gemstones are characteristics. They serve to identify the elements present in a material, as they exist in different positions showing



bright-line absorption spectrum in almandine

bright lines in the spectrum, for different elements at any chemical combinations. Also called bright-line method or bright-line technique. → Fraunhofer lines.

**bright-line technique;** same as bright-line spectra.

**brightened silver;** a term used for pure silver.

**brightness;** in optics the lightness or darkness of a color, without considering its hue and saturation. The scale has white is at one end of the scale, and black at the other.

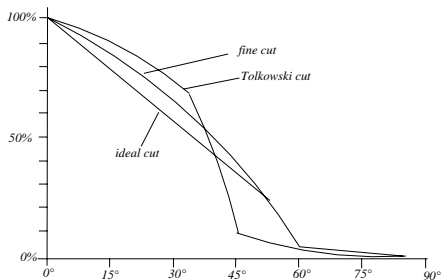
**Brighton diamond;** a misleading term for rock crystals, from Brighton, England.

**Brighton emerald;** a misleading term for bottle-green glass, used as an emerald imitation.

**Brighton emerald;** a misleading term for a natural, green, glass pebble, from the Southern coast beaches of England.

**brille;** a German term for beryl.

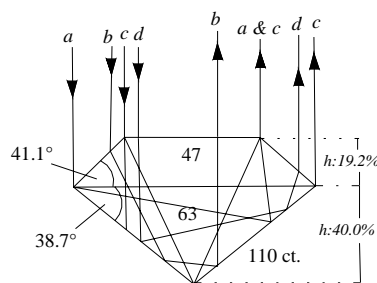
**brilliance;** the total amount of light reaching the eye, including reflections from the external surface and reflections from the internal surfaces of facets (called



brilliance of different brilliant-cut diamond due to cut depend on angle and light proceed

total internal reflection) of a gemstone, plus fire and scintillation added to both. Given equal transparency, polishing, luster, and reflection due to cutting, the gem species with the highest refractive index is the most brilliant. Brilliance depends upon the exact cut of a transparent stone, when cut too shallow or too deep, the entering light the stone dose not reflected past the table

of the stone. The term brilliance should not be confused

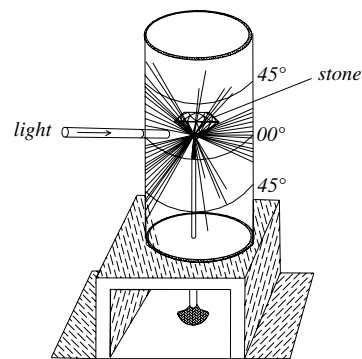


brilliance and paths of light passing and reflecting back through ideal brilliant-cut diamond

with scintillation. The term brilliance is derived from beryl.

**brilliance;** amount of reflecting light of a body, including brightness and saturation. → Total reflection, luster, scintillation.

**brilliance scope;** an instrument used to measure the brilliance of a diamond, both its external and internal



brilliance scope

reflections. Also called incorrectly brilliance scope.

**brilliance;** same as brilliance.

**brillianceer;** → brillianteer.

**brilliant;** the term is misapplied to mean any brilliant-cut gemstone.

**brilliant;** same as a brilliant-cut diamond.

**brilliant;** misapplied to any brilliant cut, especially, colorless, glass imitation.

**brilliant;** a commercial term for synthetic rutile, used as a diamond imitation.

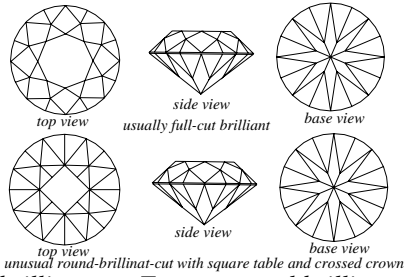
**brilliant circle;** a trade term for polished girdle.

**brilliant color;** same as diamond color.

**brilliant cut (round);** the most popular style and cut for diamond and other transparent gemstones. Brilliant cut increases the brilliance and minimizes the amount of light that escapes at the bottom of the gemstone. Brilliant-cut stones exist in the style of two octagonal pyramids. The line where the two pyramids meets is called the girdle, above which is the *crown* and, below which is the *pavilion*. The large facet, parallel to the

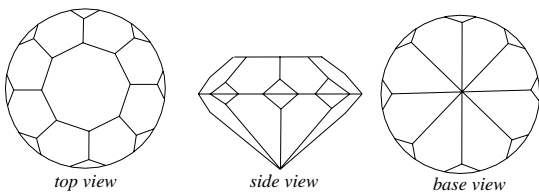


girdle on the crown is called the *table*, and the small facet, parallel to girdle on the pavilion is a *culet* or an apex. The triangular facets along both sides of the girdle, (parallel to the girdle with their bottoms) are now collectively known as *girdle facets*. (Those 16



two brilliant cut. Top row usual brilliant cut & second row round brilliant-cut with square table

facets that face upward from the girdle are known as *upper girdle facets*, and those 16, which face downward are called *lower girdle facets*). The 8 lozenge-shaped facets on the crown are *kite facets* or *main facets* (also called bezel facets, of which four are *quoins* and other four called *templets*), and those 8 small triangular facets, that, with the bottom meet the table are called *star facets*. Those 8 facets that extend downward from girdle to the culet are known as *pavilion facets*. The standard round, (girdle outline), brilliant consists of a total of 58 facets, (sometimes less but often more): 1 table, 8 main facets, (bezel facets), 8 star facets, and 16 upper girdle facets on the crown, (32 facets on the crown); and 25 facets in the base: 8 pavilion facets, 16 lower girdle facets, and usually a culet on the a pavilion. To obtain the most brilliance, the angle between crown facets and the girdle must be 35°- 40°, and the angle between the pavilion facets and the girdle must be 40°. In a standard, brilliant cut, the depth of the crown is about 35-40% of that of the girdle. The diameter of the table is approximately 55% of that of the girdle. Usually the culet is small or, is not present in some modified modern cuts. When the pavilion, (or crown), is too deep or too shallow, too much light escapes through the bottom of the gemstone. Sometimes called full-cut brilliant. → Standard round



eight-side cut

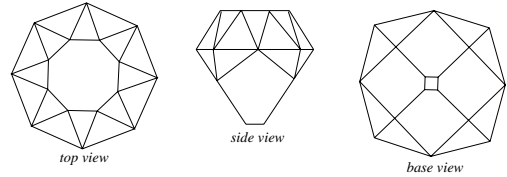
brilliant cut.

**brilliant cut, American;** a modified, brilliant cut is in use in the USA.

**brilliant cut, dispersion in;** → dispersion of diamond.

**brilliant cut, eight side;** this cut is a simple eight-sided form, in which the table and culet have 8 bezels and 8 pavilions.

**brilliant cut, English;** a cushion shaped brilliant cut,

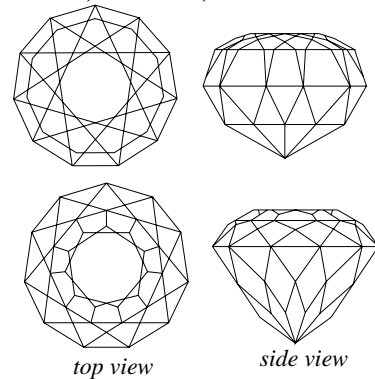


English brilliant-cut

with fewer facets. The bezels and half the cross facets are omitted, leaving the table 8 star and 8 cross facets.

**brilliant cut, sixteen sides;** this moderately simple cut, the sixteen-sided or Swiss-cut, has 8 cross facets added, both above and below the girdle.

**brilliant cuts, modified;** there are several modification



modified brilliant cuts

of brilliant cut, which differ in both outline and in the number of facets, such as the pendeloque cut, the marquise cut, the cushion shaped, etc.

**brilliant glass;** a misleading name for a flat diamond fragments used as portrait stones.

**brilliant, smallest;** → kolibri.

**brilliantdeur;** → brillianteerder.

**brilliante;** a commercial term for synthetic, strontium titanate, used as a diamond imitation.

**brilliante;** a commercial term for synthetic rutile, used as a diamond simulant.

**brilliantdeur;** → brillianteerer.

**brillianteerer;** a Dutch term, applied to the diamond cutter who completes the final stages of putting on and polishing the facets of a brilliant-cut stone, (24 crown and 16 pavilion facets), after the cross-cutter has done his work. Also spelled brilliantdeur, and brilliandeer.

Also called finisher.

**brilliandeeding**; the process of placing and polishing the remaining facets on the crown and pavilion of a brilliant-cut diamond, after the cross cutting. Also called Brillianceering. → Blocking.

**brillianteeding**; → brilliandeeding.

**brilliant-endscope**; an instrument used to measure inclusion-flawness in diamonds with a 10 time magnification.

**brilliant luster**; used to describe typical splendid luster, which can be seen on brilliant-cut diamond or other gemstones. This effect possessed only by mineral of high refractive index.

**brilliantography**; description of the brilliant cut.

**brilliantoscope**; incorrect spelling of brilliancescope.

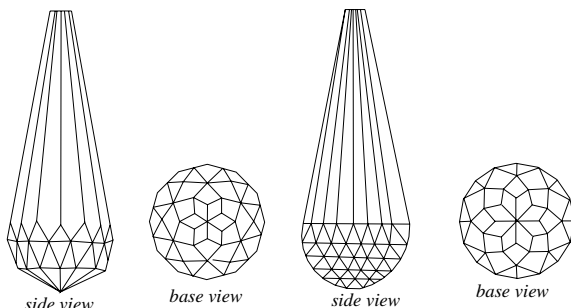
**brillionette**; same as half-brilliant.

**bril-lit**; trademark for a man-made corundum used as a diamond simulant.

**brimstone**; a common term for sulfur.

**Brinnel hardness test**; a system of measuring the hardness of a material, by heat treatment, which determines the hardness of pieces of mineral. The mineral is placed on the table of a machine, which causes the machine to presses an accurately made, steel ball against the test surface with a specific force. After removing the mineral, it is measured with a microscope, which determines its hardness number from a sample chart.

**briolette**; a diamond, or other transparent gemstone, cut in the shape of a teardrop, oval, or pear-shape with a double-rose cut in a circular cross-section. The entire



*briolette cuts with two different bases*

surface is cut with triangular facets, or less often with rectangular facets. It is an elongated modification of the double rose cut, without a table and culet.

**briolette**; another term for the Briolette of India Diamond or Briolette of India.

**briolette**; briolette is pierced along the length and used as an ear-ring or for suspension.

**Briolette of India**; → Briolette of India Diamond.

**Briolette of India Diamond**; the large briolette-shaped diamond of 90.38 cts, from India. After having passed

through several hands, in 1950 it was purchased by Harry Winston who bought it from an Indian maharajah. He sold it to Mrs. I.W. Killam who sold it back to Harry Winston. In 1971 it was sold to an unknown European. Also called briolette, or Briolette of India.

**Bristol brick**; a block of very fine sand, used for polishing and scouring.

**Bristol diamond**; a local, misleading term for a transparent variety of quartz from Bristol, England. Also called Irish diamond and Bristol stone, Bristol gem, Bristowes, and Bristos.

**Bristol gem**; same as Bristol diamond.

**Bristol glaze**; a raw glaze, containing zinc oxide, used in terra cotta.

**Bristol stone**; same as Bristol diamond.

**Bristos**; same as Bristol diamond.

**Bristowes**; same as Bristol diamond.

**Britannia metal**; a white alloy of a low melting point consisting of 80-90% tin, with copper, and antimony. Sometimes contains zinc, lead, or bismuth.

**Britannia silver**; an alloy with a higher silver content than sterling silver.

**British amber**; a variety of Baltic amber, fished from beaches off England. Clear or cloudy, yellow, or greenish-yellow and sometimes, wine color. Also called English amber.

**British Crown Jewels**; one of the world-famous diamond, gold, jewel and gem-set regalia, which has been collected by the British Monarchy. This Regalia is composed of crowns, scepters, swords, etc., and most were accumulated by Charles I, (1600-1649), but destroyed after his death then the collection was reconstructed about 1660. The British Crown Jewels have the famous diamonds, Cullinan I of 530.20 cts, and Cullinan II of 317.40 cts. Cullinan I is mounted in the Cross of the scepter and Cullinan II in the Imperial State Crown. Also in this collection is the Koh-i-Nûr Diamond, of 105.60 cts, which is set in the front of the circlet of the Queen Mother's Crown. The collection can be viewed in the British Crown Jewels House in the Tower of London. Also called Imperial Crown Jewels of England.

**British diamond**; a misnomer for a transparent variety of quartz, from Gloucester, England.

**British Diamond Distributors, Ltd.**; a branch of the Central Selling Organization, in England. Also known as Britmond.

**British Museum Aquamarine**; an oval step-cut aquamarine of sea-green from Russia of 879.50 cts. Now on display at British Museum Natural History, London.

**British Museum Morganite**; an antique brilliant-cut

pink morganite (beryl) of 598.70 cts, from Malagasy. Now on display at British Museum Natural History, London.

**British Museum, London;** an exceptional museum in which very famous and magnificent gems are on display at Natural History Department. Also known as British Museum of Gems and Jewelry.

**British Museum of Gems and Jewelry;** → British Museum, London.

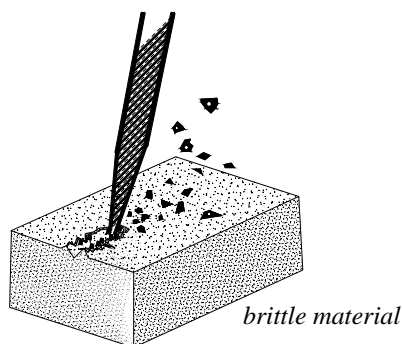
**British Regalia;** → British Crown.

**Britmond;** a semiacronym for British Diamond Distributors, Ltd.

**brittle;** the quality of a ductile, inflexible, mineral, for example that a mineral crumbles, when scratched with a knife blade or hammer. Meaning, easily broken or fractured by a blow or snapped. This is not the same as fragile, and does not relate to its hardness. → Toughness.

**brittle amber;** a misleading term used by miners for gedanite, because of its brittleness and harness.

**brittle mineral;** a mineral easy broken into fragments or



powder, under a light blow or a mineral, which easily crumbles.

**brittle silver;** a synonym for stephanite or black silver.

**brittleness;** the tendency of a mineral or material to fracture easily under low stress. A tough stone such as a diamond, despite its highly hardness, is rather brittle as it can not withstand a heavy blow. → Toughness.

**brocade stone;** a term for speckled jasper.

**broccatello marble;** a misleading term for a fine, bright red and yellow, compact variety of marble from Tortosa, Spain and the Pyrenees, France. When traversed by golden veins it is known as castracané.

**broad cutting filter;** → color filter, Chelsea color filter, filtered light.

**broad flash;** a term used by Australian miners for a pattern of quick flash of color in which the flash-color appears and disappears across part or the entire sample.

**broacher;** when the hole of a drilled pearl for using of endscope is too small it will be broaching out with a square-section needle of tempered fine point.

**Broderick Diamond;** the diamond of 412.50 cts, found in 1928 in Barkly West, South Africa.

**broken;** a term used by Australian miners for an opal level consisting of a mixture of opal dirt and sandstone but without hard sandstone roof.

**broker;** same as diamond broker.

**bromellite;** the third hardest natural minerals known. It is a rare, form of white beryllium mineral. It has also been made synthetically. Not to be confused with bromlite.

System: hexagonalic.

Formula:  $2[\text{BeO}]$ .

Luster: vitreous.

Colors: white.

Streak: colorless.

Diaphaneity: transparent.

Cleavage:  $\{1010\}$  distinct and two other indistincts.

Fracture: conchoidal to uneven.

SG: 3.017.

H 9.

Optics;  $\omega$ : 1.719,  $\epsilon$ : 1.733.

Birefringence: 0.014. ⊕.

Found in Langban, Sweden.

**bromellite, synthetic;** → synthetic bromellite.

**bromine;** a nonmetallic, halogen element, in the seventh group of the Periodic System with the symbol Br.

**bromlite;** an orthorhombic carbonate mineral of the formula  $2[\text{BaCa}(\text{CO}_3)_2]$ , midway between witherite and strontianite. Not to be confused with bromelite. Also called alstonite, barytocalcite.

**brom-toluene;** an organic liquid,  $\text{BrC}_6\text{H}_5$ , used for certain refractive index tests. RI:1.55. Miscible with xylol, alcohol and ether.

**bromofrom;** an organic, colorless, volatile, heavy liquid, with the formula  $\text{CHBr}_3$  and a narcotic odor. RI:1.598, SG:2.90 at 19° C. Miscible with xylol, alcohol, benzene, chloroform, and ether. Used for determination of specific gravity, as an immersion liquid, and in the laboratory for separation of minerals into floats.

**bronze blanco;** a synonym for arsenopyrite.

**broncita;** a Spanish spelling for bronzite.

**Bronkhorstpruit;** location of a minor alluvial diamond deposit in Transvaal Province, South Africa.

**bronze;** any variety of a reddish-brown alloy, of mostly copper, with tin up to 11%. Sometimes, contains silver, zinc, aluminum, manganese, lead, and beryllium.

**bronze;** a term applied to bronze statuette.

**bronze;** in Brazilian, a term applied to a greenish diamond, due to a thin outer skin.

**bronze mica;** same as phlogopite.

**bronze pearl;** a variety of dark pearl, with a bronze-like color and sheen.

**bronzite**; a member of orthopyroxene group. A brown or green mineral, closely related to enstatite, which has a bronzy luster and a chatoyant effects. Chemical formula:  $8[(\text{Mg}, \text{Fe}^{+2})_2\text{Si}_2\text{O}_6]$ . Optics;  $\alpha$ :1.663,  $\beta$ :1.669,  $\gamma$ :1.677. Birefringence: 0.014.  $\oplus$ . SG:3.2. H:5-6. A 6-rayed star bronzite, of brown color (due to oriented tubes), exists in Sri Lanka with SG:3.41. Also called clintonite, holmite, seybertite, hemiprismatic schiller-spar. → Enstatite, bastite.

**bronzite (of Finch)**; another synonym for clintonite.

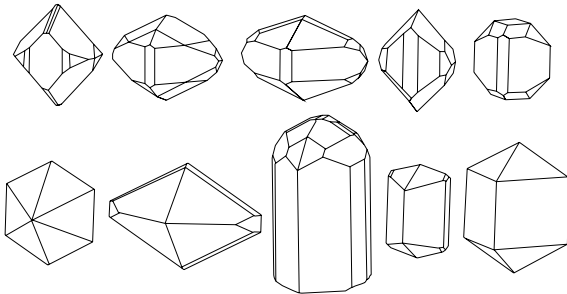
**bronzite cat's-eye**; a misleading term for bronzite, which exhibits a chatoyancy effects.

**bronzitite**; a rock composed almost entirely of bronzite.

**brooch**; an ornamental piece, worn, pinned to a garment, hood, hut, turban, in the hair, on the breast, at the neck or shoulder. Brooches are made in various forms, such as flowers, discs, rings, hearts, etc., sometimes set with gemstones or enameled. Also called pin.

**Brooke Diamond**; the red-tinged diamond of unknown weight, from the British Isles, found in 1816. Belongs to the Brooke family.

**brookite**; a trimorphous, titan-oxide mineral, from the



*brookite crystals*

rutile group, as anatase, and rutile. Pleochroism strong. Also called pyromelane.

System: orthorhombic.

Formula:  $8[\text{TiO}_2]$ .

Luster: adamantine to submetallic.

Colors: light brown to dark brown, reddish brown and black.

Streak: white to gray to yellowish.

Diaphaneity: transparent to opaque.

Cleavage:  $\{120\}$  distinct, and  $\{001\}$  in trace.

Fracture: conchoidal to uneven. Brittle.

SG: 4.14-4.15.

H:  $5\frac{1}{2}$ -6.

Optics;  $\alpha$ : 2.5831,  $\beta$ : 2.5843,  $\gamma$ : 2.700-2.740.

Birefringence: 0.122-0.158.  $\oplus$ .

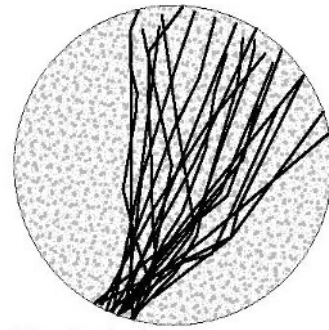
Dispersion 0.131.

Found in the Ural mountains (Russia), New York, Massachusetts (USA), Switzerland, Brazil and France.

**brookite pleochroism**; pleochroism strong: yellow-brown, red-brown and golden-brown or orange-brown,

**broom-like inclusions**; a term applied to thread-like,

fibrous inclusion similar to a broom seen in some



*broom-like inclusions in green tourmaline*

gemstones such as in green tourmaline.

**Broome pearl**; same as Australian pearl. Australian pearls are marketed through Broome, Western Australia.

**brotocrystal**; a crystal fragment, which is only partly assimilated in a later magma.

**brown**; one of the color classifications of a diamond, or a brilliant. The Brown color can refer to grade: black, olive, orange, purple, pink, red or yellow.

**brown**; in color nomenclature, this includes all brown shades: red-brown, yellowish-brown, orange-brown, yellow-brown, reddish-brown, orange-brown, etc.

**brown cleavage**; a diamond fragment of any shade of brown.

**brown corundum**; a yellowish-brown gem quality of corundum.

**Brown Derby Topaz**; an American topaz of  $\approx 300\text{kg}$  in rough found in 1972 in USA. Present whereabouts unknown.

**brown diamond**; the brown colors in diamonds are caused by the presence of both nitrogen and amorphous carbon. Brown diamonds are usually graded as slightly brown, light brown, or a brownie. These are not dark enough to be termed a fancy color. → Brown.

**brown hematite**; a misleading term for limonite.

**brown hornblende**; a brown variety of hornblende, rich in iron.

**brown hyacinth**; a misleading term for vesuvianite.

**brown iron ore**; another term for limonite.

**brownish-red**; same as brow red.

**brownie**; a trade term sometimes used to describe any diamond with a brownish tint or of a light brown color.

**brown lead oxide**; another term for lead dioxide.

**brown mica**; another term for phlogopite, which is known as amber mica.

**brown ocher**; a limonite used as a pigment.

**brown ore**; a limonite used as a pigment.

**brown pearl**; a term applied to conchiolin rich pearls, which are of little interest.

**brown quartz**; a variety of clear quartz crystal of

varying hues from light brown to dark brown, *smoky quartz*, and black. The black type is known as *morion*, and the brown, *cairngorm* that is found in Cairngorm, Scotland. Cairngorm is a term for faceted brown quartz. The naturally colored center is produced by impurities of aluminum, by irradiation, or perhaps, organic substances. Some irradiated and natural brown quartz will turn color to greenish yellow by heat treatment. The color is irreversible to brown, by re-irradiation. Used as faceted gems in a range of sizes. Most cairngorms, which are sold, are heat treated amethyst from Brazil. Found in the USA, Scotland, Switzerland, Australia, Malagasy, Japan and Spain. → Smoky quartz.

**brown red**; in color nomenclature, a color between brown and natural red. Also called brownish-red.

**brown red**; a brown red mineral of iron oxygen-hydrate.

**brown resin**; same as beckerite.

**brown series**; one of the classifications of diamond or brilliant, which includes all brown nuances: red-brown, yellowish-brown, orange-brown, yellow-brown, reddish-brown, orange-brown, and greenish stones, which show the characteristic 504 nm absorption spectrum.

**brown spar**; any carbonate, colored brown to dark brown, by the presence of iron oxide or iron carbonate. Some specimens of them turn brown on exposure.

**brown zircon**; another term for brown or gray zircon. Also called zirconite.

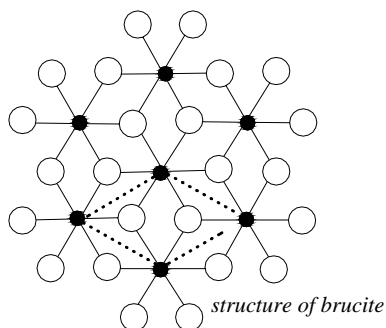
**brownstone**; a dark reddish-brown, ferruginous quartz sandstone in which the grains are coated with iron oxide. Used as a building stone.

**brownstone**; a term used almost to a dark brown sandstone from the Triassic of the Connecticut River Valley, USA.

**brownstone**; a term applied to a decomposed pyrite.

**bruciato**; an Italian term for dark brown to blackish coral, the lowest quality of precious coral. This coral has discolored naturally, at the bottom of the sea.

**brucite**; a hydrous, magnesia mineral. It is prized by



collectors. A mixture of brucite and lizardite is mislabeled serpentine by natives of Kashmir. →

periclase.

System: hexagonal.

Formula:  $Mg(OH)_2$ .

Luster: vitreous to waxy.

Colors: white, pale green, yellow, brownish-red to brown.

Streak: white.

Diaphaneity: transparent to translucent.

Cleavage: {0001} perfect.

Fracture: flexible, separable. Sectile.

SG:  $2.39 \pm 0.01$ .

H:  $2\frac{1}{2}$ .

Optics;  $\omega$ : 1.599-1.590,  $\epsilon$ : 1.580-1.601.

Birefringence: 0.010-0.020. ⊕.

Found in Canada, New Jersey, USA and Italy.

**brucite marble**; a product of dedolomitization, caused by the action of intense heat, (metamorphic process), on dolomite or magnesian limestone.

**brulo**; an old Syriac term for beryl.

**Bruneau jasper**; usually, a translucent jasper from Bruneau, Idaho, USA.

**brunnerite**; a massive, blue to violet variety of calcite, found as cuboid crystals.

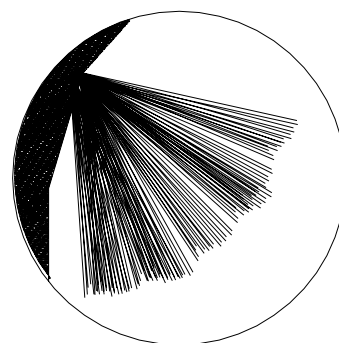
**Brunswick Blue Diamond**; the pear-shaped diamond of 13.75 cts. of a dark blue color. In 1784 sold it was to Charles, the Duke of Brunswick. Believed to be a part of the Tavernier Blue. Since the 19<sup>th</sup> century, it has not been seen.

**Brunswick Blue II Diamond**; the pear-shaped blue diamond of 6-7 cts, of unknown origin.

**Brunswick Yellow Diamond**; the diamond of 30 cts, from India, which formerly belonged to Duke Brunswick of the France. It was purchased by Tiffany & Co. in 1874.

**brush**; a type of mineral aggregate similar to a bunch of fine terminal semiparallel needles such as tourmaline. → Brush-mark.

**brush-mark**; a type of inclusion in synthetic emerald



*brush-mark inclusions in synthetic emerald created by the flux-fusion method*

created by the flux-fusion method, these appear as brush-mark.

**bruise**; a term describing: a blemish on rough diamonds, especially diamonds from alluvial placers. → Blemish.

**bruise**; a term describing: usually minute, white marks, often outlined, (square or hexagonal), by tiny cleavage or fractures on the surface of a cut diamond, caused by a sharp blow from a pointed objects. Also called a percussion mark or concussion mark. → Blemish.

**Brunswick, Duke of**; → Charles II.

**brush ore**; a term applied to stalactitic limonite.

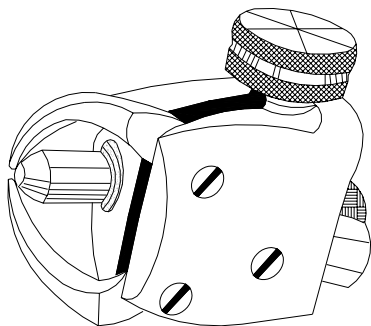
**brute**; a term, rarely used, meaning a rough or unpolished gem.

**bruted**; same as rough girdle.

**bruter**; a cutter who produces the girdle profile of a polished diamond.

**bruting**; another term for shaping, rondisting and grinding rough diamond or other transparent gemstones. A method of roughly cutting diamonds by rubbing one against another. Formerly, a laborious hand operation but now easily carried out by an electric eccentric chuck.

**bruting**; another term for removing some part of a diamond or other crystal by rubbing with another



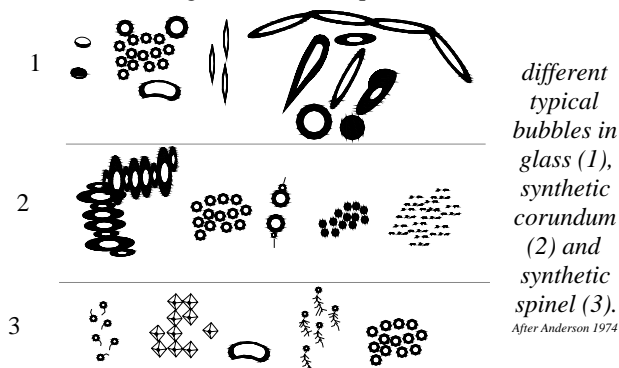
*bruting and  
polishing dop*

crystal. Also called cutting, grinding, or shaping.

**bruting lathe**; a mechanical device that rotates the diamond during bruting; rondisting and grinding.

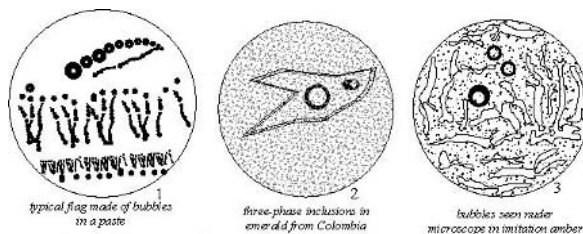
**Brypaal**; a small alluvial mine in Cape Province, South Africa.

**bubbles**; a small, spherical, oval or tadpole-shaped inclusion of gas, air or liquid, (sometimes both



together), seen in some synthetic stones and most glass.

Also seen in natural stones and resins, such as emerald,



*1 bubbles in glass, 2 three-phase inclusions in  
emerald from Colombia,  
3 three phase inclusions in emerald*

topaz, and many other true minerals.

**bubbling**; → intumescence.

**bucket-dumper**; a term used by Australian miners for a motor-driven truck which pulls dirt up the dumps for screening or puddling and sorting the opal out.

**buck quartz**; same as bull quartz or bastard quartz.

**buckhorn bivalve**; → buckhorn pearl.

**buckhorn clam**; → buckhorn pearl.

**buckhorn mussel**; → buckhorn pearl.

**buckhorn pearl**; a rare, fresh-water pearl from the Mississippi Valley, which occurs in the spherically formed mussel, *Tritogonia verrucosa*. These pearls have beautiful, iridescent nacre. Popularly known as the buckhorn clam or buckhorn mussel. Sometimes called deer-horn pearl.

**Buddha's Emerald**; same as Emerald Buddha.

**Buddha's tooth Emerald**; in Dalada Malagawa temple at Kandy, Sri Lanka a carved emerald of 10 x 5 cm in form of tooth holding in one hand.

**Buddhist prayer rosary beads**; → prayer beads.

**budding**; a term used in coral science for new branch colonies create by polyps, which increase in size by buddies and adding new individuals to the established colony.

**Buddstone**; a massive, opaque, bright green chalcedony with white veining, from South Africa. The green color is caused by the presence of chlorite. Used as an ornamental stone.

**budlike**; a term used for malachite from Ural, Russia, CIS, which resemble bud and has either radiated or concentric structure.

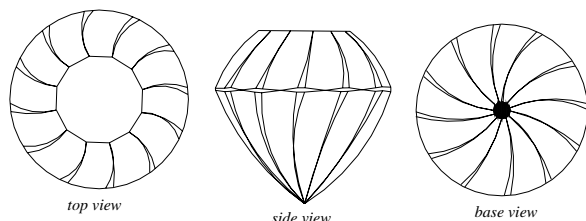
**bud-like cut**; a modified round brilliant cut similar to a flower bud. It consists of 24 facets and a table on the crown and 24 facets and a culet on the pavilion.

**Buergerite**; a term applied to a variety of tourmaline.

**buergerite**; a dark brown to black, iron-rich tourmaline. Chemical Formula:  $3[\text{NaFe}_3\text{Al}_6(\text{Si}_6\text{O}_{18})(\text{BO}_3)_3(\text{F})_4]$ . Found in Mexico. Optics;  $\epsilon$ : 1.655,  $\omega$ : 1.735. Birefringence: 0.080.  $\ominus$ .

**buff**; a wheel of soft, thick, flexible, covered with undyed cloth or leather, chiefly made from the skin of

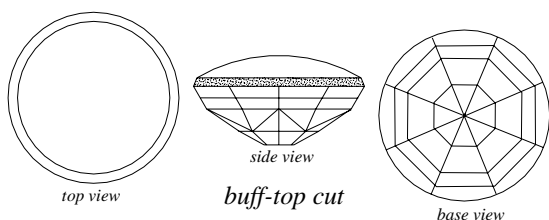
buffalo, oxen, or elk, dressed with oil, like shammy,



*bud-like cut*

and charged with abrasive powder, used for polishing.

**buffed up;** dyed black pearls which are soaked in a



*buff-top cut*

weak liquid of silver nitrate, placed under ultraviolet light or sunlight due to reducing of silver by action of organic constituent. The dried silver give to the pearl the hue of black that is known as *buffed up*, which means improving the color of pearls by staining.

**buff stick;** a piece of stick, covered with leather or velvet and charged with emery or other powder, used in polishing.

**buff-top;** → buffed top.

**buffed top;** an interesting combination of both a cabochon and faceted gem in one is found melded in the buff top. In this style, the top of the atone is a low, curved cabochon surface, while the bottom is covered with facets. A mixed cut.

**buffed up;** polished up, Shined up.

**buffed up;** improving the color of pearls by staining.

**Buffelhoutfontein diamond mine;** an alluvial mine in the Orange Free State, South Africa.

**Buffels Inland Complex;** location of alluvial diamond deposits, northeast of the Buffels River in Namaqualand, South Africa. → Langhoogte.

**Buffels Marine Complex;** location of alluvial diamond deposits, extending north of the Buffels River, in Namaqualand, South Africa.

**Buffels River;** → Langhoogte, Buffels Inland Complex.

**bug-hole;** a term used by Australian miners for holes usually caused by air or sand holes, which is interfered with the complete formation of opal.

**buhrstone;** a nodule or mass of siliceous rock found in a softer rock suitable for use as millstones.

**buhrstone;** open-textured, cellular, hard, fine-grained sandstone suitable for millstones.

**buhrstone;** a silicified fossiliferous limestone. Also written burr and called whetstone, millstone, or buhrstone.

**building granite;** → building stone.

**building rock;** → building stone.

**building stonecutter;** → stonecutter.

**building sandstone;** → building stone.

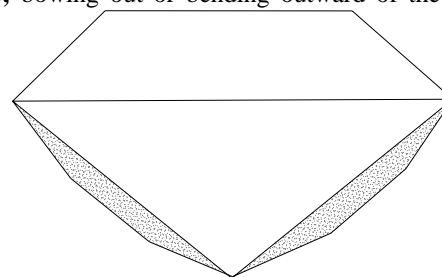
**building stone;** any massive, dense rock, suitable for use in masonry, construction and ornamentation. Practically, all varieties of igneous, sedimentary, and metamorphic rocks are included. A building stone is chosen for properties of durability, covered, attractiveness, and price. Also called cladding stone, paving stone.

**bulb opal;** another term for menilite opal.

**Bulfontein diamond mine;** one of the *Big Five* diamond-bearing mines in Kimberly district, South Africa.

**bugle head;** an elongated, black, hollow cylindrical glass bead, used in the embroidery of some women garments.

**bulge;** bowing out or bending outward of the pavilion



*step cut with bulge pavilion*

facets in a step-cut diamond.

**bulge;** a tumescence of igneous lava. Also called belly.

**bulge factor;** some step-cut diamonds show a bulge on the pavilion facets due to excessive weight retention. In the GIA diamond evaluation system a series of deductions based upon excessive bulge is in use. → Bulge.

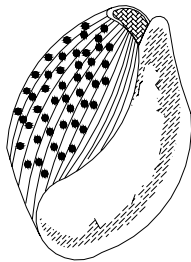
**bull clam;** a kind of pearl bearing cephalopod bulldozer fitted with striated curved bowl hinged on the top of the front of a blade.

**bullet;** a grade term used by diamond and gem cutters for a small, virtually flawless, lustrous and nearly spherical industry diamond, which may be occasionally used as a drill diamond.

**bullet;** same as drill diamond.

**bullet cut;** an elongated, modification of a pentagonal step-cut style, which resembles a bullet in the outline.

Same as obus.



bull clam

**bullock**; this term is misspelled by Australia opal miners in mullock.

**bullhead bivalve**; → bullhead pearl.

**bullhead clam**; → bullhead pearl.

**bullhead pearl**; a fresh-water pearl, from the Mississippi Valley specie of mussel, *Pleurobema oesopus*, popularly known as the bullhead clam. Its nacre is not so iridescent as to be considered with pearls of good quality.

**bullion**; uncoined gold, silver or other refined, precious metals in the shape of bars, ingots or comparable masses.

**bullion**; gold-silver alloy, produced before separation.

**bull quartz**; a miner's term for white glassy quartz. Also called bastard quartz, buck quartz.

**bull's-eye**; same as bull's-eye labradorite.

**bull's-eye condenser**; an observation condenser, used with a microscope, for studying of the surface structure of an opaque specimen.

**bull's-eye corundum**; an effect can be seen in some modern synthetic corundum with circular zoning feature on the bottom surface of cabochon cut, which occur by concentric bands forming to nearly complete bull's-eye feature.

**bull's-eye labradorite**; a dark, shiny-colored labradorite. Also called bull's-eye.

**Bultfontein diamond mine**; the location of a kimberlite diamond deposit in the Kimberly, Dutoitspan, of South Africa. Also called Bultfontein mine.

**Bultfontein mine**; same as Bultfontein diamond mine.

**balur**; another spelling of the Farsi (Persian) term bolur for quartz.

**Bumpus quarry Maine Beryl**; a giant size star-like beryl some crystals of them were 120 cm in diameter, found in 1953. In USA.

**bunch ring**; a type of finger ring, set with a tiny, part-faceted or rough diamond, so-called because such rings were sold inexpensively in bunches.

**bundle of twigs**; a term used for bundle of wisps feature inclusions found in Inamori synthetic rubies similar to rain like.

**Bunsen burner**; a smokeless and nonluminous flame gas burner, consisting of a metal tube with an adjustable air-valve, for burning at the bottom of the tube, and the flame being at the top. Used as a source of heat, for laboratory work and for jewelry work.

**bur**; a nodule or mass of siliceous rock found in a softer rock suitable for use as millstones. Also written burr and called whetstone, millstone, or buhrstone.

**bur**; an open-textured, cellular, hard, fine-grained sandstone suitable for millstones. Also written burr and called whetstone, millstone, or buhrstone.

**bur**; a silicified fossiliferous limestone. Also written burr and called whetstone, millstone, or buhrstone.

**burallou**; an old Assyrian term for beryl.

**burallu**; an old Assyrian term for beryl.

**Bureau d'Information des Perls de Culture, Paris**; Abbreviation : BIPC.

**Burgenland jade**; a local term used incorrectly for fine serpentine or compact pennin from Burgenland, Austria.

**Burgess Diamond**; the diamond of 220 cts, found in 1907, at Vaal River, South Africa.

**burial**; a term used for jade articles, which have been buried together with quicksilver in a tomb usually with the dead as a Chinese custom that has altered color to brown or reddish skin by associated bronze articles.

**buried jade**; a misleading term for a variety of nephrite of a yellowish or grayish-brown color, which is of archaeological interest. It was buried through the ages and found in the yellow losses of China.

**Burlington Diamond**; the diamond of 2.11 cts, found in 1892, near Burlington, Wisconsin, USA.

**Burma amber**; same as burmite, from Myanmar, (Burma).

**Burma epidote**; a misleading term for jade-albite from Myanmar, (Burma).

**Burma gemstones**; generally, any gem found in Myanmar, (Burma), including ruby, sapphire, amber, spinel, and etc.

**Burma jade**; → Burmese jade.

**Burma moonstone**; a floating, billowy, white or silver blue moonstone, (albite-feldspar), from Myanmar, (Burma).

**Burma peridot**; a misleading term for jade-albite, from Myanmar, (Burma).

**Burma ruby**; a commercial term for a fine, pigeon, blood color natural ruby whether or it is not from Myanmar, (Burma). Also called Burmese ruby, and pigeon's-blood ruby.

**Burma sapphire**; a fine, blue sapphire, whether, or not it is from Myanmar, (Burma). Also called Burmese sapphire.

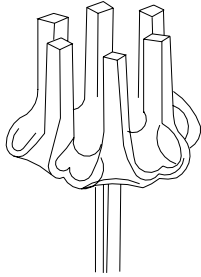
**Burma sapphire**; a misleading term for synthetic blue sapphire.



- Burmese jade;** the finest known jadeite, from upper Myanmar, (Burma) near Mogok.
- Burmese jade;** a commercial term used in the orient, to distinguish Burmese jadeite from all other varieties of jade, (nephrite). Also called Burmese jadeite and Burma jade.
- Burmese jadeite;** → Burmese jade.
- Burmese sapphire;** same as Burma sapphire.
- Burmese shell;** a pearl-bearing shell, from the waters around the Mergui Archipelago, Myanmar (Burma).
- Burmese spinel;** fine varieties of red and fire spinel, found as perfect octahedrons of gem quality. Found near Mogok in upper Myanmar, (Burma) in alluvial deposits, often found with rubies.
- burmite;** a dark brown, pale-yellow, or reddish varieties of retinite, that resemble amber, but burmite is tougher and harder than Baltic amber, found in Oligocene clay soil in the Hukong Valley, Myanmar, (Burma). Regarded as a variety of amber low in succinic acid. Sometimes stained red. → Chinese amber.
- burned;** a term used by Australian miners for burning process of opal.
- burned honey;** an ancient term for amber because may be a bee was preserved within amber.
- burned opal;** a term used by Australian miners for porous part of the matrix with minor color similar to opal.
- burning geuda;** a term applied to heat treatment process of geuda sapphire from Sri Lanka. → Geuda.
- burning glass made of amber;** a piece lens made of transparent amber for providing fire.
- burning of diamonds;** → heat.
- burn marks;** a lightly-frosted effect, groove, scratch or crack, on the surface of a diamond, caused by overheating, when polishing. → Dop marks.
- burned stone;** same as burnt stone. Also called burnet stone.
- burned gemstone;** same as burnt stone. Also called burnet gemstone.
- burnisher;** a tongue-shaped, metal or agate tool, with a handle, for pressing the *fingers* against the stone.
- burnite;** a term applied to a rock-like mixture, consisting of azurite, malachite, and cuprite.
- burnt;** a term applied to a stone, which, has been subjected to heat, to change its color, such as burnt amethyst, burnt cairngorm, etc.
- burnt amethyst;** a term applied to heat treated yellow, transparent quartz, which, unlike poorly colored yellowish citrine, is produced by heating natural amethyst or brownish hues of quartz.
- burnt borax;** a spongy mass of dehydrated borax, obtained by calcining hydrated sodium borate. Used in glass, ceramics, enamels, and in the porcelain industry.
- burnt cairngorm;** the term applies to heat treated, yellow, transparent rock crystal, known as topaz quartz, which has been changed from the color of cairngorm, (smoky quartz) to a topaz color.
- burnt coral;** same as bruciato.
- burnt gemstone;** same as burnt stone.
- burnt hair;** generally tortoise shell burning with a protein odor like hair.
- burnt jade;** a term applied frequently to chicken jade when fused into a glassy substance by heat-treatment.
- burnt quartz;** → burnt amethyst.
- burnt smoky quartz;** → heat-treated smoky quartz, burnt cairngorm.
- burnt stone;** stone, resulting from the changing of color in topaz, amethyst, aquamarine, smoky quartz, etc., by heat treatment or by burning, such as tiger-eye changes its color by heat treatment from yellowish-brown to reddish-brown.
- burnt stone;** occasionally, antique carnelian in archeological finds at ancient ruins, have apparently been treated with fire. Also called burnt gemstone.
- burnt topaz;** a natural topaz, which has been altered in color to a violet-pink topaz.
- burr;** same as bur.
- burr;** a small, hand-held rotary milling cutter, like a dentist's drill.
- burr;** a small, rough edge, remaining on a surface after cutting or grinding.
- burrstone;** a variety of buhrstone.
- burstone;** same as buhrstone.
- Burton, Richard;** → Taylor-Burton Diamond.
- Burundi;** a small country in the heart of Africa, important to the diamond trade.
- Buryata;** location of several diamond deposits, on the eastern slope of the Sayan mountains in the Russian Federation, CIS.
- Bushimaie River;** a river in Zaire, along which are found alluvial diamonds.
- bustamite;** a green to reddish mineral, similar to wollastonite. A variety of wollastonite. Prized by collectors.
- System: triclinic.  
Formula:  $12[(\text{Mn}, \text{Ca})_3(\text{Si}_3\text{O}_9)]$ .  
Luster: vitreous.  
Colors: pale flesh-pink to red, brownish-gray.  
Streak: colorless.  
Diaphaneity: transparent to translucent.  
Cleavage: {010} perfect, {010} good and vary.  
SG: 3.32-3.41.  
H: 5½-6½.  
Optics:  $\alpha$ :1.662-1.695,  $\beta$ :1.674-1.707,  $\gamma$ :1.676-1.710.  
Birefringence: 0.014. ⊖.  
Found in Sweden, New Jersey, USA, Japan, Tanzania,

and Australia.

**buttercup head;** modification of a cluster setting, with six-prongs resembling buttercup flowers. → Cluster



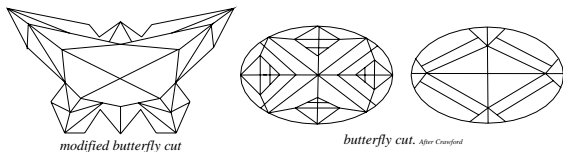
buttercup setting

setting.

**butterfly;** a motif used in jewelry of gold, silver, or other noble metals, decorated with diamonds or various colored gemstones. → Bow tie.

**butterfly clam;** same as butterfly mussel. → Butterfly pearl.

**butterfly cut;** a motif used in jewelry made of diamond



two different kind of butterfly cuts

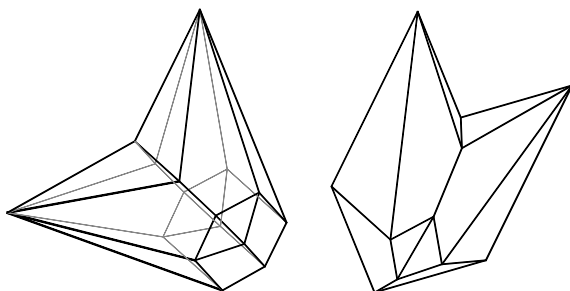
or other stones.

**butterfly inclusion;** an inclusion, which, from some direction looks like the wings of a butterfly.

**butterfly mussel;** → butterfly pearl.

**Butterfly Opal;** same as Red Admiral Opal.

**butterfly pearl;** a fresh-water pearl of the Mississippi Valley, from the mussel, *Plagiola securis*, which has unusually permanent, beautiful-luster nacre and produces fine pearls comes Known as butterfly clam and butterfly mussel.



two calcite butterfly twins

**butterfly stone;** same as Red Admiral Opal.

**butterfly twinning;** a kind of contact twinning seen in calcite, which formed at the twin plane 2311. Prized by collectors.

**butterfly wings;** → fingerprint inclusion.

**button;** any small usually flattened round object made of metal, gemstone, sandstone, wood, plastic, glass, etc., which is attached to a garment for the purpose of fastening two pieces of cloth together, by passing the button through a slit.

**button onyx;** term applied to an opal-agate, with alternating bands of black chalcedony and common opal, from Mexico. Also spelled button opal.

**button opal;** same as button onyx.

**button pearl;** a type of natural, or cultured pearl, having a rounded top and a flattened base. It occurs, when the incomplete pearl is attached to the inside of the oyster. Suitable for ear-studs, dress studs and for rings. Also called boutons pearl and button-shape pearl.

**button-shape pearl;** same as button pearl.

**Buxton diamond;** a misleading term for transparent quartz crystal from Buxton, England.

**buyer's box;** a special metal container, used at sights to hold several hundred rough diamonds, wrapped in parcel papers. Larger stones are offered individually.

**bye (diamond);** a color-grading term, used for rough diamonds tinged, with yellow. Stones are termed *first bye* or *second bye* to clarify the degree of yellow color. Also called byewater.

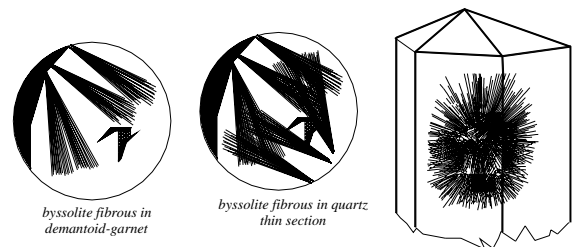
**byewater;** a color grade of yellowish diamond or same as bye (diamond). Also spelled bywater.

**Byfield Diamond;** the diamond of 54.74 cts. It was set in a ring, and once belonged to the late Vala Byfield. Present owner unknown.

**byon;** a native term for gem-bearing alluvial gravel, in which ruby, sapphire, corundum, etc. occur. Found in Upper Myanmar (formerly Burma). Also spelled byone, bion.

**byone;** same as byon.

**byssolite;** a commercial term for a variety of quartz



byssolite fibrous in demantoid, quartz crystal and thin section

containing greenish, fibrous inclusions of actinolite or asbestos. Generally, an olive-green, fibrous variety of

amphibole.

**byssolite**; a characteristic inclusion in radiating form may be seen in demantoid garnet and are referred to as *horsetail*.

**byssus**; a tuft or bundle of long, tough, thread-like, hair-like or silky filaments. A substance secreted by glands in the foot of certain bivalve mollusks to enable them to attach themselves to hard bodies or surfaces, the sea floor or to one another.

**bytownite**; a transparent to translucent, reddish, bluish or pale-yellow mineral of plagioclase feldspar, having compositions varying from Ab<sub>30</sub>-An<sub>70</sub> to Ab<sub>10</sub>-An<sub>90</sub>. They occur in basic and ultrabasic igneous rocks.

Colorless, gray and white. Vitreous luster. Optics;  $\alpha$ :1.561,  $\beta$ :1.565,  $\gamma$ :1.570. Birefringence: 0.009.  $\ominus$ . SG:2.72-2.74. H:6-6½. Found in Canada, the USA, Iceland, Sweden, England, Japan, and South Africa. Sometimes used as a gemstone. A red-colored variety is misnomerly called *andalusite*.

**bytownite**; an igneous rock consisted almost entirely of bytownite.

**bywater**; → byewater.

**Byzantine mosaic**; a design or decoration, made up of small pieces of colored stone or glass, cemented in an upright position to a recess, usually in a glass frame. Also called Roman mosaic. → Mosaic, Roman mosaic.

# C c

**c**; a symbol for one of the three crystallographic axes. Conventionally, the vertical axis is the *c* axis. with subscript °*c*. The letter “*c*” usually appears in italics.

**c**; abbreviation used in gemology for carat.

**C**; a chemical symbol for the element carbon.

°**C**; degrees Celsius, known as centigrade.

**C**; one of the Fraunhofer lines, in the red area of the solar spectrum, its wavelength is 656.30 nm, caused by hydrogen.

**C1, C2, C3, C4, C5, C6, C7**; a color grading scale used in the trade, by Argyle Diamonds, from Australia, for grading brown colored diamonds: C1, light champagne; C2, champagne; C3, medium champagne; C4, light cognac; C5, medium cognac; C6, cognac; and C7, fancy cognac.

**Ca**; a chemical symbol for the element calcium.

**Cabinet des Médailles**; a museum of different engraved gemstones from old Egyptian cylinder made of emerald to modern pieces in Paris, France. → Julia portrait, Oratorium of Charlemagne.

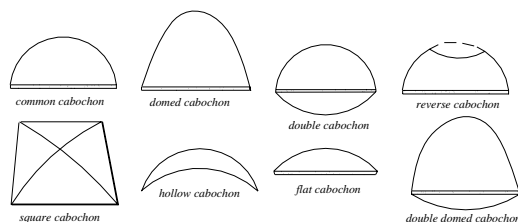
**cabinet of gems**; same as cabinet of minerals. → Collector.

**cabinet of minerals**; any fine specimen of mineral or gem, which is a collector’s item. Same as museum of minerals. → Collector.

**cabinet stone**; same as cabinet of minerals. → Collector.

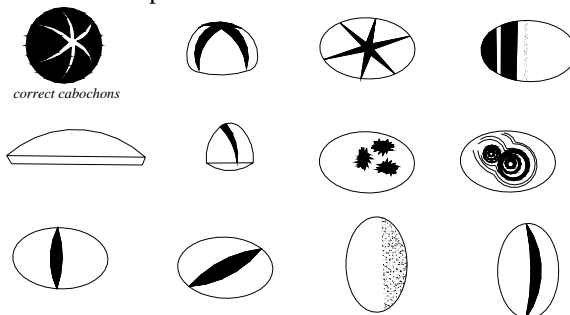
**cabochon**; an unfaceted, highly polished, cut gemstone, in which the top of the gem forms a dome-shaped or curved, convex surface. The base may be flat, convex or concave. The girdle outline may be round, oval, square, triangular, polygonal, or any other fancy shape. Usually, a cabochon stone is one cut from a poor quality or a translucent to opaque mineral, or material, and those with a special optical effect, such as opal, moonstone, adularia, asteria etc. Stones with needle-like inclusions are cut with high cabochon, to obtain a star-like effect or eye-like effect. There are 4 basic cut forms of cabochons: (a) the *simple cabochon*, with a convex top of varying degrees of steepness and a flat base. (b) *Double cabochon*, a lentil-shaped cabochon or a convex top and base cabochon but the underside is flatter than the upper dome. Also called *concavo-convex*. (c) *Hollow cabochon*, a cabochon cut, which has a concave depression, hollowed out of the bottom section to improve or lighten the color. (d) *Tallow-topped cabochon*, a cabochon with a shallow dome

often used for opal, or moonstone. Adularia is cut as a low cabochon, to achieve a special optical effect. Also



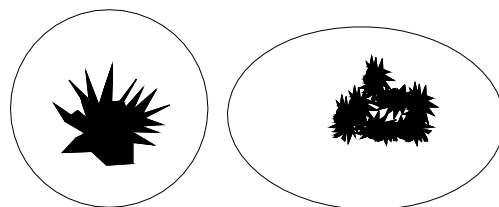
*different cabochon cuts*

called *cabochon cut* and written cabouchon. Sometimes the lentil-shaped cabochon is called double cabochon,



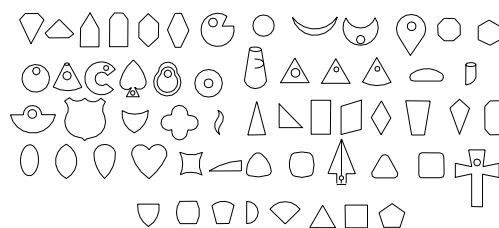
*incorrect cut cabochons. After Fischer 1989*

hollow cabochon, or tallow-topped cabochon. Cabochon, cut from almandine, (carbuncle), cat’s-eye, tiger’s-eye, and amazonite are said to be cut *en*



*two different cabochon cut of dendritic inclusions*

*cabochon*. Sometimes, opaque stones can exhibit



*modified cabochons-cuts*

chatoyancy or asterism.

**cabochon cut**; → cabochon.

**cabocle**; a compact, rolled pebble, resembling red jasper, supposed to be hydrated phosphate of calcium

and aluminum, found in the diamond-producing sands of Bahia, Brazil.

**cabook**; a Sri Lankan local term for a reddish laterite, rich in iron and aluminum.

**cabouchon**; another spelling of cabochon.

**cabra stone**; another term for fluorite.

**cabujon**; Spanish term for cabochon.

**cachalong**; same as cacholong.

**cacholong**; a Tatar (Tatar Republic in NE Asia, section of Siberia, originating of Mongolia and Manchuria) term, meaning beautiful stone (Tatar spelling is kashtchilon). A porous, pale, bluish-white, or pale-yellow, due to the presence of aluminum, or a reddish, opaque, poor variety of opal. Having a porcelaneous or mother-of-pearl luster. Highly regarded in the East, but of little gemological interest in the occident. Occurring on the Cash River in Bokhara, the Russian Federation, CIS. Cacholong adheres to the tongue, because of porosity. Also spelled cachalong and called kalmuck agate, kalmuck opal, pearl opal, porcelaneous, pearl opal, mother-of-pearl agate and mother-of-pearl opal.

**cachalot**; → sperm whale ivory.

**Caciques**; a Spanish American-Indian term for dominated primarily in a Spanish-speaking region.

**Caciques of Guatavita**; Guatavita Lagoon located in the crater of emerald bearing region in Bogota in Colombian, was mined by Indian native before Spanish conquerors and was a religious ceremonies lake, by which gold and other gemstones together offered to calm the powerful god or devil residing there. The rites were held semiannually by Cacique, (Indians shamans or dominated primarily) or with chiefs padding boats which is drove exact into center of lagoon. While the Cacique is naked and dusted with gold powder, dived into the water, after he washed gold dust from his body, swam to strand. As Cacique entered the water, the Indian people around the lake threw their offerings into water over their shoulders. Some authorities thought it is a myth from El Dorado with the name golden one.

**cacona**; a term used by native Indians of southern Arizona, USA for turquoise ornaments. → Caconados.

**caconados**; a term used by native Indians of southern Arizona, USA for wearing of turquoise ornaments. → Cacona.

**cacoxenite**; these yellow or brownish minerals of  $\text{Fe}_4(\text{PO})_3(\text{OH})_3 \cdot 12\text{H}_2\text{O}$ , which are embedded in amethyst or rock crystal. Such material has a sheaf-like appearance.

**cadacryst**; same as xenocryst or inclusion. Also spelled chadacryst.

**cadmean stone**; a Greek term for calamine, of which calamine may be a corruption.

**cadmium**; a silvery-white, ductile, malleable metallic element, in the IIB group of the Periodic System, with the symbol Cd. Used as an alloy in gold solder to decrease the melting point and as a pigment in ceramic glazes and enamels. It is a highly toxic element.

**cadmium blende**; same as greenockite.

**cadmium laser**; → laser.

**cadmium ocher**; same as greenockite.

**cadmium sulfid**; same as greenockite.

**cadmium yellow**; same as greenockite. Used as pigment with RI:2.40.

**cadmium yellow glass**; → Kaiser yellow glass.

**Caen stone**; a pale cream variety of limestone, chiefly from Caen, Normandy, France. Marked with a rippling effect, it is largely used for building purposes.

**caeruleum**; a word for turquoise, in ancient Greek.

**Caesalpinaceae**; a family of leguminous trees producing copal such as Sierra Leone copal.

**caesium**; a highly reactive, tin-white, alkali metal element in-group IA of the Periodic System, with the symbol Cs. It resembles sodium in both chemical and physical properties. Also spelled cesium.

**caesium beryl**; a tem used for colorless beryl, rose beryl or morganite. Also spelled cesium beryl.

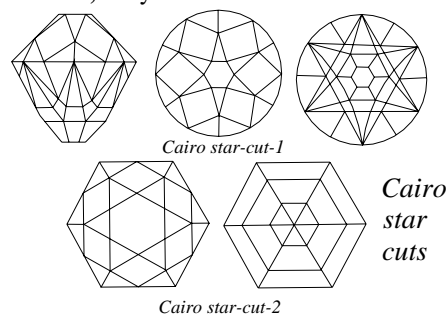
**caillou du Rhine**; a French term for the cut rock crystal pebble of the Rhine. Also called Pierre d' Alenon. → Rhine stone.

**Caire cut**; a star cut designed by the Frenchman Caire in the 18<sup>th</sup> century.

**Cainozoic**; a synonym for Tertiary plus Quaternary. Also spelled Kainozoic.

**cairngorm**; a local term for a variety of smoky quartz, with a smoky-yellow or smoky-brown color, from Cairngorm Mountain in Scotland. The color is caused by natural radioactivity. Used as faceted gems in all sizes. Most of the cairngorms in the trade are treated amethysts from Brazil. Also called cairngorm stone, smoky quartz, Scotch topaz, and brown quartz. Found in Arran (Scotland), the Swiss Alps, and Colorado (USA).

**Cairo star cut**; a style of brilliant-cut with 74 facets that



was developed from a briolette cut, made in order to

retain the maximum weight of the stone and a minimum loss of brilliancy. It has 24 facets and a small table on the crown, and 48 facets plus a culet on the pavilion. It has a minute 6-sided table, which is only  $\frac{1}{4}$  the width of the girdle, with a large culet. Also called Star Cut of Cairo.

**Caixepa**; a river in Angola, Africa, where a diamond mine is located.

**cakes**; in England, a term applied to gypsum minerals that are found as lenticular masses in Derbyshire. → Floors.

**Calaite**; an obsolete term for mammillary or botryoidal variety of turquoise. → Turquoise, variation of.

**calamine**; a European term for smithsonite.

**calamine**; in the USA, used for hemimorphite.

**calamine**; a name used for hydrozincite. Also called calamine stone. Frequently used for gems.

**calamine stone**; same as calamine.

**calamite**; an asparagus-green variety of tremolite.

**calbenite**; another term for myrickite.

**calc-alkalic**; an igneous rock, or a group of igneous rocks, in which the percentage by weight, of silica is between 56 and 61, when the weight percentages of CaO and  $K_2O + Na_2O$  are equal.

**calc-alkalic**; a term used for igneous rock, containing plagioclase feldspar. Synonym for alkali-lime.

**calcareous**; a mineral containing calcium carbonate.

**calcareous**; the nature of calcite. When applied to a rock, the name implies that a considerable percentage, (up to 50%) of the rock is calcium carbonate.

**calcareous**; same as carbonate.

**calcareous concentration**; another term cross section of a natural pearl-like object because mollusk deposits crystalline calcium carbonate around a sand, parasite, irritant, etc. This object can qualified as a pearl when outer plate consisting of aragon-nacreous crystalline layers with name nacre.

**calcareous sinter**; another term for travertine.

**calcareous spar**; another term for calcite or calcspar.

**calcédoine**; a French term for chalcedony.

**calcedonia**; Spanish or Portuguese name for chalcedony.

**calcedonia veteada**; a Spanish term for cachalong.

**calcedony**; a misspelling of chalcedony.

**calcentine**; a commercially, misleading term for an iridescent, opaque shell, consisting of aragonite, with patches and bands of red, blue, and yellow colors. Found in Canada. Also known as ammolite, korite.

**calcicase**; same as anorthite.

**calciferous**; bearing, producing, or containing calcium, calcium carbonate, or calcite.

**calcined gypsum**; same as plaster of Paris.

**calcinite**; a silicon-carbide product, used as an abrasive.

**calcio-olivine**; an orthorhombic variety of calcium

orthosilicate, known as  $\gamma$ - $Ca_2SiO_4$ , it is isomorphous with olivine. Also called lime olivine.

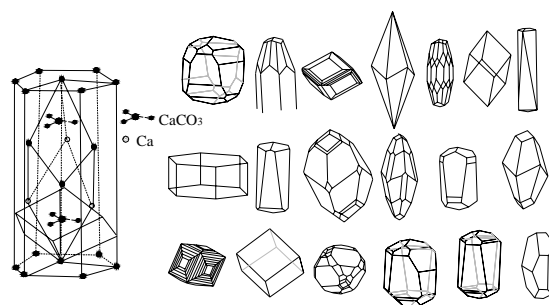
**calciphyre**; a calc-magnesium-silicate marble.

**calc-silicate**; metamorphic rock, chiefly consisting of calcite and calcium-bearing silicates. Also called lime-silicate.

**calc-silicate marble**; a marble with a conspicuous amount of calc-silicate and /or magnesium silicate. Also called calciphyre.

**calc-sinter**; same as travertine.

**calcite**; a transparent to translucent mineral, occurring in a wide variety of colors and patterns from massive aggregates to a variety of crystal forms. They are massive, fibrous, granular, stalagmitic, and chalky. Varieties of calcite include *Island spar*, *calcite satin*



calcite structure and crystals

*spar*, *marble*, *travertine*, and *flowstone*. It is trimorphous with aragonite and vaterite. This mineral is not a gemstone, but plays an important part in gemology, as it is used in scientific instruments, optically pure form, *Iceland spar*. Calcite is better known as limestone. *Cobalt calcite* is a pink variety, colored by cobalt, and often cut into cabochon. *Cave pearls* are a misleading term for a concretion of calcite or aragonite, with a pearly luster. Misleading names of some varieties are: *onyx marble*, which is a banded stone; *Mexican onyx* also a banded stone; *Mexican jade* a green-dyed, massive stalagmite calcite; *atlas pearls*, beads made from white satin spar; *cerulene*, a blue satin spar and *California onyx* an amber-colored or brown-banded calcite. Also called calcspar, Iceland spar. Used for carving. It has the same chemical composition when crystallized in orthorhombic form. Aragonite is a major component of pearls.

System: trigonal or hexagonal.

Formula:  $2[CaCO_3]$ .

Luster: vitreous to pearly.

Colors: colorless, pale yellowish-to-yellowish green.

Streak: colorless, white to grayish.

Diaphaneity: transparent to translucent.

Cleavage: {1011} perfect.

Fracture: conchoidal to uneven. Brittle.

SG: 2.71-2.80.

H: 3.

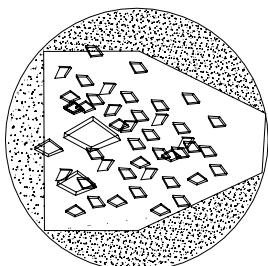
Optics;  $\omega$ : 1.658-1.740,  $\epsilon$ : 1.487-1.550.

Birefringence: 0.171-0.190.  $\ominus$ .

Dispersion: strong.

Sources are widespread.

**calcite as inclusions;** calcite can be found in rubies,



*typical calcite crystals in emerald*

sapphires, emeralds, chrysoberyls, etc.

**calcite eye;** same as bird's-eye.

**calcite occurrence;** occurring as crystals in various forms, crystalline dripstone, in stalactitic, and stalagmitic forms, in caverns, in geodes, as a replacement for fossils animals and plants, in limestone and marble.

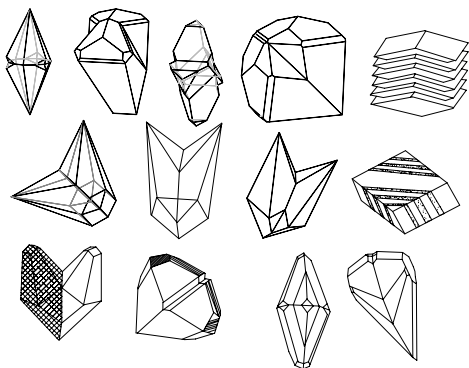
**calcite luminescence;** generally calcite from many localities shows luminescence. Under SWUV: red, orange, shades of green and blue, pink, yellow, lemon yellow and white. Under LWUV: orange, yellow, pink, blue, gray and tan.

**calcite onyx;** massive-banded calcite, is used for ornamental objects, such as bookends, desk stands, etc. Also called onyx calcite. → Cave onyx.

**calcite satin spar;** less correct term for a fibrous crystal variety of calcite.

**calcite, serpentinous;** same as verde antique, or Connemara marble.

**calcite, twins;** some different twins of calcite are seen in



*calcite twins*

figures below.

**calcium;** a silvery-white, soft metallic element of common alkaline-earth group. It is in combined in

certain minerals and rocks, especially as carbonate, sulfate, phosphate, or silicates. Chemical symbol of calcium is Ca.

**calcium carbonate;** a white or colorless powder,  $\text{CaCO}_3$  is soluble in water. It occurs as chalk, calcite, limestone, travertine, marble, aragonite, and vaterite. Used in a white paint, lime, and for polishing.

**calcium feldspar;** plagioclase feldspar, containing the anorthite molecule.

**calcium glass;** synonym for crown glass.

**calcium titanate;** a synthetic product  $\text{CaTiO}_3$  or perovskite, marketed as a *new gemstone*.

**calcium-aluminum garnet;** same as grossularite.

**calcium-aluminum silicate;** known as calumite, it is used to make synthetic amber and green glass.

**calcium-chromium garnet;** same as uvarovite.

**calcium feldspar;** same as anorthite.

**calcium-iron garnet;** synonym for andradite.

**calcium mica;** → margarite.

**calcium oxide;** → lime.

**calcium phosphate;** → apatite.

**calcium-zirconium garnet;** same as kimzeyite.

**calcomalachite;** an intimate mixture or the intergrowth of calcite and malachite, occasionally with gypsum. Used as ornamental stone.

**calcouranite;** → autunite.

**calcrete;** cementation of surficial gravels, sand and occasionally diamonds, by calcium carbonates.

**calcspar;** → calcite.

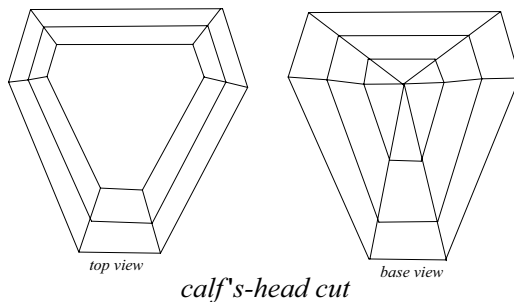
**calcsparite;** same as sparry calcite.

**calculation of the price of gemstones;** the price of a single gemstone is calculated by its weighed in carats multiplied by a base price. For example, to find the price of a zircon weighing 5.85 cts, when zircon is \$ 10.50 per carat, we multiply. The result is \$ 61.425. → Base price of pearl, base system of calculation for pearls, base price.

**calderite;** a variety of manganese garnet  $\text{Mn}_3\text{Fe}_2(\text{SiO}_4)_3$ . → Garnet.

**calderite-blythite;** a mixture of calderite and blythite garnet was reported from Chargaon, Pradesh, India. → Garnet.

**calderite-spessartite;** a mixture of spessartite garnet



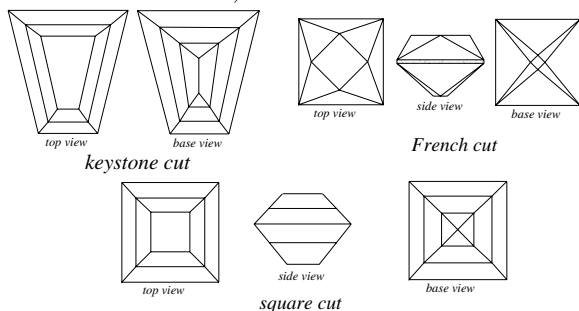
75% and calderite 18%, 5.9% andradite and 0.5% almandine. → Garnet.

**calf's head cut;** a fancy, hexagonal step-cut, resembling a calf's head in outline.

**Calecut;** an old spelling for Calcutta, India.

**calibrated stones;** usually, stones cut exactly according to specifications, for special purposes.

**calibr  cut;** a style of cutting used for very small gemstones, (mostly colored) is known as *calibre* or *m l e*. used for stones which range in diameter from one millimeter or less, to several millimeters. The term



*three different kinds of calibr -cut*

applies to a special rectangular trap cut with sharp square, angular, corners, often oblong or elliptical. These small stones are used for *eternity* rings, or in *fancy* shapes and as *pav * in lines or masses, to improve the design or enhance the color and beauty of a jewel. Also called caliber. → Calibr  stones.

**calibr  stones;** small step-cut stones, usually have a special form such as square, keystone, or rectangular in outline. They are cut to special sizes. → Calibr  cut.

**California;** a source of small, scattered diamonds and other gemstones, and gold-bearing placers, since 1849 in the USA.

**California cat's-eye;** a misleading term for a compact, fibrous variety of serpentine, with as indistinct light line or chatoyant effect. Occasionally a fine quality cat's-eye is found in California, USA.

**California hyacinth;** a misleading term for hessonite, from California, USA.

**Californian iris;** a misleading and fanciful term for kunzite, a variety of spodumene, from California, USA.

**Californian jade;** a misleading term for californite, a compact variety of vesuvianite, (idocrase), used as an ornamental stone. Found in California, USA.

**California lapis;** a misleading term, for the mixture of blue dumortierite and quartz.

**California moonstone;** a misleading term for white, or whitish-blue chalcedony pebbles, from California, USA. → Chalcedony moonstone.

**California morganite;** a morganite of fine color, often of salmon pink color, from California, USA.

**California onyx;** a misleading term for a dark, amber-

colored or brown, banded variety of calcite and aragonite. Also called *Mexican onyx*. Used as a cut stone.

**California pearl;** a term used for La Paz pearl, from Baja California, USA and Mexico.

**California ruby;** a misleading term for red garnet.

**California tiger-eye;** a misleading term for chatoyant bastite. → California cat's-eye.

**California topaz;** usually fine grade, pale blue to colorless topaz, from Mesa Grande, a district of Southern California, USA and Romania.

**California turquoise;** a misnomer for variscite.

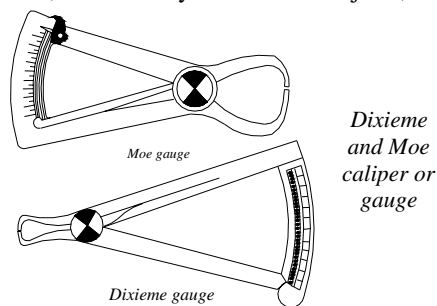
**California turquoise;** any turquoise, from California, or any other southwestern state of the USA.

**californite;** a massive, translucent to opaque, green-yellow to dark-green variety of vesuvianite or idocrase. Closely resembling jade, it is used as a substitute for poor-quality jade. RI:1.72. SG:3.25.-3.35. Sources are Fresno, Siskiyou, and Tulare counties in California and in Pakistan. Erroneously named American jade and California jade.

**californite;** a compact, white variety of grossular or hydrogrossularite garnet used as an ornamental stone from Fresno, Siskiyou, and Tulare Counties, California, USA.

**californium;** a synthetic, radioactive element with the symbol Cf.

**caliper;** a mechanical device used to measure the precise dimensions of an object, or the distance between two surfaces, (culet and table), and the diameter of a gemstone, etc. Usually with movable jaws, which hold or



*Dixieme and Moe caliper or gauge*

contact the objects to be acted upon. The accurate tool to measure small units is called a micrometer caliper or micrometer. A referring table, with a gauge, measures at the weight of a diamond or gemstone. Sometimes spelled calliper. Also called caliper gauge. The Leveridge dial gauge is a more refined version of the caliper gauge. → Stencil gauge, Moe gauge.

**caliper gauge;** same as caliper.

**callaica;** an ancient name, used by Pliny for a green or greenish-blue stone, probably turquoise. This name is still sometimes used for turquoise. Also called callaina, callaite, callais, calaite, kallainite, and callainite.



**callaina**; → callaica.

**callinite**; very rare massive mineral of wax-like, translucent, apple-green to emerald-green aluminum phosphate, probably a mixture of wavellites and turquoise, from Brittany, NW France. Also spelled kallinite. → Callaica.

**callais**; → callaica.

**callaite**; → callaica.

**calliard**; same as galliard.

**calliper**; same as caliper.

**calls**; → diadochus.

**calmazul**; synonym for chrysocarmen.

**Calonda**; location of a kimberlitic diamond pipe, with the associated alluvial deposits, in northeastern Angola, Africa.

**calorescence**; a term, which applies to the phenomena of glowing, when a mineral is exposed to heat or to certain rays, which lie beyond the red and visible spectrum, or infrared ray. → Thermoluminescence and luminescence.

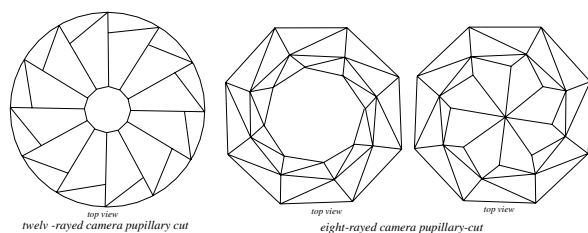
**calyon**; a local term used for a variety of pebble from Sussex, England.

**camafeo**; Spanish term for cameo.

**Camafuca Camazomba Pipe**; location of a kimberlitic diamond pipe, on the Chicapa River in northeastern Angola, Africa.

**Camagico**; location of a kimberlitic diamond pipe in northeastern Angola, Africa.

**Camera twelve-rayed papillary cut**; two different modified round brilliant-cuts similar to papillary of



two different camera papillary-cuts

camera with 8 or 12 facets and a round or eight sided table on crown.

**Camatchia**; location of a kimberlitic diamond pipe near Chicapa River in northeastern Angola, Africa.

**Camatué Pipe**; location of a kimberlitic diamond pipe near the Luachimo River in northeastern Angola, Africa.

**Cambay stone**; a term applied to carnelian from Cambay, India.

**Cambrian**; the oldest system of rocks on the earth's surface, in which lie fossils, which can be used for dating and making correlations. The rocks came into

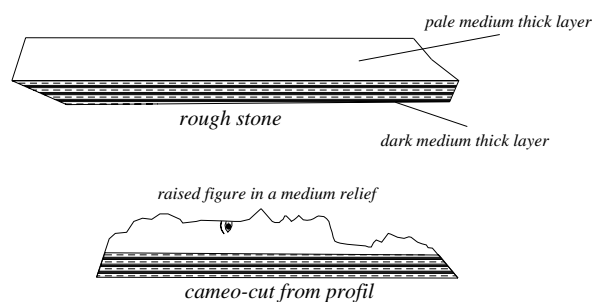
existence during the Cambrian period, 530 to 500 million years ago, in the first part of the Paleozoic era.

**Cambodia gemstones**; generally, any gem from Cambodia.

**Cambridge Diamond**; the pear-shaped diamond of 20 cts, which once belonged to Catherine the Great of Russia. It was named after Lady May Cambridge. Present location unknown.

**Camchia Pipe**; location of a kimberlite diamond pipe in Lunda district Angola, Africa.

**cameo**; a translucent layered gemstone generally composed of two layers, (or more), and colors. The top layer has a raised figure or a design carved on it, while the layer of the second layer with other color forms a background. Stones with nearly flat bands, such as



engraving of cameo from layered stone

agate, onyx, sardonyx, opal, shells, jet, rock crystal, giant conch, helmet shell, etc. are suitable materials. The image is created by carving away material that is, grinding away cavities below the surface of the gem, which is a process known as *intaglio*. Often used for carved symbols mainly as a seal. In both, (cameo and intaglio), the layered mineral has two distinctly different color layers. Dyed cameos are known, made from onyx or sardonyx. Cameos can be molded from substitute materials, such as porcelain, glass, lava, wedgwood, plastics, etc. When two or more pieces of natural stone are cemented together, the piece is known as an *assembled cameo*, and when, it is not made of natural material, it is called an *assembled imitation cameo*. → Shell cameo, stone cameo, coral cameo assembled cameo, imitation cameo, synthetic stone cameo, molded cameo pressed cameo, genuine cameo, etc.

**cameo**; carving or molding in relief.

**cameos and intaglios**; transparent to opaque gemstones may be carved in the shape of flowers, leaves or into a stylized design. The carved portion cameos is raised, above the surface. Intaglios are incised carvings primarily used for as seals. In both, a layered mineral of two distinct colors is used. → Cameo.

**cameo conch**; same as conch pearls.

**cameo doublet;** a doublet, in which the top may be molded or made of carved glass, or porcelain, (or sometimes real stone), and the bottom layer made is chalcedony and only cemented on as a base. Usually made of two pieces of glass, reddish-brown cement is used that joins the two pieces together. This cement produces the carnelian color. Intaglio doublets are common, and be dated back to Roman times, and before.

**cameo habillé;** a type of cameo with a carved bust or head, used as a pendant, earrings, etc.

**cameo men;** same as furniture men.

**cameo, shell;** same as shell cameo.

**cameo ware;** in fine pottery, dull jasper ware, with applied decoration of classical motifs, resembles a cameo.

**Cameroon;** a source for gemstones, in West Africa.

**campan mélange marble;** a misleading term for pale, yellowish-green, gray-green to dark green or a dark-red variety of marble with a green and, dark red, banded matrix. Also called campan rouge.

**campan rouge;** same as campan marble.

**Campeche pearl;** pearl from the Gulf of Campeche. Also called Venezuela pearl.

**camphor jade;** a variety of white jadeite, similar to crystallized camphor in appearance.

**camptonite;** a lamprophyre, similar in composition to diorite, having plagioclase (usually labradorite), brown sodic hornblende, pyroxene, and olivine found in Compton, New Hampshire, USA. Suitable for cladding stone.

**camstone;** a compact, bluish-white limestone with clay, used for whitening hearths and doorsteps.

**Canada balsam;** a yellowish, transparent resin, with a pine-like odor, obtained from a species of fir-tree, *Abies balsamica*. Because its refractive index is similar to that of glass, it is used as an adhesive in optical devices i.e. for cementing separate bifocal lenses and as a mounting medium for microscope specimens. Soluble in ether, chloroform, and benzene. RI:1.53. Used in the Nicol polarizing prism to reject ordinary rays, (RI:1.658), because the rays are totally reflected by the balsam layer, while extraordinary ray (RI:1.486) is able to pass through the prism. Synonym for balsam of fir, Canada turpentine.

**Canadian amber;** same as chemawinitite or cedarite.

**Canadian asbestos;** same as chrysotile.

**Canadian blue stone;** a commercial, misleading term for sodalite, from Canada. Also called Princess blue or bluestone. Used for inlay.

**Canada diamond;** some diamonds of mineralogical interest have been found in Manitoba, Ottawa, Quebec, and Ontario, Canada.

**Canadian Gemmological Association;** Headquarters for the Society is located at: Box 1106, Station Q, Toronto, Ontario, M4T 2P2, Toronto, Ontario, Canada. Abbreviation: CGA.

**Canadian jade;** a nephrite, from British Columbia, Canada.

**Canadian jet;** a jet from Pictou, Nova Scotia. Softer than Whitby jet.

**Canadian Jeweller's Association;** the Canadian Jeweller's Association, which includes retailers, wholesalers and manufacturers. It was organized in 1918. Headquarters for the Society is located at: 800 Bay street, Toronto, Ontario, Canada.

**Canada moonstone;** a peristerite variety of albite feldspar, like moonstone, from Canada.

**Canada turpentine;** same as Canada balsam.

**canary;** same as canary diamond.

**canary beryl;** the light greenish-yellow variety of beryl.

**Canary Diamond;** same as Tiffany Diamond.

**canary diamond;** a commercial term for the fancy, intensely yellow-colored Type Ib diamond due to the presence of nitrogen atoms.

**canary glass;** a yellow glass colored by uranium oxide, which exhibits a brilliant yellow-green fluorescence under UV light. It has absorption spectrum bands in the blue-violet range at 495, 460, and 430 nm. Used as an imitation gemstone. Also called uranium glass.

**canary stone;** a canary yellow variety of carnelian.

**canasite;** a greenish-yellow silicate. Used as Gem.

System: monoclinic.

Formula:  $2[(\text{Na},\text{K})_5\text{Ca}_4(\text{Si}_{10}\text{O}_{25})_6(\text{OH},\text{F})_3]$ .

Luster: vitreous.

Colors: greenish-yellow.

Streak: colorless.

Diaphaneity: transparent to translucent.

Fracture: brittle.

SG: 2.71.

H: 5-6.

Optics;  $\alpha$ :1.534,  $\beta$ :1.538,  $\gamma$ :1.543.

Birefringence: 0.009.  $\ominus$ .

Found in pegmatites in the Khibina Tubra, Russian Federation, CIS.

**Canavieiras;** a mine, bearing diamonds of fine quality, located in Bahia, Brazil.

**cancrinite;** a rare, transparent to translucent mineral. Cut cabochon and as beads, also, sometimes faceted. It is prized by collectors. Usually associated with white feldspar and sodalite. Varieties are vishnevite, when  $\text{SO}_4 > \text{CO}_3$ , and microsommite, when chlorine-rich.

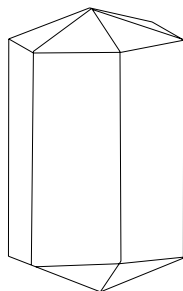
System: hexagonalic.

Formula:  $4[(\text{Na}_6,\text{Ca})_2(\text{SiAlO}_4)_6(\text{CO}_3,\text{SO}_4,\text{Cl})_2.n\text{H}_2\text{O}]$ .

Luster: vitreous, pearly or greasy.

Colors: colorless, white, yellow, orange, pink, reddish, pale blue, to

pale bluish gray.  
Streak: colorless.



*cancrinite  
crystal*

Diaphaneity: transparent to translucent.  
Cleavage: {1010} perfect, and {0001} poor.  
Fracture: uneven. Brittle.  
SG: 2.42 - 2.51.  
H: 5-6.  
Optics;  $\omega$ : 1.507-1.528,  $\epsilon$ : 1.495-1.503.  
Birefringence: 0.022.  $\ominus$  may be  $\oplus$ .  
Dispersion: weak

Found in Quebec, Russia, Norway, Zaire, India, Uganda, Korea, China, and Kenya.

**cand**; a term used in Cornwall, England for blue-john or fluorite occurring in a vein. Another spelling is cann, kann, and kand.

**Candelabra Tourmaline**; a red, white and blue rough stone of 25x23x15 cm from USA. It is a color-zoned elbaite together with albite, quartz and lepidolite.

**candlebox**; a term used by Australian miners for poor opal but not so good enough that can be offered as a gem. Normally it is stored in candlebox.

**candleholder**; a term used by Australian miners for a sharp tool in which a candle was carried for use to remove opals. Also called spider.

**candite**; blue spinel or Ceylonite (pleonaste).

**candle**; the ceramic pedestal used in a Verneuil furnace, on which boules are grown.

**candle flame**; another term for diffusion flame. → Stearic acid.

**candle quartz**; a faceted, quartz crystal, with a long, prismatic, often trap shape.

**candling pearl**; a method used to reveal the difference between natural and cultured pearls. When beam of long-wave, ultraviolet light is passed through a correctly- oriented, cultured pearl on a piece of bare film, a *stripy* pattern will be seen after the development of the film. The measurement is made using a lucidoscope, preferably in a darkened room. The pearl is rotated slowly in front of a strong light. In a cultured pearl, parallel layers of the mother-of-pearl core are seen as lines across the pearl (stripes). Candling of natural pearl shows only a decrease of light transmission from the periphery to the center.

**candy spinel**; a misleading term for Kandy spinel.

**canga**; a Brazilian term for a conglomerate layer, often covering the Brazilian diamond-bearing deposits. The rock is cemented by hematite of rubble ore and limestone.

**canhuang**; a Chinese term for yellow pigment.

**cann**; same as cand.

**cannel coal**; a dull, compact black coal (bituminous), with a waxy luster and conchoidal fracture. Sometimes used as a substitute for jet. Conchoidal fracture. Also called cannel, cannelite, parrot coal, and curly cannel. Found in Scotland and in the north of England. Also called gayet, candle coal, cannelite, and curly cannel coal. In Yorkshire called ratter. Used as jet imitation

**cannetille**; a style of jewelry in various shapes, made of coarse metal wires of gold or silver, enhanced with gemstones or enameled.

**Canning Siren Jewels**; the pendant, made of enameled gold, set with gemstones in the form of a siren, in which the trunk of a human, or torso of the siren is a baroque pearl.

**Canning Triton Jewels**; the pendant, made of enameled gold, and set with diamonds and rubies, in which the trunk of a human, or torso is a baroque pearl.

**canoas**; same as fervidor.

**Cañon**; a spanish term for canyon.

**Cañon Diablo meteorite**; another spelling for Canyon Diablo meteorite.

**cant**; a local term used by Whitby jet worker in England for facets.

**Canteen Kopje**: → Klipdrift.

**cantharides**; an iridescence light vivid green insect, with the color similar to a kind emerald. Also known as la mouche Cantharides. Zobabi is an Arabic name for this insect, which were used in classification of emerald colors. Also in Arabic spelled zubabi, zabab.

**canting**; a local term used by Whitby jet worker in England for faceting.

**Canton jade**; any jadeite or nephrite from Canton, China.

**canutillos**; a Colombian term used by miners for fine-quality emerald crystals. → Moralla.

**canyon**; a deep, narrow, steep-sided valley.

**Canyon Diablo meteorite**; minute, polycrystalline cubes and cubo-octahedral diamonds is found in 1893 when a meteorite struck the earth at the Diablo canyon, Arizona, USA. They were formed by the heat and shock of impacts. Also spelled Cañon Diablo meteorite.

**capangueiros**; Brazilian word for a traveler who buys diamonds.

**cap cut**; a fashioned stone, with irregular and haphazard facets. → Bastard cut.

**Cape**; term for the color grading of a rough or polished,

Type Ia diamond, having a distinctive yellowish tinge or bodycolor. The best grades stone in the cape group are called: top silver cape, top cape, light cape, fine cape, fine silver cape, or silver cape. Also called cape mineral, capish, cape stone, cape diamond.

**Cape;** a color scale, for faint-yellow to light-yellow diamonds, over 0.47 cts, used by Scan. D.N., which corresponds to M-Z on the GIA color-grading scale.

**Cape;** any gemstones from the Cape of Good Hope, South Africa.

**Cape;** sometimes, a misnomer such as Cape ruby for pyrope, cape emerald for prehnite, cape chrysolite for prehnite.

**cape and yellow spotted;** an obsolete grading term, used by diggers to mean of imperfect quality as when crystals are spotted and yellow.

**Cape ballas;** same as ballas, or industrial diamonds, from South Africa.

**Cape blue;** crocidolite asbestos from South Africa.

**Cape chrysolite;** a misleading term for green prehnite from South Africa. Also misnomerly known as Cape emerald.

**Cape Colony;** same as Cape Province.

**Cape Diamond;** the canary-yellow diamond of 297 cts, found in the Dutoitspan Mine, South Africa. Belonged to CSO and displayed at its London headquarters. → Cape.

**Cape diamond;** a grading term for a diamond having a yellowish tinge. → Cape.

**Cape emerald;** a misleading term for prehnite, from South Africa.

**Cape garnet;** a local term applied to pyrope garnet from South Africa.

**cape lines;** natural white, to deep-yellow colored diamonds showing two characteristic bands in the spectrum, when examined with a spectroscope at 415.5 and 478 nm, with some weaker lines between these two. Also called cape spectrum, cape series.

**Cape May diamond;** a misleading term for the colorless, clear quartz crystal from Cape May, New Jersey, USA.

**Cape mineral;** → Cape.

**Cape province;** a diamond-bearing province in the northeast and central east part of South Africa. Also called the Province of the Cape of Good Hope.

**Cape ruby;** a misleading term for the fiery, ruby-colored pyrope garnet, found in association with diamond in kimberlite, and eclogite in South Africa. Similar name as *Adelaide ruby*. → Fashoda-ruby, false ruby.

**Cape series diamonds;** the term applied to diamonds which exhibit the characteristic color range, from top white to deep yellow stones just above the fancy-color

range, or those that between 415.5 and 478 nm on the absorption spectrum. → Cape stones, cape lines, cape spectrum.

**cape spectrum;** same as cape lines.

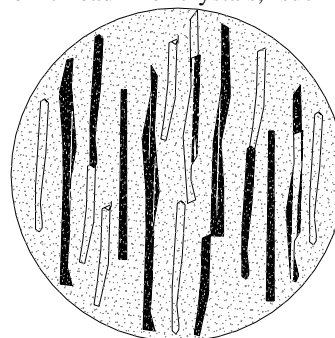
**Cape stones;** a color classification for any distinctly yellow diamonds, sub-divided into: fine silver cape, silver cape, light cape, cape, dark cape. This group is classified next, in quality, after blue-whites and whites. In the CIBJO grading system, white, slightly tinted white, tinted white, tinted color. → Cape series.

**Cape stones;** a term for any diamonds from Cape Province, South Africa.

**Cape Town;** a seaport in South Africa and one of the first rough diamond marketing centers.

**Cape white;** → Cape.

**capillary;** a mineral or gemstone, exhibiting fine, hair-like or thread-like crystals, such as millerite. Also



*capillary inclusion in aquamarine from Malagasy*

called filiform, moss, wire, hair-like, thread-like and wiry.

**capillary;** same as tube.

**capillary pyrite;** refers to the crystal millerite, which has slender, hair-like crystals.

**capish;** diamonds that face up yellow. → Cape.

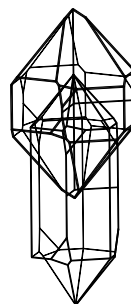
**capillite;** → rhodochrosite.

**cap jewel;** same as end stone.

**Caplan Emerald;** an Arabic engraved emerald of fine quality of 217.80 cts. Belong to Allan Caplan Collection, New York City, USA.

**cappe;** a Dutch name for octahedral-shaped crystal, or the cleavage of diamond.

**capped quartz;** a term used to a variety of quartz,



*capped-quartz phantom*

containing separate thin layers of clay at intervals in the

growth of crystal which resembled repeated caps, found in New South Wales, Australia. Also spelled cap-quartz.

**capping;** near surface, an iron bearing. weathered product overlying a sulfide deposit. Occurring by the oxidation of sulfides and leaching out of the sulfides and metals, leaving hydrated iron oxide. Useful in mineral exploration. Also called iron hat, gossan, gozzan, chapeau de fer, capping of gossan, ore capping, ironstone blow.

**capping of gossan;** same as capping.

**cap-quartz;** same as capped quartz.

**capra gem;** a commercial term for a synthetic, rutile diamond imitation.

**capstone;** in masonry, the uppermost or finishing stone of a structure.

**capture;** a term used in a crystal lattice for replacing or substitution of a common or trace element of lower valence such as  $Ba^{++}$  for  $K^+$  or  $Pb^{++}$  for  $K^+$ , etc.

**caput mortuum;** iron oxide, used as polishing powder.

**caracoly;** a metallic alloy composed of gold, silver, and copper, used by Caribbean Indians as ornaments.

**carapace;** the upper side of tortoise shell.

**Carapidae;** → pearl fish.

**carat;** a unit employed in weighing diamonds, pearls, and other gemstones, which formerly ranged from 185.5 to 205.3 milligrams. Now the International metric carat is equal to 0.2 gram, or 200 milligrams and this is the standard in a majority of countries. Abbreviation: c. The unit carat since April first 1914 was standardized worldwide as the *metric carat*. The term carat is derived from the seed of the *Carob tree* or *Ceratonia siliqua*. Also known as the locust tree in the Middle East. The dried seeds are very uniform in weight and were used by ancient pearl merchants as units of weight. Less uniform in weight is the seed of an orange, kidney-shaped with a black spot at one end, which was obtained from the so-called *Coral tree* or *Erythrina corallodendron*. The carat is divided into 4 grains. Not to be confused with *Karat*. → Carat weight, Grain.

**carat;** a unit that refers only the purity of solid gold and to gold alloy, used in jewelry. To avoid confusion, the term for measuring the purity of solid gold and gold alloy is spelled *karat*.

**carat count;** the number of near-equal-size diamonds having a total weight of 1 ct., are grouped, such as 8-count or 40-count pieces of diamond.

**carat goods;** parcels of diamonds, averaging about 1 ct, each in weight.

**carat grain;** same as grain.

**carat loss;** the amount of diamond material lost or worn away by drill.

**carat, old;** → old carat.

**carat weight;** the standard unit of weight for diamonds, pearls, and other gems. It is defined as 0.2 gram, or 200 milligrams. One carat is equal to 4 grains. Synonym for caratage. → Carat, grain.

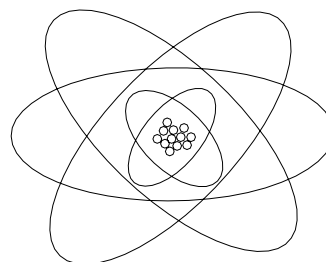
**caratage;** same as carat weight.

**carato;** Italian spelling for carat.

**carbide of silicon;** same as carborundum, carbon silicide, or silicon carbide.

**carbinol;** same as methyl alcohol.

**carbon;** an amorphous, nonmetallic element with the



*carbon-12 structure and surrounding negative electrons orbitals the nucleous*

symbol C. It occurs in crystalline form as graphite, and diamond.

**carbonaceous;** a sediment rock having a high carbon content.

**carbonaceous;** a sediment rock, the composition of which is chemically organic.

**carbonado;** an opaque, massive, cryptocrystalline, dark brown, black, and gray variety of minute diamond found in Bahia, Brazil. SG:2.9-3.5. Highly prized in diamond for its hardness, as an abrasive, for cutting purposes and as industrial diamond. Also called, carbon, black diamond and misleadingly, *carbonate* in the trade. → Abrasive material.

**Carbonado Casco do Burro Diamond;** a piece of carbonado of 2000 cts, was found in Municipio de Lençóis, Brazil.

**Carbonado do Sergio Diamond;** the largest carbonado, weighing 3167 cts, was found in 1905 at Municipio de Lençóis, Brazil.

**Carbonado Pontesinha Diamond;** the 267.53 cts, carbonado found, in the district of Rosario, in southwest Brazil. First reported in 1938.

**Carbonado Xique-Xique Diamond;** the 931.60 cts, carbonado, was found in 1905 at Andaraí Lavars, Bahia, Brazil. Also spelled Chique-Chique Diamond.

**carbon amber glass;** a synthetic dark or black glass is colored by  $Fe^{2+}$  —  $Fe^{3+}$  charge transfer. Also called beer glass, black glass.

**carbon amber glass;** → beer-bottle glass.

**carbon condition in relation to high pressures and temperatures;** → diamond.

**carbonate;** a misleading, commercial term for carbonado.

**carbonate;** a chemical composition consisting of acid radical of carbonic acid  $\text{CO}_3^{2-}$ .

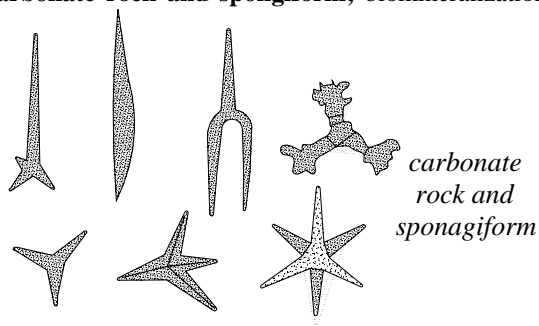
**carbonate;** any carbonate rock such as limestone, dolomite, magnesite, etc.

**carbonate-apatite;** → francolite.

**carbonate color center in beryl;** in some beryl some color centers or structure defects where an atom is missing, now the free electron vibrate and absorbed certain wavelength of light where the remaining wavelength reach the eye with peculiar color. Such color center in beryl caused by irradiating or destroyed by light, which found by Anderson caused by impurity ions such impurity lost one electron by irradiation to caused carbonate  $\text{CO}_3$  centers in beryl. In Maxixe-type  $\text{No}_2$  color center are found.

**carbonate of manganese;** another term for mineral rhodochrosite.

**carbonate rock and spongiform;** biomineralization or



biological rocks consisting of remaining of marine organic substances. → Biomineralization.

**carbon bearing;** of, or pertaining to, carboniferous.

**carbon dating;** same as radiocarbon dating.

**carbon diamond;** same as boort.

**carbon dioxide bands in infra-red spectrum;** in the spectrum of some emeralds which are green due to chromium and iron, can be seen bands near infrared, which are caused by the molecular vibration of water and carbon dioxide.

**carbon dioxide test;** same as dry ice test.

**carbon disulfide;** a liquid form of  $\text{CS}_2$ . RI:1.63. Used as an immersion medium in microscopy.

**carbon-14 dating;** same as radiocarbon dating.

**$\text{C}^{14}$  method;** same as radiocarbon dating.

**carboniferous;** a rock system on the earth's surface which divided into upper and lower parts, (345-280 million years ago), during the Paleozoic era. Also called coal age, age of coal.

**carboniferous;** synonym of, or pertaining to, carbon bearing.

**carboniferous sandstone;** sandstone rock containing

limestone.

**carbon mineral;** any mineral with the composition of C, including coal, graphite, anthracite, diamond, peats, asphalts, and bituminous coals.

**carbon oxide laser;** → laser.

**carbon pinpoints;** a promotion term denoting small carbon specks in diamond.

**carbons;** a black inclusion in diamond, is known as a carbon spot.

**carbons;** a misleading commercial term for carbonado. → Carbon spot.

**carbon silicide;** → silicon carbide.

**carbon spot;** many minute dark included crystals in diamonds are written off as *carbon spots*, because their of total reflection of light, which causes them to appear nearly black. Also called carbon pinpoints.

**carbon spot;** a black fleck or flake of carbon, (non-diamond), included in a diamond crystal. → Carbon.

**carbon steel;** steel, containing high carbon is used as a cutting tool.

**carbon temperature/pressure phases;** → diamond.

**carbon tetrachloride;** the colorless, volatile liquid,  $\text{CCl}_4$ , has a strong, pungent odor, and is nonflammable. Used as a grease solvent, cleaning agent and in microscopy, as an immersion liquid for gemology and mineralogy. RI:1.44. SG:1.59. Soluble in alcohol, not soluble in water. Also called carbonyl. Avoid smoking highly flammable.

**carbonetto;** an Italian coral classification, meaning a grade of very dark red coral. Also called arciscuro.

**carbonizing;** → black opal, black dyed opal, opal dying.

**carbonyl;** a trade term for carbon tetrachloride.

**carborundum;** a commercial term for colorless or bluish-green to black, often iridescent, artificial  $\text{SiC}$ . Insoluble in water and alcohol. Used for grinding and to abrade colored gemstones, other than diamond. Hexagonal system. Transparent. Optics;  $\omega$ :2.65,  $\epsilon$ :2.69. Birefringence: 0.043.  $\oplus$ . Dispersion: 0.80 twice that of diamond. SG:3.17. H:9-9½. Manufactured by fusing a mixture of carbon and quartz sand, or silica in an electric furnace. Some of the larger crystals have been faceted. Naturally, counterpart is moissanite. Also called silicon carbide.

**carbuncle;** an old popular collective term (in Latin carbunculus) for any of several red precious stones of a fiery-red or scarlet-like color such as ruby, spinel (ballas ruby), garnet, red tourmaline, amber (carbo amber), and may red glasses. A term used during the Victorian era. → Anthrakion, Garamantic, flower of jove, anthrax.

**carbuncle;** a now obsolete name, for any precious stone of a fiery-red or scarlet-like color, such as almandine garnet, ruby or spinel, used during the Victorian era.

**carbuncle**; a term applied to en cabochon-cut, deep-red almandine garnets.

**carbuncle**; a term used by Thomas Nicols synonym for pyrope garnet.

**carbuncle**; fourth stone at Jewish High Priest Breastplate. Also same as bareketh.

**carbunculus**; a Latin term applied to red-colored gems such as ruby, almandine, ruby spinel, tourmaline, and pyrope.

**carcanet**; an obsolete term for a gold ornamental necklace or chain usually enameled, and possibly set with gemstones.

**carchariarum,-Pinctada**; a kind of pearl-bearing oyster fished of shark Bay, Australia, the pearl is yellow.

**Carchedonia**; an equivalent Latin term for Carthage.

**Cardinal Mazarin**; Jules Mazarin, (1602-1661), was a cardinal, statesman and prime minister, under Louis XIV. He possessed a magnificent collection of diamonds, which he bequeathed to the French Crown.

**cardiometer (pearl)**; an important special stage-support for testing pearls under the microscope, which is similar to petrographic stage and can raise or fall the width of a very thin needle. It has a mirror-like surface at a 45°. The polished needle is introduced into the string hole of the pearl. It is used to distinguish between natural pearls and cultured pearls, as it allows the concentric layer structure of a natural pearl or the bead nucleus of a cultured pearl to be seen.

**care and preservation of pearls**; → pearl, care and preservation of.

**care of amber**; same as amber,-care.

**care of pearl**; → pearl,-care of.

**Caria**; an ancient source for carbuncles garnet in Asia Minor.

**caribou hooves**; an important material used in jewelry making by Eskimos. The hooves of caribou, have similar qualities to tortoise-shell and take a high polish.

**carinthine**; → hornblende.

**Corinthian-marble**; a variety of marble quarry in Corinthian, Austria.

**Cariué Pipe**; location of kimberlite-diamond pipe, near Luachimo River, Angola, Africa.

**carletonite**; a rare mineral rarely cut as gems.

System: tetragonalic.

Formula:  $4[\text{KNa}_4\text{Ca}_4\text{Si}_8\text{O}_{18}(\text{F},\text{OH})\cdot\text{H}_2\text{O}]$ .

Luster: vitreous to pearly. After exposure waxy.

Color: colorless, pale blue to pink

Streak: colorless.

Diaphaneity: transparent to translucent.

Cleavage: {001} perfect, and {110} distincts.

Fracture: conchoidal to uneven.

SG: 2.44-2.45.

H: 4-4½.

Optics;  $\omega$ :1.521,  $\epsilon$ :1.517.

Birefringence: 0.004.  $\ominus$ .

Dispersion: 0.014.

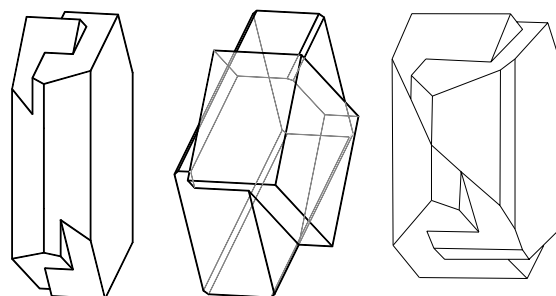
Found in at Mont St. Hillarie, Quebec, Canada.

**Carlotta Diamond**; the fancy, light-pink colored, pear-shaped diamond of 40.30 cts, from Lesotho, Southern Africa. Named after Lazare Kaplan's wife, Carlotte.

**Carlotta of Belgium Diamond**; same as Maximilian Diamond.

**Carlsbad twin**; same as Carlsbad twin law.

**Carlsbad twin law**; a twin law, which exhibits the



*feldspar Carlsbad twin*

triclinic and monoclinic systems in feldspar, especially orthoclase feldspar, which has a parallel twin, where the twin axis is the *c* crystallographic axis. Alternately spelled Karlsbad twin law.

**carmen red**; a term used in Finland for Rapakivi granite, suitable for cladding stone. Also called baltic red.

**carmen red**; same carminite.

**carminite**; a carmine-red mineral of  $\text{KMgCl}_3\cdot 6\text{H}_2\text{O}$ .

**Carmo do Paraneiba Diamond**; the brown diamond of 245 cts, found in 1937, in Minas-Gerais, Brazil. Present location unknown.

**Carnaiba beryl**; a rather pale, emerald-colored beryl, from the Carnaiba mine, Brazil.

**carnat**; rock, miner, or gem with red color.

**Carnegie Gem**; a commercial term for a doublet a with a synthetic spinel top and a strontium titanate base. Used as a diamond imitation.

**carnelian**; a translucent, uniformly, colored, blood-red, flesh-red, reddish-white, orange-red, reddish-yellow, or brownish-red variety of chalcedony, containing iron-oxide impurities. Sometimes carnelian's color is improved by heating. Flecks of matrix are sprinkled in some stones. Used for carving intaglio as seals, as beads or as ornamental stones. Found in Egypt, Brazil, India, and Uruguay. Also spelled as cornelian, kornelian, and carneol.

**carnelian**; the commercial term *sard* is used for a translucent, uniformly-colored, light brown to dark

reddish-brown chalcedony, and *sardonyx*, a sard with white bands is another variety of carnelian. Also spelled kornelian.

**carnelian agate**; a variety of banded agate, similar to carnelian onyx in coloring, sometimes with attractive with neither/nor parallel, bands of white.

**carnelian onyx**; onyx, with alternating bands of white chalcedony and colored carnelian.

**carneol**; an obsolete trade term for carnelian, or pink-dyed chalcedony.

**carneol beryll**; an old misleading term for carnelian.

**Carnot**; a diamond deposit in West Oubangui, in the Central African Republic.

**Carns Diamond**; a macle diamond weighing 107 cts, found in 1891, in South Africa. Whereabouts unknown.

**carob**; the seed of the carob tree, (*Ceratonia siliqua*), originally was used as a standard carat weight. → Carat, carat weight.

**Caroní River**; location of important alluvial diamond deposits on the upper part of the river in Venezuela, South America.

**carotenoids**; a class of noncyclic colorants or pigments occurring in the carrots, vegetables, tissues of higher plants, algae, bacteria, and fungi. Also obtained from shark liver oil. It contain  $\beta$ -carotene which is used as dye in different industry branches. → Polyene.

**Carrara diamond**; a misleading term for quartz crystal, from the famous quarries of statuary marble, Carrara, Tuscany, Italy.

**Carrara-marble**; a general term for all fine marbles quarry of statuary marble near Carrara, Tuscany, Italy. Formed by contact metamorphism from ordinary limestone. The colors are white to bluish, or white with bluish veins. Also used as tiles.

**carrée**; French term for a square, trap-cut stone.

**carrée**; any minute, square cut diamond.

**carst**; caves, sinkholes and underground drainage. Also spelled karst.

**cartesian coordination**; an old term used to describe the faces of crystal and their relationships to each other, which consists of three imaginary lines or axes that intersecting each other at a common point. Also called crystal axes.

**Cartier Diamond (New York)**; the pear-shaped diamond of 107.70 cts, from South Africa. Also called Cartier-Taylor - Burton Diamond or Cartier - Taylor - Burton Diamond.

**Cartier-Kenmore Diamond**; the Indian, canary-colored, cushion-cut diamond of 38.31 cts, acquired by Rosemarie Kenmore, wife of Cartier in 1971. It was later sold to an undisclosed buyer.

**Cartier-Taylor-Burton Diamond**; this internally flawless, pear-shaped diamond of 69.42 cts. This was

cut from a 240.80 cts, rough diamond. Found in 1966 at the Premier Mine in South Africa. Purchased by Richard Burton for his wife, Elizabeth Taylor, in 1969. Repolished to 68.09 cts, in 1969. Sold in 1980. Whereabouts unknown. Also called Taylor-Burton Diamond.

**cartouche**; a symmetrically carved, ornamental framework used in decoration sometimes having an inscription or pictorial subjects.

**cartouche**; a variegated agate or jasper beach pebble from Santa Catalina Island, Gulf of California, Mexico, used as gem.

**carumbé**; a wooden vat, used in Brazil to carry away waste material from their claims.

**Carthaginian carbuncles**; Pliny described that garnet carbuncles stones from Carthage are purple in shadow and flame-red in transmitted daylight.

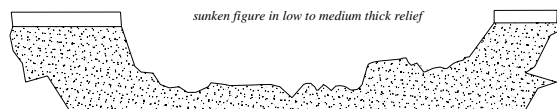
**carved**; to cut, to chip in order to form something. To decorate or form by cutting or chipping such as a statue.

**carved beryl**; carved beryl from Ancient Times and later are very rarely seen because no enormous stones were found until emeralds from Colombia were available in the 16<sup>th</sup> century. Some carved stones are from Middle Ages reported such as Scepter of Harunal-Rashid (746-809 A.D.), which was carved from a single piece of emerald and was capped with a carved ruby bird. The whereabouts of this scepter is unknown. Now beryl is carved with diamond, silicon carbide powder for shaping on wheel or loose grits are used for sanding to polishing. Also the same method for making cabochons. → Carving.

**carved gem**; → carving.

**carved setting**; an old type of closed setting for a gem. Used in finger rings, this setting is similar to the pavé setting, which is carved or scooped out of the metal.

**carving**; in gemology the decoration of gemstone, metal, or a figure or design, produced by carving. Patterns, etc.



carving or engraving of intaglio from layered stone

are usually engraved in translucent materials, decorating objects such as vases, statues, etc.

**cascading phosphorescence**; an interconnected effect



seen in luminescence produced by one phosphor, which is absorbed by another phosphor, in turn least one produces light and so fort.

**cascalho**; a native term used in Brazil for diamond-bearing, brown gravel and ferruginous sand. → Gorgulho.

**Cascalho River**; location of alluvial diamond-bearing deposit, in Minas Gerais, Brazil.

**casein**; a hard, white, artificial, colloidal, amorphous, sectile substance, made from the albumen of milk, by treating milk with acid or formaldehyde. Used for thermoplastic materials, occasionally as an imitation of amber, agate, malachite, ivory, tortoise-shell and other ornamental stones. RI:1.50 to 1.56. SG:1.325-1.39. H:2-2½. It changes color to yellow when a drop of concentrated nitric acid is added and is non-flammable. Under UV light fluoresces white. The commercial names for these plastics are: erinoid, lactoid, galalith, milkstone or casein plastics.

**casein plastics**; same as casein.

**Cashmere sapphire**; any sapphire from Cashmere, in northwest India, often they are somewhat milky in appearance due to numerous, extremely-fine inclusions.

**Cashmere sapphire**; a commercial grade of sapphire, applied to a velvety, cornflower blue sapphire from Cashmere. Also spelled Kashmere sapphire.

**casings**; a term used by Australian miners for bandstone.

**Ca-spar**; same as anorthite.

**Caspian stone**; an old term for Persian turquoise.

**Cassamba**; an alluvial diamond deposit in Angola, Africa.

**Cassanquide Mine**; an alluvial diamond deposit in Angola, Africa.

**cassia oil**; yellow or brown oil, obtained from the bark of cinnamon. Used as an immersion medium. RI:1.60. Also called Chinese oil.

**Cassis madagascariensis**; the shell of a species of the genus, *Cassis madagascariensis* found in the warm waters of the West Indies, are used for cameos. The white or outer layers cover colored under-layers, providing full contrast necessary for good carved cameos. Most are sent to Italy. Also called Helmet shell. → Conch, operculum.

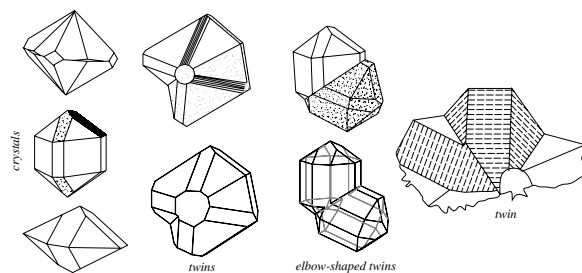
**Cassis, pearls**; a member of the salt-water family Mollusca, which frequently produces pearls of little gemological interest.

**cassiterite**; rarely fashioned, but prized by collectors, because of its high brilliancy and dispersion. Twined as geniculate twins of the second order pyramid, (101), who are also known as elbow twins or knee-shaped forms. Synonym for tin ore, tine stone, tin oxide. It has dispersion nearly twice that of diamond.

System: tetragonalic.

Formula:  $2[\text{SnO}_2]$ .

Luster: Adamantine, splendent metallic adamantine, vitreous, often



*cassiterite crystals and twins*

greasy on fracture

Colors: colorless, various brown, gray, yellowish, greenish, red, and black.

Streak: pink, pink white, grayish, brown.

Diaphaneity: transparent to opaque.

Cleavage: {100} imperfect and {110} indistincts.

Fracture: subconchoidal to uneven. Brittle.

SG: 6.8-7.1.

H: 6-7.

Optics;  $\omega$ : 2.006,  $\epsilon$ : 2.097-2.101.

Birefringence: 0.098. ⊕.

Dispersion: 0.071.

Found in Bolivia, Malaysia, Namibia, Mexico, Saxony (Germany), Australia, Spain, and Canada.

**cassiterite pleochroism**; very weak to strong, mostly visible in dark colored stones: greenish-yellow or yellow brown and red brown.

**cast**; to convert a fossil organism into an inorganic substance, which fills the original body, and therefore showing the surface features of the organism, but retaining nothing of internal structure, such as in agatized wood, silicified coral, silicified copal, encrinite. → Fossil, pseudomorphous.

**cast**; a change in color because of addition of another hue.

**cast**; change the direction in a vein.

**cast**; to make duplicate plates of all kinds.

**cast gold**; a synonym for cat gold or mica.

**casting**; the method of pouring glass, or molten metal into a hollow mold of sand, gypsum, or metal, in which it solidifies to produce a shaped-form or component. At this time mass production or centrifugal casting has replaced this method. Mostly used for duplicating famous pieces of jewelry. Also called die-casting.

**casting**; industrial diamonds that cannot be used for drilling.

**castings**; a term applied to low quality, drill diamonds.

**castle**; a natural rock formation, which has a fanciful resemblance to a castle.

**castor**; same as petalite.

**castorite**; same as petalite.

**castor oil**; a pale yellow or brown oil, obtained from the seeds of *Ricinus communis*, used as an immersion medium. RI:1.48. Sometimes mixed with diamond dust, to produce an abrasive paste, which can be used to polish diamond facets.

**castracané marble**; a misleading term for the golden variety of broccatello. → Broccatello.

**cat**; a Cornish term for a hard rock, which contains iron. Also called gat, kat.

**catagenesis**; the change of the mineral content of a rock because of outside influences such as metamorphism. Sometimes used as equivalent to epigenesis. Also spelled katagenesis.

**catalin**; a trade term for a synthetic, amorphous, phenolic plastic resin, similar to bakelite, used as an amber imitation.

**Catalina sardonyx**; a misleading term for catalinite.

**catalinite**; a variegated agate or jasper beach pebble, from Santa Catalina Island, in the Gulf of California, and Mexico, used as a gem.

**catalyst**; a substance that increases the rate of a chemical reaction, without undergoing any net change itself.

**catamorphism**; the theory of destructive process of most metamorphism in the earth were produced by the occurrence of sudden short-lived worldwide events. Also spelled katamorphism.

**catapleite**; a dimorphous mineral, with gaidonnayite. It is rarely fashioned.

System: hexagonalic.

Formula:  $2[\text{Na}_2 \text{Zr}(\text{Si}_3\text{O}_9)\cdot 2\text{H}_2\text{O}]$ .

Luster: vitreous, greasy to dull.

Colors: colorless, pale yellowish to yellowish brown, flesh-red, salmon-pink, pale blue.

Streak: colorless.

Diaphaneity: transparent.

Cleavage: {1010} perfect, {1011} imperfect, {1012} imperfect, and {0001} parting.

Fracture: splintery. Brittle.

SG: 2.65-2.80.

H: 5-6.

Optics;  $\omega$ :1.590,  $\epsilon$ :1.627.

Birefringence: 0.037. ⊕.

Found in Norway, Mont Saint Hillarie, Quebec (Canada), Malagasy, Russia, Greenland and Arkansas, the USA.

**catazone**; the deepest zone of rock metamorphism, characterized by high temperatures (500-700°) and mostly strong pressures. Also spelled katazone.

**catel**; a term used for beryl with obscure color.

**cat gold**; synonym for mica.

**cathay cat's-eye**; a commercial term for a translucent, limori glass made in Japan, which is wrongly sold as *Victoria cat's-eye*. It can be distinguished by its specific gravity, as it floats in di-iodomethane. It is manufactured in a variety of colors. Also sold as meta-jade, kinga-stone.

**cathay cat's-eye**; a commercial term for a simulated, chrysoberyl cat's-eye, produced from a relatively heavy, dense, fused mosaic of glass fibers, with a highly refractive index, these fibers run parallel and are covered or embedded in a different color glass of a lower refractive index. RI:1.8. SG:4.56. H:6. It can be distinguished by its peculiar, hexagonal parallel fiber-bundle structure under the microscope. Also called cathay stone, cat's-eye or mistakenly spelled cats-eye.

**cathay stone**; same as cathay cat's-eye.

**cathedral glass**; a flat glass, made by the cylinder process, with a textured surface resembling old glass, it is used in making stained-glass windows. Also called antique glass.

**Cathedral of San Giovanni in Genoa**; a cathedral in Genoa, Italy in which a famous shallow, circular Grail or dish made 12.5cm high and 36cm in diameter made of antique green glass with gas bubbles is preserved. Also called Sacra Catina, Sacred Vessel. → Holly Gral.

**Cathedral of Toledo**; → Crown of Virgin del Sagrario.

**Catherine the Great's Sapphire**; the fine sapphire, which once belonged to Catherine the Great of Russia, was most recently purchased by Harry Winston. → Star of India.

**cathode**; the negative terminal of an electrolytic cell, the electrode, by which electrons enter the device from an external circuit.

**cathode rays**; a stream of electrons emitted from the surface of a cathode in a vacuum tube, the source of X-rays or Roentgen rays. Also called electron beam.

**cathodoluminescence**; certain minerals display a remarkable fluorescence, when they are lit with a beam of cathode rays. The phenomena can be observed only to a very limited extent, in some varieties of mineral. It is a useful research tool for detecting the presence of radioactive or rare earth elements in minerals. Abbreviation: CL.

**cathodoluminescence microscopy**; microscopic study of minerals, gems and materials that emit beam by means that are not temperature depended.

**cathodoluminescence of synthetic diamonds**; certain synthetic diamonds made by De Beers Diamond Research Laboratory, in Johannesburg, South Africa, show a number of features under cathodoluminescence, and greenish-yellow glow. Some natural yellow stones, which exhibit blue luminescence.

**cathodoluminescence of synthetic emeralds**; the

Lennix synthetic emerald, made by De Beers Diamond Research Laboratory in Johannesburg, South Africa, when under cathodoluminescence displays a pink or pale violet-blue color.

**Catherine the Great's Emerald:** a hexagon-cut emeralds of 70-80 cts, surrounded with numerous of diamonds in a stud. It was a wedding gift from Catherine the Great of Russia to a Prussian family. Present owner is S. S. De Young of Boston, USA.

**Catherine the Great's Emerald:** a rectangular-cut Columbian emeralds of 136.50 cts, surrounded with numerous of small diamonds in a stud. Now on display at Diamond Fund Museum in Moscow, Russia.

**cation;** positive charged ions.

**cationic dye;** same as basic dye.

**catlinite;** a soft, red to brownish, siliceous, indurated clay containing pyrophyllite, from southwestern Minnesota. Formerly used by the Indians for making pipes. Also called catlinite pipestone, Indian pipestone.

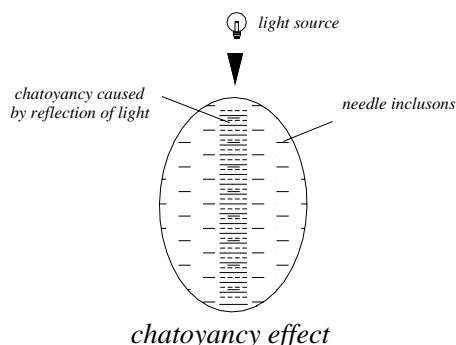
**catlinite;** a soft, red to brownish, siliceous, indurated clay used in the synthetic diamond industry as container material.

**catlinite pipestone;** → catlinite.

**Catoca Pipe;** location of a diamond-bearing kimberlite pipe near Chicapa River, Angola, Africa.

**cat sapphire;** same as lynx sapphire. A black or greenish-blue, Oriental sapphire, (precious sapphire).

**cat's-eye;** the term "cat's-eye" was originally applied to the chatoyant variety of chrysoberyl. Any gemstone, which, when cut en cabochon, and put under a single, strong source of light exhibits a sharp, narrow, well-defined chatoyant band or streak, that moves across the summit of the gemstone and shifts from side to side as



the gem is turned under the light. It resembles the shape of the slit pupil of a cat's eye. This phenomenon is caused by the reflection of light, from numerous inclusions of minute fibers, (crystals), or long parallel cavities, channels, or tubes. A numerous of gemstones exhibit this phenomenon, including chrysoberyl, several varieties of quartz, sillimanite, orthoclase, albite, scapolite, moonstone, cordierite, beryl, tourmaline, etc.

Many other gemstones exhibit a well-defined light line, but these are more often said to have a cat's-eye effect or a chatoyant effects. Two types of cat's-eye imitations are made. → Chatoyant, cymophane, tiger's-eye, hawk's-eye, and girasol, cat's-eye imitation.

**cat's-eye;** a variety of grayish-green quartz or chalcedony, containing fine fibers of asbestos, that exhibit an opalescent play of light.

**cat's-eye;** yellowish-brown, silicified crocidolite.

**cat's-eye;** a greenish variety of chrysoberyl that exhibits chatoyancy. Synonym for cymophane, oriental cat's-eye. Two types of cat's-eye imitations are made. → Chatoyant, cymophane, tiger's-eye, hawk's-eye, and girasol, cat's-eye imitation.

**cat's-eye;** incorrect term sometimes used for shell cat's-eye.

**cat's-eye;** a crescent-shaped blister.

**catseyte;** an irritant term for a chatoyant glass made of parallel glass fibers, which shows hexagonal honeycomb pattern in cross section.

**catseye;** a term used for glass chatoyant.

**catseye;** a misnomer for cathay cat's-eye.

**cat's-eye actinolite;** a greenish variety of actinolite, from Tanzania that exhibits chatoyancy. RI:1.63, S.G.3.00. Similar to tremolite cat's-eye. → Cat's-eye nephrite.

**cat's-eye amphibole;** a tourmaline-green variety of amphibole from Myanmar, (Burma) that exhibits chatoyancy, when cut en cabochon.

**cat's-eye apatite;** a greenish, translucent apatite from Sri Lanka, with a cat's-eye effect, when cut en cabochon in the correct direction.

**cat's-eye beryl;** a greenish variety of beryl that exhibits chatoyancy.

**cat's-eye chrome diopside;** a gem greenish variety, of chrome-rich gem quality diopside, from Myanmar, (Burma), and Kimberley, South Africa, that exhibits chatoyancy.

**cat's-eye chrysoberyl;** dark yellow-brown, light yellow, honey-yellow and greenish varieties of chrysoberyl that exhibits chatoyancy, when cut en cabochon in the correct direction.

**cat's-eye corundum;** a very rarely occurrence corundum cat's-eye.

**cat's-eye diopside;** a fine, greenish variety of chrome-diopside, from Myanmar, (Burma), that exhibits chatoyancy, when cut en cabochon, due to fibrous material.

**cat's-eye emerald;** a greenish variety of beryl or emerald that exhibits chatoyancy.

**cat's-eye enstatite;** a misleading term for the glass-gray variety of enstatite, with a chatoyant effect, when cut en cabochon.

**cat's-eye feldspar;** moonstone feldspar from Myanmar, (Burma), which has oriented needles that cause a cat's-eye effects. Same as moonstone cat's-eye. → Black moonstone.

**cat's-eye fibrolite;** a misleading term for a pale, grayish-green variety of sillimanite from Myanmar, (Burma), contains fibers in a parallel arrangement, yielding a cat's-eye effects. Fibrolite is a greenish or brownish fibrous variety of sillimanite. Also erroneously called sillimanite cat's-eye. → Cat's-eye sillimanite.

**cat's-eye glass;** a cabochon of gray or blue glass on the base of which, fine, parallel lines, intersects, exhibiting chatoyancy. → Cathay cat's-eye.

**cat's-eye hexagonite;** the transparent, pink to purple, manganese-rich variety of tremolite, when cut en cabochon is a chatoyant exhibits a weak cat'-eye, It also exhibits orange fluorescence. Found at Flower, St. Lawrence County, New York, USA.

**cat's-eye Hungarian;** an unsatisfactory term for an inferior quality of pale greenish to grayish variety of quartz cat's-eye from Bavaria, which is sold as Hungarian cat's-eye.

**cat's-eye imitation;** there are two sorts of cat's-eye imitation made of glass: (a) → cathay cat's-eye or cathay stone. (b) Iimori stone, which is sold as victoria cat's-eye or victoria stone. → Iimori stone.

**cat's-eye kornerupine;** a dark, greenish to yellowish variety of kornerupine from Sri Lanka, that exhibits a small deeply-colored flacks and very sharp chatoyancy.

**cat's-eye kunzite;** a pink to violet variety of spodumene that exhibits chatoyancy, when cut en cabochon.

**cat's-eye kyanite;** a dark-blue to pale-blue variety of kyanite that exhibits chatoyancy, when cut en cabochon.

**cat's-eye moonstone;** a blue, bloom moonstone from Kangayam, India that exhibits chatoyancy. → Cat's-eye feldspar

**cat's-eye nepheline;** a translucent, blue-green, reddish-brown, or brown nepheline that exhibits chatoyancy because of inclusions.

**cat's-eye nephrite;** a rough, translucent to opaque member of the tremolite-actinolite series of the amphibole group. Same as actinolite cat's-eye, cat's-eye hexagonite.

**cat's-eye obsidian;** a gray to light-gray, transparent variety of obsidian that may show fine silky, striations of a cat's-eye effect, when cut en cabochon.

**cat's-eye opal;** a flash-fire, green or otherwise colored variety of harlequin opal, that exhibits chatoyancy.

**cat's-eye peridot;** a green variety of peridot that exhibits chatoyancy.

**cat's-eye petalite;** a white to pale-yellow variety of

petalite, from Brazil, or petalite-analcime from Zimbabwe, that exhibits chatoyancy.

**cat's-eye prehnite;** a semitransparent, pale, yellowish-brown variety of prehnite that shows a cat's-eye effect, when cut en cabochon.

**cat's-eye quartz;** most often greenish, but sometimes brownish or yellow, fine quartz from Sri Lanka, that exhibits chatoyancy. It is similar to chrysoberyl cat's-eye, as the effect is caused a number of needle or channel inclusions, which are of parallel oriented. Same as quartz cat's-eye.

**cat's-eye resin;** a misleading term for dammer.

**cat's-eye resin;** → batu.

**cat's-eye ruby;** same as ruby cat's-eye.

**cat's-eye sapphire;** another spelling of sapphire cat's-eye.

**cat's-eye satellite;** a fibrous, grayish to greenish-blue variety of serpentine or chrysolite, which produces a cat's-eye effect, when cut en cabochon. Found in Maryland, and California, USA.

**cat's-eye scapolite;** a white, pink or violet, distinctly fibrous variety of scapolite from Mogok, Myanmar, (Burma), which produces a cat's-eye effect, when cut en cabochon in the correct direction.

**cat's-eye shell;** the domed upper surface, with its porcelain-like luster and shades of brown, yellow and green color of the so-called black-lip pearl shell is suitable to be cut to produce cat's-eye shell or Chinese cat's-eye. This is one form of operculum, the marine gastropod, *Turbo petholatus*, a sea snail. It shows a cat's-eye effect. Also called shell cat's-eye.

**cat's-eye sillimanite;** same as cat's-eye fibrolite.

**cat's-eye synthetic alexandrite;** a variety of synthetic alexandrite with a cat's-eye effect, made by Inamori, Japan, with fine, white, acicular inclusions.

**cat's-eye spodumene;** a white variety of spodumene, from Brazil, that exhibits chatoyancy.

**cat's-eye tourmaline;** a yellowish variety of tourmaline that exhibits chatoyancy or the cat's-eye effect, when cut cabochon, caused by the inclusion of thin fibrous crystals.

**cat's-eye tremolite;** a greenish, chatoyant variety of tremolite from Ontario, Canada, which gives a good cat's-eye effect, when cut en cabochon.

**cat's-eye tremolite;** a lilac-pink variety of tremolite, is termed *hexagonite*, from New York, USA. RI:1.60-1.62. SG:2.976-2.98. H:5½-6.

**cat's-eye ulexite;** ulexite is a fibrous and reniform mineral. When cut en cabochon because the fibers are at right angles, it shows a very good cat's-eye effect.

**cat's-eye zircon;** a few colored varieties of zircon exhibit chatoyancy, when cut en cabochon due to fibers arranged at right angles.

**cat's-eye zoisite;** zoisite crystals exhibits chatoyancy or cat's-eye, when cut en cabochon. This is caused by numerous needles or canal-like inclusions, which are oriented parallel to one another.

**cat silver;** synonym for mica.

**cat's quartz;** a misleading term for quartz cat's-eye.

**cat's silver;** synonym for mica.

**Catskill diamond;** a misleading term for colorless quartz crystals from the Catskill Mountains, New York, USA.

**catty;** a Chinese weight unit equal to 1.1023 pounds or 500 grams.

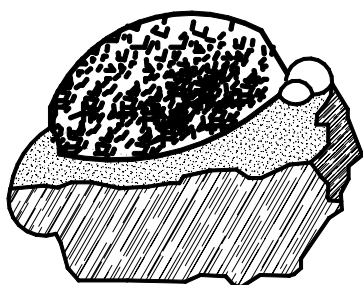
**catty;** a Thai or Siamese weight unit, used for rough zircons, equal to 3015 cts.

**catty;** a gold weight, which equals 2.981 troy pounds.

**Catumbela River;** location of a diamond-bearing kimberlite pipe, near Chicapa River, Angola, Africa.

**caulk;** a term used by English miners as barite.

**cauliflower aggregate;** a kind of aggregate can be seen



*cauliflower aggregate*

in some carbonate minerals similar to vegetable cauliflower.

**caustobioliths;** a term used for combustible substances of organic origin usually of plant origin such as resins and waxes. Ambers, resins and waxes are classified in a subgroup as liptobioliths, which mean that materials are resistant to the decay.

**cave coral;** a small, stalked formation of calcium carbonate on the floor, the wall, or ceiling of a cave.

**Cave Creek jasper;** a fine, bright red jasper from Cave Creek, Arizona, USA.

**cave marble;** a cryptocrystalline, banded layer of calcite or aragonite. Same as cave onyx.

**cave onyx;** a cave marble that can be highly polished. Synonym for cave marble.

**cave pearl;** a misleading term for a concretion of calcite or aragonite with a pearly luster formed by concentric drops of precipitation, which fall around a nucleus. Usually found in caves. The faceted golden-yellow variety is a collector's stone. Found in Idaho, USA and Bohemia, the Czech Republic. Synonym for cave pisolite or pisolite.

**cave pisolite;** same as cave pearl.

**cavern;** same as underground chamber or series of chambers carved out by rock spring in limestone. Also called underground chamber.

**cavern deposit;** any deposit of cryptocrystalline, banded layer of calcium carbonates such as calcite or aragonite, or other minerals occurring by flowing water on the walls or from roof to floor of a cave.

**cavity;** any opening on the surface of a diamond, caused by when included crystals, were pulled out from the surface during the polishing, possibly during cleavage.

**cavity;** a term used for elongated tube bounded by parallel silvered reflecting mirror for the production of laser in a such cavity.

**cavity filling;** any opening on the surface of gemstones, caused by when included crystals, were pulled out from the surface during the polishing, possibly during cleavage such as in rubies and sapphires especially on the pavilion side. Such stones are filled with glassy material with lesser hardness than stone having improved surface by adding weight, appeared by covering the blemishes. Under magnifier will seen gas bubbles in fill materials. In immersion oil may also detect a difference in transparency of fill material and stone.

**cawk;** a Scottish term for chalk and limestone.

**c axis;** the vertical axis of crystals in all systems, except the isometric or cubic system. With subscript  $c_0$ .

**Cb;** a chemical symbol for the element Columbium.

**Ccomer Rumi;** a native Indian term for emerald from Quichua, Peru.

**Cd;** a chemical symbol for the element Cadmium.

**CDM;** an acronym for Consolidated Diamond Mines of South-West Africa, Ltd.

**Ce;** a chemical symbol for the element Cerium.

**cedar wood oil;** a vegetable oil used as an immersion medium for refractive index tests. RI:1.51.

**cedar wood oil;** same as treated emerald.

**cedarite;** same as chemawinite, a variety of amber, from Manitoba, Canada.

**Cedro do Abaet é Diamond;** the alluvial, light, lilac-colored diamond of 194.00 cts, rough, found in 1967 in Minas-Gerais, Brazil.

**CL;** an acronym for cathodoluminescence.

**celadonite;** same as terre verte or green earth, Verona earth.

**celastoid;** a property of thermoplastic, made from cellulose acetate. Similar as bexoid.

**Celebes pearl;** a pearl from the Celebes Archipelago. Inferior in quality to a Madras pearl or a Bombay pearl, but better than an Australian pearl.

**celadonite;** a soft, green or green-gray, earthy mineral of muscovite group, containing silicate of iron, magnesium and potassium, occurring in cavities of

basalt rock. Regarded as a ferruginous glauconite.

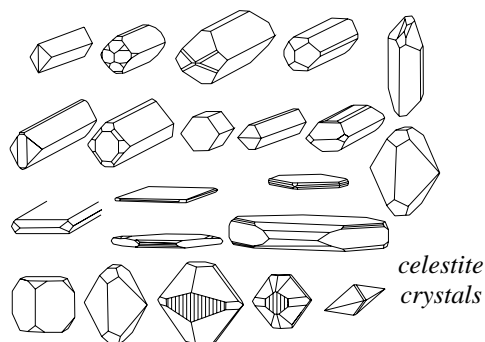
**celeste blue**; a ceramic color made by adding cobalt blue to zinc oxide.

**celestial opal**; a term for a fine quality of pearl.

**celestial stone**; synonym for turquoise.

**celestine**; same as celestite.

**celestite**; a mineral of the barite group. It is faceted in a



step-cut and prized by collectors. Fluorescent under UV light. Also spelled celestine.

System: orthorhombic.

Formula:  $4[\text{SrSO}_4]$ .

Luster: vitreous, pearly on cleavage.

Color: colorless, white, bluish, blue, green, gray, yellow, orange, and red.

Streak: colorless.

Diaphaneity: transparent to translucent.

Cleavage: {001} perfect, {210} good, and {010} indistinct.

Fracture: uneven. Brittle.

SG: 3.97-4.00.

H: 3-3½.

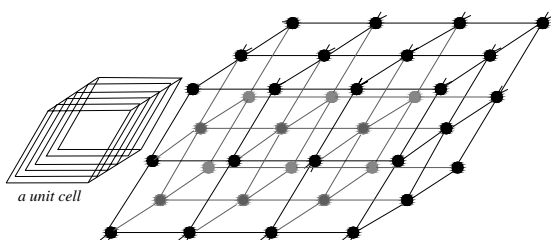
Optics:  $\alpha$ : 1.622,  $\beta$ : 1.624,  $\gamma$ : 1.631.

Birefringence: 0.009-0.012.  $\oplus$ .

Dispersion: 0.014.

Found in Malagasy and Namibia (Africa), Canada, and the USA.

**cell**; in mineralogy same unit cell, the simplest form of atoms, ions, or molecules that is characteristic of a



cells, unit cells, elemental cells or parallelepipeds  
a homogenous, three dimensional discontinuum

particular crystal lattice. It is repeated indefinitely to form the crystal lattice.

**cell**; in ore mineralogy a compartment in a flotation

machine for enrichment of ores.

**cell**; smallest volume unit on a mathematical coordination system.

**cell**; in biology and organic mineralogy the microscopical and structural unit of living organisms which may create mineralodis such as coral.

**cell**; a small vessel or like that made of glass, metal, plastics, etc., containing electrolyte.

**Cellini, Benvenuto**; an Italian goldsmith and sculptor, (1500-1571). He described some gemstones and large diamonds in his two treatises on Goldsmithing of 1568, such as the Cellini Green Diamond, and the Cellini Peach Diamond. Cellini was a famous sculptor.

**cellomold**; similar to bexoid.

**cellon**; a non-flammable, cellulose acetate plastic. RI:1.48. SG:1.26.

**cellophane**; a flexible thin transparent film, uniaxial substance, highly resistance to oil, grease, and air. Made from wood pulp by the viscose process, used as moisture-proof wrapping for industrial articles and in microscopy shows attractive colors between crossed Nicols.

**cellosolve**; a commercial term for the colorless liquid, ethylene glycol mono-ethyl ether. Used as an immersion medium in microscopy RI:1.408. Also called oxitol.

**cellosolve**; a colorless liquid with the chemical formula:  $\text{C}_2\text{H}_5\text{OCH}_2\text{CH}_2\text{OH}$ , soluble in water and alcohol.

**cells**; a so-called petri dish with a rather flat base, is used in gemology, with a stopper, to carry a stone on one axis or as a clean glass container.

**cellular**; a term employed for the texture of rock, containing numerous small openings, or sponge-like cavities, which may or may not be connected. Cellular is larger than pore size but smaller than cavernous. Synonym: vesicular.

**celluloid**; a thermoplastic substance, produced from camphor and nitro-cellulose, *cellulose nitrate*, or cellulose acetate, (safety celluloid), and an alcohol base. celluloid is of two varieties: (a) Ordinary celluloid RI:1.495-1.51. SG:1.36-1.42. (b) Safety celluloid RI:1.490-1.505. SG:1.29-1.40. Sometimes used as an imitation of amber, ivory, tortoise shell, smoker articles, etc. It smells vinegary when burnt or touched with the hot point of a needle on its surface. Other commercial terms for celluloid used are: hecolite, rhodoid, viscoloid, pyralin, and fibroid. Under UV light fluoresces yellowish-white.

**celluloid imitation amber**; same as amber antique.

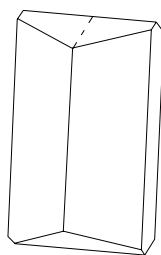
**cellulose**; a polymeric carbohydrate, (polysaccharide), composed of glucose units, with the formula  $(\text{C}_6\text{H}_{10}\text{O}_5)_x$ . It is the fundamental component of the cell walls in plants. RI:1.54. SG:1.40-1.43. H:2 ½.

**cellulose acetate;** a transparent to opaque, flammable, thermoplastic compound that finds wide application in various imitation gemstones. It is extremely tough, and sectile, and when tested with a knife, has a resinous luster. RI:1.26-1.50. SG:1.27-1.37. H:1½. → Bexoid.

**cellulose nitrate;** a more or less transparent thermoplastic substance, produced from nitro-cellulose or cellulose nitrate. This is one of the products termed celluloid. Other commercial terms are: pyralin, hecolite, viscoloid, and fibroid. It is an amorphous, white, cottonlike, solid, sectile, and when tested with a knife, has a resinous luster. RI:1.495-1.52.0. SG:1.27-1.37. H:1½. It finds wide application in various imitations of gemstones.

**cell unit;**

**celsian;** a colorless, rare, silicate of barium feldspar. Monoclinic system. Formula of  $8[\text{Ba}(\text{Al}_2\text{Si}_2\text{O}_8)]$ .



*celsian crystal*

Colorless. Transparent. Optics;  $\alpha$ :1.579-1.587,  $\beta$ :1.583-1.593,  $\gamma$ :1.588-1.600. Birefringence: 0.011.  $\oplus$ . SG:3.38. H:5½. Found in Sweden, and California (USA).

**Celsius temperature scale;** temperature measurement system with the symbol C. in this scale, the freezing point of water is 0 °C, it is the same as a centigrade scale. An internationally adopted standard for water boiling is point 100 °C. To convert from Centigrade to the Fahrenheit scale, multiply by 9 and divide by 5 then add 32:

$$^{\circ}\text{F} = 9/5 ^{\circ}\text{C} + 32.$$

**cement;** generally, any adhesive material used for binding diamonds to the holder, during cleaving and bruiting.

**cement;** these cements soften and harden by heating and cooling.

**cement;** those chemical materials or other ore minerals, which bind loose particles of sediment rock together.

**cement;** those chemical materials joining the composite stones together.

**cement;** a term used by Australian miners for bandstone.

**cement band;** a term used by Australian miners for bandstone

**cementation;** generally, any process of binding together sedimentary rock particles by some secondary material.

In this process, rocks are consolidated into hard, compact aggregates. An important component of diagenesis.

**cemented with gypsum;** same as gypsinite. → Cementation.

**cementing material in rocks;** a material, which binds any loose sediment into unified rock.

**cementite;** same as cohenite.

**cenotypal;** same as young volcanic.

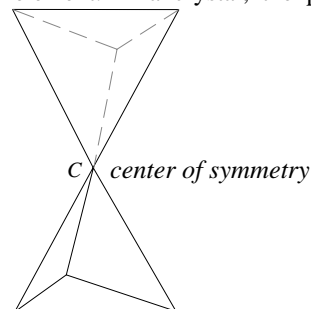
**Cenozoic;** the latest era of geologic time, from the beginning of the Tertiary period to the present, recorded by stratified rocks on the earth's crust. Beginning from 65-70 million years ago it includes the Tertiary and Quaternary periods. Also called Cainozoic, or Kainozoic.

**Cent Six;** the diamond of 106 cts, found reported but not confirmed.

**Centenary Diamond;** the flawless, fancy, fashioned diamond of 273.85 cts, cut from a 599 cts, rough diamond from Premier Mine, South Africa. The diamond has 164 facets on the crown and pavilion, and 83 facets on the girdle, (164 facets). Named to commemorate the 100<sup>th</sup> anniversary of De Beers Consolidated Mines.

**center of inversion "i";** → center of symmetry.

**center of symmetry;** in crystallography, the symmetrical element. In a crystal, the point was the



axes and planes of symmetry intersect. Synonym for the center of inversion *i*. See the graphic of body-centered cubic crystal. Also called, symmetry center, inversion center.

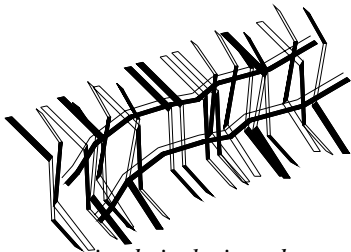
**centigrade degree;** temperature measurement with the symbol C. → Celsius temperature scale.

**centigrade, temperature scale;** temperature measurement with the symbol C. → Celsius temperature scale.

**centipede;** term refers to the form in the freshly broken surface occurring in moonstone and in some other gemstones, which has the shape of small parallel, wavy, and tapering lines.

**Central African Republic;** an important alluvial diamond-bearing country in western and eastern part of

the country in Mouka-Ouadda sandstone formation.



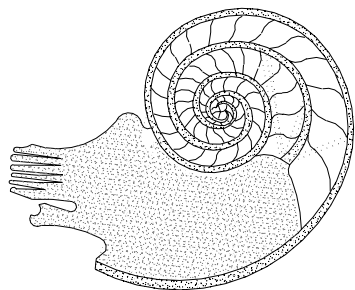
*centipode inclusions due to fissures in Sri Lanka moonstone*

**Central African Republic Diamonds;** diamonds from the Central African Republic.

**Central Selling Organization;** a subsidiary organization of the De Beers group, which dominates 80% of the world's rough diamonds, trade and receives, buys, sorts, and markets rough and industrial stones. Formed in 1934. Abbreviation: CSO. Gem quality diamonds are traded by the Diamond Trading Company, and industrial diamonds by Industrial Distributors Ltd. It encompasses three different companies: Diamond Corporation Ltd. Diamond Trading Company Ltd., and Industrial Distributors Ltd.

**centrosphere;** same as barysphere or inner core.

**cephalopod;** any group of marine mollusk, belonging to the class cephalopoda, characterized by a well-



*section through a cephalopod, marine*

developed head, mouth, and eyes and a ring of sucker-bearing tentacles. The external shell, if present, as in the nautilus, is univalve and resembles a hollow cone, which may be straight, curved, or coiled and divided into chambers, connected by a siphuncle. → mollusks.

**cephalopoda;** → cephalopod.

**cerachat;** same as ceragate.

**ceragate;** a term used for wax-yellow chalcedony. Same as carnelian.

**ceramic jewelry;** porcelain or pottery material used for gems or for gem imitations.

**cerannite;** a French name for nephrite.

**ceraunio;** a term used by Solinus for pyrope garnet. Pliny described a bluish stone, perhaps a moonstone

(after Rouse).

**ceraunite;** same as thunder-bolt.

**cerannite;** a French name for nephrite.

**cercaria;** a term applied to larval stage of some trematodes.

**ceremony of the scarab;** the term for a carved scarab mostly from emerald or beryl may be worn as a protective amulet or talisman, usually the scarab is invested with powder and at bottom is engraved image of Holy Isis. Also called ceremony of the beetle.

**ceremony of the beetle;** → ceremony of the scarab.

**Ceres Diamond Probe;** a commercial term for a thermal diamond tester. → Thermal conductivity diamond tester.

**ceric oxide;** → cerium oxide

**cerinus;** a wax colored beryl.

**cerium;** a steel-gray, metallic element in the Periodic System with the symbol Ce.

**cerium oxide;** a yellowish-pink, polishing powder of cerium oxide, used for beryl and quartz gemstones. Also called ceric oxide.

**cerkonier;** an ancient term for colorless zircon.

**cerkonier;** a pale-blue or colorless jargon, (zircon), from Sri Lanka.

**certificate;** a written declaration, including all the details about a polished diamond or gemstone. Certificate usually issued by grading laboratories.

**certificate diamond;** any fashioned diamond accompanied by a grading certificate. Also called certified diamond.

**Certificated diamond;** → certificate diamond.

**Certificated price;** → premium price.

**Certified Gemologist;** a diploma or a title, awarded by the American Gem Society to members who have been qualified through passing examinations. Abbreviation: CG.

**centripetal replacement;** replacement of a mineral substance from the periphery internally.

**ceruleite;** a turquoise-blue to sky-blue, cryptocrystalline, with the chemical formula of  $\text{CuAl}_2(\text{OH})_2\text{AsO}_4 \cdot 7\text{H}_2\text{O}$ . RI:1.69. SG:2.7-2.8. H:6½. Found in Chile, Cornwall, England. It is rarely fashioned as cabochon.

**cerulene;** a commercial term for a form of calcite, colored blue and green by malachite and azurite, from Bimbowrie, South Australia. Used as gemstone.

**cerulene;** a misleading term for blue satin spar. Also called ceruline.

**cerulene blue;** a term frequently used for indigo blue turquoise.

**ceruline;** same as cerulene.

**cerussite;** a colorless carbonate of the aragonite group. It is prized by collectors. Synonym for white lead, or lead spar.



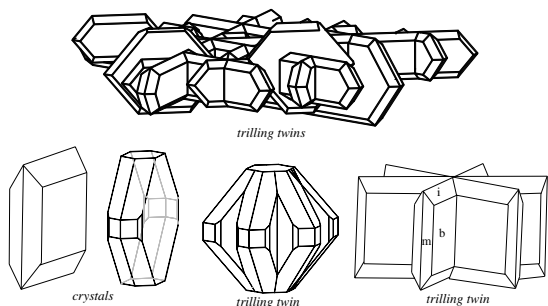
System: orthorhombic.

Formula:  $4[\text{PbCO}_3]$ .

Luster: adamantine, vitreous, resinous, or pearly.

Streak: colorless to white.

Colors: colorless, pale yellowish, green, gray, smoky, blue, dark



cerussite crystals and two trilling twins

gray, or black.

Diaphaneity: transparent to translucent.

Cleavage: {110} distinct, {021} distinct, {012} trace, and {010} trace.

Fracture: conchoidal. Very brittle.

SG: 6.55.

H:  $3\frac{1}{2}$ .

Optics;  $\alpha$ : 1.8036,  $\beta$ : 2.0765,  $\gamma$ : 2.0876.

Birefringence: 0.275.  $\ominus$ .

Dispersion; 0.055.

Worldwide occurrence.

**cerussite luminescence;** Luminescence under WSUV: shades of green of light blue. Under LWUV: pinkish-orange, shades of yellow.

**cestode worms;** any minute, tapeworm-like parasite, which may cause irritation in a mollusk and form a *blister*, when introduced between the shell and mantle, or, a *pearl sac* which produces a *cyst pearl*, when introduced into the mantle. Also the trematode worm and *Atax ypsilophorus* has the same effect. Also called *Distomum duplicatum*.

**ceylanite;** original spelling of Ceylonite.

**Ceylon;** same as Sri Lanka.

**Ceylon alexandrite;** a fine-quality alexandrite from Sri Lanka found in large sizes, often more than 20 cts, in weight, after cutting.

**Ceylon brilliant;** a local, misleading term for a colorless zircon with a brilliant cut from Sri Lanka.

**Ceylon brilliant cut;** same as Ceylon cut.

**Ceylon cat's-eye;** same as chrysoberyl cat's-eye, from Sri Lanka. Also called Ceylonese cat's-eye.

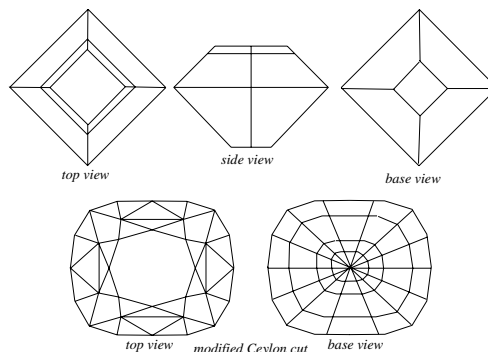
**Ceylon chrysoberyl;** a dark-green to green colored chrysoberyl from Sri Lanka, most often with cat's-eye effect or chatoyant effects.

**Ceylon chrysolite;** a local, misleading term for yellowish-green to greenish-yellow tourmaline from Sri

Lanka. Also called Ceylonese chrysolite.

**Ceylon cut;** any gemstone of modified brilliant-cut, a step-cut bottom, a round, oval, or other form in the girdle outline.

**Ceylon cut;** a commercial term for a mixed cut in any



stone of any form or any style that has been finished unsymmetrically, to preserve as much of the original weight as possible.

**Ceylon diamond;** a misleading term for colorless zircon from Sri Lanka.

**Ceylon garnet;** almandine garnet from Sri Lanka, which is frequently sold under the misnomer as *kandy spinel*.

**Ceylon Gem Society;** → Gem Society of Sri Lanka.

**Ceylon hyacinth;** a misleading term for hessonite garnet from Sri Lanka.

**Ceylon hyacinth;** a term used for jargon or hyacinth a gem variety of zircon from Sri Lanka.

**Ceylon moonstone;** very important deposits of orthoclase moonstone in Sri Lanka, with a usually whitish, less often bluish adularescence. Sometimes incorrectly called Ceylon or Sri Lankan opal.

**Ceylon opal;** a misleading term for moonstone from Sri Lanka (Ceylon).

**Ceylon pearl;** a fine silvery-white, spherically shaped pearl with a beautiful luster from the Gulf of Manner, between India and Sri Lanka, from the salt-water mollusk, *Pinctada vulgaris*.

**Ceylon pearl;** a commercial American term for a white pearl with a blue, violet or green luster.

**Ceylon peridot;** a misleading local term for yellow-green tourmaline from Sri Lanka. Used as a gemstone.

**Ceylon ruby;** a pale-red, pink or pigeon-blood red ruby from Sri Lanka. It is often classed as pink sapphire.

**Ceylon ruby;** a misleading term for almandine garnet.

**Ceylon sapphire;** a pink to pale-blue colored corundum from Sri Lanka, is called Sri Lanka sapphire.

**Ceylon sapphire;** an incorrect term for artificial sapphire.

**Ceylon shell;** a yellow-colored shell with a brown lip, which is a variety of *Margaritifera*, found in the waters of Sri Lanka.

**Ceylon spinel;** generally, an incorrect term applied to garnet from Sri Lanka.

**Ceylon zircon;** a green, nearly amorphous zircon from Sri Lanka. RI:1.79. SG:4.00-4.50. H:6½. → Ceylonian zircon.

**Ceylon zircon;** sometimes a fine red, cloudy zircon.

**Ceylonese cat's-eye;** same as Ceylon cat's-eye.

**Ceylonese chrysolite;** same as Ceylon chrysolite.

**Ceylonese peridot;** a misnomer for yellow-green tourmaline from Sri Lanka.

**Ceylonite;** varieties of dark greenish, brown and black spinel containing iron. Sometimes cut for mourning jewelry. RI:1.77-1.78. SG:3.63-3.90. Also called pleonaste, candite and spelled ceylanite or zeylanite.

**Ceylonian zircon;** a trade term for fire-red, yellow, yellowish green, and gray zircon. → Ceylon zircon.

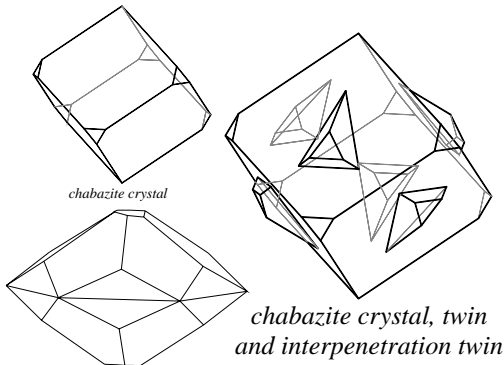
**Cf;** a chemical symbol for the element Californium.

**C.G.;** an acronym for Certified Gemologist.

**cha;** a Chinese term for opaque white nephrite. → Nephrite colors in Chinese, Chinese ritual and symbol jades.

**chabasite;** another spelling for chabazite.

**chabazite;** a zeolite mineral. Also spelled chabasite.



System: hexagonalic.

Formula:  $6[\text{Ca}(\text{Al}_2\text{Si}_4\text{O}_{12}) \cdot 6\text{H}_2\text{O}]$ .

Luster: vitreous.

Colors: colorless, white, lilac to pink, red, brown.

Streak: colorless.

Diaphaneity: transparent to translucent.

Cleavage:  $\{1011\}$  distincts.

Fracture: uneven. Brittle.

SG: 2.05-2.08.

H: 4-5.

Optics;  $\omega$ : 1.470-1.494,  $\epsilon$ : 1.470-1.494.

Birefringence: 0.00-0.024.  $\ominus$  or  $\oplus$ .

Found in Greenland, Russia, Italy, Nevada, California, New Jersey, and Hawaii, USA.

**chadacryst;** another spelling for cadacryst.

**chaff;** a term used by Australian miners for a pattern of straw, which is sprinkled on the surface of opal similar to lines.

**chagaleh;** a Farsi or Persian term meaning unripe, turquoise with white crust. → Turquoise classification in Iran.

**chai;** a Chinese term for hairpin of women carved from jade.

**chain;** any series, or members of things, which are connected and related by a specific phenomenon.

**Chain of Gems;** translation of the term Mani-Málá (book).

**chain silicate;** same as inosilicate.

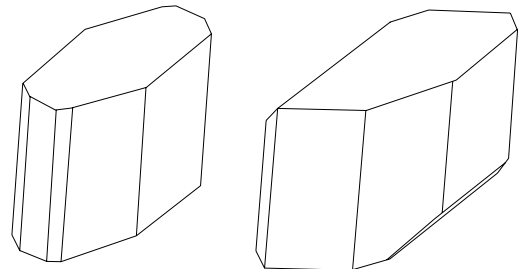
**chain structure;** same as structure of spinel or chromite series.

**Chair of Amber;** a chair made of amber, which presented from Duke Albert to Tsar of Russia.

**chakasi copal;** a Zanzibar native name for copal.

**Chalazia;** an historical term for quartz crystal pebbles, which fall as hailstone.

**chalcantite;** a blue mineral of  $\text{CuSO}_4 \cdot 5\text{H}_2\text{O}$ . Triclinic crystal. SG:2.20-2.30. H:2-2½.  $\alpha$ :1.516,  $\beta$ :1.539,

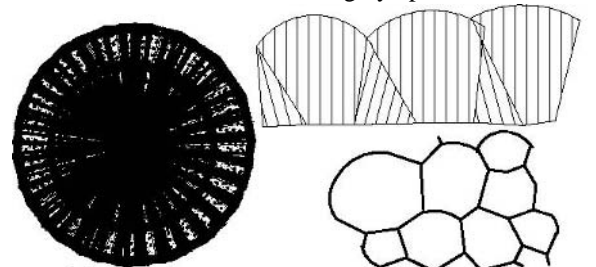


*chalcantite crystals*

$\gamma$ : 1546. Birefringence: 0.030. Cleavage:  $\{11\bar{0}\}$  imperfect,  $\{110\}$  trace. chalcantite without water is known as chalcocyanite. Also called copper vitriol, blue vitriol, blue stone, cyanosite, cyanose. Those with seven molecules of water are known as boothite.

**chalcedonite;** same as chalcedony.

**chalcedony;** a translucent, cryptocrystalline variety of quartz. It is commonly microscopically fibrous, massive, and has a nearly wax-like luster. It has a lower density than ordinary quartz (SG:2.58-2.64), is of a uniform tint, found in white, gray, pale-blue, brown,



*chalcedony sections seem between crossed Nicols*

*radiated quartz fibres in chalcedony*

*radiated quartz fibres in chalcedony*

black, and many of the other hues, known by a specific

names. Usually the blue color is caused by *Tyndall scattering effects*. It is porous and can be stained to improve the color. Subvarieties of chalcedony include agate, banded agate, eyed-agate, fortification agate, iris agate, moss agate, Mocha stone, fire agate, jasper, carnelian, sard, chrysoprase, prase, plasma, hornstone, bloodstone, (heliotrope), onyx, sardonyx, and light-blue, (common chalcedony). RI:1.53-1.54. SG:2.61. H:6½. The fracture has a splintery surface with a waxy luster. Luminescence under UV light is very variable. A light violet to gray-purple variety of chalcedony from Arizona, USA is marketed under the commercial name *damsonite* or *chalcedony amethyst*. Some carnelians are heat-treated whites. Blue chalcedonies and black onyx are often dyed chalcedonies. Also called myrickite, quartzine, and spelled chalcedonite, and calcedony. Found in Russia, Mexico, Iceland, and California, USA. An optically positive variety is known as lussatite. Glass in several colors is used as an imitation. → Agate. The difference between jasper, chalcedony and agate is based upon the transparency of light. Jasper is the most opaque variety, when translucent it is chalcedony, and translucent, and brightly colored stones are known as agate.

**chalcedony**; a trade term for natural blue onyx.

**chalcedony**; a term for crystalline silica that forms in concretionary masses with radiating fibers is optically negative, although quartz is positive.

**chalcedony agate**; a striped chalcedony.

**chalcedony amethyst**; → chalcedony.

**chalcedony, fossilized**; → agatized wood.

**chalcedony botryoidal**; → chalcedony stalagmite.

**chalcedony chrome**; a translucent, chromium-green variety of chalcedony similar to chrysoprase from Zimbabwe, Africa. It is red under a colored filter. Also known as mtorolite.

**chalcedony dyed**; → chalcedony.

**chalcedony enhydros**; nodules of cloudy-white chalcedony, which contain water, found in Australia, Uruguay, and India. It is a curio stone, of no gemological value. Also called enhydros, and water-agate.

**chalcedony industrial uses**; common chalcedony is used for technical and industrial purposes, such as for balancing edges of knife.

**chalcedony jet imitation**; imitation jet is made of black-dyed chalcedony, which is known as black onyx. Other jet imitations are made of glass, and obsidian.

**chalcedony-like fibrous of tourmaline**; a kind of cryptocrystalline fibrous of blue tourmaline masses occur in a fault near contact zone in Barstow, California, USA.

**chalcedony moonstone**; a misleading term for

translucent, colorless or white chalcedony, which is gathered from beaches in various parts of the world. It lacks the adularescent effect of genuine moonstone, (adularia), feldspar. Also called California moonstone.

**chalcedony onyx**; a chalcedony with alternating stripes, or bands of gray and white. Also spelled chalcedonyx.

**chalcedony patch**; a misleading term for a milk-like to white blemishes in ruby crystal.

**chalcedony rose**; a stalagmitic chalcedony in the form of a rose, termed chalcedony rose.

**chalcedony staining**; chalcedony can be stained different colors.

**chalcedony stalagmite**; much chalcedony occurs as botryoidal, stalagmite or stalactite masses. → Chalcedony roses.

**chalcedony stalactite**; → chalcedony stalagmite.

**chalcedony thunder egg**; → thunder eggs, star-shaped core.

**chalcedonyx**; a variety of onyx with alternating strips or bands of gray and white similar to chalcedony, used ad gem.

**chalchiguite**; same as chalchihuitl.

**chalchihuite**; same as chalchihuitl.

**chalchihuites**; same as chalchihuitl.

**chalchihuitl**; a Mexican Indians term for a green stone, such as jade, turquoise, smithsonite, serpentine, porphyry, etc., that has been carved into a decorative or useful objects. Also spelled chalchiguite, chalchihuite, chalchihuites, chalchuite, chalchuites. → Tolteca-iztli, tlilavotic chalchihuitl, quetzal chalchihuitl, iztac-chalchihuite.

**chalchihuitl**; sometimes applied to any stone regardless of color, that has been carved such as green quartz, jade, or madre de esmeralda (mother-of-emerald), malachite, serpentine and chrysocolla.

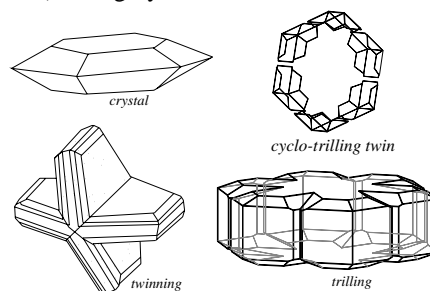
**chalchihuitl**; it usually refers to jadeite or turquoise, but sometimes to porphyry and serpentine.

**chalchihuitl**; a variety of blue to green turquoise.

**chalchuite**; a blue or green variety of turquoise. Same as chalchihuitl.

**chalchuites**; another spelling for chalchihuitl.

**chalcocite**; lead-gray to black, with a metallic luster, of



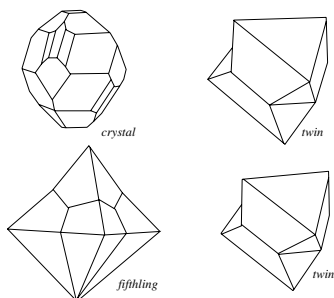
*chalcocite crystal, twin and cyclo-trilling twin*

96[Cu<sub>2</sub>S]. It occurs in orthorhombic crystals or in masses, sometimes used in cheap jewelry. SG:5.5-5.8. H:2½-3. Synonym for chalcosite, chalcosine, redruthite, beta chalcocite, and vitreous copper. Also known as copper glance.

**chalcogens**; a homogeneous group of chemical elements in Group VIB of the Periodic System include O, S, Se, Te, and Po.

**chalcogens**; the association of ore deposits are connected with a phase of plutonism and orogenic.

**chalcopyrite**; an opaque mineral of little interesting as a gemstone but for collectors. A sulfide of copper, 4[(CuFeS<sub>2</sub>)]. Tetragonal system. SG 4.2. H:3½-4. Brass yellow in color, often showing a superficial tarnish or iridescence. Brittle. Found: worldwide. It can



*chalcopyrite crystal, twin and fithling*

be seen as an inclusion in peridot, garnets, etc. Known as copper pyrites, yellow copper ore, run, pyrite of copper, yellow pyrites, copper iron sulfide.

**chalcosiderite**; an isomorphous mineral, with turquoise CuFe<sup>+3</sup><sub>6</sub>[(OH)<sub>2</sub>(PO<sub>4</sub>)<sub>4</sub>].4H<sub>2</sub>O. Blue-green to dark-green color. Triclinic system. Optics; α:1.775, β:1.840, γ:1.850. Birefringence: 0.075. ⊖. SG:3.22. H:4½. Cleavage: {001} distinct, and {010} good. Found in Arizona, USA, Saxony, Germany and Cornwall, England.

**chalcosine**; same as chalcocite.

**chalcosite**; same as chalcocite.

**chalcosphere**; a theoretical zone or layer of the earth consisting of heavy metal oxides and sulfides.

**chalcotrichite**; a variety of cuprite.

**chalcocyanite**; → chalcantinite.

**chalk**; a white, fine-grained and soft sedimentary rock of

limestone, which contains nearly 90% calcium carbonate, almost entirely as calcite. Derived from floating micro-organisms and finely divided marine shells with detrital quartz etc. Fine grained, and somewhat friable to gritty in texture. Scottish termed as cauk, cawk.

**chalk jade**; a descriptive term employed by the Chinese for a specific color grade of jade.

**chalk powder**; powdered chalk which is used in gem industry.

**chalky**; a term sometimes used for cretaceous chalk.

**chalky**; → iridescence.

**chalky chert**; commonly dull or earthy, soft to hard, sometimes fine-porous, essentially uniform in composition, uneven or rough fracture surface, resembling chalk.

**chameleonite**; same as chameleonite.

**chalumeau**; an inverted oxy-hydrogen burner installed in the Verneuil furnace for the process of producing synthetic stones. → Verneuil furnace.

**chalybite**; same as siderite, which is frequently seen as a cut stone.

**chamber**; a term used by Australian miners as an abbreviation for loading chamber, which is a working area in underground at the bottom of the shaft.

**chambered nautilus**; same as nautilus shell.

**chambering**; the process of removing the blue ground from pipe mines in South African diamond mines.

**chamber out**; a term used by Australian miners for heaved and clear a good working area.

**chambersite**; a rare mineral prized by collectors.

System: orthorhombic.

Formula: 4[Mn<sub>3</sub>B<sub>7</sub>O<sub>13</sub>Cl].

Luster: vitreous.

Colors: colorless to brownish-lilac, pale brown to deep purple.

Streak: white.

Diaphaneity: transparent.

Cleavage: none.

Fracture: subconchoidal to uneven.

SG: 3.49.

H: 7.

Optics; α:1.730, β:1.737, γ:1.744.

Birefringence: 0.014. ⊕.

Dispersion: 0.015.

Found in Chambers County, Texas, USA, and Switzerland.

**Chameis**; location of a diamond mine, near Orange River in Namibia, Africa.

**Chameleon Diamond**; the brownish-yellow colored diamond of 2.24 cts, which changes in color from bronze to green by daylight, (ultraviolet light). It reverts to its origin color, when kept away from UV ray and daylight.



*microfossils in chalk*

**chameleon stone;** a hydrophane or opal that changes the color under daylight or artificial light.

**chameleon style diamond;** some diamonds are strongly phosphorescent and change color for a long time under daylight. Some take on a yellow color, when placed in a dark room and change to green, when exposed to daylight. Also called chameleon type diamond.

**chameleon type diamond;** same as chameleon style diamond.

**chameleonite;** a misleading term applied to olive-green tourmaline, that changes color to brownish red in artificial light. Also erroneously spelled chalmeleonite.

**chamfer;** a beveled face, formed by removing a portion of material from sharp edges or corners.

**champagne diamond;** a trade term for greenish-yellow, yellowish-green to brownish-yellow diamond where the color is not deep enough to be graded as fancy diamond.

**Champagne Topaz;** champagne to light yellow colored topaz of 7.37kg. Now on display at Los Angeles County Museum, USA.

**champlain marble;** a misnomer for massive dolomite, from Vermont, USA.

**chan;** a Chinese term for spade-shaped blade carved from jade. → Chinese ritual and symbol jades.

**chance OX7 filter;** a filter, like Wood's glass filter, used to produce short-wave ultraviolet radiation. It is more resistant, stronger and does not break as easily as Wood's glass filter.

**Chanda Diamond Field;** location of alluvial diamond deposits in India.

**changeable feldspar;** a misnomer for quartz, cat's-eye.

**changeable luster;** a term used for minerals with schiller luster.

**chang;** a Chinese term for a half-tablet carved from jade held in hand used to celebration worship God of the South, also used as State ceremonies. → Chinese ritual and symbol jades.

**change of color;** an optical phenomenon occurring in stone that shows a difference in color, (when a gemstone is moved), from daylight to artificial light, caused by selective absorption; such as alexandrite. → Transchromatic, play of color, transchromatic.

**change of color;** sometimes, an alternate term for labradorescence effects. → Transchromatic, play of color, transchromatic.

**changeant;** a French term for labradorite.

**changkol;** a Malaysian term for a heavy Chinese hoe, with an eye, in which the handle fits, used for cutting soft rock and earth and for stirring up the gravel in sluice boxes, etc.

**Changlin Diamond;** the yellow diamond of 158.79 cts, found in 1977 near the Chenjibu Mine in Shandong

Province, China.

**Changma;** a kimberlite diamond mine near the town of Changam Zhuang, in Shandong Province, China.

**Chang Kuo-Lao;** a Chinese term used for a human symbol carved on jade as a magician often with a monkey and carrying a bamboo tube drum named as yu ku. → Chinese ritual and symbol jades.

**Chang Li;** a Chinese term used for a human symbol carved on jade as a leader of eight immortals dwelt on the mountains with fungus a symbol of immortality. → Chinese ritual and symbol jades.

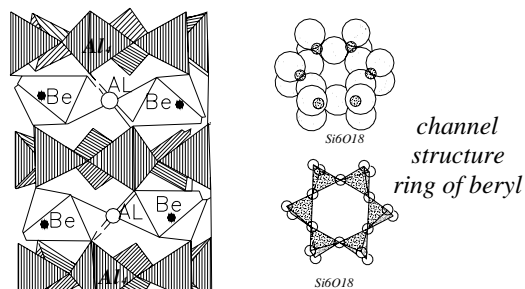
**chang ritual jade;** a Chinese term used for carved jade that is similar to a rod tapered at one end with red color to symbolize the fire and reverence to the South. → Chinese ritual and symbol jades.

**chang ti;** a Chinese term for a half-tablet carved from jade with disc and point held in hand used in celebration worship of mountain and river Gods. → Chinese ritual and symbol jades.

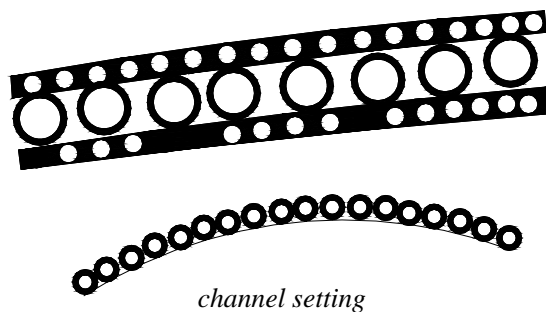
**chank pearl;** same as conch pearl. This sacred Indian pink pearl is devoid of nacreous luster and therefore not a true pearl. The mollusk is the gastropod *Turbinella scolymas*. Also called shank pearl.

**channels in cells;** → channel structural orientation.

**channel ions;** in some ring-silicate structures such as beryl ions trapped in the channel opening, the channels



are large enough to accept or to accommodate water molecules ( $H_2O$ ) in their chemical formula. → Channel structural orientation.



**channel setting;** a variety of finger ring setting used for small gemstones of uniform size in which one or two

rows are so close together that the edges are almost touching, arranged in a channel, usually a straight line. Pavé, paved, calibré cut.

**channel structural orientation;** tube or tabular-shapes occurred when Si-O rings in a silicate structure such as beryl aligned over each other, by which produced openings are in form of channels parallel to *c*-axis and may occupied with ions. Also called channels in cells.

**channer;** a Scottish term for gravel. → Channel ions.

**Chantabun ruby;** a gem market and ruby mining city in Thailand (Siam), in the district of the same name, or in Krat, south-west of Chantabun.

**Chantilly Pink Diamond;** same as Grande Condé Diamond.

**chaosite;** a natural carbon polymorph with diamond, graphite, and lonsdaleite.

**chaos of rocks;** a term used for a mass of large and small blocks (also fine-grained material) of rocks of irregular shape collected together.

**Chapada Diamond;** diamond of 87.50 cts, found 1851 in Chapada, Minas-Gerais, Brazil.

**chapeau de fer;** same as capping.

**chapra;** a kind of hoe used in mines in Bihar, India, for scraping waste rocks into pans.

**characteristic;** a commercial term, used in the USA for grading diamond clarity, divided into *internal characteristics* and *external characteristics* referring to inclusions and surface marks.

**characteristic fluorescence of gemstones;** generally, the luminescent effect test for gemstones is extremely helpful. It is based on the specific fluorescence emitted under induction of various wavelengths, such as long-wave ultraviolet, short-wave ultraviolet, cathode rays, etc. Also used in gemology, as one of several diagnostic methods. Generally, testing the fluorescence of glass is not particularly helpful.

**characteristic spectrum or radiation;** the disposition arrangement of extended, continuous, white X-rays or other optical wavelengths, related to the atomic structure of the material giving rise to them, are characteristic of the emitting element of the target.

**charcoal;** a term used to a black amorphous form of carbon produced by burning wood in the absence of air, which is used in blowpipe testing of minerals.

**charcoal-like appearance;** due to altering some tourmaline sunburst lost their resinous luster seen similar to charcoal luster.

**charge injection electroluminescence;** a term used in crystallography for a semi-conductor junction in crystals which depends on the nature of phosphor impurities as well as on the electric frequency. Also known as injected electroluminescence. → Intrinsic electroluminescence, injection electroluminescence.

**charge transfer of color in lattice;** the charge of a valence is result of the transfer of an unpaired electron between 2 different transition elements, with ions of different valency conditions, such as in sapphire, when a Fe<sup>+2</sup> and a Ti<sup>+4</sup> are substituted for aluminum Al<sup>+3</sup> or when Fe<sup>+3</sup> and Ti<sup>+3</sup> substituted for aluminum Al<sup>+3</sup>. This happens when an electron temporarily jumps from an iron to its neighboring titanium atom, which absorbs light by the transfer process. → Color (definition).

**charged lap;** lap with a surface embedded with abrasive or polishing dust.

**Charkhari Diamond-Mining Works;** a diamond-mining corporation in the Panna area of India.

**Charlemagne Crown;** → Imperial Crown.

**Charlemagne Emerald;** Same as Benedictine Abbey Emerald.

**Charlemagne's Crown;** → Imperial Crown.

**Charlemagne Talisman;** → Talisman of Charlemagne.

**Charlemagne's Talisman;** same as Talisman of Charlemagne. Also spelled Charlemagne Talisman.

**Charlemont Diamond;** the rough yellow diamond of 20 cts. Found in Cape Province, South Africa, it was bought by an officer of the Royal Artillery in 1854 in.

**Charles II;** the French Duke of Brunswick, (ca. 1810-1873), who owned a number of notable diamonds and other gemstones.

**Charles II Pearl;** the pearl found in 1691, presumably fished in America, and presented to Charles II, of Spain. Almost equal in weight to La Peregrina; both were worn as a pair of earrings, by the Queen of Spain.

**Charles II Sapphire;** same as Stuart Sapphire, it is companion to the Black Prince's ruby in the Imperial State Crown of England.

**Charles the Bold;** the Duke of Burgundy, (1433-1477), owned a number of notable diamonds and other gemstones.

**Charles the Bold Diamond;** the legendary, yellow, pyramid-shaped diamond that once belonged to Charles the Bold, Duke of Burgundy (1433-1477). The stone may have been lost at the Battle of Granson. Present owner unknown.

**charm;** any small article made of gemstone or other material, worn as a pendant or on a chain, or bracelet or carried, for its supposed ability to bring luck, ward off the devil or illness. Charms are made of gold or other metals often with designs of musical instruments, animals, zodiacal signs, hearts, horseshoes, egg, cloverleaf, etc. → Amulet, talisman.

**charnockite;** a coarse-grained, massive, dark, granitic rock, characterized by feldspars, blue quartz, and orthopyroxene. Found in Madras, India. Used as building stone.

**charoite;** an ornamental stone, carved as vases or other

objects.

System: monoclinic.

Formula:  $18[(Ca,K,Na)_2Si_2O_{10}(OH,F).H_2O]$ .

Luster: cryptocrystalline.

Colors: purple with swirls of greenish-black, orange.

Diaphaneity: opaque.

Cleavage: {001} good.

Fracture: subconchoidal to uneven.

SG: 2.60-2.78.

H: 5½-6.

Optics:  $\alpha$ :1.549,  $\beta$ :1.553,  $\gamma$ :1.560.

Birefringence: 0.009. ⊕.

Found in Yakutia, the Russian Federation, CIS.

**charoite pleochroism**; colorless to rose-pink.

**charp**; a commercial term for calcined, high-alumina refractory powder; made from Ayrshire bauxite.

**chashing**; ornamentation of metal, by cutting it with a graver, or the product of this process. → Ciselé, engraving.

**Châtelherault**; same as Châtellerault.

**Châtellerault diamond**; a misnomer for quartz crystal from Châtellerault, in west-central France. Also spelled Châtelherault.

**Chatham created emerald**; an undesired trade name for a flux-fusion synthetic emerald, grown by C. F. Chatham of San Francisco, California, USA.

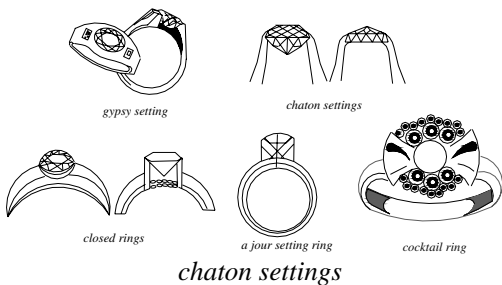
**Chatham cultured emerald**; same as Chatham emerald.

**Chatham emerald**; a misleading trade term for a flux-fusion synthetic emerald, grown by C. F. Chatham, San Francisco, USA. Also called Chatham created emerald, Chatham cultured emerald, Chatham synthetic emerald

**Chatham synthetic emerald**; a trade term for the synthetic emerald made by a flux-melt method grown in 1940 by C. F. Chatham of San Francisco, California, USA. RI:1.560-1.563. Birefringence: 0.003. SG:2.65. H:7½.

**Chatham synthetic rubies**; a flux-melt method of growing synthetic ruby, similar to that of synthetic emerald by C. F. Chatham of the USA. With similar constants as natural rubies, but unlike natural rubies, they lack any trace of the element iron.

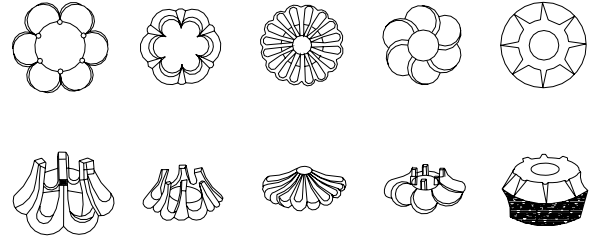
**cathay cat's-eye**; → chrysoberyl.



**cathay stone**; → chrysoberyl.

**chaton**; a French term for the bezel of a finger ring, set with a gemstone.

**chaton**; a faceted glass gem with a reflective mirror-like surface, the pavilion of which is treated with a mercury amalgam. Also called Mirror foiling. → Chaton foil.



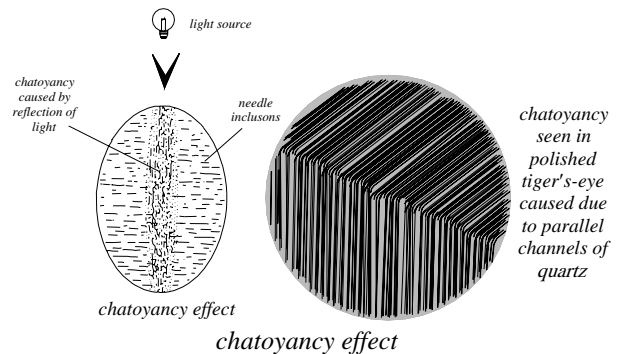
different chatons

**chaton foil**; imitation foilback or imitation lacquer back, on the base of a stone. Same as a colored imitation foilback.

**chatons**; glass imitation stones backed with a reflecting foil.

**chatoyance**; → chatoyancy.

**chatoyancy**; an optical effect, possessed by certain translucent gemstones in reflecting light, in which a movable, wavy or silky sheen is concentrated in a narrow band of white light that changes its position, when the gem is turned. This is characterized of cat's-eye and some other minerals. It is caused by the reflection of light from numerous, minute, parallel fibers, cavities or elongated tubes, or needle-like inclusions within the mineral, oriented in accordance with the symmetry of the crystal. The effect may be



seen in cut *cabochon* gems. It can be seen in certain quartz, chrysoberyl, tourmaline, moonstone, andalusite, scapolite, fibrolite, and adularia. When the needle-like or elongated cavities are parallel to more than one crystal face after being cutting cabochon, in other words, perpendicular to the plane of included materials, the stone exhibits a *star* effect. Also spelled chatoyance. → Epiasterism, diasterism, asterism.

**chatoyant**; said of a gemstone possessing chatoyancy or

has a changeable luster or color which is characterized by a thin narrow band of light resembling the cat's-eye.

**chatoyant malachite;** malachite with cat's-eye effect, when cut cabochon.

**chatoyant obsidian;** gray variety of obsidian with cat's-eye effect, when cut cabochon caused by parallel cavities or other inclusions.

**chatoyant quartz;** same as binghamite.

**chatoyant quartz with goethite inclusions;** same as binghamite.

**chat-sawed;** describes the surface finish of building limestone, which is somewhat smoother than "shot-sawed".

**chatter marks;** any of a series of small cracks seen along the faceted edges of corundum. They are caused



*chatter marks*

by local overheating on the polishing lap. This can be seen in both natural corundum and in synthetic corundums. Also spelled chattermark. → Fire marks.

**chatter marks;** small, short, densely-packed cracks, or curved scars seen on the surface of rocks, caused by other fragments at the base of a glacier.

**chattermark;** same as chatter marks.

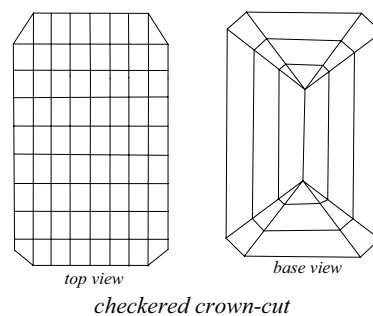
**chatty;** grown together.

**Chaulnes' refractive index method;** a direct measurement method in microscopy, which depends upon the change of focus caused by placing a plate of the substance whose refractive index is in question over an object in the focus of a microscope. Also called De Chaulnes' method of refractive index measurement, de Chaulnes' refractive index method.

**Cheapside Hoard Watch;** a large hexagonal emerald crystal of Colombian origin 17<sup>th</sup> century, in London a jeweler made a watch case from this crystal in which the dial itself was enameled emerald green, because of transparent hinged lid the time could be easily to read. This watch with other jewels was found by worker digging in an area of Cheapside of he jeweler's stock.

**checkered crown-cut;** a modified emerald-cut I which the crown is checkered at right angle and the pavilion is eight-sided elongated step-cut form.

**cheky;** a Turkish weight unit of 1600 cts, or 320 grams.



**Chelsea color filter;** a useful, popular filter consisting of a combination of two pieces of carefully-chosen, colored glass or films or filters, which when white light passes through them absorb or filter out certain colors of the spectrum. It transmits deep red rays near 690 nm and yellow-green near 570 nm. Minerals or materials seen are red, green or brown in color, when they possess one of the colors or mixture of the two, when viewed through such a filter. Natural or synthetic emeralds appear pink or red, but most imitation emeralds appear green. Cobalt colored synthetic blue spinel appears red through the filter. Also called Chelsea filter, emerald filter. → Color filter.

**Chelsea filter;** same as Chelsea color filter.

**chemawinite;** a pale-yellow to dark brown variety of retinite, (a fossil resin related to succinite), found in decayed wood at Cedar Lake in Manitoba, Canada. SG:1.055. Soluble to the extent of 21% in alcohol. Synonym cedarite.

**chemical bond;** a mutual attraction between two atoms resulting from a redistribution of their outer electrons.

**chemical composition;** a chemical formula for a substance, giving the relative number of atoms present in a particular mineral, for example, in corundum: Al<sub>2</sub>O<sub>3</sub>, or for quartz clan: SiO<sub>2</sub>, or calcite: CaCO<sub>3</sub>. Diamond exists as a single element, C. Also called chemical formula, compound.

**chemical composition;** the weight of elements or component parts, in percentage in a rock.

**chemical composition of gems;** the elements, or component parts of a mineral, of which a gemstone is composed. These are determined by chemical analyses. → Chemical composition.

**chemical element;** gem minerals or substances consist of atoms of only one element or one chemical type, this chemical type cannot be decomposed into any simpler substances by chemical means. Chemical elements are usually divided into 2 categories: metals and non-metals, with the exception of a few elements, in which they have both properties, such as in arsenic. Usually, metals are basic or positive elements, while non-metals are negative, or acidic elements. See also Table of the chemical elements in appendices.



**chemical erosion;** same as corrosion.

																					H	He		
Li	Be	B	C																		N	O	F	Ne
Na	Mg	Al	Si																		P	S	Cl	Ar
K	Ca	Sc	Ti	V	Cr	Mn	Fe	Co	Ni	Cu	Zn	Ga	Ge	As	Se							Br	Kr	
Rb	Sr	Y	Zr	Nb	Mo	Tc	Ru	Rh	Pd	Ag	Gd	In	Sn	Sb	Te							I	Xe	
Cs	Ba	Tr	Hf	Ta	W	Re	Os	Ir	Pt	Au	Hg	Tl	Pb	Bi	Po							At	Rn	
Fr	Ra	Ac	Th	Pa	U																			

*chemical elements*

**chemical formula;** same as chemical composition.

**chemical polishing;** improving the surface luster of a metal, by chemical treatment.

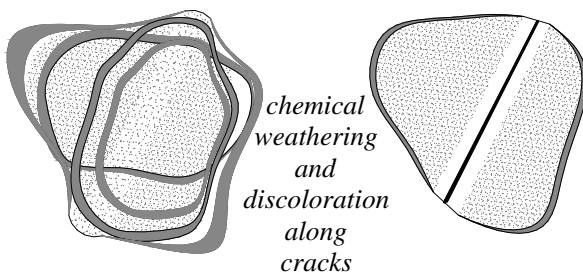
**chemical rock;** rock which formed from solution with peculiar chemical condition.

**chemical symbol;** the notation of single capital letter, or a combination of a capital letter and a lowercase letter, which is used to represent either an atom or a gram atom of an element, such as O for oxygen, Na for sodium, etc.

**chemical valency;** same as valency.

**chemical vapor deposition;** a method of producing synthetic diamond, using a thin film of tetrahedral-bonding, (similar to a diamond bond). Carbon atoms are deposited on a substrate, using hydrogen and methane gas, at low pressure and moderate temperatures. Also known as plasma-enhanced, chemical vapor deposition. → Synthetic diamond.

**chemical weathering;** the process of weathering whereby rocks and minerals are transformed into new chemical combinations at or near the Earth's surface



by chemical reactions such as hydrolysis, oxidation, ion change, and solution, for sample alteration of orthoclase feldspar into kaolinite. Also called decay, decomposition, disintegration, deconsolidation.

**chemiluminescence;** a type of cold light is exhibited by the chemiluminescence phenomenon, which is connected with chemical changes in a luminous minerals, which occur without increasing its

temperature. For example, bioluminescence is a kind of chemiluminescence.

**chemise;** → chemise stone.

**chemise stone;** same as revetment stone. A protective covering rock to prevent under lying surface, such as quartz en chemise which a skin milky quartz.

**cheng ya;** a Chinese term for a tassel or central bottom piece of a girdle pendant which is carved from jade. → Chinese ritual and symbol jades.

**chen yü;** an old term used in China for jade from Turkistan, which means true jade.

**chen yü;** a Chinese term for true jade.

**cherry amber;** a misleading term for red bakelite used as amber imitation.

**cherry opal;** a cherry colored variety of opal. Also called red colored common opal.

**cherry opal;** a misleading term for red or amber-colored, semitransparent opal from Querétaro, Mexico which has no iridescent quality. Some yellow-colored opals with the same properties are also found there.

**cherry opal;** a misleading term for *fire opal* that is applied in North America.

**cherry pearl;** a pink to cherry colored pearl.

**cherry pearl;** pearls grown in the size of cherries.

**cherry red;** a pink to cherry color.

**chert;** an impure, hard, extremely dense or compact, black or gray variety of micro- or cryptocrystalline silica, composed of chalcedony and quartz, which resembles flint. Sometimes contains impurities, such as calcite, iron oxide, and the remains of siliceous and other microorganisms. It has a conchoidal fracture and may be white, green, blue, pink, red, yellow, brown, and black. Long used by Indians and other native peoples for making knives, spearheads, arrowheads, and other useful objects. Chert occurs principally as nodular or concretionary segregations, in dolomites and lime-stones, and less commonly as layered deposits, (bedded chert). It may also be an original organic product. Artificially blue-dyed material is misleadingly called *Swiss lapis*. Used as abrasive material, cladding and paving stone. Sometimes used as an ingredient of tripoli. Also called hornstone, white chert, silexite, and phthanite. Source : widespread.

**chert nodule;** a dense, irregular, commonly fossiliferous, usually structureless, diagenetic segregation of chert nodule. Found in Mississippian limestone, and in the chalk from England and France.

**chert ironstone;** a sedimentary rock consisting of alternating iron-rich layers of chert and siderite, or chert and hematite. Sometimes greenalite is embedded in a chert groundmass, with some carbonate minerals. Found in Brazil, India, Scandinavia, South Africa, and Lake Superior, Canada.

**chessman**; a term used for chessman made of jet.

**chessy copper**; same as chessylite.

**chessylite**; a common, commercial term used in France and elsewhere for azurite found at Chessy, near Lyons. Also called chessy copper. → Azurite.

**chesterlite**; a microcline feldspar from Chester County, Penna, USA.

**chestnut jade**; a descriptive Chinese term for a specific color quality of jade.

**chevee**; in North America, a term for a type of flat, carved, cameo gemstone made of hematite, with a polished, concave depression. If a raised, carved figure is in the center of a bowl-shaped depression, it is called cuvette, curvette. Also spelled chevet.

**chevet**; same as chevee.

**chevill**; same as chevü.

**chevron**; a simple style of ornament consisting of short stripes meeting at an angle worn on the sleeve.

**cheveron cast**; same as herringbone texture

**cheveron mark**; same as herringbone texture

**cheveron pattern**; same as herringbone texture

**chevü**; a Sri Lankan (Ceylonese), unit of weight, which is equal to 21.84 cts. Also spelled chevill, chow and called tank and chow.

**chevü**; a Sri Lankan term, used for pearls of superior quality, including ani, masaka, kaiyéral, and anitári. → manchandi.

**Chhatrapati Manick Ruby**; the fine, cabochon cut ruby of gem quality, from India, weighing nearly 40 cts.

**Chhatrapati Manick Ruby**; same as Peace Ruby.

**chi**; a Chinese term for an ornamental cap carved from jade. → Chinese ritual and symbol jades.

**ch'iano-tiao**; a Chinese term used to a kind of carving of opaque root amber of various mixed brown shades from Myanmar (Burma), this naturally swirled amber carved as ornaments but utilizing the stone swirls, which means clever carving or ingenious carving.

**Chiapas amber**; → Mexican amber.

**chiastolite**; an opaque variety of andalusite containing



*cross section of chiastolite a variety of andalusite*

black carbonaceous impurities, which occur in four-sided fusiform crystals. The stone usually has a definite

pattern along the longer axis of crystal, resembles a black Maltese cross. It has long been used for amulets, charms, and other inexpensive, novelty jewelry. It is a curio stone. Found in Santiago de Compostela, (Spain), Siberia, (Russia), California, (USA), Myanmar, Zimbabwe, and Australia. Also called cross-stone, crucite, macle. An obsolete term for chiastolite is stealite.

**Chibcha stone**; (named for an Indian tribe), rounded emerald pebbles, found near Muzo Mine, North-West Bogota, Colombian. → Somondoco emerald, Muzo Mine, Chivor emerald.

**Chicago Aquamarine**; a cut aquamarine of 137.00 cts, from USA. Now on display at Chicago field Museum of Natural History.

**Chicapa River**; location of alluvial diamond deposits in northeastern Angola, Africa.

**Chi Ku Pai jade**; Chinese spelling for chicken bone jade.

**Ch'ien Lung (Emperor)**; a period style of carving from China, which represents perhaps, the highest level of skill in the long history of jade sculpting.

**Ch'iong Yü**; a Chinese term for gem quality red jade.

**chicken bone jade**; a Chinese term for a type of jade, (sometimes nephrite), that is converted by heating, (or burning up to 1025 °C), to a yellowish-white, opaque color, which may show a crackled surface and small patches. The Chinese spelling is: Chi Ku Pai jade. → Tomb jade, burnt jade.

**chicken bone jade**; a Chinese term for whitish opaque jade which may be distinguish from burial jade or heat-treated jade.

**chicken tracks**; a term applied to small marking growth features occur on some terminal faces of a crystal and most of these pattern are pedion faces.

**chicken-wire**; a term applied to a peculiar structure can be seen in synthetic opal similar a chicken-wire or snake-skin, sometimes showing a columnar honeycomb outlook.

**chicot pearl**; an alternative term for blister pearl.

**chidder**; in Australian a term for a slate mixed with pyrite. Used as cladding and ornamental stone.

**Chief of Carlisle Diamond**; the octahedron diamond of 13.50 cts, found in 1966 at Murfreesboro, Arkansas.

**chiffre cut**; a cut similar to the rose cut, with a three-faceted, shield-shaped roses and a flat, unfaceted base.

**chihuahua geodes**; geodes from the Sierra Callego in Chihuahua, Mexico, which have been incrustated in a wall of chalcedony. The interior walls are studded with megacrystalline amethyst or smoky quartz.

**childernite**; an isomorph with the mineral eosphorite. It is rarely fashioned into gems.

System: orthorhombic.

Formula:  $8[(\text{Fe},\text{Mn})\text{AlPO}_4(\text{OH})_2 \cdot \text{H}_2\text{O}]$ .

Luster: vitreous to resinous.

Color: pale-yellowish to dark brown.

Streak: colorless.

Diaphaneity: transparent to translucent.

Cleavage: {100} poor.

Fracture: conchoidal to uneven.

SG: 3.20-3.25.

H: 5.

Optics:  $\alpha$ :1.630-1.645,  $\beta$ :1.650-1.680,  $\gamma$ :1.660-1.685.

Birefringence: 0.030-0.040.  $\ominus$ .

Found in Cornwall, England, Minas-Gerais, Brazil, Germany, and South Dakota, USA.

**childernite absorption spectrum:** absorption spectrum lines at 410 and 490 nm.

**childernite pleochroism:** yellow, pink, pale pink to colorless.

**Chilean lapis;** a local term for a pale to light blue lapis lazuli from Chile. These contain veins of a white matrix, and are often spotted green, white or gray.

**chi lin;** a Chinese term used for unicorn carved on jade. → Chinese ritual and symbol jades.

**chilong;** a Chinese term for dragon, carved from jade. → Chinese ritual and symbol jades.

**chimaltizal;** an Aztec term for selenite.

**chimney;** a neck or pipe through which magma reaches the Earth's surface such as Kimberly pipe

**chimney;** a vertical shaft in the roof of a cave.

**china;** an unglazed or glazed, vitreous ceramic, from China.

**chin;** a Chinese term for jade.

**china clay;** a trade term for kaolin.

**China diamond;** → China,-People Republic of.

**Chinaman's-hat;** an informal term used by Australian miners for flat knobby, a minute pointed end of a solid cone shape similar to Chinese hat. Also called Chinese-hat, teat.

**china metal;** same as porcelain.

**china opal;** common opal, resembling white porcelain from China.

**China pearl;** a fresh-water pearl from China. Rarely called an oriental pearl.

**China pearl;** a pearl with two drilled holes for setting or mountaineering with a pin or screw. Also called Chinese pearl. → Chinese drilling (pearls).

**China, Peoples Republic of;** some alluvial diamonds of good quality are found in Shanyung province. Synthetic diamonds for industrial use are also being produced.

**China stone;** a descriptive term for white, cherty limestone of carboniferous age, from Derbyshire. Sometimes contains white mica and fluorite. Also called Manx stone.

**China stone;** a fusible aluminum silicate, which is used

as a component of porcelain. Also called petuntse.

**Chinaman pebble;** a New Zealand term for a boulder made from a conglomeration of quartz pebbles, cemented by chalcedony.

**chinarump;** same as petrified wood in southwestern USA. Also spelled shinarump.

**Chinaware;** a description of porcelain.

**chine;** same as barranca.

**Chinese aeroplane;** a term used for impure inclusions in moonstone, which can be seen as an aeroplane or a pseudo-insect or a centipede.

**Chinese amber;** amber mined in Myanmar, (Burma), and marketed in China.

**Chinese amber;** often applied incorrectly in Germany to pressed Baltic amber or bakelite.

**Chinese amber;** a misleading term for amber-colored plastics.

**Chinese amber imitation;** reportedly Chinese made imitation amber by boiling chicken with the fat of a fish with dark color.

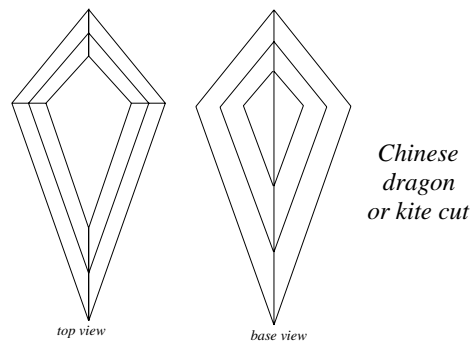
**Chinese blue;** a blue glaze for of ceramics, (pottery), ranging from sky-blue to grayish-blue, used by the Chinese and the Persians. Impure cobalt compounds are used as colorants. Also called Mohammedan blue.

**Chinese cat's-eye;** a misleading term for operculum, shell cat's-eye or cat's-eye shell.

**Chinese Coromandel Room-Divider Screen;** → appliqué work.

**Chinese cultured pearls;** technique of cultured pearl was tried in China in the 1000 BC by inserting Buddha figure made of lead or bronze, pellets of mother-of-pearl from pearl oyster, or other objects into a fresh-water mussel. Buddha figures used as dress ornaments.

**Chinese dragon-cut;** a four-sided trap-cut (lozenge cut) stone having an outline of a child's kite, that two



touched sides of the table are longer than the other two sides. Also called kite cut.

**Chinese drilling (pearls);** a method of drilling drop or button-shaped pearls, across the top or toward the back of the pearl. These pearls are cheaper than usual drilled pearls. → China pearl.

**Chinese fresh-water mussel;** this fresh-water mussel from rivers in China, is from the *Cristaria plicata* genus. the Chinese have made use of these mollusks for a long time by inserting objects made of mother-of-pearl, and particularly, metal figures of Buddha, between the shell and the mantle.

**Chinese-hat;** same as Chainman's-hat, teat.

**Chinese jade;** a synonym for Turkistan jade.

**Chinese jade;** a misleading term for green aventurine quartz, resembled jade.

**Chinese jade;** a misleading term for true jadeite a variety of jade carved in China, but found in Myanmar.

**Chinese jade;** a misleading term for antigorite, resembling jade. The Chinese term for true jade is *chen yü*.

**Chinese imitation pearl;** → imitation pearl.

**Chinese jade;** a misleading term for true jadeite a variety of jade carved in China, but found in Myanmar. The Chinese term for true jade is *chen yü*.

**Chinese jade;** a misleading term for antigorite, resembling jade.

**Chinese nephrite;** → Chinese jade.

**Chinese oil;** a chemical term for cassia oil.

**Chinese pearl;** same as china pearl.

**Chinese ritual and symbol jades;** some pieces of ritual carved jade have persisted into our time such as (a) *pi* that is a flat disc with a hole in the center made of a blue-green stone to symbolize the heaven which was placed under the body in tomb. (b) *Ts'ung* an open cylindrical hollow vase ? (or tube) whose outer surface is in form of square cross section to symbolize the Earth with yellow color which was placed on the chest of the body in tomb. (c) *Hu* that is a pattern similar to tiger with white color to symbolize the metal. (d) *Chang* that is similar to a rod tapered at one end with red color to symbolize the fire. (e) *Kuei* that is a flat blade-shaped, which is normally tapered of green color at one end to symbolize the wood. (f) *Huang* that may be semi-circular looked like half a pi with the black color to symbolize the water. (g) *Swastika* that is a Buddhism emblem to symbolize to decorate Buddha and his heart. (h) *Yin-yang* that is a circular pattern of cosmology combines interacts with their opposites carved on jade to symbolize to produce everything, which comes into existence or principle of opposites (moon and sun) with the five elements. (i) *Pa kua* that is a that is a circular pattern with eight sets in such an order that each symbol is an inverse of the opposite emblematic figure to symbolize to produce everything, which comes into existence, or principle of opposites with the five elements. (j) *Ten* celestial stems. (k) *Twelve* terrestrial branches or twelve signs of zodiac. (l) *T'ao t'ieh* that is a monster design with two big

round eyes carved on jade. (m) *Lung* mean dragon, which represents different cosmic forces, carved on jade. (n) *Feng huang* mean phoenix carved on jade. (o) *Chi lin* means unicorn carved on jade. (p) *Shen kwei* mean tortoise carved on jade. (q) Carving of *animals* and *plants* are as religion symbols are ever-present. Small carving of animals was used as tomb pieces as guardian symbols, (r) *fu-i* mean bat with the symbol of happiness. (s) *Han Hsiang* a human symbol carved as a musician-plying flute. (t) *Chang Li* a human symbol carved on jade as a leader of eight immortals dwelt on the mountains with fungus a symbol of immortality. (u) *Chang Kuo-Lao* a human symbol carved on jade as a magician often with a monkey and carrying a bamboo tube drum named as *yu ku*. (v) *Ho Hsien-Ku* a woman symbol carved on jade with a stem of lotus flower as a immortality sign. (w) *Lu Tung-Pin* a human symbol carved on jade as a older man with a sword and doer stick in hand functioned as protector of magicians. (x) *Lan Ts'ai-Ho* a human symbol carved on jade as a dressed woman (uncertain she or he) carrying flower basket and singing songs of immortality. (y) *Ts'ao Kuo-Chin* a human symbol carved on jade as a patron with cap, beard and fine dress always with a castanets instrument in hand, it is a recent immortal figure. (z) *Li T'ieh-Kuai* a human sign carved on jade as a crippled beggar carrying a scepter to symbolize immortality for the rest of his earthy life. (aa) *Shakyamuni* a human sign carved on jade as a category of the Lord Buddha figures with beard, big ears and in meditation sitting. (bb) *Ananda* a Buddha figure carved on jade as Teacher and discipline. (cc) *Lohans* a Buddha figure carved on jade as Buddhist saints. (dd) *Maitreya* a Laughing Buddha figure carved on jade. (ee) *Kuan Yin* a common popular Buddhist female figure carved on jade is one of the Bodhisattvas which may represent asexual reincarnation of future is calling Buddha Avalokitesvara meaning compassionate Buddha. (ff) *Samantabhadra* another Bodhisattvas figure sitting on the back of an elephant carved on jade. (gg) *Minjusri* another Bodhisattvas figure sitting on the back of a lion carved on jade. (hh) *kuang* that is an open ewer or bowls or sometimes covered carved on jade. (ii) *ku* that is a vase with an open end carved on jade. (jj) *ting* that is a four-legged casket carved on jade. (kk) *ju-i* that is a scepter carved on jade. (ll) *lien* that is a cylindrical scroll holder carved on jade. → Nephrite colors in Chinese.

**Chinese ruby;** a misleading term for a heat-treated quartz crystal, which turn color to purplish-red, and is used as a gem or an imitation gem.

**Chinese silver;** an alloy used as a silver imitation consisting of 58% copper, 17% zinc, 11.5% cobalt, 11% nickel, and 2% silver.

**Chinese tourmaline;** a misleading term for tourmaline, from California and other sources, fashioned as gems in China.

**Chinese turquoise;** a misleading term used for turquoise-colored jasper.

**Chinese turquoise;** a misnomer for a mixture of soapstone, (steatite), calcite and quartz, which is dyed blue.

**Chinese writing;** a term used by Australian miners for pattern showing more or less similar to Chinese symbols.

**Ching Peh;** a Chinese term for golden amber from Thailand, which has sherry or gold color.

**chink-faceted pebble;** a term applied to often sharply limited facets of the surface of beach pebbles.

**chinolite;** → quinoline.

**chinoiserie;** a generic French name for ornaments made to resemble fanciful, Chinese imagery, such as pseudo-Chinese figures, pagodas, landscape, etc.

**chiolite;** a colorless, white, sodium aluminum fluorite mineral. Chemical formula:  $2[5\text{NaF} \cdot 3\text{AlF}_3]$ . Tetragonal crystal. Vitreous luster. Transparent to translucent. Optics;  $\omega$ :1.345,  $\epsilon$ :1.342. Birefringence: 0.003.  $\ominus$ . SG:2.99. H:3½-4. Found in the Urals, Russia.

**Ching Peh;** Chinese term for golden amber.

**Chio-Naio;** a Chinese term for opaque, dark yellow amber, which means bird's brain.

**chip;** a sorting category denoting cleavage of rough diamonds under ¾ cts.

**chip;** an irregularly shaped piece, broken from a gemstone or diamond.

**chip;** a minute, rose-cut diamond or single-cut *mêlée*, or one cut irregularly.

**chip;** a curved break blemish on a diamonds surface edge, which may occur due to breakage.

**chip;** a surface on a gemstone or diamond from which a chip has been broken.

**chip;** a small fragment or piece of a substance.

**chip diamond;** → chip.

**chipped;** have been broken from the body of the diamond.

**chipped culet;** a culet of a fashioned stone that has been damaged or broken. → Abraded culet.

**chipping;** small fragments breaking away from a diamond stone.

**chipping;** removing surface defects in metal surface with chisel or gouge or by machine before further processing.

**chipping;** setting diamond fragments in a bit.

**chips;** small fragments or pieces of a substance removed from a medium.

**chips;** broken-off small fragments or pieces of opal,

used to make cheap jewels.

**chip up or snide;** a term used by Australian miners for a rough opal by which the edges of stone be pare to ascertain quality degree by faceting or rubbing down. Also called snip.

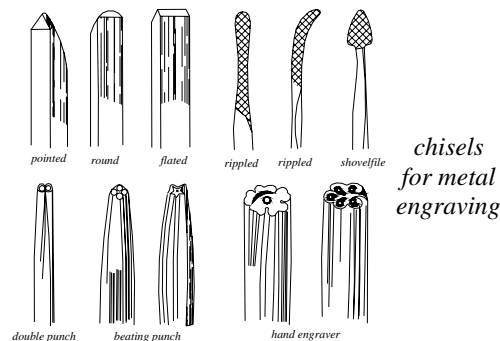
**chip up;** same as snip.

**Chique Chique Diamond;** same as Carbonado Xique-Xique Diamond.

**chir;** a term used in India for streak like inclusion in emeralds.

**chiral nematic;** → liquid crystal

**chisel;** a hand cutting instrument of great variety for working on the surface of various gems or other



materials by chipping, carving, turning, etc., consisting of a flat steel blade with a sharpened cutting edge at one end attached to a handle made of wood, metal or plastic.

**chisel;** same as to cut, engrave, pare, gouge, to shape with a chisel.

**chisel-pick;** a term used in Australian for a small opal miner's pick with chisel points at both ends.

**chisel-worker;** same as stonemason.

**chispa;** Spanish spelling for chip.

**chispas;** a Spanish term means sparks, which used by Colombian miners for small piece of emerald to cut.

**Chiumbe River;** an alluvial diamond deposit in northeastern Angola, Africa.

**chiung;** a Chinese term for cinnabar red nephrite. → Nephrite colors in Chinese, Chinese ritual and symbol jades.

**Chivor emerald;** an ancient emerald mine in Columbia. Used as a trade term, Chivor refers to a more bluish, less velvety and less intensity colored emerald than a Muzo emerald. → Somondoco emerald, Muzo Mine, Chibcha stone.

**Chivor Mine;** an ancient and important emerald mine in Colombian, South America.

**chkalovite;** a sodium beryllium silicate  $[\text{Na}_2\text{Be}(\text{SiO}_3)_2]$ . Orthorhombic system. Semitransparent. White color. Vitreous luster. SG:2.66. H:6. Found in Russia.

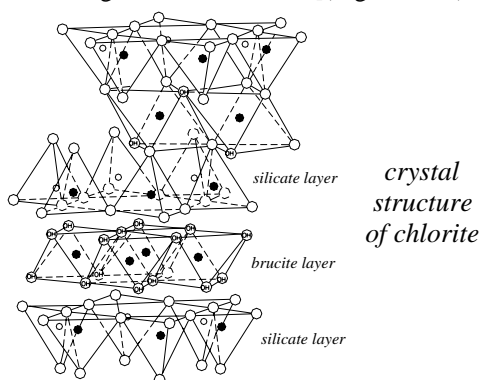
**chlorapatite;** a pink-white to pale yellow, transparent to

translucent apatite, in which chlorine predominates over fluorine and hydroxyl. Monoclinic system. Vitreous to chalky luster. SG:3.10-3.20. H:5. Chemical formula:  $2[\text{Ca}_5(\text{PO}_4)_3(\text{Cl},\text{F},\text{OH})]$ .

**chloraastrolite**; an opaque, fibrous, molted, light bluish-green rock with a silky luster consisting mainly of pumpellyite. Formula:  $4[\text{Ca}_2\text{MgAl}_2(\text{OH})_2(\text{Si}_2\text{O}_7)(\text{SiO}_4)]$ . Occurs in grains or small nodules, and as a radial fibrous structure in geodes found in basic igneous rocks. It is related to prehnite. cut cabochon, these minerals resembles a miniature tortoise shell. Orthorhombic system. Optics;  $\alpha$ :1.674-1.702,  $\beta$ :1.675-1.715,  $\gamma$ :1.688-1.722. Dispersion is moderate. Birefringence: 0.017.  $\ominus$  or  $\oplus$ . SG:3.2-3.5. H:5-6. When cut cabochon, it exhibits chatoyancy. Used as a gemstone, it is cut cabochon and exhibits a star-like effect. Found along the coast of Lake Superior, USA. Also misleadingly called green stone, Lake Superior greenstone. There is a green variety with patches of another color known as *turtle back*.

**chlorine**; a greenish-yellow, pungent, poisonous, corrosive, nonmetallic, univalent element, in group VIIA of the Periodic System, with the symbol Cl. Soluble in water. Belonging to halogens.

**chlorite**; a mineral of the hydroxyl phyllosilicate group, with the general formula:  $4[(\text{Mg},\text{Fe}^{+2},\text{Fe}^{+3})_6\text{AlSi}_3\text{O}_{10}$



$(\text{OH})_8]$ . Monoclinic system. SG: 2.65-2.94. H:1.5-2.5.  $\beta \approx 1.580-1.685$ . An alteration product of biotite, and hornblende, it occurs in many rock types.

**chlorite**; an inclusion in quartz, which gives a green mossy-like color to the quartz.

**chlorite as inclusions**; chlorite inclusions in the form of needles occur in quartz, emerald, etc.

**chlorite quartz**; an inclusion in quartz, which gives it a green mossy-like color.

**chlorophyll**; an organic important porphyrin with basic  $\text{C}_{55}\text{H}_{72}\text{MgN}_4\text{O}_5$ , a natural green-blue wax pigment essential to photosynthesis, has a pyrrole rings (nonbenzenoid), with a central metal ion nearly similar structure to hemin. Soluble in ether, ethanol, acetone,

chloroform, benzene, and methanol. Chlorophyll used in several industries as dyes. → Porphyrin.

**chloromelanite**; a gem quality, dark green, nearly black variety of jadeite. Colored by iron oxide. Part of it may be ureyite, which is also dark in color. SG:3.25. H:6 ½-7. It may be in the form of a smaragdite. → Maw-sit-sit.

**chloromelanite**; a term used for intermediate between chloromelanite and acmite a variety of aegirine.

**chloromelanite (jade)**; a gem quality, dark green, nearly black variety of jadeite. Colored by highly contain iron oxide. SG:3.25. H:6 ½-7. Possibly a form of smaragdite. → Maw-sit-sit.

**chloromelanite (jade)**; a misleading term for gem quality green diopside resembling the jade.

**chloromelanite (jade)**; a term used for jadeite with iron content.

**chloromelanite (jade)**; a misleading term for gem quality of green diopside resembled the jade.

**chloropal**; a green, opal-like, hydrous silicate of iron or nontronite.

**chloropal**; a green, common opal from Silesia, Poland. Also called pinguite.

**chlorophaeite**; a mineral closely related to chlorite. It is dark-green, but quickly changes color to brown. SG:2.02. H:1.5-2.0.

**chlorophane**; a variety of fluorite, which emits a bright-green light, or fluorescence when light heated.

**chlorospinel**; a grass-green gem variety spinel, the color of which is due to the presence of iron oxide. Also called iron-magnesium spinel.  $8[\text{Mg}(\text{Al},\text{Fe})_2\text{O}_4]$ . Found in Russia.

**chlor-utahlite**; a green variety of utahlite. Same as utahlite and variscite.

**choaspites**; a variety of golden beryl, or chrysoberyl found near Choaspes River, Iran (Persia).

**choghondar**; → salaki.

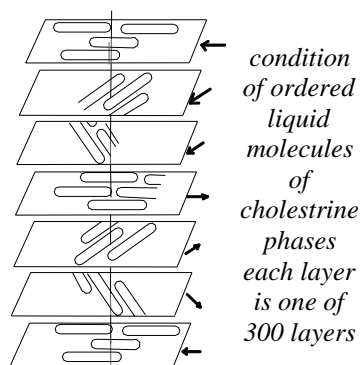
**choker**; a standard length necklace, made of short, narrow beads or pearls of the same size. About 35-36 cm or 14 inches in length, it is worn close to the throat, frequently with a suspended pendant. It is sold as a matinee, or opera, and rope. → Opera length

**cholesteric liquid crystal**; entire the molecules are straight but arranged in distinct layers. Also called chiral nematic. → Liquid crystal.

**choncholin**; same as conchiolin.

**chondrite**; a type of stony meteorite, consisting of nodule-like aggregates of pyroxene or olivine minerals. Suitable for collectors.

**chondrodite**; a transparent to translucent, yellow, red, brown mineral of the humite group. It occurs in contact-metamorphosed dolomites. Synonym for condrodite. Monoclinic system. Chemical formula:



$2[(Mg,Fe)_5 Si_2O_8(F,OH)_2]$ . Cleavage: {100} indistinct. Fracture: uneven to subconchoidal. Brittle. Optics;  $\alpha$ :1.604,  $\beta$ :1.614,  $\gamma$ :1.634. Birefringence: 0.030.  $\oplus$ . SG:3.16-3.26. H:6-6½. Found in Italy, Finland, USA, and Sweden. Cut as gems for collectors. It is pleochroitic.

**chondronite**; a deep red, garnetlike stone, found in the USA. It is similar to peridot.

**chorlo**; a Spanish term for tourmaline.

**choroid**; the highly vascular part or layer of eye acting as a protective layer between sclera and retina. → Eye.

**Chou Kung**; believed originally to have come from Chou Kung about, 1100 BC, mainly jade carvings have been found and are significant as symbols.

**chow**; a Hindu or Sri Lankan unit of weight for pearls. Also called chevvü or Tank.

**christol**; an obsolete term for mother-of-pearl, used for inlays.

**Christiana**; location of a small alluvial diamond deposits in South Africa.

**Christlijke Belgische Diamantbewerkerbond**; an organization of diamond workers, in Belgium.

**christolite**; another spelling for cristobalite.

**chrisolitus**; tenth stone at Jewish High Priest Breastplate. → Breastplate.

**Christopher Black Diamond**; the black brilliant-cut diamond of 58.10 cts. Details of prior its history are lacking. Last sold by Harry Winston in 1969.

**christophite**; an iron-rich variety of sphalerite. Same as marmatite.

**chroma**; color chroma is the saturation of a color, or how pure the color is. Intensity of color. → Color,-definition.

**chromatic**; of, or pertaining to, colors or wavelength.

**chromatic aberration**; in crystal optics, the defect of a lens or a mirror to light rays in the same focus, which causes different points for different colors. → Aberration.

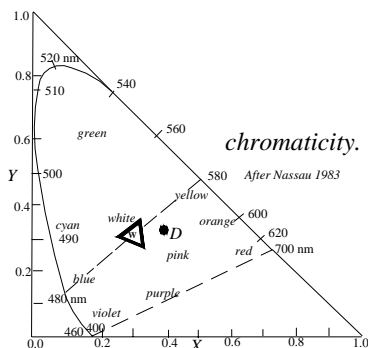
**chromatic adaptation**; an optic term used for changeability in coloration in association to the amount

of light reaching color receptors. Also called successive brightness contrast.

**chromatic color**; a more formal term for color. Color hues, as distinguished from white, black or any tone of gray.

**chromatic diagram**; → chromaticity diagram.

**chromaticity**; in optic the numbers which are represent primary color quality of light in a color sample, which



can be shown in a triangular graph with the name chromaticity diagram.

**chromaticity diagram**; a triangular chart that exhibits specific chromaticity coordination. The apexes of diagram represent primary colors. Also known as chromatic diagram. → chromaticity.

**chromatic mineral**; colored mineral.

**chromaventurine**; an incorrect term for green glass, containing chromic oxide.

**chromdiopside**; → chrome diopside.

**chromdravite**; a green to black magnesium and chromium-rich variety of tourmaline. Trigonal system. Chemical formula:  $3[NaMg_3Cr_6(Si_6O_{18})(BO_3)_3(OH)_4]$ . Optics;  $\omega$ :1.778,  $\epsilon$ :1.772.  $\ominus$ . → Tourmaline.

**chrome**; element chromium.

**chrome**; to dye or to treat with the compound of chromium.

**chrome**; chromium pigment color.

**chrome**; in technical dyeing, the chromate of potassium or sodium.

**chrome**; a term applied to indicate green color saturation.

**chrome antigorite**; antigorite containing chromic oxide.

**chrome chalcidony**; a green variety of chalcidony from Zimbabwe, which contains chrome oxide. It is sometimes confused in association with chrysoprase. Chrome chalcidony appears red under the Chelsea filter, while chrysoprase appears green. It has a sharp, one-band spectrum in the red zone. Also called mtorodite, or mtorolite.

**chrome chert**; a green variety of chert, which has replaced the silicate minerals of chromite diopside.

**chrome diopside**; a transparent, bright to dark-green

gemstone variety of diopside, which contains chromium. Found in association with diamonds in the blue ground of the Kimberley diamond mines of South Africa and in Myanmar. Those from Myanmar shows cat's-eye effect, when cut cabochon. Also spelled chromdiopside.

**chrome diopside cat's-eye;** → chrome diopside.

**chrome enstatite;** a transparent to opaque, pale to dark-green gemstone variety of diopside, which contains chromium.

**chrome epidote;** a green variety of epidote, containing chromic oxide, found in Upper Myanmar, (Burma), and Zimbabwe. It shows chatoyancy, when cut cabochon. Also called tawmawite. Sometimes spelled chrome-epidote.

**chrome garnet;** another term for uvarovite garnet.

**chrome green;** a series of pigments, which are mixed with precipitate of chrome yellow and iron blue. Used as a polishing agent. RI:2.50.

**chrome green;** a dark green, amorphous powder of  $\text{Cr}_2\text{O}_3$ , which forms hexagonal crystals on heating, which are insoluble in water or acids. Often mixed with cobalt oxide. Used as pigment for color ceramics and glass. Also called chromic oxide, chrome oxide, chromium oxide. Sometimes called viridian or veridian.

**chrome hercynite;** → hercynite.

**chrome idocrase;** an emerald-green, chromium-bearing variety of vesuvianite. Used as a gemstone. Also called chrome-vesuvian.

**chrome iron ore;** same as chromite.

**chrome iron;** same as chromite.

**chrome ironstone;** same as chromite.

**chrome jade;** a misnomer for chrome-bearing variety of epidote found in Tawmaw Burma with the common name tawmawite.

**chrome jadeite;** a chromium-bearing, green jadeite tawmawite or Maw-sit-sit from Myanmar, (Burma).

**chrome kyanite;** a green, chromium-rich variety of kyanite found in Sakha, the Russian Federation, CIS.

**chrome mica;** another term for fuchsite.

**chrome oxide;** same as chrome green.

**chrome pyrope;** pyrope with more than 8.3% chromium oxide.

**chrome spinel;** a transparent to opaque, chromium-bearing, dark-green to dark-brown variety of spinel. Also called picotite. Sometimes used as a synonym for magnesiochromite.

**chrome tourmaline;** a transparent, emerald-green gemstone variety of tourmaline, containing chromium oxide. Found in Tanzania, associated with green emerald and grossular garnet.

**chrome-vesuvian;** same as chrome idocrase.

**chrome yellow;** same as crocoite.

**chromia;** same as chromium oxide.

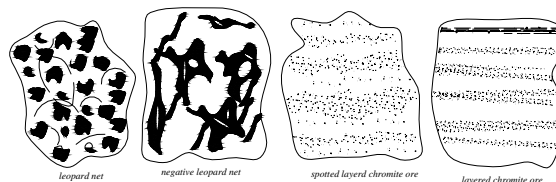
**chromic;** of, or pertaining to chromium oxide in the trivalent state  $\text{Cr}_2\text{O}_3$ .

**chromic iron;** same as chromite.

**chromic oxide;** same as chrome green, chromium oxide.

**chromiferous;** of, or pertaining to chromium.

**chromite;** an opaque, iron-black to brownish member of spinel group. Sometimes shows a magnetic effect. Rarely fashioned but it is prized by collectors. Also



*disturbition of chromite in ultrabasic magmatite.*

*After Schneiderhoehn 1961*

called chrome iron ore, chromium iron, chrome iron, chrome ironstone or chromic iron.

System: cubic.

Formula:  $8[\text{FeCr}_2\text{O}_4]$ .

Luster: metallic.

Colors: black to reddish or brown.

Streak: brown.

Diaphaneity: opaque.

Cleavage: none.

Fracture: uneven. Brittle.

SG: 4.50-4.80.

H:  $5\frac{1}{2}$ .

RI: 2.08-2.16.

Found in Turkey, Zimbabwe, Russia, Norway, Cuba, India, France, and California, USA.

**chromite as inclusions;** chromite as inclusions are seen in peridot, emerald, garnets, etc.

**chromium;** a grayish-white, hard, brittle, non-corrosive metallic element in the Group VIB of the Periodic System, obtained from chromite. One of the eight metallic elements, mainly responsible for green or red color in very important gem minerals such as emerald, ruby, spinel, pyrope garnet, demantoid garnet, jadeite, purple topaz, synthetic minerals, glasses, etc. Chemical symbol: Cr. Used to plate articles of costume jewelry, and for enamel decoration as it resists corrosion. It is a constituent of stainless steel.

**chromium coloration;** → chromium.

**chromium garnet;** same as uvarovite.

**chromium oxide;** the very hard, green abrasive powder,  $\text{Cr}_2\text{O}_3$ . Hexagonal system. Used as a polishing and pigment agent for gemstones, glasses, glazes, and enamels. Also called green rouge, and green chrome,



chromium sesquioxide, chromia, green cinnabar or chromic oxide.

**chromium spectrum;** the presence of chromium in gemstones such as natural or synthetic corundum-ruby is shown by 3 narrow lines in the blue at 468.5, 476.5 and 475 nm, 2 in the red at 692.8, 694.2 nm and 2 weaker lines in the orange at 659.2 and 668 nm. The element chromium enters the crystal lattice of a gemstone, when aluminum is present in its compound, to replace it.

**chromocratic;** an obsolete term for dark-colored igneous rock. Same as melanocratic.

**chromogen;** a term applied to a color producing or colored compound, which containing chromosphere.

**chromosphere;** a pinkish colored gaseous layer of the sun's atmosphere, which is responsible for the fine-line absorption spectrum. It is due to hydrogen and can be seen in natural daylight. Also called color bearing. → Fraunhofer lines.

**chromophores;** a structural feature in a group of atoms, in a chemical compound for the color of that compound which is a major factor in selective absorption and in color because of presence of electron configuration of the ions in a crystal lattice, such as transition metal ions may occupying several different coordination sites. Or may occupation of oxidation of transition metals caused for absorption such as ferrous iron ( $\text{Fe}^{2+}$ ) or ferric iron ( $\text{Fe}^{3+}$ ), the ferrous caused in peridot green color and ferric yellow color in chrysoberyl. This color effect has important use in heat-treatment gemstones such as blue color in heat-treated sapphire. Some minerals are colored by transition elements, which are major and essential ingredient, and substances are colored by small amount of transitional element as impurity. Best method to distinguish is to examine the color of powder, which in mineralogy called as *streak-test* by rubbing the mineral across a porous ceramic plate. Generally most colors caused by impurities are not saturated and mostly are not seen in the powder or streak. Most idiochromatic compounds have their own colors, are saturated, and are not seen in the powder or streak. Also called self-colored, dopants, activators, chromophores, colorbearing. → Idiochromatic minerals, Coloring agent.

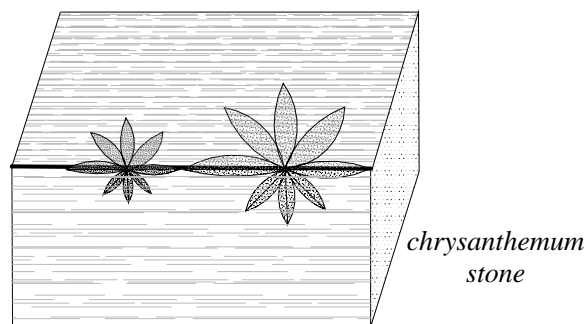
**chron;** a small time unit indicating when a rock was formed.

**Chronology;** events or forming of a rock in its proper sequence in time.

**chronozones;** in stratigraphy, a classification of time, in the sense of *age zone*. A time unit indicating when rocks were formed, anywhere during the geologic time span.

**chrysanthemum;** a skeleton-shaped inclusion of ilmenite in aquamarine.

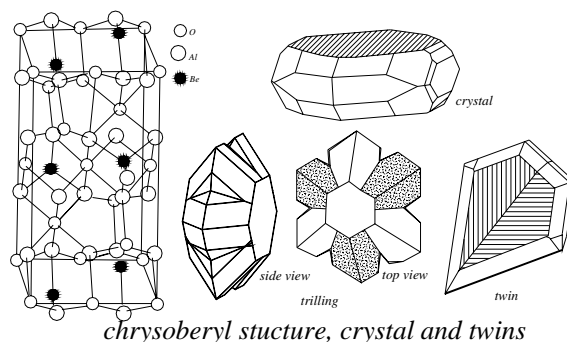
**chrysanthemum stone;** a term applied in Japan to a basaltic rock, containing a flower-like crystal of xenotime and zircon. The Japanese word is *Kiku-ishi*,



which probably means chrysanthemum stone. Used as an ornamental stone. Found in Maru Yama, (Japan), and Vancouver (Canada).

**chryselephantine;** a term applied to objects of art, made with or overlaid with gold and ivory.

**chrysoberyl;** a hard, important gem mineral, of which *alexandrite* and *cymophane* are two varieties. Occasionally a greenish chatoyancy can be seen which was formerly known as *cymophane*, but is now called *chrysoberyl cat's-eye*, or *oriental cat's-eye*, when cut en cabochon. Frequently *star chrysoberyls* are found. Some crystals are twinned as trillings, called *flowers* or *cyclic twins*, which appear in a pseudo-hexagonal symmetrical form. Alexandrite is an emerald green variety in daylight, which alters in color to red under artificial light. Chrysoberyl or alexandrite is a trichroic crystal. Synthetic chrysoberyl has been made by



different techniques, such as floating-zone and flux, Czochralski or the pulling method. Imitation alexandrite is a misleading term for synthetic spinel or corundum or sapphire, with the property of changing color, which, like alexandrite is reddish-green in daylight and reddish under artificial light. Such stones were at first mislabeled as *scientific alexandrite*. Imitations are also made, from glass such as the *cathay cat's-eye* or *cathay stone* and the *Victoria cat's-eye*, which is two types of glass chrysoberyl imitations.

Also, other glass imitations are made, like the rock crystal doublet, composed of two pieces of quartz crystal with a dyed gelatin filter as cement. Imitation cat's-eye is produced from quartz cat's-eye, tourmaline cat's-eye, prehnite cat's-eye or bleached tiger's-eye. Erroneously, yellow chrysoberyl is known as *chrysolite chrysoberyl*. Transparent stones are faceted in a mixed cut, cloudy or chatoyant stones are cut en cabochon, and usually of a mixed cut. Also called chrysochal. Gold beryl. → Synthetic chrysoberyl, vanadium in synthetic corundum, cathay cat's-eye. Strong pleochroism.

System: orthorhombic.

Formula:  $4 [\text{BeAl}_2\text{O}_4]$ . Frequently contain Cr.

Luster: vitreous.

Colors: yellowish, yellowish-green, gray, brown, blue-green, and emerald green, rarely colorless.

Streak: colorless.

Diaphaneity: transparent to translucent.

Cleavage: {110} distinct, {010} imperfect, and {001} indistinct.

Fracture: conchoidal to uneven. Brittle.

SG: 3.75-3.85.

H: 8½.

Optics:  $\alpha$ : 1.740-1.759,  $\beta$ : 1.747-1.764,  $\gamma$ : 1.745-1.770.

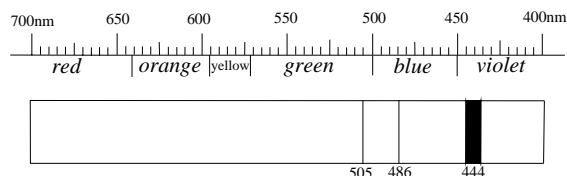
Birefringence: 0.009-0.012. ⊕ may also be ⊖.

Dispersion: 0.015.

Found in Sri Lanka, Ural, Brazil, Zimbabwe, Zaire, Finland, USA, Malagasy, Myanmar, and China.

**chrysoberyl**; an obsolete term for heliodor.

**chrysoberyl absorption spectrum**; iron-rich brown and yellow chrysoberyl has a band at 444 nm, and



*chrysoberyl absorption spectrum*

sometimes may be at 504 and 486 nm.

**chrysoberyl, as an inclusions**; chrysoberyl inclusions can be seen in emeralds from Zambia, Africa.

**chrysoberyl as medicine**; the use of gemstones, minerals, rocks, fossils, etc is very old and gemstone were used as homeopathic medicine such as chrysoberyl powder cures liver weakness when taken in water.

**chrysoberyl cat's-eye**; same as cymophane or Oriental cat's-eye.

**chrysoberyl cut**; alexandrite, a yellow variety of

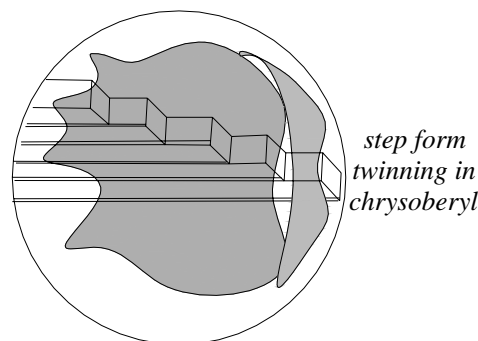
chrysoberyls, is fashioned as mixed cut, the crown is in the form of a brilliant, and the pavilion in a trap cut. To obtain a cats'-eye, chrysoberyl must be cut en cabochon in the right direction.

**chrysoberyl, inclusions in**; chrysoberyl has fine, needle-like inclusions, which cause a cloudy internal appearance and, when cut en cabochon show a cat's-eye effects. Other inclusions are bubbles of two phases, and the peculiar feature of *stepped twins*. Goethite needles, apatite, quartz, mica, and needles of actinolite can be seen as inclusions.

**chrysoberyl luminescence**; weakly red fluorescence be seen in alexandrite under SWUV and LWUV, chrysoberyl from Connecticut, USA show pale Yellow-green under SWUV.

**chrysoberyl pleochroism**; strong in alexandrite: dark red, orange-yellow and green. In chrysoberyl: shades of yellow and brown.

**chrysoberyl twinning**; a common repeated twinning (penetration trilling), especially in the alexandrite



*step form twinning in chrysoberyl*

variety, causes a stellate appearance and the simulation of hexagonal symmetry. Frequently an inclusion known as a *stepped twin can be seen*.

**chrysoberyl, X-ray transparency**; chrysoberyl is translucent under X-rays .

**chrysoberyllus**; a term rarely used for chrysoberyl.

**chrysoberyllus**; an old term used for golden beryl.

**chrysoberyllus**; a confusing or misleading term for a greenish-yellow beryl, from the USA.

**chrysoberyllus foiling**; a method of improving or altering the color, brilliancy, or both of chrysoberyl by backing with foil. → Foil, foil back.

**chrysoarmen**; a red to brown copper-bearing, ornamental stone from Mexico sometimes containing light and dark blue, or green spots of azurite and malachite.

**chrysocolla**; a massive, soft, amorphous to cryptocrystalline hydrous silicate of copper. Often impregnating quartz or chalcedony, this is cut in its matrix. It is cut cabochon. Sometimes called mountain green. The *Eilat stone*, is an opaque, green mixture of

chrysocolla, turquoise and pseudo-malachite. Used for soldering gold. Also called mountain blue (obsolete), mountain green.

System: monoclinic. Cryptocrystalline.

Formula:  $(\text{Cu},\text{Al})_2\text{H}_2\text{Si}_2\text{O}_5(\text{OH})_4 \cdot n\text{H}_2\text{O}$ . May vary.

Luster: vitreous to earthy or waxy.

Colors: various shade of blue, blue-green or green.

Streak: greenish-white.

Diaphaneity: translucent to opaque.

Cleavage: none.

Fracture: conchoidal to uneven. Very brittle.

SG: 2.00- 2.20.

H: 2-4.

Optics;  $\alpha$ : 1.580,  $\beta$ : 1.597,  $\gamma$ : 1.598-1.635.  $\ominus$ .

Birefringence: 0.023-0.040.

Found in Utah, Nevada, and Arizona (USA), Chile, Russia, Congo, and Zaire.

**chrysocolla**; an old term given to a mineral or group of minerals, such as malachite, borax, and chrysocolla.

**chrysocolla cut**; usually tumbled and cut cabochon, frequently as the matrix, when it is embedded in quartz.

**chrysocolla chalcedony**; a translucent to opaque, vivid-blue to greenish-blue chalcedony, colored by impregnation with chrysocolla. → Chrysocolla quartz.

**chrysocolla opal**; a translucent to opaque, light blue to greenish-blue opal, colored by impregnating of chrysocolla. Found in Mexico.

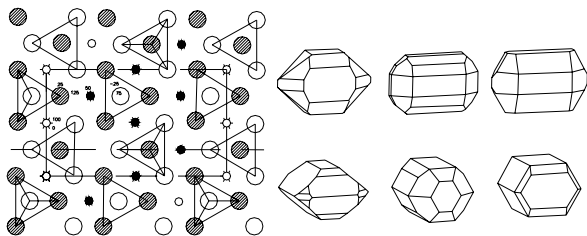
**chrysocolla quartz**; a tough, translucent chalcedony, colored by disseminated, fine particles of chrysocolla.

Found in Mexico, Arizona and New Mexico (USA). Same as azurlite, azurchalcedony, and blue chrysoprase. → Chrysocolla chalcedony.

**chrysdor**; a commercial term for a green and white stone with markings similar to marble.

**chrysojasper**; a jasper, colored by chrysocolla.

**chrysolite**; an ancient term for greenish-yellow gem variety of olivine or peridot. At one time for many years, sinhalite was mistakenly known as brown peridot or brown chrysolite. The name is misapplied to many



structure and crystals of chrysolite or olivine

other stones such as, *Bohemian chrysolite*, *water chrysolite*, *false chrysolite*, *pseudo-chrysolite* that is

moldavite glass. *Brazilian chrysolite* is a tourmaline or pale green chrysoberyl. *Ceylon chrysolite* is a chrysoberyl. Saxony chrysolite is a greenish-yellow topaz. *Siberian chrysolite* and *Siberian olivine* or *Uralian chrysolite*, are demantoid garnets. *Evening emerald* is a chrysolite. *Cape chrysolite* is a prehnite. *Oriental chrysolite* is a chrysoberyl or a sapphire. *Opalescent chrysolite* is a chrysoberyl. *Schiller chrysolite* is a chrysoberyl. *Chrysolite chrysoberyl* is an aquamarine. *Aquamarine chrysolite* is a greenish-yellow beryl.

System: orthorhombic.

Formula:  $4[(\text{Mg},\text{Fe})_2\text{SiO}_4]$ .

Luster: vitreous to greasy.

Colors: green, light-green, lemon, yellow.

Streak: colorless.

Diaphaneity: transparent to translucent.

Cleavage: {010} imperfect and {100} imperfect.

Fracture: conchoidal to uneven. Brittle.

SG: 3.33-3.53.

H: 7.

Optics;  $\alpha$ : 1.654,  $\beta$ : 1.650-1.690,  $\gamma$ : 1.689.

Birefringence: 0.033.  $\oplus$ .

Dispersion: 0.020.

Found on the Island of Zebirget, or St. John's Island in the Red Sea, Myanmar, Brazil, Norway, Greenland, Congo, Arizona, Mexico, and Australia.

**chrysolite**; sometimes incorrectly applied to chrysoberyl of a golden yellow color, to topaz, prehnite and apatite.

**chrysolite asbestos**; a fibrous variety of serpentine mined at Cassiar, British Columbia in this serpentine matrix is found jade also nephrite.

**chrysolite absorption**; chrysolite has bands at 493, 453 and 653 nm and sometimes may be at 529nm.

**chrysolite aquamarine**; an incorrect term for greenish-yellow beryl.

**chrysolite beryl**; an incorrect name for greenish-yellow to light yellow-green beryl.

**chrysolite cat's-eye**; a misleading term for chrysoberyl cat's-eye.

**chrysolite chrysoberyl**; an incorrect name for light greenish-yellow to light yellow-green chrysoberyl.

**chrysolite du Brésil**; a French term for beryl from Brazil.

**chrysolite pleochroism**: weakly: colorless to pale green, green and light green.

**chrysolite peridot**; same as chrysolite, a variety of olivine, or peridot.

**chrysolite sapphire**; a misleading term for a light, yellow-green sapphire.

**chrysolite spinel**; an incorrect name for a light greenish-yellow, to light yellow-green spinel.

**chrysolite topaz**; a misleading term for light, greenish-

yellow to light, yellowish-green topaz. Also called Saxony topaz or Saxon topaz.

**chrysolite water;** a misleading term for moldavite.

**chrysolithos;** a term used as equivalent to tarshish a biblical term for the tenth stone in the breastplate of the High Priest. The word tarshish means golden stone. It was translated and generally believed to be chrysolite, topaz, citrine quartz, and also yellow jasper. Engraved with the name Naphthali.

**chrysolithus;** a misleading term for pale, yellowish-green or golden beryl.

**chrysoopal;** a translucent variety of common opal, colored apple-green by nickel. Also called prase opal. Found in Silesia, Poland.

**chrysoopal;** synonym for chrysoberyl.

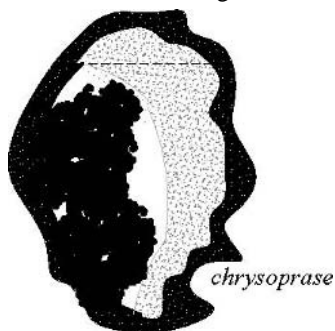
**chrysoopal;** a trade term for opalescent chrysolite (olivine).

**chrysoprased;** a misleading term for translucent, artificially dyed, bright green (colored by nickel), chalcedony, to distinguish it from other similar green minerals, such as *green onyx*. May resemble fine quality jade. A misspelling of chrysoprase or a misleading name, proposed by those who intended to imply that green-dyed chalcedony was chrysoprase. Found in Russia, Australia, Brazil, and the USA.

**chrysophytic;** applied to a basalt, containing phenocrysts of olivine.

**chrysopilon;** a term rarely used for pale golden beryl.

**chrysoprase;** an attractive, translucent variety of chalcedony, colored apple-green by nickel silicate and valued as a gem, cut as beads, and cabochon, frequently used for cameos and for intaglios. Found in Silesia,



(Poland), Ural (Russia), Minas Gerais, (Brazil), Australia, Oregon and Tulare County, California, (USA) and Kenya, (Africa).

**chrysoprase;** a misleading term for dyed chromium green chalcedony or quartz, having a darker color than natural chrysoprase, which is called mtorolite. Found in Zimbabwe, Africa. It can be distinguished by a sharp, single band absorption band in the red part of the spectrum.

**chrysoprase colored onyx;** a misleading term for green

onyx.

**chrysoprase colored onyx;** a misleading term for dyed green chalcedony, which is not an onyx.

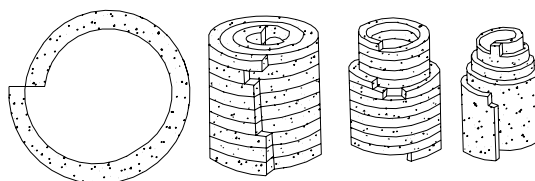
**chrysoprase matrix;** chrysoprase with a considerable amount of white or brown inclusions.

**chrysoprasius;** a term may formerly used for beryl.

**chrysoprasus;** an obsolete spelling of chrysoprase.

**chrysoquartz;** a green aventurine quartz.

**chrysotile;** a highly fibrous, silky variety, (one of the three monoclinic and orthorhombic varieties), of



*spiral-cylindrical concentric layers structure of chrysotile and cross section.* After Grimm, R.E. 1962, 1968

serpentine, which constitutes an important type of asbestos. Synonyms: clinochrysotile and serpentine asbestos. Also sometimes called Canadian asbestos. The basic variety is known as  $\gamma$ -chrysotile, or ishkyldite.

System: monoclinic.

Formula:  $2[\text{Mg}_6\text{Si}_4\text{O}_{10}(\text{OH})_8]$ .

Luster: silky, sometimes greasy.

Streak: colorless.

Colors: white, gray, yellow, green, brownish.

Cleavage: one direction.

Diaphaneity: translucent to opaque.

SG: 2.55.

H:  $2\frac{1}{2}$ .

Optics;  $\alpha$ : 1.540-1.549,  $\beta$ : ?,  $\gamma$ : 1.545-1.556.

Birefringence: 0.016.  $\ominus$ .

Found in California, New York, New Jersey (USA), Russia, Zimbabwe, Italy, and South Africa.

**chrysotile asbestos;** a fibrous variety of serpentine.

**chrysotolon;** same as silicon carbide.

**chui;** a Chinese term for an awl-shaped medallion carved from jade. → Chinese ritual and symbol jades.

**Chuimbo River;** a river in Angola, Africa.

**chum;** an informal term used by Australian miners to an area having many newcomers, therefore with little organization or control.

**Chung Kuo-Lao (jade);** a style of carved image of a fat, half-naked little man with a beard, usually a fan and a peach, or fungus. It is a Chinese symbol of immortality.

**Chung-li Ch'uan (jade);** a carved image of a famous Chinese magician, often carved riding a donkey, frequently backward. He always carries a Yü Yü, a kind

of tabular drum.

**chunum**; a Sri Lankan, (Ceylonese), term for a unit of weight of gold.

**Chuquicamata**; location of a turquoise deposit in northern Chile.

**churning**; the action, process, or effect of certain machines that tumble gems.

**chute, à la, necklace**; a style graduated of pearl necklace a single strand, about 42 cm long.

**Ch'uti**; a Chinese term meaning out of the earth. Jade of various colors, is dyed by oxides to all colors due to a long reburial period in the earth.

**chytha**; a Chinese trade term for an olive-green to yellow variety of jadeite or antigorite-serpentine with chemical formula  $\text{NaAl}(\text{Si}_2\text{O}_6)\cdot\text{MgOH}_4$ . Found in china.

**ciamita**; Spanish for tourmaline.

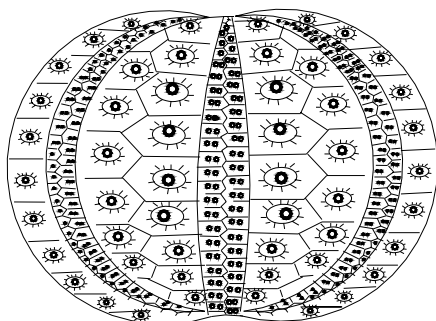
**cianita**; Spanish for citrine.

**CIBJO**; an acronym for the French Organization: Confédération Internationale de la Bijouterie, Joaillerie, et Orfèverie des Diamants, Perles et Pierres. Founded in Paris in 1961. An international confederation of the jewelry and silverware trades.

**CIBJO International Clarity**; a clarity or purity scale for diamonds, beginning with loupe clean (LC), VVS, VS, SI, ending with three-grade piqué.

**CIBJO International Color-grading Scale**; color grading scale for diamonds, beginning with colorless to light yellow, light brown, and light gray.

**cidaridae**; a genus of the sea urchins, primitive echinoderms in the subclass Persichoechinoidea



*cidaridae*

including all recent members of the cidaroida family, which found in different forms and widely distributed in warm waters.

**CIE**; an acronym for Commission Internationale de l'Eclairage. An international body, which specifies the standards for illumination, color, measurements and color description.

**CIE Chromaticity Chart**; a trichromatic system of color notations used as a color chart for chromaticity coordination (x,y) derived from red/green/violet hues

(X.Y.Z).

**CIE Coordinates**; Commission International l'Eclairage. An international body, which specifies the standards for illumination, color, measurements and color description.

**cigarette smoke**; a term used to faint curved growth striae seen in synthetic Inamori rubies by using of immersion observation and shadowing from different directions, with color swirl which resemble the cigarette smoke and running across the striae.

**cilia**; a term used sometimes for microscopic feather-like structure, which covered the respiratory organs of invertebrates or water-breathing animals such as bivalve mollusk.

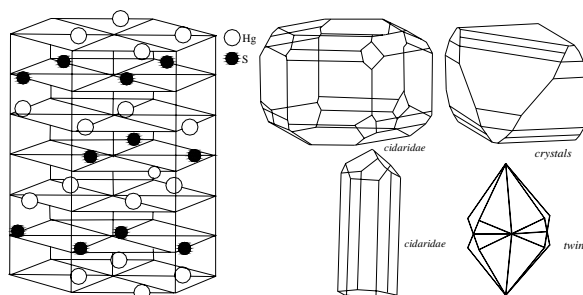
**cilia**; → gills of oyster.

**cimfano**; the Spanish and Portugesian word for chrysoberyl cat's-eye.

**Cincora**; location of a very important alluvial diamond deposit in Bahia, Brazil.

**cinder wool**; same as mineral wool.

**cinnabar**; the transparent crystals are used in China as a coloring agent for red lacquer, they are rarely faceted as



*cinnabar structure, crystals and twin*

gems or cut cabochon. Also used as a coloring agent in the production of imitation coral. Often occurring as red impurities in different gemstones. Synonyms are: cinnabarite and vermillion.

System: monoclinic.

Formula:  $3[(\text{HgS})]$ .

Luster: adamantine to submetallic, dull, earthy.

Color: scarlet, brilliant red to brownish red, or gray.

Streak: scarlet red to brown.

Diaphaneity: transparent to translucent.

Cleavage: {1010} perfect.

Fracture: conchoidal to uneven. Brittle to sectile.

SG: 8.00-8.20.

H: 2-2½.

Optics;  $\omega$ :2.905,  $\epsilon$ :3.256.

Birefringence: 0.351. ⊕.

Dispersion: 0.040.

Found in Peru, Mexico, Spain, China, Germany, Italy, Nevada, California, Texas, and Arkansas (USA).

**cinnabar as inclusions;** it occurs as inclusions in chalcedony, giving it a vivid pink or bright red colors.

**cinnabar matrix;** a term applied to a special variety of jasper from Mexico, containing numerous inclusions of cinnabar.

**cinnabar matrix;** quartz crystal containing numerous inclusions of red cinnabar.

**cinnabarite;** same as cinnabar.

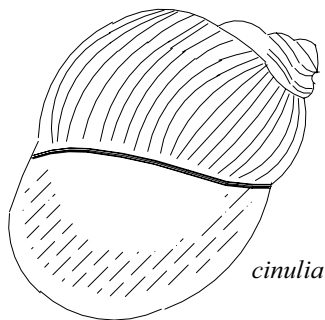
**cinnamic aldehyde;** same as carbon disulfide, used in spectroscopy.

**cinnamite;** same as cinnamon stone.

**Cinnamon Century Diamond;** the walnut brown, pear-shaped diamond of 32.16 cts.

**cinnamon stone;** a yellow-brown to reddish-brown variety of hessonite or grossular or hyacinth garnet from Sri Lanka, which color matched that of the oil of cinnamon. Also called cinnamite.

**cinulia;** a kind of pearl bearing cephalopod fitted with



striated curved bowl hinged on the top of the front of a blade.

**cipolin;** synonym for cipolino.

**cipolino;** a misleading term for a metamorphic marble, rock rich in silicate materials, having alternating white and green, finely parallel layers, rich in mica. Found on the Greek island of Euboea, and in Italy. Synonym for cipolin or cipolino marble. Also spelled cipollino, cipolin.

**cipolino marble;** same as cipolino.

**cipollino;** → cipolino.

**circle agate;** a term applied to agate with circular markings.

**circle of light;** trade term for a diamond with a polished girdle.

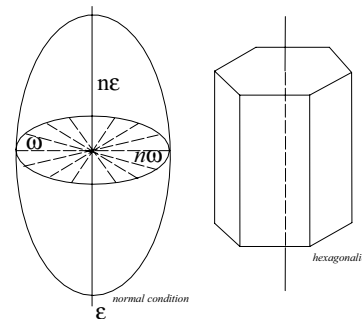
**circlet;** a type of crown, worn as a head ornament, in the form of a circle, ornamented with gemstones.

**circone;** an Italian term for zircon.

**circular polarization;** in optics a property peculiar to quartz, among other gem minerals. The rotation plane of polarization of a ray of light, when passed parallel to the optic axis, shows an interference figure in convergent polarized light. The arms do not meet at the center: the four arms stop at the innermost ring. This is

caused by the interaction of mutually perpendicular, wave motions, whose path differences in phase by  $(2n + \frac{1}{4}\lambda)$  when emerging from the crystal. Crystals displaying it are known as having optically active. Also called rotatory polarization. → Polarization of light.

**circular section;** a circular section can be seen in



*a circular section of an uniaxial crystal with two different refractive indices,  $n$   $\omega$  and  $n\epsilon$*

biaxial indicatrix of a positive crystal which lies between XZ section (or  $\alpha\gamma$  axis) with the radii proportion to the intermediate index Y ( $\beta$  axis). All radii of this section are circular equal to  $\beta$ .

**cire perdue;** a method used in metal casting, which consists of forming a wax model. → Lost-wax casting.

**ciro pearl;** a misleading term, used for an imitation pearl.

**cirolite;** a trade term for yttrium aluminate garnet (YAG).

**ciselé;** a method of decoration of metal, which includes both chasing and engraving.

**Cissie Patterson Necklace;** a diamond necklace with more than 400 cts. weighing stones. In the center of these necklace is mounted a flawless, colorless, 22 cts, cushion-shaped diamond. It belonged to Mrs. Patterson, former owner of the Washington Times Herald.

**cistern rock;** same as laccolith.

**citiekuang;** a Chinese term for magnetite ( $Fe_3O_4$ ).

**C'itraka;** a Sanskrit term used in past in India for defect grading of sapphire. → Sapphire, defects of in Hindu.

**citrine;** any transparent golden-yellow, pale-yellow, yellow, yellow-brown, reddish-brown variety of quartz closely resembling topaz in color also known as topaz-quartz. Yellow color caused by presence of  $Fe^{+3}$ . It can be produced by heating amethyst or smoky quartz, it has been sold under such erroneously names as *topaz*, *Spanish topaz*, *Saxon topaz*, *Madeira topaz*, *Bohemian topaz*, *Brazilian topaz*, *Indian topaz*, and *Madagascar topaz*. It probably owes its color to a trace of iron oxide. Natural citrine crystal always shows dichroism, which is absent in heated yellow quartz. It is one of the *birthstones* for November. Found in Brazil, Malagasy, etc. Synonym for false topaz, yellow quartz, citrine quartz, quartz topaz, jeweler's topaz, jeweler's topaz-

quartz, Colorado topaz. → Quartz, Scottish topaz.

**citrine**; a term applied to citrine-color, or lemon-colored.

**citrine quartz**; same as citrine.

**citrine, synthetic**; → synthetic citrine.

**City of Gems**; a popular and misleading name for Ratnapua, Sri Lanka.

**C.I. vat blue 4**; same as anthraquinone.

**C-jade**; a semi-acronym for colored jade.

**Cl**; a chemical symbol for the element chlorine.

**cladding stone**; same as building stone.

**claim**; a formal request is made to acquire public land for mining purpose.

**clam**; a term applied to any bivalve mollusk of the genera *mya*, *venus*, etc, which lives partially or completely buried in sand or mud.

**clam**; often used incorrectly for fresh-water mussels, in which pearls are found, such as in Mississippi basin.

**clammer**; one who fishes for the fresh-water pearls and its mussel.

**clamp**; → claw setting.

**clam pearl**; a variety of salt-water pearl, non-nacreous, and not fine-quality obtained from oysters and clams such as the hard *clam* or *quahog*, *giant clam* and *coconut pearl*. Colored in purplish red or blue, and almost black. SG:2.20-2.66.

**clam pearl**; misleadingly a term applied to pearl from fresh-water mussel.

**chladnite**; a synonym for enstatite, occurring in meteorite.

**clarification of amber**; the rough cloudy amber can be clarified by boiling completely immersed in colza oil or rape-seed oil (oil of the nearly same refractive index such as rapeseed oil 1.475 in yellow color) in an iron vessel very slowly or in fat of pig. Here the bubbles air which caused cloudy appearance will filled with oil, amber appears transparent because the light passing through the stone without interferences. Cloudy amber, which has been clarified in heated colza oil or rape oil sometimes show some crack-like marks that resemble the nasturtium leaves and are known as sun-spangled amber.

**clarified amber**; any cloudy amber, which has been clarified by heating in rape-seed oil.

**clarity**; a classification term used in the grading of polished gems or diamonds depends on the included particles, cracks, features, etc. and the surface blemishes. Most diamonds contain some minute imperfect inclusions, which were formed by nature.

**clarity**; the term clarity is similarly used in the sorting of rough diamonds and also called purity, clarity grade. Also called cleanliness.

**clarity**; a visual quantity of suspended opaque solids in a

liquid.

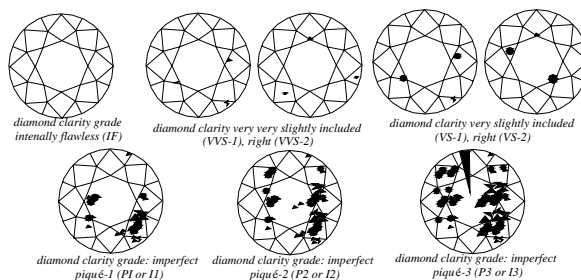
**clarity characteristic**; a term used by retail sales for blemishes and inclusions in gemstones.

**clarity characteristic**; internal and external blemishes of a stone been expressed by the number, color, size, position, and clarity grade of the stone.

**clarity enhancement**; any process to improve the apparent clarity of a gemstone, such as the filling of cavities or fractures with other substances such as resin, glass, etc.

**clarity grade**; → clarity, clarity grading.

**clarity grading**; the classification of fashioned gemstones or diamonds according to their clarity using the standard nomenclature of terms: flawless, pure, clean, perfect (for top grade). VVS, VS, SI, and piqué.



#### clarity grades and their symbols

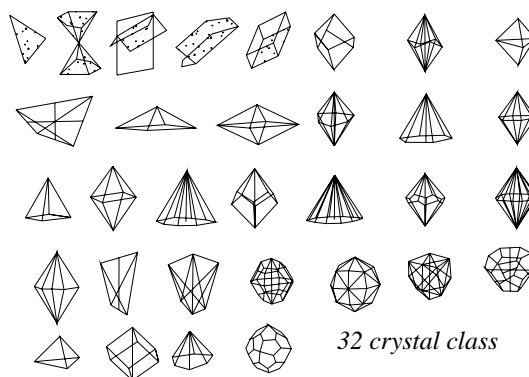
Lower grades are called *spotted*, or *rejections*. The grades from flawless to piqué must be examined through a lens. The term *clean* is restricted in the USA.

**clarity-grading System**; → clarity, clarity grading.

**class 1**; a term used by Australian miners for opal or other precious stone with high grade.

**class 2**; a term used by Australian miners for opal of firsts, seconds and thirds grade quality.

**class (crystal)**; one of the 32 possible types of symmetry. Crystal classes are divided among the six crystal systems: cubic, tetragonal, hexagonal,



orthorhombic, monoclinic, and triclinic. Also called classification of crystals, crystal class.

**classification of coral**; → coral, classification of.

**classification of crystals;** same as class (crystal).

**classification of gemstones;** classification of gems based on the same classification as minerals. A descriptive category is the *name* of gems (natural, or synthetic, inorganic or organic). A basic category of gems are *species*, mostly of these are minerals, which mean a class of gems with particular chemical and physical properties (usually a crystallographic structure), which distinguish them from others, and within which may be numerous, for example corundum is a mineral species, In organic gem species are seen pearl, coral, amber, jet, ivory and shell. Species are divided into *varieties*. Varieties are based on color, color distribution, diaphaneity, and optical properties. Corundum is a gem mineral species of  $Al_2O_3$ , the red to purplish-red variety is called ruby, the blue variety is known as sapphire and all other colors are named as fancy sapphire. Chalcedony is fine-grained variety of quartz, when it has quasi parallel black and white banding named as onyx, whereas the bands are curved and angular known as agate. The translucent reddish chalcedony is termed as carnelian. A fine-grained, reddish and nearly opaque variety of quartz named jasper. Some optical effect of gems such as *asterism* is classified as variety for example a sapphire with star effect is known as star sapphire variety. Sometimes found the term *group*, which means two or more chemically related gem mineral species with the same structure and physical properties such as feldspars group or garnets group.

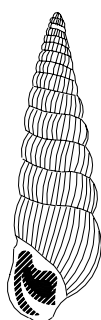
**classification of inclusions;** → inclusions.

**clastic rocks;** a sedimentary rock composed of fragments of pre-existing rocks. Composed of fragments. Also called fragmental rock.

**clastation;** same as weathering.

**clatersal;** a Dutch term for small diamond splint or cleavage, from which diamond powder is made by crushing.

**clausilia;** a kind of cephalopod fitted with striated



*clausilia*

curved bowl hinged on the top of the front of a blade.

**claw;** same as prong.

**claw setting;** a type of mounting of a gem in a finger

ring, in which the gemstone is set and secured in a prong above the girdle or at its edge.

**clay;** an old term used by Australian miners for clay shale contains opal, but now the word is replaced by dirt.

**clay-boulder;** → clay-boulders.

**clay-boulders;** a term used by Australian miners for mud-boulders, which is found in opal dirt and lies under the mother sandstone in boulder area with good opals.

**clay ironstone;** a compact, hard, dark-brown or gray brown, layered or concretionary mass of argillaceous siderite and limonite sedimentary rock associated with carbonates strata. Sometimes has been cut.

**clay minerals;** finely crystalline, layer-structure, plastic properties, hydrous magnesium or aluminum silicate with general formula of  $Al_2O_3 \cdot 2SiO_2 \cdot 2H_2O$ , which occur as minute platy, more rarely fibrous crystals. The most common clay minerals belong to the kaolin, montmorillonite, vermiculite, palygorskite, and illite groups. Also called clay, hydrosialite.

**clayey;** same as argillaceous.

**clean;** a term applied to a diamond or to other gemstones that are free from noticeable inclusion by diamonds or interior flaws by gemstones. It must be examined by 10x magnifier.

**clean;** sometimes the word pure is used as a synonym.

**clean;** free of foreign material such as sand and gravel are without binder.

**clean;** a term used by Australian miners for well-formed, hard roof or band over the opal dirt.

**cleaning;** cleaning of gemstone and jewels by means of ultrasonic device.

**cleaning, gemstones;** all stones must be carefully cleaned before they are examined.

**cleanliness;** same as clarity.

**clean-skin;** a term used by Australian miners for an opal in a nobby, which may found in old mine.

**clear;** a term used by Australian miners for opal not of dark or black variety found in layer of sandstone or shale.

**clear;** a term used by Australian miners for lightest type of potch, which is generally heavier than opal.

**clear amber;** a German commercial name for transparent amber takes a high polish. Also used as faceted beads.

**claet spar;** → ankerite.

**cleavability;** a mineral can be easily cleaved or splitting property.

**cleavable;** a mineral capable of being cleaved.

**cleavage;** splitting property. A term in gemology for act of producing a break.

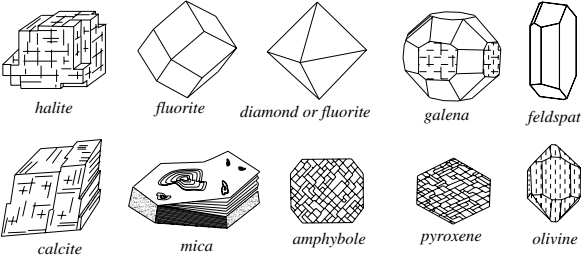
**cleavage;** the term applied to diamond crystals, which



require cleaving before being fashioned.

**cleavage:** a name for a diamond crystal showing many flaws.

**cleavage:** in mineralogy meaning the tendency possessed by many minerals being that they are rather

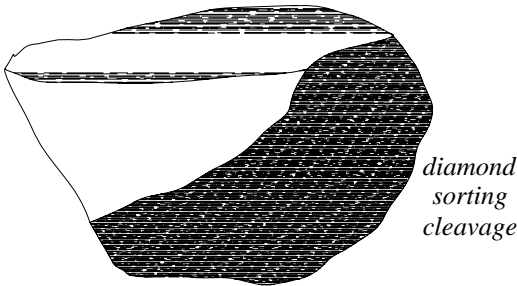


cleavage of different kinds of minerals

easily divided or cleaved along or parallel to one or more certain plane of weak molecular bonding. Different crystals have different cleavage directions, which depend upon molecular bonding such as diamonds cleaved parallel to the octahedron faces. Cleavage is important in measuring the process of cleaving. In Farsi (Persian) *rakh* or *tabarзад* cited by *Al-Biruni*. → *Rekha*.

**cleavage:** one of the portions of a stone resulting from such a break in large size is known as a cleavage mass.

**cleavage:** broken diamond crystals above one carat, of



suitable thickness.

**cleavage:** a misshapen diamond crystal such as one of that is flat and rather elongated.

**cleavage:** a term used by CSO in classification of rough diamonds for a medium-sized cleavage weighing more than 1.80 cts.

**cleavage crack;** a clean and regular cleavage, which may manifest in any surface chips or as incipient cleavage cracks, it exhibiting a smooth reflective surface between atomic planes of a mineral, and along a cleavage direction. → *Gles*.

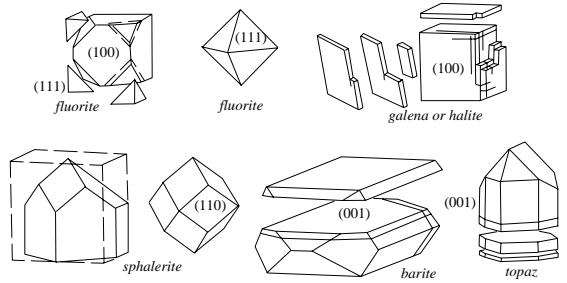
**cleavage face;** the term applied to a crystal with smooth surface produced by cleavage, such as mica. In case of mica, the cleavage face may be almost a plane surface.

→ Crystal face.

**cleavage, false;** same as parting.

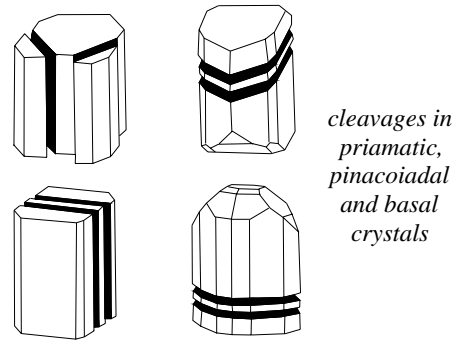
**cleavage fragment;** a small parting of a crystal that is bounded by cleavage faces.

**cleavage in crystals;** the property of a crystal break along its crystallographic planes, thus reflecting crystal



cleavage of different crystals

structure. Cleavage planes are always parallel to a possible crystal face of the mineral in question.

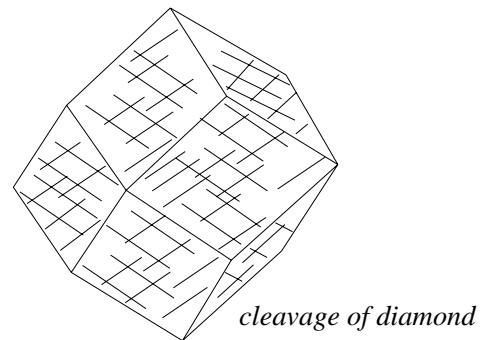


**cleavage in diamond;** same as cleavage of diamond.

**cleavage mass;** a term applied by diamond cutters to refer to the large portion of diamond produced by the cleaving work.

**cleavage of calcite;** → Cleavage in crystals.

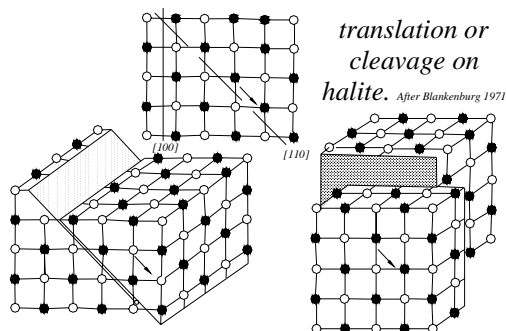
**cleavage of diamond;** the diamond has a strong tendency at the cleavage to octahedral surface of the



natural crystal. In trade, the cleavage planes are known as *grain* of a diamond. Also called cleavage in diamond. → Cleavage in crystals.

**cleavage of fluorite;** fluorite has a perfect octahedral plane cleavage, which may manifest in any surface chips or as incipient cleavage cracks. → Cleavage in crystals.

**cleavage of halite;** the halite has a {001} perfect cleavage parallel to the faces of the crystal. Translation



surface is (110). → Cleavage in crystals.

**cleavage of topaz;** the topaz has a strong tendency to cleavage parallel to the base of the crystal. → Cleavage in crystals.

**cleavage quality;** a cleavage is described by its quality, which is expressed as perfect, good, imperfect, poor, etc.

**cleavages;** an irrespective sorting classification of shape of rough diamonds, which may weigh over 2 cts. These irregular broken fragments of diamonds are: chips, m $\acute{e}$ l $\acute{e}$ e, macle, shape, stone, and cleavage.

**cleavelandite;** a gem variety of white albite feldspar from brazil with a lamellar structure.

**cleaver;** the craftsman who separated the diamond by the use of the cleavage planes.

**cleaver's blade;** a wedge shaped blade used by cleaver for cleaving diamonds. Also called cleaver's knife.

**cleaver's knife;** same as cleaver's blade.

**cleaver's mallet;** a rounded wooden hammer, which is used to strike the cleaver's blade to cleave a diamond.

**cleaver's stick;** a holder for the diamonds to dig the kerf or groove for preparation of the cleavage operation. → Dop.

**cleaver's wedge;** → cleaver's blade.

**cleaving;** the technique of splitting or parting of a rough diamond crystal into two or more portions along the cleavage plane (four cleavage planes parallel to the octahedral faces), used in fashioning of diamond but rarely in other gemstones. Cleaving produced pieces, which are of sizes or shape, which may be of better quality and more economically. The procedure involves: (a) studying of those stone that should be divided. (b) Marking on the stone, with ink or ink marker. (c) Fastening or cementing the stone on a dop-stick or in a dop. (d) Grooving a minute V-shaped notch or kerf on the stone. (e) Putting the blunt slide in

the groove and giving it an abrupt break or sharp blow, thus participle dividing the stone.

**cleaving diamond;** the diamond crystal, which requires separation before being fashioned, equal with any diamond containing flaws.

**cleft;** a V-shaped part, abrupt break, cut, chasm, split, fissure, or past tense or a past participle of cleavage in a stone.

**cleftstone;** same as flagstone.

**cleiophane;** a colorless to light green variety of sphalerite. Found in New Jersey, USA.

**Cleopatra emerald mines;** emerald from ancient Egypt mines in the hillside of Jebel Sikait, Jebel Zubara in northern Etbai, near the Red Sea. → Egyptian emerald.

**Cleopatra Pearls;** reportedly two pearls worn as earrings by Cleopatra. One of these was dropped and dissolved in vinegar (which is literally impossible, because vinegar is too weak an acid). Reportedly, the other was bisected in the ears of the statue of Venus in the Pantheon at Rome.

**Cleopatra turquoise imitation;** → Gilson-synthetic turquoise.

**Clerici's solution;** a mixture of thallium malonate,  $\text{CH}_2(\text{COOTl})_2$ , and thallium format,  $\text{HCOOTl}$  in water, which is a clear liquid with a slightly amber tint. Used as a heavy solution for the separation of gems, SG:4.15 at 20 $^\circ$  C. Sometimes thallium carbonate ( $\text{Tl}_2\text{CO}_3$ ) is used and mixed with malonic acid and formic acid in water. It is poisonous and should be used with reasonable care.

**Cleveden;** location of a small alluvial diamond mines in cape Province, South Africa.

**Cleveland Diamond;** a rough diamond of 100.00 cts, after 128-facet cushion-shaped weight 50.00 cts. Named after Grover Cleveland twenty second president of USA.

**cliffstone;** a hard chalk found in England and used in paint.

**clifftonite;** a term applied to polycrystalline mass of graphite pseudomorphous after diamond.

**Clinch River Diamond;** a diamond of 3 cts, found in 1889 on Clinch River, Tennessee, USA.

**clinc-stone;** same as phonolite.

**clinker;** pyroclastic rock particles fused together, which resemble the clinker of a furnace.

**clinkstone;** same as phonolite.

**clinoaxis;** the diagonal or lateral axis in the monoclinic crystal system, designated *a*.

**clinocllore;** a yellowish-green, green to olive-green sometimes purplish variety of k $\ddot{a}$ mmererite of chlorite group. A flexible mineral of chemical formula of  $4[(\text{Mg},\text{Fe})_5\text{Al}(\text{Si}_3\text{Al})\text{O}_{10}(\text{OH})_8]$ . Monoclinic system.

Transparent to translucent. Vitreous to greasy luster. Cleavage: {001} perfect. Optics;  $\alpha$ :1.578-1.670,  $\beta$ :1.580-1.685,  $\gamma$ :1.586-1.685. Birefringence: 0.002-0.006.  $\oplus$  or  $\ominus$ . SG:2.65-2.70. H:2-2½. Found in Russia, Switzerland, Austria, Japan, and New Zealand.

**clinochrysotile**; a synonym for chrysotile. The term used to denote its monoclinic system.

**clinohumite**; a rare, yellow brown-white mineral. It is prized by collectors. Transparent to translucent. Chemical formula:  $2[\text{Mg}(\text{OH},\text{F})_2.4\text{Mg}_2(\text{SiO}_4)]$ . Monoclinic crystal. Vitreous luster. Fracture: uneven to subconchoidal. Brittle. Cleavage: {100} indistinct. Optics;  $\alpha$ :1.629-1.638,  $\beta$ :1.652-1.643,  $\gamma$ :1.662-1.674. Birefringence: 0.024-0.037.  $\oplus$ . SG:3.15-3.21. H:6-6½. Orange-yellow fluorescence. Found in Russia, California (USA), Canada, Greenland, Switzerland, Spain and Japan.

**clinopyroxene**; a collective term for any monoclinic mineral of pyroxene group.

**clinovarsicite**; the term is used to denote the monoclinic system of variscite.

**clinozoisite**; an iron-rich (but ca. 10% less than epidote), grayish-white, pink or light green mineral of the epidote group. Chemical formula:  $2[\text{Ca}_2(\text{Al},\text{Fe})_3(\text{OH})\text{Si}_3\text{O}_{12}]$ . It is the monoclinic dimorph of zoisite. Transparent to translucent. Streak: colorless to pale gray. Vitreous luster. Cleavage: {001} perfect. Fracture: uneven. Brittle. Optics;  $\alpha$ :1.67-1.715,  $\beta$ :1.674-1.725,  $\gamma$ :1.69-1.734. Birefringence: 0.005-0.015.  $\oplus$ . SG:3.21-3.38. H:6-7. Found in Myanmar, India, Zimbabwe, Mexico, Kenya (Africa), Italy, Ireland, Norway, etc.

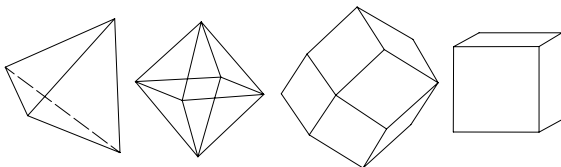
**clintonite**; → bronzite.

**clivage**; rough diamond that must be divided into smaller pieces.

**cloak quartz**; same as mantel quartz.

**closed culet**; same as a sharp point at the bottom of the pavilion of a brilliant cut. It can be seen as a knife-edge on an emerald-cut stone.

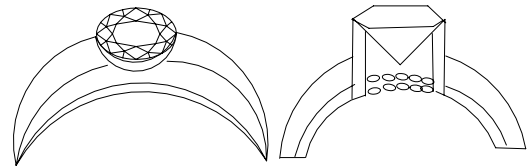
**closed form, crystal**; when a crystal is formed entirely



closed crystal forms

of one form. → Open form, form.

**closed setting**; a style of setting a gem in a finger ring, in which the metal rim is fitted with a closed base so



closed settings

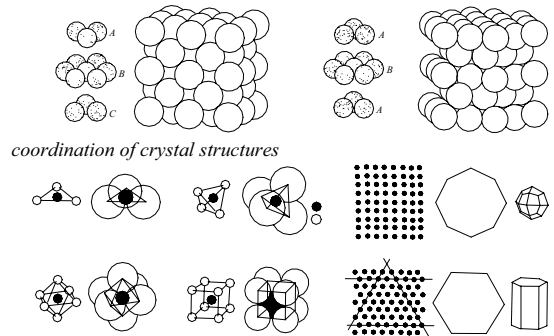
that no part below the girdle is free. The gemstone was mounted in a collet with a thin band and the development of the claw setting followed.

**closed star**; during cutting an oval cabochon, when one ray is not parallel to the width of the oval cut form, it produce a pinched unattractive star effect. Star rubies and star sapphires cut as low cabochon because of greater effect of star. → Open star.

**closed table**; a diamond with small table diameter, however, its interpretation and use is varied.

**close goods**; an old sorting classification for whole, highest-class diamond crystal containing no flaws, from South Africa.

**close-grained**; fine-grained, closely spaced particles of crystals or other substances.



**close packing crystal**; the packing of spheres as to occupy the minimum amount of structural space in three dimensions of a crystal. There are two ways of packing of identical spheres in a crystal, in a two dimensional single plane each sphere is surrounded or contacted by six close neighbors in own layer in a hexagonal arrangement which is known as *hexagonal closet packing* (close-packed hexagonal), now the spheres of second layer occupied depressions in the first plane, etc., in a such set, each sphere has 12 other touching spheres as neighbors, the spheres of third layer are directly over those in the first plane, and so on which is signed with letters ABAB.... In *cubic closet packing* (close-packed cubic) the spheres in the third plane occupying in a different arrangement of indentation than those of the first with set

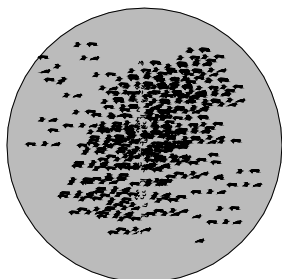
ABCABC... in a such arrangement, each sphere has 12 other touching spheres (12 coordination). The combination of these two arrangements also occur. → Coordination number, closet packing crystal.

**close sand;** closely packed particles of sand that it has low porosity therefore poor as a reservoir.

**close set;** a gem-setting of brilliant diamond or other gemstone, in which only the top surfaces of stones are visible to distinguish from open set or à jour.

**closet packing;** the packing of spheres as to occupy the minimum amount of space in three dimensions. → Close packing crystal.

**cloud;** a term used in mineralogy to characterize some white tiny cottony inclusions or minute internal fractures distributed through the crystals, to produce a semitransparent to semitranslucent area resembling a



*cloud in synthetic ruby due to bubbles*

cloud caused by submicroscopic gas-filled spaces. Also in diamond grading is called cloudy texture.

**cloud;** a term used by Australian miners for a film sometimes can be affected the brilliance of the opal.

**cloud;** same as a vein.

**cloud agate;** a transparent to semitranslucent, light-gray variety of chalcedony with more or less rounded spots or patches of darker gray resembling dark clouds. Also called clouded agate.

**clouded agate;** same as cloud agate.

**clouding;** the effect of cloud in crystal.

**cloudy;** a term used to any crystal which is semitransparent to semitranslucent or cloudy.

**cloudy agate;** a term is sometimes used for white to gray chalcedony with cloudy effects.

**cloudy amber;** a commercial grade for translucent to opaque amber. Its approximate opal effect is due to inclusions of minute bubbles. It takes a good polish but is more turbid than fatty amber. Also called cloudy bastard amber.

**cloudy bastard amber;** same as cloudy amber.

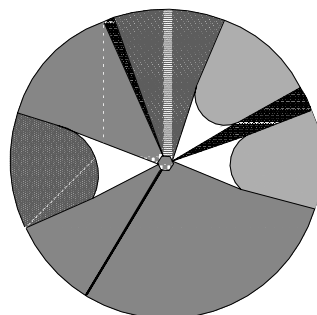
**cloudy carbuncles;** a term applied by Callistratus to carbuncles garnet with dark cloudy spots, in opposite of bright carbuncles.

**cloudy chalcedony;** a term applied to chalcedony with dark cloudy spots in a light-gray transparent base.

**cloudy stains;** a term applied to a mica with cloudlike effects in various colors.

**cloudy texture;** → cloud.

**clover leaf;** a term used by Australian miners for a kind



*cloverleaf or umbrella pattern effect in radiated diamond or brilliant-cut zircon*

of pattern usually can be seen in minute stone in which a center is surrounded by rings of outer units.

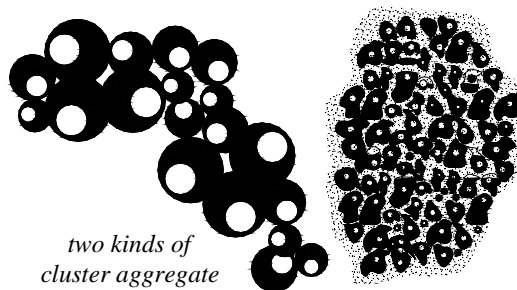
**cloverleaf effect;** an effect, which appears around the culet of a brilliant cut diamond, which has been cyclotron-treated to give a green color to the stone. When looked through the table cyclotron-treated diamond shows a halo around the culet that has been linked to the shape of a *watermark* or cloverleaf or an opened umbrella. Also called umbrella effects. → Cyclotron-treated diamond, diamond artificial coloration.

**clove oil;** an aromatic oil used as immersion in refractive index tests. RI:1.54.

**clump;** a term rarely used by Australian miners for an isolated patch of opal dirt to distinguish from a whole layer.

**cluster;** a style of stone setting, in which the minute stones are arranged to give the pattern of a single larger stone.

**cluster aggregate;** a botryoidal aggregate of minerals.

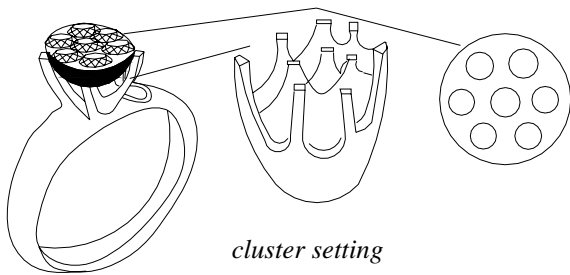


*two kinds of cluster aggregate*

**cluster;** same as dyke.

**cluster;** sometimes used for agglomeration of rocks or minerals.

**cluster setting;** a style of setting of gems usually in a round finger ring, in which several minute diamonds or other gemstones are mounted close together to creates



cluster setting

the illusion of a large stone. or setting around a large central stone. → Buttercup head.

**clusterite**; another term for botryoidal, grape formation.

**C.L. vat blue**; another term for indigo.

**cm**; abbreviation for centimeter. → Grapestone.

**Cm**; a chemical symbol for the element curium.

**C<sup>14</sup> method**; same as radiocarbon dating or carbon-14 dating.

**CMOO**; an acronym for Compagnié Minère de LOubangui Oriental.

**Co**; a chemical symbol for the element cobalt.

**co-activator**; → phosphor in zinc sulfide, sensitization.

**coal**; an impurity grade as inclusion.

**coal**; a term including lignite and jet.

**coal**; colloquially a synonym for black diamond.

**coal jade**; a term applied by Chinese to a specific color quality of jade.

**coalescence**; same as growing together.

**Coalinga diamond**; a misleading term for quartz crystal from Coalinga, California, USA.

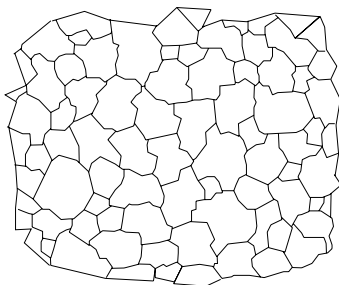
**coal-oil blue**; a commercial name for yellow diamonds, which have an oily-blue appearance in daylight.

**coarse**; fragments or pieces in large grains.

**coarse basalt**; same as dolerite or bluestone.

**coarse adjustment**; any mineralogical- or petrological microscope is also fitted with a coarse adjustment focusing arrangement to obtain sharp focusing with low or medium powers. → Fine adjustment.

**coarse gold**; fragments or pieces of gold in large grains in contrast to gold dust. Also known as coarse quartz gold, heavy gold.



coarse-grained granite

**coarse grained**; a crystalline rock, in which the mineral particles are relatively large than 2 mm in diameter.

**coarse-grained gravel**; → coarse grained.

**coarse-grained phanerocrystalline**; same as phanerocrystalline.

**coarsely crystalline marble**; same as sparry limestone.

**coarsely granular**; same as coarse-grained.

**coarse quartz gold**; same as coarse gold.

**coastal dune**; same as beach deposition by sea waves.

**coastal placer**; placer deposited by sea waves.

**coastal working**; same as beach mining.

**coated**; → coated gemstones.

**coated beryl**; same as Lechleitner synthetic emerald or Lechleitner synthetic emerald-coated beryl.

**coated gibbsite**; → gibbsite.

**coated crystal (diamond)**; diamond crystals usually alluvial, which are coated with a dark-colored, thin, translucent to opaque layer of diamondiferous material. The tone of the color may well vary with the thickness of the coating substance for example alluvial diamonds from Paraguay are coated with iron oxide. Coated or frosted diamonds are *opened* by polishing two *windows* on opposite sides of the stone. Found in Zaire, and Sierra Leone. → Coated stone, coated diamond, bloomed.

**coated diamond**; a brilliant diamond, which has been coated entirely, or on pavilion or girdle with a bluish or yellowish transparent color substance to improve the phenomenal effect or color of the stone. Also called painted diamond.

**coated diamond**; a term applied to coated crystal (diamond). → Coated stone, lacquer back, diamond artist.

**coated gemstones**; a gemstone partially or entirely covered by some transparent material to heighten color, improve phenomenal effects or conceal defects such as pale color emeralds and rubies. → Lacquer back, altered stone. Coated diamond, coated crystal (diamond).

**coated gemstones**; diamond crystals, which are coated with a green, brown, or yellow substance removable by cutting. The best method of detecting is to soak the stone in detergent or spirits or boil it in sulfuric acid. → Coated diamond, coated crystal (diamond).

**coated glass**; surface of some glasses are with a thin layer of refractive index of air (usually 1.00) and glass, therefore the film has a thickness of  $\lambda/4$ . This can be seen for wavelength region where the eye is sensitive such as for 500 nm the thickness  $I$  of 125 nm.

**coated marble**; some marbles are coated with wax, plastics, paraffin or other colorless materials to protect before they become scratched and this enhances the color and appearance. → Treatment of marble.

**coated opal;** → painted opal.

**coated quartz;** pale-blue iridescent colored natural quartz, which is coated with gold, silver, or platinum and misnomerly called *aqua aura quartz*.

**coated topaz;** blue topaz can be created by coating with a very thin layer of gold, which is commercially called *aqua aura topaz*.

**coating;** some diamonds and colored gems, (or glasses) are found with a coating on the surface that may mean they are poor quality diamonds or gemstones. → Coated stone, coated crystal (diamond).

**cobalt;** a tough, ductile, lustrous, somewhat malleable, nickel-white or silver-gray metallic element in the group VII of Periodic System. One of the eight metallic elements mainly responsible for color in minerals and important coloring agent of synthetic blue spinel, some glass imitations and in ceramic industry. Chemical symbol: Co. Used in many alloys.

**cobalt bloom;** same as erytherite.

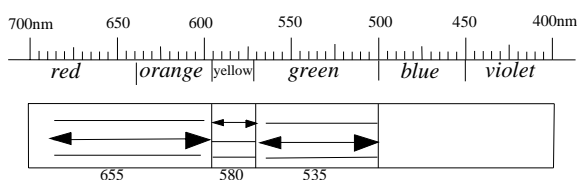
**cobalt blue;** a most stable blue pigment of blue to green color consisting of mixture of cobalt oxide and alumina  $\text{Co}(\text{AlO}_2)_2$ . In trade varies due to cobalt content and the shade of color. It is resistant to both chemicals and weathering. Also called Thénard's blue, azure blue, cobalt ultramarine, zaffer blue, king's blue.

**cobalt blue topaz;** a misleading term for irradiated blue topaz.

**cobalt coloration;** cobalt as color agent in minerals caused pink to blue colors, or mostly glasses are colored blue by cobalt.

**cobalt glance;** same as cobaltite.

**cobalt glass;** a term applied to a glass colored blue by cobalt oxide. This glass is characterized by a typical



*cobalt-glass absorption spectrum*

absorption spectrum. Often used as an imitation gems. Same as a blue paste (glass).

**cobaltoan tourmaline;** a synthetic tourmaline contain cobalt, known as synthetic.

**cobalt oxide;** a steel-gray or black compound of  $\text{Co}_2\text{O}_3$ , used as a coloring glass, enamels, glazing pottery and pigment. → Cobaltous oxide.

**cobalt pyrite;** a variety of pyrite, which contains cobalt.

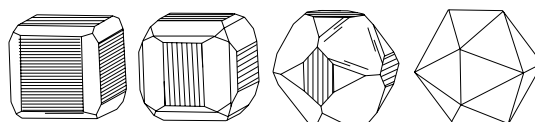
**cobalt-pyrites;** same as linnaeite. → Pyrites.

**cobalti-calcite;** a pink variety of calcite, which is colored by cobalt. Cut cabochon for collectors.

**cobalt salt as humidity determinant;** anhydrous of cobalt II salt with tetrahedral four ligands or coordination have blue color. Whereas dissolved in water the coordination increase to six or octahedral surrounded  $\text{Co}^{2+}$  ion, as a result of increased crystal field as mentioned in *isoelectronic*, both forms turn in coordination and change of ligands now caused the pink color. Also when moisture evaporates and humidity falls the salt turn blue, and when atmospheric humidity rises and moisture is absorbed the color change to pink.

**cobalt 60;** an unstable, radioisotope of cobalt, which emits gamma and beta rays as it decays and has many medical and industrial uses (half-life 5.3 years). Also used to irradiate diamonds to enhance their color due to their absorption. Only the surface of the color is instable and they are safe to wear.

**cobaltite;** cut cabochon but rarely for gem use. Also



*cobaltite crystals*

called cobalt glance.

System: cubic.

Formula:  $4[\text{CoAsS}]$ .

Luster: metallic, brilliant to dull.

Color: silvery white tinged with purple.

Streak: grayish black.

Diaphaneity: opaque.

Cleavage:  $\{001\}$  perfect.

Fracture: conchoidal to uneven. Brittle.

SG: 6.00-6.40.

H:  $5\frac{1}{2}$ .

Found in Scandinavia, USA, Russia, India, Mexico, Australia, Norway, Germany, and England.

**cobaltocalcite;** a mineral species, occasionally fashioned into attractive cabochons. Also called sphaerocobaltite.

System: hexagonalic (trigonalic).

Formula:  $6[\text{CoCO}_3]$ .

Luster: vitreous somewhat waxy.

Colors: peach blossom-red to rose red. Often altered to gray, brown, or black surface.

Streak: rose to red.

Diaphaneity: transparent to translucent.

Cleavage: {1011} perfect.

SG: 4.13.

H: 4.

Optics;  $\omega$ : 1.855,  $\epsilon$ : 1.600.

Birefringence: 0.255.  $\ominus$ .

Found in Italy, Katanga, Congo, Australia, Mexico, and California (USA).

**cobalt spectrum;** cobalt-rich gemstones such as natural or synthetic are blue in color, and shows 3 major spectrum bands in the orange, yellow, and green at 630, 580, and 543 nm and a very weak band at 478 nm for synthetic blue spinel, for cobalt blue glass at 656, 590, and 538 nm and a very weak band at 495, and for cobalt blue plastics at 652, 610, and 566 nm. The arrangement of cobalt spectrum differs slightly in their make up from blue synthetic blue spinel to cobalt blue glass and cobalt blue polystyrene.

**cobaltous oxide;** a reddish crystal of CoO soluble in acids and insoluble in water. Used as a pigment. → Cobalt oxide.

**cobalt ultramarine;** same as cobalt blue.

**cobalt vitriol;** a flesh-red to rose-red cobalt-sulfate ( $\text{CoSO}_4 \cdot 7\text{H}_2\text{O}$ ), mineral, which occurs in crusts and dripstones. Suitable mineral for collectors. Also called bieberite, rose vitriol, red vitriol.

**cobble;** a rounded sedimentary gravel rolled along a watercourse bed. Suitable for paving a street or road.

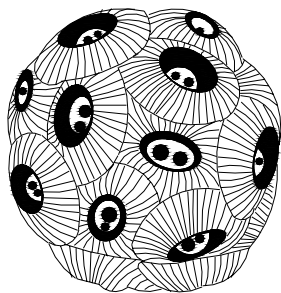
**cobbled quartz;** same as frosted quartz.

**cobblestone;** a rounded sedimentary rock suitable for paving a street or road.

**cobweb matrix;** fine blue lines, which can be seen in some turquoise.

**coccolite;** a variety of various colored diopside occurs as granular.

**coccolith;** various micro-organic calcareous, button-like



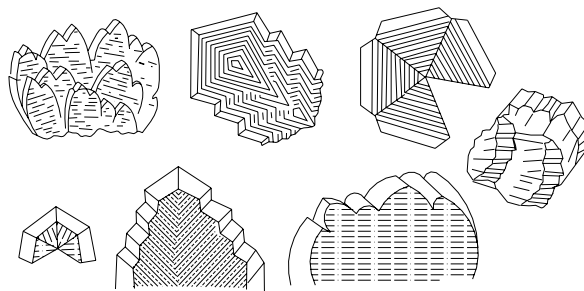
*coccolith*

plates, warm water leaving, found in chalk.

**cochineal;** a related dye to kermes obtained from an insect living on oak-trees and extruded resin. Used as dyes.

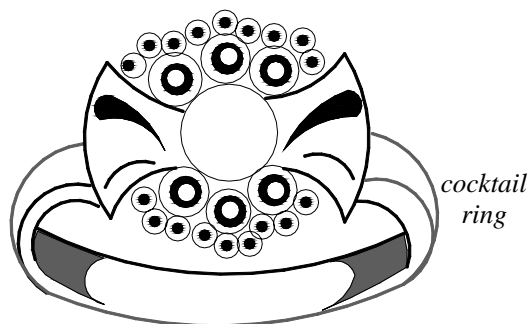
**cockscornb marcasite;** a twin form of marcasite mineral

that resemble the crest. → Spear pyrites.



*repeated twinning of marcasites or so called cockscornb*

**cocktail ring;** a modern style of finger ring made of gold or platinum usually set with small diamonds and other colored gemstone or sometimes set with a small watch in the bezel. Also known as bridge ring, cocktail



*cocktail ring*

watch.

**cocoanut pearl;** same as coconut pearl.

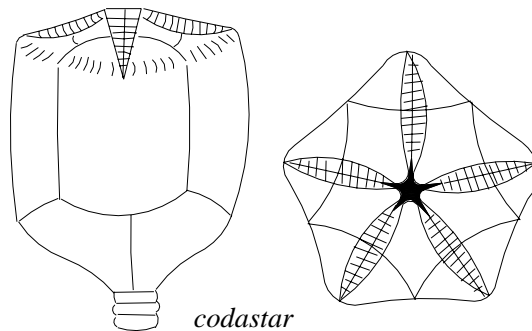
**coconut;** a term applied to hollow geodes from northern Mexico, in which amethyst crystals dorm sometimes with calcite.

**coconut pearl;** a local term for pearl from the *giant clam* of Singapore, which in appearance resembles the meat of a coconut.

**coconut pearl;** a misleading term for pearl-like rounded concretions found in coconuts, of no value.

**coconut pearl;** a commercial term for a pearl being from a white conch. Also sometimes spelled cocoanut pearl.

**codastar;** a various organic calcareous, five-rayed star-



*codastar*

like top, warm water leaving, found in chalk.

**codazzite**; a mixture of ankerite and parisite, a dark-brown to dark-gray, carbonate mineral of  $(Ca,Mg,Fe,Ce)CO_3$ . Hexagonal system. SG:2.50. H:4. An inclusion in emerald from Muzo, Coscuez, Colombia.

**cod's eye**; same as fish-eye.

**coefficient of cubical expansion**; → coefficient of expansion.

**coefficient of expansion**; the fractional expansion per degree rise of temperature. Because diamond has a very low coefficient of expansion, it can be heated to higher temperatures. Also called coefficient of linear expansion, coefficient of superficial expansion, coefficient of cubical expansion.

**coefficient of linear expansion**; → coefficient of expansion.

**coefficient of roundness**; a term applied to the ratio of specific gravity to hardness of a mineral or rock. It expresses the relative facility with which materials can be rounded.

**coefficient of superficial expansion**; → coefficient of expansion.

**coelanaglyptic**; → intaglio.

**coelestine**; same as celestite.

**coenosarc**; a very sensitive gelatinous mass, in which the hydrorhizae of corals are embedded and itself is coated by a skin thin membrane, which is known as perisarc. **coccolite**; a variety of various colored diopside occurs as granular.

**coeruleite**; a milky-white to light sky-blue color mineral member of the turquoise group with chemical formula:  $Cu_2Al_7(AsO_4)_4(OH)_{13} \cdot 11\frac{1}{2}H_2O$ . Triclinic system. Conchoidal to uneven fracture. Optics;  $\alpha$ :1.580,  $\beta$ :1.599,  $\gamma$ :1.605. Birefringence: 0.025.  $\oplus$ . SG:2.70. H:5-6. Found in Chile, and Bolivia.

**coesite**; a mineral of  $16[SiO_2]$ , which crystallizes under high temperatures and pressures. It is stable at room temperature and at pressures above 20,000 bars. It is a very dense polymorphous with quartz, tridymite, cristobalite, and stichovite. It is an inclusion in synthetic diamonds. Colorless. Monoclinic system. Fracture: subconchoidal. Optics;  $\alpha$ :1.596,  $\beta$ : ?,  $\gamma$ :1.608. Birefringence: 0.005-0.011.  $\oplus$ . SG:2.93-3.01. H:7½-8.

**coexisting**; to exist together at the same time and sometimes at the same place.

**coffee**; color grade of brown diamond.

**coffinite**; a mineral with composition of  $USiO_4$  is included in some zircon crystals, which emitted alpha particles and completely breaks down the structure of the stone into an amorphous state, which is known as metamict zircon.

**cogherent**; a group of elements or metals such as copper, silver, gold which owing to similarity in

valence and radius, occur intimately associated in nature.

**cognac**; a color grading of brown diamond.

**Cognac Over Ice Diamond**; a cognac colored, pear-shaped diamond of 34 cts, belonged to Elizabeth Taylor.

**cognate inclusion**; same as autolith.

**cognate xenolith**; same as autolith.

**coherent light**; controlled waves of a beam of light, or other electromagnetic radiation of the same wavelength or nearly so in a very narrow frequency band.

**cogherent metal**; a group of metals such as copper, silver, gold.

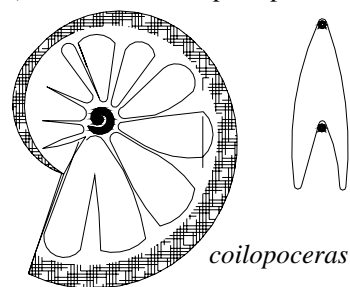
**cohenite**; a tin-white meteorite mineral of  $(Fe,Ni,Co)_3C$  that occurs also in iron dross. Also called cementite.

**cohesion**; the term applied to the force of attraction existing between the atoms (molecules) of a substance or liquid, which tends to resist any separation of them.

**cohesion**; generally in sedimentary rock or other rocks, the shear strength of the cement or absorbed water is not related to interparticle friction. → Fracture, cleavage, toughness.

**coinage metal**; to make or stamp coins from suitable metals such as copper, silver, gold. Also called mintage metal.

**coilopoceras**; a kind of turbo cephalopods .



**coin finger ring**; a style of finger ring set with a gold coin on the bezel, worn as an ornament.

**coin gold**; in the USA a gold-base alloy containing 900 parts fine gold and 83 to 100 parts copper.

**coin jewelry**; any jewels mounted in charms with a gold coin in several types, worn as finger ring set on the bezel, pendant, bracelet, etc.

**coin silver**; an alloy containing 900 parts fine silver and 100 parts as balance copper.

**Co Ken Lu**; a Chinese author who write a book about jade in 1366.

**colam**; pieces of a variety of beryl used by Arabs in Arabians to decorate their houses.

**cold cathodes**; for testing of fluorescence of some stone used cold cathode, which is produced under low vacuum and at voltages up to 20 KV. Also called ion



cathode. → Hot cathode, Coolidge hot cathode.

**cold crucible melting method;** same as skull crucible process.

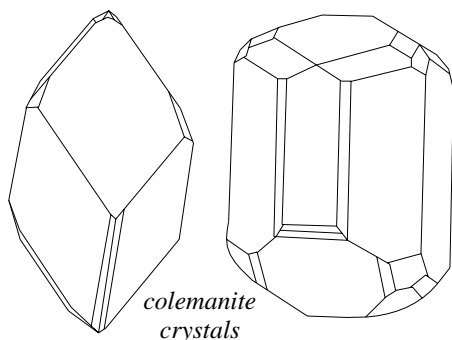
**cold improves lines and fluorescence;** the sharpness of absorption bands and the intensity of the fluorescence and phosphorescence in diamond are depended upon temperature. Diamond can be examined on a piece of dry ice (does not fluoresce), which reduces the temperature of the stone to about  $-70^{\circ}\text{C}$  or  $-158^{\circ}\text{F}$ .

**cold-light;** a commercial term for light beams of visible range of low heat such as luminescence razors which are useful for transmitted or reflected light.

**cold-light spectroscopy;** a commercial term for light beams of visible range of low heat emerged by flexible parallel glass fibers (light-guides) does not contain infrared wavelengths used in spectroscopes and microscope, which are useful for transmitted or reflected light. In such a spectroscopy the measured absorption spectrum can be read on a scale tile 2nm accuracy.

**cold setting;** same as industrial diamond.

**colemantite;** frequently are cut as gems but prized by



collectors.

System: monoclinic.

Formula:  $2[\text{Ca}_2\text{B}_6\text{O}_{11} \cdot 5\text{H}_2\text{O}]$ .

Luster: vitreous to adamantine.

Color: colorless to white, grayish, yellowish.

Streak: colorless.

Diaphaneity: transparent to translucent.

Cleavage:  $\{010\}$  perfect, and  $\{001\}$  distincts.

Fracture: subconchoidal to uneven. Brittle.

SG: 2.42.

H:  $4\frac{1}{2}$ .

Optics;  $\alpha$ : 1.586,  $\beta$ : 1.592,  $\gamma$ : 1.614.

Birefringence: 0.028. ⊕.

Found in Russia, Turkey, Argentina, and California, USA.

**Colenso diamond;** a beautiful yellowish, perfect octahedral crystal diamond of 133.145 cts, was named in honor of the first bishop of Natal J. W. Colenso, a distinguished mathematician. It was exhibited in the

British Museum but has been stolen since 1965, and never recovered.

**Colesberg Kopje;** a town on the Orange River where Kimberly diamond mine (formerly New Rush) was found.

**collar;** a term used by Australian miners for a shaft break into the opal dirt after passing through band or sandstone.

**collar;** a term used by Australian miners for a timber framework around the top of shaft.

**collarette;** a kind of necklace made of flattened elliptical pieces of jet.

**collection;** a term used by sorters of rough diamond for a very white grade.

**collection blue;** → collection color.

**collection color;** a trade color classification of rough diamonds at the source by Trading Co., which is for the second best color or the first two finest colors *mixed* together.

**collection color;** the finest color is called *extra collection*.

**collection color;** collection color, collection blue, and collection gem blue is sometimes used by importers and retailers as colorless diamonds and, unethically, for those toned with yellow.

**collection gem blue;** a term used by sorters of rough for a very white grade.

**collection gems;** → museum of minerals.

**collection of gems;** → museum of minerals.

**collection of minerals;** → museum of minerals.

**Collection of Nizam of Hyderabad;** a collection of 37 articles, including 22 emeralds of 414.25 cts, was offered for sale in 1979 in Andhra Pradesh, India. Among the diamonds were the Nizam Diamond and Jacob Diamond.

**collector;** a person or institution that collects any fine specimens of mineral or gems as a hobby or because of scientific interest. → Museum of minerals.

**collet;** an alternative name for culet.

**collet;** a circular metal rim, in which a gem is set.

**collet setting;** a form of setting an opaque or flawed stone in a finger ring in a circular metal rim or box, in which a gem is bent over the girdle in a collet to secure it. Also called rub over setting.

**collette;** same as collet and alternative name for culet.

**collier;** a collar or necklace made of one or several strings of pearls. The strings usually are of silk and have a length of 15-16 inches.

**collier de chien;** a French term for a necklace (collar) containing several parallel arranged strings of small ungraduated pearls. Made also of jet or coral. Also called dog collar.

**Collier de la Reine;** → Marie Antoinette Necklace.

**collimate;** to make refracted or reflected rays of light parallel. To make divergent or convergent rays of light parallel.

**collimator;** an optical device of lenses, which produces parallel light rays, usually for use in spectroscopy. It consists of a tube, at one end, of which is fixed a narrow adjustable slit and at the other end a lens, which has a principal focal length equal to the length of the tube.

**colloform schorls;** a term used for black tourmaline masses up to 7x10 cm which formed in metasomatized silica-rich rock such as in ore deposit in Azerbaydzhan, CIS.

**colloid;** the term applied to a liquid or semi-solid jelly substance consisting of very tiny particles that does not occur in crystalline form. Alternatively, any fine divided material in suspension usually between 1 to 100 nm in diameter, or any such substance that can be easily suspended.

**colloidal;** same as jelly-like or relating to a colloidal suspension. → Colloid.

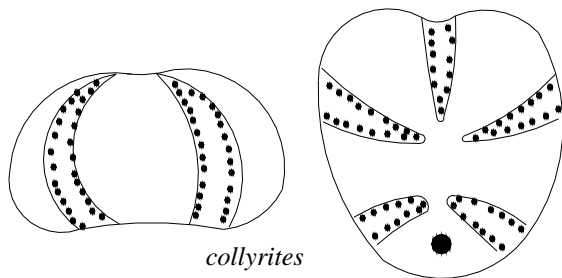
**colloidal coloration;** the coloring agents in gems are in the form of fine colloidal particles of ultra-microscopic size diffused through another. The coloration of gems also provides an explanation of the irregular distribution of color in crystals of sapphire.

**collophane;** an amorphous, colorless, horny, massive, dull, often opaline, cryptocrystalline variety of apatite. Also called collophanite. SG:2.5-2.9. H:3-4. Conchoidal to uneven fracture.

**collophanite;** same as collophane.

**colluvial deposit;** a contraction term for secondary deposit consist of heterogeneous alluvial in part and containing angular fragments of diluvia.

**collyrites;** various micro-organic calcareous, button-like



plates, warm water leaving, found in chalk.

**cologene earth;** an earthy black to brown lignite used as a pigment. Also called cologene umber.

**cologene umber;** same as cologene earth.

**Colombian emerald;** a trade term for fine colored emerald from any mine in Colombia. Also called

southern emerald, new emerald, occidental emerald, meridional emerald. Esmeraldas nuevas is an old term for new emerald or Colombian emerald. → Esmeraldas viejas, oriental emerald.

**colophonite;** a term applied to a dense, cloudy, yellowish-brown variety of andradite garnet.

**colophonite;** a name for a non-gem variety of vesuvianite from Arendal, Norway.

**colophonium;** → colophony.

**colophony;** small pieces of amber, which were produced when heating succinite acid, amber oil and colophony. Used to prepare varnish. Also called colophonium, and rosin.

**color;** a term used in optic to describe three different properties according to light: (a) property of an object such as gold is yellow, (b) characteristic of light rays such as gold reflects yellow light because of nearly full absorption of other colors, (c) grading of sensation in the brain, which be interoperated in special kind as the eye perceives light selectively reflected yellow from gold. → Color,-definition.

**color;** a general term for light when perceived by the eye. → Color,-definition.

**color;** a term used in Australian for spectrum colors that play in precious opal with a radiate light.

**color;** a term used in Australian for spectrum colors which play in potch opal by which the color is flat, like paint and does not radiate light.

**color;** a term used by Australian miners for an opal of good sign in the potch and generally through the opal dirt.

**Colorado;** kimberlitic diamond pipes in W. Larimer County, Colorado (USA). Some minute diamond crystals were discovered here.

**Colorado aquamarine;** any pale light blue, pale blue to pale blue-green aquamarine from Mt. Antero, Colorado, USA.

**Colorado diamond;** a misleading term for transparent smoky quartz from Colorado, USA.

**Colorado goldstone;** a commercial term for aventurine quartz.

**Colorado jade;** a misleading term for green microcline feldspar or amazonite.

**Colorado jet;** good quality jet from Colorado, USA.

**Colorado lapis lazuli;** a worthless dark blue lapis lazuli from Sawatch Range, Colorado, USA.

**Colorado metal;** same as Colorado silver.

**Colorado ruby;** a misleading term for fire-red pyrope garnet.

**Colorado silver;** a misleading term for German silver containing 57% copper, 25% nickel, and 18% zinc. Also called Colorado metal.

**Colorado topaz;** a misleading term for yellow quartz or

citrine.

**Colorado topaz;** a colorless or pale blue topaz from Colorado, USA.

**Colorado tourmaline;** the term applied to colorless, red, pink, lilac, green tourmaline found near Royal Gorge, Colorado, USA.

**Colorado turquoise;** the term applied to turquoise from four different localities in central Colorado, USA. Same as American turquoise.

**colorant;** any dye substances, organic and inorganic, which gives color to the materials. Colorant or dyes including naturally obtained from plants, animals and synthetic dyes and pigments. It is different between two terms dye and pigment. Generally most *dyes* are soluble in medium but all pigments are insoluble in the medium therefore it require a binder to hold them to the matter.

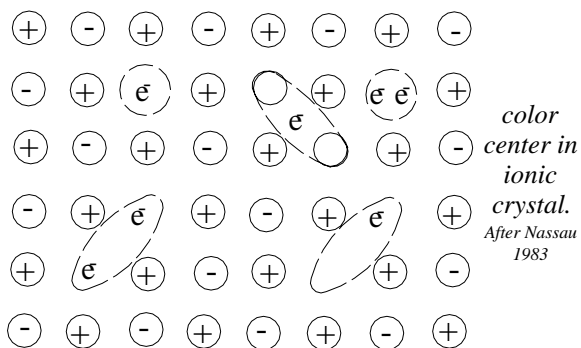
**colorbearing;** same as chromosphere.

**color blindness;** a condition of faulty spectral color vision, in which the distinguishing of one color from another is very sever or not possible. The commonest form is in dichromatic vision, in which the insensitivity to those wavelengths in the red longer than 680 nm (normal vision extends to 750 nm). In another type of deficiency, red-green produce the same sensation as yellow. Color blindness can affect the ability to color grade diamonds. It appears to be a normal state for animals that are only active at night. 5% of human females and 8% of males suffer from color blindness. Known as defective color vision, color discrimination deficiency.

**colorblindness;** another spelling of color blindness.

**color by inclusions;** same as mechanical coloration.

**color centers;** in crystal optics, a selective color absorption within a crystal as a result of a lattice defect or impurity in the atomic structures, which produces an electronic transition, it can be produced by irradiation of diamond, which causes blue color in the stone, such defects give colored crystals their characteristic hue. Such stones when are naturally or synthetically irradiated (naturally amethyst or desert amethyst)



mostly are stable, fading their color only when heated.

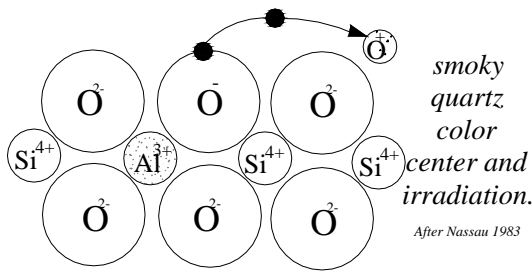
Color centers due to absorption of light produce a colored appearance in transparent crystals and glasses. Color center are revealable with magnetic resonance. Another sample of color center is natural purple fluorite, which shows no impurities responsible for color. Synthetic fluorites of very high purity can irradiated with energetic radiation to produce desirable colorations. Colored fluorite can be produced by excessive addition of color centers to the crystal structure by exposing a crystal to excessive metal such as fluorite exposing to hot calcium vapor, the additional metals have merely the function to produce a *halogen deficient*. Another method of addition of color centers to the crystal structure can done by using electrodes to a heat fluorite crystal when an electric passing through it. Also other color can produced by colloidal metal such as blue color in sodium chloride due to colloidal metallic sodium particles, which is not a color center. Defects in crystal are responsible for color centers, see defects in crystal and color effect. When the trapped electron is released the crystal become bleaching again. Crystals with color centers having lower density than the colorless. → Lattice,-defect in, hole color centers, electron color centers, sapphire color centers, F center, additive primary colors, subtractive color process, additive coloration, trapping, color change by X-ray irradiation.

**color change;** it means the four major methods of changing the colors of gemstones. These are surface painting or foiling the back, oiling, coating, impregnating, staining of porous stones, heat treatment, and irradiation by particles of atomic size and X-rays. The color change by X-ray treatment is temporary usually after some time reverts to its original color. Also called color improving, color enhancement. → Color change by X-ray irradiation.

**color change;** different significant color change can be seen in some gemstones when studied under different lighting conditions such as alexandrite a chromium, highly dichroic, rare variety of chrysoberyl with emerald green-blue in natural daylight or under many fluorescence rays, reddish-brown to deep violet red by artificial light, due to its unusual absorption properties. Frequently called alexandrite effect. This effect can be seen in corundum, spinel, tourmaline and garnet. Synthetic alexandrite and synthetic sapphire with color change are made; simulated glasses with color change are produced. → Metameric colors, color change by X-ray irradiation..

**color change by X-ray irradiation;** changing the color of gem minerals by X-ray bombardment. The changed color by X-ray treatment is temporary and usually after some time reverts to its original color, when the induced specimen is exposed to strong sunlight for

about three hours or heating at 230° C for a couple



minutes. → Color change.

**color-change garnets;** a phenomenon can be seen in some garnets when containing vanadium due to absence of chromium.

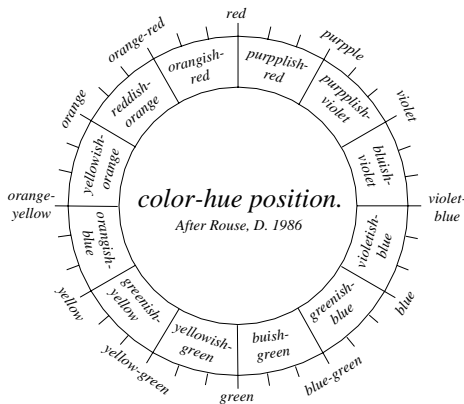
**color-change garnet;** → Manila garnet.

**color-change of quartz;** → color change by X-ray irradiation..

**color-change of zircon;** → zircon, heat treated.

**color cone;** a graphic that is called *color cone*, which should help in comprehension of the meaning of colors and their relationships.

**color, definition;** color is the response of the eye in the broadest sense, an impression produced on the optic nerve by light. The color variation depends on the wavelength or combinations of wavelengths of that light, the variation of wavelength described as a variation of hue, and as to the tone and intensity of that hue. Objects of color have three different characteristics in appearance: (I) the *hue*, which is determined by its wavelength. It means the dominant saturated wave-

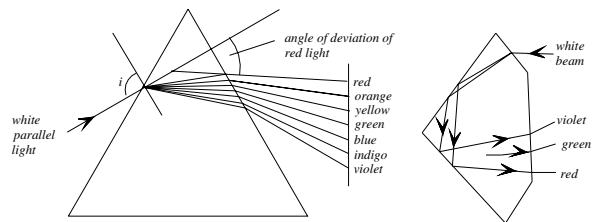


length of color such as red, green, or blue. (II) *Saturation* is the extent, to which a color departs from white and approaches the pure color of a spectral color. Also called intensity and *chroma* or *purity*. Saturation is the intensity or vividness of a color, high saturation means little white, or low saturation means whiter or *faded*. (III) *Luminosity* or the value, a measure of its

*brightness* of an emitting source, for example the emitting source is a gray pigment or dye that means that the white is in one end of the scale and black at the other. Also called value, luminous intensity, and in the CIE calling luminous emittance. Ton, shades, or lightness. The visible light ranges from about 380 nm to 780 nm in comparison the shortest visible wavelength is violet to longer ray, the red. Between the two extends the remain of colors like a spectrum color of glass prism, when the white light passes through it. Theoretically color in gemstones is caused by 1-allochromatic transitional elements or idiochromatic, 2-color centers, 3-charge transfer in lattice, 4-organic pigments, 5-conductors coloration, 6-semiconductors, 7-semiconductor coloration, and 8-physical optical properties or coloration. → Inorganic substances,- colors in, color perception, color.

**color discrimination deficiency;** → defective color vision.

**color dispersion;** the analysis of white light is termed color dispersion. The power of a transparent gemstone or prism to separate the light into colors by refraction of diffraction with the formation of a spectrum. The



*dispersion of light in a prism and right: in a brilliant-cut diamond*

interval between such colors varies in different gemstones, and is usually expressed by the measure of the subtraction between the refractive index of the red ray (Fraunhofer line at B 686.7 nm) from the refractive index violet ray (Fraunhofer line at G 430.8 nm). This measure is used in this book as dispersion such as albite 0.012, etc. → Dispersion.

**colored diamond;** a name applied to diamonds having a different tone of color, termed *fancy stones* or *fancy diamond* and *fancies* such as red, pink, blue, mauve, green, canary-yellow, orange, gray, brown, or black. When the stones are colored by irradiation, they are known as treated diamonds.

**colored frit;** a frit containing a color pigment, which produces a strong color in the porcelain and glazes for enamel.

**colored jade;** artificially green colored jade. Also called c-jade.

**colored pearl;** a name applied to the pearl (both naturally and cultured) of golden-yellow, yellow, pink, gray, purple, red, bronze, blue, and black colors. The cause of the color of black pearls is not clearly known, but it appears to be the nature of the water, in which the animals lives. Also called *fancy pearl*.

**colored stone;** a commercial term used in North America for any gemstone species other than diamond. This usage illogically classifies all varieties of such species as colored stones, including colorless varieties. However, it has proved a practical and satisfactory classification.

**color enhancement;** → enhancement, color change, treatment.

**color fastness;** a chemical compound used to prevents the fading of objects when exposed to bright light or abrasion (or crocking).

**color filter;** an optical component made from pieces of colored film or glass (colored solution or semitransparent material), when white light passes through it, which selectively absorb certain wavelengths, and hence change spectral distribution of transmitted radiation. Selective transmit or blocking a part of the spectrum based on absorption, interference, band reflection, and birefringence filter. When emerald, demantoid, other genuine or synthetic stones are seen through a filter, which absorbs all but red and green, those stones appear red. Color filters are distinguish as *hand pass filter*, *hand blocking filter*, and *band reflecting filter*, the last filter is a transmit block filter. Section of spectrum can be *narrow* or *wide*, *sharp*, *broad cutting filter*, *short wave pass filter* by which transmit the short wavelength at the blue end, and long wave pass filter by which pass blocking long wavelength. Some filters are known as beryloscope, Chelsea filter, emerald glasses, or any filter operating on the same principle. Color filter is especially successful in the discrimination between emerald and its imitations. Also called filter. → Filtering of color.

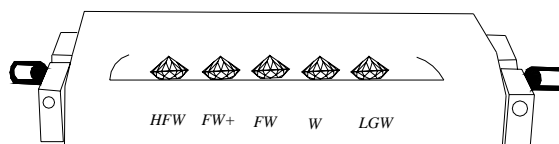
**color-floater;** a term used by Australian miners for a piece of poor opal, which may be bleached and worn with less indication of a vein. Also called floater.

**color grade;** → color grading, color grading of diamond.

**Color Grader;** an accessory designed and manufactured by the Gemological Institute of America to facilitate the color grading of diamonds under binocular magnification and to demonstrate its manufactured to customers.

**color grading of diamond;** in diamond grading there are many divisions and subdivisions, into which diamonds may be color-graded. For grading the color of diamonds uses the standards comparison *master*

*diamonds*. Master stones for diamonds are carefully selected and usually range from colorless to shades of yellow and brown, 7 in number by CIBJO. Generally,



color grader, GIA

the following grouping for white diamonds is used: Extra collection (blue-white), collection color, finest white, fine white, browns (varying from light brown to light green), top capes (stones having a yellowish tinge), and yellows. Other colors of diamond are called *fancy stones* or *fancy colored*. → Master diamonds.

**color grading scale;** color grading scale of diamond range from colorless to light yellow, light brown, or light gray.

**color grading system;** → AGS color-grading scale, CIBJO International color-grading scale, color nomenclature system, GIA color-grading scale, etc.

**color grading;** the grade or classification of hue, color saturation, brightness and color purity, into which a gem is placed by examination of its color in comparison to the color of the other gems of the same variety. Comparable color grades are not used for fancy colored stones.

**color grading;** color grading in polished diamonds are: cape, and brown series, which is the degree of freedom from color, when viewed under specified conditions.

**color improving;** same as color change.

**color in gemstones;** → color,-definition.

**colorimeter, diamond;** → diamond colorimeter.

**colorimeter;** an instrument for precise measurement the quality of a color by comparing the intensity of color with standard colors or combinations of colors of a specimen. This is usually done by measuring the relationship between intensity of the red, green, and violet light transmitted by the stone through color filters. For measuring with the colorimeter or diamond colorimeter used only on colorless to yellow diamonds with the effective round brilliants. Also called tintometer, spectrophotometer. → diamond colorimeter, coloriscope.

**coloring agent of natural and synthetic corundum;** to produce colored corundum small amounts of metallic oxides or various combinations of them added to aluminum oxide to create different color corundums. In

the below table are variety of corundum and coloring agents in natural and synthetic are compared.

table 3: compare of coloring agent of natural and synthetic corundum (Verneuil synthetic).  
After Hughes 1990.

variety	coloring agent(s)	coloring agent(s)
	natural	Verneuil process
colorless sapphire	pure aluminum oxide	pure aluminum oxide
ruby red	chromium	chromium
ruby dark red	chromium + iron	chromium + iron
sapphire, yellow	nickel	iron + color center
sapphire, orange	nickel + chromium	nickel + chromium
pink sapphire	chromium	chromium
sapphire, blue	iron + titanium	iron + titanium
sapphire, violet, purple	chromium + iron + titanium	chromium + iron + titanium
sapphire, green	cobalt+vanadium+nickel	iron + titanium
sapphire, color change	vanadium	chromium + iron + titanium (+ vanadium)
sapphire, black star	-	hematite plates

**coloring gemstones;** turning or altering of the color of a natural gemstone. Frequently synthetic gemstones are altered by using heat treatment, tinting, foiling, dyeing or staining, irradiation, produce doublet, etc.

**coloring gemstones;** using the metallic oxides in the production of synthetic gemstones. → Coloring metal in gemstones, tenebrescence, transchromatic, transition elements.

**coloring jadeite;** → jadeite, coloring.

**coloring material;** any colored material, which colors light when the ray passed through it according to partially absorbing the light.

**coloring metal in gemstones;** there are many metallic elements in some colored gems, which cause color in allochromatic minerals, when they enter these as impurities or traces, such as iron, chromium, manganese, copper, titanium, cobalt, vanadium, and nickel. → Coloring gemstones, tenebrescence, transchromatic, transition elements.

**coloring metals;** giving or altering the color surface of a metal by enameling, electroplating, chemical coloring, heat treatment, etc.

**coloring pearls;** → dyed pearl, staining pearls.

**color inter alia;** a term applied to color variety in pink tourmaline after irradiation and heating explain the diversity of origin of the pink color.

**color interference and diffraction;** → interference and diffraction colors.

**coloriscope;** an instrument made in Switzerland for the color grading of diamonds, similar to a colorimeter.

**colorless;** any transparent gem devoid of any color or nearly colorless, such as a fine diamond, a fine quartz crystal, pure water, synthetic rutile, strontium titanate, and a pane of ordinary window glass. Colorless gemstone or minerals transmit all wavelengths of light. Opaque object or gems are not colorless. Such terms as white sapphire and white topaz are misnomers. However, there are many other colorless natural gemstones and substitute cuts for jewelry use.

**colorless topaz;** a term used for colorless topaz.

**colorless topaz;** sometimes misnomered as Killiecrankie diamond from Tasmania, Australia. Used as a gem imitation.

**colorless zircon;** a term commercial used for colorless zircon.

**colorless zircon;** sometimes misnomered as Ceylon diamond.

**color nomenclature System:** the nomenclature or grading of gemstones by color cannot be very definite, and the divisions are consequently wide, and include in each instance a larger variety of shades, even in the first of them it will seldom by happen that a faint tinge is not present. However, a system of correlated term of colors by the use, of which makes it possible to describe the colors nearly. Although there are only 6 main color names (or 7 if indigo is included) yet these can readily be subdivided by using such terms as orange-yellow, yellow-green, greenish, etc. for intermediate hues. Thus, the yellow category includes orange, the green category yellowish and greenish shades, etc.

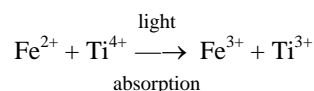
**color of ice;** → ice.

**color of cultured pearls;** the color depends on salinity of water, richness of conchiolin, temperature, and species of oyster and health of them.

**color of diamond;** same as color grading.

**color of diamond;** generally means all characteristic color of diamonds and related to a diamond's color.

**color of sapphire;** color of blue sapphire is derived from a charge transfer of an electron from an iron ion involved by jumping to one ion of titanium:



→ Color change.

**color of smoky quartz;** → smoky quartz, color of.

**color of water;** → ice.

**color perception;** generally, to precipitate and determine color three factors are needed, object, light and a receiving device like eye. Retina of the eye perceive the color by three set of cones, which reports with maximum sensitivity to blue, green and red.

**color play;** a term used for prismatic colors produced by

the dispersion of light, not play of color.

**color print;** recording or printing the complete color spectrum on graph paper using the spectrophotometer.

**color sample;** → master diamonds.

**color saturation;** same as saturation.

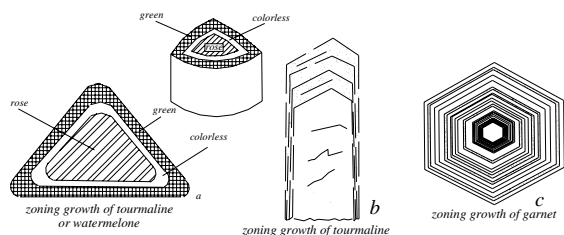
**color stratigraphy;** color stratigraphy is commonly involving with pockets with large or small crystals with zoning structure because of changing within the fluid from which a crystal was formed such as tourmaline. Involving may be complex or extremely closely spaced zones.

**color temperature;** comparing the temperature of a visible light source, with an incandescent source, which determines its emission spectrum. Light sources with color temperature have maximum output toward the red end of the spectrum and in violet.

**color temperature of north light;** the slightly bluish-white light of north light or skylight from opposite hemisphere (South Pole) has a color temperature about  $273.15^{\circ}\text{C}$ .

**color treated diamond;** → irradiated diamond.

**color variation in minerals;** in parti-colored tourmaline can be seen that the core is nearly colorless and outer segments may be pink in one end, green at the other end. In bi-colored, the core is colorless or green and outer segments are pink. In some tri-colored tourmaline, the color is separated in three zones: the core is frequently pink or red and the outer ends are white and green or any combination of these colors,



cross section through color variation of zoning minerals. a: tourmaline b: tourmaline c: garnet

this effect is known as *watermelon tourmaline*. In other tourmaline can be seen concentric shell of colors, when a crystal is sliced at right angles to the length such color variation caused due to straight, parallel growth-lines in the internal structure of a gemstone with definite angles, usually seen in some stones, which occur by slightly variation in the chemical composition within the crystal due to separation or interruptions of the crystal phases during growth. Occasionally can be seen in quartz but not as common as in tourmaline, which occurs in bicolored minerals consisting partly of amethyst and partly of citrine. Some opaque minerals

are color banded such like as malachite in different hues of green or in rhodochrosite in pale pink to white and pink, which is called *bacon strip stone*. Snowflake obsidian, amazonite microcline belonging to this category.

**color vision;** → vision of color.

**Color-Zoned Tourmaline;** a red, white and blue rough stone of  $20 \times 12.7 \times 12.7$  cm from USA. It is a color-zoned albite together with albite, quartz and lepidolite.

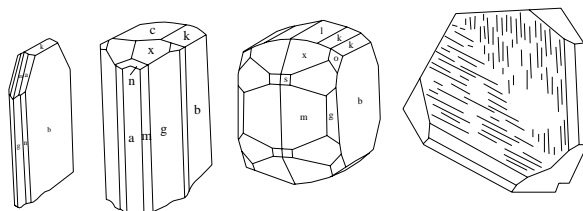
**color zoning;** the distribution of color in a cut gem or rough. These zones of color in natural corundum or sapphire are parallel and straight, while in synthetic flame-fusion synthetic sapphire zones are not straight but curved and concentric. In diamonds, color zoning can be seen in fancy colored stones. Also known as uneven color. → Color variation in minerals.

**color, unevenness of;** the color of diamond is not always uniform, some contain a very fine tinge of color in concentrated spots or layers.

**colour;** English spelling same as color.

**colour;** a term used in England for minute gold particle.

**columbite;** an opaque, brown, black to green with a submetallic luster. Formula:  $4[(\text{Fe}, \text{Mn})(\text{Nb}, \text{Ta})_2\text{O}_6]$ . It is isomorphous with tantalite. Orthorhombic crystal.



columbite crystals and twins

Submetallic luster to vitreous. Streak: brownish black. Cleavage:  $\{010\}$  distinct, and  $\{100\}$  less distincts. RI 2.45. SG: 5.10-8.00. H: 6. Found in Maine, North Carolina (USA), Russia, and Germany. Synonym for niobite, dianite, and greenlandite.

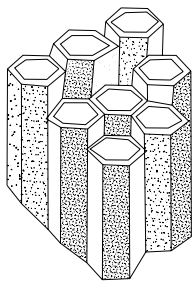
**columbium;** formerly the name for the chemical element niobium.

**columnar crystals;** a crystal having the form or structure in the shape of a prism in close parallel groupings, such as tourmaline or hornblende.

**columnar honeycomb;** a term applied to a peculiar structure can be seen in synthetic opal similar a columnar honeycomb.

**columnar structure (mineral);** in mineralogy an aggregate of slender, elongated, individual crystals in a columnar, nearly parallel grouping. The columns are generally roughly perpendicular to the cooling surface

such as basalt.



*columnar structure of basalt*

**column of heavy liquids;** → diffusion column.

**coluvial;** a deposit formed by heterogenous placer aggregate.

**colza oil;** a variety of rape-seeds *Brassica campestris*, which produce a pale-yellow oil, used for clarifying some cloudy amber, which has been clarified by heating in these oil. Overheating of oil caused stress cracks in amber that resemble the nasturtium leaves and are known as sun spangled. Also called rape oil, rapeseed oil.

**coma;** an aberration in an optical device caused by occurrence of different zonal magnification on the surface of a lens system.

**comb;** having a small cell-like or pitted surface, like a of honeycomb.

**comb;** crystal aggregate resembling a honeycomb.

**combination;** formation of colors by combing.

**combination;** alliance of individuals color.

**combination;** union of two or more pieces of a or different stones together, which known as composite stone, or doublet, or triplet.

**combination;** adding of some pigments to a chemical compound to obtain a new color or variety of a product such as in synthetic stones by adding of color donants.

**combination;** color effect produced by adding of pigment in a chemical compound with respects of its structural colors. Such as obtaining synthetic alexandrite by adding vanadium element to the mean material such as synthetic spinel or corundum (sapphire), which is able to change color like alexandrite reddish-green in daylight and reddish at artificially light, such stones were at first misnomered as *scientific alexandrite*. Also called combination color. → Alexandrite-like sapphire, alexandrine sapphire.

**combination;** a sequence of acronyms, letters to create a name for a new product, etc.

**combination;** alliance of individuals color.

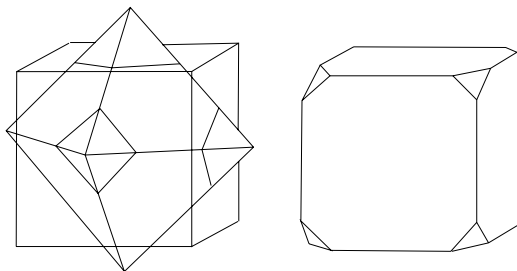
**combination;** the process of uniting to form a chemical compound.

**combination;** the process of uniting a group of organs to

produce quickly material such as inserting of organic tissues in pearl mussels.

**combination color;** same as combination.

**combination of crystals;** union of two or more pieces of a or different crystal forms from a system, which



*combination of octahedron and hexahedron*

known as composite or combined crystal such as combination of octahedron and hexahedron of cubic system.

**combination tones;** a color which consists of vibration color (or overtone) due to high absorption energy from visible light and with the other overtones present in the stone which gives a very high overtone or combination.

**Comblanchien marble;** a misleading term for an oolitic marble of Jurassic age, found in the Loire valley of France.

**come in;** a term used by Australian miners for occur in quantity of opal.

**comet;** → comet-tail.

**comets-tail;** → U-shaped inclusions in Kashan rubies.

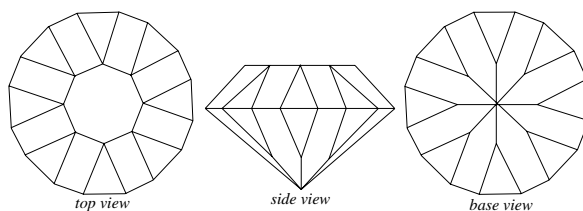
**comet-tail inclusions in Kashan rubies;** a term used for comet feature arrangement of large droplet flux particle as inclusions in Kashan synthetic rubies, which is known as comets. → Dash, dot, U-shaped, dust-like inclusions in Kashan rubies.

**come up;** a term used by Australian miners for occurring the best face of opal after polishing.

**Comité de Coordination de l'Industrie Diamantaire;** a Belgian organization in contact with the Government and the Diamond Trading Co. Ltd.

**comma-shaped inclusions;** a typical comma-shaped two-phase inclusions found in emeralds from India.

**commemorative jewelry;** jewels which are made to



*commercial cut*



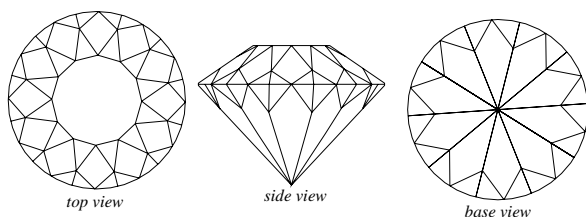
celebrate event such as Jubilee.

**commercial cut;** a type of cut that has a table, but no culet and no star facets. The girdle symmetry is eightfold and the gem is round. There are eight main facets and eight break facets in both crown and pavilion. The pavilion break main facets are triangles pencil-shaped to the culet.

**commercial diamond;** diamonds suitable for trading.

**commercial granite;** a trade term for a decorative building stone, included granite, gneiss, syenite, monzonite, granodiorite, anorthosite, and larvikite.

**commercial king cut;** a trade term rarely used for modification of a near rounded brilliant king cut for



*commercial king-cut*

large stones, which has a symmetrically twelve-sided table (instead of eight-fold) with 48 surrounding facets to form the crown of the stone, and 37 facets, no culet on the bottom, with a total of 86 facets. The crown consists of 12 small triangular facets touching the table and 24 small triangular facets touching the girdle, between both are 12 lozenge-shaped facets. The 12 lozenge-shaped facets on the pavilion are not elongated like cut.

**commercial marble;** marble suitable for trading and polishing.

**commercially clean;** a misleading term for free from inclusions but not flawless.

**commercially perfect;** a misleading term for nearly perfect but almost flawless diamond.

**commercial marble;** a commercial term for a crystalline, decorative rock composed predominantly of calcite, dolomite, or serpentine, which is capable of taking polish.

**commercial white;** a misleading term of a color grading with slight traces of yellow color of polished diamond. It means not *white*, but *slightly off color*.

**commercially clean;** a misleading term meaning: *reasonably free from inclusions*, but not flawless.

**commercially perfect;** a misleading term meaning: *almost perfect*.

**commercially white;** → commercial white.

**commercial top shell;** same as top shell.

**common;** a term used by Australian miners as a synonym for a kind of opal and frequently for potch. Both kinds of opal have no display of color.

**common clear amber;** a German commercial color grading of transparent, light yellow-colored amber.

**common chalcedony;** same as blue chalcedony.

**common conch;** a conch-pearl from the univalves, either the common conch (*Strombus gigas*).

**common feldspar;** an obsolete term for orthoclase.

**common garnet;** a brownish-red translucent or opaque variety of almandine.

**common good;** the low-quality grade end of the scale used in the sorting of rough diamonds at the mines.

**common mica;** same as muscovite.

**common ostrea edulus;** → oyster.

**common opal;** a mineralogical term for a variety of opal ( $\text{SiO}_2 \cdot n\text{H}_2\text{O}$ ) without play-of-color that is found in a wide variety of colors and patterns. Usually whitish background and milky opalescence. Most of those are not of gemological interest or important includes milk opal, cachalong, moss opal, geyserite, prasopal, cherry opal, menilite, petrified opal, chrysopal, band opal (opalite), and resin opal. In Australia, it is called potch. Cut cabochon.

**common quartz;** same as rock crystal

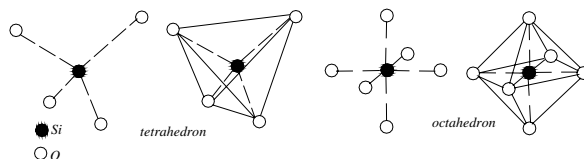
**common rose cut;** the most frequently form of rose cut, which has unafaceted pavilion and faceted crown is covered with a variable numbered facets.

**common salt;** same as halite, or sodium chloride.

**common schorl;** same as black tourmaline.

**common tourmaline;** a term applied to transparent to opaque in nearly all distinguish dark to black colored tourmaline.

**comorphism;** an indicating term used in crystal structures for nearly complementary forms of lattice



*comorphism of aluminum*

polyhedrons such as aluminum in silicates which occurs as octahedron and tetrahedron.

**compact;** any mineral or soil of closely united aggregate. Same as massive.

**compact;** a term sometimes used for hard.

**compact lime(stone);** same as compact limestone.

**compact gypsum;** same as alabaster.

**compact limestone;** a diagenetic aggregate of limestone that takes good polish, mostly of organic origin. Also called compacted lime(stone).

**Compagnié Diamantifere de la Haute-Sangha (Sangha Mine);** a minute diamond deposit company in Central African Republic.

**Compagnié Française des Mines de Diamant du Cap de Bonne Espérance;** a French diamond Mining company of the Cape of Good Hope, Africa.

**Compagnié Minère de LOubangui Oriental;** a diamond mining company in Central Africa with the abbreviation CMOO.

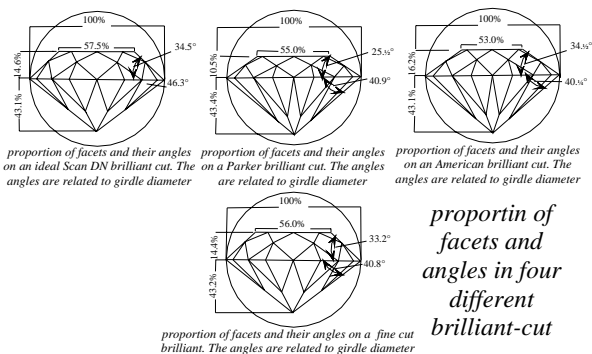
**Companhia de Pesquisas Mineras de Angola;** a diamond mining company in Angola, Africa. Abbreviation: PEMA.

**Companhia de Diamantes de Angola;** Lisbon based diamond mining company in Angola, Africa. Abbreviation: DIAMANG.

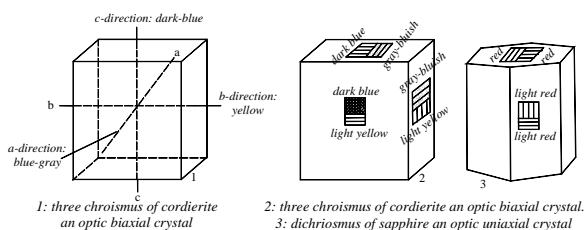
**comparison diamonds;** carefully selected polished diamonds or other gemstones of known bodycolor grade, which are used as standards for comparison, when grading the color of other stones. Master stones by diamonds usually range from colorless to shades of yellow and brown. Also called master stones, master set, color sample, master color set, or key diamonds. Also frequently called diamond yardstick, standard stones or standard comparison stones.

same as master diamond.

**comparison of diamonds;** comparison of ideal cut,



American brilliant cut, fine-cut brilliant, Parker brilliant cut and ideal Scan DN brilliant cut.



comparison of sapphire a uniaxial crystal with dichroism effect and cordierite a biaxial crystal with three-chroism effect

**comparison of dichroism and trichroism;** dichroism can be seen in sapphire an uniaxial crystal with two different colors in two crystallographic directions and trichroism can be seen in cordierite a biaxial crystal with three different colors in three crystallographic directions.

**comparison spectrum;** a line spectrum whose wavelengths are precisely standard, and which is matched with another spectrum to determine the wavelengths of the later.

**comparison stones;** same as master diamonds.

**compass, pearl;** → pearl compass.

**complementary colors;** same as complementary pair.

**complementary pair;** a pair of specific colors that lie on opposite sides of the white point in the chromaticity graph produce the sensation of white when mixed in appropriate intensities such as 480 nm blue and 580 nm yellow gives any of the colors lie between. Also called complementary colors.

**complex crystal;** a large-scale association or assemblage of different crystals.

**compliance;** a term applied to the state of yielding to bend under pressure within the elastic limit such as tourmaline. → Bent crystal.

**compliance tourmaline;** → compliance,-tourmaline bent, compliance.

**component;** a part of a mixture.

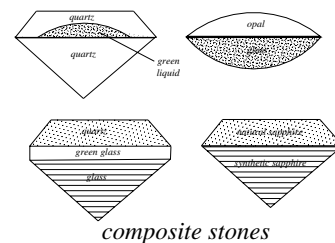
**component;** the smallest number of chemical substances required for the forming of equilibrium, physical or chemical, in a given system.

**composite;** a gemstone or material system assembled of two or more macropieces or micropieces. Also called glued. → Composite stones, compound, chemical formula, assembled stone.

**composite quartz;** same as polycrystalline quartz.

**composite carving work;** the term includes *inlays, overlays, and appliqués*, each type of work formed by the use of separate thin pieces of gemstone cemented together to characterize the symbolic, or geometrical designs.

**composite cultured blister pearl;** → steatite nucleus for cultured pearls.



**composite stones;** a gem constructed of two or more pieces of material, which may be or may not be genuine

crystal or simulated crystal cemented or fused or otherwise joined together so as to be a whole natural stone. In Roman times, various colored composite stone were cemented together with Venice turpentine, which was named *jaspis terebinthizusa*. Composite stones are generally described as *doublets*, and *triplets*. They are distinguished from natural gemstone by a ring around the girdle in the air or better, when immersed in certain liquids or water by viewing from the side or by microscopic determination. Or by having different specific gravity. By immersion method in organic liquids or so-called solvents or hot water it will soften the cement and separate the sheets. Also called fabricated gemstone or assembled stone, glued stone. → Doublet, soudé emerald.

**composition (mineral);** same as chemical composition of gem.

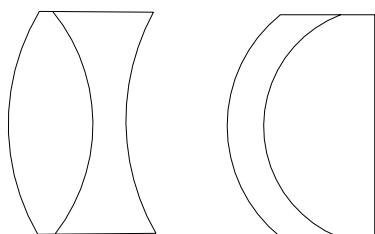
**composition of Earth;** composition of Earth and transition elements are seen in below table. There are low transition metal elements, available for coloration in the earth crust.

table 4: composition of Earth and transition elements

nontransition	%	transition	%
O	46.60	Fe	5.55
Si	27.72	Ti	0.44
Al	8.13	Mn	0.10
Ca	3.63	Cr	0.02
Na	2.83	V	0.02
K	2.69	Ni	0.01
Mg	2.09	Cu	0.01
others	0.79	others	0.02
total	94.38	total	5.62

**composition of pearl;** the chemical composition of pearl is about 82-86% calcium carbonate (as aragonite  $\text{CaCO}_3$ ), 10-14% conchiolin ( $\text{C}_{32}\text{H}_{48}\text{N}_9\text{O}_{11}$ ), and 2-4% water.

**compound;** same as a composite or chemical formula. Composed or produced by the combination of two or more elements, or parts held together by chemical



principal composition of achromatic lenses

bonds.

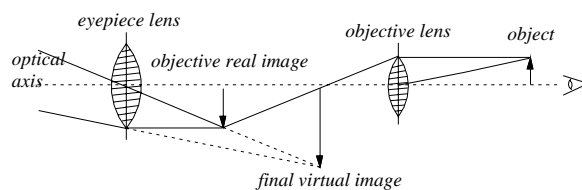
**compound;** an enclosure area at a South Africa diamond

deposit, in which the native workers lived.

**compound lens system:** composite lens made of two or more lenses with the same radius in order to minimize the aberration, which exists in a single lens. Used in microscope as objective or ocular. → Compound microscope.

**compound microscope;** the magnification in modern microscopes is carried out in two sections of lenses, first by the objective to magnify the image of the object and then by the ocular magnify the first image, as contrast to a simple microscope.

**compound microscope;** microscopes may be divided



compound microscope

into two sections, the optical system, the fundamental principles, of which, except for the substage condenser, and the mechanical side, the so-called stand. Also called compound lens system. → Microscope, compound lens system.

**compound operculum;** a marine plant-like flagellate of dinoflagellata operculum usually is divided into two or more pieces that are completely separable from one another.

**compressibility;** the property of pressure power, by which a material accepts reduction in volume. Compressibility of diamond is very high on the numerical scale 18, whereas for quartz are 267, and for steel are 68.

**compression of diamond;** → compressibility.

**compression of quartz;** → compressibility.

**comptonite;** an opaque, white, yellow, green variety of thomsonite, it has radiating aggregate and banded structure. SG: 2.37. Sometimes cut cabochon and as a curio stone. Found as pebbles in Good Harbor Bay, Lake Superior region, USA.

**computer program for gem identification;** a computer program containing a data bank about gemstone constants. Available through GIA, and Gem Testing Laboratory of Great Britain.

**concave;** an object with curved inward form.

**concave lens;** same as divergent lens. → Concave mirror.

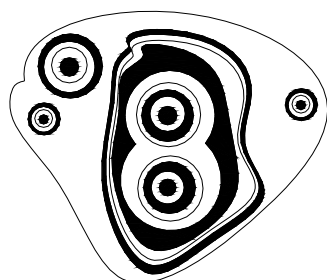
**concavo-convex;** same as double cabochon. → Cabochon.

**concentrate;** → concentrates.

**concentrates;** in diamond mining means such minerals of higher specific gravity that remain after crushing and separating the blue ground. Also spelled concentrate.

**concentration in water;** separating of relative higher specific gravity gravels by means of water, the fractionated gravels are known as concentrate.

**concentric;** a system, in which two or more materials having a common center such as concentric fracture or a common center of axis extending in all direction.



typical concentric rings on polished surface of malachite from Russia

**concentric weathering;** same as onion-skin weathering

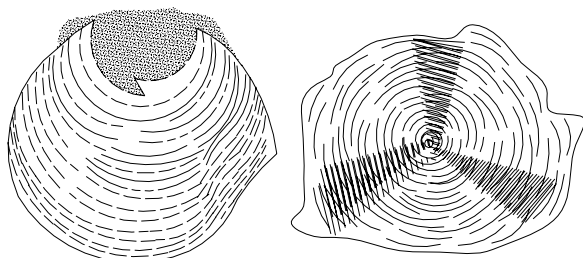
**conch;** a common name for any salt-water large, colorful, spiral-shelled gastropods, often of the genera *Strombus gigas* or *Cassis madagascariensis*, which produce conch pearl.

**conch;** a term sometimes used as a synonym for common queen conch from West Indies and Florida, has been used for cameos, in which the carved figures appear in pink against a white ground.

**conch, clam;** same as giant clam.

**conch, giant;** same as giant conch.

**conchiolin;** a horny, fibrous, dark brown organic scleroprotein of keratin type ( $C_{32}H_{48}N_9O_{11}$ ) secreted by the pearl mollusks shell, and a constituent of pearl (12%). The dark brown outer coating layer of the oyster shell is conchiolin, this layer is called *periostracum*, and the second layer is a *shelly layer* consisting of



conchoidal fracture in quartz and obsidian

prismatic columns of aragonite or calcite crystals. Also spelled chonchyolin.

**conchiolin coral;** black coral is composed primarily of

conchoidal an organic protein with a concentric circular structure in cross section, which known as tree-ring.

**conchiolin-rich pearls;** same as ligament pearl.

**conchoidal;** a shell shaped fracture. A term describing a fracture in a curved, ribbed, shell-like surface in glassy mineral or rocks.

**conchoidal fracture;** a type of mineral fracture that gives a smoothly curved, concentric ribbed surface, not unlike the shells. Conchoidal fracture can be seen in quartz, obsidian and flint.

**conchoidal limestone;** a limestone containing the shells of animals. Also called shelly limestone. Used as an ornamental stone.

**conchologist;** one who is versed in conchology.

**conchology;** the study and collection of mollusk shells and shellfish. It is well displayed of both fossil and existing animals.

**conch pearls;** a variety of non-nacreous pearls with a porcelain like surface, light orange-red or pink salt-water pearls obtained from the great conch, a univalves shell, or queen conch, or common conch *Strombus gigas* or large conch *Cassis cornuta*. SG:2.81-2.87. The pearls are of inferior quality and appearance and their sheen is like watered silk with *flames* marking effect on the surface. The shells are used for carving cameo. Conch pearls are alternatively called, helmet conch, cameo conch, or *pink pearls*. Sometimes is imitated by a bead of pink coral. → Flame pattern pearl.

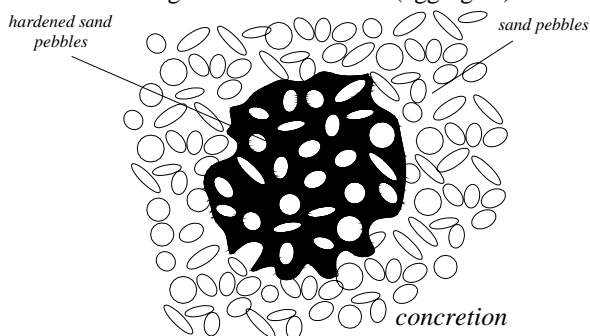
**conch pearl imitation;** pink conch pearl imitations are made of glass, which shows the *flames* marking on the surface. Glass is distinguished by bubble inclusions. Also made from pink coral or beads cut from the conch shell but without flames on the surface in both cases.

**conch shell;** same as conch.

**chonchyolin;** same as conchiolin.

**concrete;** a term used by Australian miners as another term for bandstone.

**concretion;** any hard, compact accumulation of various rounded or irregular mineral masses (aggregate) formed



within pores, which are different in composition from the sedimentary rock that surrounds them.

**concretion limestone;** any hard, compact accumulation rounded of irregular limestone masses (aggregate).

**concussion mark;** same as percussion mark. → Bruisse.

**Condé Diamond;** same as Grande Condé Diamond.

**condenser;** a lens or lens system used in microscopes to collect the light from an object and project it onto another objects. → Substage condenser.

**condenser,-substage;** → substage condenser.

**condensing lens;** a simple lens for obtaining convergent light.

**condition of diamond;** same as diamond condition.

**conduction;** same as heat conduction.

**conduction band;** an energy band in a semiconductor crystal or solid material in which electrons can move freely in it and producing net transport of charge. → Band theory.

**conduction detector, audio;** a device for detecting electrical conductivity in diamonds. By using the earphone, when the circuit is closed and by touching the two contact probes on the stone if a scratching sound is heard as thing are moved across the stone surface, than the stone is a conducting type.

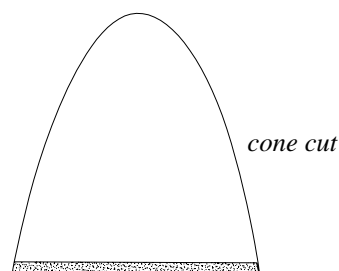
**conductor coloration;** to the mineral with typical luster ascribed the free movement of the outer electrons from one atom to another atom, which causes the conduction of heat and electricity. This effect in metals is responsible for high reflection, opaqueness, and these results in the differences in the color of copper, silver, gold, etc. An organic conductor is nitrogen, which occurs as trace inclusions in diamond and act as *donors*, while the light is absorbed in the violet region and it is believed to be the cause of the yellow tints in cape stones, such diamonds are classified as Type Ib or *canary diamonds*. When the content of nitrogen is in greater quantity than described the diamonds are classified as Ia, which have no more the donors function. Completely nitrogen free diamonds are classified as Type IIa, and IIb. Diamonds of the Type IIb contain boron, are semi-conductive and usually blue in color. → Diamond types I and II, type classification, Color,-definition.

**conductometer;** an ordinary device for detecting electrical (and heat) conductivity in materials and diamonds, is useful to determinate whether a diamond is Type IIb. Only the diamond Type IIb is found occasionally in blue color in nature.

**Conductor 2000;** a brand new diamond conductor which is running from battery used thermal and electrical conductivity tester for discriminating zircona, colorless sapphire, natural diamond, synthetic diamond and synthetic moissanite. Works for all colors, sizes, shapes, fashioned and rough stones.

**cone-shaped cut;** a modified cabochon cut with an

acute dome topped form, which is more higher than



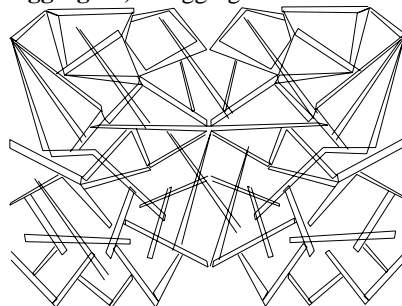
normal cabochons.

**confection of hyacinth;** → giacinto.

**Confédération internationale de la bijouterie, joaillerie, et orfèverie des diamants, perles et pierres;** an international organization of jewelry, silverware, diamonds, pearls and stones, which was founded in Paris in 1961. Abbreviation: CIBJO.

**confused;** irregular, indistinct, mingled together.

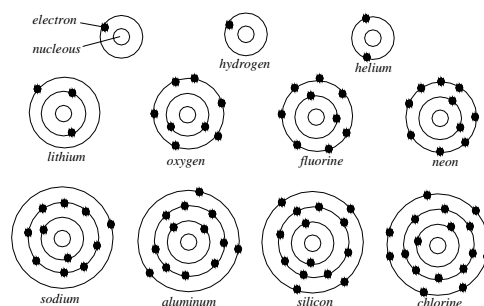
**confused aggregate;** → aggregate.



*confused aggregate*

**configuration;** the three dimensional spatial arrangement that is fixed by chemical bonding in a stable or instable molecule

**configuration of atoms;** the arrangement of atoms in the Periodic Table of the Elements beginning with the simplest element hydrogen to the larger atoms such as



*configuration of atoms. Nucleus: positively charged protons surrounded by negatiely charged orbital electrons*

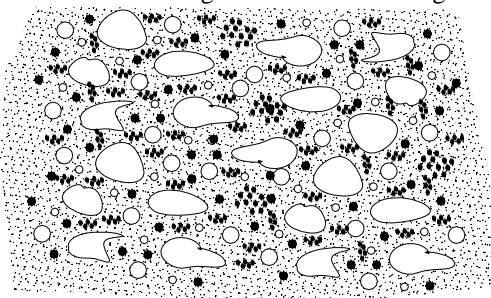
actinides.

**cong;** a Chinese term for a cylinder carved from jade, ended in a rectangular tube used as worship celebration of the God of the Earth. → Chinese ritual and symbol

jades.

**congelifraction**; same as frost blasting.

**conglomerate**; a cemented, coarse-grained, clastic rocks or minerals embedded in a fine-grained matrix of silt, sand or other materials, containing rounded fragments of gravel or pebble size, larger than 2 mm. Also referred to as puddingstone, millstone. Sometimes being cut and polished. Alluvial diamonds are sometimes found in conglomerates. → Pudding stone.



conglomerate

**conglomerate marble**; coarse-grained rounded fragments of gravel or pebble size cemented and composed of limestones. Used to make vases and cladding stones.

**Congo bort**; any industrial diamond or bort from Congo.

**Congo copal**; a natural, hard, yellowish to colorless, amorphous fossil resin, derived from certain trees of the genus *Copaifera*. SG:1.06-1.07. Soluble in benzene, turpentine, ether, and chloroform. Found in the Congo and used as a substitute for amber and in making varnish. Synonym Congo gum.

**Congo diamond**; same as Congos.

**Congo emerald**; a misleading term for diopside from Congo, Africa. Also spelled Kongo emerald and called Congo emerald.

**Congo gum**; same as Congo copal.

**Congo ivory**; a misleading term for an imitation ivory made in South Africa.

**Congo marble**; a misleading term for grayish to dark-green serpentine of gem quality from Congo, Africa.

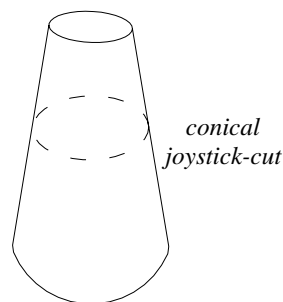
**Congo rounds**; any spherical- or near-spherical-shaped diamonds from Congo.

**Congos**; used as a term for a variety of diamond from Congo diamond districts. Congos are opaque to translucent, white to gray green and yellow, drusy-surfaced, translucent to opaque diamonds. The term applies to all diamonds having the appearance and characteristics of those Congo diamonds.

**conical**; same as cone shaped. A term in mineralogy used for an elongated cone, as are most icicles.

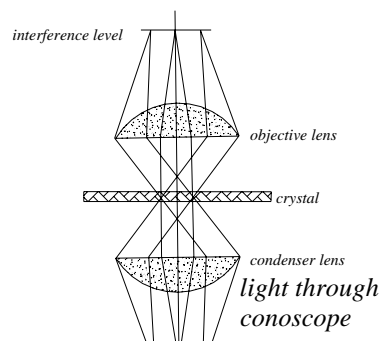
**Connemara marble**; a misleading term for dark-green to grayish serpentinous Marble or calcite of gem quality

found in Galway, Eire, Ireland. RI:1.56. SG:2.48-2.77. Also called verde antique. → Ophicalcite, serpentine.



conical joystick-cut

**conoscope**; a polariscope that contains a Bertrand lens for examining the interference figures produced by



crystal, gem, and minerals in convergent polarized light.

**conoscopic**; an arrangement of a polarizing microscope for creating the interference figures of minerals.

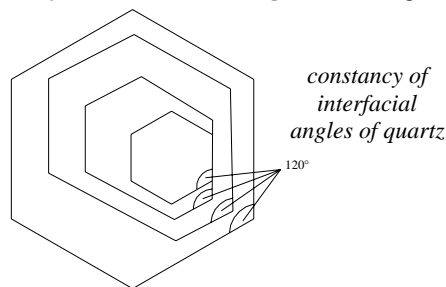
**consecration ring**; same as bishop ring.

**Consolidated African Selection Trust, Ltd.**; a diamond-mining corporation operating in Ghana, Africa. Abbreviation: CAT.

**Consolidated Company Bulfontein Mine Ltd.**; a diamond mining company and owner of the Bulfontein Mine, South Africa.

**Consolidated Diamond Mines of South-West Africa, Ltd.**; the largest diamond mining corporation in the world that operates exclusively in the alluvial deposits of South-West Africa. Acronym: CDM.

**constancy of interfacial angles**; the angles between



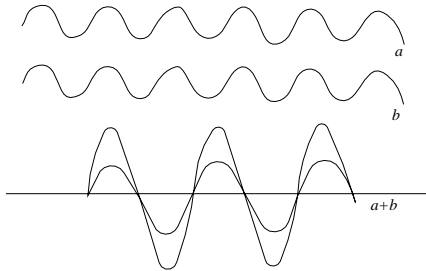
constancy of interfacial angles of quartz

corresponding faces on different crystals of one chemical composition have a constant value.

**Constantin Diamond;** an emerald-cut, flawless diamond of 46.05 cts, was sold in 1970 in Geneva.

**constringence;** same as reciprocal dispersion.

**constructive reinforcement;** when two phases of light



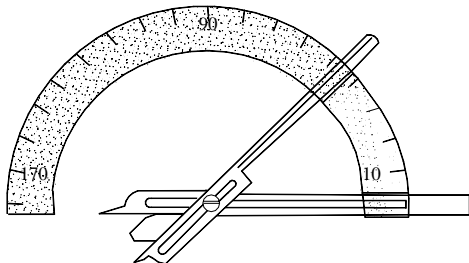
*constructive reinforcement and destructive cancellation of wavelength*

wave with the same wave-crest arriving at a specifies point, then electric field will, add and the result is a double amplitude as seen in figure below. → Destructive cancellation, interference of light.

**contact;** the surface between two fluids such as oil and water.

**contact angle;** the angle included between the surface of a liquid and the surface of a solid object or at any point along their line of contacts. Also known as angle of contacts.

**contact goniometer;** an instrument for measuring the

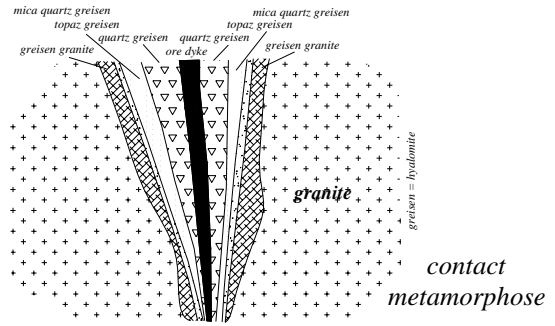


*contact goniometer*

angle between adjacent crystal faces. → Goniometer.

**contact liquid;** any standard liquid that is used as a contact liquid for refractometers, which has a constant refractive index and makes good optical contact between the test surface of the critical angle refractometer prism and the facet of the gemstone by excluding air. → Anderson and Payne liquid, West's solution, Clerici solution.

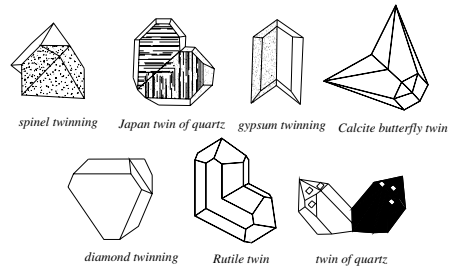
**contact metamorphism;** the process of alteration of rock caused by thermal metamorphism associated with igneous intrusion (extrusion) that is taking place in rocks at or near their contact with a body of magmatic rock.



**contact mineral;** any mineral that is formed by contact metamorphism process. → Metamorphism.

**contact photograph;** → immersion contact photograph.

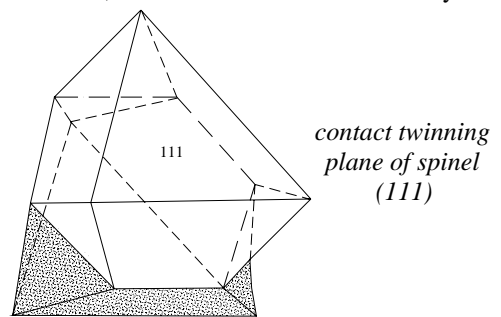
**contact twinning;** the simplest type of twin, where two



*different form of contact twinnings*

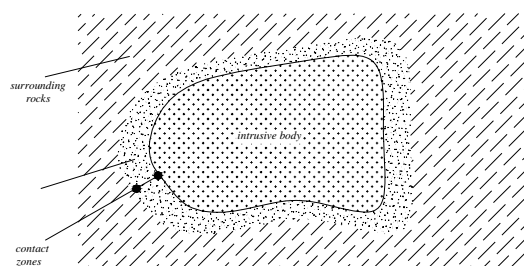
individual of crystals are symmetrically arranged about a twin plane (180°). In diamonds, a contact twin is called a *maclé*. Also called *juxtaposition twin*, *spinel twin*, simple twin or simple contact twin.

**contact twinning plane;** the plane of the simplest type of contact twin, where two individual of crystals are



*contact twinning plane of spinel (111)*

symmetrically arranged about (111).



*contact belt formed due to contact metamorphism*

**contact zone;** a local term for top of the pipe of the

Finsch mine (in South Africa), which lies between 4.9 to 4 m of mixed kimberlite and ironstone rubbish known as the contact zone.

**contact zone;** a zone surrounding an igneous intrusion in which contact-metamorphism of other rocks has taken place.

**containing;** same as bearing.

**containing agate;** same as agatiferous.

**containing augite;** same as augitic.

**containing blende;** same as blendeous or blende.

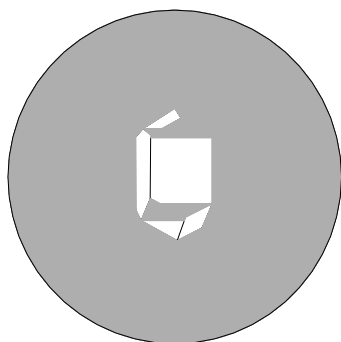
**containing garnet;** same as garnetiferous.

**containing hornstone;** same as corniferous.

**containing mica;** same as mica-bearing.

**containing silver;** same as argentiferous.

**contemporary inclusion;** inclusions, which developed, originated, or existed at the same time as the host



*a typical contemporary crystal inclusion in Sri Lanka sapphire*

mineral. Also called syngenetic.

**continental jewels;** a commercial term for synthetic strontium titanate. Used as a diamond imitation.

**continuous spectrum;** an uninterrupted rainbow of colors (wavelengths) from red to violet, which is visible in the continuous spectrum of white light or can be



*continuous sun absorption spectrum*

produced by incandescent solids. Also called Newtonian spectrum.

**contra-luz opal;** a slightly blue, milky opal variety from Brazil, which resembles water opal. The play-of-color is visible by transmitted and reflected light.

**contraction fissure;** → Cooling fissure

**convergent lens;** a lens, which increases the

convergence of light rays, because the lens is thicker at the center than at its edge. Also known as convex lens, converging lens.

**convergent polarized light;** a converging lens placed above the polarizer and below the rotating stage in polariscopes, which transforms plane polarized light into convergent also used for the production of interference figures. Polarized light tending to one point or focus.

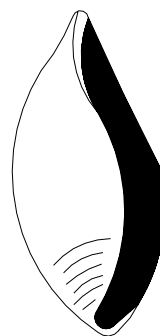
**converging lens;** same as convergent lens.

**converse effect;** same as reverse effects.

**convex cutting;** same as cabochon cutting.

**convex lens;** → convergent lens.

**convolute;** a kind of pearl bearing cephalopod fitted



*convolute*

with a few striated curved bowl hinged on the top of the front of a blade.

**Coober Pedy opal;** a white to slightly gray opal of precious quality found in sandstone and claystone matrix in Coober Pedy, South Australia. Resembling White Cliffs opal in appearance.

**coocoran;** a term used by Australian miners for a fine-grained, whitish sandstone which when exposed to the air on the surface becomes silicified and hardened. Also called shincracker.

**cooked;** a peculiar inclusion can be seen in some diffusion treatment corundum, in which chromophores are cooked into the gemstone as a thin layer near-surface color. This can be revealed under immersion in diffused illumination.

**cooking;** a style of heating of zircon, which is carried out by natives for between 1½-2 hours at a temperature 900° C-1000° C. Also cooking opal in a sugar solution and later treating it with sulfuric acid, which produces a black background due to carbonization of the sugar and known as *carbonizing*.

**Coolidge hot cathode;** another term for electron tube in X-rays.

**cooling crack;** crack which is formed as a result of cooling of an igneous rock or other substances such as glass. → Cooling fissures.

**cooling fissures;** fissures which are formed because of



cooling or drying of rock or other substances such as glass due to contraction. Also called contraction fissure. → Cooling crack.

**cooling striae**; curled or whorl lines seen in most glasses, caused by irregularities in mixing, used as gem imitations.

**cool opal**; opals of blue, green plus red, orange colors less vivid than warm opal.

**Cooperative Africaine de Recherches et d'Exploitations Diamantifères**; a society of African diamond Prospectors in Ivory Coast.

**Cooperative Bekima**; a cooperative of African miners in Guinea, was founded in 1957.

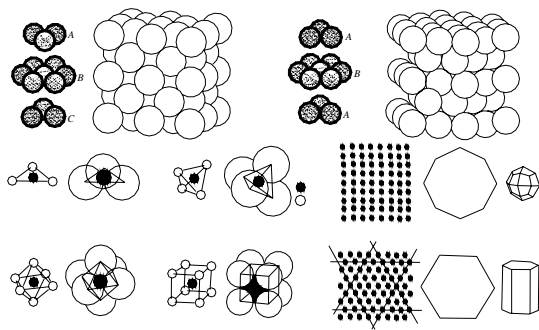
**cooperative charge transfer**; same as intervalence charge transfer.

**coordinate**; a defining point in space or on a particular plane by reference to a fixed system of lines, etc.

**coordination**; a term used in crystallography to a crystal lattice in which each ion has the same relation to the neighbor ions in all directions. Also called coordination lattice.

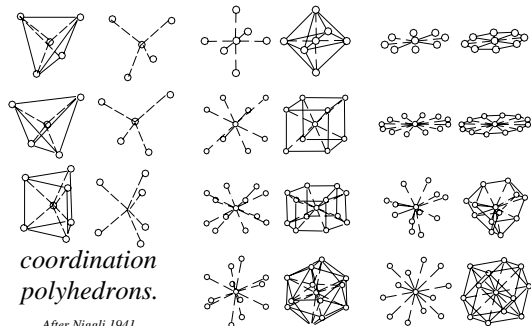
**coordination lattice**; same as coordination.

**coordination number**; a term used in crystallography to the number of nearest neighbors of a given atom in a



coordination of crystal structures

space lattice surrounded by molecules, atoms or ions. For example a silicium cation is surrounded by four oxygen anions (tetrahedron) and an oxygen anion surrounded by two silicium cation. In such crystal structure each anion or cation tends to coordinate to



coordination polyhedrons.

After Niggli 1941

gather to itself, as many ions of opposite charge as size

permits, this joining with their center outline gives a geometric figure known as *coordination polyhedron* such as sodium chloride in which each cation is surrounded by six anions and each anion is surrounded by six cations. In a square-planar feature, the central ion has a coordination number four. In a close-packed crystal, the coordination number is twelve. → Close packing crystal.

**coordination polyhedron**; → coordination number.

**co-ox**; a term applied to green cubic zirconium oxide.

**Copaifera, australis**; → copal.

**Copaifera guibourthiana**; a kind of leguminous tree of the family copal-bearing Caesalpiniaceae from Sierra Leone and Congo. → Sierra Leone copal.

**copal**; a Spanish-Mexican term for a wide variety of semitransparent, of various hardness, brittle, conchoidal fracture, colorless, light-yellow, reddish to yellowish-brown, resins resembling amber and having a similar consistency to it. A recent fossil of 40,000,000 years old from various tropical trees such as kauri pine *Copaifera, australis*, *Hymenaea courbaril* and *Agathis australis*, being nearly soluble in alcohol, ether, turpentine and linseed oil. Used for varnishes, lacquer and as imitation amber. Copals fluoresce in white color under SWUV. It is distinguished from amber by its lighter weight. Found in the Philippines, New Zealand, Sierra Leone, Australia, East Indies, and Africa. Copals occur in two varieties, *true copal* and freshly obtained resin, which is named *raw copal*. Also called gum copal and kauri gum, copal resin. → Leguminous tree, Leguminous tree hymenaea.

**copal amber**; oblate or barrel-shaped African beads made of copal resin mostly from east coast used by native tribes as jewels. Also erroneously called African amber.

**copal resin**; same as copal.

**copal, pressed**; → pressed copal.

**copaline**; same as copalite.

**copalite**; a clear, pale yellow, dirty-gray, or dirty-brown vegetable resin, resembling copal and having similar hardness, color, and transparency. Nearly solubility in alcohol, ether, turpentine and linseed oil. Containing succinic acid, and emits a resinous aromatic odor, when broken. Used as an imitation for copal. Synonym for copaline, and fossil copal.

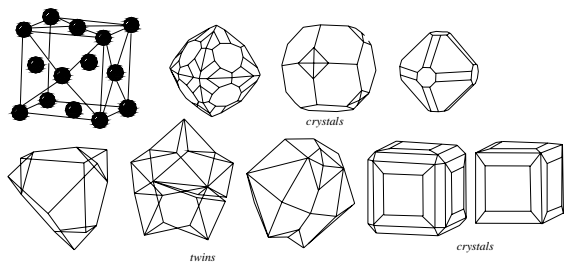
**Copenhagen Blue Diamond**; a blue, emerald-cut diamond of 45.85 cts, was fashioned from a stone found at the Jagersfontein Mine, South Africa. It was named after exhibition in Copenhagen in 1960. Present owner unknown.

**Copeton**; location of a diamond mine in New South Wales, Australia.

**copper**; a bright, soft, reddish, ductile, metallic element

with the symbol Cu. One of the eight metallic elements mainly responsible for color in minerals. Used as alloys such as brass and bronze, gold, silver, and other alloys. As a color agent, it occurs in many idiochromatic gemstones such as azurite, malachite, chrysocolla, azurmalachite, etc. Rarely occurs as allochromatic minerals.

**copper**; a natural copper mineral  $4[\text{Cu}]$ , containing small amount of Ag, As, Bi, and Hg. Cubic system. Copper red on fresh surface. Metallic luster, usually dull. Fracture hackly. Ductile and malleable. SG:8.94-



copper structure, crystals and twins

8.95. H:2½.

**copper arsenite**; a light green pigment powder  $\text{Cu}_3(\text{AsO}_3)_2 \cdot 3\text{H}_2\text{O}$ . Soluble in acids. Insoluble in water and alcohol. Used as dyes. Also called scheele's green, cupric arsenic, copper orthoarsenite.

**copperas**; a local term used in England by jet polishing worker, which is a mixture of jeweler's rouge and oil.

**copper as inclusion in glass**; → aventurine glass.

**copper blue**; incorrect name for chrysocolla.

**copper coloration**; → copper.

**copper emerald**; a misleading term for diopside from Congo. Also called Congo emerald.

**copper enamel**; an enamel used in glass and porcelain manufacture for design and application to prepare copper surfaces.

**copper glance**; → chalcocite.

**copper green**; incorrect name for chrysocolla.

**copper lapis**; a misleading term for azurite.

**copper malachite**; a misleading term for chrysocolla.

**copper-nickel-zinc**; same as German silver.

**copper orthoarsenite**; → copper arsenite.

**copper pyrite**; another term for chalcopyrite.

**copper-ruby glass**; copper contained glass is blue green in color due to  $\text{Cu}^{\text{II}}$ . The color change to red when reducing agents such as  $\text{SnO}_2$ , carbon, or tartrates are added to the glass. Also called sang de boeuf, ox blood.

**copper salts**; → acetate of copper dye.

**copper spectrum**; monovalent cuprous causes red color stones and divalent cupric copper causes blue or green stones. Divalent cupric copper found in turquoise, malachite and azurite. Turquoise has absorption bands

in the blue at 460, 432 nm and in the violet at 420 nm.

**cooper sulfate liquid as filter**; sometimes copper sulfate solution is used as a filter, when the light is directed on to the stone through liquid, for example alexandrite shows a red fluorescence.

**copper vitriol**; another term for chalcantite.

**Coptos emerald**; an old emerald district in ancient Egyptian, near Copt or the city Qift on the Nil River, north of Thebes.

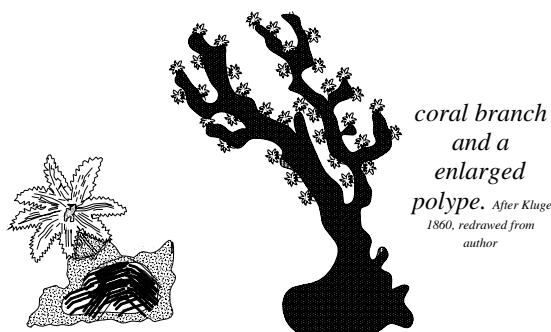
**coque de perle**; a French term for natural pearl shell.

**coque de perle**; suitable pieces cut as an oval form of the rounded whorl of the nautilus shell *Indian nautilus*, which resembles to some extent a blister pearl, and being a mother-of-pearl bubble. Such pearls are porcelain-white with weak luster, irregular or pear-shaped. The shells have a thinner skin and are hollow inside and are usually filled in with wax or cement mass. Also called osmenda pearl, eggshell pearl.

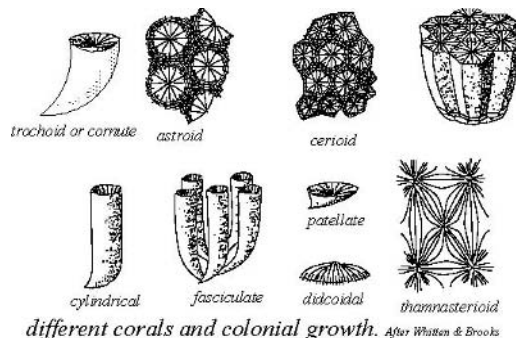
**coraffine**; a commercial term for abrasive material from corundum.

**corail**; a French term for coral.

**coral**; a general term for any semitransparent to opaque, branching plant-like, large group of bottom-dwelling,



marine organic origin (polyp a primitive type of animal of zoophyte) that belong to certain colonial *anthozoa* (*phylum coelenterata*) and some *hydrorhizae*, either solitary or, more commonly, growing in colonies of countless individuals. Corals are composed of the remain of skeletons of millions of very small coral



polyps in the form of colonies. Usually found in light

red to dark red *ox-blood coral*, orange, flesh-colored, white, cream, brown, blue, or black of calcium carbonate it is the form of calcite ( $\text{CaCO}_3$ ) with 3%  $\text{MgCO}_3$  plus traces of iron oxide, and this *wood-grain* structure radiates from the center of each branch. The red color is caused by iron oxide or may be organic partly or both. RI:1.486-1.658 (black coral from Hawaiian about 1.37, for white and pink coral 1.34). Birefringence: 0.172. SG:2.60-2.70. H:3-4. The precious coral is known scientifically as *corallium rubrum* or *corallium nobile* and has long been popular for beads in the manufacture of necklaces, cabochon, bracelets and rosaries and for carved objects and figurines as cameos or intaglios. Sometimes used as an imitation for pink conch pearl. Imitations for coral are coral red glasses, stained or not stained coral dust cemented together, porcelain, dyed shell, stained calcined bone, stained vegetable ivory, powdered gypsum or limestone or rubber mixed with isinglass and cinnabar or lead oxide, and plastics. Some corals are *dyed* to improve color and appearance, which is similar to *angle's-skin coral*, such colored stones can be discriminated by wiping the surface with a nail-polish moistened cotton ball, which removes amyl acetate. Imitation coral is manufactured by Gilson Company, France, from limestone powder mixed with a small percent of pigments by high pressure and some heating, produced in several colors. Natural gem corals are found in the Mediterranean Sea, Persian Gulf, Australia, Japan, Malaysia, Korea, Hawaii, China, and Ireland. Also called scorpion stone.

**coral agate;** an agate resembling coral, or agate pseudomorphous after coral with flesh-red background. A variety of beekite.

**coral, blue;** same as *Allopora subiroleca*, akori coral.

**coral, classification of;** rough corals suitable for fashioning are graded in Italy into different colors: 1-*bianco* that is pure white (*Oculinacea vaseuclosa*) valued in Orient. 2-*Pelle d'angelo*, which is rose-red. 3-*Rose pallido* is a pale rose color coral. 4-*Rosa vivo* that is a bright rose. 5-*Secondo coloro*, which is salmon rose. 6-*Rosso* appeared red (*Corallium rubrum*). 7-*Rosso scuro* is a dark red coral, and 8-*arciscuro* or *carbonetto*, which is very dark red with the name *ox-blood coral* valued in United States.

**coral cut;** a popular stone for beads, which are manufactured as necklaces, cabochon, bracelets, rosaries and for carved objects and figurines as a cameo or intaglio. Polished pieces with natural shape, drilled crossways called *Arabian beads*.

**coral imitation;** imitation corals are made from glasses, dyed shell, plastics, and by barium sulfate together with a plastic. Gilson company in France make coral

imitations from calcite and small percent of pigments by high pressures and heat.→ Gilson-created coral.

**coral jade;** in China a color grading or quality for jade resembling coral.

**coral limestone;** a limestone composed of coral fragments. Synonym for coralline limestone.

**coral, red;** same as *Corallium rubrum*, red coral.

**coral, trade classification of;** trade terms for classification of coral are: 1-*Sardinian* hard, excellent-quality of red. 2-*Italian* good quality in all shades ranges from white to red. 3-*Moro* fine-quality dark red of Japanese type. 4-*Tosa* an average of Japanese. 5-*Sicilian* a lower-quality of Mediterranean. 6-*Algerian* from quality same as Sicilian.

**coral, white;** same as *Oculinacea vaseuclosa*, white coral.

**coralli;** an Italian term for coral.

**corallaceous;** composed or pertained of coral.

**coralliferous;** composed or pertained of coral.

**coralliform;** having the form or appearance of coral.

**coralline;** an aniline-dyed red chalcedony.

**coralline;** any stone resembling coral in color or in form.

**coralline;** composed or pertained of coral.

**coralline algae;** → coralline marble.

**coralline limestone;** → coralline marble, coral limestone.

**coralline marble;** a rouge, gray, and black marble containing remains of fossilized coral or *coralline algae*, which occurs as a diverse large-scale pattern. Varieties from Belgium are called *rouge-et-gris marble* and *rouge royal marble*. Also called algal marble, coralline algae. → Rouge de rance.

**corallite;** the skeleton of an individual coral polyp.

**corallium nobile;** same as precious coral. → Coral.

**corallium rubrum;** same as precious coral. → Coral.

**coralloid;** in a cave, a nodular formation of calcite. Having the form or appearance of coral.

**corallum;** the hard skeleton of a coral polyp.

**coral reef;** a wave-resistant variety of calcareous reef bank composed mainly of fossilized coral skeletons, which live in colonies in tropical climates. When it is polished, it shows irregular, reddish sprinkles and streaks.

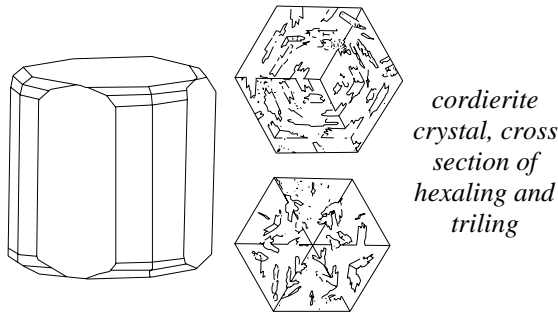
**coral rock;** a term used for coral-reef limestone.

**Coral Sea mv;** location of diamond mining in South Africa, in which rotating drill is used for extraction of the marine gravel.

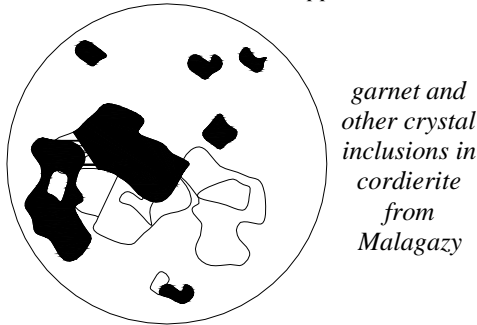
**coral tree;** → carat.

**cordierite;** a dimorphous mineral with indialite. Strong trichroism. Gem variety is called iolite. Absorption spectrum bands are at 645,593, 585, 535, 492 and 426 nm. Parallel orientation of hexagonal plates of hematite

or goethite inclusions in cordierite cause the red color



and pseudo-dichroism is known as *bloodshot iolite*. Also Known as dichroite, violet stone. Sapphire blue color is misnomered as *water sapphire*. Varieties of



iolite are: lux-sapphire, lynx sapphire, lynx stone, iron-rich is known as sekaninaite.

System: orthorhombic.

Formula:  $4[(Mg,Fe^{+2})_2Al_4Si_5O_{18}]$ .

Luster: vitreous.

Colors: green, greenish-blue, blue, violet, yellowish to yellowish green, brown.

Streak: colorless to greasy.

Diaphaneity: transparent to translucent.

Cleavage: {010} distinct, {001} indistinct, {100} indistincts.

Fracture: conchoidal. Brittle.

SG: 2.55-2.78.

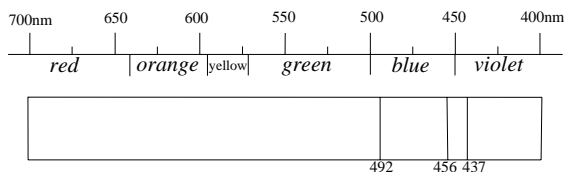
H: 7-7½.

Optics:  $\alpha$ :1.522-1.558,  $\beta$ :1.524-1.574,  $\gamma$ :1.537-1.578.

Birefringence: 0.018.  $\oplus$  may  $\ominus$ .

Dispersion: 0.008-0.017.

Found in Greenland, Sri Lanka, Tanzania, Namibia,

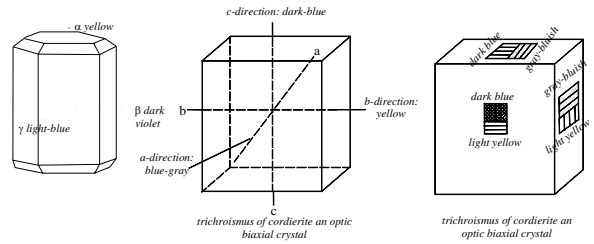


cordierite absorption spectrum

Colombia, Australia, India, Canada, Brazil, and USA. **cordierite absorption spectrum;** weak bands at 645, 593, 585, 535, 492 and 426 nm.

**cordierite inclusion;** in cordierite from Malagasy are some garnet and other crystal to seen.

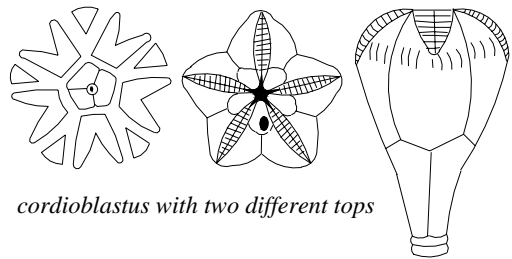
**cordierite pleochroism;** strong. Fe-rich are colorless



three-chroism effect in cordierite a biaxial crystal

and violet. Mg-rich stones light yellow to green, light blue and violet blue.

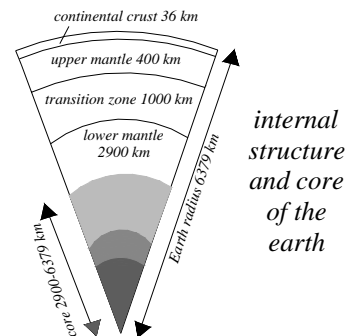
**cordioblastus;** a micro-organic calcareous, button-like plates with five-rayed star on top, warm water leaving,



cordioblastus with two different tops

found in chalk.

**core;** the central interior zone of the Earth's below the Gutenberg discontinuity at a depth of 2900 km to the center of the Earth. It is separated into inner core and outer core units with a transition zone in between. Apparently, only compression waves traverse the core. It is composed of iron and nickel (hence the acronym



internal structure and core of the earth

NiFe), with a lighter element, probably sulfur. The inner core is a solid with a radius of about 1220 km

starting at 5000 km depth. The density of the core ranges from 9.5 to 14.5, and possibly higher. Also known as barysphere or centrosphere. The outer core is liquid however does not permit the passage of shear waves (S-Waves). It is estimated that the temperature is more than 2700° C. The pressure is of  $3.5 \times 10^6$  bars. Also known as earth core, core of the Earth.

**Corean jade;** same as Korean jade.

**cored;** → shell crystal.

**cored crystals;** same as shell crystal.

**core drill;** the act or process that cuts and removes a cylindrical core from the hole, and brings it to the surface. → Core drill sample.

**core-drill sample;** one or several pieces of whole or split parts of cylindrical samples of rock in the form of core.

**cored jet;** another term for soft variety of jet.

**cornea;** the transparent part of the outer coat of eye, which covered the iris and pupil. → Eye.

**core of the Earth;** same as core.

**core zoning;** a color phenomenon in yellow andradite in which a green color was found near the center of stone and exterior color was yellow.

**corindite;** a commercial term for an artificial abrasive material made from corundum.

**corindon;** same as corundum.

**corkscrew;** a term used by Australian miners for round work at bottom of chamber of a shaft.

**corkscrew;** a term used by Australian miners for a twist work of a shaft as it is being sunk.

**cornalina;** a Spanish or Portuguese term for carnelian.

**cornaline;** a French term for carnelian.

**cornelian;** another spelling for carnelian.

**corneol;** a pink dyed variety of chalcedony. Same as carnelian.

**corneous;** same as corniferous or containing hornstone.

**corner;** a term applied by cross-cutters to 8 main facets, excluding table and culet, such as first corner, second corner, etc.

**cornerina;** a Spanish term for carnelian.

**Cornflower Blue Diamond;** a fancy blue, flawless, pear-shaped diamond of 31.92 cts, was cut from a 158.00 cts, rough stone. Present owner unknown.

**cornflower blue sapphire;** a fancy bright blue sapphire from Sri Lanka, paler than royal blue.

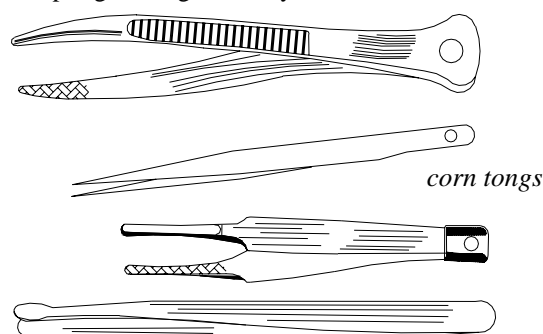
**corniferous;** containing hornstone.

**Cornish diamond;** a misleading term for rock crystal from Cornwall, England.

**Cornish stone;** a variety of clay from Cornwall, England, used as a bond in the manufacture of pottery.

**corn tongs;** tongs are for the handling of gemstones, made of stainless steel, with rather blunt, rounded tips, scored inside to prevent the stone slipping, and with a

mild spring. In England, they are called tweezers. In the



USA, a term infrequently used to describe pearl tongs.

**choroids;** → eye.

**coro pearl;** a term for imitation pearl.

**Coromandel;** an alluvial diamond-bearing district in western Minas-Gerais, Brazil.

**Coromandel;** a composite work like inlays, overlays, and appliquéés. → Appliquéés.

**Coromandel Diamond 1;** a colorless diamond of 180 cts, found in 1934 in Coromandel, Minas-Gerais, Brazil.

**Coromandel Diamond 2;** a colorless diamond of 141 cts, found in 1935 in Coromandel, Minas-Gerais, Brazil.

**Coromandel Diamond 3;** a colorless diamond reported with two different weights 226 or 228 cts, found in 1936 in Coromandel, Minas-Gerais, Brazil.

**Coromandel Diamond 4;** a colorless diamond of 400.65 cts, found in 1940 in Coromandel, Minas-Gerais, Brazil.

**Coromandel Diamonds;** four large diamonds from Coromandel District, in Minas-Gerais, Brazil. they are mentioned under Coromandel Diamonds 1-4.

**corona;** have a less intense electric discharge whereas appearing as a bluish-purple glow in form of a crown or halo on the surface, therefore cannot produce a spark or lightning in a gas. Also called aurora, electric corona, corona discharge.

**corona discharge;** → corona.

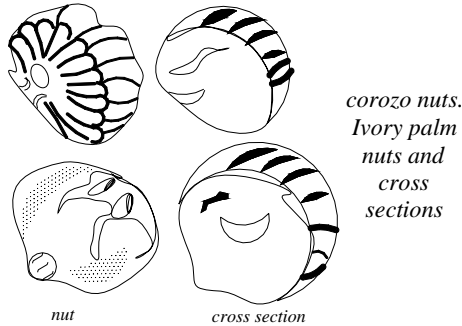
**coronal;** a crown-like cirlet for the head made of gold and set with gemstones worn by noblewomen or peeresses.

**coronet;** a local term for dravite from Crown Point, New York, USA.

**coronite;** a small crown-like ornament for the head made of gold and set with gemstones worn by noblemen or peers and peeresses but lower than a sovereign.

**corozo nut;** a commercial term for one of two substances known by the general term vegetable ivory the other being *doom-palm nut*. A hard, aggregated, white kernel of the ivory palm *Phytelephas macrocarpa*

or *homero pullipunta*, which resembles ivory and is often used as imitation for elephant ivory and coral. The nut is as large as a hen's egg and its composition is



nearly pure cellulose or *albumen* a resistant carbohydrate:  $C_6H_{10}O_5$ . RI:1.583. SG:1.40-1.43. H:2½. Weak fluorescence under UV light. Found in Peru, Brazil, Colombia, and other South American countries. It has local names such as *anti* in Coast of Darien, and *tagua* in Colombian. There is another tree with the name doom palm nut with the shape of a fattened hen's egg size kernel. The palm is often called *gingerbread palm*. It is known as doum-palm ivory. → Doum palm nut.

**corpse pearls;** a tradition of Chinese in Sumatra where they buried pearls with the dead, one pearl in the mouth and one in each eye.

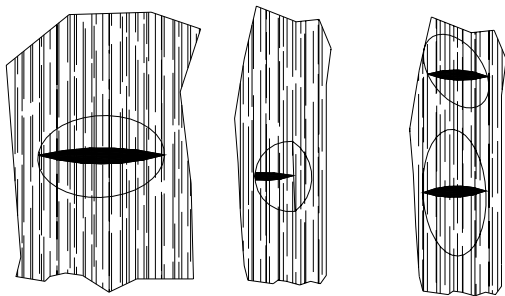
**corpuscles;** → corpuscular theory of light.

**corpuscular theory of light;** a term used in optics for light consisting of minute particles or corpuscles in rapid motion.

**corrasion;** the act or process of erosion, specifically, the removal of soil or rock by mechanical action or worn away by the abrasive action of solid materials. Also called mechanical erosion, cutting.

**corrasion;** a misnomer for corrasion.

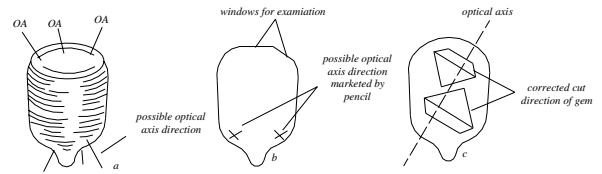
**correct cat's-eye;** gemstone when cut correctly en cabochon perpendicular to fibers, and put under a single, strong source of light exhibits a sharp, narrow,



correct and incorrect cut cat's-eyes

well-defined chatoyant band or streak, that moves across the summit of the gemstone and shifts from side to side as the gem is turned under the light.

**corrected cut direction of gems;** transparent and fine-



corrected cut direction of ruby gem. a: a synthetic boule of ruby, b: polishing windows for examination of correct optical axis direction and c: orrect direction for cutting gems

quality of corundum such as ruby, sapphire, or *padmaragaya* the orange colored corundum or other varieties has been cut as brilliant, mixed cut, step cut, cut as star rubies, star sapphires and cabochon, asterism or with cat's-eye. In which the direction and thickness of the stone is very important.

**corrected loupe;** → loupe, corrected.

**correlation between density and chemical composition of gems;** correlations between specific gravity and chemical composition of gemstones are direct and are based on chemical and structural differences. In two graphs of tourmaline can be seen interrelations between specific gravity and Fe + Mn content, and interrelations between specific gravity and birefringence. → Correlation between optical and physical properties of gems.

**correlation between optical and physical properties of gems;** correlations of gemstones are indirect and are based on chemical and structural differences in four relations: I- correlation of refractive indices with color, II- increasing of refractive indices with saturation of body color, III- varying of refractive indices and birefringence with specific gravity, IV- varying of optical and properties with cell dimensions.

**corroded crystal;** an igneous crystal that after crystallization is more or less fused again into the magma.

**Corrombe;** a mining term for a wooden platter 40 cm in diameter used for carrying away the diamond-bearing gravel in Brazilian Mines.

**corrosion;** the act or process of corroding, specifically, the removal of soil or rock by the solvent or chemical action of running water. Compare corrasion.

**Corsican green;** a green schiller rock similar to bastite composed of diallage and feldspar, used as a substitute for ornamental gems and carving objects from Corsica, France. Also called verde de Corsica, and verde de Corsica duro.

**corsite;** an orbicular variety of gray diorite or hornblende gabbro clan. The orbiculars are light colored. Found in Island Corsica, France. Used as an

ornamental stone for vases, etc. Also called napoleonite, miagite.

**Cortez Emeralds;** Hernando Cortez, one of the Spanish Government in 16<sup>th</sup> century in Mexico who reported in 1552 from an enormous pyramidal shaped emerald was mounted on a skull in the Hall of Justice in Texcoco used by Aztec judges. It was adorned by many gems and known as the Tribunal of God. At least possessed by Francis I, King of France. After his return to Spain, he brought numerous good quality emeralds and presented some costly carved emeralds to his bride Doña Juana de Zuniga. Another Cortez Emeralds are: Emerald of Texcoco, Goddess of Emeralds. → Tezcuco.

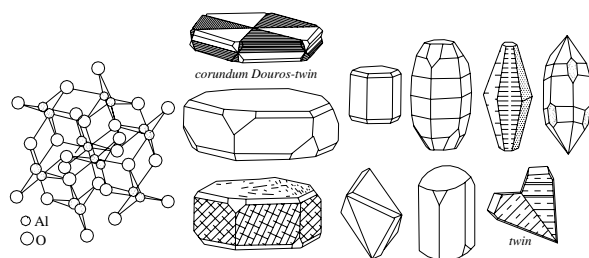
**corundite;** a trade term for colorless synthetic corundums used as insulating material.

**corundite;** a commercial name for colorless synthetic spinel used as a diamond imitation.

**corundolite;** a misleading commercial term for colorless synthetic spinel. Used as a diamond imitation. Same as radiant.

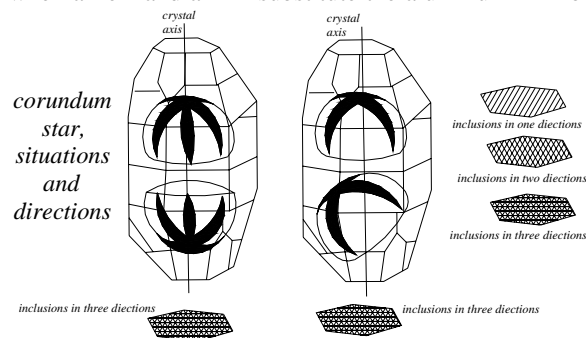
**corundolite;** a rock consisting of corundum such as emery rock, and emery.

**corundum;** an aluminum oxide, it occurs as shapeless grains and masses (emery), rhombohedral crystals. Ruby contains traces of chromium oxide, when red and



corundum structure, crystals and twin

$\text{Fe}_2\text{O}_3$ , which modified the color. The color of sapphire results from a combination of titanium and iron oxides, when a  $\text{Fe}^{+2}$  and a  $\text{Ti}^{+4}$  substitute the aluminum  $\text{Al}^{+3}$  or



a  $\text{Fe}^{+3}$  and a  $\text{Ti}^{+3}$  substitutes the aluminum  $\text{Al}^{+3}$ . Star

sapphires and rubies show asterism of 6-rayed star. Cat's-eye sapphire is very rare. It is the second hardest mineral after diamond. Sometimes called *hard spar*, *diamond spar*, *adamantine spar* and *corindon*. Some impure stones, show a silk effect, have minute, needle-like inclusions of rutile, and are cut as star rubies, star sapphires and cabochon, asterism or with cat's-eye (one ray) effects. Pure synthetic crystals are used in the laser industry. Sometimes the word *oriental* as a prefix, is used which is a misnomer other than the red variety that is called *oriental ruby*. Corundum is distinguished from other stones of similar appearance by their vitreous luster, weak color dispersion, double refraction, high specific gravity, dichroism by colored stones or by microscopical examination. It is the *birthstones* for July. Pigeon blood ruby is a purplish deep red from Mogok in Upper Myanmar, (Burma). *padmaragaya* is a Singhalese (Ceylonese or Sri Lankan) term for orange colored corundum, which means *lotus flower*. It was named as *carbuncle* with many other red stones such as spinel (ballas ruby) and garnet. Used as an abrasive such as common corundum or emery, transparent crystals such as *ruby*, which are red in color and *sapphire* in blue, or other colors are fashioned as brilliant-cut, step-cut, emerald-cut, mixed-cut. → Charge transfer of color in lattice, corundum, name of.

System: trigonal.

Formula:  $2[\text{Al}_2\text{O}_3]$ .

Luster: vitreous to adamantine, sometimes pearly on base.

Colors: colorless (white sapphire), red (ruby), pigeon's blood, blue (sapphire), yellow (golden sapphire), green (green sapphire), olive green, purple and violet (violet sapphire).

Streak: colorless.

Diaphaneity: transparent to translucent.

Cleavage: none.

Fracture: conchoidal to uneven. Brittle. Tough, when compacts.

SG: 4.00-4.01.

H: 9.

Optics;  $\omega$ : 1.7653-1.7760,  $\epsilon$ : 1.7573-1.7677.

Birefringence: 0.007-0.008.  $\ominus$ .

Dispersion: 0.018.

Found in Myanmar formerly Burma (rubies), Thailand and Sri Lanka (sapphire), Cashmere-India (sapphire), Australia, Tanzania, Cambodia, Russia, Thailand, Malagasy, Nepal, Malawi, and the USA

**corundum, absorption spectrum of;** in corundum 3 major elements as absorption spectra are seen: chromium, iron, and vanadium. Chromium has in green at 550 nm, and 3 bands in the blue at 468.5, 476.5, and at 475 nm a series of weak fine lines are seen. Vanadium in corundum causes same red color like chromium it has in the blue a line at 475 nm and a broad band at 585 nm, which caused the color change of stone. Iron has absorption spectrum in yellow, green

and blue sapphire at 451, 460, and 470 nm.

**corundum classification in Myanmar (Burma);** gem trading in Mogok, Myanmar (Burma) has own classification; *lon-bauks* for individual gemstone which is graded rubies by size and color: (I) First water stones of dark red-crimson which are graded due to weight (a) *anyun* stone of 2 cts., and over, (b) *lethi* stone of average 1.75 cts., (c) *the-bauk* or *haibauk* stone of average 0.75 cts., (d) *saga-the* stone of average 0.50 cts., and *ame-the* stone of average 0.20 for five pieces. (II) Second water stones of pale red-crimson which are graded due to weight, *ani-gyi* stone of 2-6 cts. (III) Third water stones of bright light-crimson known as *ani-te* or *bombaing*, which are graded due to weight of 2-6 cts, they were fancied in India. (IV) Fourth class stones are known as *ahtet-kya* which are graded into two categories (a) *ahtet-kya* means fallen from the top, a term used for mixed stones of the above grades therefore little defective in shape and water. (V) Parcels of lower grade stones (a) *gaungsa* or *yawya* a term for pale inferior mixed stones up to 6 cts, (b) *asa-yo*, inferior mixed deep stones up to 6 cts. (c) *asa-yo kya* inferior than *asa-yo*. (d) *akyan-the* like *asa-yo* but smaller stones. (e) *apya* a term for flat stones of fine quality. (f) *apya-kya* or *apya-sa* a term for flat stones of second class. (g) *apyazone* flat stone of third quality. (h) *awa* large and defect stones. (i) *gair* opaque, large and impure stones. (j) *ani-the* mixed minute stones of second water and fine quality. (k) *akyaw-the* pale, minute stones of good quality. (l) *apyu-the* small stones of pale, inferior quality and rough. (m) *atwe* impure and rough stones. (n) *zon-si* a term for spinel stones and rejections of another classification. (o) *mat-sa* opaque sapphire stones. (p) *thai* very minute stones similar to sand. (q) *pingoo-cho* a term for first-quality star rubies like spider's thread. (r) *pingoo* or *pingoo-sa* a term for silky rubies with or without star. (s) *gaw-done* or *gaw-cho* star sapphire stones. (t) *anyan* mixed of common water-worn spinel. (u) *anyan-nat-thew* a term for rose spinel of octahedron crystal and perfect luster. (v) *anyan-seinche* small spinels of quality of *anyan-nat-thew*. (w) *nila* large sapphire stones. (x) *nila-sa* a term used for inferior mixed stones. The finest ruby pigeon's-blood or pigeon's-eye in Burmese called *kothway*. Second class of best ruby named as *yeong-twe* or rabbit's-blood the color is more bluish red. The third class ruby with dark hot pink termed as *bho-kyeit*. Fourth-class ruby with pale-pink color named as *ley-kow-seet*, which mean bracelet quality. Fifth class or bottom of rubies is a ruby with dark-red color, labeled as *ka-la-ngoh*, which means *crying Indian quality*.

**corundum cut;** transparent and fine-quality of corundum such as ruby, sapphire, or *padmaragaya* the

orange colored corundum or other varieties has been cut as brilliant, mixed cut, beads, tumbled, step cut, cut as star rubies, star sapphires and cabochon, asterism or with cat's-eye.

**corundum heat-treatment;** → sapphire heat-treatment.

**corundum imitation;** imitations of ruby and sapphire are made from composed stones, glasses, or several natural or synthetic stones such as spinels, garnets, etc.

**corundum, inclusions in;** → inclusion in corundum.

**corundum in basalt;** corundum or peridot, which occurs in basalt are usually darker in color, while iron-rich rocks are found in several sources such as China, Cambodia, Thailand, Australia, etc.

**corundum luminescence;** chromium-rich corundums are strong crimson or frequently orange under SWUV or LWUV light caused by the existence of Cr ion.

**corundum, names of;** the name of corundum is derived from the Hindu term *kurand* or *kuruvinda* described an impure form of corundum. Now in mineralogy the name corundum described mineral species with the formula  $Al_2O_3$ . Some authorities believed that *kuruvinda* might be also rubicelle spinel. Burmese term for ruby is *padamya* with the meaning plenty of mercury. Thai name for ruby is *taubptim*.

**corundum, occurring;** corundum is also a contact metamorphic stone, which occurs in the mother rock such as limestone, dolomite, marble. It occurs in pegmatite, and syenite.

**corundum, optical properties of;** because of trigonal division of the hexagonal system of corundum, it is optically doubly refractive and uniaxial.

**corundum pleochroism;** dichroism by colored stones or by microscopically examination can be seen in varied colors.

**corundum, sources of;** famous and important world sources of corundum are: Afghanistan, Australia, Burma (Myanmar), Cambodia, India, Kenya, Montana (USA), Nigeria, Sri Lanka, Tanzania and Thailand.

**corundum, synthetic;** → synthetic corundum.

**Coscuez emerald;** any emeralds from Coscuez Mine near Muzo Mine, Colombia. Also spelled Cosquez emerald.

**cosmites;** a term used to designate minerals, decorative materials, ornamental stones, and gems.

**cosmolite;** same as meteorite.

**Coscuez emerald;** same as Coscuez emerald.

**costume jewelry;** a term used to describe various jewelry articles of moderate price composed to other expensive jewelry highly designed especially for use with the current fashion in women's garments. Usually contains gem-set imitations and metal such as silver or materials of even less value, which resemble precious jewelry, imitation stones such as glass, marcasite, and



synthetic gemstones are cemented. This term is sometimes used for jewelry containing precious stones and metals.

**cottaite**; same as orthoclase.

**Côte d'Ivoire**; French spelling for Ivory Coast. Alluvial diamond bearing country in West Africa.

**cotham marble**; a light gray-colored marble, having dark brown, nearly black, dendritic markings throughout. The polished surface of the rock frequently shows patterns, which simulate trees and other vegetation. Also called landscape marble. Found in Rhaetic of Gloucestershire, England. → Ruin marble.

**Côte de Bretagne**; an irregular red spinel of 206 ct in rough. Belonged to Henry II of France. It was cut into a body and head of a dragon of 105 cts, in Louis XV of France time (1754-1793), which was set in a jewel above the Blue Diamond of the Crown. Inherited by Louis XVI, later was stolen in the robbery from Grand Meuble in 1792, but was returned to Louis XVII. It is now on display at the Museum Louvre, Paris.

**cotterite**; an undesired Cornish local term for quartz with pearly, metallic luster due to colloidal inclusions of white clay.

**cotton ball**; same as ulexite.

**Cotton Belt Star Diamond**; a rough diamond of 11.92 cts, found in 1963 by a 14-month old baby, at Pine Bluff, Arkansas, USA.

**cotton chert**; synonym for chalky chert.

**cotton miner**; a miner employed in an asbestos mine.

**cotton rock**; a variety of chert.

**cotton rock**; a fine-grained, white to pale gray variety of siliceous limestone from Missouri, having a chalky or porous appearance similar to cotton.

**coumarin**; a bitter, aromatic, colorless crystal, scaly or powder fragrant odor similar to vanilla, burning taste. Soluble in 95% alcohol, in ether, chloroform, slightly soluble in water. Toxic by ingestion. Obtained from Tonka beans and produces synthetically. Used as dyes and in laser dye as laser dye with the wavelength 430-530 nm. Also called benzopyrone, tonaka bean camphor and spelled coumarin. → Oxazine 9.

**counter-enameling**; a method of enameling by painting both sides of the metal with enamel.

**counterfeit**; an imitation of gemstone or noble natural metal made with the intent to deceive, also gold rings with hollow shank or a shank filled with some other composition.

**counterfeit amber**; ambers made colorless by overheating and then oxidized. The color is thin on the surface. Also called surface color-treated amber.

**Countess Széchényi Diamond**; a pear-shaped diamond of 62.05 cts, is named after Laszlo Széchényi's wife.

**counting diamonds**; certain blue body color diamonds

of Type IIb containing boron are usually semi-conductors. This behavior is used as radiation counters or counters of gamma rays like a Geiger counter. These radioactive properties may be of exceptional advantage for medicinal purposes. → Type IIb diamonds.

**country rock**; the pre-existing rock, which has been penetrated and surrounded by an igneous intrusion, such as kimberlite pipe.

**country rock**; a term used for jade mineral, which is surrounded by other rocks.

**covalent bond**; same as covalent bonding.

**covalent bonding**; a chemical linkage between two or more atoms in a molecular compound with sharing of electrons and forms a structure like an inert gas. Also called covalent bond, electron pair bond. → Homopolar bond.

**covellite** same as covellite.

**covellite**; a massive, opaque mineral. Sometimes cut cabochon. Formula: 6[CuS]. Trigonal crystal. Vitreous luster. Indigo-blue, purplish, yellow and red, with iridescent effects. Shinning gray-black streak. Cleavage: {0001} perfect. Optics;  $\omega$ :1.400,  $\epsilon$ :2.620. Birefringence: 1.220.  $\oplus$ . SG:4.68. H:1½-2. Fracture: uneven. Brittle. Found in Sardinia, Italy, New Zealand, Australia, Argentina, Philippines, and USA. Also called indigo copper and spelled covellite. Pleochroism strong but can be seen in thin section.

**cowdie gum**; same as Kauri copal.

**Cowee Creek**; corundum or rubies of moderate quality, have been found in the sand of Cowee Creek, USA.

**cowrie shell**; → cowry shell.

**cowry shell**; any small marine gastropod shell of the family Cypraeidae, having a glossy oval shell with a slit-like toothed opening found in Indian Ocean. Used in Egypt as an amulet against sterility and later in South Asia and Africa as a form of money. Now making small objects such as snuffbox, étui, etc.

**Cr**; a chemical symbol for the element chromium.

**crack**; a partial or incomplete or irregular fracture, therefore usually one not in a cleavage direction. → Fissure.

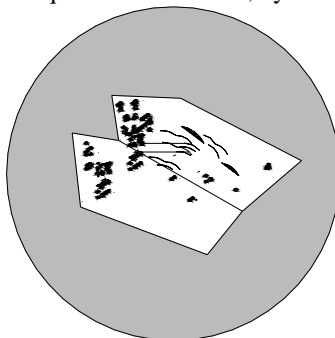
**crackle**; a glazed or crackled surface on gem, glass, and pottery.

**crackled**; crackled surface on gem, glass, and pottery having the appearance of a multitude of tiny compact placed cracks. → Crackled stone.

**crackled quartz**; same as crackled stone.

**crackled stone**; gemstones containing small cracks, which have been formed as a result of heating and sudden cooling, producing slight iridescence or rainbow colors (as in natural iris quartz). The rainbow color can be seen by interference of light in artificially colored stone, by impregnating the cracks with dye. Artificially

dyed red-or green crackled quartz crystal is frequently used for this purpose and is called *fire stone*. For example, *Indian emerald* is a misnomer for green crackled quartz. → Crackled, dyed stone.



*surface  
cracks and  
bubbles in  
synthetic  
ruby*

**cradle**; a simple wooden, metal device for washing sand or gravel to separate diamond, gold, or other heavy metal.

**craquelé**; a French term for small cracks, which have been formed as a result of heating and sudden cooling, producing slight iridescence or rainbow colors in gemstones.

**craquelées**; a French term for quartz crystal gems, which has been artificially crackled by heating to produce rainbow effect and stained ruby red known as rubace. → Rubasse

**crater glass**; natural, slaggy, white, greenish-yellow, black glasses (fused quartz) are obtained from meteoritic craters, occurs due to very high heat generated by impact of meteor on the sand deserts on the earth surface, consisting of approximately 90% silica. RI:1.46-1.54. SG:2.10-2.31. Found in sandy desert in Wabra, Saudi Arabia, at Meteor Crater, Arizona, USA, and in central Australia.

**Crater of Diamond**; a diamond-bearing pipe in south of Murfreesboro, Arkansas, USA. → Arkansas diamond.

**crateral magma**; same as lava.

**craton**; a relatively immobile part of the Earth's crust, invariably part of a continent, which is longer not affected by orogenic activity. Cratons are generally more than 1 million years old. It believed they are associated with diamond formation. Also spelled kraton.

**craze**; a term used by Australian miners for several number of straight cracks on the opal due to shrinking of silica after exposure to the air, light and heat on the surface. Such opal is difficult to cut.

**crazed**; a term used for particular inclusion pattern in Kashan synthetic rubies formed from negative crystal may often shows irregular surface cracks which is known as crazed. → Crackled stone.

**crazing**; the tendency of opals such as opal from Nevada to form multiple fine, hairline cracks after being mined

and exposed to the air or aging.

**crazing amber**; the tendency of amber to craze to multiple fine, hairline cracks after it is subjected to extreme heat treatment because of its low melting degree.

**crazy lac agate**; a banded agate, in which the bands are zigzag and resemble the scallops of lace edging, from Mexico. → Lace agate.

**cream**; a rusty impure sepiolite.

**cream bed**; a term applied to fine-grained, grayish limestone.

**cream fancy rosée pearl**; any cream colored pearl with light-pink orient, but more luster than cream rosé pearl.

**cream pearl**; a term applied to any light-, medium- and dark-cream colored pearl but without any particular orient, or overtone.

**cream rosé pearl**; any cream colored pearl with light-pink iridescent overtone orient.

**creams**; a term applied sometimes to designate a very high quality drill diamond.

**created**; a term for synthetic or man-made crystals made in laboratory.

**created emerald**; the term is legal in some countries, for synthetic emerald.

**Creative Crystal flux-grown of synthetic alexandrite**; a method of growing synthetic stones of solution-growth process or flux process especially for alexandrite, which is divided into two method; Creative Crystal-alexandrite and Novosibirsk-alexandrite.

**credite**; a colorless to white and sometimes purple, rare mineral of  $4[\text{Ca}_3\text{Al}_2(\text{F},\text{OH})_{10}(\text{SO}_4)_2\text{H}_2\text{O}]$ . Monoclinic crystal. Transparent to translucent. Vitreous luster. Cleavage: {100} perfect. Brittle. Optics;  $\alpha$ :1.460,  $\beta$ :1.478,  $\gamma$ :1.484. Birefringence: 0.019.  $\ominus$ . Dispersion: 0.014. SG:2.71-2.73. H:3½-4. Luminescence under SWUV white to cream and under LWUV white to pale cream. Found in Mexico, and California, USA. A suitable mineral for collectors.

**creepers**; a term used by Australian miners for cracks or gaps, fine opening appear in underground, indicating dangerous. Also spelled creeps.

**creeps**; same as creepers.

**creolin**; a brecciated jasper or pudding stone. Same as brecciated jasper.

**creolite**; red and white banded jasper from Shasta and San Bernardino counties, California, USA.

**creolite**; a purplish epidotized basalt from Massachusetts, USA.

**creolite**; a silicified rhyolite from California, USA.

**crepe stone**; a French term for jet or black glass used to make a dull crepe spectacle for jewelry.

**crepuscular**; the radiating and colored rays from the sun when passing through the gaps in clouds below the

horizon.

**Crescent Vert Alexandrite;** a commercial term for a flux-melt method synthetical emerald, produced by Creative Crystal, San Ramon, California, USA. Optics;  $\omega$ :1.564,  $\epsilon$ :1.568. Birefringence: 0.004.  $\ominus$ . SG:2.66. Same product from Kyocera, Japan is commercially named as Crescent Vert Alexandrite, marketed by Inamori Created Alexandrite.

**cresecentic dune;** same as barchane dune.

**cresecentic necklace;** a necklace with the shape or outline of a crescent moon.

**resol;** a colorless, yellowish to pinkish liquid of  $C_6H_4(CH_3)OH$ . Used as a flotation agent. Soluble in water and alcohol. Synonym for cresyl alcohol and methyl phenol.

**crest;** same as crown.

**crest;** a term used for peak.

**crested;** a growth of groups of tabular crystals resembling a ridge.

**crested;** any ornament piece, such as a plume, on top of a helmet.

**resyl alcohol;** same as resol.

**resyl violet;**  $\rightarrow$  oxazine 9.

**Cretaceous System:** a rock system on the earth's surface from the final period of the Mesozoic era (136-65 million years ago). Extensive marine chalk beds were deposited during this period.

**crimson;**  $\rightarrow$  kermes.

**crimson corundum;**  $\rightarrow$  corundum luminescence.

**crinkled diamond;** a diamond with a shallowish wavy, or rough surface. Also called stepping.

**crinkled stone;** same as crinkle diamond.

**crinoidal limestone;** same as encrinite limestone.

**crisoberillus;** a misleading term for a green variety of beryl.

**crinoidal marble;** same as encrinital marble.

**crisoberilo;** a Spanish spelling for chrysoberyl.

**crisocola;** a Spanish spelling for chrysocola.

**crisoprasa;** a Spanish spelling for chrysoprase.

**crisopassus;** a misleading term for a golden beryl mixed with purple.

**crisopilon;** a misleading term rarely used for variety of beryl.

**crispite;** any quartz or agate with green hair-like needles. Same as sagenite.

**crystal brilliant;** a Spanish term for rhinestone, or other imitation diamond.

**crystal de roca;** Spanish spelling for rock crystal.

**crystal de rocha;** Portugesian spelling for rock crystal.

**crystallinus;** a misnomer for pale to colorless beryl.

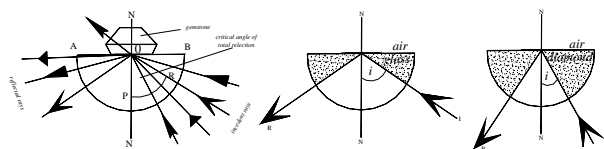
**Cristaria plicata;** any fresh-water mussel from Chinese rivers and Lake Biwa, Japan that has long been used in

that countries to artificially induce the production of cultured blister pearls and nacre-covered, knob-like pieces of bone, wood, brass and leaden images of Buddha. It is also used as one of the host mollusks for freshwater pearl cultures.

**crystalite;** a translucent to opaque mineral like quartz  $4[\alpha-SiO_2]$ , is present in many siliceous volcanic rocks. Stable only above 1470-1720° C. Occurring as cavity lining and consistent in the fine-grained groundmass. Polymorphous with quartz, stichovite, coesite, and tridymite. Tetragonal crystal. White, or milky white, gray, brownish, bluish gray color. Brittle. Optics;  $\omega$ :1.484,  $\epsilon$ :1.487. Birefringence: 0.003.  $\ominus$ . SG:2.30-2.33. H:6½-7. Crystallinity state of opal consists of very small particles of cristobalite. Variety is called lussatite. Also spelled christobalite.  $\rightarrow$  Opal, silica glass.

**crisoberillus;** a term rarely used for variety of beryl.

**critical angle;** that angle, at which a ray of light is passing from a dense medium such as a gemstone to



depending of critical angle or total-reflection from refraction of light between gem and hemisphere

depending of critical angle from refraction of light, left in glass and right in diamond

### critical angle or total reflection

one less dense such as air, is reflected at an angle of 90 degrees to the normal or made an angle of 90° with the normal so that it skims along the surface separating the two media, any further and the incident ray angle would cause the refracted ray to turn back into the medium where it obeys the ordinary laws of reflection. Also called critical angle of total reflection.

**critical angle;** an imaginary cone-shaped pattern within an optically dense medium, such as minerals or diamond, in which all the transmitted light at a given point is confined to a cone, when considered in three dimensions.

**critical angle of total reflection;** same as critical angle.

**critical angle cone;** a three dimensional imaginary cone, which can be assumed by rotating the critical angle around the normal.

**crizzling;** very fine cracks in the surface of the glass, caused by local cooling during manufacturing.

**crocetin;** a red, rhomboidal crystal, noncyclic colorants or pigments of carotenoids compound ( $C_{20}H_{24}O_4$ ), obtained from crocus sativus with the name saffron.

Used as yellow pigment. Also called crocin. Soluble in pyridine, slightly in water, and dilute sodium hydroxide. → Polyene.

**crocidolite**; a lavender-blue, indigo-blue, or leak-green variety of asbestos, a riebeckite amphibole, occurring in silky fiber, massive and earthy forms, which has altered and decomposed into quartz. Generally is known as *crocidolite quartz*. The original blue color is changed by hydrous iron oxides into a fine golden-brown, known as *tiger's-eye* or spelled *tiger-eye*. Occasionally has been silicified or pseudomorph without alteration of the blue color, it is known as *sapphire-quartz*, *azure-quartz*, *siderite*, *hawk's-eye* or *falcon's-eye*. Particolored golden-brown and blue crocidolite known as *zebra crocidolite* or *zebra tiger-eye*. When the gold-brown crocidolite is heat-treated, the brown limonite turns into red hematite. Most crocidolites are from South Africa. Also called, opal cat's-eye, blue asbestos, cape blue. The quartz pseudomorph is called pseudocrocidolite.

**crocidolite cut**; cut cabochon, beads, carved cameos, flat plates, tumbling, etc.

**crocidolite opal**; a chatoyant opal with included crocidolite. Also called opal cat's-eye.

**crocidolite quartz**; same as tiger-eye or tiger's-eye. → Crocidolite.

**crocin**; → crocetin.

**crockery**; an informal term used by Australian miners for crockery bottom to indicate a nobby with a milky-white patch base, which describes the possibility of light-color crystal opal.

**crockery**; an informal term used by Australian miners for an opaque, milky-white patch.

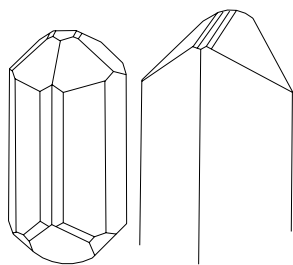
**crockery**; same as crockery patch.

**crockery patch**; an informal term used by Australian miners for crockery cap of a white patch top on a nobby like Chinaman's-hat.

**crocking**; a term used in coloring for removal of a dye or pigment from the surface of a painted object.

**crocoisite**; same as crocoite.

**crocoite**; A suitable mineral for collectors. Synonym for red lead ore, lead chromate, chrome yellow, crocoisite,



crocoite crystals

and beresofite. It has an absorption spectrum at 555 nm

and Frequently a reddish-brown glow under UV light. Also called chrome yellow.

System: monoclinic.

Formula:  $4[\text{PbCrO}_4]$ .

Luster: adamantine to vitreous.

Colors: bright red, yellowish-red, hyacinth-red or orange

Streak: orange-yellow.

Diaphaneity: transparent to translucent.

Cleavage: {110} distinct, {001} indistinct, and {100} indistinct.

Fracture: conchoidal to uneven. Very brittle.

SG: 5.99-6.10.

H:  $2\frac{1}{2}$ -3.

Optics;  $\alpha$ :2.29-2.30,  $\beta$ :2.36,  $\gamma$ :2.66.

Birefringence: 0.270. ⊕.

Dispersion: strong.

Found in Tasmania, Russia, Romania, Brazil, and USA.

**crocus**; a coarse-grained abrasive and polishing powder produced from an iron oxide or rouge. Also called crocus martis, rouge, jeweler's rouge.

**crocus martis**; same as crocus.

**crocus sativus**; → crocetin.

**croix**; a French term meaning cross.

**chromolite**; a misleading term applied to transparent, medium dark green tourmaline.

**Crookes dark space**; a dark region in Crookes tube separating emanation from the negative cathode in an electrical discharge in a gas at low pressure. The thickness of the Crookes dark space is about 0.6 cm thick at 0.1 mm pressure. → Crookes glass.

**Crookes glass**; an anti-glare glass often used in spectacles, can be tinted by didymium and will show the didymium rare earth spectrum. → Crookes dark space.

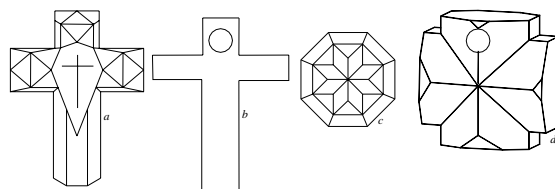
**Crookes tube (X-ray)**; an original gas-discharge tube used in X-ray made by Crookes, William.

**crop pearl**; same as baroque pearl.

**cross**; same as four-square stone.

**cross**; any ornamental article in the form of a cross used as a pendant or brooch.

**cross**; the cutting of the first group of facets such as four



cross cuts, a and b: two faceted cross cut, c: a cross shaped star facet and d: a twin of staurolite in form of a cross

kite facets or main facets on the crown and four

pavilion facets on the pavilion of a diamond.

**cross cut;** a variation of the trap cut, which increases the scintillation of diamond and other gemstones of lower refractive index such as quartz, beryl, tourmaline, and topaz. In which the first 4 sided crown main facets surrounding the table are cut, the first 4 elongated triangular facets meeting at an apex. Also called scissors cut, four-square stone.

**cross cut;** a horizontal tunnel mined across the direction of the strike.

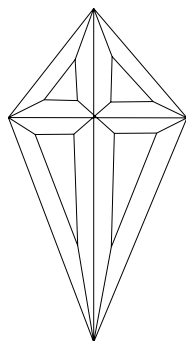
**cross cutter;** same as lapper. The craftsman who puts on or grinds and polishes the table facet and 4 main side facets on the crown and the corresponding 4 facets and culet on the pavilion. Also called Kruisworker, blocker, cross worker. → Lapper, blocking, brillanteer.

**cross cutting;** → cross work.

**crossed filters;** a method to the study fluorescence phenomenon of gems such as ruby, red spinel, alexandrite, emerald and pink topaz all show up well between two crossed color filters. Light passes through one but is absorbed by the other, which causes darkness. Chromium-rich stones often fluoresce red, when irradiated with blue ray. In natural spinel observed under crossed filter and UV light a group of several shallow absorption lines, occur as a set of organ pipes and is called *organ pipe*. Also called crossed filter technique.

**crossed filter technique;** same as crossed filters.

**crossed lozenge cut;** a modern four-sided trap-cut (lozenge cut) for diamond or other transparent gemstones having an outline of a child's kite, in the



*crossed  
lozenge-cut*

table is faceted a cross with eight facets. In this cut, a sloping trapezoidal facet borders each of the four sides.

**crossed Nicols;** two Nicol prism are so arranged that their principal vibration planes are mutually at right angles (or their principal axes are at right angles to each other). In this position the plan-polarized light emanates from one Nicol but is absorbed by the other, which causes darkness. Crossed Nicol is used to examine minerals in parallel-polarized light. Also called Nicol crossed, crossed polarizing filter, crossed prism. →

Nicol prism.

**crossed polaroids;** a term applied to examine gems in polarized light, both polaroid discs must be crossed over one another.

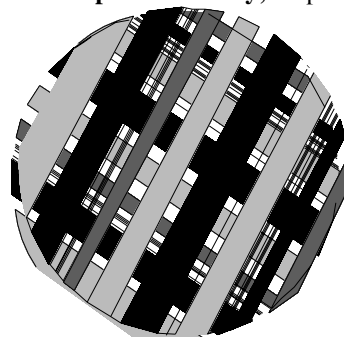
**crossed dispersion;** cross-hatched dispersion.

**crossed prism;** → crossed Nicols.

**crossed polars;** same as crossed Nicols.

**crossed twinning;** cross-hatched twinning.

**crossed twin plane in ruby;** a peculiar twinning as



*crossed twin  
planes in  
Thailand  
ruby*

inclusions seen in Thailand ruby.

**cross facets;** the name applied to eight of the relatively small three angular facets on the crown (half of 16 facets) and 8 facets on pavilion all abutting the girdle. In the case of a modern circular stone another 8 facets have the same size and shape, which is known as the skill facets (another half of 16 facets on crown), and the another 8 facets on the pavilion, alternating with 8 similar adjacent skill facets are now collectively known as *girdle facets*. In the order oval-shaped stones, these facets are the eight larger of the 16 edge facets. In modern nomenclature the eight cross and the eight skill facets are combined as 16 half facets. Formerly an alternative name for cross facets is skew facets. Also called break facets, and sometimes referred to as half facets, or little halves. → Girdle facets.

**cross-fiber;** an oriented silky fibered variety of crocidolite. When crocidolite is disoriented, it is known as riebeckite asbestos.

**cross grained stones;** any irregularly shaped and intergrown diamond crystals.

**cross grained stones;** sometimes a misleading term for any twinned diamond crystals. → Macle.

**cross-hatch effect;** singly refractive, synthetic spinel because of its uniquely strained structure exhibits a peculiar patchy extinction under crossed polars of polariscope, which resembles fine cloth fibers with anomalous double refraction. *House cat stripes* are a term used in England for *tabby extinction*. Also called crosshatch in synthetic spinel.

**cross-hatch in synthetic spinel;** → cross-hatch effect.

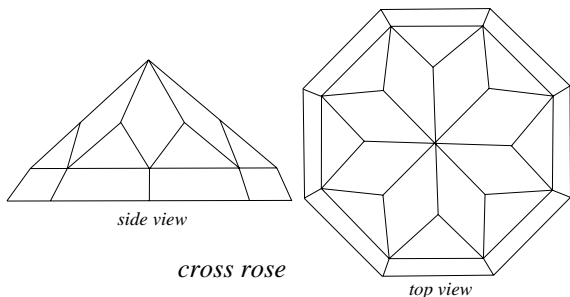
**cross naat;** same as naat, or cross grained stones.

**Cross of Asia Diamond;** a champagne-colored diamond

of 109.26 cts. It is cut so that a Maltese cross is visible, when it is looked at through the table.

**Cross of the South Diamond;** same as Abaeté Rose Diamond.

**cross rose cut;** a rarely used rose style of cutting of

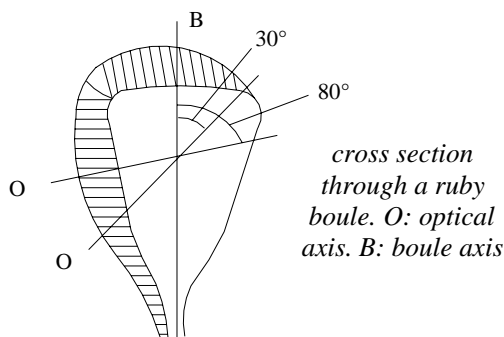


diamond or other transparent gemstones, a variation of the trap rose cut with 24 facets, in which the 8 facets in the crown are usually triangular in shape, but in one form as a cross. The pavilion is flat and unfaceted, and it has no table in the crown but 8 lozenge-shaped facets, which are pointing upward and meeting at a point at the apex. The lozenge facets are abutted by 8 triangular facets to complete the crown, these are abutted by 8 isosceles-trapezoidal facets, which surround the girdle.

**cross-section elbaite;** a pale-red elbaite, 30cm long from Mawi, Kabul, Afghanistan 1979? Present whereabouts unknown. Afghanistan?

**cross-section of the Earth;** → core, Earth structure, Earth cross section.

**cross-section through synthetic ruby boule;** a section



cross section through a ruby boule. O: optical axis. B: boule axis

through synthetic boule of ruby for the choice of cut and polishing.

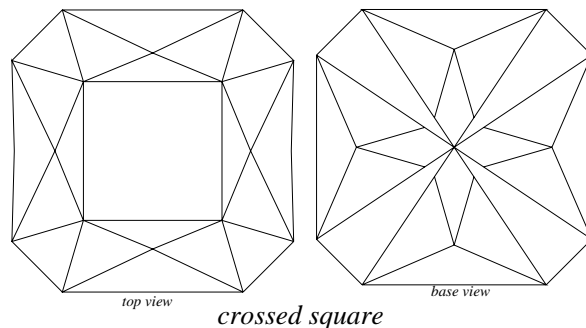
**Cross-section Tourmaline;** a pale-red cut-stone of 30 cm long. Found 1979? in Afghanistan. Present whereabouts unknown. Afghanistan?

**cross-shaped inclusion;** a term used for cross-shaped feature seen as internal graining in Itami synthetic diamond from Japan. Also called phantom strain.

**Cross-Shaped Tourmaline;** a multi-colored cut-stone in form of a pendant of 6.3 cm. Belonged to Alexander

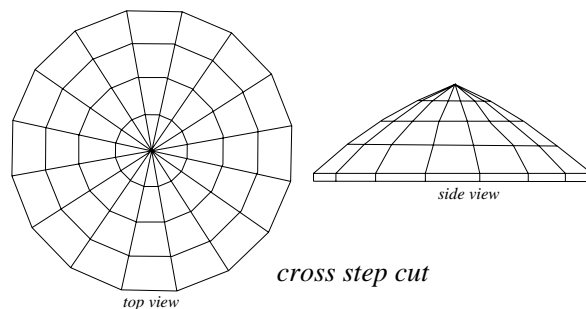
Blythe Collection, California, USA.

**cross square-cut pavilion;** a modified of cutting a diamond or other transparent stone in the form of 4-equal sided, with 20 facets and a square table, which is a modification of 18-facet single cut by abutting each



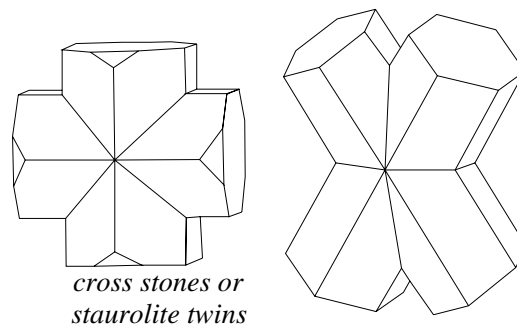
of its edges with a double-cut facets. Pavilion has 20 facets in form of a four-rayed cross or star.

**cross step cut;** a rarely used step rose style of cutting of diamond or other transparent gemstones, a variation of the trap rose cut with 48 facets in the crown are usually



triangular and lozenges in shape and 16 facets surround the girdle.

**cross stone;** a fanciful term for twinned crystal of staurolite in the form of a cross, known as *fairy stone*. Worn as an amulet for baptism or for charms. Found in



Brazil, Switzerland, Zambia, Scotland, Russia, France, Canada, Hampshire, Maine, Virginia, and North Carolina (USA).

**cross stone;** a fancy name for opaque crystals of

andalusite, which contain carbonaceous inclusion with a cruciform arrangement in one end and square in other end, which are known as *chiastolite*. Such stones were frequently worn as amulets and charms. Found In Russia, Australia, France, Myanmar, Zimbabwe, and USA. Also called crucite, crusite.

**cross stone;** an obsolete term for harmotome a zeolite mineral.

**cross stone;** an obsolete term for hercynite a black spinel mineral.

**cross table;** some Australian sapphires are cut parallel to the table because the lesser color intensity from a dark stone.

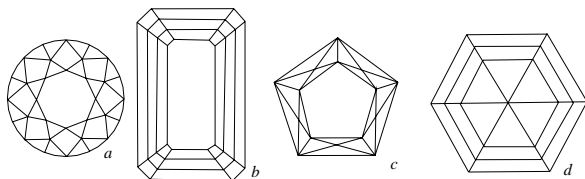
**cross work;** after blocking, the first operation in grinding and polishing a brilliant-cut stone, consisting of grinding the table facet and four main side facets (bezels), and four back facets and the culet. Same as blocking or cross working. Sometimes called cross cutting, four-square stone, four-square diamond.

**cross worker;** The craftsman who does cross work. Also spelled Kruisworker. → Cross work.

**cross working;** → cross work.

**crown;** the upper part of a faceted gemstone.

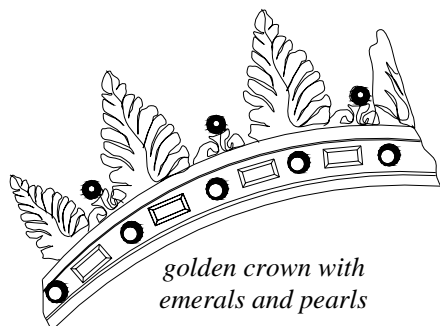
**crown;** part of a brilliant-cut diamond, which lies above the girdle. In brilliant cut stone, it has the table facets



*crown of different cuts, a: round-brilliant crown, b: emerald-cut crown, c: five rayed star-cut crown and d: hexagon-cut crown*

and 32 surrounding facets. Also called bezel. → Pavilion, crown cut forms.

**crown;** a usually circular royal head-dress with an open center, often made of precious metal and decorated with



*golden crown with emeralds and pearls*

gemstones, worn by a monarch or consort as a symbol

of sovereignty. Crest.

**crown;** in England and Africa a drilling bit.

**crown angle;** in a cut gemstone or brilliant the angle between the plane of the girdle and the crown facets.

**crown cut forms;** part of a brilliant-cut diamond, emerald cut and fancy cut stones, which lies above the girdle. In brilliant cut stone, it has the table facets and 32 surrounding facets. Also called bezel. → Pavilion.

**Crown Diamond;** a honey-colored, cushion-antique-cut diamond of 84 cts. belonging to the Russian Imperial family. It disappeared from 1917-1935, now after its third round brilliant cut which occurred in 1963 weighs 50 cts. Present owner unknown.

**crown flint glass;** an optical crown glass bordering on optical flint glass because of the addition of a substantial content of lead oxide and with somewhat higher dispersion than crown glass. Also called lead crown glass.

**crown glass;** a term, which refers to classify a group of soda-lime-silica glasses, which do not include lead oxide in their chemical composition 73% SiO<sub>2</sub>, 14% Na<sub>2</sub>O, and 12% CaO. it have relatively low dispersion, and is used only for cheap gem imitations. RI:1.49-1.53. SG:2.30-2.60.

**crown glass;** a style of lens made of soda-lime-silica glasses with low dispersion and index of refraction. → Lead glass, flint glass, optical crown.

**crown height;** in a cut brilliant the vertical distance between the plane of the girdle and the plane of the table facet, usually determined in millimeters.

**Crowning Glory;** a fine elbaite tourmaline from Queen Mine of San Diego County, California, USA.

**crown jewels;** any collection of jewelry and gemstones decorated such as gem-set regalia or not mounted, which belonged, to a royal dynasty.

**crown jewels;** a commercial term for synthetic sapphire. Used as a diamond imitation.

**crown jewels;** in England an elliptical reference to the British Crown Jewels.

**Crown Jewels of England;** the regalia of Great Britain worn by Imperial family, now on display at the Jewel House of the Tower London.

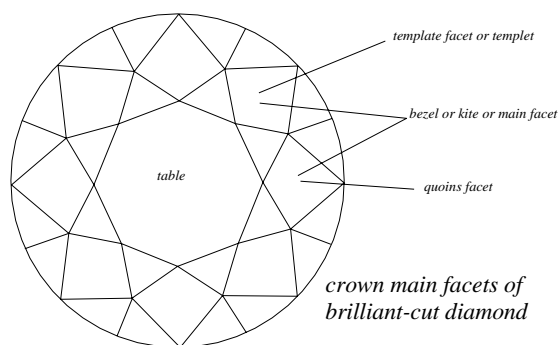
**Crown Jewels of Hapsburg;** → Kunsthistorisches Museum, Vienna.

**Crown Jewels of Iran;** → National Jewel Treasury of Iran.

**crown metal;** a synonym for diamond matrix.

**crown main facets;** more specifically, the sloping kite-shaped facets or main facets between the girdle and the table, or only a small part, (the so-called *setting edge*), of the sloping surface just above the girdle. All lozenge-shaped facets having their apex touching the girdle. The French name is chaton. Same as bezel, top

main facets.



**Crown Mine;** same as Lace Mine.

**Crown of King Agilulf;** two crowns were made (ca. 600 A.D.) for King Agilulf and his wife Queen Theodolina of Lombardy, set with emeralds among other gemstones. Now in Italian Collection in the Vatican Museum, Roma.

**Crown of Charlemagne Diamond;** a blue, round brilliant-cut diamond of 37.05 ct, was recut from a stone 42.50 cts. by Harry Winston in 1949

**Crown of Queen Theodolina of Lombardy;** → Crown of King Agilulf.

**crown of silver;** chalcedony including minute plumes of black manganese arranged in bands, polished to a brilliant black. Also called psilomelane chalcedony. Used as a substitute for hematite.

**crown of silver;** erroneously same as black malachite.

**Crown of the Andes;** perhaps the richest and most famous crown that was never intended for the head of a king is the crown of the Andes. That is a gold crown set with 453 emeralds, estimated to weigh 1521 cts, the principal stone weighs 45 cts. The story of this crown begins in the 1580's, when smallpox epidemics raged through Colombia. The city of Popayan, near the source of the Cauca River, was a prosperous cultural center in the path of the plague. The people of the city prayed for deliverance from the death-dealing sickness and were spared. In thanksgiving, the citizens donated gold and emeralds for a crown to be dedicated to the Virgin Mary. It was completed and placed in 1599 on the statue of the Madonna (Queen of Heaven) at the Cathedral at Popayan. In the nearly 1900's it was decided that the crown should be sold to build an urgently needed orphanage, hospital, and home for the aged. The fall of the Russian Czars brought a halt to one possible sale being negotiated but finally in October 1936, the sale was completed to an American syndicate. In 1963, it was sold at an auction to the Dutch diamond cutter and gem dealer, J. Assher. Its present owner is Oscar Heyman & Bros. Inc., New York City, USA manufacturing jewelers. → Atahualpa Emerald.

**Crown of the Asia;** a champagne diamond of 109.26 cts. Locality not confirmed.

**Crown of the Empress Farah;** → Farah Diba's Crown.

**Crown of the Moon Diamond;** same as Taj-e-Mah, at the present time an outstanding item in the Iranian Jewels, Tehran.

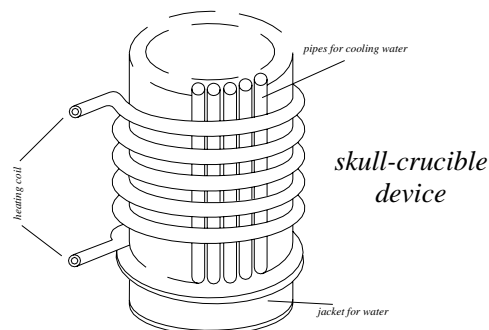
**Crown of Virgin del Sagrario;** a Crown of Spain made of gold set with several other precious stones such as emerald with the statue of the Virgin del Sagrario, was deposited in the Cathedral of Toledo. Were finished between 1574-1464. Stolen in 1869 and never seen. The crown is illustrated as engraving by Miro in 1870.

**crown optical glass;** a term, which refers to a classification of glasses, which have relatively low dispersion, and is used only for lenses. RI:1.49-1.60.

**crown rose cut;** same as Dutch rose cut.

**crowned rose;** same as Dutch rose cut.

**crucible;** a vessel or device in which substances can be



heated to a high temperature.

**crucible former;** consists of a flat dish with a vertically raised rim flange and a central pierced dome used in pressure casting. → Flask.

**cruciform twin;** same as interpenetration twin or crossed twinning.

**crucite;** another term for cross stone such as andalusite, chiastolite or staurolite.

**crude;** a mineral or gemstone in its natural state before treatment.

**Crude Rosette Tourmaline;** a black tourmaline of 2.2 m in diameter from Stewart, San Diego, California, USA. Found in San Diego County, California.

**Crude Rosette Tourmaline;** a black tourmaline of 1.5 m x 7.5 cm in diameter from Stewart, San Diego, California, USA. Found in 1951-1953? San Diego County, California.

**crumbling;** the falling or breaking into minutes particles of a rock.

**crumbly calcite;** → moon milk.

**crushing bort;** inferior qualities of industrial diamonds, which are suitable for grinding and polishing powder. Fragments from cutting or recovered from waste are frequently classed as crushing bort.



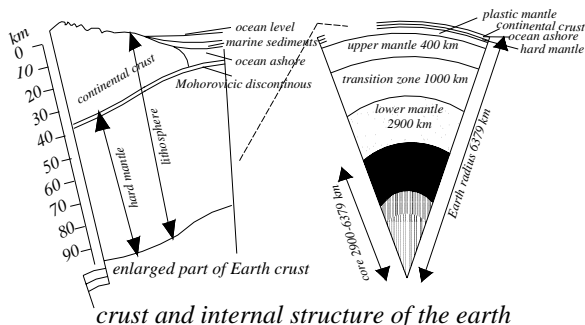
**crushing bortz;** synonym for bort.

**crushing plant;** size reduction into relatively manageable particles.

**crusite;** same as cross stone chiastolite.

**crust;** the thin outermost layer or shell of the Earth, it represents less than 1 percent of the Earth's volume.

Extending 5km beneath the ocean to 60km beneath



mountains. It separated into two shells, that part of the Earth above Mohorovicic discontinuity, the sial (acronym of silica and aluminum) and sima (acronym of silica and magnesia). The sial apparently confined to the continental masses. Also known as Earth crust, crust of the Earth, lithosphere, geosphere.

**crust;** a surface soil layer may slightly cemented with silica, calcium carbonate or iron oxide which becomes harder than the underlying horizon.

**crust;** coating or covering with a hard surface layer, which is known as incrustation.

**crust;** an informal term used by Australian miners for outer coating of sandstone or opal.

**crusta petrosa;** the root end or *fang* of teeth of elephants or mammals, which is placed into bony socket of skull or jaw is covered by a layer of cement with the name crusta petrosa.

**Cruzeiro Ou Vitória Diamond;** a diamond of 261 cts, found at the Sant Antonio River, Minas-Gerais, Brazil, in 1942. It was cut into six stones of unknown records.

**crying Indian quality;** same as ka-la-ngoh. → Corundum classification in Myanmar.

**cryogenic cooling;** the study of the production and effect of very low temperatures by using liquid nitrogen or dry ice, which cause slower molecular vibrations and that means sharpening the absorption spectra of some colored diamonds.

**cryolite;** a massive, monoclinic mineral of  $2[\text{Na}_3\text{AlF}_6]$ . White, reddish, brown, grayish-black or colorless. Transparent to translucent. Streak: white. Vitreous to greasy luster. Fracture: uneven. Brittle. Optics;  $\alpha$ :1.338,  $\beta$ :1.338,  $\gamma$ :1.339. Birefringence: 0.001. ⊕. Dispersion: 0.024. SG:2.97. H:2½. Found in Spain, Russia, and USA. Sometimes found in topaz as an inclusion. It is rarely fashioned but it is prized by collectors. Also

known as Greenland spar.

**crypto;** prefix for hidden, or invisible, latent, secret.

**cryptocrystalline;** same as submicroscopic fine-grained crystal aggregate made of one material. Such minerals are generally formed gelatinous masses that slowly crystallize by dehydration or depositions of silica material from ground waters in bands, which can be seen in certain types of agate. They are semitransparent or opaque. Very minute crystals. Also called microaphanitic, microcryptocrystalline, aphaniphytic.

**cryptocrystalline;** described crystalline structure of a sedimentary carbonate with a diameter of 0.0001-0.01mm.

**cryptocrystalline quartz;** any variety of microscopic quartz that requires high magnification, usually colored by minerals including impure oxides of Mn, Fe, Ti, Cr, Ni, Cu, etc. and contain small needle or granular crystals. Cryptocrystalline quartz is chalcedony in several varieties, carnelian, sard, prase, onyx, flint, chrysoprase, bloodstone, sardonyx, flint, chert and plasma.

**cryptocrystalline tourmaline;** a kind of cryptocrystalline tourmaline masses occurs in Klyuchevskoe, Russia.

**cryptogene;** said a rock of obscure or unknown origin.

**cryptolite;** same as monazite.

**cryptomere;** → aphanite.

**cryptoperthite;** submicroscopic interlamination of albite and orthoclase as lamellae, which gives marked schiller of feldspars.

**crystal;** a misleading word for chrysochal.

**crystal;** a misleading word for chrysochal.

**crystal;** a regular polyhedral solid form of a definite internal atomic structure, bounded by natural plane surfaces. This definite arrangement directly influences the physical and optical properties. Crystals are classified into seven systems according to the symmetry of its crystal faces. → Crystal systems.

**crystal;** a commercial term for diamond of a particular nuance of color.

**crystal;** a commercial name for sharp-edged octahedral rough diamond. → Glassie.

**crystal;** formerly color grading for a very slightly yellowish diamond.

**crystal;** a color scale for near-colorless diamonds, over 0.47 cts, used by Scan. D.N.

**crystal;** lead glass, which is used as glassware, diamond imitation, etc. Also called crystal glass.

**crystal;** a term used by Australian miners for semi-transparent and semi-translucent variety opal of white or gray background without milkiness, which exhibits a moderately play of color. Crystal opal is superior to jelly opal, but inferior to semi-black and crystal-black.

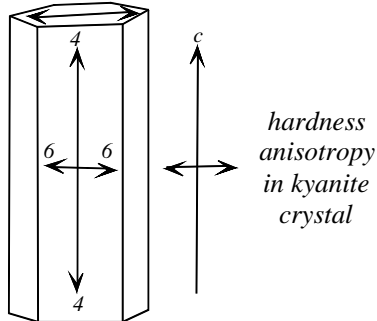
**crystal**; a term sometimes used for rock crystal.

**Crystal**; same as Kristall.

**crystal aggregate**; a cluster or group of crystal grown together so that each crystal in the group is large enough to be seen by the unaided eye and each crystal is more or less perfect. → Crystalline aggregate.

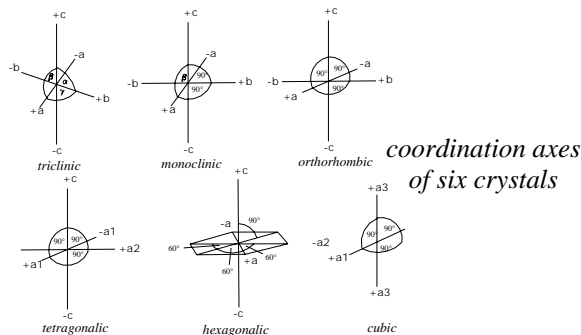
**crystal, angle**; in crystallography interfacial angles are the same as angles between two normals.

**crystal anisotropy**; a crystal whose physical properties vary in different directions, such crystals exhibit double refraction, for example break a ray of light into two



rays, which move with different velocities within the crystal, such crystals, minerals or gems have two refractive indices. Alternatively, cordierite has strong trichroism in three crystallographic directions. These properties normally include elasticity, conductivity, permittivity, permeability, etc. Crystals not belonging to the isometric system have this property. Also known as anisotropic, aeolotropy, eolotropy. → Isotropic, single refraction, double refraction.

**crystal axes**; three imaginary lines or axes that intersecting each other at a common point. Also called



coordination axes of six crystals

cartesian coordination.

**crystal axis**; one of the three imaginary lines passing through a crystal in important symmetry directions, intersecting in the origin at the center of the crystal. A reference axis used for the description of the vectorial properties of a crystal.

**crystal ball**; the glass globe used in crystal gazing.

**crystal-black**; a term used by Australian miners for an opal variety which is partly transparent from some

angles, from other angles shows a deep royal blue flash, therefore the stone appears opaque and like black-opal.

**crystal chemistry**; the study of the relations among chemical composition of a solid crystal, internal structure, and the physical properties of solids.

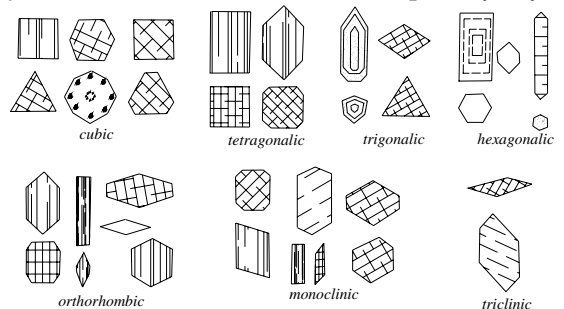
**crystal class**; one of the 32 crystallographically possible combinations of the element of symmetry. → Class (crystal).

**crystal cleavage**: same as cleavage.

**crystal coated**; many gem minerals are coated, when mined. The surface is more opaque than before and often was a different color from the material inside.

**crystal consciousness**; an earlier believing or superstitions of gems, rocks or other materials were valued much than as today for personal adornment, because of presumed magical powers ascribed to them were make one invulnerable, make to sleep, to prevent disease (or misfortune and to ward off evil), to render one invisible, give wisdom, etc., which today are found as good luck charms, religious symbols, birthstones, day-stone, week-stones. Also called superstition stones. → Amulet.

**crystal corn section under microscope**: any crystal



cross section of crystal corns under microscope

corn of crystal systems having their own peculiar form, which can be seen under microscope in following figures.

**crystal cushion**; combination of forms based on crystals sometimes of flattened cushion form.

**crystal, distorted**; same as distorted crystal.

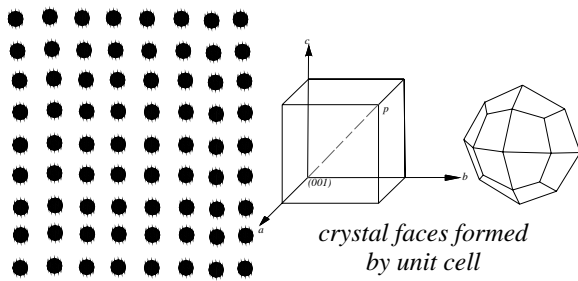
**crystal dog's tooth**; certain faces of crystal overdevelop into long thin forms, which curve slightly and have one end blunt and the other pointed, like a dog's tooth.

**crystal defect**; → lattice,-defect in.

**crystal etched features**; etching diamond with a hot oxidizing agent, surface features on various faces can be produced. → Etching marks.

**crystal faces**; in crystallography a natural flat, smooth, planar or geometrical surfaces that bound a crystal, and intersect to form sharp edges, and reflect its internal orderly structure. In the case of minute undistorted

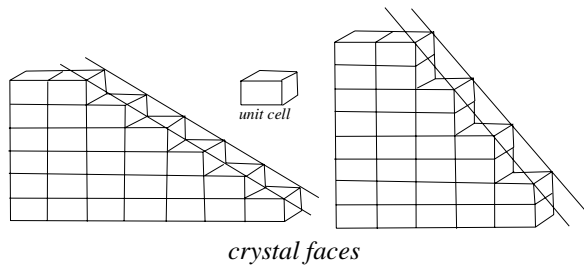
crystals, each face is an optically plane surface.



Crystals with well-developed faces are known as *euhedral* in contrast to *anhedral*. → Cleavage face, face, set.

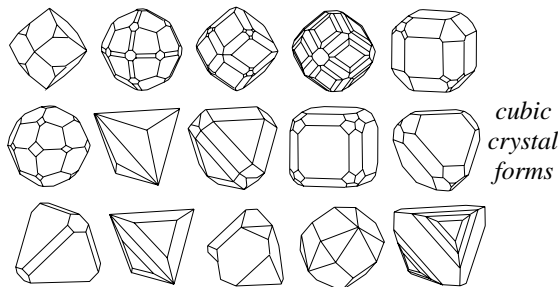
**crystal faces;** in brilliandeering the placing and polishing of the crown and pavilion facets on the brilliant-cut diamond after polishing the bezel and pavilion facets by the blocker. → Cleavage face, face, set.

**crystal face;** the sloping of a crystal wall, which formed crystal face, in which the unit of the bottom



row is longer than the row higher. → Cleavage face, face, set, crystal growth.

**crystal field;** six oxygen ions of corundum crystal as neighbors produce an electrostatic field around the aluminum ion in the center of polyhedron, which is known as crystal field, this can be described because of its



symmetry arrangement, distorted octahedral and the overall strength of the electric field.

**crystal field theory;** the internal theory that an electric field of an ion group in a solid metal atom the source of the negative charge, which causes the metal to response to an electric field and transitional metal colors.

**crystal form;** the external geometrical form or shape, in which crystals occur, such as cube, hexagonal, tetragonal, etc. Also known as crystal habitus. → Single form, closed form, opens form.

**crystal form, ideal;** → ideal crystal form.

**crystal gazing;** globe carved transparent beryl or quartz crystals are used as crystal gazing by concentrating upon the crystal (or glass globe) to inducing a psychical state, due which divination can be performed or attempt to predict the future. Also included crystallo-mancy, or some ritual of hydromancy. → Margaritomancy, crystallo-mancy, hydromancy, speculum, lithomancy.

**crystal gilding;** same as gilding.

**crystal glass;** a highly transparent, colorless and brilliance glass of high refractive index that resembles rock crystal, which may be *lime crystal* or *lead crystal*. When it contains 10-24% lead oxide is named as *half lead*, if it contains 30% lead oxide it is called *full lead*. Used for decorative articles, ornamental ware and as high-quality beads.

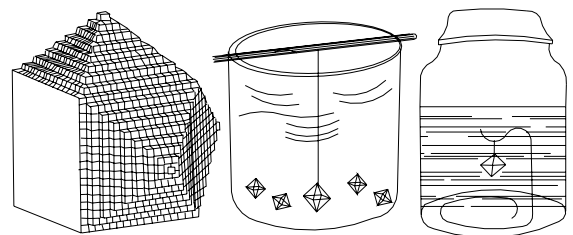
**crystal glassies;** a term for octahedral diamond crystals.

**crystal glazed;** devitrified glazes, in which crystallization has taken place.

**crystal goniometer;** → goniometer

**crystal group;** same as crystal aggregate.

**crystal growth;** the study of crystal growing method whereby their constituents are dissolved in superheated and saturated solution. Whereby the sloping feature of a crystal, in which the unit cell of the bottom row grow



crystal growth of an octahedron. After Huaey. Synthetic crystal growth on a string or metal wire

longer than the row higher, which will form the crystal faces.

**crystal growth line;** same as growth line.

**crystal habit;** the characteristic crystal form or forms, in which a solid substance usually appeared, such as prismatic, tabular, platy, etc. → Habit.

**crystal, hemihedral;** some crystals, possessing only half the number of faces required by the symmetry. →

Hemihedral.

**crystal, hemimorphic;** → hemimorphic.

**crystal, holohedral;** → holohedral.

**crystal, holosymmetric;** → holohedral crystal.

**crystal, indices;** same as Miller indices.

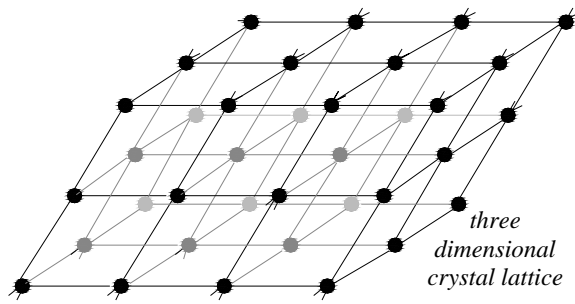
**crystal, irregular;** crystals of no form, or a hardly recognizable one.

**crystal intaglio;** another term for reverse crystal intaglio.

**crystal internal structure;** same as crystal lattice.

**crystal jewelry;** polished and faceted articles made of transparent quartz as distinguished from lead glass, which are sometimes called crystal.

**crystal lattice;** the regular and repeated three-dimensional arrangement of atoms and molecules with the same orientation that distinguishes solid substance



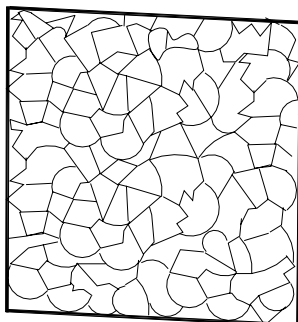
from all other states of matter. Also called lattice, space lattice, crystal internal structure.

**crystal lattice;** sometimes Used for Bavaris lattice.

**crystal layered growth;** it has been revealed that diamond grew in nature by a series of concentric layers of atoms on the octahedral faces.

**crystalline;** pertaining to or having the nature of a crystal without definite geometrical external form. Not glassy or not amorphous.

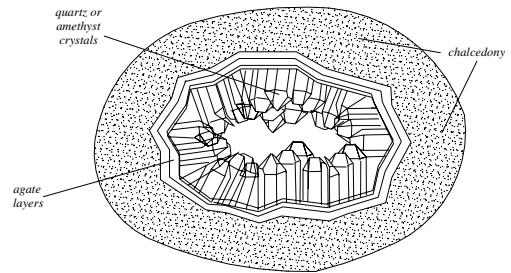
**crystalline;** resembling a crystal such as clear, transparent and pure.



**crystalline aggregate;** an aggregate of crystalline grains of fragments without well-defined geometrical external form. → Crystal aggregate.

**crystalline lined geode;** an often crystal-lined, hollow,

quasi rounded cavity, in which gem minerals are



a crystal lined geode

projecting towards the center, which usually differ in composition from surrounding material. Amethyst or quartz agate sometimes occurs this way. → Druse, vugh, miarolitic rocks.

**crystalline chert;** same as granular chert.

**crystalline emerald;** a misleading term for an emerald triplet.

**crystalline glass;** a misleading German commercial name for parti-colored glass, used as a gem imitation.

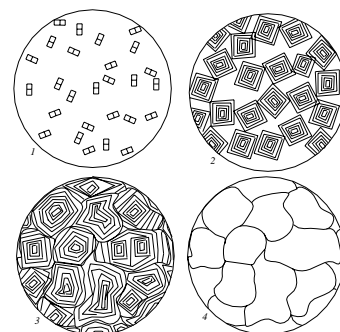
**crystalline grains;** minute crystal or grains of crystalline fragments, which compose a granular crystalline aggregate.

**crystalline limestone;** a term including metamorphic rocks marble, which is formed by recrystallization of sedimentary limestone such as cipolino, ophicalcite, and predazzite. Also called sedimentary marble.

**crystalline material;** any substance, which shows by physical and optical study the crystal structure of internal atoms but not definite geometrical external form. Also called crystal material. → Crystalline aggregate.

**crystalline quartz;** rock crystal, citrine, amethyst, etc. varieties that are large enough to see with the naked eye.

**crystalline, rock;** a rock composed of minerals plainly



in the crystalline state.

**crystalline, rock;** a term applied to metamorphic or igneous rock.

**crystallite;** minute minerals or grains of crystal

fragments without well-definite geometrical external form.

**crystallization;** deliberately formed crystals from solution, vapor, dispersed state, melt or an amorphous solid.

**crystallization degree;** the degree of crystallization, happen by an igneous rock such as hypocrySTALLINE, holocrySTALLINE and holohyaline.

**crystalloblast;** a mineral crystal formed entirely by metamorphic processes.

**crystallographic axis;** in crystallography one of three (four in hexagonal crystal) imaginary fixed lines in a crystal that intersect its center, which is used as a reference in describing crystal structure and symmetry. → Axes.

**crystallographic direction;** those directions in any crystal system, which refers to the formation of the mineral and often with the direction of one of the faces of the crystal. → Crystal faces.

**crystallographic plane;** any set of parallel and equally spaced planes, which can be described mathematically in terms of the lengths and directions of the crystallographic axes.

**crystallography;** the study of crystal properties, structure, and their classification into types.

**crystallohyaline;** same as hyalinocrystalline.

**crystallo luminescence;** the emission of light from a substance during its crystallization from a solution, such as arsenic oxide ( $\text{As}_2\text{O}_3$ ).

**crystallo mancy;** a method of divination by certain crystals gazing. Also crystals used as good-luck charms. → Speculum, margaritomancy, lithomancy, crystal gazing.

**crystallo us;** a rock crystal variety of quartz.

**crystal material;** same as crystalline material.

**crystal multiple;** gems, which are found two or more crystals joined together.

**crystal naats;** diamond crystals are internally twinned, part of the material having grown with an opposite crystal orientation, a mirror image, which is called naat.

**crystal, negative;** an inclusion in the form of a cavity in a crystal having the crystal form of the host mineral. → Negative crystal.

**crystal opal;** water opal or milk opal with intensive fire that are seen by reflected light from Butte, Oregon, USA.

**crystal plane;** → crystallographic plane.

**crystal polar;** same as hemimorphic crystal.

**crystal print;** any photomicrograph from polished stone surface. This photograph may be classified similar to the *fingerprint*.

**crystal pulling;** a method of producing synthetic crystal by pulling solidified material from the liquid. →

Czochralski pulling technique.

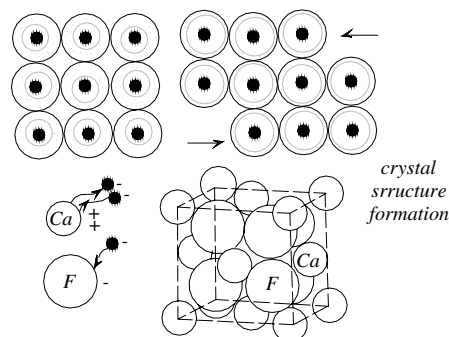
**crystal seeding;** introducing a small crystal into a liquid in order to initiate crystallization. → Seed crystal.

**crystal soldered emerald;** same as soldered emerald, but with rock crystal substituted for beryl.

**crystal striation;** fine parallel lines seen on the surface of a mineral or on the cleavage face.

**crystal structure;** → crystal structure formation.

**crystal structure formation;** the regular, orderly,

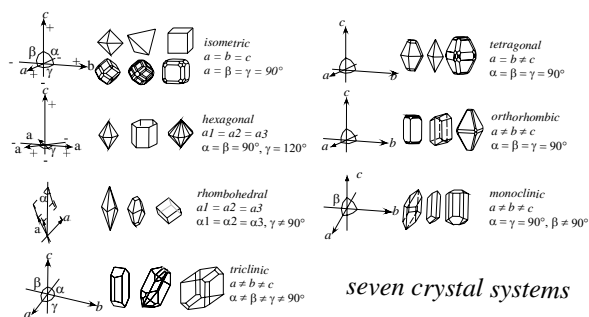


periodic or repeated arrangement of atoms, molecules, or ions in a crystal.

**crystal surface growths features on beryl;** → beryl surface growths features.

**crystal symmetry;** → symmetry.

**crystal systems;** one of six (or seven) group classifications of a crystalline mineral according to the



symmetry of its crystal faces. Each species occurring in only one of those systems. They are cubic, tetragonal, hexagonal (trigonal), orthorhombic, monoclinic and triclinic. → Seven-crystal system under their respective names, Bravais lattice.

**crystal, tabular;** a habit of a crystal occurring in a very flat, tablet-like crystal. → Tabular crystals.

**crystal, twinned;** same as twinning or twin crystal.

**crystal, unit cell;** the unit of crystal structure, which is the smallest part of a crystal.

**crystal, X-ray;** → X-ray crystallography.

**crystal twinning, internal;** diamond is commonly twinned internally. → Crystal naat.

**crystal violet;** a green dye compound of the rosaniline series ( $C_{25}H_{30}N_3Cl$ ), of benzene structure with a resonance structure depend between two structures. Soluble in water, chloroform and partially in alcohol and glycerol. It is a member of triphenylmethan. → Resonance.

**crystolon;** a commercial term for carborundum or silicon carbide (SiC) powder, used as an abrasive.

**Cs;** a chemical symbol for the element cesium.

**CSO;** an abbreviation for *Central Selling Organization* that distributes 80% of the world's rough gem diamond.

**cts;** an abbreviation for carat.

**Cu;** a chemical symbol for the element copper.

**Cuango;** location of alluvial diamond deposits and known kimberlite pipes in northeastern Angola, Africa. Also spelled Kwango.

**Cuanza River;** a river location of alluvial diamond deposits in northeastern Angola, Africa. Also known as Kwanza River.

**Cuban Capitol Diamond;** a yellow diamond of 23 cts. it was sold in Paris 1928 for Cuban Capitol at Havana. It is a South African stone.

**cubanite;** a rhombohedral variety of quartz.

**cubanite;** an opaque, bronze to yellow mineral of  $4[CuFe_2S_3]$ . Orthorhombic system. Metallic luster. SG:4.03-4.18. H:3½.

**cube;** a crystal form of six equivalent square faces perpendicular to each other. A crystal form of crystal system. Also called cube form. → Cubic system.

**cube;** a sorting name for large rough diamonds with the basic shapes of diamond crystals.

**cubic;** having the form of a cube. → Cubic system.

**cubic;** measuring or describing of a volume unit.

**cubic boron nitride;** same as boron nitride.

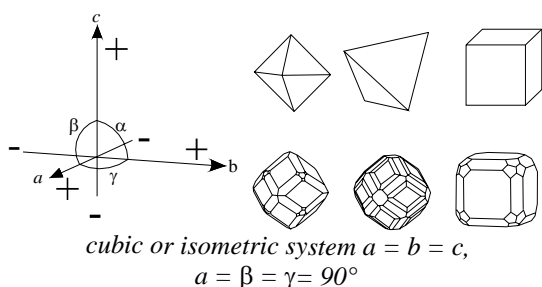
**cubic crystal:** → cubic system.

**cubic crystal system:** → cubic system.

**cube form;** → cube.

**cube ore;** a greenish-yellow to green mineral of hydroarsenate. It occurs in cubic form. Also called pharmacosiderite.

**cube spar;** a synonym for anhydrite.



**cubic mineral;** a misleading term for mineral of the

cubic system. Also called cubic stone.

**cubic stone;** same as cubic mineral.

**cubic system:** one of the crystal systems, which has the highest degree of symmetry of all the six (or seven system). It contains three axes of fourfold rotation at right angles of equal length parallel to each crystal axis. Also it has four axes of threefold rotation along all four diagonals. Also called isometric system, cubic crystal system, isometric crystal system.

**cubic zirconia (CZ);** → synthetic cubic zirconia.

**cubic zirconia, synthetic;** → synthetic cubic zirconia.

**cubic zirconium oxide;** → synthetic cubic zirconia.

**cubic Z refractometer;** a special refractometer incorporating synthetic cubic zirconia hemicylinder to obtain higher refractive index, which ranges from 1.40 to 2.10. Made by S & T Electro-Optical Systems corporation, Redondo Beach, California, USA.

**cuboid;** a rectangular parallelogram.

**cubo-octahedron;** a cubic crystal form bounded by the six equivalent squares of the cube and eight equal triangles of octagon. Also spelled cuboctahedron.

**cuboctahedron;** another spelling of cubo-octahedron.

**cuckoo;** a term used by Australian miners for a variety of sandstone or clayey nodule material near sandstone. Also called mottled sandstone, mottled.

**cuckoo sandstone;** same as mottled sandstone, speckled hen.

**Cuiaba Diamond;** a fine pale-rose diamond of 60.75 cts. found in Cuiaba, Minas-Gerais, Brazil. Present owner unknown.

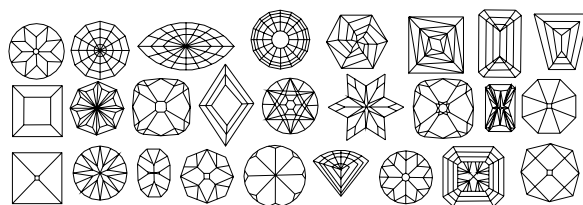
**culasse;** a French term for the base or pavilion of a cut diamond or other gemstones.

**culch;** a term applied to rock formations or paars to which young oysters attach themselves.

**culch;** a term applied to a collection of oyster occurring on the seabed, which is attached to dead coral, shells, and rocks. When it occurs artificially, it is called *culching*.

**culching;** → culch.

**culet;** the very small flat facet polished at the base of the



*different kind of culets*

pavilion of a brilliant-cut or other gemstone parallel to

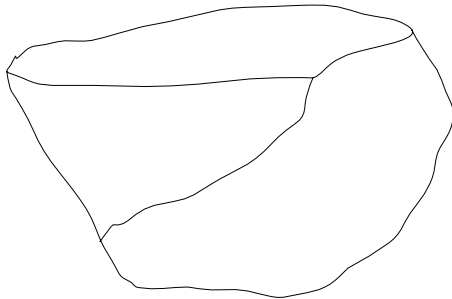
the table facet. Its principal function is to reduce the possibility of damage to the gem but is often omitted in modern cut stone. The sharp point apex is called a *close culet*, when larger than normal is called *open culet*. Also spelled culette, collet, collette.

**culette;** → culet.

**cullet;** a term applied to waste glass, which is used with batch to improve the rate of melting.

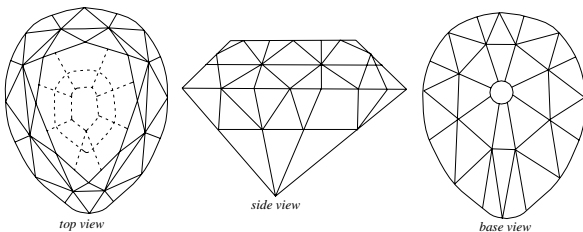
**Cullinan;** → Cullinan Diamond.

**Cullinan Diamond;** the world largest rough diamond ever found. It weighed 3106 cts. found at the Premier



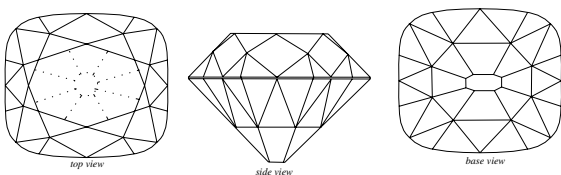
*Cullinan Diamond in rough*

Mine in South Transvaal, South Africa on 20<sup>th</sup> January 1905. It was named after Thomas Cullinan, Chairman



*Cullinan I or Star of Africa*

of the mine. From this magnificent stone two important diamonds were cut; One a pendeloque brilliant weighing 530.20 cts. (the largest cut brilliant in the world) and mounted in the Royal Scepter of the British

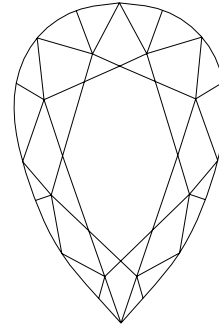


*Cullinan II or Lesser Star of Africa or Second Star of Africa*

Regalia. The other a square brilliant weighing 317.40 cts. is set in the British Imperial State Crown. Also

known as the Star of Africa I and II. Sometimes called Cullinan. → Cullinan diamonds I to IX.

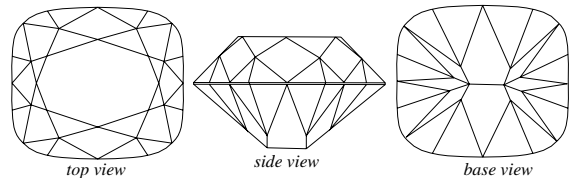
**Cullinan I;** a very fine, pendeloque-shaped diamond Type IIa of 530.20 cts, with 74 facets, mounted in the Royal Scepter of the British Regalia. Display among the British Crown Jewels. Also known as the Great Star



*Cullinan III or Lesser Star of Africa*

of Africa. → Cullinan diamond.

**Cullinan II;** a very fine, cushion-shaped diamond Type IIa of 317.40 cts, with 66 facets, mounted in the Royal



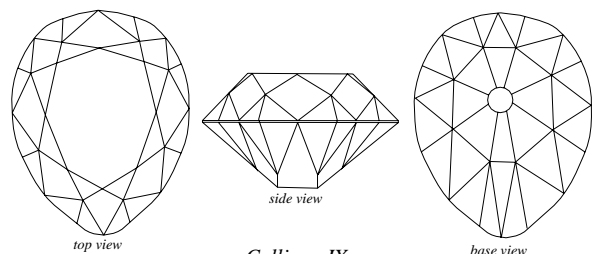
*Cullinan VIII*

State Crown. Now on display among the British Crown Jewels. Also called Lesser or Second Star of Africa. → Cullinan diamond.

**Cullinan III;** a very fine, pear-shaped diamond of 94.40 cts, mounted in a crown or in a pendant brooch. Also called Lesser Star of Africa. → Cullinan diamond.

**Cullinan IV;** a square-shaped diamond of 63.60 cts. mounted in a crown or in a pendant brooch. Also called Lesser Star of Africa. → Cullinan diamond.

**Cullinan V;** a heart-shaped diamond of 18.80 cts,



*Cullinan IX*

mounted in a brooch. → Cullinan diamond.

**Cullinan VI;** a marquise-shaped diamond of 11.50 cts, mounted in a diamond and emerald necklace. → Cullinan diamond.

**Cullinan VII;** a marquise-shaped diamond of 8.80 cts, mounted with the Cullinan VIII as a pendant on a diamond brooch. → Cullinan diamond.

**Cullinan VIII;** an oblong diamond-cut of 6.80 cts, mounted with the Cullinan VII as a pendant on a diamond brooch. → Cullinan diamond.

**Cullinan IX;** a pear-shaped diamond of 4.39 cts, mounted in a finger ring. → Cullinan diamond.

**cultivated pearl;** an alternate term for cultured pearl.

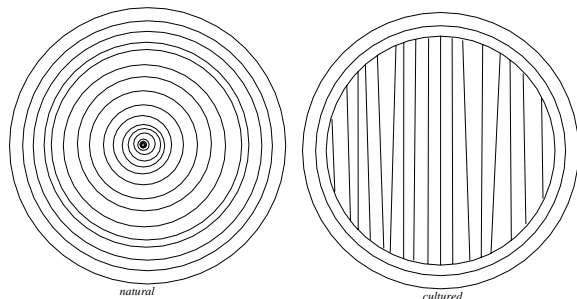
**cultivation centers of cultured pearls;** modern production of cultured pearl localities are in Japanese waters, Australia, Myanmar, Thailand, Tahiti, and New Guinea waters.

**culture pearl;** a rarely used term for cultured pearl.

**cultured blister pearl;** artificially inserted in the blister pearl oyster of an artificial nucleus or half-bead, usually mother-of-pearl or sometimes small Buddha figure in the shell of a fresh-water mussel, which coated it with nacre. The hemisphere bead is cut out from the mussel and the nacreous dome is removed and embedded onto a hemisphere of mother-of-pearl, which is called pearl doublet or mabé pearl. → Blister pearl.

**cultured emerald;** a misnomer for synthetical emerald, made by Chatham, San Francisco.

**cultured pearl;** a variety of pearl produced by the inducing in the pearl oyster, a piece of mantle tissue, a grain of sand, or other irritant, usually by the



cross section of cultured and natural pearl

introduction of a mother-of-pearl, and the deposition of nacre thereon by the pearl-bearing mollusk. Over this core, layers of nacre, seldom more than ½ millimeter in thickness, exactly like those of natural pearls. The technique was tried in China in the 13<sup>th</sup> century BC by inserting Buddha or other objects into a fresh-water mussel. Cultured pearls are produced largely in Japan, Australia, Myanmar, Thailand, Tahiti, and New Guinea waters. The pearl-producing mollusk, which lives in Japanese waters, is the small oyster *Pinctada martensii*, about 8 cm. The colors are: white, pink, cream, gray,

rose, black. RI:1.53-1.69. Birefringence: 1.56. SG:2.72-2.78. H:2½-4. Also called pearl cultivation. → Biwa pearls, mabé pearl, imitation pearl.

**cultured pearls, care;** → pearl,-care of.

**cultured pearls, drilling;** → drilling pearl.

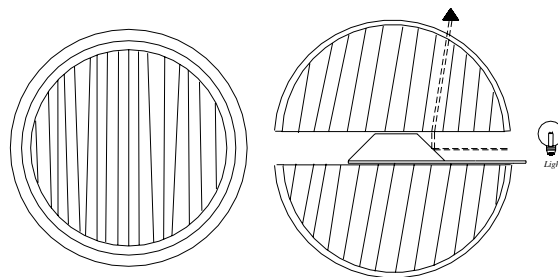
**cultured pearls, discrimination of;** to distinguish whether a particular pearl is of the cultured or the natural kind, it is necessary to determine whether or no the kernel, if present, is a mother-of-pearl bead, those methods, which have been used are optical examinations such as UV light, pearl microscope, pearl lucidoscope, and pearl endscope, or other tests such as specific gravity, pearl compass, or the use of X-rays methods.

**cultured pearl, fisheries;** → pearl fisheries.

**cultured pearl, fluorescence;** fluorescent test of pearls under UV light are not really very informative but non-nucleated freshwater cultured pearls showing the strongest fluorescence of all under X-rays.

**cultured pearl, grading;** → pearls grading, pearl.

**cultured pearl, identification;** some cultured pearls show a greenish tinge and certain marking on the surface, but an adequate test is to examine specific gravity and luminescence. Devices for examination are



left: cross section of cultured pearl. Right: action of the endscope in cultured pearl

pearl microscope (pearlometer), lucidoscope, pearl compass, endoscope and skiagram (X-ray test) for drilled pearls, for underlined pearls the Lauegrams.

**cultured pearl in ancient China;** → Chinese cultured pearl.

**cultured pearl, non-nucleated;** non-nucleated cultured pearls are grown by the induction of a piece of mantle into the Japanese freshwater mollusk *Hyriopsis Schlegeli*, which in Japanese is known as *ike-chogai*. These pearls are produced on pearl farms in Lake Biwa in Shiga Province, Honshu, Japan. They are known as *Biwa*, or sometimes as *Biwa-Ko* pearls; the termination -Ko: simply the Japanese word for lake.

**cultured pearl, nuclei preparation of;** the most suitable material to make a nucleus is mother-of-pearl bead, which is not foreign to the animal and inserted in the shell of a mussel, which coats it with nacre to



produce cultured pearl. The diameter of nuclei ranges from 1 to 6mm or more for *Pinctada martensii* to 13mm for *Pinctada maxima*. Rarely used salt-water genus *Trochidae* or *Trochus* mollusk. Is also known as bead nuclei for pearl.

**cultured pearl, protection of;** → pearl,-care of.

**cultured pearl, radiation of;** → irradiated pearl.

**cultured pearl, subcutaneous markings of;** → subcutaneous markings of cultured pearl.

**cultured pearl, whole;** → whole cultured pearl.

**cultured pearl, specific gravity of;** → pearl, cultured pearl.

**cultured ruby;** a misnomer for synthetically produced ruby, grown by Chatham, San Francisco, USA. They closely resemble natural ruby crystals in respect to properties and inclusions.

**cultured pearl staining;** → dyed pearl.

**cultured pearl weighing;** the unit of weight for cultured pearls are metric carat and sometimes grain.

**cultured-pearl Association of America;** it was founded in 1956. Headquarters for this association are located at: 663 Fifth Ave., New York City 10036, USA

**cumarin;** → coumarin.

**Cumberland Diamond;** a triangular shape fine Indian diamond of 32.82 cts, was purchased by the city of London to present to the Duke of Cumberland in appreciation of his victory at Culloden in 1746. Present owner unknown.

**cumingtonite;** a transparent to opaque, brown or green mineral of  $2[(Mg,Fe)_7(Si_8O_{22})(OH)_2]$  of the amphibole group. Triclinic system. Silky luster. Optics;  $\alpha:1.656$ ,  $\beta:1.671$ ,  $\gamma:1.688$ . Birefringence: 0.032.  $\oplus$ . SG:3.10-3.47. H:5-6. Cleavage: {110} good. → Rhodonite.

**cumula;** an old Chinese term for emerald. Also spelled cu-mu-la.

**cu-mu-la;** same as cumula.

**cumulate;** → accumulative rock.

**cuneate;** same as cuneiform.

**cuneiform;** a French term for wedge-shaped. Also called cuneate.

**cup coral;** a solitary coral, as opposed to a colonial coral. Also called simple coral.

**cupel;** a small and thick-bottomed cup made of bone ash used in gold or silver assaying with lead beads.

**cupellation;** the process of assaying or recovering precious metals such as gold and silver with a cupel. A method for freeing silver, gold or other nonoxidizing metals from base metals (lead metals), which can be oxidized. The base metals are absorbed in the cupel, leaving the pure metal to be decanted.

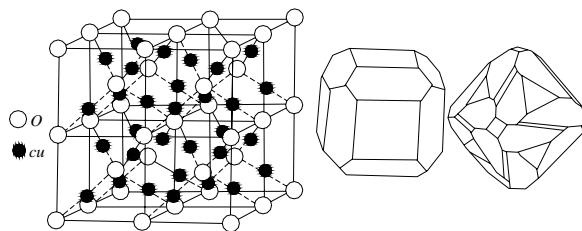
**cupid's darts;** same meaning as French word flèches d'amour. A term for hair-like needles of red or golden

colored rutile included in quartz. → Venus hair, Thetis hair.

**cupping tool;** for carving and engraving of stones a hand-held burr is used for hollowing out an ashtray. For agate cups a lager tool, which known as cupping tool is used.

**cupric arsenic;** → copper arsenite.

**cuprite;** a very rare, small clear crystals suitable for faceting, collector's gems, and sometimes used as cabochons and ornamental objects. Chemical formula:  $2[Cu_2O]$ . Cubic crystal. Color various shade of brownish-red to red. Brownish-red streak. Translucent



cuprite structure and crystals

to transparent. Adamantine to submetallic luster. Cleavage: {111} interrupted. Conchoidal to uneven fracture. Brittle. RI:2.849. SG:5.85-6.15. H:3½-4. Widespread occurrence. A suitable mineral for collectors and gems. Cochineal-red variety of cuprite is known as *chalcotrichite*. Also called octahedral copper ore, red glassy copper ore, ruby copper ore, red oxide of copper.

**cuprite;** a term applied to designate a cuprite-stained epidote metarhyolite, which has sometimes been cut cabochon and for ornamental objects. → Metarhyolite.

**cuproan tourmaline;** a synthetic tourmaline contain copper, known only as synthetic.

**cuprous;** pertaining to monovalent compound copper.

**curator;** the administrative head of a department in a museum.

**cured;** → decraqueler (pearl treatment).

**cure jet;** in the 19<sup>th</sup> century jet bracelets was worn as a cure for rheumatism.

**Curie;** (named after Marie Curie) a unit of radioactivity equal  $3.7 \times 10^{10}$  disintegrations per second. Abbr.: Ci.

**Curie-cut;** same as X-cut quartz.

**curio stone;** a stone of little intrinsic value, but which combines uniqueness or souvenir value with a reasonable amount of beauty and durability, for example cross stone, Niagara spar, etc.

**curio stone;** sometimes classed as an ornamental stone.

**curiol;** a term used in Costa Rica for jasper blackened by included manganese.

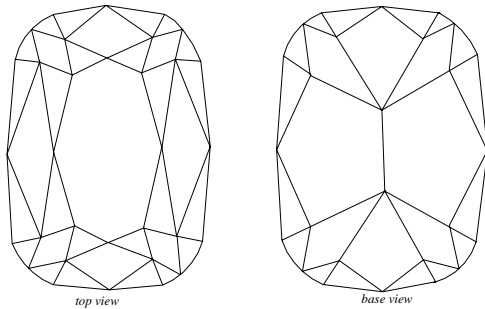
**curium;** a silvery metallic element in the Periodic

System, with the symbol Cm.

**curved striae;** line structures, which are like an onion, characteristic of synthetic stones and glasses.

**curvette;** a common misspelling of cuvette that is used for a cameo, engraved so that the design has a hollowed background and the edge of the stone raises as much as the central design, mostly engraved from hematite. Found in Cumberland, England. → Cuvette.

**cushion antique cut;** the older form of the brilliant cut,



antique cushion brilliant

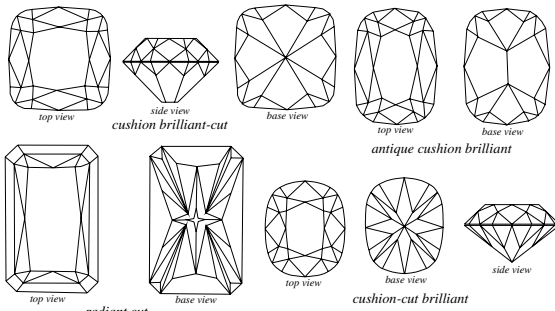
same as cushion cut.

**cushion brilliant;** → cushion-shaped brilliant.

**cushion crystal;** a rough diamond with a flattened shape.

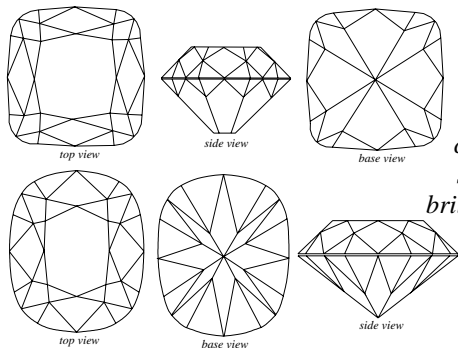
**cushion-cut carat estimator;** → appendices.

**cushion cuts;** any form of cutting of a diamond or other



different cushion cuts

gemstone, either faceted or not faceted as cabochon, for



cushion shaped brilliant-cuts

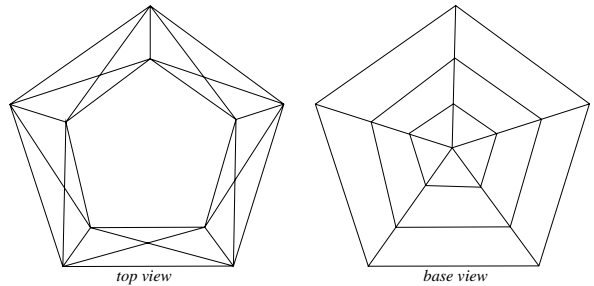
example rectangular shaped stone with rounded ends,

and curved sides' stones. Also called cushion antique cut, antique cut. Sometimes called buff-top-cut.

**cushion-shaped brilliant;** any modifications of the brilliant cut, both in outline and in the number of facets, more or less rectangular or square form with rounded corners to retain weight, for example pear-shaped, pendeloque, marquise, oval brilliant, etc. Also called cushion brilliant. → Antique cushion brilliant.

**cushion shape;** any rectangular or square brilliant cut with curved sides and corners.

**cushion step cut;** any modifications of the step-cut,



cut-cornered triangle

includes octagon step cut and the cushion step cut.

**custom gemolites;** any models of the gemolite, which employ binocular stereo microscopes of exceptionally high resolution and use the zoom feature.

**cut;** the form or style used in the fashioning of gemstones, such as brilliant-cut, emerald-cut and step cut as opposed to rough or uncut stone.

**cut and try;** → overlay work.

**cut-cornered triangle;** a modification of pentagon cut stone with 5-sided table (step-cut) of a diamond or other transparent gemstone, in which the outline is that of a triangle with two of the corners beveled off. Also called cut-cornered triangle cut.

**cut-cornered triangle cut;** → cut-cornered triangle.

**cut grading;** describing and evaluating the proportion and finishing of a fashioned diamond or other gemstones with regard to their brilliance, dispersion, and relationship between them. Also called proportion grading.

**cut of gemstones;** → cut of stones.

**cut quartz;** breaking quartz.

**cut rock;** same as excavated rock.

**cut of stones;** any forms or styles used in the fashioning of gemstones. Also called cut of gemstones. → Cut.

**cut steel;** a material used to imitate marcasite but it is easily distinguishable as cut steel rusts easily.

**cut stone;** generally a faceted diamond or stone used as an ornament, as distinguished from uncut or rough stone.

**cuttable diamonds;** same as cuttable rough.

**cuttable goods;** same as cuttable rough.

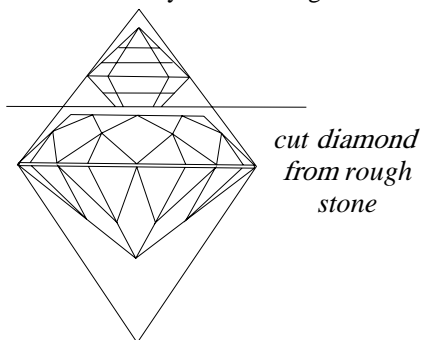
**cuttable rough;** all diamond materials suitable for cutting into gems or ornaments. Also called cuttable diamonds or cuttable goods.

**cutter;** a term applied to a worker fashioned gemstone. Also called bruter, diamond cutter.

**cutter;** one who cuts flat glass.

**cutter;** a workman engaged in grinding design on glass.

**cutting;** the process of the cutting or sawing, grinding, polishing, faceting of precious stone or other materials to improve its brilliancy on revolving diamond charged



grinding wheels. After cutting normally, it has symmetrical shape, either in cabochon. Also called fashioning. → Faceting device.

**cutting;** another term for corrasion.

**cutting;** the excavating space of the natural ground.

**cutting centers;** cutting centers devoted to all other gemstones are numerous. The major diamond-cutting centers are Antwerp in Belgian, Amsterdam in Netherlands, Johannesburg in South Africa, twin towns Idar-Oberstein in Germany, Hong Kong in China, London in England, Kofu in Japan, Paris, New York, Los Angeles in the USA, Brazil, Australia, New Zealand, Thailand, Sri Lanka, Israel, and elsewhere.

**cutting machine;** any mechanical or semi-mechanical machine used for grinding a diamond after the cleaving or sawing.

**cutting marking;** → diamond cutting marking.

**cuvette;** the cuvette combines features of cameo and intaglio by creating a shallow relief sculpture, which does not rise above the top surface.

**cuvette;** a term applied to small, hollow-glass or other material is used as container or as an immersion cell. → Curvette.

**cuvette;** a basin in which the sedimentation is going on.

**Cuyani River;** location of an alluvial diamond-bearing area in Venezuela and Guyana, South America.

**cyanidin;** a variety of anthocyanin obtained as glycosides in form of two heterocyclic groups in purple brown-red crystalline chloride  $C_{15}H_{11}ClO_6$ . It turns red in acid solution and blue in alkalic liquid. Used as acid-bade indicator and as dyes. → Anthocyanin.

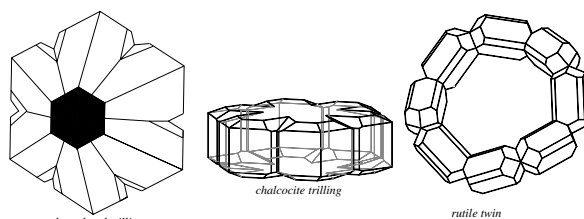
**cyanite;** another spelling for kyanite. A blue or light green aluminum silicate. A suitable mineral for collectors. Trimorphous with andalusite and sillimanite. Also called disthene, sappare. → cyanite.

**cyanos;** some authorities identified this term as ultramarine.

**cyanose;** a synonym for chalcantite. Also called cyanosite.

**cyanosite;** a synonym for chalcantite. Also called cyanose.

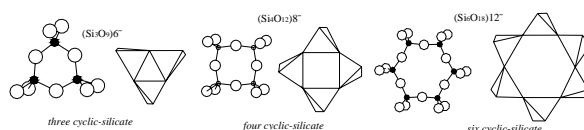
**cyclic twins;** repeated twinning that tends to produce circular forms according to the same twin law but with the twin axis or twin planes, such as chrysoberyl or aragonite crystals having a pseudo-hexagonal symmetry.



*cyclic twins*

**cyclone;** a term employed to an apparatus consists of a cone-shaped tank, in which valuable ores are separated or classified from crushed rocks. Principally a heavy media separator, in which gravels or broken rocks fed in from the side are centrifuged in a continuously circulating ferro-silicon or other slurry, when the heavy fragments sinks and the lighter one is extracted from the top. → Heavy media separation for diamond, heavy mineral separation.

**cyclosilicate;** arrangement of linked  $(SiO_4)^{4-}$  tetrahedra to ring structure with ratio of Si to O 1:3. There are three, four or six  $(SiO_4)^{4-}$  tetrahedra linked together



*isolated cyclosilicates*

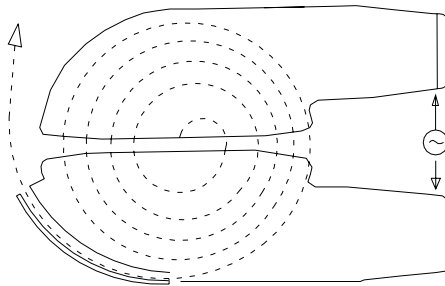
such as tourmaline, benitoite, beryl, etc. Also called ring silicate.

**cyclops agate;** any eye agate but with one eye. → Owl-eye agate.

**cyclotroned diamond;** any diamond, which is colored green by bombardment with fast-moving charged subatomic particles such as protons, deuterons or alpha-particles, which have been accelerated to a high speed by a cyclotron. Cyclotroned green diamonds may be turned to a golden-brown or yellow color by heating about 800° C. Cyclotroned diamond show under loupe or microscope an umbrella around their culet. Also called cyclotron-treated diamonds. → Diamond neutroned, treated diamond, radium-treated diamond.

**cyclotron-treated diamonds;** → cyclotroned diamonds.

**cyclotron treatment;** a type of accelerator machine for increasing the kinetic energy of substance particles or



cyclotron

atomic nuclei, in which the particles spiral inside two flat D-shaped hollow metal electrodes (called dees) under the effect of a strong vertical magnetic field, gaining energy by a high-frequency voltage applied between these electrodes. Often used to turn the color of diamond to green. Dark tourmaline turned to green, yellow, or reddish-brown. The deep penetrated diamonds showing under loupe or microscope an umbrella around its culet. → Electron accelerator.

**cylinder;** any fashioned gemstone as a cylinder form. Decorated with linear designs, inscriptions or names, animals, humans, plants, or scenes together with an inscription for use or seals. In the ancient business and social world drilled lengthwise for inserting of cord for carrying or wearing. Found in the Middle East and Balkans; dating from about 6000 BC. Often fashioned of gem minerals. Also called cylinder seal. → Seals, signet rings.

**cylinder seal;** → cylinder.

**cyma;** same as double cabochon.

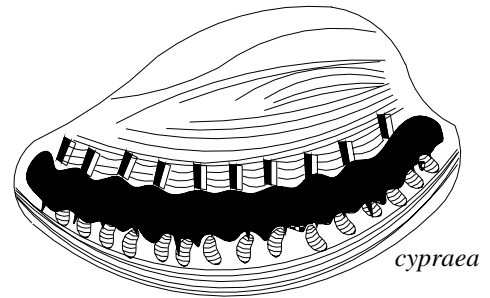
**cymatolite;** → silky cymatolite.

**cymophane;** the term is applied specially to a variety of chrysoberyl exhibiting a girasol or chatoyant effect, when cut en cabochon.

**cymophane;** more specially applied to chrysoberyl cat's-eye only.

**cymophane;** an alternative and synonym but little used name for chrysoberyl.

**cypraea;** a tropical seashell of family cowries with glossy, china-like shell. The largest known living in the West Indies and Florida in brown-spotted are 10-15 cm. Attracted by people who used them as ornaments, money, and by some native tribes as religious symbols.

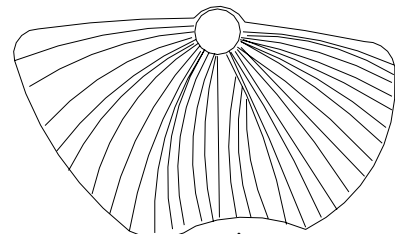


The enveloping of fleshy mantle creates the hard shell and attractive colors. It prized by collectors.

**cyprine;** synonym for a variety of vesuvianite or idocrase containing a trace of copper with pale-blue to sky-blue or greenish-blue color. Found in Telemak, Norway.

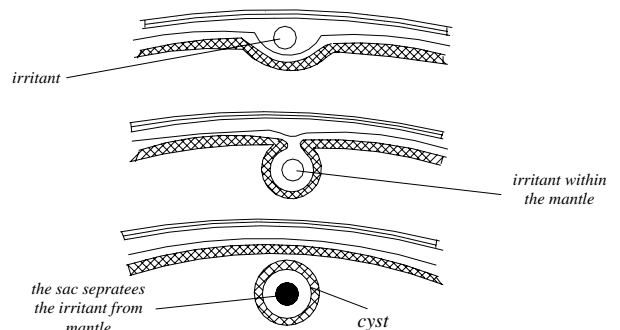
**Cyprine diamond;** a misleading term for quartz crystal from the island of Cyprus. Also known as Baffa diamond.

**cyrtina;** a kind of brachiopod fossil from middle Silurian to Subcarboniferous. Prized by collectors.



**cyrtolite;** a term allied to partially metamict variety of zircon.

**cyst;** → cyst pearl.



formation of a cyst pearl

**cyst pearl;** any type of natural pearl, which occurs

within the tissue of the mollusk itself as distinguished from pearl, which forms outside of the tissues or mantle. These pearls are not formed by a grain of sand or other similar object but a living parasite or microbe. The parasite was not cemented to the inside of oyster, but displaced in a depression under the mantle. The parasite produces a blister pearl, while the mantle secretes a series of concentric layer nacre entirely surrounding the parasite, which is known as *encystation*. These pearls are the most perfect. Sometimes the pearls are irregular in shape, when the sac is interfered with or is too near the edge of the mantle. Also called true pearl, mantle pearl, free pearls. → Encystation (of pearl), blister pearl.

**Cythia;** → Scythia.

**CZ;** an acronym for cubic zirconia.

**Czarina Blue Diamond;** a diamond of 30 cts, sold 1953 in Rome, Italy. Present owner unknown.

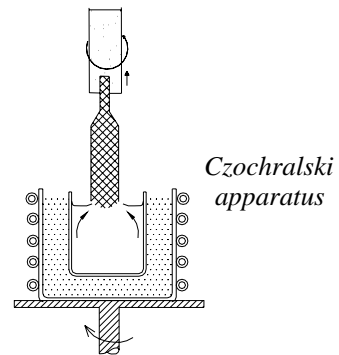
**Czochralski alexandrite;** alexandrite made by Czochralski method, which known in trade as allexite. → Czochralski technique.

**Czochralski method;** same as Czochralski technique.

**Czochralski pulling technique;** → Czochralski technique.

**Czochralski rubies;** rubies made by Czochralski method. → Czochralski technique.

**Czochralski sapphire;** sapphires made by Czochralski



method. → Czochralski technique.

**Czochralski technique;** a method of growing synthetic crystal by high-melting point devised by Czochralski and is named as Czochralski pulling technique. Where a seed crystal is gently lowered until it is in contact with the pure melt in the crucible and it is then pulled slowly upwards. The product shows rod-like single crystals. Used to make rare-earth garnets, lithium niobate, synthetic scheelite, and synthetic alexandrite.

# D d

**d**; an abbreviation for density, sometimes used for specific gravity.

**d**; a symbol for interplanar distance in Bragg's law measured in X-ray:

$$n\lambda = 2d\sin\theta.$$

**D**; an abbreviation for density, sometimes used for specific gravity.

**D**; a symbol for the element deuterium or hydrogen.

**D or d**; a symbol for diameter.

**D**; a group of three Fraunhofer lines in the yellow of the solar spectrum, the [D<sub>1</sub>] and [D<sub>2</sub>] wavelengths at 596.63 and 589.02 nm caused by sodium, and the [D<sub>3</sub>] wavelength at 587.56 nm caused by helium.

**D**; the highest color grading in the GIA color-grading of colorless diamond.

**dabbhani**; same as dabhani.

**dabhani**; an Arabic term for light green emerald similar to green color of *Cantharides* insect. Also spelled dabbhani.

**Dacca, Nawab of**; same as Nawab of Dacca (now Bangladesh). A 150 cts, Indian diamond belonging to the Nawab of Dacca (until 1955) and reported to be of square cut. Also called *Darya-i-Nûr* (which in Persian or Farsi means *sea of light*) but has no connection with the true *Darya-i-Nûr* (Iran).

**dacire**; a fine-grained extrusive rock used as a building stone.

**dacite**; a dark-colored, fine-grained extrusive igneous rock composed chiefly of acidic plagioclase and mafic minerals such as biotite, hornblende, pyroxene and less quartz. Frequently used as decorative or cladding stone.

**dactylotype intergrowth**; a mineral intergrowth, in which successive thin layers of a mineral are penetrated by a finger-like projections from another mineral, as in some orthoclase-nepheline intergrowth.

**dactyloglyphist**; a person who engraves gems or metals for rings and other ornamental objects.

**dactylography**; the scientific study of the history and lore of engraved gems.

**dactylography**; rarely used in the art of gem engraving.

**daeng chomppoo**; a Siamese term used for type-B, a classification of ruby used in Thailand for pinkish red stone, which has pinkish red to orange color. →

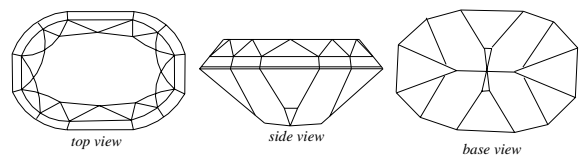
Ruby colors terminology in Thai, some.

**daeng dum**; a Siamese term used for type-D, a classification of ruby used in Thailand for blackish red stone, which has pure red color on the brilliant areas and blackish on extinction areas. → Ruby colors terminology in Thai, some.

**daeng som**; a Siamese term used for type-C, a classification of ruby used in Thailand for orangey red stone, which has slightly orangey red color. → Ruby colors terminology in Thai, some.

**dhani**; a term used in India for emerald with light yellow.

**Dahlia Cut**; a registered name for one of 5 new Flower style cuts with an exceptional different cut style. This was created for special effect with a 12-sided symmetrical oval-shaped, combined brilliant-cut and



*Tolkowsky Dahlia Flower Cut. Courtesy of De Beers, London*

step-cut with 63 facets. It is said to improve the color and reflection. Designed by CSO consultant Gabi Tolkowsky in 1988. The proportions are: table 56%, crown height 15%, pavilion depth 49% and a girdle of thickness medium to thick. → Flower Cuts; Fire Rose Cut, Dahlia Cut, Marigold Cut, Sunflower Cut, Zinnia Cut.

**dahlite**; a carbonate variety of apatite.

**Dale and Demko's mine**; synonym for Gregory Ruby Mine, USA

**dallasite**; location term for a green and white variety of jasper from Vancouver Island, British Columbia.

**damalah**; a Farsi term used for cabochon cut. → Tarmalah.

**damage blemish**; non-inherent blemish, caused during or after cutting.

**damage report**; damages report written by a qualified gemologist or a gemological laboratory.

**damar**; same as dammar.

**damar batu**; a local term for rock-like, opaque and colored lumps of dammar resins from the Philippines. Also called stone dammar.

**damar hitam**; a local term for black dammar resins from the Philippines.

**damar mata kucing**; same as dammar or cat's-eye dammar (resin).

**damar penak**; the fresh resin exuded from the *belanocarpus heimii* trees either naturally or by tapping, it is a clear, pale or yellowish, stalactitic resin of high quality.

**damborite**; a commercial term for light-yellow to dark wine-yellow synthetic corundum.

**damburite**; a commercial term for rose synthetic corundum.

**dammar**; any variety of resin from south east Asian coniferous Pinaceous trees with resinous odor, especially from the tree *hopea* and *pinus dammara*, of East India, which is marketed principally in Singapore, sometimes called cat's-eye resin or *damar mata kuching*. → Copal, black dammar, white dammar, kauri copal.

**dammar**; a clear, light yellow copal-like resin which is known as kauri copal and smells like turpentine. Used for varnishes, lacquers, sometimes as amber imitations, or melted with amber, and often containing real or imitation insects. Both become sticky, when rubbed briskly. Singapore dammar has a RI:1.515, and SG:1.062. A similar resin from Borneo known as *pontianak* has a RI:1.544. SG:1.07, and it melts at 135° C. The so-called *Manila copal* has a RI:1.544, and SG:1.072. Also called damar, dammer, resin damar. → Copal, black dammar, white dammar, kauri copal.

**dammar, black**; → black dammar.

**dammar, white**; a valuable white resin exuded from the *vateria indica* or *dipterocarpa*: genus trees (evergreen) from India. Black dammar produce by *dammara officinalis*, and kauri gum by *dammara australis*.

**dammer**; another spelling of dammar.

**damonite**; a commercial term for synthetic rutile used as a diamond imitation.

**damourite**; a massive variety of muscovite.

**damsonite**; a commercial term for light violet to gray-purple variety of amethystine chalcedony. Found in Arizona, USA.

**Danau Seran Swamp**; a regional location of alluvial diamond deposits in southern Kalimantan, Borneo, Indonesia.

**danbha**; an old Indian term for marks on the surface of emerald, which is similar to spider-web.

**damburite**; a variety of gemstone feldspars group that resembles topaz. Used as ornaments and cut as attractive and bright stones. Phosphorescence reddish, when heated, fluorescence pale to sky-blue. Erroneously called bementite.

System: orthorhombic.

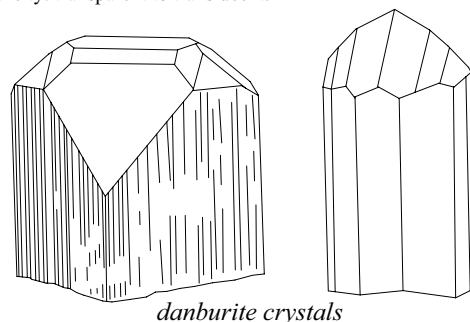
Formula:  $4[\text{CaB}_2\text{Si}_2\text{O}_8]$ .

Luster: brilliant vitreous to greasy.

Colors: colorless, white, pale pink, rose, pale to dark yellowish to yellowish green, brown.

Streak: colorless.

Diaphaneity: transparent to translucent.



Cleavage: {001} very indistincts.

Fracture: conchoidal. Brittle.

SG: 2.97-3.02.

H: 7.

Optics;  $\alpha$ :1.631,  $\beta$ :1.633-1.637,  $\gamma$ :1.636.

Birefringence: 0.006-0.008.  $\ominus$  or  $\oplus$ .

Dispersion: 0.017.

Found in Danbury, Connecticut (USA), Myanmar, (Burma), Malagasy, Russia, Mexico, Japan and Switzerland.

**danburite**; a misleading term for light red synthetic corundum. Also spelled danburyite.

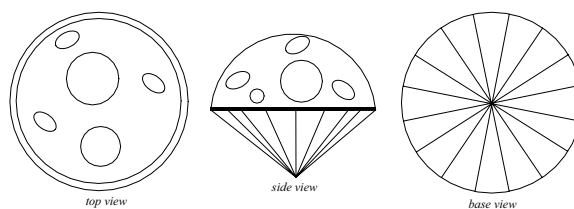
**danburite absorption spectrum**; often it shows the lines of rare earth spectrum.

**danburite luminescence**; luminescence is sky blue to pale blue-green under LWUV. It shows also thermo-luminescence.

**danburyite**; a misleading term for and another spelling for danburite.

**Dan Campbell diamond**; a diamond of 192.25 cts, in rough found in 1916 at Gong Gong, Vaal River, South Africa. Was cut into a stone of 32 cts. Present owner unknown.

**dandelion cut**; a modified cut form similar to dandelion flower. Top in cabochon form with some round pits,



*dandelion cut. After Tauro Paronen*

circular girdle and a 16-rayed star in the pavilion without culet.

**dandelion moon**; a new type of cutting machine for gemstones.

**Danish amber;** amber fished along the coasts of Denmark.

**dao;** a Chinese term for square-ended blade cut of jade.

**daourite;** a misleading term for red tourmaline from Daouria, Russia.

**Dar-Challa;** a subsidiary company of Compagnie Minière de LOubangui Oriental; a diamond mining company in Central Africa.

**Darcy Vargas diamond;** an irregular shaped, brown diamond of 460 cts. Found in 1939 in Coromandel district, Minas-Gerais, Brazil. It was presented to Darcy Vargas the wife of President Vargas. Present owner unknown.

**dark adaptation;** a term used for increasing of light intensity of eyes because of remaining in the dark.

**dark-bearer;** same as scotophore.

**dark brown;** a color classification of diamond.

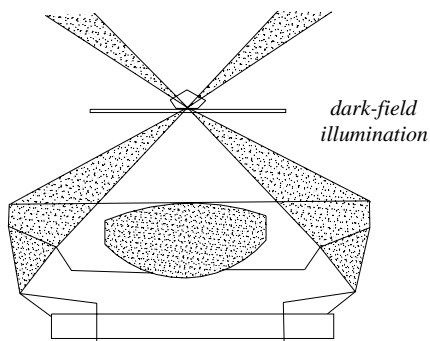
**dark cape;** a color classification of yellow to yellowish gem diamond in the lower end of the cape range subdivided into: very light yellow, light yellow, and yellow. → Cape stone.

**dark centered;** the dark center effect may be seen in round brilliant-cut diamonds when viewed directly face-up through the table of a stone with deep pavilion. Also called black centered stone.

**dark colored;** the minerals of the rock having dark color or are melanocratic as viewed macroscopically, but being transparent in thin sections.

**dark colored mineral;** same as dark mineral.

**dark-field illumination;** in optical microscopy, having a dark background. In optical mineralogy, a device whereby transparent or uncolored gem or mineral is



made to appear as bright particles on a dark background. This effect is created by passing light through a hollow cone of light while no part of light passes directly into the objective lens. The stone lies at the apex of this cone where the stone reflected and deflected light into the objective. It shows inclusions that appear bright and stand out clearly and reduces confusing surface reflections. Also a device incorporated in certain diamond and other gemstones

microscopes with a diffuseable strong transmitted light. This effect is created by passing light through a condenser from the side, while the specimen is viewed against a black background. It shows inclusions that appear bright and stand out clearly and reduces confusing surface reflections. Also called dark-ground illumination. → Light or bright-field illumination.

**dark filled ground;** a method of indirect illumination on a stage of a microscope, causing specimen to be brightly displayed by oblique rays against a dark background.

**dark ground illumination;** same as dark-filled illumination.

**dark line spectra;** observation, the spectrum of a transmitted light through or reflected from the surface of a gemstone or substance can be seen through a prism shows a different dark-line spectrum (or continuous spectrum of all wavelength such as sun), crossed by black or dark bands or fine lines caused by the emission spectrum in bright background. The emission and absorption spectra of gemstones are characteristics, they serve to identify the elements present in a material, as they exist in different positions showing dark lines in the spectrum, for different elements at any chemical combinations. → Fraunhofer lines, continuous spectrum.

**dark mineral;** synonym for mafite or melanocratic. Any minerals from a group of rock-forming minerals having dark color as seen in the thin sections.

**dark reddish African amber;** a misleading term used for heat-reddened copal beads.

**dark red silver ore;** same as pyrargyrite.

**dark ruby silver;** same as pyrargyrite.

**dark yellow;** a color classification of pure diamond.

**darlingite;** a variety of Lydian stone or touchstone from Victoria, Australia, used as a testing quality of precious metals. A synonym for Lydian stone.

**darlingtonite;** same as jasper.

**Darwin glass;** same as Tasmanian tektite. A colorless, greenish, yellowish-green, transparent to opaque, highly siliceous, vesicular, frothy form of tektite. RI:1.47-1.50. SG:1.85-2.30. Found in the Mount Darwin range in western Tasmania near Queenstown, Australia. Also called darwinite, and queenstownite. → Tektite.

**darwinite;** same as Darwin glass.

**Darya-i-Nûr Diamond;** Darya-i-Nûr Diamond (Dacca), which is known as Nawab of Dacca, which has no connection with the true Darya-i-Nûr (Iran). → Great Table, Nûr-ul-Ain Diamond.

**Darya-i-Nûr Diamond (Iran);** in Persian or Farsi it means *sea of light*. The world's largest and most beautiful, pale pink Indian diamond in the Treasury



Jewels of Iran, having been taken from the Mogul's treasures, when Dehli was sacked in 1739 by Persian invaders Nadir Shah. It is flawless with a weight estimated to be between 175 or 195 cts, in its present rectangular step-cut table form. It is set in a gold, rectangular frame, between two jeweled lions. It is suggested that the Darya-i-Nûr at Tehran Treasury is indeed the Great Table or rather a part of it. Also spelled Dariya-eye-Noor.

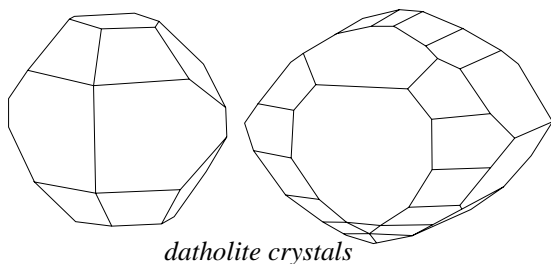
**Dariya-eye-Noor;** → Darya-i-Nûr Diamond.

**Darraya-i-Nur;** → Darya-i-Nûr Diamond.

**dash inclusions in Kashan rubies;** a term used for dashed rows arrangement of small particles as inclusions in Kashan synthetic rubies, which appeared similar to a dash or resemble a dot. → Dot inclusions in Kashan rubies.

**date stone jade;** a Chinese term employed to particular color of jade.

**datolite;** a rare silicate mineral of gadolinite group. Is



*datholite crystals*

sometimes cut as a curio stone and prized by collectors and cut as cabochon.

System: monoclinic.

Formula:  $4[\text{CaBSiO}_4(\text{OH})]$ .

Luster: vitreous.

Colors: colorless, pale yellowish to yellowish greens, white, pink, reddish or brownish.

Streak: colorless.

Diaphaneity: transparent to translucent.

Cleavage: none.

Fracture: conchoidal to uneven. Brittle.

SG: 2.80-3.00.

H: 5-5½.

Optics:  $\alpha$ : 1.622-1.626,  $\beta$ : 1.649-1.659,  $\gamma$ : 1.666-1.671.

Birefringence: 0.044-0.048.  $\ominus$ .

Dispersion: 0.016.

Found in Italy, Norway, Tasmania, Germany, Mexico, England, Austria, Russia, and New Jersey (USA),

**datolite luminescence;** blue color under SWUV.

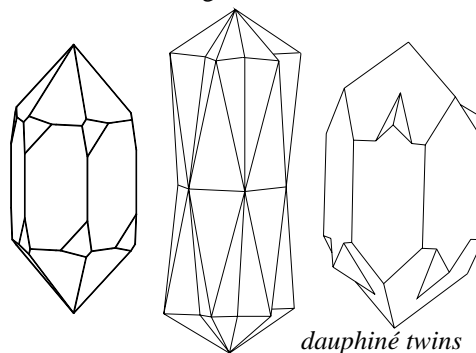
**Daughter of the Goddess Emerald;** → Emerald Goddess.

**Dauphiné diamond;** a misleading term for rock crystal

from Dauphiné, French Alps.

**Dauphiné twin law;** → Dauphiné twin.

**Dauphiné twin;** a twin in the hexagonal system of quartz, in which two right-handed or two left-handed



*dauphiné twins*

individuals from an interpenetrating twin by a 180° rotation about the c axis. It can only be detected by X-ray diffraction or etching. Also called electrical twinning.

**dauphinite;** a synonym of anatase.

**daurite;** a misleading term for daourite.

**Dauvillier's method of Lauegrams;** in 1924 Dauvillier experimented with Lauegrams by X-ray of natural and cultured pearls. The result of the experiments showed that a different pattern occurred in one direction in cultured pearls.

**dauidsonita;** a Spanish term for davidsonite.

**davidsonite;** a term for green or greenish-yellow variety of beryl from vicinity of Aberdeen, Scotland, England.

**dawn stone;** → eolith.

**Dayarai Diamond;** a diamond of unknown weight and origin. Brought in 1921 to the USA by Princess Fatima the daughter of Yakob Khan, Sultan of Afghanistan. Present owner unknown.

**daylight lamp;** a lamp that emits light whose spectral distribution curve is approximately similar to daylight, such as a fluorescent or incandescent lamp.

**D.C.;** abbreviation for diamond cut or brilliant cut.

**d-d absorptions;** → transition elements.

**d-d colors;** → transition elements.

**d-d transitions;** → transition elements.

**dead;** same as dead opal.

**dead chert;** same as chalky chert.

**dead coral reef;** a coral reef or a part of coral reef with no living coral.

**dead opal;** a term used by Australian miners for worthless opal. Also called dead.

**dead opal;** a term used by Australian miners for opal without life. Also called dead.

**dead pearl;** a misleading commercial term used for natural pearl without luster or dead white.

**dead quartz;** quartz carrying no valuable gems.

**De Beers;** occasionally used to refer to all other names from De Beers Consolidated Mines Ltd., etc.

**De Beers Centenary AG;** a sister corporation of De Beers Consolidated Mines founded in 1990 in Lucerne, Switzerland, to hold De Beers' assets, not in South Africa.

**De Beers Collection;** a fine collection of 150 colored diamonds by De Beers Consolidated Mines Ltd.

**De Beers Consolidated Mines Ltd.;** a company that is the major factor in the diamond mining and diamond industry, it was founded in 1880 in Kimberly, South Africa. De Beers' now operates a series of mines including Wesselton, Dutoitspan, Finsch, Bulfontein, Premier, Koffiefontein, Namaqualand, and off the coast of Namaqualand and Namibia.

**De Beers Diamond;** a pale-yellow octahedron diamond of 428.50 cts. Found in 1888 in De Beers mine and called by its name. From it a cushion-shaped brilliant, weighing 234.50 cts, was cut, it was bought by an Indian in 1889. In 1925, it was sold by Cartier and was last sold in 1982.

**De Beers Diamond Mine;** one of the *Big Five* diamond mine in South Africa. It was named as Old De Beers Mine. → De Beers Consolidated Mines Ltd.

**De Beers Industrial Diamond Division;** a subsidiary company of De Beers Consolidated Mines and De Beers Centenary AG, which operates research of diamond synthetic factories and markets natural and synthetic diamonds and boron nitride-based products for industrial uses. Abbreviation: DEBID.

**De Beers Marine Ltd.;** a subsidiary company of De Beers Consolidated Mines established in Cape Town, South Africa. They operate in 120 meters (394 feet) of deep water off the coast of Namaqualand and Namibia.

**De Beers Mine;** a diamond pipe (one of the Big Five) in South Africa discovered in 1871 on a farm near Kimberley owned by De Beer Family. It was this mine that took the formation of De Beers Consolidated Mines, Ltd.

**De Beers Mining Company;** a company founded in 1880. → De Beers Consolidated Mines.

**De Beers New Rush;** → Kimberley Mine.

**De Beers synthetic diamond;** the production of industrial and gem-quality synthetic diamond, which are grown by the Diamond Research laboratory in Johannesburg, South Africa.

**de Berquem, Louis;** → Berquem, Louis de.

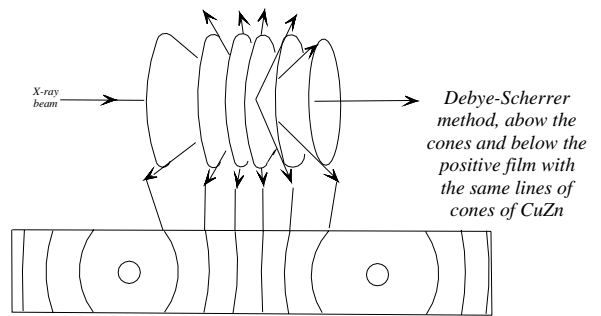
**de Berquem, Robert;** → Berquem, Robert de.

**debris;** large surficial fragments of loose material detached from rocks by mechanical and chemical means.

**debris;** same as rock waste.

**Debye-Scherrer method;** a technique used in X-ray crystal analysis in powder form or in aggregate

state. → X-ray powder diffraction.



**decae;** → Ave.

**decay;** the general desegregation of rocks, such as weathering or wasting away of rock, for example gradual decline of brightness of an excited phosphor. Decomposition.

**decay;** same as radioactive decay.

**decayed fluorite;** same as decomposed fluorite.

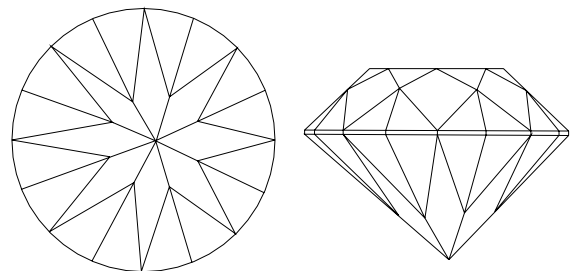
**decayed granite;** same as decomposed granite. → Gowan.

**decayed rock;** same as decomposed rock.

**decayed saprolite;** same as decomposed saprolite.

**Deccan;** an area of India where basalt rock occurs and well-known Scotch Pebbles found in river-gravels agate in amygdaloids or cavities. → Landscape agate.

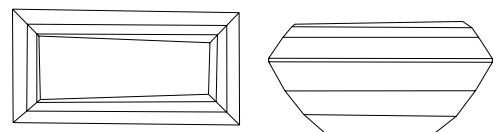
**decentered brilliant-cut;** a brilliant cut by which the



*decentered brilliant-cut*

table and facets in the crown and pavilion facets are not symmetrically to central point of stone.

**decentered emerald-cut;** an emerald cut by which the



*decentered emerald-cut*

table and facets in the crown and pavilion facets are not symmetrically to central point of stone.

**deceptive practice;** any perceptually misleading of color, clarity, condition, value, weight, or nature of gemstone or diamond. Also any failure to disclose that a stone has been treated or that it is synthetic or imitation.

**De Chaulnes' method;** → direct method, Chaulnes' refractive index determining.

**De Chaulnes' refractive index determining;** → direct method.

**decomposed fluorite;** same as decayed fluorite.

**decomposed granite;** same as decayed granite. → Gowan.

**decomposed rock;** same as decayed rock.

**decomposed saprolite;** same as decayed saprolite.

**decomposition;** any process of chemical breakdown following the action of chemical reagents, heat or living matter into simpler molecular substance or atoms. Also called chemical weathering.

**De Chaulnes' method;** → direct method, Chaulnes' refractive index determining.

**De Chaulnes' refractive index determining;** → direct method.

**deconsolidation;** same as chemical weathering.

**decorative mineral;** same as ornamental mineral.

**decorative stone;** any stone used for architectural decoration, as in mantles, columns, and storefronts. It is sometimes set with silver or gold-filled jewelry, but usually cut as a curio stone.

**decorator;** one who traces lettering and designing on the surface of granite, marble or other stone to prepare for cutting.

**decraqueler (pearl treatment);** a method of healing the cracks in the surface of pearls, which are *cured* by soaking in warm olive oil, about 150° C, such pearls tend to change to brown after a time.

**decrepitation;** the breaking up with a crackling sound of rock or mineral, when crystals are suddenly heated, caused by internal stresses and cracking, as when rock salt is thrown upon the fire. Fracture of crystals on heating.

**Deepdene Diamond;** a golden-yellow (most notorious color treated stone), cushion-cut diamond of 104.88 cts. Named after the estate of Mrs. Book's Family. It was sold in 1955. Also spelled Deepdeen. Not to be confused with a 104.52 cts, diamond, which was alleged to be the Deepdene, but later was found to be a treated stone.

**Deepdeen;** → Deepdene Diamond.

**deep pavilion;** when the depth of the pavilion of a diamond brilliant-cut exceeds 44 percents of the average girdle diameter, it can lead to expressing the light leakage the deep pavilion may show a dark center, when looked through the table.

**deer horn;** a horny substance near to the bone of certain deer family *Cervidae*. Has been used instead of ivory for small carving of objects, for inlays, and netsukes of Japanese or in Germany has been used as inlay. Usually brownish in color. RI 1.56. SG:1.70-1.85. H:2½. Also called stag horn.

**deer horn pearl;** a pearl from the buck-horn clam. Sometimes called deer-horn.

**defect crystal;** a discontinuity in the crystal lattice.

**defect in lattice;** → Lattice,-defect in.

**decomposition;** any process of chemical breakdown following the action of chemical reagents, heat or living matter into simpler molecular substance or atoms.

**decorative mineral;** same as ornamental mineral.

**decorative stone;** any stone used for architectural decoration, as in mantles, columns, and storefronts. It is sometimes set with silver or gold-filled jewelry, but usually cut as a curio stone.

**decraqueler (pearl treatment);** a method of healing the cracks in the surface of pearls, which are *cured* by soaking in warm olive oil, about 150° C, such pearls tend to change to brown after a time.

**decrepitation;** the breaking up with a crackling sound of rock or mineral, when crystals are suddenly heated, caused by internal stresses and cracking, as when rock salt is thrown upon the fire. Fracture of crystals on heating.

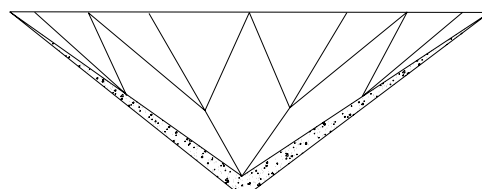
**deep-country;** a term used by Australian miners as contrast with shallow-country. → Shallow country.

**Deepdene Diamond;** a golden-yellow (most notorious color treated stone), cushion-cut diamond of 104.88 cts. Named after the estate of Mrs. Book's Family. It was sold in 1955. Also spelled Deepdeen. Not to be confused with a 104.52 cts, diamond, which was alleged to be the Deepdene, but later was found to be a treated stone.

**Deepdeen;** → Deepdene Diamond.

**deep donor;** when a donor in a crystal seat deep in contrast to shallow acceptor. For interaction between two donor and acceptor both must be either deep or shallow.

**deep pavilion;** when the depth of the pavilion of a



*deep pavilion. Hatched part shows a normal pavilion depth*

diamond brilliant-cut exceeds 44 percents of the average girdle diameter, it can lead to expressing the

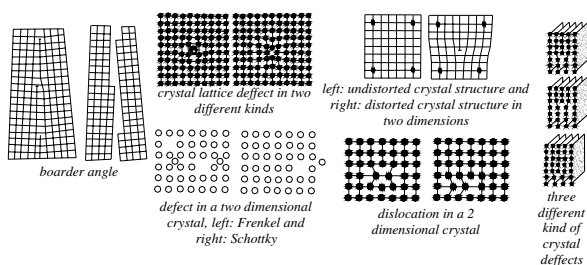
light leakage the deep pavilion may show a dark center, when looked through the table.

**deer horn;** a horny substance near to the bone of certain deer family *Cervidae*. Has been used instead of ivory for small carving of objects, for inlays, and netsukes of Japanese or in Germany has been used as inlay. Usually brownish in color. RI 1.56. SG:1.70-1.85. H:2½. Also called stag horn.

**deer horn pearl;** a pearl from the buck-horn clam. Sometimes called deer-horn.

**defect crystal;** a discontinuity in the crystal lattice.

**defects in crystal and color effect;** mechanism of color alteration caused by involves the operation of a color center which occur from a defect in a crystal structure. In a defect an atom may be missing from its expected position, the space of this defect, which should have filled from the atom, is known as vacancy. There are



*different kinds of crystal defect*

two well-known arrangements of crystal structure defects. (a) frequently a missing ion (positive or negative) displaced in an occupied position in a crystal structure, where normally is no ion present, which known as *interstitial site* and caused a pair of defects (a vacancy and an interstitial site), this effect named as *Frenkel defect*. (b) a singly ion (charged atom) can not be absent in a crystal structure when electrical neutrality of crystal is preserved, but a pair of electrically balanced ions (positive and negative) or vacancies can be absent and removed to the surface of the crystal, which is known as *Schottky defect*. Both defects produce not color by themselves nor light absorption but subsequently give the color of crystals caused by irradiations. Other ways in which alien atoms may occupy reserved sites for regular atoms with the name *substitution* such as replacing of a  $Ca^{+2}$  two  $Na^{+}$  atoms to preserve electrical neutrality. May be an alien atoms occupy a site which lies outside of regular lattice similar to chessman placed on the border between two squares which is named as *interstitial*. Defect in crystals can produce by *shock waves*, which may give rise to thermoluminescence. → Lattice,-defect in, F center, color centers.

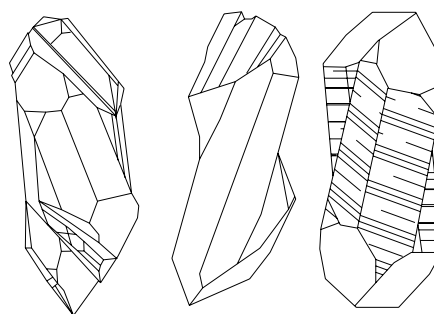
**defect in lattice;** → Lattice,-defect in.

**defective color vision;** known as color blindness. A condition of faulty spectral color vision, in which the distinguishing of one color from another is very severe or not possible. The commonest form is in dichromatic vision, in which the insensitivity to those wavelengths in the red longer than 680 nm (normal vision extends to 750 nm). In another type of deficiency, red-green produce the same sensation as yellow. Color blindness can affect the ability to color grade diamonds. It appears to be a normal state for animals that are only active at night. Also called color discrimination deficiency.

**definition of color;** → color,-definition.

**deflagration;** to burn with rapid and violent combustion.

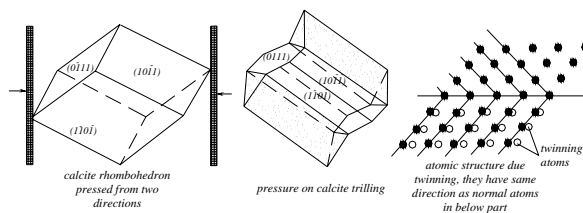
**deformed crystal;** the act of deformation of a crystal, when its shape is twisted out, so that the angles between



*deformed or twisted quartz*

its crystal faces may differ widely from those on the regular form. Also called strained crystal.

**deformation twin;** in crystallography twin which is



*deformation due to sliding twinning*

formed by gliding. Also called strain twin, mechanical twin.

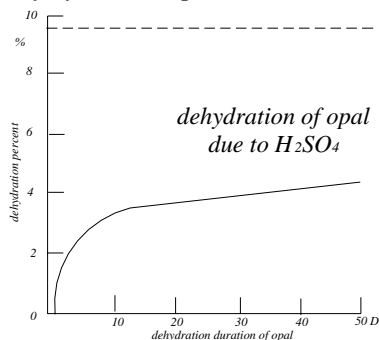
**deformation twinning;** same as secondary twinning.

**Degussite;** a colorless synthetic spinel manufactured by Degussa in Frankfurt/Main, Germany.

**dehydration;** removal of water, usually, when it is chemically combined in a compound, which can be seen in opals due to aging. Opal is hydrous gemstone and sometimes loses water and tends to crack, which is seen in the figure below. The drying.

**dehydrated stone;** removal of normal water from a

stone, usually by a natural process.



**De Kalk Farm;** a farm in the Orange River, South Africa, where the Eureka Diamond in 1866 was found.

**dekorite;** a trade term for phenol formaldehyde resin that is called bakelite.

**de la mar pearl;** a commercial term for an imitation pearl.

**delatinite;** a misspelling of delatynite.

**delatynite;** a variety of amber from Delatyn in the Galician, Carpathians Mountains, Romanian rich in carbon, low in succinic acid and lacking in sulfur. SG:1.0444. H:2-2¼. Sometimes misspelled delatinite. Also, found in Baltic area. → Almashite.

**delawarite;** a term applied to the pearly aventurine feldspar from Delaware, Pennsylvania, USA.

**Deleff Collection;** a pale blue Brazilian topaz of 250kg in rough found in 1987. Now on display at the Natural History Museum, Paris, France.

**Deleff Collection;** a pale blue Brazilian topaz of 200kg in rough found in 1987. Now on display at the Natural History Museum, Paris, France.

**Deleff Collection;** a pale blue Brazilian topaz of 117kg in rough found in 1987. Now on display at the Natural History Museum, Vienna, Austria.

**delf;** a term used in England for a thin layer of ironstone.

**delf;** same as quarry.

**Delhi, Sack of;** → Sack of Dehli.

**deliquescence;** conversion to liquid on exposure to air, often by means of solution in atmospheric water.

**delocalized electron;** in crystal structure of pyrrhotite (approximation FeS), can be detected that electrons are at least not symmetrically or they are delocalized.

**De Long Star Ruby;** a natural star ruby of 100.32 cts. Found in 1930 in Myanmar, (Burma). Named after George Bowen de Long who donated it to the American Museum of Natural History, New York City, USA.

**delphinite;** a yellowish-green variety of epidote from France. Sometimes called oisanite or thallite.

**delta pearl;** a commercial name for imitation pearls such as solid-wax-filled pearl.

**dellenite;** synonym for rhyodacite, toscanite, quartz latite.

**dellenite glass;** same as rhyodacite glass, toscanite glass,

quartz latite glass.

**Deluxe Gemolite;** an instrument used for measuring purity of diamond. Made by Gemological Institute of America.

**demantoid;** an attractive, transparent, bright green variety of andradite garnet, having a brilliant luster. It is reddish, when viewed through Chelsea filter. Absorption spectrum in the violet part at 443 nm caused by iron oxide. It has a characteristic arrangement of byssolite as inclusions, which are known as *horse tails*. Yellow variety of demantoid is miscalled *topazolite*. Also misnomered as *Uralian emerald*, *Uralian emerald*, *Siberian chrysolite*, *Bobrovskia garnet*, and sometimes miscalled *olivine*. Sometimes asbestos fibers are included or so-called *byssolite* inclusions hence they are called *ponytails*. Synonym for andradite garnet.

System: cubic.

Formula: 8[Ca<sub>3</sub>Fe<sub>2</sub>(SiO<sub>4</sub>)<sub>3</sub>]. May contain Cr.

Luster: adamantine, vitreous to resinous.

Colors: green, yellowish-green, yellow, gray-green or black.

Streak: white.

Diaphaneity: transparent to opaque.

Cleavage: not determined.

Fracture: uneven. Brittle.

SG: 3.81 - 3.90.

H: 6 - 7 .

RI: 1.880-1.895 .

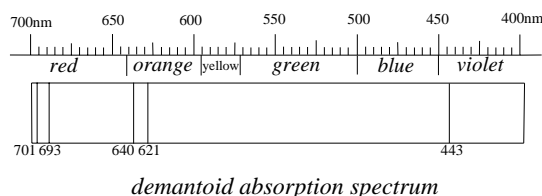
Birefringence: none.

Dispersion: 0.057.

Source : Russia, Korea, USA and Congo.

**demantoid;** as an adjective, diamond-like.

**demantoid absorption spectrum;** most demantoid



stones show absorption bands almost nearly at 443, 621, 640, 693 and 701 nm from violet to red.

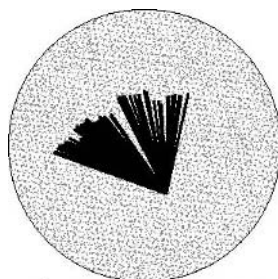
**demantoid cut;** cut as faceted gems and cabochon. Some cabochons from Mexico show rainbow effect on red brown body color.

**demantoid inclusions;** fine fibers of asbestos (byssolite), silk, rounded stubby, horsetail, are included in demantoid. Sometimes are these are called ponytails.

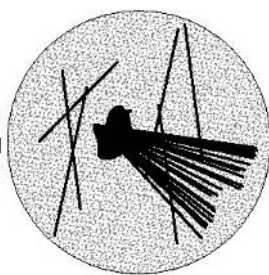
**demantspar;** another term for adamantine spar.

**Demidoff Diamond;** a 19<sup>th</sup> century synonym used for

the Nancy-diamond. Also spelled Demidov diamond.



horsetail inclusions  
in demantoid



ponytails bysolite  
needles in demantoid

**demidovite**; a phosphoriferous, compact, blue variety of chrysocolla from Taglisk, Russia. Usually cut as a gemstone.

**demifin**; a commercial term used in jewelry for half finished gemstone, which is polished above the girdle. Half-finished stone.

**demineralization**; a process for water softening, which uses resins to remove cations.

**demi-parure**; a pendant and matching earrings. A French term for semiprecious. → Parure.

**demion**; a term applied to carnelian variety of chalcedony.

**demorphism**; same as weathering.

**dendrite**; a branch-like, bushy or feather-like pattern of some crystal aggregate of an oxide of manganese that resembles fern moss. The dendrites are frequently secondary chemical precipitates. Found as inclusions in some dendritic minerals such as moss agate, feather agate, moss opal. Tree-like. → Skeleton crystal.

**dendritic**; the term describes a mineral, which has the form of a tree or branch-like habit. Synonym for



skeleton crystal



dendritic crystal

dendritic  
and  
dendritic,  
skeleton  
crystal  
and  
poiktic  
structure

arborescent.

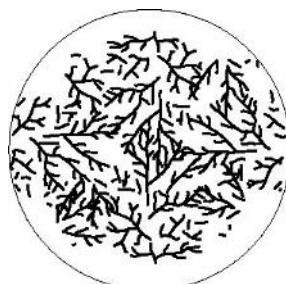
**dendritic agate**; a translucent, gray, bluish, yellow variety of agate or chalcedony containing slender, dark-hued filaments of iron or manganese oxide or both resembling miniature trees or the flat fronds of ferns and certain vegetation. Also called tree agate, moss agate and mocha stone, arborescent agate, branching agate. Found in Yemen.

**dendritic chalcedony**; same as dendritic agate.



dendritic  
agate  
cabochon  
crystal

**dendritic inclusions**; the term describes a mineral, which has the form of a tree or branch-like habit.



dendritic inclusion



dendritic inclusion of liquid

Synonym for arborescent.

**dendritic opal**; a white and common, multi-colored opal, which contains tree-like inclusions of iron or manganese oxide. Found in Zimbabwe (Africa), USA, and South Africa.

**dendrolite**; petrified tree or branch of them. Also called petrified wood.

**dense**; a substance with high density.

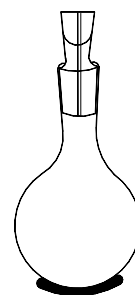
**dense**; compact, fine-grained, lacking pore space.

**dense**; higher index of refraction in optical glasses.

**dense flint glass**; a variety of flint glass containing potassium and lead oxide with lead and potassium replacing a considerable part of the lime and soda. RI:1.54-1.78. SG:3.1-4.2. H:5.

**densiscope**; a specific gravity apparatus manufactured in Vienna for obtaining specific gravity of pearls.

**density**; the weight (mass) of a substance per unit



density  
bottle or  
pycnometer

volume at a stated temperature, measured in kilograms per cubic meter, Kg/m<sup>3</sup> or gm/cm<sup>3</sup>. The comparison of

the weight of a given space of a gemstone with the weight of a similar space of another gem. It should not be confused with the specific gravity. → Specific gravity.

**density bottle;** a small water bottle fitted with a ground glass stopper so marked that it can contain a definite amount of water or liquids. It is used for the determination of specific gravity of small fragments of a gemstone by using heavy liquids. Also called pycnometer, pyknometer, specific gravity bottle.

**density of states;** → electron density.

**density, relative;** same as specific gravity.

**dentalium shell;** a shell variety of dentalium a genus of the tooth shell, were used as beads for necklaces by Egyptian from 10,000 BC to 8,000 BC.

**dentelle (teeth);** a French term meaning lace used for a round rose, in which the row of 18 triangle facets form in multiples of six or two rows between crown or star and lower facets or break facets seen on a rose cut diamond. The third row with 6 facets was their base abutting the base of the star facets. Also known as teeth or dentelle.

**dentelle (teeth);** in the USA a misleading term for glass imitation stone. → Star facets.

**dentelle on cut stone;** → dentelle.

**dentine;** correctly, same as ivory. A substance common to the teeth of all mammals, makes up the teeth, or teeth modifications such as tusks. → Ivory.

**dentine ivory;** same as ivory.

**denudation;** a term meaning breaking down. The end result of various combined processes such as weathering and erosion, which cause a wearing away of the land surface.

**denuded;** rocks exposed by the mean of denudation.

**Denver, Salvador Dali Topaz;** a champagne colored, brilliant cut topaz of 2.12kg, from Brazil. It was owned by Salvador Dali. Now on display at Denver Museum, USA, since 1978.

**De Park;** location of a small alluvial diamond mine in Transvaal Province, South Africa.

**depletion gilding;** a method to create a gold surface made of gold alloy or copper. → Differential pickling.

**De Pohl Diamond;** → Pohl Diamond.

**deposit;** in sedimentology any natural accumulation of useful minerals, or ores, in sufficient extent and degree of concentration to invite exploitation. Such matter accumulated by water, wind, ice, volcanoes, chemical action, etc. → Alluvial.

**deposit;** sometimes means to carry out.

**deposition;** same as sedimentation or depositing.

**depth;** a vertical dimension of a diamond or other cut gemstone from the table to the culet. The determination is recorded in millimeters. → Depth percentage.

**depth percentage;** the depth of a fashioned stone measured from the table to the pavilion end, conducted as percentage of cut stone diameter at the girdle. → Depth.

**De Punt Mine;** location of a marine diamond deposit on the Namaqualand shores.

**Derbyshire black marble;** a misleading term for black marble from Derbyshire, England. It was also called *Poolvash marble*. Found on the Isle of Man. → Encrinital marble, encrinital fossils.

**Derbyshire spar;** a popular name for the massive fluorite from Derbyshire, England. It is frequently banded, and is used for the manufacture of vases. Also called blue john or fluorspar.

**derbystone;** a local term applied to a massive, fibrous or columnar amethyst colored fluorite from Derbyshire, England. It is frequently banded, and is used for the manufacture of vases. Also called blue john, Derbyshire spar.

**Derrea-i-Nur Diamond (Dacca);** in Farsi or Persian it means valley of light. An Indian diamond reputed to be of square cut of 66 cts, belonged to the Nawab of Dacca, Bangladesh. Last offer for sale was in 1959. Present owner unknown. Also spelled Darraya-i-Nur. Has no connection with the true Darya-i-Nûr.

**Desaturated color;** low saturation color.

**Des Belges Diamond;** other alternate term for Queen of Belgium Diamond.

**descriptive gemology;** characterized or classification of gemstones according to their composition, properties, sources and the methods of recovery, fashioning, substitutes and trade grades.

**desert amethyst;** a local misleading term used in western USA for some violet colored glass due to exposure to strong sunlight and rays caused, when glass contains manganese impurities. The color derived from color centers as in natural amethyst, blue topaz, blue diamond, smoky quartz, etc. These stones are naturally irradiated and mostly are stable, fading their color when heated. → Color centers.

**desert amethyst;** a misleading term for solarized glass.

**desert crust;** another synonym for desert varnish.

**desert diamond;** a misleading term for colorless quartz from Kern County, California, USA.

**desert glass;** synonym for obsidian or moldavite.

**desert lacquer;** synonym for desert varnish.

**desert patina;** another synonym for desert varnish.

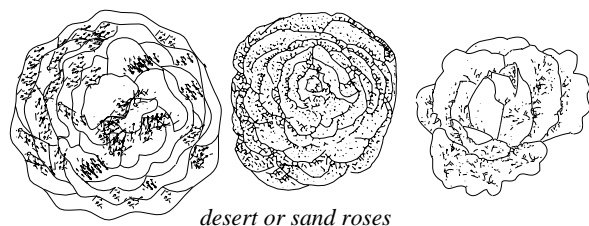
**desert patina;** same as wind polish.

**desert polish;** synonym for desert varnish.

**desert rind;** another synonym for desert varnish.

**desert rose;** a group of concretion of barites or sometimes gypsum and calcite in sandstone, or cluster of platy crystal containing sand, resembling a rose.

Barite acts as cement for sand, formed reddish-brown



or pink rosettes with sandy texture. Also called rock rose.

**desert varnish;** a thin, dark (brown, red, black), hard, smooth, shiny or glazed iridescent film, stain, coating, or polish composed of iron- or manganese oxide and silica, which characterized many exposed rock surfaces in the desert. Caused by scouring action of wind sand and dust. Synonym for desert lacquer, desert rind, desert patina, desert crust, desert polish, varnish, patina.

**design;** to work out the form of a gem, as making artistic or silky a sketch (preliminary drawing), outline, pattern, or plans.

**designer;** a person who works out the form of a gem, making an artistically or silky sketch (preliminary drawing), outline, pattern, or plans. Also occasionally a maker of gem articles.

**designer-maker;** a person who is able to combines the artistic or silky sketch (preliminary drawing) of a designer and of a maker of a gem article designed make for executing by others.

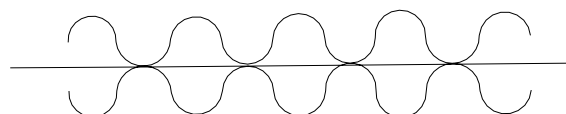
**desmine;** same as stilbite.

**desquamation;** same as spalling.

**dessing;** a local term used in England for jet veins lying to high to work which is also a dangerous occupation.

**Destriau effect;** same as intrinsic electroluminescence.

**destructive cancellation;** when two light beams are out



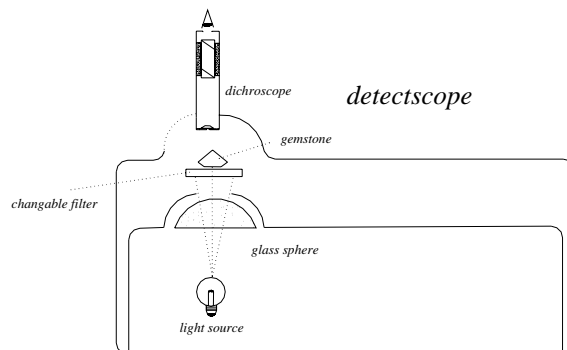
wavelength destructive cancellation

of phase so that the wave-crest of one beam superimposed the other beam and the result is a reduction or cancellation of intensity, as seen in figure below. → Constructive reinforcement, interference of

light.

**detector;** any mechanical sensing device.

**detectoscope;** a commercial term for an instrument



applied to the detection of emerald imitations.

**determinative gemology;** that branch of gemology, which comprises the determination of nature, composition, and classification of gemstones by mean of a physical test. Differentiating between the various gems and their substitutes.

**determinative inclusion;** the determination of nature of inclusions are useful and important to exactly identify an unknown stone.

**determinative mineralogy;** that science of mineralogy, which comprises the determination of nature, composition, and classification of minerals by means of examination of crystallographic, optical properties, physical test, blowpipe analyses, differential thermal analyses, chemical analyses, X-ray diffraction, X-ray fluorescence, etc.

**detrital;** pertaining to or formed from detritus.

**detrital mineral;** any especially heavy mineral grains in sand and other sediments, the granulation, of which results from detrition.

**detrital rock;** any rock that is composed of fragments eroded from pre-existing rocks.

**detritus;** any loose particles or fragments of minerals or rocks, which have been derived directly from pre-existing rock by processes of weathering and/or erosion, such as gravel, sand, and silt.

**deuteron;** a term applied to nucleus of an atom of heavy hydrogen or deuterium.

**deuterium;** a heavy, stable isotope of hydrogen, occurring in natural hydrogen and in heavy water. Having a neutron and a proton in its nucleus, this doubles its atomic weight to 2. Symbol: D. Also called heavy hydrogen.

**deuterolite;** a suggested name for alexandrite-like tourmaline.

**deuteron activation analysis;** a process used in conjunction of neutron activation analysis to test tourmaline because of its chemical composition that is similar to most geological pieces, which have a large



number of elements such as Al, Mn, Mg, Li, Na, Fe and B when this element are greater than 0.1 weight percent.

**Deutsche Diamant;** a misleading term for rock crystal.

**Deutsche Gemmologische Gesellschaft;** Headquarters for this society are located at: 55743 Idar-Oberstein, Professor-Schlossmacher-Str. 1, Germany. Abbreviation: DGemG. Founded in 1932.

**Deutsche Lapis;** a misleading term for artificially blue colored jaspis from Nunkirchen, Germany.

**De Valera;** location of a small alluvial diamond mine in Cape Province, South Africa.

**development of blue color of sapphire;** geuda and Kashmir sapphires are heated by 1600-1900° C in a reducing atmosphere, also pale silky pieces become clear dark blue. → Heat treatment of sapphire and ruby.

**development of silk of sapphire;** development of silk and star effect in sapphire happen by 1300-1900° C for 1 to 14 days and more. → Heat treatment of sapphire and ruby.

**development of yellow color of sapphire;** turning of pale-yellow sapphires to gold or intense yellow happen by 1600-1900° C in an oxidizing atmosphere. Purple stones turned to orange. → Heat treatment of sapphire and ruby.

**deviation method of light;** the difference of angles between the incident ray on an object or optical system and the emergent ray, following reflection, refraction, or diffraction. Also known as angle of deviation.

**devitrification;** converting glassy nature into a crystalline state during the passage of time. Obsidian or pitchstone changes into dull cryptocrystalline rocks, which is usually termed as felsites.

**devitrification of glass;** glass always tends to crystallize losing its characteristic state of clear transparency. Such devitrified glass has been used for ornamentation. → Glass.

**Devonian:** an informal design for Age of Fishes.

**Devonian System:** a rock system on the Earth's surface formed during Devonian period of the Paleozoic era, 395-345 million years ago.

**Devonshire Emerald;** a large natural crystal, uncut, deep-green emerald of 1383.95 cts, found in Muzo, Columbia, South America. It was presented by Dom Pedro I, abdicated emperor of Brazil in 1831 to the sixth Duke of Devonshire lately Emperor of Brazil. Now in the Devonshire Collection in the British Museum. Also called Pedro, Dom,-Emerald.

**Devonshire Opal;** a magnificent, oval and hollow convex shape, black-opal of 100 cts, with flashing coloration from Lightning Ridge, New South Wales, Australia. It was the property of the Duke of Devonshire. Now in the Devonshire Collection in the

British Museum.

**dewelite;** a variety of clinochrysolite consisting of lizardite and clinochrysolite with a talc-like material so called stevensite. Also called gymnite.

**Dewey Diamond;** largest diamond octahedron of 23.75 cts, found in 1884-5 in Virginia, USA. After cutting weighed 11.15 cts. Sold to Samuel W. Dewey. Owned by John Morrissey since 1878. Also called Or-I-Noor Diamond, Sun of Light Diamond, or Morrissey Diamond. Present owner unknown.

**dewylite;** an old term for mixture of stephanite, chrysolite and lizardite. Amorphous, resembling gum Arabic. Brittle and often cracked. Whitish, yellowish, wine-yellow, greenish or reddish. SG:2.0-2.2. H:2.0-3½. Found in Pennsylvania, Massachusetts, Tyrol (Austria), and Passau, Germany. Sometimes used as ornamental stone. Also called gymnite.

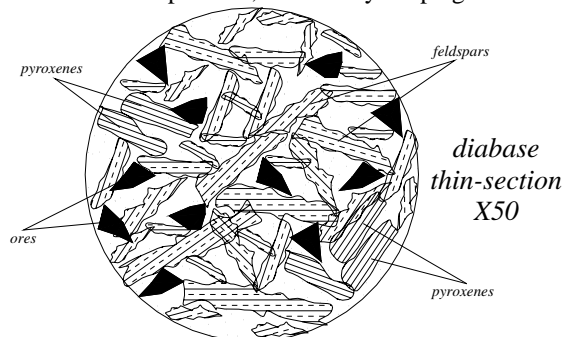
**dew formed theory of pearl;** ancient people believed that pearls are formed from drops of rain or dew.

**DGemG;** a semi-acronym for Deutsche Gemmologische Gesellschaft.

**De Young Diamond;** a fancy pink, pear-shaped brilliant diamond of 2.90 cts, from Tanzania. Sydney De Young, presented the diamond to the Smithsonian Institution in Washington, D.C., USA.

**dhani;** an Indian term for emerald tinged with yellow.

**diabase;** a dark, medium-grained, intrusive igneous rock of basaltic composition, essentially of plagioclase and



augite. Frequently used as decorative or cladding stone.

**dia bud;** a commercial term for synthetic yttrium aluminum garnet (YAG).

**diacetylenes;** → polydiacetylines.

**diad axis;** same as diagonal axis.

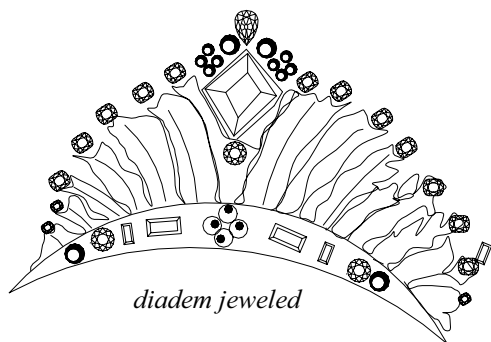
**diadem;** a light jeweled or ornamental headband or royal crown worn by men and women usually made of gold. Sometimes decorated with diamonds, gemstones and pearls. → Tiara.

**diadochos;** an unidentified term may be used for a beryl-like stone. Also called diadocos.

**diadochy;** the replacement of one ion or atom in a crystal lattice by another. → Ionic substitution.

**diadochus;** a superstition that magicians used stones with similar color as beryl as in calling up spirits. Also

known as calls. → *Artemisia dracunculus*.



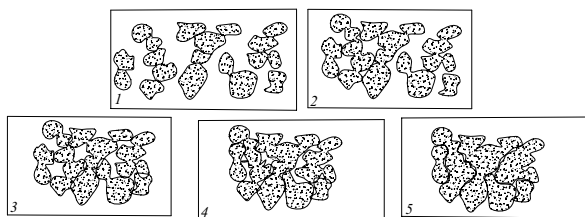
**diadochus**; a term rarely used for stones with similar color as beryl.

**diadocos**; same as diadochos.

**diadogite**; same as rhodochrosite.

**diagem**; a commercial term for synthetical strontium titanate used as a diamond imitation.

**diagenesis**; all processes, which affect sedimentary



*diagenesis formation from loose grains (1) to hardened rock and less porosity (5)*

materials after deposition, excluding erosion and weathering as well as true metamorphism, into which it merges.

**diagnostic mineral**; a characteristic mineral, such as olivine or quartz, whose presence in an igneous rock, indicates whether the rock is basic or acidic.

**diagram**; a chart, which gives information about some variable quantity.

**diakon**; a synthetic, transparent acrylic resin of low density and thermo-plastic methylmethacrylate Perspex. Used as imitation stones for costume jewelry and for the beads of imitation pearls. RI:1.50-1.52. SG:1.18. H:2½.

**DIALAP**; an acronym for Sociedade Portuguesa de Lapidacao de Diamnates.

**Dialdex refractometer**; a Rayner refractometer with a lead glass prism and an exterior ribbon-like scale or cursor that is dialed to the reading that is seen on the scale.

**dial gauge**; a measuring device with jaws of assistance, which estimates the weight of a mounted stone, which is indicated on a dial. Also called dial micrometer. →

Gauge, Leveridge gauge.

**dialite**; a commercial term for an imitation doublet of diamond from synthetic colorless spinel in crown and synthetic strontium titanate (fabulite) in pavilion. Also known as a diamond simulant.

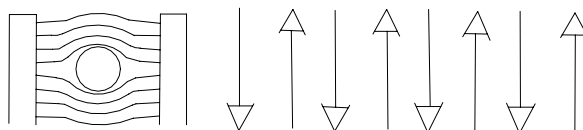
**diallage**; a variety of pyroxene diopside or augite with composition near diopside, but with much alumina. Which has a characteristic lamellar or thin-foliated structure due to a parting along {100}? Also fibrous mineral, grayish to green or dark green, also bronze-brown, sometimes exhibiting schiller. Monoclinic. Optics;  $\alpha$  1.72,  $\beta$  1.74,  $\gamma$  1.75. Birefringence: 0.024.  $\ominus$ . SG:3.20-3.35. H:4. Used as ornamental stone, transparent variety sometimes cut as gem. Found widespread. Smaragdite often is found in this rock.

**dial micrometer**; → micrometer.

**diallogite**; same as dialogite.

**dialogite**; synonym for rhodochrosite. Also spelled diallogite.

**diamagnetic**; having a small, negative magnetic susceptibility so that the relative permeability  $r$ , is less than that of vacuum. Diamagnetic substance is repelled



*diamagnetism effect neutral electron spins*

by a magnet, opposite of magnetization force.

**diamang**; a commercial term for synthetic yttrium aluminum garnet (YAG).

**DIAMANG**; an acronym for Companhia de Diamantes de Angola.

**diamanite**; a commercial term for synthetic yttrium aluminum garnet (YAG).

**diamant brut**; a French term for rough diamond.

**diamant caillou**; a misleading term for colorless quartz crystal.

**Diamant Coeur**; a heart-shaped diamond of 12.33 cts, auctioned at Paris in 1933.

**diamant de première eau**; a French term for diamond of the first water.

**diamant de vitrier**; a French term for glazier's diamond.

**diamant negro**; a Spanish term, meaning carbonado.

**diamant taillé**; a French term meaning cut diamond.

**Diamant und Edelsteinbörse Idar-Oberstein e.V.**; a diamond and precious stone bourse (combined) in twin towns Idar-Oberstein, Germany, member of the World

Federation of Diamond Bourses.

**diamant**; a French term for diamond.

**Diamant**; an illustrated periodical journal for diamond news, published monthly in Antwerp, Belgium.

**diamantaire**; a French term for diamond cutter or seller.

**diamantaire**; an expert in the diamond industry.

**Diamantclub van Antwerpen NV**; a diamond bourse in Antwerpen, Belgium, founded in 1893, member of the World Federation of Diamond Bourses.

**diamante en bruto**; a Spanish term for rough diamond.

**diamante**; a Spanish, Portuguese, and Italian term for diamond.

**diamanté**; a French term used for inexpensive jewels of bright color or colored glass set articles used to decorate fabrics.

**diamanter**; a French term meaning to set with diamonds or to make shine like a diamond.

**diamantfontein**; location of a small alluvial diamond mine Transvaal District, South Africa.

**diamantifere**; a French term meaning diamond-bearing or diamantiferous.

**diamantifero**; meaning diamond-bearing ground or rock.

**diamantiferous**; same as diamond-bearing, or diamond containing material. Any substance containing or bearing diamonds. Also spelled diamondiferous.

**Diamantina**; a town and diamond district of Minas Gerais, Brazil.

**Diamantina**; sometimes used for inferior color grade of diamonds. The term is derived from the town Diamantina.

**diamantine**; a commercial term for an abrasive material of aluminum oxide.

**diamantine**; a trade term for an abrasive crystallized boron powder.

**diamantini**; an Italian term for glass frost. Very fine glass that has been crushed for use as a decorative material.

**diamantista**; a Spanish term for diamond cutter.

**diamantite**; a term applied to polycrystalline diamond.

**Diamant-Klub Wien**; a diamond bourse in Wien, Austria, member of the World Federation of Diamond Bourses.

**diamantoid**; like a diamond, or of the nature of diamond.

**diamantwerker**; a Dutch Term for diamond worker.

**diamatic**; a commercial term of a line of computerized polishing machines from Israel.

**diamdel**; a large sight holding company associated with CSO and De Beers' founded in 1965 in Belgium.

**diamel**; a commercial name for a magnesia spinel brick.

**diameter**; distance of a straight line passing from one side to another side of a girdle of a brilliant through its

center. Also called girdle diameter.

**Diamex microscope**; a commercial name for a student monocular microscope.

**Diaminir Ltd.**; an Israeli industry for computerized polishing machines.

**diamite**; a commercial term for synthetic yttrium aluminate (YAG) used as a diamond imitation.

**diamogem**; a commercial term for white yttrium aluminate (YAG). RI:1.834. H:8.5. Birefringence: 0.028. Used as a diamond imitation.

**diamolin**; a commercial term for yttrium aluminate (YAG) used as a diamond imitation.

**Diamolite**; another spelling of DiamondLite.

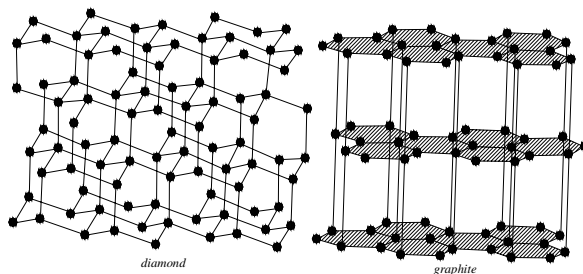
**diamonair**; a commercial term for white yttrium aluminate (YAG). RI:1.834. H:8.5. Birefringence: 0.028. Used as a diamond imitation.

**diamonaite**; a commercial term for yttrium aluminate (YAG) used as a diamond imitation.

**diamonaurea**; a commercial term for synthetic yttrium aluminate (YAG) used as a diamond imitation.

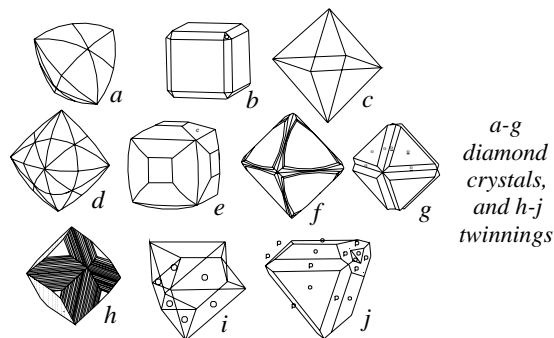
**diamon-brite**; a commercial term for synthetic yttrium aluminate (YAG) used as a diamond imitation.

**diamond**; an isometric mineral, representing a naturally occurring crystalline form of pure carbon polymorphous with graphite, chaoite, and lonsdaleite



*diamond and graphite structures*

and being the hardest substance known. Found in volcanic neck, volcanic pipe, and alluvial deposits. Cut



into various forms and shape, when free from flaws. Sometimes fluorescent under ultraviolet light. There are two distinct types of diamond; Type I, to which the

majority of stones belong, which exhibits complete absorption beyond 300 nm, and Type II, the rare transparent type, which transmits light down to 225 nm. Its high dispersion makes it valuable as a gemstone. Diamond is ready subject to cleavage. Polycrystalline mineral variety and is crushed and used as an abrasive powder in drilling and cutting such as carbonado boart, ballas. Diamond in Sanskrit is known as the Artha-Sastra, which means the Lesson of Profit. → Cutting diamond, brilliant cut, Types I and II, -diamonds.

System: cubic.

Formula: C.

Luster: adamantine to greasy.

Colors: colorless, white to blue-white, gray, various shade of yellow, brown, orange, pink, red, lavender blue, green, black.

Streak: colorless.

Diaphaneity: transparent, translucent, rarely opaque.

Cleavage: {111} perfect parallel to the faces of octahedron.

Fracture: conchoidal. Brittle.

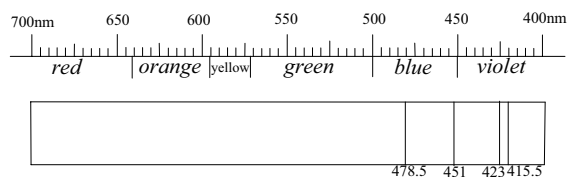
SG: 3.51-3.53.

H: 10. Hardest natural substance.

RI: 2.4175-2.4200.

Dispersion: 0.044.

Found in alluvial and volcanic pipes in South Africa, India, Brazil; South West Africa, Tanzania, Australia, Russia, West Africa, Guyana, Congo, Ghana, Venezuela, China, USA, and Borneo.



*diamond absorption spectrum*

**diamond absorption spectrum;** most diamonds show absorption bands almost nearly at 415.5 nm in the deep violet, this is diagnostic for diamond. In *Cape* stones, this is very intense by 478, 465, 435, and 423 nm in the blue and violet.

**diamond aggregate;** aggregates of diamond are ballas, carbonado, framsite, bort, and stewartite.

**diamond ancillary test;** a test to appoint the diamond, which will be treated.

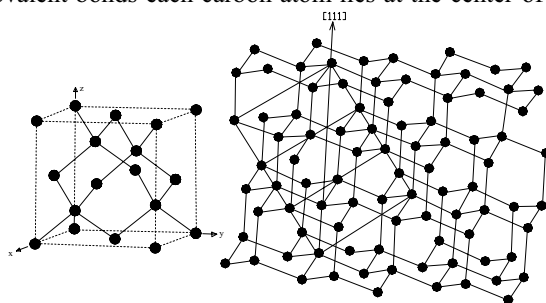
**diamond-angle gauge;** a gauge device, which is used for determining the comparative correctness of the slope of the bezel facets in relation to each other and the table of fashioned diamonds or stones. It can be used for the angles of pavilion facets.

**Diamond Area No. 1;** it means the entire mining area in Namibia.

**diamond artificial coloration;** color change in diamond, either by exposing the stones to the action of radium salts or radium emanation, or bombardment by various subatomic particles of high energy. Alpha-particles (helium nuclei) cause diamond to change to green, *greened* or *radium greened*. Inorganic substances cause color change in diamond but most are temporary. The green diamonds may be turned to a dull red color by heating about 450° C for several hours, or may become yellow color by temperature at 537° C for duration of 30 minutes. This treatment changes the color and removes the radioactivity. Irradiated diamonds under loupe or microscope show an opened *umbrella* or *watermark* around its culet or glow on a zinc-sulfide screen in darkness, which known as *scintillation*. Occasionally an absorption spectrum band at 540 nm shows and can be seen in green radium irradiated diamond. The green cyclotron-treated diamond may be change color to a golden-brown or yellow by heating to about 800° C. The color of pile treated diamonds is like cyclotron-treated diamonds, while by pile uncharged subatomic particles are neutrons in a cyclotron. The radioactivity will be eliminated by heat treatment. → Cyclotron-treated diamond, pile-treated diamond, diamond neutroned, treated diamond.

**diamond artist;** a craftsman who is skilled in coating or painting diamonds. → Coated diamond.

**diamond atomic structure;** diamond has highly covalent bonds each carbon atom lies at the center of a



*diamond structure and unit cell*

tetrahedron, which links with four carbon neighbors at the apices of a regular tetrahedron parallel to {111} which accounts for octahedral cleavage of stone.

**diamond balance;** a sensitive balance used to measure the weight or specific gravity of gemstones and diamonds. Specific gravity obtained by hydrostatic weighing method.

**diamond ballas;** the term ballas, was first applied to such stones from Brazil. An important industrial variety of diamond. The stones are spherical masses of minute diamond crystals arranged more or less radially. They have no well-defined cleavage planes and thus have great resistance to abrasion. Found in Brazil and Africa.

Spherical white or grayish diamonds, which have cleavage planes, are often called *ballas* although they should more correctly be called *bort*.

**diamond-bearing;** same as diamond-containing or diamondiferous.

**diamond-bearing gravels;** all alluvial diamond pebbles contain diamond fragments. The pebbles are mainly of chert, jasper, quartzite, chalcedony, quartz, and banded ironstone.

**diamond belt of synthetic pressure;** a modern device for producing synthetic diamond and in mineral industry. → Synthetic diamond, belt of synthetic diamond pressure.

**diamond birefringence;** all brilliant cut diamonds show some degree of strain birefringence, when examined between crossed Nicol prisms, with bands of shadow alternating with brilliant patches of color.

**diamond blocker;** → diamond cutting.

**diamond bombarded;** diamonds can also be artificially turned green by bombardment by charged particles in a cyclotron. Also called bombarded diamond.

**diamond bourse;** an organization or club members, who deal with diamonds or gemstones. Also called diamond bourse, diamond club, club, diamond exchange.

**diamond bourse;** a building or rooms, which house such a club, or organization.

**diamond boy;** an instrument for testing a cut of a diamond.

**diamond brilliandeer;** → diamond cutting.

**diamond broker;** compare diamond dealer or diamond buyer. A person who buys diamonds directly from marketing agency of diamond syndicate or other source, and sells for a principal on a commission basis.

**diamond broker;** one of the five companies known as Central Selling Organization, or Diamond Trading Company brokers. Also called broker.

**diamond bruting;** → diamond cutting.

**diamond buyer;** a person who buys diamonds directly from producer at or near the site mine or where the diamonds are found. Is not same as diamond broker, who is sometimes miscalled a diamond buyer.

**diamond, canary;** in a true canary-type, yellow-fluorescing brilliant can be observed and a structure of fine lines between 600 and 700 nm.

**diamond cape series;** those diamonds with blue-fluorescing brilliant belonging to the Cape series.

**diamond cape;** diamonds having yellowish tinge due to presence of nitrogen N<sub>3</sub> centers. Also simply called Cape.

**diamond carat estimator;** → appendices.

**diamond cement;** a mortar or glue substance used for setting diamonds or other gemstones, which can obtain as a solution of mastic and isinglass in alcohol.

**Diamond Certificate;** a certificate award from Gemological Institute of America to those who successfully complete the diamond courses.

**diamond chain;** same as diamond pipeline.

**diamond, chemical and physical properties of;** the chemical stability and harness of diamond, the hardest mineral known, with the symbol 10 on Mohs's scale of hardness. The cleavage is parallel to the faces of octahedron and the density of diamond 3.52.

**Diamond City;** same as Kimberley.

**diamond clarity;** → clarity grading

**diamond cleavage;** diamond has a strong tendency to cleavage to perfect octahedral surfaces of the natural crystal, while the cohesion is weaker along (111) planes. → Diamond atomic structure.

**diamond cleaver;** the craftsman who cleaves a diamond into parts by exploiting its cleavage planes. → Diamond cutting.

**Diamond Club of South Africa;** same as South African diamond bourse. A member of the World Federation of Diamond Bourses.

**Diamond Club West Coast Inc.;** a Los Angeles Branch of American diamond bourse. A member of the World Federation of Diamond Bourses.

**diamond club;** same as diamond bourse.

**diamond coating;** → coated diamond, coated crystal (diamond).

**diamond, colored;** same as colored diamond.

**diamond color grading;** the grading of diamonds for color are very different in different countries and carried out by those who have knowledge purely by experience and comparison with of a series of carefully selected *masterstones* under standard lighting condition. In fact diamonds and all gemstones must be done by the eye alone. Four major nomenclatures are in use in various grades, by which the actual grades are identical: CIBJO, GIA, Scan. D.N., and IDC. Diamonds may be graded into: extra collection color (blue-white); collection color; finest white; fine white; browns and greens (varying from brown to light green); top Capes; Capes (stones having a yellowish tinge); and yellow. Also called diamond color-grading system. those stones, which are not encountered in masterstones are known as *fancy colored* diamonds. → Fancy diamond, appendices, color grader GIA.

**diamond color-grading System:** → diamond color grading.

**diamond colorimeter;** similar instrument as diamolite. (DiamondLite) An American instrument for color grading of polished diamonds. Used for the ratio of yellow and blue light transmission to measure the depth of color in cape series diamonds. The electronic part of colorimeter includes a selenium cell that measures the relative transmission of yellow and blue light by a

diamant brilliant. → Fancy diamond, appendices, color grader GIA.

**diamond colors;** the colors for untreated and for natural diamonds are: completely colorless, white bluish, shades of yellow or brown, red, violet, pink, green, blue, and black. The color of diamonds can be artificially altered or enhanced by irradiation or heat treatment. → Diamond color grading.

**diamond concentration;** diamonds can be concentrated by washing and by sink and float using a heavy agent medium such as a mixture of ferrosilicon in water (SG:2.8-3.2).

**diamond condition;** it means whether diamond is treated or untreated.

**Diamond Corporation, Ltd.;** subsidiary of the market-control organization of the diamond industry, which was organized in 1930. It functions as the contractual purchaser from diamond producers outside the Central Selling Organization a part of De Beers group.

**Diamond Corporation (Sierra Leone), Ltd.;** a subsidiary of the Diamond Corporation Ltd., of London. It is a licensed diamond dealer company in Sierra Leone, in Bo and Yengema districts. Abbreviation: DICOSIL.

**Diamond Corporation Côte Divoire, Ltd.;** a subsidiary of the Diamond Corporation Ltd., of London. The company has a license to buy diamonds on the open market at Abidjan, in Ivory Coast, Africa.

**Diamond Corporation West Africa, Ltd.;** a subsidiary of the Diamond Corporation Ltd., of London. It is a licensed diamond dealer company in West Africa exported and managed diamonds from Sierra Leone. Abbreviation: DICORWAF.

**Diamond Council of America;** a not-profit education foundation established in 1944 in Kansas City, Missouri, USA. The Council holds course of Diamontology and certified Diamontologist.

**diamond count;** the number of diamonds inset in the crown of a diamond bit. → diamond content.

**diamond counting (for radiation);** some Type IIb diamonds are semi-conductors and behave as a radiation counter like a Geiger counter and can also be used as counters of gamma-rays. Also called diamond radiation counters. → Diamond electroconducting.

**diamond critical angle;** the critical angle of diamonds is  $24^{\circ} 26'$ .

**diamond crystal form;** most perfect crystals have the form of the octahedron of cubic system frequently tetrahedron or cube form.

**diamond cubic;** with respect to atomic structure to the diamond in having the all face-centered cubic arrangements of atoms. → Diamond.

**diamond cut;** diamonds are cut into various forms and modifications, when free from flaws. → Diamond

cutting.

**diamond cut;** a commercial term means brilliant cut.

**diamond cut;** a term applied to gemstones with brilliant cut other than diamond.

**diamond cutter;** a general term for any craftsman employed in the sawing, bruting, shaping or polishing of diamonds as gems.

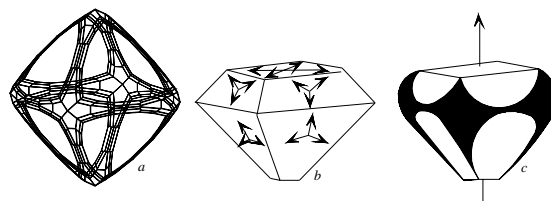
**diamond cutter;** a tool in which a single diamond, shaped as a cutting point, is inserted.

**diamond cutter;** any workman who rounds up rough as a step in the fashioning of brilliant. Diamond cutter is distinguished from a gem cutter or lapidary.



*diamond cutter ca. 1800*

**diamond cutting;** usually for cutting a diamond six processes must be done to fashion a rough diamond crystal to a finished gem: marking, grooving, cleaving, sawing, grinding and faceting. All these steps are not necessary to do in every stone because they depend on shape, size and quality of rough crystal. Diamond cutting is a highly specialized form of lapidary work which provides maximum brilliance. Diamond cutting is one of the six steps, by which diamonds are prepared for use as ornaments or in the arts by *marking* by a *planner*, who examined a rough stone how it should be cut to have the best value, size, shape and direction of the cleavage *grain*. The other being diamond cleaving (to a *cleaver*) or sawing; to remove flaws and slicing



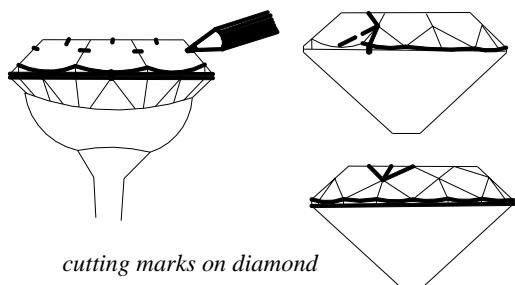
*brilliant-cut diamond from a octahedron crystal. a: crystal, b: four and three point on diamond and c: first facets on the stone*

into desired size, *bruting*; to give desired fundamental shape, grinding and rounding; to make facets on a revolving horizontal lap or *scaife* made of cast iron. Finally a standard round brilliant stone goes to first polisher, known as *blocker* or *lapper* who cuts table

facet, 8 main facets above girdle, 8 facets below girdle, culet and then goes to *brilliandeer* (or brillianteer) or *finisher* who puts 40 remaining facets on the stone. The process of diamond cutting is not always divided as mentioned above. Diamond cutting other than standard round brilliant often finished by a single craftsman. Also called diamond cutting and polishing. The major diamond cutting companies are located in Amsterdam and Antwerpen (Belgium), New York (USA), Tel Aviv (Israel), India, Thailand, Hong Kong (China), Smolensk (Russia). → Brilliant cut.

**diamond cutting;** diamond cutting is a highly specialized form of lapidary work which provides maximum brilliance. Diamond cutting is one of the three processes, by which diamonds are prepared for use as ornaments or in the arts, the other being diamond cleaving or sawing; to remove flaws and slicing into desired size, bruting; to give desired fundamental shape, grinding; to make facets. Finally cleaning or polishing. Also called diamond cutting and polishing. The major diamond cutting companies are located in Amsterdam and Antwerpen (Belgium), New York (USA), Tel Aviv (Israel), India, Thailand, Hong Kong (China), Smolensk (Russia).

**diamond cutting marking;** the identification of the cleaving and sawing instructions on a rough diamond with



cutting marks on diamond

Indian ink to show how it is to be sawed.

**diamond, cyclotroned;** → cyclotron-treated diamond

**diamond dealer;** same as diamond broker.

**Diamond Dealers' Club, Inc.;** a nonprofit trading association in New York City included diamond importers, wholesalers, and cutters. Abbreviation: DDC. Founded in 1931.

**Diamond Development Co. of Ghana;** a corporation in Accra, Ghana that is licensed to buy diamonds from local miners. Founded in 1950.

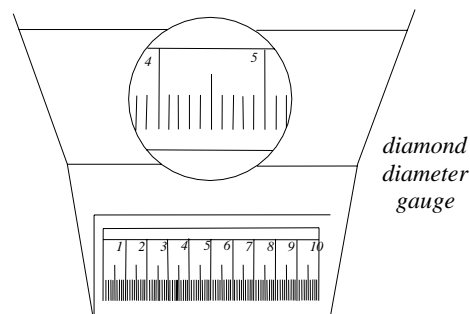
**diamond diadem;** a light jeweled headband or royal crown set with diamonds.

**diamond diameter;** → diamond table diameter.

**diamond diameter gauge;** a device for measuring of distance of a straight line passing from one side to another side of a table or girdle of a brilliant through its center. Also called girdle diameter. → Diamond table

### diamond cutting- diamond electroconductivity

diameter.

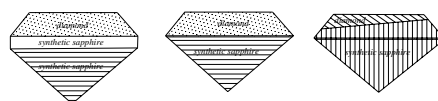


**diamond dies;** industrial diamond used for drawing wire of a constant diameter.

**diamond differential fluorescence;** some diamonds under long-wave ultraviolet light of 365 nm show blue, green, yellow or sometimes reddish glow, which is used as an identifying method of stones setting together in jewelry pieces.

**diamond dispersion;** diamond is famed for its *fire* or its dispersion of 0.044 for the B-G interval of Fraunhofer lines is in fact low for a stone of such high refractive index. Fire, scientifically known as dispersion. → Dispersion of diamond

**diamond doublets;** diamond doublets consisting of a



diamond doublets

crown of diamond cemented to a pavilion of diamond, or another colored or not-colored material such as white synthetic sapphire, quartz, or even glass.

**Diamond Dredging & Mining Co.;** location of a minor diamond mining company in Luderitz district, South-West Africa.

**diamond dressing tool;** same as dresser.

**diamond drill head;** diamond-crowned bit. → Drill diamonds, drill head diamond.

**diamond dust;** same as diamond powder. A diamond powder produced in the cutting of gems of sizes of 20 microns. (1 micron=1/1000 or 0.001 of an mm). → Dust, diamond.

**diamonded;** diamondized or embellished with diamonds.

**diamond electroconductivity;** normally the diamond is an isolator but by the use of fast moving electrons from an accelerator, the natural blue diamonds Type IIb are electroconducting caused by structure imperfection. → Diamond counting (for radiation).

**diamond electrostatic separation;** → electrostatic separation of diamond.

**diamond, emplacement of;** → emplacement of diamond.

**Diamond Exchange of Singapore;** a diamond bourse founded in 1976 in Singapore. A member of the World Federation of Diamond Bourses.

**diamond exchange;** same as diamond bourse.

**diamond faceting and polishing;** same as polishing diamond.

**Diamond Eye;** a commercial term for a reflectivity meter device.

**diamond file;** a file (hones) is a strip of copper, into which diamond powder has been hammered. It is impregnated in resin, metal or vitrified bonds.

**diamond fingerprint;** producing of X-ray scanning photograph, which reveals the internal flaws or structure defects of gemstones or diamonds used to distinguish it from its imitations, while stones other than diamond are much more opaque to X-ray. It is used for fingerprinting of gemstones but not commercially. → Diamond transparency to X-rays.

**diamond finisher;** → diamond cutting.

**diamond fire;** → diamond dispersion.

**diamond first water;** a term applied to flawless and limpid diamonds. → First water.

**diamond flat;** flats are a distorted and thinner octahedral of diamond by classification of diamond. → Diamond gem classification, diamond sorting.

**diamond, flawless;** diamond, which is free from both external and internal flaws.

**diamond, flaws in;** the quality of gem diamonds depends also on the flaws in diamonds, which may be so obvious as to severely mar the beauty of the stone. → Clarity, clarity grading.

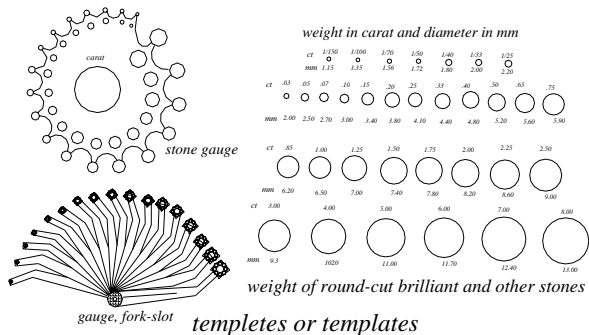
**diamond fluorescence;** under the long-wave ultraviolet rays, the majority of gem diamonds show a sky-blue to violet fluorescence. Also, this effect is used to distinguish ruby from spinel. Fluorescence effect in diamond can be produce by X-rays, cathode rays.

**diamond fluorescence spectrum;** → diamond fluorescence.

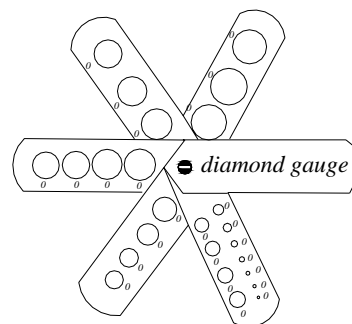
**diamond, formation of;** → diamond occurrence, diamond,-genesis of, formation of diamond.

**diamond gauge;** an instrument for estimating the weight of a diamond already set in an article. There are several types of such device. (a) A *stencil gauge* or *aperture gauge*, consisting of a thin sheet of metal or celluloid (the metal types often being in the form of folding leaves), in which a series of differently sized circular or cushion-shaped apertures, each of these holes has a diameter agreeing with the diameter of a correctly fashioned diamond of given weight. The gauge is placed over the stone to be estimated and the aperture,

which just fits over the girdle of the stone and gives the approximate weight of diamond, each hole being marked with its value in cts, or decimals of a ct. (b) A pair of spring *caliper gauge* with the moving arm fitted with a pointer, which moves over a scale of numbers. This caliper measures the width of the girdle and the



depth of the diamond. The readings obtained are looked up in an available table supplied with the instrument and the approximate value read from them. It is considerably more accurate than the stencil gauge. (c) The comparison gauges consisted of a series of



swiveling arms at the end of each is mounted with a synthetic spinel of known characteristic size. → Also Moe's diamond gauge, carat, diamond carat estimator.

**diamond gem classification;** diamonds are classified into groups: close goods (*stones*), spotted goods, cleavages, flat, macles, rubbish, and bort. → Diamond sorting.

**diamond, genesis of;** all diamonds, except the pipes mines, are alluvial deposits. There are many theories to account for the formation of a diamond, most common being that it occurs under intense heat and pressure. → Formation of diamond.

**diamond genesis;** → diamond occurrence.

**diamond glass filled;** → filled diamond.

**diamond glassy;** diamond crystals from Sierra Leone with excellent octahedral form with bright faces are called *galsies*.

**diamond grade;** the worth of a diamond is based on an individual sorter's interpretation, which is somewhat



arbitrary, standards of weight, proportion, finish, clarity, color, presence of flaws, and soundness. Also called diamond quality.

**diamond grader;** a small binocular microscope manufactured by the Gemological Institute of America employing the same type of dark-field illuminator as a gemolite and diamondscope known as the diamond grader. Accessories for proportion and color grading extend its use.

**diamond grading lamp;** → DiamondLite.

**Diamond Grading Report;** report written by institutions, and laboratories. This report includes weight, proportion, finish, clarity, color, presence of flaws, and soundness. Also called Quality Analysis Report.

**diamond grading system:** describing the relative quality of fashioned diamonds clarity, color, and cut. → Diamond color grading.

**diamond grading;** the grading of polished diamond by color, clarity, cut, and weight.

**diamond grain;** a cleavage direction of diamond parallel to the four octahedral faces. In diamond cutting industry, when the term is used, it refers to a polishing direction.

**diamond grain;** a metric carat weight, often divided into 4 diamond grains.

**diamond, grease affinity of;** → petroleum jelly, vaseline, grease table.

**diamond grit;** same as diamond powder.

**diamond hardness;** the hardness of diamond is generally designated as 10.

**diamond, hardness in, variation of;** hardness variation of diamond mineral is not very great, is of high practical importance.

**diamond hardness tester;** polished and shaped diamonds are used in many parts of industries as a modern indenter hardness tester.

**diamond hardness variation;** the true hardness of diamond is nearly unique and of practical importance because some directions are softer to abrade diamond for example directions parallel to the crystal axes are less hard such as on cube face are 2 suitable polishing direction, on octahedral all 3 directions are nearly equal, and on rhombic dodecahedron one direction.

**Diamond High Council, Belgium;** → Hoge Raad voor Diamnat vzw.

**diamond hone;** a mechanical tool containing a minute holder, the front part of the holder may contain diamond powder impregnated in metal, resin or vitrified bonds. Used for repolishing the slightly blunted cut edges.

**diamond identification tests;** → breath test, dot-ring test, fingerprinting, light spill test, reflectivity meter, thermal conductivity diamond tester, water contact

angle, and X-ray diamond tester.

**diamondiferous;** same as diamond-bearing, or diamond containing material. Any substance containing or bearing diamonds. → Diamond-bearing gravels.

**diamondiferous formation;** → yellow ground.

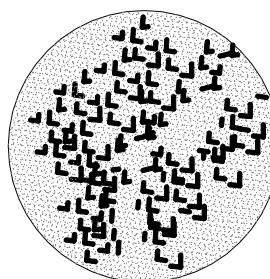
**diamond imitation;** → imitation diamond.

**Diamond Imperfection Detector;** a trademark instrument from Gemological Institute of America, it is similar to Gemolite and Diamondscope employs a monocular.

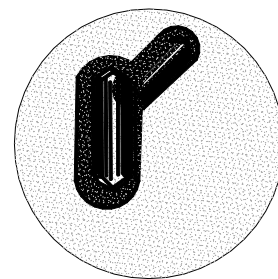
**diamond impregnated;** diamonds are distributed throughout a matrix.

**diamond-impregnated bit;** a synonym for impregnated bit.

**diamond inclusions;** diamond inclusions of special interest here are *syngenetic*; carbon, carbon spot, garnet, diopside, olivine, enstatite, chrome-spinel,



*nitrogen scales in diamond  
Type IA. ca. 90000 x*



*olivine crystals in  
diamond. ca. 2000x*

rutile, nitrogen, magnetite, boron, colorless octahedron of diamond itself.

**diamond, Indian classification of;** a ceremonial classification of charming diamond according to Hindu caste. (a) The finest quality being the Brahmin diamond, which may give power, friends, riches and good luck. (b) Flowed by the Kshatriya diamond, this prevented the approach of old age. (c) The Vaisya diamond or merchant caste stone, which may bring success, and (d) the Sudra diamond or worker's caste, which may bring all manner of good fortune.

**diamond, industrial use of;** diamonds unsuitable for gemstone production, which are used in modern industrial and engineering practice, the earliest use of diamond in industry was as an abrasive powder, rock drilling, glass-cutters, wire drawing dies, hardness testers, indenter hardness testers, radiation counter, glaziers, turning tools for grinding wheels, turning tools.

**diamond, irradiated cut;** irradiated diamonds have no residual radioactivity, however gemological methods exist to distinguish natural fancies from irradiated diamond.

**diamond, irradiation charges;** → irradiation of diamonds.

**diamondite;** a commercial term for white synthetic sapphire or colorless synthetic corundum used as a diamond imitation.

**diamondize;** diamondized or embellished with diamonds, also, to change into diamond.

**Diamond Jubilee;** → Jubilee Diamond.

**diamond lapper;** → diamond cutting.

**diamond, laser drilled;** → laser drilling.

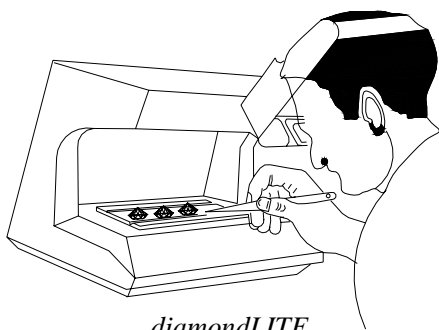
**diamond lamp;** any model of light designed specifically for diamonds determination or display purpose and sales.

**diamond lap;** same as scaife.

**diamond laxey;** a term applied to rather shallow brilliant. Also called laxey diamond.

**diamond-like carbon;** a material used as a coating for gemstones. Abbreviation: DLC.

**DiamondLite;** a commercial term for an American instrument with a series of calibrated diamonds made

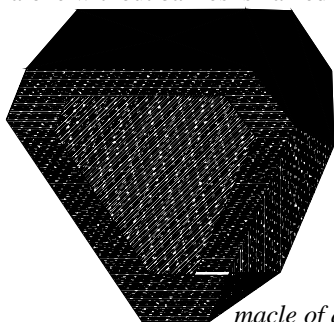


*diamondLITE*

by Gemological Institute of America, used for color grading of diamonds by visual comparison with master diamonds. The instrument simulates north daylight needed for accurate color viewing of diamonds and colored stones, also incorporates a long wave ultraviolet tube for detecting fluorescence in gemstones and diamonds. Also called Diamolite.

**diamond luster;** same as adamantine luster.

**diamondlux;** a commercial term for an instrument of Gemological Institute of America for a special overhead light, which produce a daylight-equivalent illumination to show objects in their true colors. The fixture alone without baffles is named as the Verilux.



*macle of diamond*

**diamond macles;** sorting grade of triangular-shaped diamond in accordance to the twinned crystals. Generally macles are disliked by the diamond polisher owing to the twin-plane, or naat.

**diamond, make;** same as make.

**diamond manufacturer;** a term applied to the owner or somehow of a concern, which fashioned polished diamonds from rough material.

**diamond manufacturer;** sometimes it means the concern itself.

**diamond marine deposit;** same as marine deposit.

**diamond, marine deposits of;** diamonds from the Atlantic coast of South-West Africa.

**diamond, marketing of;** about 85% of the world's production of diamonds is marketed by the De Beers syndicate, which regulates the process from mining to cutting.

**diamond marking;** → diamond cutting.

**diamond matrix;** a term applied to the rock, in which diamonds are formed naturally and occur, such as in kimberlite.

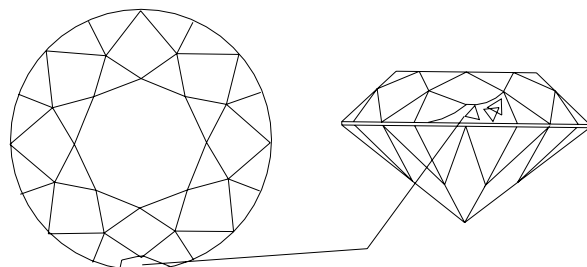
**diamond mêlée;** mêlée is a term used primarily to describe small scale diamonds, which are crystals under one carat.

**diamond mining;** the mining of diamonds happens in various types open-cast working or underground mining, such as placer deposits or pipes of kimberlite (igneous origin).

**diamond mortar;** a small, hand-operated special steel mortar used for grinding diamond for small scale uses. An automatic mechanical mortars used for large applications.

**diamond, naats in;** same as *knots*. A crystal twin occurs locally within the crystal producing *hard spots*, which are called *naats*.

**diamond, naturals on cut;** small extra portions of the original crystal surface, remaining on the unfinished



*natural crystal faces on cut diamond, mostly occur beneath the girdle*

edge or the girdle are called naturals.

**diamond needle;** a small, metal hollow tube attached to a flexible rubber tube through which air is pulled by a suction pump. This metal tube enables small diamonds to be picked up and place in the bit mold, which gives

greater facility than tweezers. It is called a diamond needle because the metal tube is usually made using a discarded hypodermic needle. Also called diamond pickup, diamond tube, diamond pipe.

**diamond neutroned;** diamonds can also be artificially turned green, brown, and yellow by pile-treatment, in which the neutrons are uncharged particles in a cyclotron. The brown and yellow stones are obtained after heat treatment by heating about 800° C. → Cyclotroned diamonds, diamond radium treated and diamond,-pile treatment.

**Diamond News and S.A. Jeweller, the;** a monthly commercial journal for international diamond news, which gives comprehensive coverage of all phases of the diamond industry. Published monthly in Kimberly, South Africa.

**diamond, nitrogen in;** diamonds of Type I contained free nitrogen as a constant impurity were shown to account for many of the absorption bands in the infrared and ultraviolet light. Diamond Type I has been divided into two sections: Type Ia, in which the nitrogen has platelets, and Ib the nitrogen is dispersed in substitutional site in a paramagnetic form. There is no nitrogen (?) in Type II. → Diamond Types I and II, diamond inclusions.

**diamond occurrence;** the diamond crystallized directly from rock melts rich in magnesium at depth of 150 km or more in the earth. The melt are essentially saturated in carbon dioxide gas at extreme high pressure and temperature nearly 1400° C. Thus, rocks, which contain natural diamonds are of the deep mantle of the Earth and everywhere of similar composition. Diamonds are formed in two different rock types; peridotite or eclogite (P-type or E-type). Also calling formation of diamond, diamond genesis.

**Diamond of Nepal;** a colored diamond from Golconda, India of 79.41 cts.

**diamond, origin of;** same as diamond, genesis of. → Diamond, formation of, diamond occurrence.

**diamond, optical properties of;** the optical properties of diamonds are: (a) adamantine luster depends on high polish and quality of light, (b) the ability of a well-cut diamond to totally return back a ray of light, which enters from the crown, and (c) the optical effect *fire* exhibited by the stone due to breaking up of white light into rainbow spectrum color. Fire is known as *dispersion*. Fire or dispersion caused by differing refracting indexes of each different color rays, which all together form the white light, for example the red color has a wavelength of 687 nm and a refractive index of 2.407 in diamond, and violet ray has a wavelength of 397 nm and a refractive index of 2.465, correspondent to B line for red ray and G line for violet ray of Fraunhofer's solar spectrum diamond has a (d)

dispersion of 0.044.

**diamond, origin of;** → diamond occurrence.

**diamond painted;** sometimes stones are improved when the back facets of a very light yellowish diamonds are painted. A thin layer of blue or violet color placed on the back facets of the stone to make the stone appear whiter.

**diamond paper;** one or more small sheets of specially folded paper, which is a container for diamonds to avoid damaging each other. Also called parcel paper or diamond parcel paper.

**diamond parcel paper;** the specially folded paper packets, in which a diamond or diamonds are held for carrying, or for transporting in a parcel. Also called diamond papers.

**diamond paste;** grinding and polishing paste made of diamond powder and other suitable material. It consists of a wetting and dispersing agent.

**diamond paste;** a variety of lead glass or other glasses (paste), which is ground fused, cooled, and polished. Used as an imitation for diamond and other gemstones.

**diamond pen;** a commercial term for a diamond tester made by GIA, which is provided with a special liquid, which leaves a coherent spot on the table of the diamond, when drawn across it can also be used to make droplets on the crown or surface other gemstones.

**diamond pencil;** generally, a cutting tool tipped with a diamond, also used for inscribing or marking glass, metal, or other material.

**diamonds per carat;** a term employed to the number of relatively equal size diamonds having a total weight of 1 cts.

**diamond per carat;** the number of broken diamond crystals having a weight of one carat, sometimes of suitable thickness.

**diamond per carat;** diamond stones per carat.

**diamond phosphorescence;** many diamonds show strong blue glow and yellow afterglow (phosphorescence) after exposure to ultraviolet light or sunlight. Afterglow can be seen, when a diamond is exposure to strong sunlight.

**diamond photometer;** photometers can be used only for colorless to yellow diamonds in the cape series, the strengths absorption line be seen by 415.5 nm.

**diamond physical properties;** → diamond.

**diamond pickup needle;** same as diamond needle.

**diamond, pile treatment;** gem quality diamonds can also have their color artificially altered. The color is similar to with the pile-treated like cyclotron, in which the neutrons are uncharged particles, but here the coloration happen throughout the stone. → Cyclotroned diamonds, diamond neutroned, diamond radium treated.

**diamond, piggy-back;** → piggy-back diamond.

**diamond, point stones;** same as table cut. The first advance form of diamond cutting, being merely the polishing of the diamond octahedron faces of the crystal.

**diamond pipe;** same as diamond needle.

**diamond pipes;** a large volcanic *pipe*, in which the kimberlite rock occurs and is sufficiently diamondiferous to be mined. The size and shape of these pipes are cylindrical, columnar, tabular, or irregular in shape, more or less vertical. known as pipe.

**diamond pipeline;** the various steps through, which a diamond passes from production to marketing not including the end consumer. Also called diamond chain, pipeline.

**diamond planner;** → diamond cutting.

**diamond plow;** a glass engraving tool, which is diamond-pointed.

**diamond points;** an old style of swan diamond where the faces are pointed, such as *four-point*, *three-point*, or *two-point*. → Diamond, piggy-back, four-point, three-point, two-point.

**diamond points;** an old cut style where the faces of octahedral crystal were polished, therefore the brilliant-cut diamond has been developed from point-cut diamond. → Diamond, piggy-back, four-point, three-point, two-point.

**diamond-point ring;** a finger ring with high bezel mounted with a diamond cut as a diamond point, an octahedron form with 8 faces of triangles. → Diamond point.

**diamond polish;** last high polish of stone combined with its hardness and superb flatness and prepared by the skilled gem cutter, gives rise to the peculiar adamantine luster.

**diamond polishers;** in the diamond industry a craftsman who places the facets on the diamonds or other hard



*diamond polisher ca. 1800*

gemstones and polishes them.

**diamond polishing;** → diamond cutting.

**diamond powder;** finely fragmented and powdered synthetic or natural diamond such as boart and remainders achieved by various mechanical methods and then segregated into micron size groups. Used as

cutting, grinding, polishing, sawing, and abrasive medium of diamond and other hard stones. Also called dust diamond, or diamond grit.

**diamond premier;** the premier diamond always fluoresces very strongly by shorter wavelength radiation, usually in a light-blue color.

**diamond probe;** same as thermal conductivity diamond tester.

**diamond profilometer;** an optical profilometer is used to check and measure the depth and angles of cut stones.

**diamond proportion analyzer;** an eyepiece manufactured by GIA of a lens or combination of lenses as accessory for zoom-type microscope (Gemolite microscope), nearest the eye of the observer. It is used for analyzing the proportions of round, brilliant-cut diamonds, also for measuring of new recut stones. Also called ocular. → Proportionscope.

**diamond proportion grading;** a device for checking and determining the angles and depth of diamond and other cut stones by means of a spotlight. → Diamond proportionscope.

**diamond, proportion of brilliant cut;** a well proportioned diamond should have the ability to reflect all the light entering from the crown, and exactly reckoned angles and diameter of the stone. → Brilliant cut (round).

**diamond proportionscope;** an optical instrument used for gathering detailed, exact information on proportions and angles of a brilliant-cut diamond. The diamond shadow is projected on an illuminated screen where its proportions can be compared to ideal measurements shown on the screen background. → Proportionscope.

**diamond proportions;** → diamond, proportion of brilliant cut.

**diamond purity;** → clarity, clarity grading.

**diamond purity grading;** same as clarity, clarity grading.

**diamond-pyramid hardness test;** a diamond-pyramid indenter used as one hardness scale for all ranges of hardness, such as Vickers hardness test.

**diamond, qualities of cut;** there are many factors for an excellent quality of diamond such as color, clarity, and cut or *make*. A well cut or proportioned diamond should have, in order to reflection all the light entering from a crown, and exactly reckoned angles and diameter of the stone.

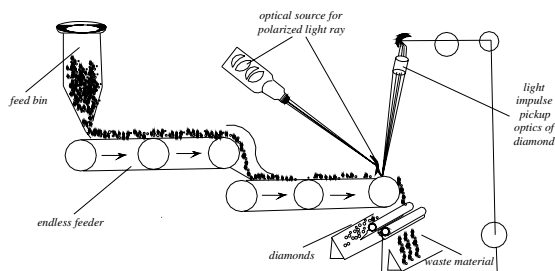
**diamond quality;** same as diamond grade.

**diamond qualities of cut;** there are some factors for a noble quality of diamond such as color, clarity, and cut or make. A well cut or proportioned diamond should have the ability to reflect all the light entering from the crown, and exactly reckoned angles and diameter

**diamond radiation counters;** → diamond counting (for radiation).

**diamond radium treated;** → radium-treated diamond.

**diamond recovery by optical separating;** an optical device used generally for separating of diamond



*optical separating and recovery device for diamond*

obtained in the treatment after production.

**diamond recovery by X-ray fluorescence;** diamond-bearing gravel or crushed rocks, which are passed down a hopper where they pass through an X-ray beam. The beam makes the diamonds glitter so that they are seen and depends upon the fluorescence of diamond, when in an X-ray beam. → X-ray separation.

**diamond reflectance;** → reflectivity.

**diamond refraction;** diamond is famous for its high single refraction, the measurement of this is 2.417 for yellow light.

**diamond refractometer;** same as normal refractometer with a small prism of diamond used instead of glass material in refractometer, this extends the range of the refractometer to 2.42.

**diamond Regie;** a former German marketing company was formed in 1909 in Berlin.

**diamond, replicas of famous cut;** fairly accurate replicas of famous diamonds are made from various manufactures by glass or quartz either as individual pieces, partial sets or complete sets. The colored diamond made by glass, citrine or synthetic spinel.

**Diamond Research Laboratory;** a scientific research laboratory for diamonds founded in 1947 in Johannesburg, South Africa. (a) They assist and investigate the mining companies with problems concerning extraction processes and increasing the production and reduced the cost, which leads to profit making. (b) Research service for all users of industrial and gem diamonds. Abbreviation: DRL.

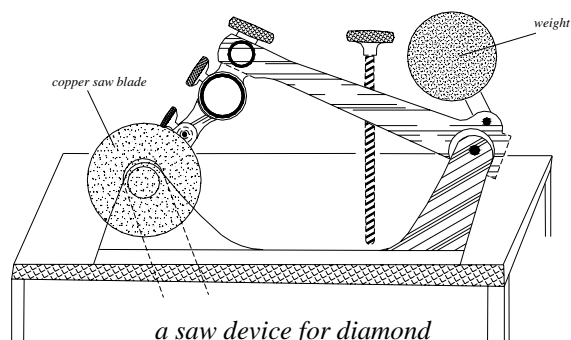
**diamond rush;** → gold rush.

**diamond salvage;** small fragments and powder of diamond are dropped down during cutting and polishing, these pieces accumulate in the scarf and sludge, which can also be recovered. Material from wheel dressers, diamond-drill bits, diamond-pointed tools, and broken or discarded diamond wire, drawing dies and grinding wheels can also be recovered.

**diamond sand;** a sorting degree of diamonds, which includes stones, which may total as many as 120 to the

cts.

**diamond saw;** a circular metal blade or disk having diamond or diamond dust charged in its cutting or peripheral edge. Used as a cutting aid in fashioning



*a saw device for diamond*

colored stones or in various applications industry.

**diamond saw;** also employed to cut and saw for dividing, or separating, rough diamond, rocks and other brittle substances.

**diamond sawyer;** in the diamond industry one who uses a saw, in which diamonds are inserted in the teeth.

**diamond scale;** an instrument, on which diamonds are weighed with weight units in cts.

**diamond scaife;** → diamond cutting.

**diamond, scientific uses of;** such as diamond radiation counters. → diamond counting (for radiation).

**diamond scoop;** → diamond shovel.

**diamondscope;** a commercial term for an instrument made by Gemological Institute of America consisting of a binocular microscope mounted on a specially designed dark-field illuminator base used for identification of imperfections and internal features and grading of diamonds and other gemstones in either direct or indirect light. → Gemolite.

**diamond set;** the diamond-set glass cutters, which are called vitriers and contain inset diamond.

**diamond-set bit;** contains inset diamonds.

**diamond setter;** in the diamond industry a person who is qualified to mount a fashioned diamond into item of jewels.

**diamond setter;** a person who is trained to fix diamonds in a dop for sawing or polishing.

**diamond setter;** a person who sets diamonds in a mold to produce a so-called mechanical bit.

**diamond, shapes;** → diamond sorting.

**diamond shaped;** a four equal-sided or lozenge form, making two equal and opposite acute and obtuse angles. → Lozenge.

**diamond shoe;** a special diamond-set washover shoe.

**diamond shovel;** a small, stainless shovel, which is used with dexterity for handling a large quantity of minute diamonds. Also called diamond scoop.

**diamond sieve;** generally a rounded, plate utensil with network or perforated stainless metal for grading of fashioned or loose diamonds for size. Each mesh-size of sieves is available. Used to separate round brilliant diamond according to size.

**diamond sights;** once a month carried out by the Diamond Trading Company a subsidiary of Central Selling Organization in London holding sights to sell rough diamonds. The sights are made up into parcels of sizes, shapes, colors, etc.

**diamond simulants;** stones or another materials, which are not natural or synthetic diamonds, which simulate diamonds, under normal conditions of lighting, such as zircon, white sapphire, quartz, topaz, garnet, YAG, GGG, synthetic materials, and composite stones. Also called diamond substitute

**Diamonds of Russia and Sakha;** same as Almazy Rossii-Sakha.

**diamond sorter;** → diamond sorting.

**diamond sorting;** the first sorting may happen in two groups: cuttable and industrials. Than the sorting of gem, diamonds depends upon four factors: size (cts, weight), color, shape, and quality or purity. Diamonds of acceptable color and good weight and octahedral shape are termed *stones*, to which *shapes* may be added. *Macles and flats* are the next grade or category. Smaller stones less than one carat are known as *mêlée*. Very small stones are named as *sand*. *Coated crystal diamonds* are coated with a dark-colored, thin, translucent to opaque layer of diamondiferous material. *Cleavages* are irrespective, irregular broken fragment of diamonds. The sorting of rough or polished diamonds happens per hand, or computer controlled. → *Mêlée*, sand, Macles, flats, shapes class of rough diamonds.

**diamond spar;** another term for adamantine spar, corundum or corindon.

**diamond specific gravity;** specific gravity of gem diamond is usually given as 3.52 (3.51-3.53).

**diamond, stones;** → diamond sorting.

**diamond strain birefringence;** some diamonds show an inclusion of minute crystals of diamond or other mineral anomalous with double refraction. This effect can be observed between crossed filters of a polariscope, which a typical display of light and shadow are visible as the sample turned. → Strain, anomalous double refraction.

**diamond structure;** the homopolar bond of diamond may give still greater hardness, such as hardest substance designated as 10. Optical properties, also are closely related to the structure.

**diamond substitutes;** the properties and its possible substitutes are great either natural stones or artificial material such as zircon, quartz, YAG, GGG, strontium

titanate, scheelite, sphalerite, synthetic rutile, lithium niobate, demantoid, sapphire, synthetic spinel, and some paste. Same as diamond simulant.

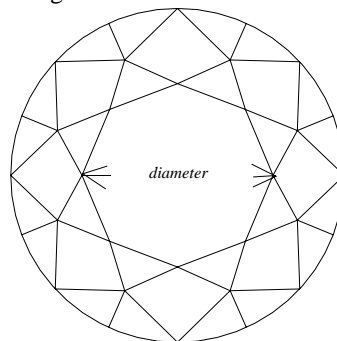
**Diamond Syndicate;** various groups of individuals forming companies that together formed an organization with controlling interest in diamond production and distribution. In 1893, it was composed of 10 firms, which offered to purchase all diamonds owned by De Beers Company. This was the embryo of the famous Diamond Syndicate that becomes so well known to jewelers in the early decades of the 20<sup>th</sup> Century. In 1929, a crisis occurred and a more rigid type of marketing organization with greater capital was required. Today the term syndicate is often associated with the De Beers Consolidated mines, Ltd. because it holds a controlling interest in a number of diamonds-mining companies and buying companies. → De Beers Consolidated mines, Ltd.

**diamond, synthetic;** → synthetic diamond, diamond-, synthesis of.

**diamond, synthesis of;** a reproduction of a natural diamond that has approximately the same physical, chemical and optical properties as the genuine mineral, synthesis of diamond by manufacture has caused great experimental difficulties. A synthetic reproduction of diamond made by very high pressure and temperature. → Synthetic diamond.

**diamond system;** same as diamond drill or diamond drilling.

**diamond table diameter;** distance of a straight line passing from one side to another side of a table of a



*table diameter of a brilliant-cut*

brilliant through its center. Also called girdle diameter. → Diamond diameter gauge.

**diamond tester;** same as thermal conductivity diamond tester.

**diamond thermal conductivity;** → thermal conductivity.

**Diamond Throne;** a Buddhist fabulous said that a throne was made from a single diamond of 100 feet in circumference. It stood near that tree, under which Buddha was said to have received enlightenment.

**Diamond Tiara of the Queen of Sweden;** a curved or semi-circular head ornament worn by Swedish Queen

in 1850, which was encrusted with several diamonds.

**diamond tin;** a term applied to large bright crystals of cassiterite.

**diamond tongs;** for the handing, the diamonds or other stones variety of tongs or tweezers is available with fine non-slip tips, which are blunter than watchmaker tweezers and have fine milling inside the tips. → Diamond tweezers.

**diamond trade practices;** trade of the diamond in the general economy is considerable, while this is reflected in the trade practice rules of the diamond industry.

**Diamond Trading Company;** → Central Selling Organization.

**diamond transparency to X-rays;** diamond is pure carbon (a light atomic weight 12) and is transparent to X-ray. Other heavier and indeed all colored stones and glass, which simulate diamonds are much more opaque to X-ray.

**diamond treated;** → diamond radium treated, diamond pile treated, diamond neutroned, treated diamond.

**diamond truer;** a grinding-wheel usually with a short steel rod, which is inserted in a wooden handle and has in its free end an industrial diamond. Same as diamond dressing tool.

**diamond tube;** same as diamond needle.

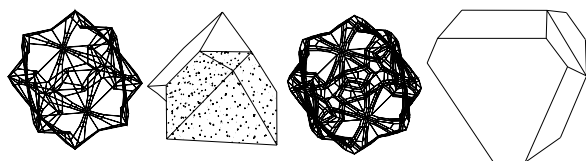
**diamond turning tools;** any kind of a diamond-tipped turning tool, using single precisely shaped and polished diamond used in lathes for the turning of nonferrous metal, other hard materials and plastics. → Diamond tongs.

**diamond tweezers;** sharp, pointed small metal pincers



*holding diamond tweezer for examining of the inclusions*

used to pick up, hold and manipulate angle diamonds.



*diamond twins*

→ Corn tongs.

**diamond twins;** diamond twins are seen as contact twins with the twin law (111).

**diamond Types;** → Types I and II,-diamonds.

**diamond Types I and II;** → Types I and II,-diamonds.

**Diamond Viewer;** an apparatus made for De Beers to detect strongly phosphorescence effect of synthetic diamond. This effect caused due to forming of cubic crystal (normally octahedric) in internally of stone, which is similar to umbrella. diamond viewer; A commercial instrument used for rapidly making phosphorescence effect and comparisons of synthetic diamond. Designed by the De Beers Co., London.

**diamond washer;** a tool used for washing diamondiferous gravel.

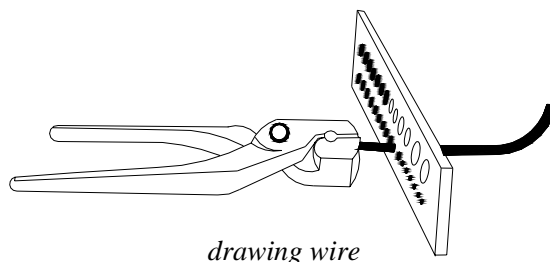
**diamond washer;** a device used in West Africa used for washing diamondiferous gravel.

**diamond-washing cup;** same as diamond sieve but smaller provided with pieces of glass, one as cover and another as jar, for washing and cleaning diamonds and other gemstones.

**diamond wear;** same as diamond loss.

**diamond, weight estimation of polished;** → weight estimation of polished gemstones.

**diamond wire-drawing dies;** diamond turning tools of similar type used with fine metal. Wire-drawing is



made for using the orifice of pressure-type oil burners from boiler furnaces.

**diamond working;** a term applied to the methods of working the pipes by means of shafts.

**diamond, world production of;** total world production estimated from 1970 is 46,269,156 cts.

**diamond writing pencils;** a small diamond of a cone shape mounted in a suitable penholder shaped metal grip used to etch on metal or glass.

**diamond, X-ray fluorescence of;** → diamond fluorescence.

**diamond yardstick;** same as master diamond.

**diamond yardstick holder;** a special attachment for holding master diamonds for using in DiamondLite for color grading of mounted diamonds.

**diamond yield;** same as diamond recovery.

**diamone;** a commercial term for yttrium aluminate garnet (YAG) used as a diamond imitation.

**diamonesque;** a commercial term for synthetic cubic zirconium oxide, made by the Ceres Corporation of Waltham, Massachusetts, USA. Used as a diamond imitation.

**diamonette;** a trade term for colorless synthetic corundum used as a diamond imitation.

**diamonflame;** a trade term for colorless synthetic corundum used as a diamond imitation.

**diamonique;** a commercial term for synthetic yttrium aluminate (YAG) used as a diamond imitation.

**diamonique I;** a commercial term for synthetic yttrium aluminate (YAG) used as a diamond imitation.

**diamonique II;** a commercial term for synthetic gadolinium gallium garnet (GGG) used as a diamond imitation.

**diamonique III;** a commercial term for synthetic cubic zirconium oxide used as a diamond imitation.

**diamonite;** a commercial term for synthetically rutile used as a diamond imitation.

**diamonte;** a commercial term for yttrium aluminate (YAG) used as a diamond imitation.

**diamontiferous;** same as diamondiferous.

**diamontina;** a commercial term for synthetic strontium titanate used as a diamond imitation.

**diamontine;** same as aluminum oxide.

**diamontite;** same as aluminum oxide.

**diamothyst;** a commercial term for synthetic rutile used as a diamond imitation.

**dianite;** same as columbite.

**diaper;** to ornament a pattern unit in the form of contiguous repetitions.

**diaphaneity;** a term applied to properties of gemstones, which are divided in transparent (semitransparent), translucent (semitranslucent) and opaque. In mineralogy the light-transmitting quality of a gemstone or mineral.

**diaphanous;** the term applied to mineral, which allows light to show or to shine through.

**diaphroite;** same as ultrabasite, an orthorhombic, gray black mineral of  $Pb_2Ag_3Sb_3S_8$ .

**diaphthoresis;** same as retrogradic metamorphism.

**diaphthorite;** same as diaphthoritic rock.

**diapositive;** same as transparent positive.

**Diário De Minas-Gerais Diamond;** a diamond of 375.10 cts, found in 1941 in San Antonio river, Minas-Gerais, Brazil. Was purchased by Harry Winston and fashioned into a number of stones.

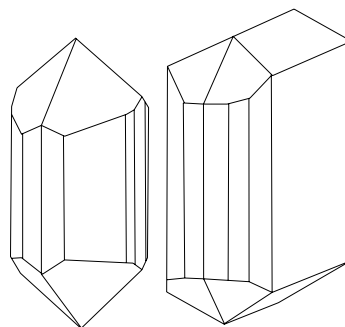
**diarita;** a commercial term for colorless doublet from synthetic spinel in crown and strontium titanate in pavilion.

**diascope;** an optical projector used to display

transparencies.

**diaschistic;** a rock of a minor intrusion or dike, in which differentiation has occurred, so that its composition is not the same as the parent igneous mass; said of certain dikes associated with igneous intrusions.

**diaspore;** dimorphous with boehmite. Synonym diasporite, kayselite (from Turkey). A suitable gem



*diaspor  
crystals*

mineral for collectors. Used as an abrasive, or refractory.

System: orthorhombic.

Formula:  $2[Al_2O_3 \cdot H_2O]$  or  $4[HAIO_2]$  or  $4[AlOOH]$ .

Luster: vitreous, pearls on cleavage.

Colors: colorless, white, yellow, grayish, greenish, pink, brownish, and violet.

Streak: colorless.

Diaphaneity: transparent to translucent.

Cleavage: {010} perfect, {110} distinct, and {100} in trace.

Fracture: conchoidal. Brittle.

SG: 3.30-3.50.

H:  $6\frac{1}{2}$ -7.

Optics;  $\alpha$ :1.702,  $\beta$ :1.722,  $\gamma$ :1.751.

Birefringence: 0.049.  $\oplus$ .

Found in the Czech Republic, Massachusetts, and Pennsylvania (USA), and Turkey, Hungary, Urals (Russia), China, Japan, etc.

**diaspore absorption spectrums;** in the blue at 471, 463, and 454 nm, and a sharp line at 701 nm.

**diaspore luminescence;** dull light yellow under SWUV, those stones from Turkey green under SWUV.

**diaspore pleochroism;** it is strongly pleochroitic in violet-blue, light-green and rose to deep red.

**diasporite;** same as diaspore.

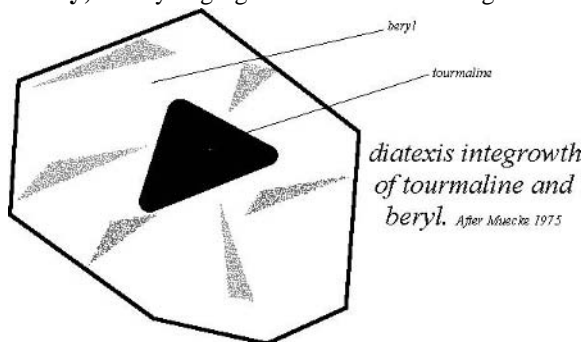
**diaspro;** an Italian term for diaspore.

**diasterism;** a star effect, which is easily visible, when light is transmitted through the stone, this can be seen in common rose quartz, which contains microscopic needles of rutile and phlogopite mica, in contrast to epiasterism observed by reflected light.

**diatexis;** high-grade metamorphism or anatexis by which the involving rock forming minerals are with high melting points. In this condition, a mineral is intergrowth with surrounding mineral such as tourmaline in beryl.



**diataxy**; nearly high-grade of oriented intergrowth of

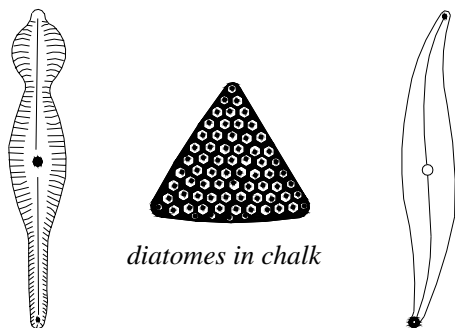


two crystals such as tourmaline crystal within a beryl crystal from Amakazobé, Malagasy.

**diatomic**; having two atoms in the molecule such as O<sub>2</sub>.  
→ Molecule.

**diatomaceous earth**; containing numerous fossilized diatoms. → Diatomite.

**diatomite**; a polishing powder produced from fossilized diatoms. Diatomite is essentially amorphous, soft, fine,



yellow to light gray, hydrated, or opaline silica with various contaminants, such as silica sand, clay minerals, iron, alkalis, and alkaline earth's. Sometimes called diatomaceous earth, fossil tripoli, fossil flour, rock meal, and kieselguhr.

**diatreame**; a breccia-filled volcanic vent or pipe, which formed by the explosive energy of the gas-charged magmas. When the breccia is kimberlite or lamproite the rock may be diamond-bearing. Example: diamond-bearing kimberlite pipe of South Africa.

**diazo**; a compound contains two azo groups such as Bismarck brown R, a dark brown powder soluble in water and alcohol. Used as dyes and biological stain.

**dibromoethane**; same as ethylene dibromide.

**dibromoindigo**; same as tyrian purple.

**dice**; a term used dice made of jet.

**dice mineral**; a term used in USA for cubic mineral such as sphalerite, galena, etc.

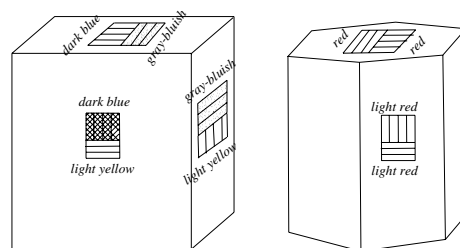
**dichloromethane**; same as methylene chloride.

**Dichopsis gutta**; → gutta percha

**dichroic**; a term applied to any mineral or gem that displays dichroism.

**dichroic filter**; same as dichroic mirror.

**dichroic gem**; any gemstone or mineral, which



left: three chromism of cordierite an optic biaxial crystal. Right: dichroism of sapphire an optic uniaxial crystal

possesses dichroism. Synonym dichroic stone.

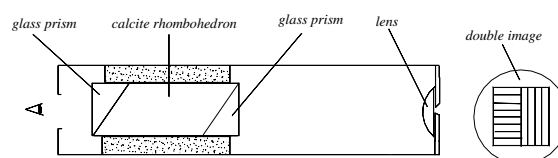
**dichroic mirror**; a term used in spectrometry when color of selective mirror, reflects a particular band of spectral energy and transmits all other energies. Also called dichroic filter.

**dichroic stone**; same as dichroic gem.

**dichroism**; an optical property, by which the color of a stone varies according to the direction, in which it is viewed by transmitted light. The two polarized rays passing through a given direction in a colored doubly refracting mineral are often differential selective absorption, and thus differ in color, when they emerge to reach the eye. The two colors can be compared side-by-side using a dichroscope. This effect is correctly called dichromatism and may be seen in the hexagonal and tetragonal system. The effect dichroism is never observed in glass or single refracting or non-dichroic stones. Dichroism effect may derive from the same phenomenon as color. The general term covering all such properties is pleochroism. Trichroism may be seen by biaxial stones, when crystallized in orthorhombic, triclinic, and monoclinic system. → Pleochroic, dichroscope.

**dichroism**; a term used in spectrometry when absorption spectrum band is symmetrically or in balance, it means the band is fully in visible region and two wings of spectrum have a balance effect. Not to be confused with oriented dichroism in minerals.

**dichroite**; synonym for cordierite.



section through a dichroscope

**dichromatic**; pertaining to or involving two colors only.

**dichromatism;** state of being dichromatic. Color blindness, in which only two colors of the spectrum can be distinguished. → Dichroism.

**dichroscope;** an optical instrument that is used to detect two of the different colors emerging from pleochroic gems. The device comprising a suitably cut rhombus of Iceland spar or polarizing filters and a lens system in a short tube, and the two colors be viewed side by side.

**dickinsonite;** a green, olive-green, yellowish to yellowish-brown, hydrous phosphate mineral. Similar as arrojadite. Monoclinic system. Vitreous luster. Optics;  $\alpha$  1.653,  $\beta$  :1.659,  $\gamma$  :1.667. Birefringence: 0.014. ⊕. Dispersion: strong. SG:3.38-3.41. H:3½-4. Pleochroism: pale yellowish-green to olive-green. Found in Poland. Rarely been cut.

**dickite;** → kaolinite.

**dickstein;** a German term for table cut.

**DICORP S.L.;** an acronym for Diamond Corporation Sierra Leone.

**DICORWAF;** an acronym for Diamond Corporation West Africa, Ltd.

**DICOSIL;** an acronym for Diamond Corporation Sierra Leone.

**didodecahedron;** a crystal form of dyakisdodecahedron. Also called diploid, diploherdon.

**didymite;** a variety of mica.

**didymium;** a collective term of two elements of rare-earth as neodymium and praseodymium. Used in imitation gem as color agents to produce lilac and amber-colored varieties of cubic zirconium oxide.

**didymium glass;** any glass containing elements of didymium.

**didymium spectrum;** didymium a collective term of two elements of rare-earth (neodymium and praseodymium) in glass as quantity, which cause strong absorption in the yellow, and a rather characteristic pink color. Synthetic gems as YAG and natural scheelite are frequently doped with one or other of the rare-earth oxides.

**die;** any various devices for casting or forming. → Casting.

**die;** an informal term used by Australian miners for a precious opal by which the color quality fade as viewing angle is changed.

**die casting;** → casting.

**Diego Ajejo Montoya, Don;** who finished the Crown of Virgin del Sagrario.

**dielectric;** non-conductor of electricity such as glass, quartz, or other gemstones.

**diesel;** → diesel gueda.

**diesel geuda;** a Sinhalese term used for a semitransparent to sub-translucent sapphire of tea-color to diesel effect in transmitted ray. → Geuda.

**die stamping;** the method used to produce a relief pattern generally on a flat layer of a metal by pressure, in a die made from a master model like an embossed book cover. Sometimes called die striking.

**die striking;** → die stamping.

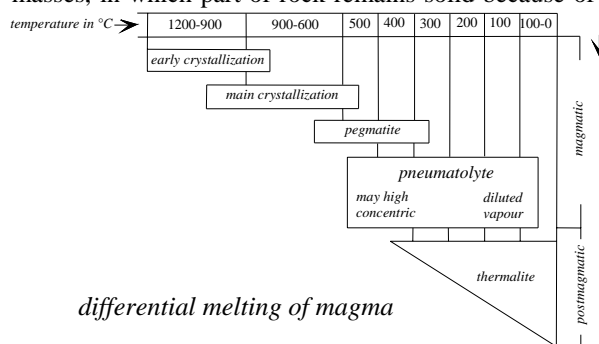
**Dievedraai;** location of a small alluvial diamond mine in Transvaal Province, South Africa.

**differential brilliant cut diamond;** comparison of ideal cut, American brilliant cut, fine-ct brilliant, Parker brilliant cut and ideal Scan DN brilliant cut. → Comparison of diamonds

**differential fluorescence of diamond;** many diamonds show an afterglow or phosphorescence under ultraviolet light, this differential effect can be photographed and can be used as an identity certificate.

**differential grinding;** differences in grinding ability of constituents of mineral or ore.

**differential melting;** partial melting of a rock in igneous masses, in which part of rock remains solid because of

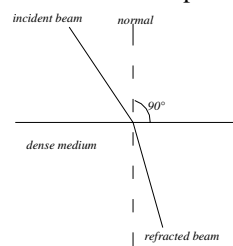


*differential melting of magma*

differences in melting point of minerals.

**differential pickling;** to create a surface of two gilt colors on a certain part of an article, which is made of gold alloy or copper. → Depletion gilding.

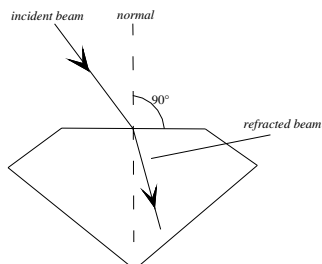
**differential selective absorption of light;** when light passes through the colored doubly refracting gemstones in the form of two polarized rays (the ordinary ray and the extraordinary ray in uniaxial crystals is called dichroism, or of the three rays in biaxial crystal is called trichroism) may emerge differing shades or colors said to have differential selective absorption. Also, this phenomenon is called pleochroism.



*entering of incident light in a dense medium is refracted toward the normal*

**differentiation;** the process of developing of two or more different rocks from a common magma body.

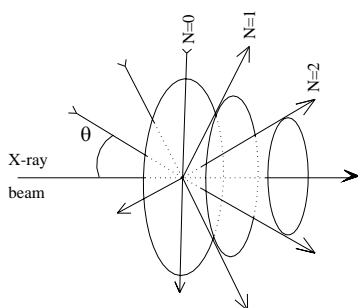
**diffraction;** the process, by which the direction of the light and other forms of radiant energy (as X-ray, electrons, and neutrons) is modified by the bending of radiation around the edges of opaque bodies or through narrow slits, or when transmitted through or reflected from a diffraction grating, in which the rays of white light are broken into a series of colored spectra. It is a



*diffraction of light after entering in a gemstone towards the normal*

special case of light when it departs from rectangular propagation, and it is a special case of interference of light. Also called diffraction of light.

**diffraction cones;** in a 3-dimensional lattice there are 3 axial directions, each with its peculiar periodicity of scattering points, which are capable of generating its



*diffraction cones of X-rays*

own series of nested cones with belonged angles.

**diffraction grating;** a device in optical spectroscopy, a series of fine equidistant and parallel lines on glass or metal and that are used in producing the spectra by diffraction. They are used in some types of spectroscopes.

**diffraction of light;** → diffraction.

**diffraction pattern by X-rays crystals;** producing a photographic pattern from crystal specimen by X-ray method.

**diffraction pattern by X-rays pearls;** an experimental X-ray method by Lauegrams involving testing of natural pearls and cultured pearls, according to known experiments, which should give a different pattern in one direction with cultured pearls.

**diffraction, principle of;** → diffraction.

**diffraction spacing;** in a crystal lattice, interplanar spacing given by a diffraction pattern.

**diffraction spectroscopy;** an instrument that determines the spectrum, which is produced by diffraction of light from finely ruled grating surface. → Spectroscope.

**diffractometer;** an instrument used in mineral analysis for the examination of the atomic structure of substances by the diffraction of X-rays or neutrons, which records intensities of diffracted beams of X-rays at different angles as an inked trace on a strip chart.

**diffuse light;** a name applied to describe an anomaly of light, which does not show any pronounced focal point or reflects off irregularly in all directions.

**diffuse luster;** same as glimmering.

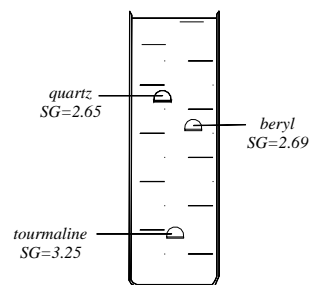
**diffuse reflection;** same as nonspecular reflection.

**diffuse reflector;** those rough surfaces of stone, which reflects incident rays in a multiplicity direction because of irregularities in the surface.

**diffusion;** the permeation of higher density substances through another of lower density, such as gas through liquid, solid, or gas.

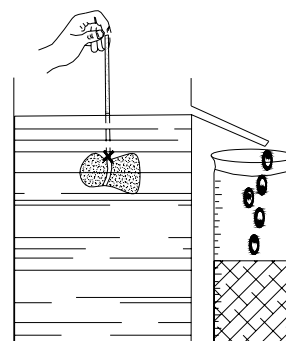
**diffusion bonding;** the method of joining two separate parts of gold or other solid surfaces under high pressures and temperatures, similar to the method of colloidal hard-soldering.

**diffusion column;** a method for quickly determining the density of gemstones of slightly differing specific gravity such as stones of different color of the same



*diffusion column of heavy liquid, methylene iodide and benzol*

species mineral. A long, narrow test tube containing



*measuring the SG of a mineral by means of its volumetric displacement of water in a diffusion column*

two heavy liquids, one being less dense than the other,

allowed to diffuse together so that the resultant liquid varies in density from top to bottom such as methylene iodide with about five times as much benzol added. Stones of specific gravities between the limits of the liquid settle at the levels, which correspond with their particular densities.

**diffusion flame;** long luminous gas flame with constant rate of radiation. Also called candle flame.

**diffusion melt;** describing of the method to produce synthetic crystal, which is similar to flux diffusion. In this technique, the used chemical compositions are usually in separate sheets and crystallization occurs after diffusion of the chemicals, when the mass is fused. → Diffusion technique.

**diffusion of light;** → diffuse light.

**diffusion technique;** a technique, in which a natural colorless to weakly colored corundum has its color improved by diffusing color into the surface of preformed gemstones. This happens by adding element oxides to the paste; chromium for ruby, iron and titanium for sapphire. → Diffusion melt, sapphire surface diffusion.

**digger;** a term applied to one that digs in the ground as miner.

**digenite;** blue, with a metallic luster, of  $4[\text{Cu}_9\text{S}_5]$ . It occurs in trigonal pseudocubic crystals or in masses. Opaque. Streak: bluish. Fracture: conchoidal. Cleavage: (111). Sometimes used in cheap jewelry. SG:5.5-5.8. H:2½-3. Found in USA and South-West Africa. Synonym for alpha chalcocite and neodigenite.

**digestion;** same as assimilation.

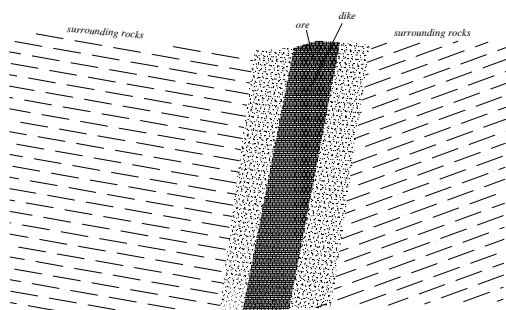
**digging;** mining operation in mineral or ore.

**diggings;** a term applied to any mineral deposit and mining camps.

**diggings;** in the USA used for placer mining only.

**digital scanning spectroscopy;** a type of diffraction grating spectroscopy, by which the wavelength can be read digitally.

**digraha yoga;** a Hindu term for emerald when worn on May Mercury associated with emerald while emerald is a friend of Saturn and because of combination of two



*dike with metallic ore insurrounding rocks*

planets in one house of the zodiac. In this

constellations the Mercury together with Sun, Moon and other planets having great influence on morals, baleful, and beneficial.

**di-iodoform;** same as tetraiodoethylene.

**di-iodomethane;** same as methylene iodide.

**dike;** tabular appearance of igneous rock intruding vertical or inclined through the fissure of the country rock. Not to be confused with a vein. Also spelled dyke.

**dikelet;** a minute dike. Also spelled dykelet.

**dilatation;** change in volume without change in shape, which includes expansion and contraction of granular material such as sand due to rearrangement of the component grains.

**dilute;** to make a less concentrated solution.

**dilute;** in optics to make fainter, as in color.

**dilute;** sometimes used to relatively weak in concentration.

**diluvial;** pertaining to, produced by, or resembling a flood.

**diluvial;** of or relating to diluvium. Also called diluvial deposit.

**diluvial deposit;** → diluvial.

**diluvial ore;** same as placer.

**diluvium;** a term applied to sand, gravel, clay, etc., in surficial deposits.

**dimension stone;** naturally occurring building stone that is quarried and prepared in various blocks according to specifications. Used for external and interior parts of building and curbing such as marble, granite, limestone, sandstone, diorite, basalt, diabase, etc. Also called quarry block.

**dimethylaniline;** a toxic, yellowish to brown liquid that is used in dyes and for determination of refractive properties. RI:1.56. Soluble in alcohol.

**dimetric system;** another term for tetragonal system.

**DIMINCO;** an acronym for National Diamond Mining Company Sierra Leone.

**dimorph;** either of two crystal forms that exhibits dimorphism. Partial synonym for allomorph.

**dimorphic;** same as dimorphous.

**dimorphism;** the term describing the property of certain substances that enables them to exist in two distinct crystalline forms, such as calcium carbonate ( $\text{CaCO}_3$ ) crystallizing as calcite in the hexagonal and aragonite in orthorhombic, or  $\text{FeS}_2$  as pyrite (cubic) and marcasite (orthorhombic) or diamond in cubic system and graphite in hexagonal system both are carbon. These properties collectively are known as polymorphism. → Trimorphous, polymorphism, allotropic.

**dimorphous;** having the same chemical composition but exhibiting two different crystal systems. Also called dimorphic. → Polymorphous, trimorphous, allotropic.

**dinas rock;** a term applied to a natural rock or sandstone

of high silica content, used as a refractory brick.

**ding**; a Chinese term for food vessel made of bronze.

**dinny bone**; brownish fossilized dinosaur bone from Wyoming, Utah, and Colorado, USA used for carving ornamental objects. Other colors are red, blue, green, orange, and pink shades. Also called dinosaur bone.

**dinosaur bone**; same as dinny bone.

**dinotherium**; a prehistoric beast whose body was buried in the frozen mud and then the tusks were used as ivory. → *Odontolite*.

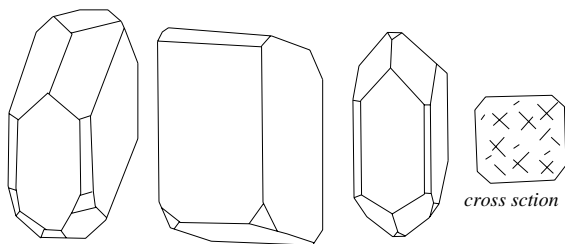
**diploherdon**; → *didodecahedron*.

**diogenite**; an achondritic stony meteorite consisting of bronzite or hypersthene. Also called *rodite*.

**diplogenetic**; a term used to a mineral deposit, which is partly syngenetic and partly epigenetic.

**diploid**; → *didodecahedron*.

**diopside**; a transparent mineral of single chain silicates from clinopyroxene group. A massive dark violet-blue variety from Piedmont known as *violane*. The color ranges, owing to the presence of varying quantities of



*diopside crystals and right cross section*

iron oxide (salite or ferrosalite). Containing manganese and zinc known as *jeffersonite*, rich in manganese named as *schefferite*. Some varieties show chatoyancy *cat's-eye* or 4-rayed star due to inclusions, when cut cabochon. It shows variable luminescence under LWUV light. Is used for step-cut varieties and as ornamental stone. Varieties are called *alacolite*, *chromdiopside* (chromium-rich from Kimberley, South Africa), *malacolite*, *baikalite*, *alalite*.

System: monoclinic.

Formula:  $4[\text{MgCaSi}_2\text{O}_6]$ .

Luster: vitreous often dull.

Colors: colorless, gray, green, yellowish to brown, green black, brown to reddish-brown, violet-blue.

Streak: colorless to grayish-white.

Diaphaneity: transparent to nearly opaque.

Cleavage:  $\{110\}$  good.

Fracture: conchoidal to uneven. Brittle.

SG: 3.22-3.30.

H: 6-6½.

Optics:  $\alpha$ : 1.664-1.695,  $\beta$ : 1.672-1.700,  $\gamma$ : 1.695-1.721.

Birefringence: 0.024-0.031. ⊕.

Dispersion: 0.017-0.020.

Found in South Africa, Myanmar, (Burma), Brazil, Sri Lanka, Malagasy, Italy, New York, Ontario, Russia, India, and Japan.

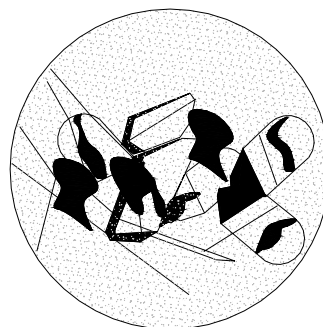
**diopside absorption spectrum**; two sharp lines in the green at 508, and 505 nm and a band in the blue at 490 nm due to chromium. It may be seen some woolly and dull bands at 635, 655, 670 and 690 nm. Light-green diopside exhibits lines at 505, 493 and 446 nm.

**diopside cat's-eye**; green chrome-diopside with *cat's-eye* effect from Myanmar, (Burma).

**diopside, chromium rich**; chrome diopside from Hunza, Pakistan is locally termed as *Hunzanite*, also found in Kimberley, South Africa.

**diopside cut**; → *diopside*.

**diopside inclusions**; in chrome diopside from Finland



*healed cracks in chrome-diopside from Finland*

can be seen several healed cracks.

**diopside jade**; same as *diopside jadeite*.

**diopside jadeite**; a pyroxene intermediate between *jadeite* and *diopside* from Tuxtla, Mexico. Synonym for *tuxtlite*. Also called *diopside jade*.

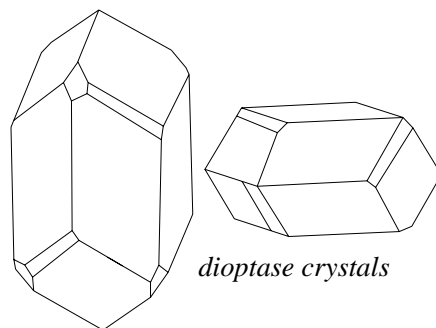
**diopside luminescence**; blue or cream-white and orange under SWUV. Frequently mauve under LWUV. Some pieces shows phosphorescence in peach color.

**diopside, star**; virtually black and opaque with 4-star effect by rod-like inclusion. The star has angles between 73° and 107°. RI: 1.674-1.700. SG: 3.35. These stone are cut cabochon. Found in India.

**diopside varieties**; → *diopside*.

**diopsideite**; a fine-grained ultrabasic igneous rock, containing essentially *diopside*, *ceylonite*, and *garnet*.

**diopside**; a rare emerald-green mineral. Cut as emerald



*diopside crystals*

for collectors. It has strong color dispersion. No

luminescence. Obsolete term of achirite. Misnomerly called emerald copper. When first found, it was used as a gemstone, but is very soft and has strong cleavage. Also in commercial misleadingly termed as diopase emeraldine or emeraldine.

System: hexagonal (trigonal).

Formula:  $6[\text{CuSiO}_3 \cdot \text{H}_2\text{O}]$ .

Luster: vitreous often dull.

Colors: emerald-green, deep bluish-green.

Streak: pale greenish blue.

Diaphaneity: transparent to translucent.

Cleavage:  $\{1011\}$  perfect.

Fracture: conchoidal to uneven. Brittle.

SG: 3.28-3.35.

H: 5.

Optics;  $\omega$ : 1.644-1.658,  $\epsilon$ : 1.697-1.7094.

Birefringence: 0.051-0.054.  $\oplus$ .

Dispersion: 0.036.

Found in Russia, South West Africa, Arizona (USA), Zaire, Katanga, Namibia, Chile, and Congo.

**diopase absorption spectrum;** a broad band in the yellow-green at about 550 nm.

**diopase cut;** → diopase.

**diopase emeraldine;** a trade term for diopase.

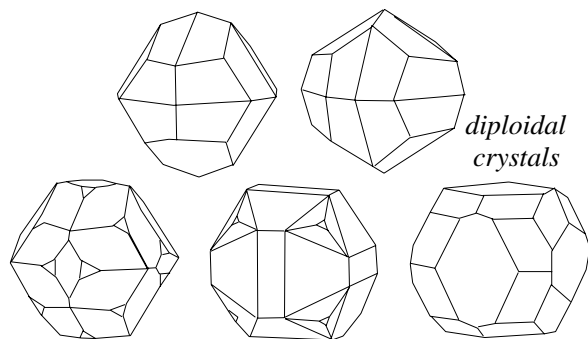
**diopase luminescence;** orange, light-green, blue, creamy-white and pale brown under SWUV and orange, light-green, blue, creamy-white under LWUV.

**diopter;** a unit of determining the refractive power of a lens or mirror system, which is expressed as the reciprocal of the focal length in meters:

$$\text{power in diopters} = \frac{1}{\text{focal length in m}}$$

The power is negative for diverging lens and convex mirrors, positive for a converging lens and concave mirrors. Also called sight.

**diorite;** a coarse-grained, plutonic igneous rock intermediate in composed sodic plagioclase, hornblende, biotite, or pyroxene, and small amounts of



diploidal crystals

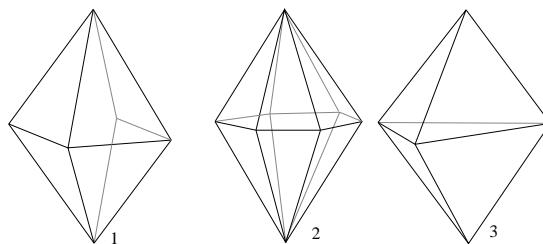
quartz. Used as ornamental and building stones. Often

called orbicular diorite. → Granodiorite, tonalite.

**diorite;** a term used for greenstone.

**diploid;** same as didodecahedron.

**diploidal class;** same as isometric system having symmetry  $2/3m3$ .



1: tetragonal dipyrmidal, 2: hexagonal dipyrmidal and 3: trigonal dipyrmidal

**dipole;** any object or system of two equal point electric charges or magnetic poles of opposite state, positively and negatively charged.

**dipterocharpa;** → white dammar.

**dipyramid;** in form of two pyramids base to base.

**dipyramidal;** adjective of dipyramid.

**dipyre;** a variety of scapolite with the components marialite and meionite with the ratio 5:1 to 1:1. Also called dipyrite, mizzonite.

**dipyrite;** same as dipyre.

**direct dyes;** a general term for dyes soluble in water used to coloring the fibers with a neutral aqueous solution containing an electrolyte because of selective absorption. To obtain a higher concentration added assistance substances such as sodium sulfate or sodium chloride. Used as dyes. Also called substantive dyes.

**direct measurement;** estimating the dimensions of a gemstone or diamond without any measuring devices.

**direct measurement method (optic);** a not very accurate but useful method to test stones with higher refractive index. For determining refractive index using a microscope two parallel faces of a crystal or a cut stone such as parallel faces in an octahedral crystal or table and culet in a cut stone are needed. Where first measured the real depth of stone with a vernier (A), than the apparent depth (B), and by dividing of real depth through apparent depth the refractive index can be obtained.

$$\text{RI} = A/B$$

Also called De Chaulnes' refractive index determining. → Refractive index measurement.

**direct measurement of refractive index;** there are three methods of refractive index (a) direct measurement method (b) minimum deviation method and (c) Brewster's angle method. The direct method is also called De Chaulnes' refractive index determining, or

De Chaulnes' method. → Refractive index measurement.

**direct method;** → direct measurement of refractive index.

**direct reflection;** same as specular reflection.

**direct vision spectroscopy;** a device in optical spectroscopy provided with glass prisms or with diffraction grating and a wavelength scale. The commonly used is glass prism type but dispersion spectrum is too small to see the detailed bands.

**direction hardness;** hardness varies according to crystallographic direction in certain minerals such as kyanite or disthene has three different hardness in three different crystallographic directions: 4.5, 6, and 7.

**directions image;** → interference figures.

**dirham;** an Iranian weight unit, 2 miscalls equal 1 dirham or 72.88 cts.

**dirigem;** a copyrighted commercial term for green synthetic spinel.

**dirigent;** a new determined brilliant cut with an extra eight facets on the pavilion.

**dirilyte;** a commercial term for an alloy of gold color composed of 88% copper, 10% aluminum, and 2% nickel.

**dirt;** same as gangue, or broken valueless mineral.

**dirt;** an informal term used by Australian miners for opal dirt, or opal-bearing clay area, which is a layer under sandstone.

**dirubin;** a German term for abrasive material from corundum or synthetic corundum.

**disc brooch;** brooch made of gold or other metals in the form of a flat disc.

**disclosure;** to advise a customer about weight, clarity, color, cut, natural, or synthetic, and condition of a diamond, or damage, etc.

**discoid;** a disc-shaped object.

**discoid;** an object having flat and circular form such as solitary corallite.

**discoid fracture;** some ruby and sapphire contain circular fractures, they surrounding included crystals, create by heat treatment expansion of inclusion crystals which is fractures by the host.

**discontinuity;** any interruption.

**discontinuity lattice;** reputation of unit crystal. In crystallography, orderly geometric structure, in which crystal or more atoms are arranged.

**discordant;** unconformable or none parallel of bedding of structure.

**discovery;** a place where a valuable mineral is found.

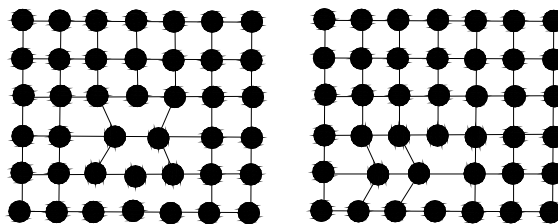
**disdain;** a term used in Baltic area with believing that amber necklace chokes the owner or wearer who tells an untruth. Probably this believing is the source of name.

**disintegration;** same as chemical weathering.

**dislocation;** slippage along a crystal plane during the crystallization.

**dislocation;** deformation, on a larger scale along bedding in a rock formation.

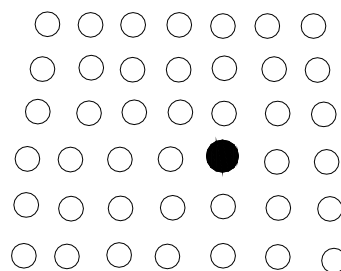
**dislocation;** in geology the relative movement of the two sides of a fault.



*dislocation in a two dimensional crystal*

**dismicrite;** a fine-textured limestone containing irregular patches or bird's-eyes of spray calcite fill in cavities. Synonym for bird's-eye limestone.

**disordered crystal structure;** occupation of atom sites in a crystal lattice by two or more different or the same



*defect in a two dimensional crystal which caused a disordered effect*

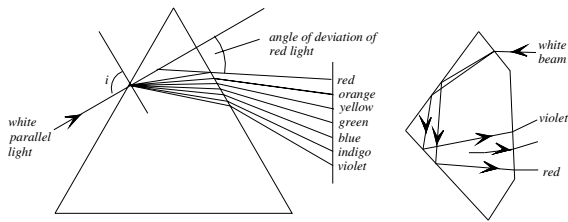
atoms of similar charge or may size, or similar size and different charge in two or three dimensions when there is a concomitant replacement to balance charges.

**disperse dye;** a dye that may be in chemical classes such as nitroarylamine, azo and anthraquinone. These three compound containing amino or substituted amino group but no soluble sulfonic acid group. They are obtained as dispersion or colloidal suspension because they are insoluble or slightly soluble in water. Used as dye.

**dispersion;** the property of transparent gemstone, which breaks up white light into the colored ray or spectrum, when a white light passes across two inclined faces of the cut stone or prism. The rays of white light are spread due to slowing and bent according to their wavelength from shortest red to the longest the violet. In gemology, it is known as *fire*. The interval between such colors varies in different gems, and is measured according to the difference between the refractive

*dispersion color – distant vision*

indices of the red ray in Fraunhofer line (B at 687 nm) and the blue-violet ray in Fraunhofer line (G at 430.8



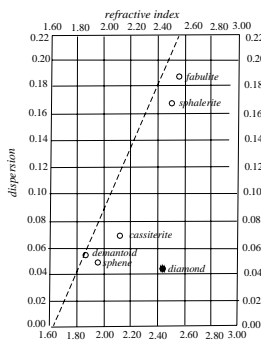
*dispersion of light in a prism and right: in a brilliant-cut diamond*

nm). Diamond's dispersion is 0.044. Also known as dispersion of light, scattering. → Color dispersion.

**dispersion, color;** → color dispersion.

**dispersion halo;** a halo with cloudy colored dispersion occurring around radioactive inclusions such as zircons in tourmaline or cordierite. Also called pleochroic halo.

**dispersion in diamond;** an attractive optical effect of diamond known as *fire* or *dispersion* by diamond. The dispersion in diamond the red ray (B line of Fraunhofer's spectrum at 687 nm) has refractive index of 2.407. The blue ray (G line of Fraunhofer's spectrum



*relatively low dispersion of diamond in relation to other stones of high refractive index*

at 430.8 nm) has an index of 2.451. Or the violet ray correspond to H line of Fraunhofer's spectrum at 397 nm has an index of 2.465. The difference between B and G (red and blue ray) refractive indices is 0.044. → Fraunhofer lines, dispersion of diamond.

**dispersion, measurement of;** color dispersion is strong in diamond, dispersion is measured by difference between the refractive indices of the medium for the red ray and the violet ray or blue ray. Usually to measure the refractive index of the medium for Fraunhofer B range of the solar spectrum (red at 687 nm) and G range (blue-violet at 430.8 nm). → Fraunhofer lines, dispersion in diamond.

**display of diamond;** a term applied to the windows for fundamental lighting must be considered to achieve the most effective display of diamond.

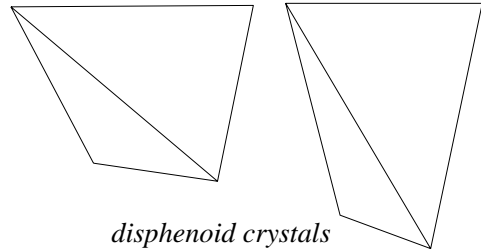
**dispersion of light;** → dispersion.

**dispersion of liquids ;** the measured refractive index of sodium light of strong wavelengths lines and mercury wavelengths lines of liquid CH<sub>2</sub>I<sub>2</sub> shows different refractive indices, Na at 589.3 nm and Hg at 623.4 nm.

**dispersion of strontium titanate;** → fadulite.

**dispersion of synthetic rutile;** The difference between both refractive indices (B,G) is 0.2851 for ordinary ray, which corresponds to approximately 0.300 of the solar spectrum.

**disphenoid crystals;** closed crystal forms consisting of two sphenoids in which the two faces of the upper face

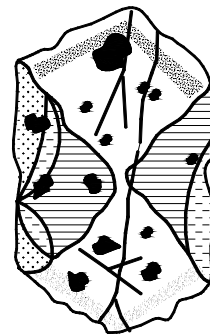


*disphenoid crystals*

alternate with the lower face. See figure below. Also called bisphenoid.

**displacement;** → parallel displacement.

**disseminated;** a mineral deposit, in which the minerals occur as scattered or diffused in the form of grains or pebbles. Spread out, dispersed, as applied particularly



*disseminated aggregate in pyroxene crystal*

to particles of ore mineral in the substrate rock. Scattered crystal or scattered minerals. Also scattered.

**disseminated crystals;** a term applied to a crystal, which has dispersed and is not found attached to the mother rock.

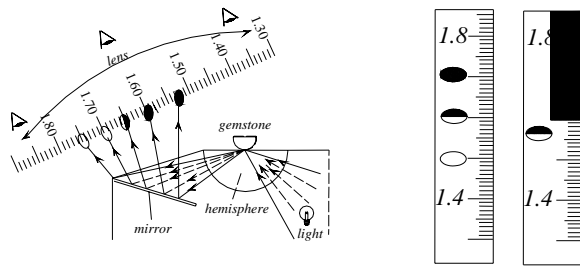
**dissociation;** a temporary reversible decomposition of a molecule into simpler molecule or atoms (into ions in solution). → Photodissociation.

**dissolution ;** → assimilation.

**distant vision method;** a method found by Lester Benson's, which is known in America as the *spot, spot contact* or *distant vision* method. A smallest spot of liquid is placed between curved surface of gem and hemisphere prism of refractometer. To use the distant vision method the eye is placed 35-40 cm away from the eyepiece and a small circular area can be seen. In



critical position, it is bisected horizontally into a dark upper part and a light lower part. When this position is found it must be carried mentally for an instant, while



distant or spot-method RI measuring of a cabochon, half filled bubble is the critical angle

the eye is lowered so that the scale of refractometer, which was previously out of focus, can be read, but reading with a device, which is provided with a ribbon is easier. Also called spot method, spot contact refractometer technique, spot contact method. → Jeweler's eye.

**distaxy;** unlike crystallographic orientation in a mineral grain and its overgrowth.

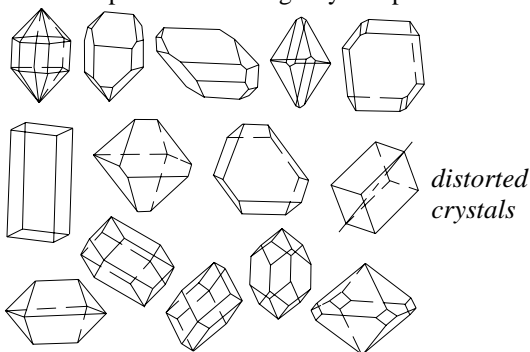
**disthene;** a less commonly used term for blue or light green kyanite. Also called cyanite, sappare.

**distinctive mineral;** same as characterizing accessory mineral.

**Distomum duplicatum;** another name for trematode parasitic worm or cestode worm found in some mollusk as agency of pearl formation. Surround of this larval worm precipitate carbonate of lime until the larva is covered or converted into a calco-spheritic structure.

**Distomum margaritarum;** a kind of parasitic worm found in *Mytilus edulis* mussel in England and France as agency of pearl formation. Also called Distomid larva. Surround of this larval worm precipitate carbonate of lime until the larva is covered or converted into a calco-spheritic structure.

**Distomum somateriae;** a kind of trematode parasitic larval found in *Mytilus edulis* mussel in England and other Europe waters as agency of pearl formation.

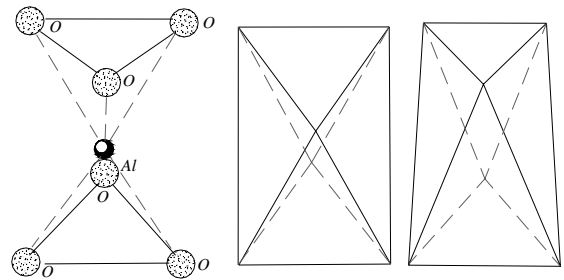


Surround of this larval worm precipitate carbonate of

lime until the larva is covered or converted into a calco-spheritic structure.

**distorted crystal;** a crystal whose faces twist or pull out of normal shape and have developed unequally, some smaller and some larger than others. But the crystal structure is the same and angle between the faces are always constant for the mineral, regardless of the imperfection of the face shapes and sizes.

**distorted crystal of corundum;** corundum crystal whose faces twist or pull out of normal shape and have developed unequally, some smaller and some larger



distorted corundum

than others. The crystal structure is nearly the same and angle between the faces are nearly constant for the mineral, regardless of the imperfection of the structure, face shapes and sizes, which can be seen in fig.

**distrene;** a promotion term for glass-like polystyrene resin plastic. RI:1.58. SG:1.05. Used to imitate amber.

**ditetragonal;** a crystal form consisting of 8 similar faces.

**ditetragonal bipyramid;** a term applied to a crystal form that is a dipyramid of 16 faces, in which any portion perpendicular to the fourfold axis is ditetragonal.

**ditetragonal-dipyramidal class;** a crystal class in the tetragonal system having symmetry  $4/m\ 2/m\ 2/m$ .

**ditetragonal pyramid;** a crystal form having 8 faces in a pyramid, in which any portion perpendicular to the fourfold axis is ditetragonal.

**ditetragonal-pyramidal class;** a crystal class in the tetragonal system consisting symmetry  $4\ mm$ .

**ditrigonal;** a crystal form consisting of 8-sided figure, in which the alternate angles are equal. Such a shape is characteristic of certain crystal forms in the hexagonal system.

**ditrigonal dipyramid;** a term applied to a crystal form that is a dipyramid of 12 faces, in which any



ditetragonal bipyramidal

perpendicular to the threefold or six fold axis is

ditrigoal.

**ditrigoal-dipyramidal class**; a crystal class in the hexagonal system consisting symmetry 6m2.

**ditrigoal-pyramidal class**; a crystal class in the rhombohedral division of the hexagonal system consisting symmetry 3m.

**ditrigoal-scalenohedral class**; same as hexagonal-scalenohedral class.

**ditróite**; a synonym for sodalite from Ditró.

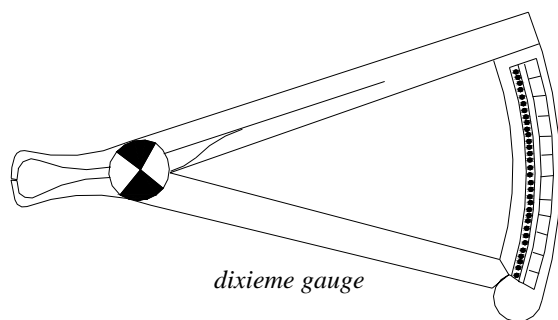
**ditróite**; a coarse-grained deep-seated alkali-syenite consisting of alkali-feldspar, nepheline, sodalite, and minute particles of soda-amphiboles and/ or pyroxene.

**divalent**; associated in pairs or otherwise bivalent.

**divergent**; the crystals radiate from a center. Same as radiated.

**divination**; a believing on the art science of divination, also black magic for practice, or foretelling and discovering future events or unknown things due to influence by supernatural powers or by omens, oracles, using of stones, gems and minerals as good-luck charms. → Margaritomancy, crystallomancy, hydromancy, crystal gazing, speculum, lithomancy.

**Dixieme gauge**; a caliper gauge used for estimating the weight of a brilliant-cut diamond by referring to the girdle diameter and depth of the stone from table to



culet in millimeters supplied by gauge. Also called Moe diamond gauge. The approximated weight is nearly 5% error carat for using of the estimation formulae or table. Also spelled Moe's gauge. → Stencil gauge, Leveridge gauge, caliper.

**Di'Yag**; an undesired commercial term for YAG, used to imitate diamond.

**djeva**; → Djevahirdjian.

**Djevahirdjian**; a Swiss synthetic gem manufacture, named after Hrand Djevahirdjian SA of Monthey, which is one of the world's biggest company they produced ruby, sapphire with 32 different color from colorless, blue to purple, cubic zirconia, etc. Also producing bicolor and tricolor gems. Frequently called Djeva. → Djevalite.

**djevalite**; a promotion term for man-made zirconium oxide (cubic zirconia) by Swiss synthetic gem

company, Hrand Djevahirdjian SA of Monthey, used as a diamond imitation. RI:2.09-2.18. Dispersion: 0.060. SG:5.54-6.00. H:8¼-8½. It was marketed as *phainite*. → Cubic zirconia.

**DLC**; an acronym for diamond-like carbon.

**D line**; → sodium vapor lamp, Fraunhofer lines.

**dneprovskite**; a Cornish term used for tin ore.

**doblete**; a Spanish term for doublet.

**Dobo pearl**; a commercial term for pearls from Aru Island fished by Dobo pearling center, Australia.

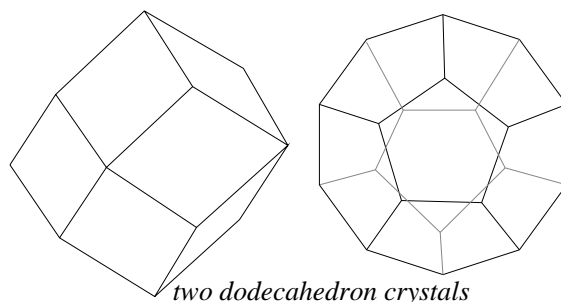
**doctor**; same as doctoring pearls, pearl doctor.

**doctoring pearls**; pearls, which have bad-colored, blemished outer layer, cracks filled, have been artificially colored, or which have been made more spherical by removing certain portions other than an entire layer as in peeling. → Pearl doctor.

**dodecahedral**; pertaining to the rhombic dodecahedron.

**dodecahedral cleavage**: it means cleavage in six planes, parallel to pairs of opposite faces of a dodecahedron crystal in cubic system. Diamond may show such cleavage.

**dodecahedron**; a crystal form having 12 faces of cubic



system, such as the rhombic dodecahedron has 12 four edges each equal length, lozenge-shaped faces.

**dog collar**; a flexible necklace or collar consisting of several parallel arranged strings of gemstones, worn tightly around a woman neck. Also called collier de chien.

**Dogger**; middle Jurassic (above lias, below malm).

**dogger**; a concretionary lumpy mass of calcareous sandstone.

**dogger**; an irregular concrete mass of ironstone.

**dog-leg cutter**; sometimes in the partly drilled pearls, a groove is cut in the side of the hole and at the end of hole is enlarged by mean of a dog-leg cutter. The metal pin of the mount is introduced down into the groove and turned at the bottom so that it can not be pulled out. → Peg.

**dog-stones**; a term used by Australian miners for lumps of sandstone, which are hanging down centimeters from the roof.

**dog-tooth pearl**; tusk-like or an elongated sharply pointed baroque pearl, typically from Mississippi,

USA.

**dog-tooth spar**; a type of calcite of scalenohedron prism crystals, giving a sharply pointed aggregate like a canine tooth. Also called hogtooth spar.

**dog's tooth crystals**; rhombic dodecahedral forms with over-developed become long thin crystals, which are curved slightly and have one end blunt and the other pointed, resembling a dog's tooth.

**dolente**; same as rhyodacite.

**dolerite**; latter synonymous with American usage of diabase.

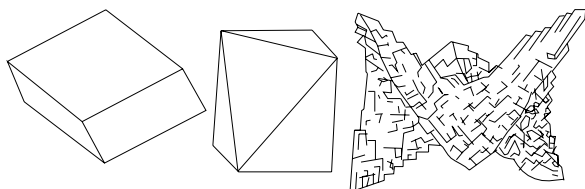
**dolerite**; same as coarse basalt.

**dolerite**; a term used in the USA for a dark igneous rock in which minerals are not determinable megascopically.

**dolin**; same as sink-hole.

**dollar value**; in pearl trade same as the once.

**dolomite**; a common rock-forming rhombohedral mineral from carbonate group, which is used for large objects. It is prized by collectors. Massive variety misnomerly known as *dolomite marble*. Banded material in red, yellow, green brown, and white from



*dolomite crystals and right: saddle shaped*

north America is misnomerly as *wonderstone*. Frequently faces of dolomite crystal are curved and some of them so acutely as to form a saddle-shaped crystal. Also called picrite, rhombic spar, miemite, taraspite, or pearl spar. → Ankerite.

System: hexagonal.

Formula:  $3[\text{CaMg}(\text{CO}_3)_2]$ .

Luster: vitreous to pearly.

Colors: colorless, white, grayish, pale brown, greenish, pinkish.

Streak: colorless.

Diaphaneity: transparent to translucent.

Cleavage:  $\{1011\}$  perfect.

Fracture: subconchoidal. Brittle.

SG: 2.85-2.95.

H:  $3\frac{1}{2}$ - $4\frac{1}{2}$ .

Optics;  $\omega$ : 1.691,  $\epsilon$ : 1.501.

Birefringence: 0.190. ⊖.

Source: Spain, Brazil, Australia, USA (Kona, Michigan), and widespread.

**dolomite lime**; lime containing 30-50% magnesium and

70-50% calcium oxide. Also called dolomite limestone, dolomitic limestone, dolomitic lime.

**dolomite limestone**; same as dolomite lime.

**dolomite marble**; a misleading term for massive variety of dolomite used for ornamental purposes, while the stone takes good polish.

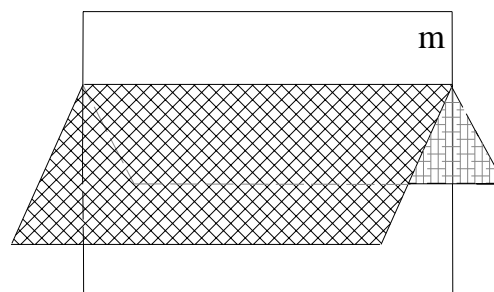
**dolomitic lime**; same as dolomite lime.

**dolomitic limestone**; same as dolomite lime.

**dolomite, saddle shaped**; → saddle shaped dolomite, dolomite.

**dolostone**; a term applied to sedimentary dolomite rock in order to avoid confusion with usual dolomite mineral.

**dome**; an open hemispherical crystal form consisting of two nonparallel faces that intersect along and astride a



symmetry plane, regardless of the orientation of the line of their intersection. Also called pinacoids, and domes.

**dome**; same as a high cabochon cut.

**dome**; in geology a mountain having a smoothly rounded summit of rock, that resembles a dome, such as salt dome, volcanic dome, tholoid and lava dome.

**domes**; same as dome.

**domeykite**; an opaque, tin white to steel-gray copper arsenate mineral of  $16[(\text{Cu}_3\text{As})]$ . Metallic luster. Fracture: uneven. SG: 7.2-7.9. H:  $3\frac{1}{2}$ . Quickly tarnishes in air. Reniform or botryoidal aggregate. Found in Michigan (USA), the Czech Republic, and Iran. Prized by collectors as cut gems. → Mohawkite, algonite.

**domatic**; a horizontal prism in relating to a dome.

**dominate eye**; person who has one eye that is stronger than the other is, this can affect color grading of diamonds.

**Domitian emeralds**; a term means resembling Domitian Roman Emperor in appearance, used for particular cruel green color emerald or beryl, allegedly due to immersed in oil to darkened the color.

**Doña Juana de Zuniga**; → Cortez Emeralds.

**donnayite**; new mineral name:  $\text{Sr}_3\text{NaCaY}(\text{CO}_3)_6 \cdot 3\text{H}_2\text{O}$ . Triclinic crystal.

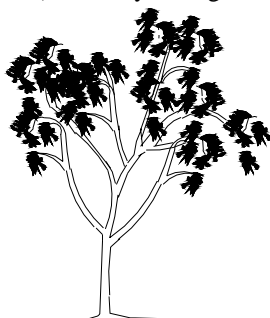
**donnayite**; a not approved name for a  $\text{Fe}^{3+}$  tourmaline with  $\text{Al}_2\text{O}_3$ .

**donor**; in Type Ib diamonds presence of nitrogen atoms

with 5 outer electrons in the stone structure acting as donors and, which induce the yellow color, while the light is absorbed in the violet region. Also called *canary diamonds*, or Type Ib diamonds. → Type Ia diamonds.

**donor-acceptor dyes;** charge transfer color is seen in iodine and other compounds in a solvent can give an electron to benzene  $C_6H_6$  system, which is an acceptor. A mineralogical sample is graphite a allotropic form of carbon.

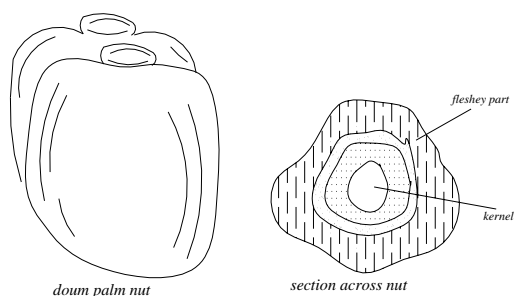
**doom palm;** a variety of vegetable palm nuts ivory used



*doom palm-tree of vegetable ivory. After Webster 1994*

as imitation of ivory are the hard nuts of certain palm tree of *Hyphaene thebaica* found in north and central Africa. Also spelled doom palm.

**doom palm nut;** the fruit of doom-palm, which is used as vegetable ivory, has the shape of a fattened kernel of a Brazil nut, each nut is as large as a hen's egg of



*doom palm nut section across nut doom palm nut vegetable ivory*

reddish-brown skin. Also known as doum-palm ivory. The palm is often called *gingerbread palm*. RI:1.54. SG:1.38-1.40. H:2. Under ultraviolet light, it glows whitish-blue. Also spelled Doum palm nut.

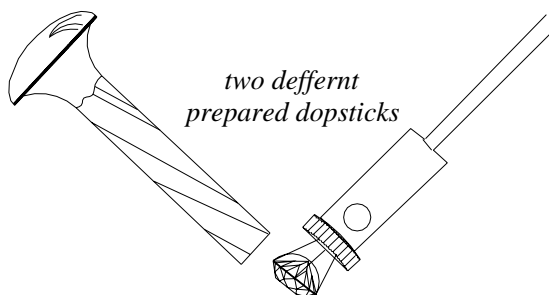
**Doornbult;** location of a small alluvial diamond mine in Transvaal District, South Africa.

**Doornkloof;** location of a small alluvial diamond deposit in Barkly area, Cape Province, South Africa.

**Doornlaagte;** location of an alluvial diamond mine in Barkly area, Cape Province, South Africa.

**dop;** solder, any copper or brass cup with a malleable copper or wooden holder filled with low-melting-point lead-tin, in which a gem or diamond is soldered to be held during sawing, bruting, or polishing, and it has a

soft copper tail. . Also called cleaver's stick. → Tang. **dop;** mechanical, a device, in which the small diamond is held between steel jaws, while enabling the gem to be



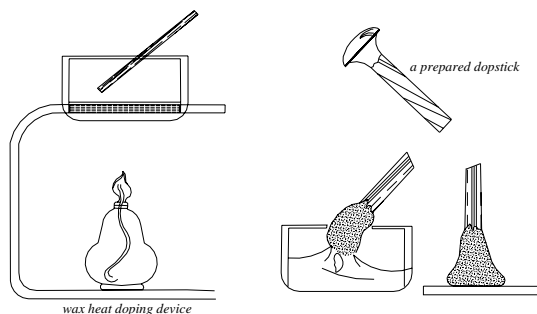
*two deffernt prepared dopsticks*

semi-automatically adjusted without re-setting. Also called cleaver's stick.

**dopants;** crystals with narrow band-gap known as dopants. → Idiochromatic.

**doped;** adding a minute amount of some element as an impurity during a melt to achieve the desired properties such as electrical behavior in production of synthetic corundum, YAG, scheelite, industry glasses, etc. → doped synthetic beryl.

**doped semiconductor diamond crystals;** those diamond crystals of Type IIb, which contain boron atoms and sometimes nitrogen and are semiconductors. Boron atom has one less electron than carbon atoms. When boron replaces carbon, an *acceptor* level is formed with a hole for each boron atom, which causes electroconductivity and the natural blue coloration in diamond such as Hope Diamond. Also in synthetic blue diamond boron compound is added. Irradiation with electrons causes the same effect due to presence of



*preparing a dopstick of gemstone*

color center in crystal. → Color,-definition.

**doped synthetic beryl;** → synthetic beryl,-doped.

**doping stick of stones;** a vertical rod holding a piece of hardwood capped metal in the form of a quasi cone, which is used by a lapidary to anchor one end of the gem stick or gemstone holder with a special faceting wax.

**dop marks;** a minute burned mark on the surface of a

polished diamond caused by the overheating of the claws of mechanical dop. → Burn marks.

**doppie;** → doublet.

**Doppler effect;** → red shift.

**doré;** an alloy consisting of silver, gold, and certain base metals as impurities.

**Dortfontein farm (Du Toit's Pan);** same as Dutoitspan mine.

**dot agate;** a variety of white chalcedony with round, colored setters.

**dot inclusions in Kashan rubies;** a term used for dotted rows arrangement of small particles as inclusions in Kashan synthetic rubies, which appeared similar to a dot or resemble a dash. → Dash inclusions in Kashan rubies.

**dot-ring test;** a test to distinguish an unmounted brilliant-cut diamond from its simulants. For this purpose, make a black dot on a sheet of white paper. The cut stone is placed with the table facet down on the dot symmetrically under its culet. When the stone is an imitation and has lower optic properties than diamond, the dot will appear as a black ring. Diamond, fabulite or rutile produces no ring. Fabulite and rutile can be distinguished from diamond by their dispersion or fire.

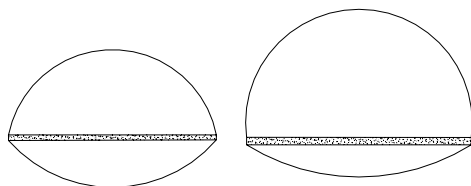
**double-bar;** a term used by Australian miners for a stone usually thin containing two bars or more of opal color ran through each stone.

**double circle goniometer;** → goniometer.

**double bevel cut;** → bevel cut.

**double brilliant;** → double-cut brilliant.

**double cabochon;** a lentic-shaped cabochon or a convex top and base cabochon is called double cabochon. Also



*double cabochons*

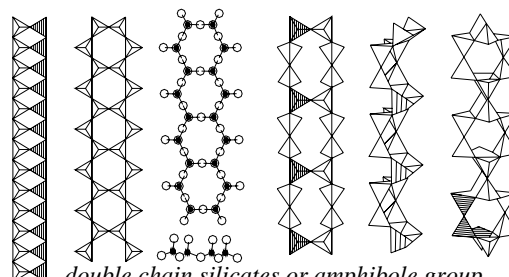
called cyma.

**double cameo;** a cameo with carved motif on both sides of the same stone or mineral.

**double chain silicates;** a group of silicate structures, in which the  $\text{SiO}_4$  tetrahedral may link into linear single or double chains  $(\text{Si}_2\text{O}_7)^{4-}$  of indefinite lengths by the sharing of oxygens of indefinite length, the ends, of which are at the surface of the crystal. Double chain or band such as amphiboles.

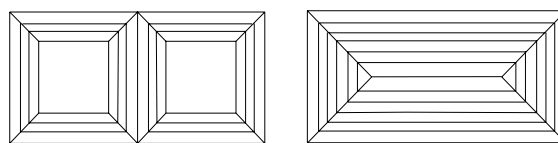
**double color diamond;** a diamond, which is one color in day-light and another color in artificial light. Also called fluorochromatic.

**double-convex lens;** same as biconvex lens.



*double chain silicates or amphibole group of inosilicate  $(\text{Si}_4\text{O}_{11})_6$*

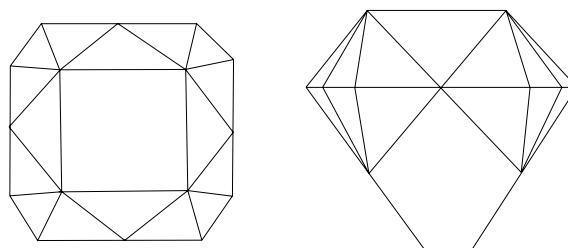
**double-crown step-cut;** a modified fancy cut with four steps double square crowns. The pavilion has six



*double-crown step-cut*

oblong steps.

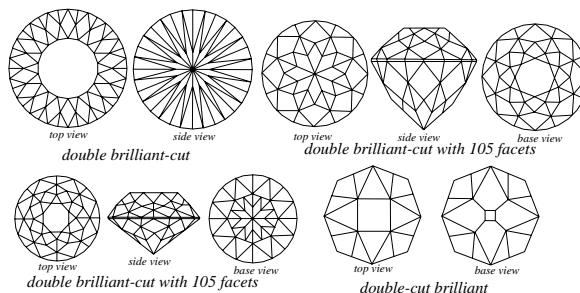
**double cut;** an old cut double square cut with 16 triangular facets and a 4-sided table in the crown and 20



*double cut*

triangular facets and a culet in the pavilion.

**double-cut brilliant ;** a cut form that is believed to have



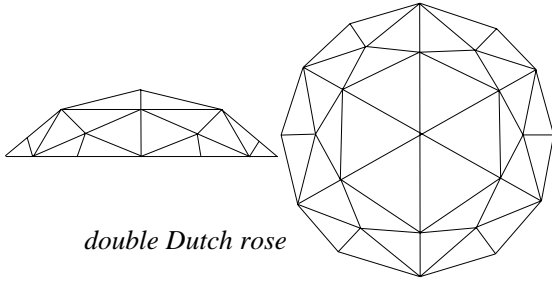
*three kinds of double brilliant-cut*

been developed by Cardinal Mazarin in the 17<sup>th</sup> century. It is similar to the cushion-shaped cut with

*double Dutch rose – double refraction*

nearly equal cut forms of both parts of brilliant such as crown and pavilion. (16 facets and table on the crown and 16 facets and a large culet on the pavilion). Also called double brilliant.

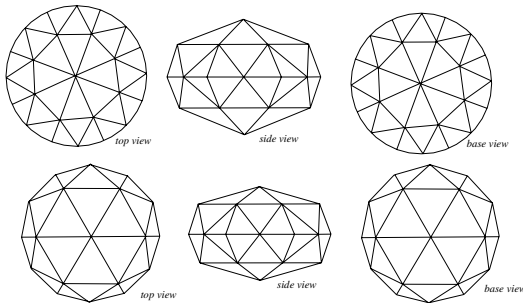
**double-Dutch rose;** a Dutch cut stone of spherical shape



*double Dutch rose*

covered all over with thirty-six facets usually triangular in shape. Also called double rose cut, double-Holland rose cut.

**double-Dutch rose cut;** a Dutch cut stone of double spherical shape covered all over with 24 facets usually

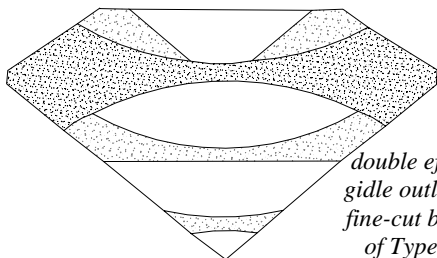


*two different kind of double Dutch rose-cuts*

triangular in shape in both crown and pavilion. Also called double rose cut, double-Holland rose cut.

**doubleeering;** a Dutch term meaning an iridescent flaw in form of an extension within a diamond of girdle facets, and gletz or gelts: a featherlike cleavage parallel to the surface, which closes it.

**Doubledipity Diamond;** a medium yellow, rough diamond of 32.99 found in 1987 in California, USA. It consists of 7 intergrown cubes. Present owner unknown.

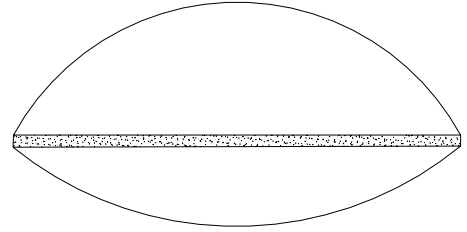


*double effect of girdle outline in a fine-cut brilliant of Type II. After Klupeppelberg*

**double effect on fine-cut brilliant;** an effect can be

seen in fine-cut brilliant of Type II when observed through the table in base part of stone may be seen two mirrors of girdle the percentage and largeness of bellows part is important for sloping of main facets in the crown.

**double-flat cabochon;** a flat lentil-shaped double



*double flat cabochon*

cabochon or a convex top and base cabochon is called double cabochon.

**double-Holland rose cut;** same as double-Dutch rose cut.

**double-English square cut;** → English square cut.

**double-image microscopy;** → double-image prism.

**double-image prism;** any optical prism made of Iceland spar, which produces double images of an object of equal intensity but polarized at right angles to each other. Used in double-image microscopy.

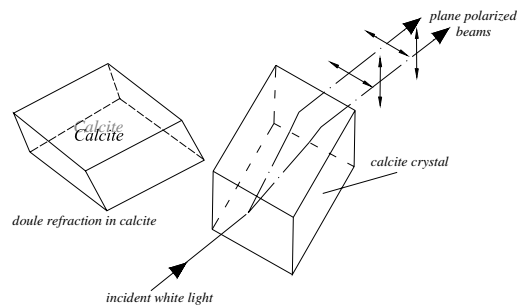
**double-mirror method;** a hollow needle that has two mirrors included at 45° to the length of the needle and at 90° to each other used to test the difference between cultured pearl or natural pearl.

**double oblique crystal;** less used term for triclinic system.

**double pearl;** pearl, which is grown of two pearls united under a nacreous coating.

**double-refracting spar;** same as Iceland spar.

**double refraction;** refraction and separation of an electromagnetic wave shown by certain crystals that split the single incident ray into two refracted rays. The two rays then vibrate at different velocities and are polarized in perpendicular planes to each other. These components are termed the *ordinary ray*, where the



*double refraction in calcite crystal*

wavefronts are spherical so that the normal laws of refraction are retained, and the next one is

*extraordinary ray*, where the wavefronts are not spherical so that the velocity is dependent on the direction of propagation. Double refraction is caused by all crystals, except those of the cubic system, such material is called anisotropic or doubly refractive media. Double refraction will not see along any direction parallel to an optic axis, or when viewed at right angles to such an axis. This effect has been used in polariscopes, dichroscopes or crossed Nicols. When light travels through a Nicol prism or a polarizing plate all its vibrations are in a parallel plane and it produces *plane polarized* light in contrast to *unpolarized* light. The polarization of the two rays is also in doubly refractive material seen. → Birefringence, polarization of light, anomalous double refraction.

**double refraction, anomalous;** → anomalous double refraction.

**double refraction calcite;** → calcite, double refraction.

**double refraction detection;** double refractive can be detected numerically by all minerals, which crystallize in systems other than the cubic system as the difference between the least and greatest refractive indices for the gem.

**double refraction measurement;** double refractive is measured numerically on the refractometer and is due to double refraction.

**double rose;** a cut form of symmetrical shape covered all over the hemisphere with twenty-four facets disposed triangular in shape, it may be assumed to be two rose-cut stones base to base. Also called double rosette, double rose cut, Dutch rose. → Double Dutch rose cut.

**double rose cut;** a rose style that consists of two pieces of dome-shaped full-Dutch rose cut in a circular-girdled diamond without a table and culet and having a total 48 triangular facets, which are jointed together base to base. Often the heights of each top may be not equal such as drop-shaped cut. Also called full Dutch-cut rose. → Double rose, double-Dutch rose cut, rose cut, and double rosette.

**double rosette;** same as double rose.

**double salt;** any compounds of two normal salts, such as dolomite.

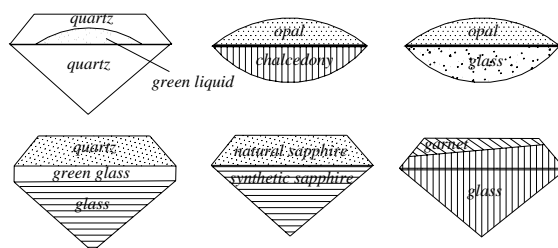
**double scissors cut;** a cut style of gemstones consisting of a double set scissors cut. → Scissors cut, cross cut.

**double spar;** same as calcite

**doublet;** same as an *assembled stone* or *composite stone*.

A gem constructed of two or more pieces (triplet, etc.) of material, which may be or may not be genuine crystal or simulated crystal cemented or otherwise joined together. Usually intended to obtain a larger stone and appear as a piece of natural mineral. Here are some general varieties of doublet: (a) *True doublet*; composed of two sheets of the same natural stone and

quality being cemented together at the girdle, owing a large stone. Often cemented two pieces of natural ruby, diamond, jadeite, etc. Also called *genuine doublet*. (b) *Semi-genuine doublet* the crown or upper sheet consisting of a genuine stone like quartz, beryl, almandine, or other inexpensive natural stone and the bottom part of colored or colorless of less valued natural stones, glass or paste due to the color by refraction. Such stones like diamond doublets mounted as *gypsy setting*. (c) The crown or upper sheet is made from imitation gemstone and the base part being of colorless or colored natural stone, imitation material, glass or paste, which is names *imitation doublet*. (d) The upper sheet is made from imitation gemstone such as synthetic beryl, and the base part being of the same piece of genuine gemstone. (e) *False doublet*: the crown or upper sheet and the base part being of



doublets

colorless or colored imitation material, such as glass or paste, which are joined together with a suitable colored gel or glass. Or the crown is a true quartz cemented with a green or other colored paste to imitate other stones as emerald, sapphire, etc. (f) Sometimes a doublet is a *counterfeit cameo*, which consists of two pieces, with carved glass on top and the lower part chalcidony. (g) *Opal doublet*; consists of a thin film of genuine opal mounted on an inferior quality of opal, black paste, black onyx. (h) Doublets created as counterfeits, are introduced under a commercial term for example smaryll. (i) *Hollow doublet* composed of a crown of glass or quartz crystal, which is hollowed out below and the polished cavity is filled with a colored liquid, which is cemented to the pavilion of the same material as the crown. All assembled stones can be easily distinguished from genuine stone, when they are immersed in water, di-iodomethane, or mononaphthalene that causes the join to be revealed by different light refraction. The term *doppie* was used by Cellini to describe a doublet. → Assembled stone, doublet,-emerald, triplet.

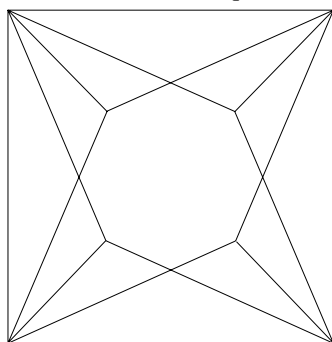
**doublet;** the term doublet is also used for closely spaced lines in emission or absorption spectra.

**doublet;** a term used in Australian for opal-doublet.

**doublet, amber;** → amber doublet.

**doublet, abalone;** an attractive form of doublet composed of a thin layer of shell covered with rock crystal, but not been offered commercially.

**double table;** a modified square four-star cut with 16



*double  
table-cut*

facets and an eight-sided table on the crown.

**doublet, beryl;** consisting of a crown and pavilion of natural pale emerald or beryl jointed by a third layer of green glass or gel (triplet). Smaryll is a commercial term for a doublet consisting of two pieces of aquamarine cemented with a green gel, distinguished by negative crystals or canals.

**doublet, cameo;** a counterfeit consisting of a portion of cameo and cemented on to the base often from chalcedony, occasionally made of porcelain. → Doublet, intaglio doublets.

**doublet, diamond;** usually composed of a crown of diamond cemented to a base or pavilion of white rock crystal, synthetic sapphire, or glass. Such doublets show a curious reflective effect on the edges of the table facet, when looking down on the table facet. → Doublet, doublet diamond.

**doublet, emerald;** usually a composed stone with a crown of beryl or pale emerald cemented to a base or pavilion of beryl or poor quality emerald cemented to a transparent emerald-green duroplastic. Also called *smaryll*. In so-called soldered emerald or *émeraude soudée* a crown of beryl or pale emerald and base of rock crystal are cemented by a transparent emerald-green plastic.

**doublet, false;** an assembled stone where the crown consists of rock crystal or other colorless stone cemented to a suitably colored glass as base. → Doublets.

**doublet, garnet-toped;** → garnet-toped doublet.

**doublet, genuine;** → doublet,-true.

**doublet, hollow;** → doublet (hollow doublet).

**doublet, intaglio;** → intaglio doublets.

**doublet, imitation;** an assembled stone. → Imitation doublet.

**doublet, jadeite;** rarely the stones are composed of up to three pieces, a hollow, polished cabochon of fine transparent white jadeite, a green dyed (with jelly-like

dyestuff of Imperial green color) cabochon of smaller size of the same material cut to fit into the hollow cabochon, and a flat piece enclosed the back. Also called jadeite triplet.

**doublet lens;** same as doublet loupe.

**doublet loupe;** an assembled lens system, which has been corrected for spherical or chromatic aberration or both. Also called doublet lens. → Aberration, aplanatic loupe, loupe corrected.

**doublet, mosaic;** → mosaic doublet.

**doublet, moss agate;** → moss agate doublet.

**doublet of two synthetic stones;** → doublet,-synthetic.

**doublet, opal;** → opal doublet.

**doublet, quartz;** → quartz doublet.

**doublet, sapphire;** usually composed of a crown of cabochon cut sapphire cemented to a base or pavilion of sapphire, synthetic sapphire, or glass. → Doublets.

**doublet, semi-genuine;** when a piece of genuine mineral of the stone forms the crown of an assembled stone and this is closed to a pavilion cut from a less valued stone, or even glass is called semi-genuine doublet, such as diamond doublet. → Doublets.

**doublet, soudé-types;** a term applied for assembled of two pieces of quartz used for crown and base, which is cemented by a transparent emerald-green gelatin or plastic or sintered glass. In so-called soldered emerald or *émeraude, soudée* the crown is made of beryl or pale emerald and base of rock crystal are jointed by emerald-green cement. → Quartz doublet.

**doublet, spinel;** a stone consisting of two pieces of colored synthetic spinel forming the crown and other stone such as rock crystal to the base closed by colored or colorless cement.

**doublet, star;** → doublet, star rose quartz

**doublet, star rose quartz;** the poly-rayed star of rose quartz is not very strongly marked but the effect can be enhanced in doublets, in which a cabochon cut of asteriated pale rose quartz is provided with a blue colored mirror base or reflected base (epiasterism). The best effect obtained by transmitted light (diasterism) provided with mirror at the back. Also called doublet, star, and star rose quartz doublet. → Doublets.

**doublet, synthetic;** a type of composite stone, in which the crown of synthetic colorless spinel or sapphire and a base of colorless strontium titanate (so-called *fabulite*) are jointed together. Usually made to simulate diamond. Also called doublet of two synthetic stones.

**doublet, synthetic spinel;** a type of soudé stone, in which the crown and base are made from colorless synthetic spinel to simulate diamond, which is known as *soudée sur spinelles*. These stones are made in diverse colors. Also called synthetic spinel doublets. RI:1.73. SG:3.66-3.70.

**doublet, true;** same as genuine doublets, in which both



pieces (crown and base) are being cut from similarly colored stones of the same species.

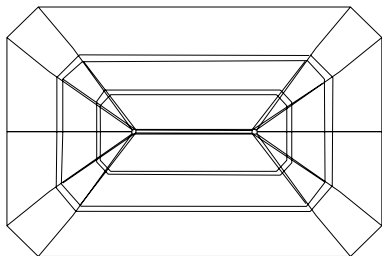
**doublet, turquoise;** → turquoise doublet.

**doublet, types;** the variation of doublets are very diverse such as true doublet, diamond doublet, quartz doublet, soudé emerald, synthetic spinel doublet, garnet-topped doublet, etc.

**doublets;** same as doublet. A composite stone consisting wholly or in part of genuine gemstone.

**doublette;** a French term for doublet, etc. Also called type of doublet- or composite stones.

**doubling of back facets;** when looking through the table facet of a brilliant cut zircon with a lens, it is noticed that instead of a single sharp line appearing a



*doubling of the edges of an emerald-cut peridot, when viewed through the table*

double line of the back facets can be seen. → Doubling of the opposite facets, doubling of facets edges.

**doubling of facets edges;** same as doubling of the opposite facets, doubling of back facets.

**doubling of the opposite facets;** scratches, facet edges, or other figures seen as double, when observed through a doubly refractive crystal. Also called doubling of facets edges. → Doubling of back facets.

**doubly refractive;** adjective of or possessing the property of double refraction.

**doubly terminated crystals;** in mineralogy the occurrence of crystals on both ends as a disseminated



*doubly terminated beryl crystal*

crystal such as quartz from Herkimer County, New York, USA, which contain black petroleum as inclusions. Doubly terminated crystals are hemimorphic. → Termination.

**doubly terminated elbaite;** a pale red elbaite of 1 meter

long from Minas Gerais, Brazil. Present whereabouts unknown. Also called floaters.

**doom palm;** same as doom palm.

**doom-palm ivory;** a vegetable ivory like corozo-nut. RI:1.54. SG:1.38-1.40. H:2, it has nearly the same refractive index and hardness as corozo-nut. → Doom palm ivory.

**doom-palm nut;** same as doom palm nut.

**Douros flux-grown synthetic ruby;** a flux method of producing synthetic red colored corundum by Douros Company.

**Dowagiac diamond;** a rounded hexagonal diamond crystal of 10.87 cts, found in 1895 near Dowagiac, Cass Co., Michigan, USA.

**D. R.;** abbreviation for double refraction.

**drag line;** a polishing flaw caused by foreign material in the diamond powder or minute detritus being pulled from an inclusion by the rotation of the lap, usually drawn from a surface crack in the stone. Drag lines are seen only on one side of the inclusion.

**Dragon Lord Ruby;** same as Gnaga Boh Ruby.

**dragonite;** a misleading term for rock crystal from Galicia. → Dragonite.

**dragon finial;** → finial.

**dragonite;** rounded alluvial quartz pebble or a quartz crystal, which is dull and has lost its angular crystal form that was formerly believed to be a fabulous stone obtained from the head of the flying dragon. Also misnomerly spelled dragomite.

**dragon teeth of pearl;** a term applied to some dragon-teeth shaped of cultured pearl, which produced the shapes of cubes, triangles, cruciform, and dragon-teeth. Some pieces of these fancy-shaped pearls are not attractive which is ground up for medicine purposes or as tomb pearl.

**drakonite;** not recommended term for Drachefels trachyte, Germany.

**dravite;** a brown, magnesium-rich variety of tourmaline, formula:  $3[\text{NaMg}_3\text{Al}_6(\text{Si}_6\text{O}_{18})(\text{BO}_3)_3(\text{OH},\text{F})_4]$ . Optics;  $\omega$ :1.634-1.661,  $\epsilon$ :1.612-1.632. Birefringence: 0.021-0.029.  $\ominus$ . Dispersion weak. Dravite occurs as little radiating tufts along twinning planes in albite or in albite crystal as isolated needles. → Tourmaline.

**Dravite;** a brown tourmaline of 11.5 kg from Yinnietharra, Australia. Found in 1977? Present whereabouts unknown.

**dravite-schorl series;** a term used for ferroschorlite, which consists partly of dravite and schorl series of tourmaline family.

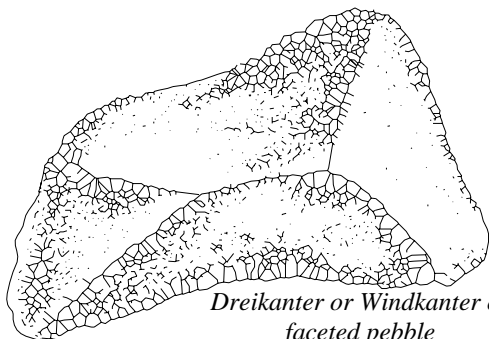
**draw;** a term used for the phenomenon of color saturation of diamond with a tinge of color particularly yellow or another color is said to *draw color*. A large parcel of diamond stones will draw more color, which will appear more deeply colored, than a group of stones

of half the number.

**drawn-amber;** same as scoop stone.

**draw tube;** same as body tube of the microscope, which often contains an inner draw tube, it may be raised or lowered for focusing.

**dreikanter;** a German term for a three-edged faceted windworn pebble formed by the natural eolian sandblast action in desert or glacial region with plane



*Dreikanter or Windkanter or faceted pebble*

faces bounded by three sharp edges or angles. Also called windkanter, pyramid pebble. → Einkanter.

**Dresden Diamond;** → English Dresden Diamond.

**Dresden Diamonds;** Dresden Diamond are: Dresden Green diamond, Dresden White diamond, Dresden Yellow diamond mentioned below. The other three diamonds are weighing 29.25, 23.10 and 13.48 cts, are on display at the Museum in the Green Vault at Dresden, Germany.

**Dresden Drop Diamond;** → English Dresden Diamond.

**Dresden Green Diamond;** an apple-green, pear-shaped diamond of 40.70 cts, purchased in 1743 by August the Strong, set in a hat ornament with several smaller diamonds. It is the largest apple-green diamond. Now on display at the Museum in the Green Vault at Dresden, Germany.

**Dresden White Diamond;** a square cut, white diamond of 49.71 cts, with an 8-sided table from India, purchased in 1743 by August the Strong, set in a shoulder knot, it is in the Green Vault at Dresden, Germany. Also called Saxon White Diamond or White Saxon Brilliant.

**Dresden Yellow Diamond;** among the treasures in Green Vault at Dresden, Germany. One of them is a yellow, brilliant-cut diamond of 38.00 cts.

**dresser;** a tool holder that contains a diamond crystal or a lapped diamond, which is used to dress. Also called diamond dressing tool, or impregnated diamond dressing tool. → Single-layer diamond dressing tool.

**dressing;** the term applied to shaping the dimensions of a stone.

**dressing;** cutting face for grinding special contours.

**dressing;** sorting, cleaning, and concentrating of ores for industry.

**drewite;** a term applied to the variety of calcite or calcium carbonate precipitated from sea-water by bacterial action.

**Dreyer's Pan;** location of an alluvial diamond deposit to the north in Namaqualand, Southwest Africa.

**dried gypsum;** same as plaster of Paris.

**driftal gold;** same as alluvial gold.

**driftal gold gravel;** same as alluvial gold gravel.

**drifted gold;** same as alluvial gold.

**drifted gold gravel;** same as alluvial gold gravel.

**drifted limestone;** same as allochthonous limestone.

**drifted sand;** same as eolian sand.

**drifted sediment;** same as eolian sediment.

**drift mining;** the extraction of collapsed ore through a kimberlite pipe, horizontal or inclined tunneling method.

**drift mining;** the exploitation of placers by underground mining.

**drift sand;** same as eolian sand.

**drift scratch;** same as glacial stria.

**drill;** any tool, machine instrument, or other form of apparatus using energy in any one of several forms for making a hole in gem, rock, metal, pearl, wood, or other material.

**drillability;** the specific value or relative speed, at which a material may be penetrated by a drill bit.

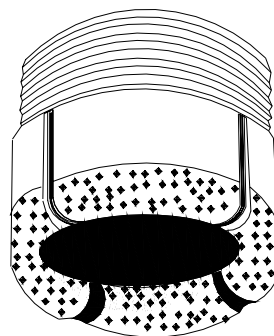
**drill bit;** same as drilling bit.

**drill bort;** same as drill diamonds.

**drill bortz;** same as drill diamonds.

**drill crown;** synonym for drill bit.

**drill diamonds;** any industrial diamonds used in diamond-drill bits. Also called diamond drill, bort, drill



*diamond drill-head*

bortz, drilling bort, bullet, drilling bortz, drilling diamonds, drillings.

**drilled pearl;** same as drilling pearls.

**driller fluid;** same as drill mud.

**driller mud;** a heavy suspension, usually aqueous, sometimes oil used in rotary drilling. Also called drilling fluid, mud flush, drill mud.

**drill hole;** a tube like drill hole introduced from the surface of a flawed diamond by means of laser beam to

eliminate the carbon spots then have been filled with epoxy or glass to conceal them. Not easily visible to the naked eye. But examination of a glass or epoxy filled diamond under rotated dark-field illumination, nearly parallel to the plane of the crack the interference flash effect can be seen. → Filled diamond.

**drilling**; a classification of diamond, which includes industrial diamonds, used in diamond-drill bits. Same as drill diamonds or drilling diamonds.

**drilling**; incorrectly used as a synonym for cuttings.

**drilling**; the act to make a circular hole with a drill.

**drilling beads and hardstone**; for the drilling of the string holes of beads or hardstones and for the loops of the pendants the bow-drill may be used.

**drilling bit**; cutting tools used to cut circular hole in rock, wood, metal, etc. Also called drill bit. Also called drilling crown in England and Africa.

**drilling bort**; same as drill diamonds.

**drilling bortz**; same as drill diamonds.

**drilling crown**; synonym for drilling bit.

**drilling diamond**; same as drill diamonds.

**drilling fluid**; a term refers to all fluids used for drilling.

Fluids include gas, air, water, oil and mud.

**drill head diamond**; → drill head diamond.

**drilling of amber**; the process of drilling a hole in amber by means of a drilling bit with the hand or electric bead drill for any purpose. Amber tending to craze when it is subjected to extreme heat during the drilling process because of low melting point of amber.

**drilling of cultured pearls**; → drilling pearls.

**drilling of natural pearls**; → drilling pearls.

**drilling of rock**; the process of drilling a hole in rock by means of a drilling bit for any purpose.

**drilling pearls**; the pearl is drilled from each end for stringing for necklace or drilled partly through for attachment on a pin or peg for use as button, earrings, rings, etc. Drilling is done with a mild steel wire of 0.3-0.75 mm normally driven by a low-power engine. 0.3 mm drill hole is minimum diameter agreed for use of endscope. Generally natural pearls have smaller, much finer and straighter holes than cultured pearls because weight lost by drilling which mean money lost. Pearls of inferior quality are Chinese drilled. Also spelled for drilled pearl. → Back off.

**drilling tools**; same as drilling implements.

**drills, bow**; → drilling beads and hardstone.

**drill, to**; to make a circular hole.

**drip**; a term used by Australian miners for a pattern of opal or potch with distinctive concentric color changes appears due to forming of different types of opal gel, which is dripped into partially solidified opal.

**dripstone**; a term used for calcite or other carbonate minerals formed in caves by dripping water from roof

which include stalagmites and stalactites deposits.

**dripstone**; the term used to replace cumbersome pair, stalagmite and stalactite. Erroneously spelled drop-stone.

**drippy inclusions in Kashan rubies**; the term used for globule or drop-like inclusions in Kashan synthetic rubies an evidence for synthetic stone.

**drive**; a horizontal tunnel mined in the direction of the strike.

**driver**; an old term was used by Australian miners for who digs in a drive to distinct from sinker.

**drive-on-the-blind**; an informal term used by Australian miners for a tunnel digging through opal dirt because of looking for opal.

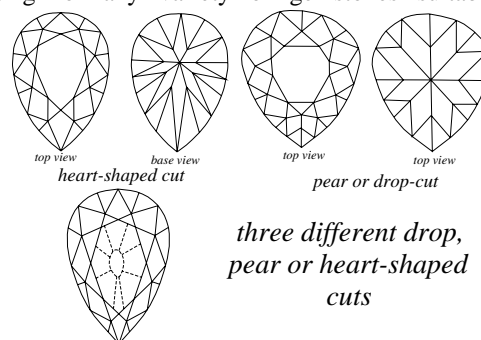
**Droogpan**; location of an alluvial diamond mine in Transvaal Province, South Africa.

**Droogveld Channel**; same as Droogveld Sluit.

**Droogveld Sluit**; very small gravel filled fissure at Droogveld, Vaal River State, South Africa. Also called Droogveld Channel.

**drop**; same as drop form pearl.

**drop cut**; same as pendeloque and briolette. A style cutting for any variety of gemstones suitable for



pendants, earrings, etc. Also called drop-form cut, and drop-shaped diamond.

**drop**; a term used for tear-shaped or small globular drop-shaped piece of amber. The size of drop-shaped ambers or resins varies from a poppy seed to a walnut or bigger.

**drop cut estimator**; → appendices.

**drop-form cut**; same as drop cut.

**drop-form pearl**; a type of pearls having an oval, drop or pear-shape, used for pendants, brooch, earrings, etc. Also called drop pearl, pear pearl, drop-shaped pearl. Frequently they are Chinese drilled. Sometimes called pear-eyes, or pear-shaped pearl.

**drop-pearl**; same as drop-form pearl.

**dropper**; water droppings from the roof or cave roof.

**dropping stones**; same as stalagmites.

**drop quartz**; same as drop-form quartz.

**drop-shaped diamond**; same as drop-form cut.

**drop-shaped pearl**; same as drop-form pearl.

**dropstone**; an obsolete term for stalagmite. Also called dripstone.

**Drude theory**; → band theory in metals.

**Drude-Lorenze theory**; → band theory in metals.

**druggist's pearl**; a misleading term for mytilus pearl.

**drum beads**; barrel or cylindrical shaped beads, which are pierced through the length or side for suspension as a pendant.

**druse**; an irregular small cavity in a rock, vein or mineral, into which euhedral crystals of the minerals filling the rock or vein project with a rough surface, usually with the same minerals as the enclosing rock. → Amygdale, geode, vugh, miarolitic rocks.

**drused**; same as drusy.

**drusy**; Adj. of druse. Pertaining to a druse, or containing many crystal-lined druses. Closely covered with many minute implanted crystals. Also called drused.

**drusy cavity**; same as geode.

**drusy mineral**; mineral with irregular cavities. Also called mineral blossom.

**drusy quartz**; quartz with irregular cavities. Also called mineral blossom.

**drusy structure**; → miarolitic structure.

**dry**; a term used by Australian miners for a dusty opal working level which is usually crumbly or hard with little or no opal in it. Also called dry level.

**dry**; a term used by Australian miners for sifting of opal dirt or mullock, which is treated without water.

**dry**; an old term used by Australian miners for puddler, a device in which opal dirt is broken.

**dry-bone**; → dry-bone ore.

**dry-bone ore**; a term applied to an earthy, friable, honeycombed variety of smithsonite. Or sometimes employed to describe hemimorphite. Also called dry-bone.

**dry diggings**; same as dry alluvial or placer. Placer mines districts of diamonds where water is not available. Also called dry placer. Opposite to *wet diggings*.

**dry diggings (diamond)**; diamondiferous areas in South Africa were found in arid alluvial surroundings and hence were known as dry digging.

**dry disk**; a tool or a machine for finishing the faces of abrasive wheels.

**dry grinding**; any process of particle size reduction carried on without a liquid medium by abrasive action.

**dry ice**; solid carbon dioxide (CO<sub>2</sub>), condensed by pressure.

**dry ice test**; a test to distinguish a glass imitation from other true gemstones. When a crystalline material such as a gemstone is placed upon a piece of dry ice a squeaking noise can be heard. This is not true of noncrystalline substances such as glass and plastic.

**drying cracks**; in ceramics industry a defect occur in



*drying cracks*

enamel characterized by a series of fissure bisque.

**dry level**; another term for dry.

**dry method**; when the host mussels are brought in baskets to the work station wharf about 24 hours before the nucleus is inserted into the oyster.

**dry ore**; an ore, which contains precious metals such as gold and silver but insufficient lead or copper.

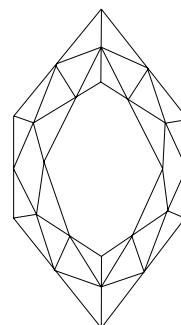
**dry silver ore**; an ore of silver that contains silver but insufficient lead or copper, which requires added lead and flux agents for treatment.

**dry placer**; → dry.

**ducat**; a minute, distorted octahedron diamond where only a table has been polished. Also called duke cut, ducats, dukes, and ducuts.

**ducats**; same as ducat.

**Duchess Cut**; a trade term for a 63 facets fancy-cut diamond derived from the marquise cut. Developed by



*duchess cut*

an Israeli Company.

**duck bone jade**; the term applied by Chinese to describe the color grade of jade.

**ducktownite**; an intimate mixture of the minerals pyrites and chalcocite.

**ducktownite**; a matrix of blackish copper ore containing grains of pyrite.

**ductile**; capable of being fashioned into a new form, or capable of being drawn out into a thread, or being hammered out into thin plates such as gold, copper, silver, etc.

**ductility**; the ability to sustain deformation without fracture and being able to be hammered into sheets or drawn out into wires.

**ducuts**; same as ducat.

**Dudley Diamond**; same as Star of South Africa Diamond.

**duffer**; not a restricted term used by Australian miners for a shaft yielding no opal.

**duffer**; a term used by Australian miners for an area would not expect to find opal in it.

**dugong pearls**; simulant pearls made from the teeth of the walrus or sea cow.

**dugout**; a term used by Australian miners for abandoned working deposit, which has been changed into living quarters.

**dugout**; a term used by Australian miners for a small open cut working shaft.

**dunin**; a gold-washing dish used in Jashpur, India.

**duke cut**; same as ducat.

**Duke of Brunswick**; who bought at a sale in 1874 of jewels the Hope diamond.

**Duke of Devonshire Sapphire**; a sapphire of 100 cts, was reported to belonged to the Duke of Devonshire.

**dukes**; same as ducat.

**duklij**; a local Apache Indian term of highly prized turquoise used as talismans.

**dulang**; a term used by Malayan miners for washing.

**Dulcote agate**; a local term for agate geodes found in marly clay near Dulcote, England.

**dull**; a term applied to the degree of luster of minerals, means lacking or total absence of luster. Also known as dull luster.

**dullam**; a Sri Lankan term for concentrated gem gravel of Sri Lanka, which consists of gemstones. → Illam.

**dullies**; a term used in England by jet cutter to a stage in which skin of beads removed and chopped out across the beads in squares after cushioned the grains were shaped and drilled.

**dull luster**; → dull.

**dullness**; not bright, or intense, clear of color.

**dullness**; lacking normal gloss on the mineral or enamel surface. Also called low gloss.

**dulong**; a term used by Malayan miner's for a conical wood to recover valuable metals from river channels and bars. The conical-shaped wood has a diameter of 31 centimeters with about 150° apex angle.

**Duluth agate**; a local term for agate from Lake Superior, Canada.

**Dumelle's heat-treatment of topaz**; a decolorizing method of topaz. The process consisted of heating topaz in a sand bath to a temperature of 500° C and cooling it in a sand bath, after cooling the color turns to a salmon pink, this is known as *pinking*. This effect was discovered by Dumelle a Paris jeweler.

**dumortierite**; a variety of gemstone of basic aluminum boro-silicate with fibrous masses. It has strong

dichroism. Sometimes it is included in a variety of quartzite, which is called *dumortierite quartz*. It is an ornamental stone and frequently is cut as a gem. It is pleochroic.

System: orthorhombic.

Formula:  $4[Al_7O_3(BO_3)(OH)_3]$ .

Luster: vitreous to dull.

Colors: blue, violet, pinkish, brown, greenish.

Streak: white.

Diaphaneity: transparent to translucent.

Cleavage: {010} good, and {110} imperfect.

SG: 3.30-3.41.

H: 7-8.

Optics;  $\alpha$ :1.686,  $\beta$ :1.722,  $\gamma$ :1.7228.  $\ominus$ .

Birefringence: 0.019-0.035.

Found in Brazil, Malagasy, France, Norway, and Arizona, Nevada (USA), Mexico and Canada.

**dumortierite in quartz**; a massive aggregate, opaque, strong-blue to greenish-blue or violet-blue variety of crystalline quartz, colored by impregnating crystals of dumortierite. Also called dumortierite quartz, or dumortierite-quartz. Sometimes cut cabochon. Found in India.

**dumortierite luminescence**; blue and blue-white to violet luminescence under SWUV.

**dumortierite pleochroism**; black, brown and red-brown. Sometimes blue-black, blue and colorless.

**dumortierite quartz**; same as dumortierite in quartz.

**dumortierite-quartz**; → dumortierite in quartz.

**dump**; a term used by Australian miners for dirt and mullock near shaft, which frequently prospected for opal pieces.

**dumper**; a term used by Australian miners for bucket dumper in which dirt is hauled up for screening washing.

**dune**; a low mound, hill, bank, or ridge of loose drifting sand or granular material heaped by wind.

**dune rock**; an eolianite consisting of dune sand.

**dune sand**; a fine-grained blown sand with well-rounded particles, which has been piled up by the wind into a sand dune. Also known as blown sand.

**dungannonite**; a variety of diorite containing corundum and nepheline.

**dunite**; a coarse-grained, mafic igneous rock consisting essentially of olivine (peridot) only, though chromite is an almost present accessory. Also called olivine rock.

**dunstone**; an amygdaloidal spilitite.

**dunstone**; a local term for certain varieties of granular, yellowish or cream-colored magnesian limestone.

**duparcite**; synonym of idocrase.

**dupa xaga**; a term employed by Pomo Indians of California for a hard variety of obsidian, which is harder than bati xaga.

**Du Plessis Diamante;** location of a diamond deposit near Barkly West, South Africa.

**duplet;** a pair of electrons shared between two atoms.

**duplex refractometer;** a refractometer has a large slotted segment of high-index hemicylinder instead of a hemisphere. Using as auxiliary eyepiece for flat-surface readings. It was the first designed refractometer to read both cabochon and facet. The Duplex, was made by Gemological institute of America. → Refractometer.

**Du Pont-synthese;** a patent process of explosion synthetic hexagonal diamond in correspondent to the compression-shocked made by Du Pont de Neymours & Co. Explosion-synthesized diamonds are normally polycrystalline and are therefore very hard but coarser and contain metallic inclusions.

**durability;** the degree of ability of a gemstone to withstand the effects of abrasion, scratching, impact, and chemical action, etc. The durability of a gemstone depends on chemical composition and both of its hardness and toughness. A mineral may be quite tough but rather easy to scratch, or it may be extra hard but be deficient in toughness because it has easy cleavage.

**dural;** a trade term for abrasive powder from aluminum oxide.

**durangite;** a mineral suitable for gem collectors. Strong pleochroism.

System: monoclinic.

Formula:  $4[\text{Na}(\text{Al},\text{F})\text{AsO}_4]$ .

Luster: vitreous or dull.

Colors: orange-red.

Streak: yellowish.

Diaphaneity: translucent.

Cleavage: {110} distincts.

SG: 3.94-4.07.

H: 5.

Optics:  $\alpha$ :1.634,  $\beta$ :1.673,  $\gamma$ :1.685.

Birefringence: 0.050. ⊕.

Found in Durango, Mexico.

**durite;** a commercial name for a series of phenol-formaldehyde groups, used as grinding wheels, etc.

**duroplaste;** a commercial term for synthetic resin.

**durosol;** a commercial term for abrasive powder from aluminum oxide.

**D'Urville Island;** location of nephritic greenstone occurs *in situ* in D'Urville Island, South Pole.

**Dushan-jade;** a jade-green rock containing mostly plagioclase from Dushan and Nanyan, China. Also called Nanyan-jade.

**dust, diamond;** same as diamond powder.

**dust diamond, assorted;** diamond fragments, which usually weigh 60 per cts, down to 150 per cts. Having a degree of brilliancy used for cheap jewelry without any polishing. Not to be confused with diamond dust.

**dust gold;** very fine gold.

**dust gold;** same as float gold.

**dust-like;** a term used for arrangement of small particles which appeared similar to dust, found in Kashan synthetic rubies.

**dust pearl;** very small seed-like pearls less than  $\frac{1}{25}$  of a grain.

**Dutch bort;** an old and false term for zircon from South African mines.

**Dutch East Indies pearl;** a trade degree for pearls from Dutch East India that is similar to Australian pearls.

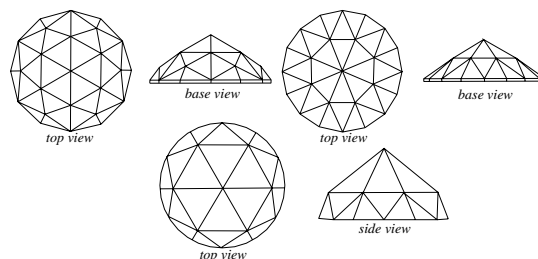
**Dutch gold;** same as tombac.

**Dutch metal;** same as tombac.

**Dutch pink;** → English pink.

**Dutch rose;** same as Dutch rose cut.

**Dutch rose cut;** a modification of the flat-based rose cut of a diamond or other transparent gemstone. Most symmetrical shapes consists of a hemisphere covered with 24 regularly facets, disposed in two steps with 6 triangular facets in the upper row and 18 triangular facets in the lower part and a flat pavilion. Usually have 12 facets in two steps with 6 triangular facets (star facets) in the upper row and 6 triangular facets in the



*Dutch or Holland roses*

lower part (cross facets). Therefore it is a 12-sided or 6-sided cut stone. Usually the highest part of the stone is equal to  $\frac{1}{2}$  of the diameter. It is similar to the Antwerp rose or Brabant rose cut. Also called Dutch rose, full-Dutch rose cut, full Holland rose, crowned rose, Holland rose cut, crowned rose cut. → Double rose cut.

**Du Toit diamond;** location of diamonds from Du Toit or Dutoitspan mine, at Kimberly, South Africa. Are named as Du Toit I diamond and Du Toit II diamond.

**Du Toit I Diamond;** a yellowish, large diamond named Du Toit after the mine, Dutoitspan was found in 1871 and weighed 250 old cts. Also called Oppenheimer Diamond.

**Du Toit II Diamond;** a yellowish diamond named Du Toit after the mine, Dutoitspan was found in 1871 and weighed 127 old cts.

**Dutoitspan Diamond;** an octahedron, pale-yellow large diamond from Dutoitspan mine, found in 1974 and weighed 616 cts. it is exhibited at Kimberly Museum, South Africa.

**Dutoitspan diamond mine;** location of a kimberlite diamond pipe, at Kimberly, South Africa, discovered in 1870. Named for the pan, or natural land basin. Also called Du Toit's Pan (Dutoitspan) mine.

**Du Toit's Pan (Dutoitspan) mine;** same as Dutoitspan mine.

**Dutoitspruit;** location of a small diamond mine, in Transvaal Province, South Africa.

**Dutra Diamond;** same as President Dutra Diamond.

**Dy;** a chemical symbol for the element dysprosium.

**dye;** any natural or synthetic colorant substance, which appears to be a property of the material. It is different from pigment. Also known as dyestuff. There 8000 dyes and pigments in 31 chemical categories with new periodical additions.

**dyed chalcedony;** chalcedonies are artificially dyed in red, green, blue, or black. Black-dyed chalcedony is known as onyx, and blue-daybed as German lapis, or Swiss lapis. Also called stained chalcedony.

**dye-dye interaction;** → solvent dye.

**dyed gemstone;** → dyed stone.

**dyed jadeite;** translucent whitish or yellowish jadeite cabochon of inferior quality, is heated and suddenly cooled to achieved cracks, then placed in blue and yellow organic color agents, after drying it is immersed in molten paraffin to conceal the fractures.

**dyed marble;** → treatment of marble.

**dyed pearl;** pearls are dyed various colors, the staining process being to introduce the color agent into the pearl by way of the drill hole. Such pearls are examined under microscope by moderate magnification shows small concentrations of color or specks in layers near the surface of pearl. These effects are not seen in natural colored pearls. X-ray irradiation on pearl can cause darkening of not desirable effect. → Stained pearl.

**dyed quartz;** → stained quartz.

**dyed quartzite;** artificially red dyed quartzite is sold as *red jade* or *red tourmaline*. Quartzite is easy to dye because the stain penetrates between the grains. Also called stained quartzite.

**dyed stone;** gem materials, which are artificially stained with organic or inorganic coloring agents to improve their color or to imitate a more valuable gemstone. Often pores and fractures of pale colored stones are filled with colorless liquid using under vacuum. Later other chemical or thermal treatments can be applied for example to crackled stone, fire stone, or Indian emerald. Frequently such treatment is commercially carried out on quartzite, which is dyed red and miscalled *red jade* or *red tourmaline*. Stones such as chalcedony, turquoise, topaz, coral, pearls, bones, alabaster, serpentine, opal, jadeite, and nephrite have porous surfaces, which are often dyed various colors.

This treatment is not always permanent. Also called dyed gemstone. → Dyeing, crackled stone, stained pearl, dyed pearl.

**dyeing;** an old and an obvious method of artificially altering or improving the color of a gem material, especially porous stones such as chalcedony, turquoise, calcite, jade, coral, etc., which are easy to stain with an appropriate dye. These stones are dyed: banded agate can be dyed in various colors. Chalcedony can be dyed in various colors after dyeing some specimens are heated. Carnelian stained blue or green, while the green colored stone called *emeraldine*. Banded calcite, which is called *Mexican onyx*. Jasper dyed blue is frequently called *German lapis*, *Swiss lapis*, or *false lapis*. Carnelian red dyed jasper obtained by impregnating in iron nitrate or ferrous sulfate and heat-treating. Green colored jasper, which looks like chrysoprase is stained with nickel or chromium salts, such stone, when treated with hydrochloric acid turns its color to yellow. *Black onyx* is dyed chalcedony, produced by impregnating the stone in sugar solution or glucose, and than treating with sulfuric acid, which produce a black background due to carbonization of the sugar. Some *black opals* are dyed in the same way. → Dyed stone, crackled stone, imperial jade, stained pearl, dyed pearl.

**dyeing pearl;** → dyed pearl.

**dyeing with acetate of copper;** → acetate of copper dye.

**dye solvent;** → solvent dye.

**dyestuff;** → dye.

**dyke;** the British spelling of dike.

**dykelet;** the British spelling of dikelet.

**dynagem;** a misleading commercial term for strontium titanate used as a diamond imitation.

**dynamidon;** a promotion term for abrasive powder made of aluminum oxide.

**dyakisdodecahedron;** → didodecahedron.

**dyscrystalline;** texture of an igneous rock whose mineral grains are too small to be seen without a microscope, refers to the groundmass of a porphyry.

**dysentery;** to combat the dysentery disease, used emerald such as in India to believe holding emerald in beneath the tongue.

**dysluite;** a brownish, manganese-iron variety of gahnite from Massachusetts and New Jersey, USA.

**Dysortville Diamond;** a fine-quality diamond of 4.33 cts, found in 1870, near Dysortville, Mc Dowel Co., North Carolina, USA.

**dysprosium;** a metallic rare-earth element of the Periodic System with the symbol Dy.

**dystome spar;** same as datolite or humboldtite.

**dystomic;** a term employed to minerals having imperfect fracture or cleavage.

# E e

**e**; in optics a symbol for extraordinary rays.

**E**; one of the Fraunhofer lines in the green of the solar spectrum, with wavelength of 527.00 nm, caused by iron.

**Eacret Benitoite**; a flawless benitoite of 7.6 cts, of gem quality, which is exhibited in the US National Museum, Washington. It is the largest benitoite gem quality known. The first purchaser of the stone was called Godfrey Eacret.

**Eagle Diamond**; a rounded octahedral, light-yellow diamond of 15.37 cts, found in 1867 on a farm near Eagle, Waukesha Co., Wisconsin, USA. Also called Waukesha Diamond. Tiffany presented it to the American Museum of Natural History, New York, from where it was stolen in 1964.

**eaglestone**; a concretionary nodule usually of clay ironstone, flint or evidently a quartz pebble about the size of a walnut, often containing a loose stone in its hollow interior, traditionally ancient people believed that eagles took them to their nests to facilitate egg-laying. Often used as an amulet. Synonym for aetites.

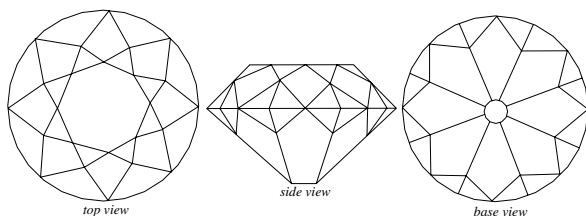
**earle vitriol**; same as double vitriol.

**ear drop**; a small pendant worn by women on the ear.

**early**; occurring near or pertaining to the beginning time segment such as Early Cambrian, Early Devonian, Early Pleistocene, etc.

**early**; same as lower.

**early brilliant-cut diamond**; an earlier brilliant cut used in Europe before the modern brilliant cut. It was round-

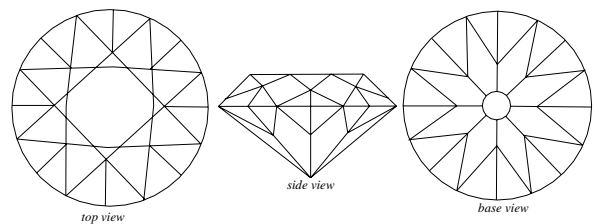


*an early form of brilliant cut*

cut with 32 facets and a table in the crown and 14 facets and a culet in pavilion.

**early brilliant-cut diamond**; an earlier brilliant confirmed by Marcel Tolokowsky before the modern ideal American cut and Tolokowsky theoretical brilliant cut.

**ear of Venus**; same as mother-of-pearl of abalone or ear

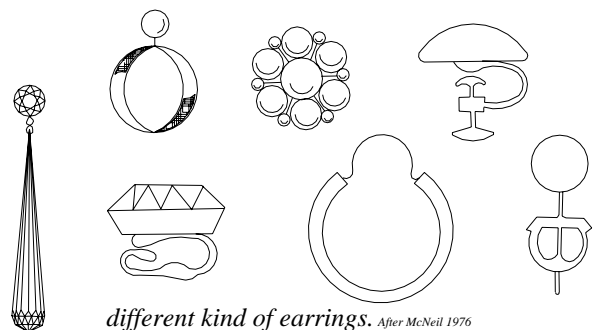


*early brilliant-cut or Tolokowsky-Cut*

shell.

**ear shell**; another term for haliotis (Haliotidae) or abalone.

**earrings**; worn suspended from the ear-lobes as



*different kind of earrings. After McNeil 1976*

ornamental objects in form of buttons, clips, pendant-shapes, spheres, rings, piercing, fashioned stones, etc.

**earth**; a fine-grained substance such as clay or a material resembling clay for sample fuller's earth.

**earth**; a term used in geology for solid materials, which make up the physical globe. → Crust, core and mantle of the Earth.

**earth**; a term used in sedimentology for an organic deposit such radiolarian earth and diatomaceous earth.

**earth**; synonym for earth color.

**earth**; a synonym for ground.

**earth**; in alchemist one of the fourth elements: air, water, fire and earth.

**Earth**; the planet Earth of the solar system.

**earth alkali**; same as base alkali.

**earth amber**; the term applied rarely to distinguish mined amber from sea amber. Earth amber has deteriorated in luster, color, and transparency due to exposure to the air. Also called earth stone.

**earth balsam**; a variety of asphalt from Alsace, France.

**earth foam**; same as aphrite.

**earth color**; a miner term. Used as a pigment, such as red iron oxide. Also called earth. → Mineral pigment, mineral paint.

**Earth core**; same as core.

**Earth crust**; same as crust. → Earth's crust.



**earthenware**; slightly porous, non-vitreous ceramic articles made of ordinary low-fired brick earth, which are coated with glaze.

**earth, green**; a green sedimentary material, generally glauconite. Also called terre verte or green earth.

**earth-like**; same as earthy.

**Earth mantle**; same as mantle.

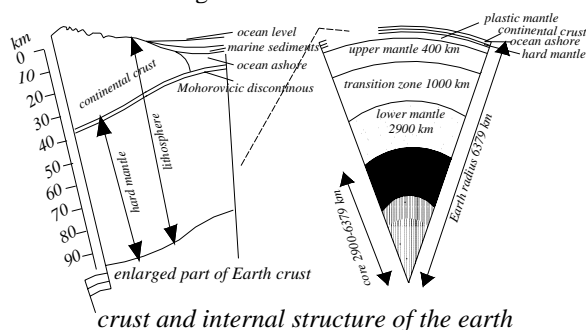
**Earth physics**; same as physics of the Earth.

**earth, rare**; → rare earth.

**Earth science**; a term including sciences related to the Earth.

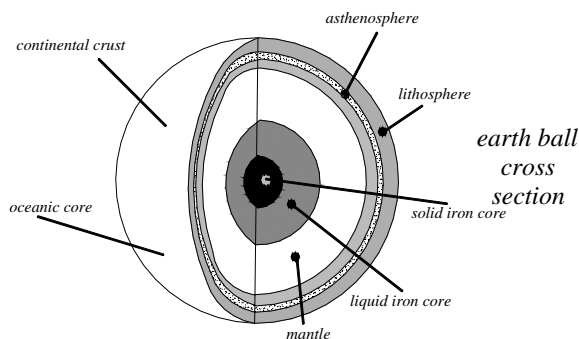
**Earth science**; occasionally misleadingly used as a synonym for geology or geological science, geoscience.

**Earth's crust**; the thin outermost layer or shell of the Earth, it represents less than 1 percent of the Earth's volume. Extending 5km beneath the ocean to 60km



beneath mountains. It separated into two shells, that part of the Earth above Mohorovicic discontinuity, the sial (acronym of silica and aluminum) and sima (acronym of silica and magnesia). The sial apparently confined to the continental masses. Also known as Earth crust, crust of the Earth, lithosphere, geosphere.

**Earth section**; an artificial and theoretical cross section



through the Earth which is divided in a few layers.

**Earth Star Diamond**; a coffee-brown, pear-shaped diamond of 111.59 cts, roughly weighing 248.90 cts, Found in 1967 in Jagersfontein Mine, South Africa. Purchased in 1979 by Baumgold Bros. New York City, USA.

**earth stone**; same as earth amber.

**earth wax**; same as ozocerite.

**earthy**; meaning earth-like.

**earthy**; a term applied to dull luster gemstone, which may be rough to touch.

**earthy**; a type of fracture similar to that of a hard clay.

**earthy base**; same as earth alkali.

**earthy alkali**; same as base alkali.

**earthy calamine**; synonym for hydrozincite.

**earthy fracture**; a fracture resembling a lump of hard clay.

**earthy gypsum**; same as gypsite.

**East African copal**; copals from Zanzibar the hardest are usually used as a varnish.

**East African pearl**; pearls fished on the east coast of Africa, between Zanzibar and Inhambane.

**East Caspian Sea amber**; ambers from this region are pale yellow to yellowish, transparent, soft and brittle.

**East India company**; the company chartered in 1600 by the British government to trade in the East Indies. It was dissolved in 1874. This company possessed most of Indian's gemstones.

**East Oubangui**; location of a diamond mine in the Central African Republic.

**East Turkestan**; a district of China where jade or nephrite occurs.

**eastenite**; a green variety of chrome enstatite-hypersthene.

**Ebelyakh River**; river and location of alluvial diamond deposits in northern Sakha (Yakutia), of the Russian Federation, CIS.

**Ebenhauzer Mine**; location of a small mine in Koffiefontein Area, Orange Free State, South Africa.

**ebonite**; a term used for a hard dark-colored variety of vulcanized India rubber or vulcanite. Obtained by adding sulfur, mercury and antimony. Used sometimes as an imitation jet for mourning jewelry. SG: 1.20-1.80. → Vulcanite.

**eburacum**; a major trade city for jet in Roman Time, which later was named York.

**écaille**; a French term meaning shell sometimes used to describe tortoise shell.

**écaille**; a term applied to unscrupulous dealers for selling imitation tortoise shell.

**eccentric**; displaced to one side with respect to center. Also known as helictite.

**eccentric culet**; same as off-center culet.

**eccentric table**; same as off-center table.

**ecclesiastical ring**; a style of ring worn by cardinals, bishops, abbots, etc.

**echelon grating**; a variety of interferometer similar to a flight of glass steps of constant offset, which replaces the ordinary diffraction grating in spectroscopy with very high resolution, light passing through the device

parallel to the thread of the steps. The number of interfering beams is equal too the number of steps. It can be used as a transmission or as a reflection grating.

**echodolite**; same as phonolite.

**éclat**; the brilliant, splendor or flash of a gem.

**eclogite**; a coarse-grained, deep-seated, ultramafic pyroxene-garnet rock found in South African diamond pipes, may also contain quartz, kyanite, and rutile. Also called E-type.

**ECOMINAS**; an acronym for Empresa Colombiana de Minas, founded in 1958, was authorized to quarry in mine Muzo and by stones from private diggers, cut and sell.

**economic geology**; same as geology of mineral deposits.

**economic mineral**; any metallic or nonmetallic mineral having a commercial value such as gems or ores.

**economy stone**; a grading term that is used infrequently for diamonds of crystal color, or lower and slightly imperfect-to-imperfect.

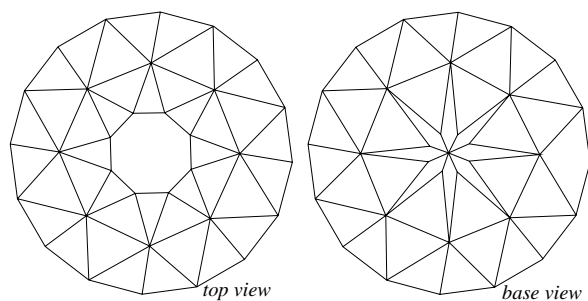
**ectoderm**; the outermost layer in the embryo of a shell or bivalve where the mantle is bounded with its outermost faces to it.

**Edelstein**; a German word for noble stone or precious stone.

**edenite**; an endmember of monoclinic amphiboles. A jadeite-like variety of actinolite. Also called smaragdite.

**edge (crystal)**; an intersection of any two adjacent faces of a crystal. A sharp pointed ridge, also the crest of a ridge.

**edged English-cut**; a modified sixteen edged brilliant cut with 40 triangular facets and an eight-sided table surrounded by an eight-rayed star in the crown. Pavilion has 40 facets by which a four-rayed star



*modified edged English-cut*

surrounded the top of pavilion.

**edge up**; for detecting the faint color of a diamond, bring the stone to a position so that it is being served parallel to the girdle plane and culet.

**edible oyster**; another term for common *ostrea edulus*.

**edinite**; a synonym for prase.

**edisonite**; an obsolete term proposed for a molted blue turquoise.

**edisonite**; an obsolete name for rutile.

**Edith Haggin de Long Ruby**; a star ruby of 100 cts, from Myanmar, (Burma) belonged to the collection of the American Museum of Natural History, New York. Also called Edith Haggin de Long Star Ruby.

**Edith Haggin de Long Star Ruby**; same as Edith Haggin de Long Ruby.

**Edna Star Diamond**; an emerald-cut diamond of 115.00 cts, sold by Harry Winston, New York, in Middle East in 1957. Its previous history is unknown.

**edolite**; a variety of hornfels consisting of feldspar, mica, cordierite, and/or andalusite from Edelo, Italy.

**Edward III, King of England**; father of Edward, Prince of Wales later known as the Black Prince.

**Edward VII, King of England**; the government of Transvaal bought the Cullinan diamond and gave it to King Edward VII of England on his 66<sup>th</sup> birthday, 9 November 1907.

**Edward, Prince of Wales**; Edward, Prince of Wales, the eldest son of Edward III and later known as the Black Prince (1330-1376).

**Edward's Ruby**; a ruby crystal, but not of gem quality of 167 cts, now on display in the Natural History section of the British Museum. It was presented to the museum by John Ruskin in 1887.

**Edward's, Saint, Crown**; a crown used for Edward the Confessor's coronation in 1043.

**Eerstebegin**; location of a small mine in Transvaal Province, South Africa.

**effervesce**; to give off bubbles of gas.

**effervescence**; process whereby small bubbles of gas escape rapidly from a liquid body, the result of a chemical action.

**efficacy**; successful to produce the necessary or desired results in the light production measured in lumens made per watt of electrical energy. In below table some lighting units can be seen.

**efflorescence**; the forming of an incrustation where loss of water takes place at a crystal or rock surface, leaving a fine-grained powdery residue.

**effusion**; the flow of liquid or pyroclastic material from a vent or fissure. Also called volcanic effusion.

**effusive**; in petrology, erupted on the surface of the earth in a molten state and formed by solidification of magma. Synonym for extrusive.

**egeran**; a brown or yellowish-green variety of vesuvianite from Eger in western Hungary.

**egg jade**; a classification used by the Chinese for a particular color of jade.

**egg pearl**; a natural egg-shaped pearl.

**egg pendant**; a type of pendant in the form of a small egg made of gemstones, gold, etc. Suspended from bracelet or necklace.

**eggs, gemstones;** beads of egg-shape. Big eggs made from opaque massive materials cut as ornaments, the smaller ones used for pendants after a hole is drilled.

**egg-shell china;** → egg-shell.

**egg-shell earl;** same as coque de perle.

**egg-shell porcelain;** → egg-shell.

**egg-shell turquoise;** turquoise with little gloss, possessing a matte (no gloss) irregular arrangement of crackled matrix appearance similar to an egg.

**egg-shell;** a type of very thin translucent porcelain. Also called egg-shell porcelain, or egg-shell china.

**egg-shell;** a yellowish-white color.

**Egg-Size Emerald;** a single hexagonal emerald crystal, hollowed out in form of a container and set as a pendant with gold, which is now on display at Topkapi Museum in Istanbul, Turkey.

**eggstone;** a synonym for oolite.

**egg yolk;** yellow, brownish-yellow bastard amber within a transparent mass. Also called kumst amber, kumst colored amber.

**églomisée;** a style of glass etching-technique applied to gold or silver leaf on the reverse of the surface and engraving with fine needle without firing.

**Egrisée;** a French term for diamond dust.

**Egyptian;** Pliny mentioned many gemstones, which were in Egypt in his book.

**Egyptian alabaster;** a misleading commercial term for a variety of banded stalagmitic calcite at Thebes, Egypt, which has been almost continuously worked, and is still called Egyptian alabaster or alternately Oriental-alabaster or onyx-marble, onyx, and onychite. → Alabaster.

**Egyptian amber;** a misleading term for orange to orange-brown, semi-translucent thermosetting or thermoplastic amber imitation from Afghanistan or Middle East, which named as prayer beads and also called Afghanistan amber.

**Egyptian amber artifacts;** some amber and other fossil resin artifacts, amulets and other objects are found in the tomb of Egyptian royalty such as scarabs, royal seals, necklaces, birds and etc.

**Egyptian black;** another term for basalt ware.

**Egyptian blue;** a blue to green, glassy frit consisting of many crystals of  $\text{CuO} \cdot \text{CaO} \cdot 4\text{SiO}_2$ . Used in ancient Egypt and Achaemenid Persian (Iran) to form molded objects and pigment.

**Egyptian emerald;** the term is applied to ancient Egyptian mines of Gebel Sikait, Gebel Zarbara in northern Etbai. The mines were discovered in 1818 and produce cloudy beryl of light color. In regard to color emeralds from Egyptian range from very pale bluish-green to yellowish-green to very rare intense green of good quality.

**Egyptian faience;** a type of glazed stoneware made in

ancient Egypt, from before 3000 BC, in variously shades of green to dark blue. Used as beads, finger ring, necklace, scarabs in various size and forms.

**Egyptian ivory;** most of the so-called Egyptian ivory is actually African ivory, which is imported over the borders of Egypt.

**Egyptian jasper;** the term applied to a variety of brown, yellow, red, black or banded (zoned) jasper occurring in rounded pieces scattered over the surface of the desert, chiefly between Cairo and Red Sea, in contrast to ribbon jasper. Also called Egyptian pebble used for ornamental purposes and brooch-stone.

**Egyptian jasper;** a misnomer for a rounded pebble from beaches in the state of Washington.

**Egyptian jewelry;** → Egyptian jewelry artifacts.

**Egyptian jewelry artifacts;** the great treasures from the tombs of Egypt shows many faceted gems and beads and rough or prepared amber, turquoise, lapis lazuli, pearl, emerald, garnet, carnelian, amethyst, and coral artifacts. Those jewels are made in Egypt from about 3000 BC. The use of gemstones and gold in jewelry as amulet figures and bracelets was common from early periods. The jewelry articles were figures of animals, diadems, head-dress, necklace, pectorals, bracelets, earrings, ear-studs, and anklets. The figures of animals were scarabs, vultures, cobras and hawks. Scarab figures were used in finger rings, seals, and amulets.

**Egyptian marble;** misnomer for a variety of marble stained black with bitumen and veined yellow with dolomite from Italy.

**Egyptian onyx;** a misleading term for aragonite.

**Egyptian pearls;** pearls from Persian Gulf and Sri Lanka, which were marketed through Alexandria, Egypt.

**Egyptian pearls;** cream to yellowish pearl fished from Egyptian coast of Red Sea.

**Egyptian pebble;** synonym for Egyptian jasper of variegated yellow and brown color, which is polished by the sand blown by wind of desert.

**Egyptian peridot;** peridot crystals from St. John's Island in the Red Sea.

**Egyptian shell;** a dark rosy pearl-oyster from Red Sea is called Egyptian shell or Alexandria shell, because before the opening of the Suez Canal it was marketed at Alexandria.

**Egyptian turquoise;** an intense blue, sky-blue to greenish and more noticeably translucent than other turquoise, found on the Sinai Peninsula, Egypt, from, which turquoise has been carried since Biblical times. Also known as alessandrine turquoise.

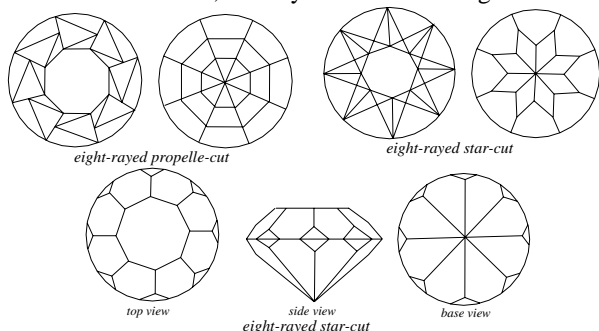
**Egyptian, gemstones occurring in;** famous Egyptian gemstones are beryl, peridot, and turquoise.

**Eickhorst diamond photometer;** → diamond colorimeter.

**ecotourmaline;** a suggested name for a mineral described as tourmaline but contains no boron and being optically biaxial. Also spelled eukotourmaline.

**eight-by-eight;** same as single cut.

**eight cut;** a simple modification of the brilliant-cut of the 17 to 18 facets, usually with a circular girdle used



*three different 8-sided or 8-rayed star cut*

for small *mêlée* diamonds usually under 0.05 cts, with eighteen facets, in which eight triangular facets and very rarely a culet on pavilion, an octagonal table on crown being surrounded by eight bezel four-sided isosceles-trapezoid facets. Pavilion is slightly deeper than crown. Also called eight side cut, eight side brilliant, old English cut, and single cut, or rounded single cut.

**eight side brilliant;** same as eight cut.

**eighth;** same as one eighth of a carat, or 0.125 cts.

**eightling;** the term applied to a crystal twin, either cyclic or interpenetrating, that contains eight individuals.

**eights;** the first eight main facets placed on the diamond, apart from the table and culet, to be grounded by the cross-cutter.

**eights;** same as one eighth of a carat, or 0.125 cts.

**eight-square stone;** same as blocker.

**Eilat stone;** an opaque, green mixture of chrysocolla, turquoise and pseudo-malachite found in King Solomon's Mine near Eilat, Golf of Aqaba, on the Red Sea, Israel. Used as gemstone and is cut cabochon or make tumbling stones. Also spelled Elath stone.

**einkanter;** a German term for windkanter or windworn stone having only one single sharp edge or a face. The face is formed at right angles to the wind. → Dreikanter.

**einsteinium;** a synthetic element of the Periodic system with the symbol Es.

**Eisenhower Diamond;** a diamond of 3.11 cts, found in 1957 in Murfreesboro, Arkansas. The name was chosen because it resembled the profile of a former US President Dwight D. Eisenhower caricature.

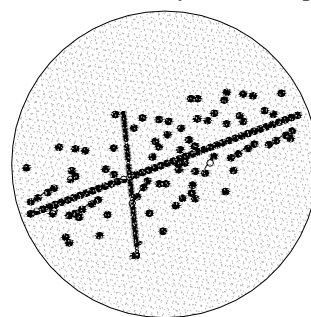
**Eisenhower Sapphire;** A rough, dark blue star sapphire of 2,097 cts, found in 1948 in Anakie, Queensland, Australia. Was carved the bust of former US President Dwight D. Eisenhower, after carving weighed 1,444

cts, A star is visible at the base of the neck. This stone, together with those of Presidents Lincoln, Washington and Jefferson and the Black Star of Queensland, were presented as a gift to the American people in 1957 by the Kazanjian Foundation of Pasadena, California. It is presently on display at the Smithsonian Institution, Washington, D.C., USA. → Lincoln sapphire, Washington Sapphire, Jefferson Sapphire, and Black star of Queensland.

**eisenkies;** a German name for pyrite.

**eisenkiesel;** a German term for ferruginous quartz, yellow, red, or brown, caused by iron oxides.

**ekanite;** a metamict, highly radioactive, massive green mineral. Formula:  $2[K(Ca,Na)_2(Th,U)(Si_8O_{20})]$ . Some specimens exhibit a four-rayed star. Optics;  $\omega$ :1.573,



*cloud inclusions in ekanite*

$\epsilon$ :1.572. Birefringence: 0.001.  $\ominus$ . SG:3.31. H:6-6½. Found in Sri Lanka. Some metamict ekanite can be restored to the crystal condition by heat-treatment.

**ekmarin;** a Turkish name for aquamarine.

**El Aguila Azteca Opal;** same as the Aztec eagle opal or El Aguila Aztec Opal. A fine, fire opal of 32 cts, carved with head of Mexican sun god. Once in Hope collection and now in Museum of Natural History, New York. Also called Sun God Opal.

**elaolite;** a translucent, massive or coarsy crystalline, reddish, brownish, greenish, grayish, or light-green variety of nephelite. Having a greasy luster, sometimes exhibit a chatoyant effect, when cut cabochon and used as an ornamental stone. Hexagonal system. RI:1.538-1.542. Birefringence: 0.003-0.004.  $\ominus$ . SG:2.55-2.65. H:5-6. Frequently used as ornamental objects. Also spelled eleolite, elaolite. Found in Russia, Norway, and USA.

**Elandfontein;** location of a diamond deposit in east Pretoria, South Africa, where the Jonker diamond was found in 1934.

**Elandsputte;** location of an alluvial deposit near Lichtenburg, Transvaal Province, South Africa.

**elaolite;** other spelling of elaeolite:

**elastic;** the tendency of a body to return to its original shape after deformation, as in bending such as a plate white mica. → Elasticity.

**elastic mineral;** a mineral, which is able to return to original form after deformation, as in thin sheet of mica.

**elasticity;** the property or quality of being elastic. Substance, which tends to recover their original shape after being compressed, stretched, or deformed.

**Elath stone;** same as Eilat stone.

**elbaite;** a pale red, borosilicate mineral of tourmaline group from Elba, Italy. Trigonal system. Formula:  $3[\text{Na}(\text{Li},\text{Al})_3\text{Al}_6(\text{Si}_6\text{O}_{18})(\text{BO}_3)_3(\text{OH})_4]$ . Optics;  $\omega$ :1.633-1.651,  $\epsilon$ :1.615-1.630. Birefringence: 0.017-0.021.  $\ominus$ . Dispersion: 0.017. Synonym for rubellite and ilvaite. → Tourmaline.

**Elbe brilliant cut;** a style of diamond-cut brilliant developed by Elbe with extra brilliance by means of a deep faceted girdle.

**elbow twins;** → geniculate twins.

**el can mayor;** a fabulous assign to bring beryl to the constellation of cancer (Sirius). → La spica turginis.

**elco pearl;** a commercial term for an imitation pearl.

**el doradoite;** a blue rock crystal from El Dorado County, California, USA. Sometimes used as an ornamental stone.

**eldoradoite;** a blue variety of chalcedony.

**electra blue topaz;** a commercial term for sky blue topaz colored by radiation and heat treatment. → Super American blue topaz, super Swiss blue topaz.

**electric axis;** same as piezoelectric axis, in which electrical resistance is at a minimum.

**electric calamine;** an American synonym for hemimorphite.

**electric dipole;** displaced center of positive and negative charges.

**electric emerald;** a misleading term applied to a glass imitation of emerald.

**electric field;** the force surrounding of the electric field intensity.

**electrical behavior;** diamonds of Type I and Type IIa are classed generally as extremely good insulators. Type IIb stones show lower resistance.

**electrical resistivity;** same as resistivity.

**electrical twinning;** same as Dauphiné twin, electrical resistivity.

**electric corona;** → corona.

**electricity;** those effect that can be seen in some gemstones such as pyroelectricity, piezoelectricity, triboelectricity (frictional electricity), and electroconductivity.

**electrides;** another spelling for electrum.

**electrification;** an old term for frictional electricity.

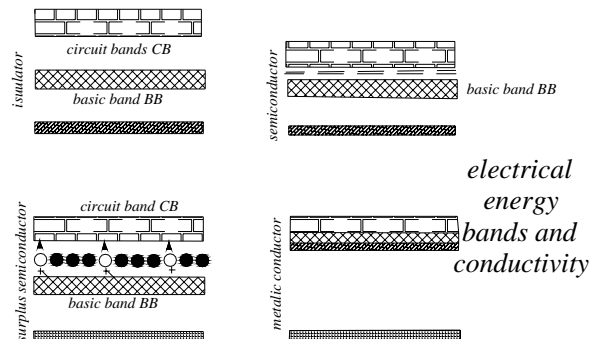
**electro ruby;** a promotion term for abrasive material from aluminum-oxide.

**electrochemistry;** the branch of chemistry that uses

action to promote chemical change.

**electrochromism;** color-change by electricity.

**electroconductivity;** metal body or medium are electro conductor because their metallic atom structures, which has one or more outer electrons are shared by the crystals as a gas of valence electrons, which are free to



move throughout the metal lattice leaving positive metal ions. In contrast are substances through, which is impossible to travel an electric current like porcelain and glasses, which is called *insulator* while they have no free outer electrons. Diamonds Type IIb are blue in color and semiconductor (diamonds are essentially a nonconductor), which is important to distinguish blue irradiated and natural blue diamonds, irradiated blue diamonds are not electroconductive.

**electroconductivity of diamonds;** usually heat and electroconductivity in diamonds go together and very high, therefore, it is essentially a nonconductor. → Electroconductivity.

**electroconductivity of psilomelane;** psilomelane is a perfect electroconductive material to distinguish from hematite.

**electroconductivity of rutile;** blue synthetic rutile is strongly electroconductive.

**electrographic;** the effect of cathode rays to engraving or etching metal surface (graveure).

**electroluminescence;** luminescence effect can actives in some gemstones by an electrical potential such as natural blue diamond.

**electrolytic cleaning;** removing of soil or other substance from work by electrolysis, the electrolyte liquid is usually alkaline.

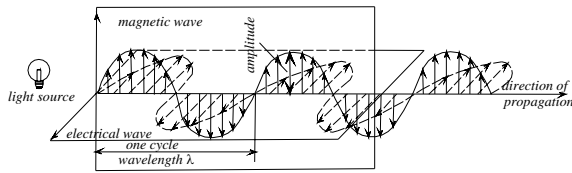
**electrolytic polishing;** the soft and bright polishing of metal surface by immersion as an anode in an electrolytic bath. Also called anode polishing.

**electromagnetic mapping;** same as electromagnetic surveying. **electromagnetic prospecting;** same as electromagnetic surveying.

**electromagnetic radiation;** the emission and propagation of radiation consisting of waves of energy associated with electric and magnetic fields.

**electromagnetic separation;** the use of electromagnet

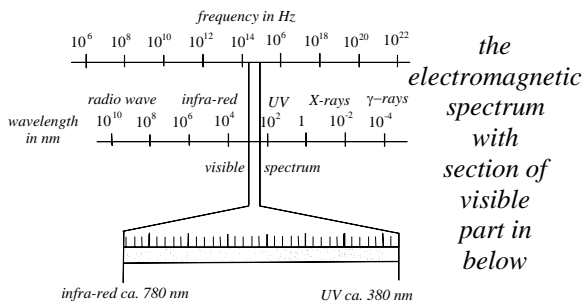
device to separate ferromagnetic minerals or metals



electromagnetic vibration of light

from relatively nonmagnetic ones. → Magnetic separation.

**electromagnetic spectrum;** the complete range of electromagnetic radiation, extending from the longest rays of radio waves to the high-frequency, shortest-



wavelength gamma and cosmic radiation. The visible light is a small part of electromagnetic spectrum, which included X-rays, gamma rays, ultraviolet, and infra-red.

**electromagnetic surveying;** the act of using a geophysical technique of systematically measuring the electromagnetic conductivity of the earth's surface or in an area adjacent to boreholes. Kimberlite and lamproite cause anomalies in the conductive pictures. Also called electromagnetic mapping, electromagnetic prospecting.

**electromagnetic theory of light;** → theory of light.

**electromagnetism;** science of the magnetism produced by electric currents and with the interaction of magnetic and electric domains.

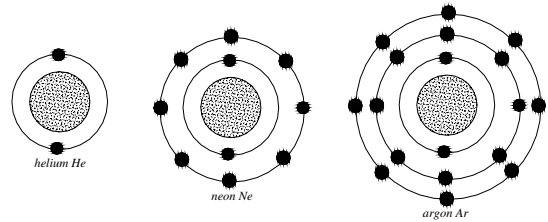
**electromigration;** a type of differentiation isotopes or ions by their differing rates of migration during electrolysis.

**electron;** a negative charged, stable elementary particle present in all atoms. Electrons surround the positively charged nucleus of the atom and determine the chemical characters of the atom. Its rest mass is  $m_e = 9.11 \times 10^{-31}$  gram. → Electron center.

**electron;** same as electron.

**electron accelerator;** an apparatus for increasing the kinetic energy of substance particles or atomic nuclei to

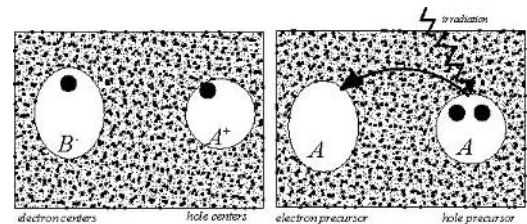
obtain a beam of high charged particles. Used in gemstone color enhancement techniques. → Cyclotron,



electronic configuration of inert atoms

diamond neutrons.

**electron and hole center;** in crystal optics, displacing of one of pair electrons from an atom, ion, molecule, impurity or blemish formed a hole due to irradiation. When the both centers (hole center and electron center) were neutral, displacing of electron formed a negative



electron and hole centers in crystal. After Nassau 1983

charge in electron center and a positive charge in hole center, therefore leaved a single unpaired electron in each center. Now one or both unpaired electrons may be excited by absorbing energy from white light, which produced color. If the hole center is responsible for color named as *hole color center*.

**electron beam;** a narrow stream of beta particles or high speed electron beam, when passed under the influence of an electric or magnetic field with the same speed in the same direction from the same source electrons are emitted. Also called electron ray or electron jet.

**electron-bombarded diamond;** → Electroned diamond, treated diamond, electroned diamond, irradiated diamond.

**electron center;** when an electron due to irradiation is displaced will trapped by a similar atom, ion, molecule, etc, create an electron center. When the both centers (hole center and electron center) were neutral, displacing of electron formed a negative charge in electron center and a positive charge in hole center, therefore leaved a single unpaired electron in each center. Now one or both unpaired electrons may be excited by absorbing energy from white light, which produced color. If the electron center is responsible for color named as electron color center. Also called

electron color center. → Electron.

**electron color center;** → electron center.

**electro-conductivity;** when a mineral held between two electrodes allows current to transfer the substance is electro-conductive. All natural blue diamonds of the Type IIb conduct electricity, while the diamonds artificially colored by electron bombardment are not electro-conducting. The semiconductor characteristic is caused by presence of boron impurities in diamond. → Electroconductivity

**electron density;** the total number of electrons in a unit volume such as per gram of a material,  $3 \times 10^{23}$  for most light metals. Also called density of states.

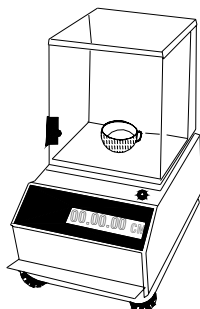
**electron diffraction;** registration of scattering of beam of electrons of very short-wavelength sent through a thin layer of crystal lattice, so that the waves shows up on an interference pattern as a light and dark bands. Electrons are associated with a wavelength  $=h/m$ , where h is the Plank Constant and m the momentum of electron. Neutron diffraction and electron diffraction can used instead of X-rays diffraction. Also called electron bending.

**electron diffraction analysis;** analysis of crystal by using the interference diffraction pattern of a beam of electrons sent through a substance to determine its identity and structure.

**electron diffraction pattern;** interference diffraction pattern of a beam of electrons sent through a substance.

**electroned diamond;** diamonds can also be artificially turned aquamarine-blue to light green with high-speed electrons from a van de Graaff generator. The treated color is coated like a film and the stones are not radioactive, nor are they electro-conductive. → Electron-treated diamond, treated diamond, van de Graaff generator.

**electronic balance;** a device for weighing gemstone,



*electronic balance for weighing gemstones*

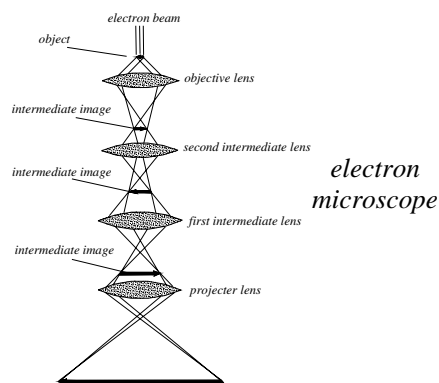
and diamonds that is provided with a piezoelectric transducer and can digitally read-out the determination.

**electronic colorimeter;** an instrument to measure the color of brilliants, constructed from the American Gemological Institute. → Micrometer.

**electronic microscope;** same as electron microscope.

*electron color center – electron volt*

**electron jet;** same as electron beam, but not necessarily



focused.

**electron microprobe;** an instrument used in gemology for identification of the inclusions of diamond using an extremely small electron beam and examining by X-ray emission spectrum. Also called electron probe microanalysis or electron probe.

**electron microscope;** a powerful optical instrument, which uses a stream of electrons or X-ray radiation instead of light focused by electron lenses to throw shadows of opaque object on a fluorescent viewing screen or photographic plate in a manner similar to that, in which a stream of light is used in a common microscope. Enlargements are capable of up to 1,000,000 times and more. Also spelling electronic microscope. → Scanning electron microscope, sputtering,-vacuum.

**electron microscopy;** measurement and identifying the structure of crystals using the electron microscope.

**electron number;** the number of electron in an ion or atom.

**electron paramagnetic resonance;** same as electron spin resonance.

**electron probe microanalysis;** same as electron microscope.

**electron probe;** same as electron microscope.

**electron ray;** same as electron beam.

**electron spectroscopy;** a type of spectroscopy proceeds with the emission and register of the electron, which constitute solids, liquids, or gases. Used to investigate atomic molecular, or solid-state structure.

**electron spin resonance;** an instrument used in gemology for non-destructive analysis of crystalline impurities by resonance occurring, when electrons, which are undergoing transitions between energy levels in a substance are irradiated with electromagnetic energy of a proper frequency to produce maximum absorption. Abbr.: ESR.

**electron volt;** a unit of energy of moving particles used in nuclear physics equal to the work done on an electron accelerated through a potential difference of 1

volt, equivalent to  $1.602 \times 10^{-19}$  Joule. It can be linked up with the frequency of light and hence with wavelength by the equation  $1\text{eV}=8066 \text{ cm}^{-1}$  or equivalent to  $1.602 \times 10^{-19}$  joules. Where eV is a symbol for electron volt.

**electron-treated diamond;** → electroned diamond, treated diamond, irradiated diamond.

**electro negative element;** those elements or groups that attract electrons such as non-metals (not always) and hydroxyls. → Electro positive element.

**electron tube;** another term for Coolidge hot cathode in X-rays.

**electro positive element;** generally elements are divide into 2 groups, metals and non-metals, and are divided into electro positive and electro negative. Electro-positive is those elements or groups that give up electrons such as metals (not always) and acidic hydrogen.

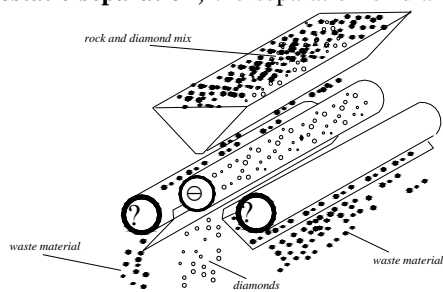
**electroscope;** an instrument for testing and measuring the presence of an electric charge in substances.

**electrostatic;** rubber and rubbed materials that become electrically. They repel unlike charges and attract like charges.

**electrostatic concentration of diamonds;** diamond is virtually non-conducting, whereas most of the waste particles are better conductors. The dried concentrate of diamond and waste is passed through a high-tension field maintained between two electrodes. The induced charge leaks more rapidly from the diamonds.

**electrostatic field;** the electric region that surrounds a stationary electrically charged body, which is subjected to force of attraction or repulsion because of presence of another stationary electric charge. A sample is corundum in which positive aluminum surrounded by six negative oxygen ions ( $\text{O}^{2-}$ ), this six oxygen ions charged neighbors create an electrostatic field around the aluminum ion, which is known as crystal field.

**electrostatic separation;** the separation of diamonds or



*electrostatic separation device of diamond from the rock. After Gübelin*

minerals according to their electrical conductivity, good conducting material is attracted by a charged body, diamonds are bad conductors and are unaffected and the diamonds fall straight down.

**electrovalent bond;** same as ionic bond.

**electrum;** an obsolete ancient Greek term for amber. Also called electron. Also spelled electrides.

**electrum;** a natural alloy of gold and silver or argentiferous gold  $4[\text{Au},\text{Ag}]$ , containing more than 20% silver. Cubic crystal. Massive. Pale yellow to yellowish white. SG:12.5-15.5. Was used by Egypt and Asia Minor 3000 BC. for jewelry and ornaments.

**electrum;** a modern man-made alloy similar as natural, which sometimes called *white gold*. Used also in depletion.

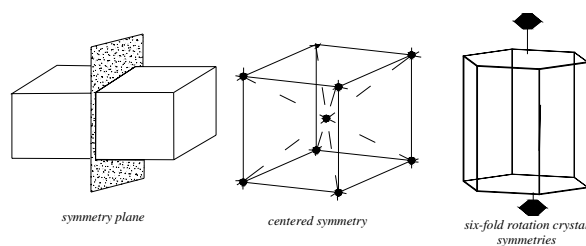
**elegant sun-spangled amber;** sometimes discoidal crack-like fissures of clarified amber show a peculiar appearance with characteristic radiating circular forms within the stone which are very attractive.

**Elektrides;** a term was used in Roman times perhaps for Frisian Island. Also was called amber islands.

**elektron;** an ancient Greek term for amber.

**element (chemical);** a simple substance or a form of matter, which cannot be decomposed chemically into simpler substances by normal chemical means. A chemical element. → Chemical element.

**element of symmetry;** same as symmetry elements. The element of symmetry possessed by a crystal may be of



*symmetry elements*

three types: axis of symmetry, center of symmetry, and plane of symmetry.

**element stone;** same as opal.

**element, periodic classification of;** classification of the elements based on the periodic law or on the order of their atomic weights. At regular stages elements of similar properties form well-defined groups.

**elementary cell;** same as unit cell. The simplest form of atoms, ions, or molecules that is characteristic of a particular crystal lattice. It is repeated indefinitely to form the crystal lattice. → Cell, unit cell.

**elementary colors;** same as primary colors.

**elementary particle;** same as fundamental particle.

**elenchi;** another term for pear-shaped pearl.

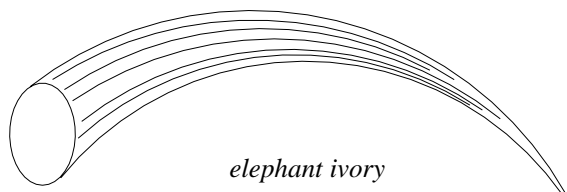
**eleolite;** a dark colored variety of translucent, massive nepheline with a greasy luster. Sometimes used as an ornamental stone. Also spelled elalolite, elaeolite. → Nepheline.

**elephant ear;** a fine grained sponge used in pottery.



**elephant hair;** a curious jewelry articles made from the coarse hair of elephant's tail, such as bracelets, finger rings, etc. often used in India. Similar to that in China seen carved objects from closely compact mass of hair or horny fibers growing from hide of rhinoceros.

**elephant ivory;** a variety of ivory, from male and female elephants, from Africa *Elephas africanus*, and South East Asia *Elephas maximus* (in Asia male



elephant has tusks), which is also called *Indian elephant*. The tusks of elephants have fine longitudinal canals containing gelatinous material, which provides the polish effects. *Bastard ivory* is an intermediate type and soft ivory from Thailand → Ivory, dentine ivory.

**elephant jasper;** a dark brown jasper included small, black dendrite.

**elephant pearl;** frequently a foreign body enters the pulp cavity of elephant tusk, which produced a nearly orbicular bead like a pearl in appearance. Around this bead are deposited concentric sheets of dentine material.

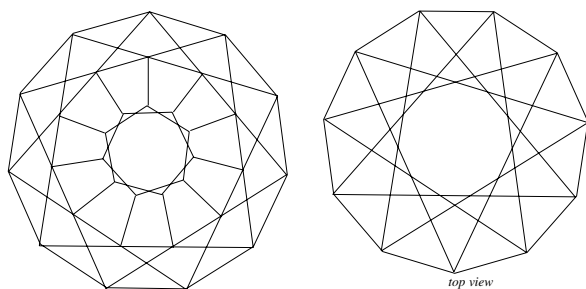
**elephant teeth;** sometimes it can be seen that unusual ivory is cut from molar teeth of elephants, which is a large posterior tooth and known as *molar ivory*, it is to distinguish by cross-section, which exhibits a mottled or banded mass with brown and cream colors.

**Elephas africanus;** → elephant ivory.

**Elephas maximus;** → elephant ivory.

**Elephas primigenius;** → fossil ivory.

**elevation;** an amulet sign made of beryl or other stones in form of two feathers which mean elevation, worn in



two eleven rayed star-cuts

ancient Egyptian to protect from snake bites and

recurrent malarial fever. Also known as youth.

**eleven rayed star-cut;** a modified unpaired brilliant cut with 55 triangular and five-sided facets and an eleven edged table in the crown. Second cut has 44 triangular facets and an eleven sided table in the crown.

**Elie ruby;** a misleading term for pyrope garnet from Elie, Scotland. Also spelled Ely ruby.

**eliodoro;** Italian spelling for heliodor, a golden variety of beryl.

**elite pearls;** a commercial term for imitation pearls.

**elipomacrostyla;** allegedly a term for beryl.

**elixerite;** a banded rhyolite from New Mexico, USA.

**Elizabeth;** location of a small alluvial diamond deposit in Lichtenburg, Transvaal Province, South Africa.

**Elizabeth Bay;** location of a small alluvial diamond mine south of Lüderitz, Namibia, Africa.

**Elizabeth I, Queen of England;** Queen of England from 1558 to 1603 owned Crown Jewels of England.

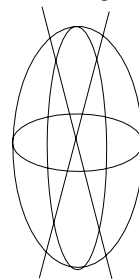
**Elizabeth II, Queen of England;** Queen of England from 1952-.

**Elizabeth Pink Diamond;** same as Williamson Diamond.

**ellandra pearl;** a commercial term for imitation pearls.

**Ellendale;** location of numerous diamond lamproite pipes in Western Australia.

**ellipsoid;** a solid figure surface, of which all plane sections are ellipses rotating about one of its axes.



a three axial ellipsoid sketch of an biaxial crystal

**ellipsoidal;** adjective of ellipsoid.

**elliptical vesicle;** same as elliptical bubble in a glass.

**Ellure Group;** known as Golconda.

**elongated cavity;** a term used for amygdaloidal rock.

**elongated cavity;** an almond-shaped cavity.

**El Pao;** an alluvial diamond deposit in Venezuela.

**Elster pearl;** fresh-water pearl from Elster River, Saxony, Eastern Germany.

**eluvial;** pertaining or composed to alluvium such as placer resulting from the decomposition of rock in place.

**eluvial deposits;** weathered or floated material. Placer mineral concentrated near the decomposed or disintegrated rock in place (*in situ*) by rain wash, but has not been transported by a stream. The term is specially applied to deposits of economic substance

(gold, platinum, diamond, etc.). Also called alluvial placer.

**eluvial placer;** same as alluvial deposit. Known as eluvium gravels.

**eluvial working;** location of two eluvial pipes near Letlhakane, Botswana, Southern Africa. The material from the original pipes remained on the top of the pipes and the surrounding area is now being mined.

**eluvium;** weathered or floated placer minerals formed in place (*in situ*) from residual rock debris.

**eluvium gravels;** → eluvial deposits.

**elvan;** a Cornish term used for granite rock containing tourmaline, fluorite, or topaz.

**Ely ruby;** a misleading term for Elie ruby.

**elytron;** a leathery, horny iridescent substance obtained from wings of beetles, and insects, which cover to protect the hind wings of animals.

**emaldine;** a synonym for emildine.

**emanation;** same as exhalation

**emboss;** to fashion relief with raised surfaces.

**embossing;** the process of raising an ornament design to produce a relief against a surface, usually effected by punching and hammering in metalwork for enameling. The technique is usually applied to thin and flat metal layers. Also called repoussé.

**emerada;** a misleading commercial term for yellow-green synthetic spinel. Same as erinite, or erinide. Also spelled emeralda.

**emeral;** a Swedish term emerald.

**emeralda;** same as erinide. → Emeralda.

**emerald;** a brilliant, grass-green variety of beryl  $2[\text{Be}_3(\text{Al,Cr})_2\text{Si}_6\text{O}_{18}]$ , highly favored as a gem. Green color is caused by trace of chromium ( $\text{Cr}^{+3}$ ) and vanadium ( $\text{V}^{+3}$ ) ions. Flawless specimens are rare and most of them contain inclusions, which are known as *jardin* of emerald. Rounded pebbles of Colombian emerald that were used as a gem called *Chibcha stones*. Sandawana emerald, is an emerald less than one cts, of good color and flawless from Zimbabwe. Brazil stones having open veins, which are filled with oil to enhance the color. They are fashioned as beads, notched, and cut as emerald cut, regular shape, cabochon (with chatoyancy), and brilliant cut. Synthetic emerald has been made since 1930 also imitation production of glass. Poor colored stone is painting on the back and enclosed in a *closed setting*. The so-called *Indian emerald* is a misleading term for green-dyed *crackled quartz*. Found in Colombia, Russia, South Africa, Austria, Zimbabwe, Brazil, India, and Africa. It is the *birthstone* for May. → Beryl.

**emerald;** any various grass-green color designation, emerald glass, copper emerald (diopside), Brazilian emerald (tourmaline), Uralian emerald (demantoid), Oriental emerald (sapphire), African emerald

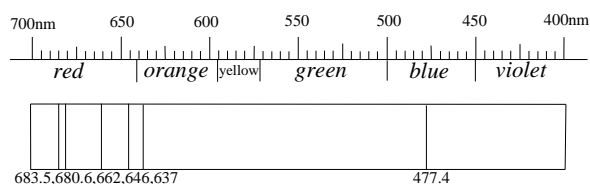
(fluorspar), Spanish emerald (green glass), etc.

**emerald;** an old term for species of beryl.

**emerald;** adj. said of a gemmy and richly green-colored mineral, such as emerald spodumene (hiddenite), emerald jade (jadeite), and emerald malachite (diopside).

**emeralda;** a misleading commercial term for yellow-green synthetic spinel. Same as erinite, or erinide. Also spelled emeralda.

**emerald, absorption spectrum of;** emerald shows a typical absorption spectrum for chromium-rich stones



emerald absorption spectrum

with fine lines in the red at 683, 680, 637 nm, weak lines at 625, 580 nm, a line in the blue at 477.5 and 460 nm.

**emerald, African;** a misnomer for green fluorite from Africa.

**emerald against epilepsy sickness;** a believe from ancient time that emerald is effective against epilepsy or other symptoms like that such as sudden collapse or convulsions when used as amulet.

**emerald, Brazilian;** a misnomer for green tourmaline from Brazil.

**emerald, Brazilian;** a term used for emeralds from Brazil.

**Emerald Buddha;** a famous dull gray-greenish gemstone of Buddha statue can be seen in Chapel of the emerald Buddha in the Grand Palace in Bangkok, Thailand. Now admitted the government the statue is not emerald, may be fine-grained igneous rock or green jasper. Government described it as one-piece-jade. Also called Buddha's Emerald.

**emerald capital;** a misleading term for the Bogotá, Columbia.

**emerald carat estimator;** → appendices.

**emerald, Chatham;** a trade misnomer for a flux-fusion synthetic emerald, grown by Carroll F. Chatham of San Francisco, California, USA. Also called Chatham-Created Emerald, or Chatham Cultured Emerald.

**emerald coated beryl;** a faceted piece of colorless or pale-colored beryl or aquamarine, on which a thin coating of synthetic emerald has been deposited hydrothermally by the Lechleitner technique. Also

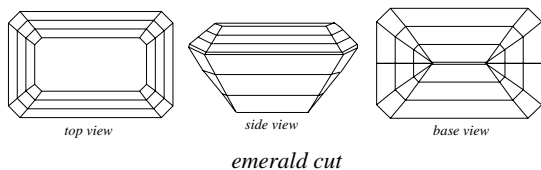
commercially called emerita or symerald. → Emerald, Lechleitner.

**emerald, Colombian;** Colombian emerald are easy to identify, they contain flat cavities like a coarse saw and consist of liquid, a bubble of gas and a little cube of rock-salt. Sometimes these three-phase inclusions may have only a single *spike*.

**emerald colors and superstitious in Indian;** according to Tagore the colors of emerald and comparing them with animals, and plants, and mentioned *seven defects* to have to avoided. An emerald or beryl fragment is inseparably joined, when on that is dirty is called *Bic'c'hava* may leads to baleful diverse diseases. An emerald or beryl with yellow spot is known as *Bishfota*, bring death from wounds due to weapon, which recommended not wearing. If an emerald is not cool, which is named *Rukshma* will bring disease. An emerald or beryl with color like *Mashakalai* (no explanation), which bring the wearer fatal destiny. Other emerald with gritty fragments is known as *Kara kara* leads to death to owner's son. That emerald, which has an ugly appearance is termed *Jathara* and leads one liable to bites.

**emerald copper;** same as diopase.

**emerald cut;** a style of rectangular or square trap-cut faceted large stones on a copper lap charged with diamond powder. Favored for emeralds, diamonds, and other transparent colored stones with the corners beveled and all surfaces covered by a series of rectangular or square facets or steps on crown and pavilion, parallel to girdle. The table is a large rectangular or square. A new modification is the *royal 144 cut*. If the form is square, it is known as *square emerald cut*. A mixed cut consists of brilliant-cut on crown and trap-cut on pavilion. Some inferior quality is cut cabochon or spheres, or some good quality stones are carved objects but they have many flaws and fissures. Sometimes the native-cut stones are boiled in



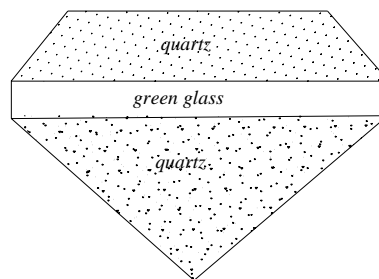
oil to improve the color, which is called *doctored*, to determine this put the stone for some time in warm alcohol to reveal the natural color. Observing an emerald cut through the table, when it is cut perpendicular to the optic axis (or to the length of the

prism), a yellowish-green hue caused by ordinary ray can be seen. A cut at right angle to this direction, or when the table is parallel to the optic axis or prism causes a bluish-green color, owed to mixture of extraordinary (more than 50%) and ordinary ray to be seen. Also called trap cut, step cut, oblong cut, emerald cutting. → Square emerald cut.

**emerald cut in Egyptian;** beryl or emerald were cut in ancient Egypt as amulets, talisman in the different shape of heart because designed to protect their wearer from deceases, fevers, and snake bites. Small pieces of emerald were suitable for cut into symbolic objects such as scarabs and shaped as beads.

**emerald, cutting;** same as emerald cut.

**emerald doublet;** a misleading term for early type of soudé emerald consisting of two pieces of rock crystal forming the crown and pavilion cemented together by a



*emerald doublet from quartz*

green colored gelatin, but beryl soudé will not be revealed. Another type consisting of a crown and base of synthetic white spinel cemented together by gelatin or green coloring layer. Also called triplet.

**emerald evening;** a misnomer for peridot, a variety of olivine.

**emerald filter;** same as emerald glass or beryloscope. A colored glass filter through, which imitations appear green, and emerald, synthetic emerald, and some other genuine gems have a reddish color. → Emerald glass, Chelsea filter.

**emerald, fluorescence of;** → fluorescence of emerald.

**emerald, Gilson;** a commercial term for a flux-fusion synthetic emerald made by Pierre Gilson in Pas-de-Calais, France. Also called Gilson-Created Emerald.

**emerald glass;** a commercial term for an instrument containing colored glass dichromatic filters. Genuine emerald and some other genuine gems appear reddish to violetish, while glass imitation and some genuine gems (such as Brazil emerald) appear green. Acting similarly to the Chelsea color filter.

**emerald glass;** an emerald green glass production of beryl glass is made by fusion of fragment of beryl. RI:1.52. SG:2.5.

**emerald glass;** any green glass, which is used as an imitation stone.

**Emerald Goddess;** an egg-shaped emerald were in

possession of Indian native priest in the city of Manta in Peru before Spanish conquest entered. It was on display on special religious ritual days when natives came to bring their gifts this emerald, which native named as Umiña. The priests suggested that this emerald crystal were the 'Daughter of the Goddess'.

**emerald, Habachtal;** the small crystals of emerald from the old Habachtal mine in Salzburg (Tyrol), Austria, which is still worked sporadically on a small scale.

**emerald, imitation of;** any substance fashioned as an emerald, which imitates it in appearance. Same as imitation emerald.

**emerald, imitation strass;** to imitate colored transparent emerald, added oxides of copper, iron oxide, copper acetate, and chrome oxide to obtain emerald green glass with RI:1.59-1.68. SG:3.15-4.15. H:5.

**emeraldin;** a German spelling for diopside.

**emeraldine;** a trade term for a chalcedony dyed green with chrome oxide.

**emeraldine;** a commercial term for light green synthetic spinel.

**emeraldine;** same as diopside.

**emerald, inclusion in;** → inclusion in emerald.

**emerald in Egyptian;** emerald were known to ancient Egyptian with the name *Mafek* which was used for beryl and other greenish stones.

**emerald, Indian;** in emeralds from India rectangular hexagonal cavities (negative crystals) parallel to the main axis of the crystal are sometimes found.

**emerald in Indian;** according to Tagore (mention the Vedas, also Rig-Veda), knowledge about emerald to ancient Indian may be even older than ancient Egypt. In Indian culture the emerald has been used by Hindus as amulet or talisman and was one of the nine jewels known as the *nava-ratna* or *nao-ratan* of Hindu lore. This nine gems were usually strung together as in necklaces to signify the protection or sages of the royal court of Vikramaditya, ca. 65 B.C. The nine talismans or ornaments by Hindu are diamond, ruby, cat's-eye, chrysoberyl, pearl, zircon, coral, emerald, sapphire and topaz. → Urim and thummim.

**emeraldite;** a German spelling for emeraldite.

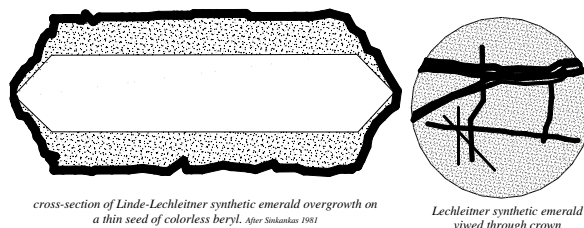
**emeraldite;** a misleading spelling of emeralite or pale green tourmaline from Mesa Grande, California, USA.

**emerald jade;** a term applied to apple-green or emerald-green translucent jadeite. A highly prized color. Also called imperial jade, jewel jade.

**emerald, Lechleitner;** a coated emerald made by the Lechleitner process, which causes a deposit of synthetic emerald on to the surface of pre-fashioned pale-yellow beryl or aquamarine, for which the name emerita was suggested but now it is called symerald. → Emerald coated beryl.

**emerald, luminescence of;** the luminescent effect

shown by natural and synthetic emeralds under various



*Lechleitner synthetic sandwich emerald  
and when viewed through crown*

conditions of radiations.

**emerald malachite;** a misleading term for diopside or so-called copper emerald.

**emerald matrix;** a compact granular rock containing essentially corundum and especially one composed of albite feldspar, black tourmaline, mica, emerald and quartz, cut as cabochon. Found in North Carolina, USA.

**emerald matrix;** a misleading term for green fluor spar, jasper, prase, etc. → Also known as mother-of-emerald.

**emerald, names in Chinese;** emerald in China is named as *tsie-mu-lu* and in Manchuria noiwarimbu wehe (means greenish stone).

**emerald, names of;** emerald in Sanskrit called *smarakata* or *marakata*. *Mafek* was an ancient Egyptian term for emerald (beryl and other greenish stone). In Scythian or Farsi (Persian) *zomorrod* or *zumurrud* derived from the area and river Izumrud in Scythian district, once northeast of Khorassan, Persian, today, the Izumrud is a district in Russia. In Chinese *tsie-mu-lu* or *tsu-mu-lu* (means greenish stone), Tibetan *mar-gad*, Mongol *markat*. The Tibetan and Mongol word derived from Sanskrit. In Assyrian or Syriac *borko*. Greek name *smaragdus* is a corruption of the Sanskrit *smarakata*. From Greek word *smaragdus* with the time, language and country derived the term *esmerauld*, *esmaragd* and *emerald*. The alteration from Sanskrit-Iranian (s)marakata-zumurrud to *smaragdus*-emerald suggests a common origin, because the name and gem have been imported together from Izumrud in Scythian or Bactria.

**emerald nickel;** synonym for zaratite.

**emerald, occurrence;** emerald is found in a number of countries: Columbia, Brazil, Russia, Austria, South Africa, Australia, Pakistan, India, Tanzania, Zimbabwe, Zambia, Malagasy, Nigeria, Norway, Algeria, and USA.

**Emerald of Texcoco;** a legendary pyramidal emerald crystal from Colombia adorned with an aigrette of plumes on the top of it. → Cortez Emerald, Tezcoco, Goddess of Emeralds.

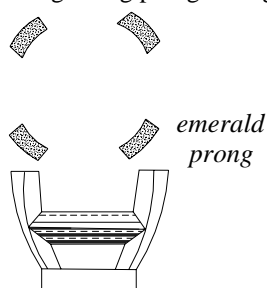
**emerald, oiled;** nearly all Brazilian emeralds are impregnated with gently-warmed fine oil such as cedar oil or kerosene to make flaw invisible and to improve their color. Cedar has nearly the same refractive index as emerald. The problem is that, when the oil dries out the stones become much less desirable. The flaws are visible under magnification examination. Newly fractured emeralds are impregnated with *opticon* a colorless polymer epoxy plastic or with a colorless glass-like material, which is known as *yehuda treatment*. → Treated emerald.

**emeraldolite;** a term applied to a synthetic production of parallel or epitaxial flux grown on to white opaque true beryl.

**emerald, Oriental;** a misnomer for green corundum.

**emerald pearl;** an international trade term for (a) dark labradorite (b) dark larvikite.

**emerald prong;** a finger ring prong setting with 4 corner

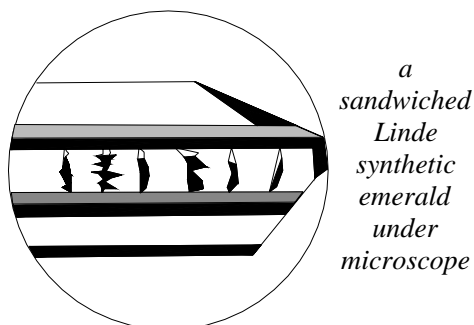


posts.

**emerald purity in Indian;** according to Tagore there are five principal for quality of emerald: purity, weight, coolness, free of dust, and beauty, which has influence to free the men from sin, causes increase in wealth, etc.

**emerald, Russia;** → Siberian emerald.

**emerald, sandwiched;** a term applied to layered



synthetic emerald made by Lechleitner.

**emerald, scientific;** scientific emerald included synthetic spinel or corundum, a beryl glass or just paste.

**emerald schörl;** same as emerald shorl.

**emerald schorl;** same as emerald shorl.

**emerald shirl;** same as emerald shorl.

**emerald shorl;** a misleading term for mother-of-emerald. Also spelled emerald schorl, emerald shirl.

**emerald shorl;** a believing that is same as Egyptian emerald. Also spelled emerald schorl, emerald shirl, emerald schörl.

**emerald, Siberian;** emerald mined from Ural mountains is called Siberian or Russia emerald, has quite a different occurrence, and this is reflected in their inclusions.

**emerald, soudé;** → soudé emerald.

**émerald, soudée;** → soudé emerald.

**emerald, South Africa;** emerald from Transvaal, South Africa. Also called Transvaal emerald.

**emerald, Spanish;** a misnomer for green glass used as an imitation emerald.

**emerald spodumene;** a misleading term hiddenite.

**emerald, synthetic;** a term applied to commercial production of synthetic emerald. → Synthetic emerald.

**Emerald Suite;** a treasury room of Grüne Gewölbe (Green Vault), in Dresden, Germany in which a big collection of cut emeralds are on display.

**emerald, synthetic;** a misnomer for the green varieties of synthetic corundum or spinel.

**Emerald Table;** same as Tabula Smaragdina, the.

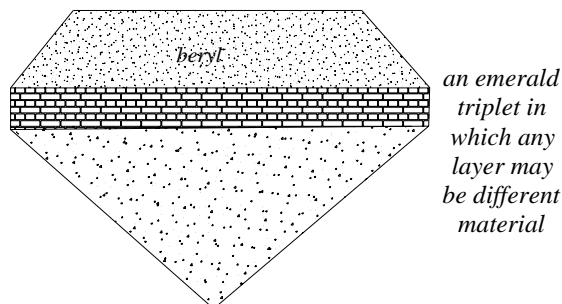
**emerald talisman in Indian;** according to Tagore the nine of *nava-ratna* or *nao-ratan* protect the wearer diseases and astral devil and require to bring respect, wealth, happiness, longevity, fame, strength, and fruition.

**emerald, Transvaal;** same as emerald,-South Africa.

**emerald, trapiche;** same as trapiche emerald.

**emerald triplet;** a misleading term for emerald doublet.

**emerald triplet;** a misleading term for emerald triplet consist of beryl in the crown, green jointing layer and



base part may be from different material such as light colored beryl or other natural or synthetic material.

**emerald under Chelsea filter;** most emeralds will appear distinctly red, whereas nearly all of the imitation emeralds or genuine stones resembling emerald show green through the filter.

**emerald, Uralian;** a misnomer for demantoid or green garnet.

**Emerald Vernicle, the;** the fabled portrait or

representing image of Jesus Christus face made of a huge single emerald. Also called the Veronica Emerald. One Image is found in the King's Handbook of Engraved Gems.

**emeralite**; a misleading term for pale green tourmaline from Mesa Grande, California, USA. Also spelled emeraldite

**emeraldine**; a misleading term for diopside.

**emeraude**; an old spelling for species of beryl.

**émeraude**; a misleading French term used for green glass.

**émeraude**; a French term for emerald.

**émeraude batarde**; a French applied to green peridot.

**émeraude cuivre**; a French term for diopside.

**émeraude d'Afrique**; a misleading French term for green fluorite or green tourmaline.

**émeraude de lithion**; a French term for hiddenite.

**émeraude de nickel**; a French term applied to zaratite.

**émeraude de nuit**; a French term for peridot.

**émeraude de oural**; a French term applied to demantoid garnet.

**émeraude du Bahia**; a French term applied to emerald from Bahia, Brazil.

**émeraude du Brésil**; a misleading French term for green tourmaline.

**émeraude du cap**; a misleading French term for green prehnite

**émeraude du Colombie**; a French term for emerald from Colombia. Sometimes is called émeraude du Pérou.

**émeraude du Pérou**; a French term for emerald from Colombia.

**émeraude électrique**; a French term applied to green glass.

**émeraude Espagnole**; a misleading French term used for green glass.

**émeraude miellée**; a French term applied to light honey yellow beryl.

**émeraude morillon**; a misleading French term used for green fluorite.

**émeraude orientale**; a misleading French term used for green sapphire.

**émeraude soudé**; same as emerald soudé, soldered emerald, and soudé emerald.

**émeraude tecla**; a French term for emerald imitation.

**émeraude vert**; a French term for emerald to distinguish from other beryls.

**émeraudine**; a term applied to diopside.

**émeraudite**; a term applied to diopside or green pyroxene.

**emeraldine**; a misleading term for chromium-oxide, green stained chalcedony that resembles the color of an emerald.

**emerged beach deposit**; same as emerged deposit.

**emerged deposit**; the sand deposit, which extended along the beach and rise above high-tide level. Also called emerged beach deposit.

**emerita**; a commercial misnomer given to the faceted pieces of colorless or pale-colored beryl or aquamarine, on which a thin coating of synthetic emerald has been deposited hydrothermally made by the Lechleitner method. Also called symerald and. → Emerald coated beryl.

**emerita stein**; a German term for emerald coated beryl. → Emerald coated beryl.

**emery**; a massive, fine to coarse-grained, impure variety of corundum. An intimate admixture of corundum, magnetite, hematite, and spinel. Dark-brown to black to grayish-black. Metallic luster. Yellowish to brown streak. Uneven fracture. Brittle. SG:7-9. H:3.7-4.3. Source: New York (USA), Saxony (Germany), Naxos (Greece), and Russia. Often used for buffing, polishing and abrasive purposes. Also called emery-rock, and corundolite. → Emery rock.

**emery**; a massive variety of carborundum powder used for polishing.

**emery buff**; a wheel made of wood surfaced with the finest-grade of emery powder, used for polishing and cleaning metal surfaces. → Emery paper.

**emery cloth**; same as emery paper. → Emery paper.

**emery paper**; stiff paper or cloth surfaced with various grades of emery powder, used for polishing and cleaning metal.

**emery rock**; same as emery. A granular rock containing essentially corundum and iron oxide ores, which may be formed by magnetic or by metamorphism of ferruginous bauxite or laterite. Synonym for emery, and corundolite.

**emery stone**; a mixture of gun shellac natural yellow to brown resin and emery, or emery and clay used for emery wheels.

**emery wheel**; a high speed grinding or polishing wheel the surface, of which is coated with abrasive emery or emery stone powder, used for polishing and cleaning metal surfaces and sharpening tools.

**emerying**; using finest grade of carborundum powder as an abrasive to polish a surface.

**emildine**; a variety of spessartite garnet containing yttrium from Namibia, Africa. Synonym for emilite, emaldine.

**emilite**; same as emildine. A spessartite garnet from South Africa.

**eminent cleavage**; same as perfect cleavage.

**eminent crystal cleavage**; same as perfect cleavage.

**eminent mineral cleavage**; same as perfect cleavage.

**emission**; emitted photons of electromagnetic radiation in the visible spectrum.

**emission;** same as emission of lava.

**emission lines;** lines resulting from emission of electromagnetic radiation by atoms, molecules, or ions.

**emission spectroscopy;** the study of an emission spectrum and processes passed into a spectroscope and measuring, which go along with it.

**emission spectrum;** generally a continuous spectrum or pattern of bright lines or bands regarded as characterizing the body that emits the electromagnetic rays rather than one through, which they pass into a spectrometer. A second kind of emission spectrum results from fluorescence by excitation of X-rays, ultraviolet rays, cathode rays or visible radiation. In gemology used for identification of characteristic spectra. → Absorption spectrum.

**Emperor Eugénie diamond;** a perfectly oval-cut brilliant diamond of 52.35 cts, cut of a rough stone approximately 100.00 cts, of Brazilian origin. First seen by Catherine II, Russian Tsar. Napoleon III of France purchased the diamond in 1853 as a wedding gift for his bride, Eugénie. Present owner unknown.

**Emperor Justinian diamond;** some evidence suggests that the Justinian Diamond, which weighed 25.00 cts, dropped out of the crown of the Byzantine emperor (527-565) during his triumphal procession in Constantinople.

**Emperor Maximilian Diamond;** a cushion-shaped diamond, which fluoresces violet in daylight. It weighed 41.94 cts, and belonged to the later Emperor of Mexico Ferdinand Maximilian Joseph (1832-1867), he was shot in 1867. Present owner unknown. → Maximilian Diamond.

**Emperor-lite;** a trademarked term for colorless synthetic corundum used as a diamond imitation.

**empirite;** a term employed to tektite from Georgia.

**emplacement;** an act, by which igneous rock intrudes on an ore body or is developed in older rocks, such as kimberlite and lamproitic magmas, which transported diamonds to the surface. Also called intrusion. → Kimberlite, lamproite.

**Empress Cut;** a trade term for a 64-facet fancy-cut diamond developed from the pear-shaped cut. Developed by an Israeli Company.

**Empress Eugénie Diamond;** same as Eugénie Diamond.

**Empress Rose Diamond;** a pink, flawless diamond of 72.79 cts, from South America. Present owner unknown.

**emulsion;** any stable colloidal suspension of two or more phase system such as suspension of silver bromide or chloride in gelatin.

**en cabochon;** a term applied to cabochon cut from almandine (carbuncle), cat's-eye, tiger's-eye, and amazonite, which is a variety of gemstone cut, having

the shape of a cabochon may be round, oval, polygonal, circular, or of a fancy shape.

**enallogene of lacroix;** → accidental inclusion.

**enamel;** glassy coating of metal or other materials. Used as an ornament for metal pottery, or for protection. A glassy substance, finely ground colored with metallic oxides (or uncolored), translucent or opaque, fused to a base or to the surface by heat of articles, glass, metal, ornament, pottery, etc. Enamels are often mixed with a flux agent to facilitate the melting point. The jewelry enamels are cloisonné, Plique à jour, Champlevé, Basse taille, niello, painted enamels and lacquer.

**enamel;** a ground oil paint containing a resin.

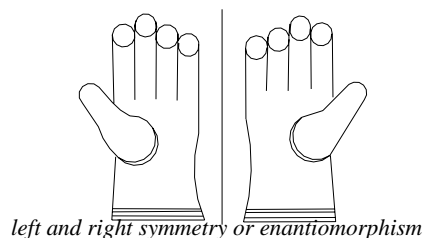
**enamel;** the external layer of teeth or ivory, which consists mainly of calcium phosphate carbonate salts.

**enamel colors;** enamel colors are metallic oxide and are often mixed with a flux agent to facilitate the melting point.

**enameling;** the method of decorating the surface of various metals or other substances by the use of enamel in order to protect against corrosion or to enhance their appearance.

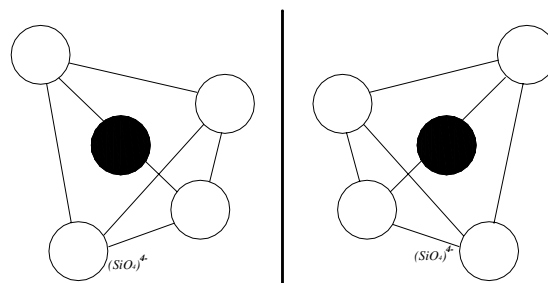
**enameling gold;** a gold alloy free from zinc metallic element.

**enantiomeric;** → enantiomorphic.



**enantiomorphic;** a term applied to forms, which are similar but not congruent or are mirror images of each other. Also called enantiomeric.

**enantiomorphism;** the characteristic relationship between two crystal forms of a substance that are



*enantiomorphism in left and right quartz structure*  
mirror images of each other such as right-handed and left-handed quartz.

**enantiomorphous;** adj. of enantiomorphism.

**enantiotropic;** the relationship between the polymorphic

forms of a substance to another, one of which is stable below a certain temperature such as

quartz ↔ tridymite ↔ cristobalite

when changes can take place in either direction according to the conditions.

**encasement pseudomorphous;** pseudomorph of muscovite after tourmaline, which appear as if mica plates were plastered on the tourmaline crystal.

**enclaves;** in effect, a synonym for inclusion or xenolith. A general term for enclosures or inclusions of any type contained in igneous rock.

**enclave's enallogenes;** exoliths or accidental inclusions.

**enclaves homogeneous;** a cognate or an autolith inclusion formed from the same magma as the enclosing rock.

**enclaves pneumatogenes;** enclaves formed by the action of magma in great depths.

**enclosed;** embedded in a matrix.

**enclosures;** generally referred to as inclusions in an igneous rock.

**encrinal limestone;** same as encrinite.

**encrinal limestone;** same as encrinal marble.

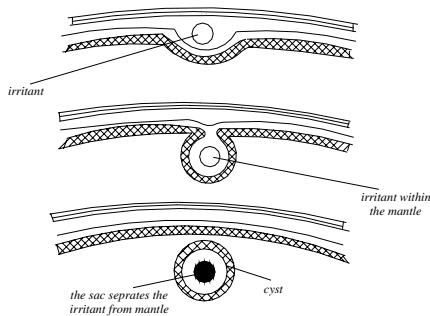
**encrinal marble;** dark-gray, brown to reddish-brown, mosaic-like marble, in which the *crinoidal fossil* (sea-lilies) fragments are embedded. Found in the lower Carboniferous strata of Derbyshire, England. Also called encrinal limestone, crinoidal marble. → Encrinite, bird's-eye, Hopton wood, rosso Verona.

**encrinite;** a crinoidal limestone or sea-lilies marble. Also called encrinal limestone.

**encrinite;** a synonym for crinoids, fossil crinoids of the Triassic, belonging to the genus *encrinurus*.

**encrustation;** another spelling for incrustation.

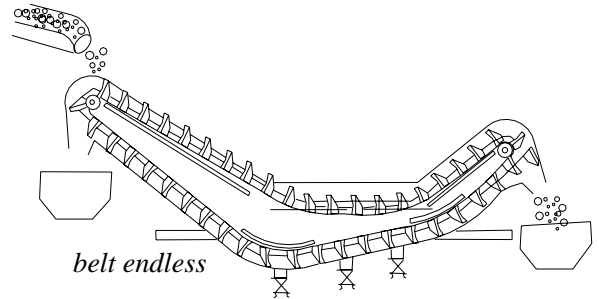
**encystation;** by introduction of small parasite as irritant such as the *cestode worm* or a *trematode worm* in mantle of a shell. The mollusk tries to eject it or to



formation of a cyst pearl or encystation of pearl

form a depression in its mantle against the inner wall until a sac-like pouch is produced, which is named *blister pearl* or *pearl sac*. → Blister pearl.

**encystation (of pearl);** pearls, which enclose or become enclosed by a cyst or sac, thick membrane, or shell.



Caused by introduction of small parasite such as the *cestode worm* or a *trematode worm* in mantle. The mollusk form a depression in its mantle until a sac-like pouch is produced, which is named *pearl sac*. Those pearls, which are produced within the body of the oyster are known as *mantle pearl*, *free pearl*, or *cyst pearl*. → Blister pearl.

**endellite;** → halloysite.

**endiopside;** synonym for enstatite-diopside.

**endlicheite;** a variety of vanadinite.

**endless belt;** a mechanical device made of flexible plastic, leather, or fabric band used to convey materials usually from shaft such as in South Africa.

**endogene;** → endogenetic.

**endogenetic;** formed by processes interior to the earth's surface, which included extrusive and intrusive igneous activity, faulting and folding. → Endogenic.

**endogenic;** the term applied to describe the geological processes and rocks that originate within the earth. Synonym for endogenetic, endogenous.

**endogenic inclusion;** inclusion of igneous origin.

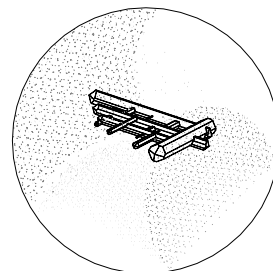
**endogenous;** same as endogenic.

**endogenous enclosures;** cognate inclusions.

**endoglyph;** a quasi hieroglyph sign occurring within a single sedimentary bed.

**endometamorphism;** same as endomorphism.

**endomorph;** a crystal that naturally occurs enclosed within another mineral, as one of rutile needles in



typical endomorphism of rutile crystal needles in Minamar ruby

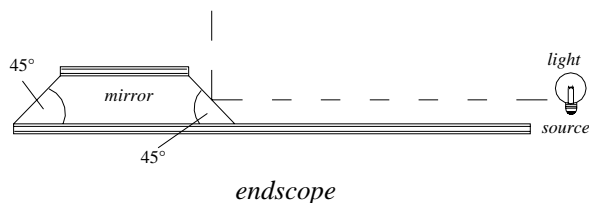
quartz. Quartz is perimorph and rutile is endomorph.



**endomorphism**; a type of contact metamorphism, in which alterations are included in the cooling molten rock material by contact with the older rock surrounding it. Also called endometamorphism.

**endomorphous**; of, or pertaining to endomorph.

**endoscope**; in gemology an illuminated optical device, which is designed for the visual identification of the



drill hole of a pearl. Used to distinguish between true and cultured pearls. A modification of it directs onto the walls of the drill hole a powerful tiny beam of light, which passed through a condensing lens system and then through a thin hollow needle, which is polished at the end to a mirror at 45° in opposite senses. The subsequent path of light through the pearl, reveals whether the structure of its core is concentric (real pearl) or parallel (cultured pearl). Also called pearl endoscope. → Pearl microscope, cardiometer.

**endoscopic stage**; a special stage for pearl microscope used for detection between drilled true and cultured pearls.

**endothermic**; pertaining to a chemical reaction or compound occurring or formed with the absorption of heat. Compare endothermic.

**endothermic process**; a process accompanied by the absorption of heat, the heat source is from outside.

**end polish**; → sulfuric acid.

**end stone**; an unpaired flat jewel, which acts as an end stone at the end of a conical pivot to limit its movement. Also called cap jewel, top jewel.

**endura emerald**; a misleading commercial term for green glass used for any glass imitation of emerald.

**energy gap**; same as band gap.

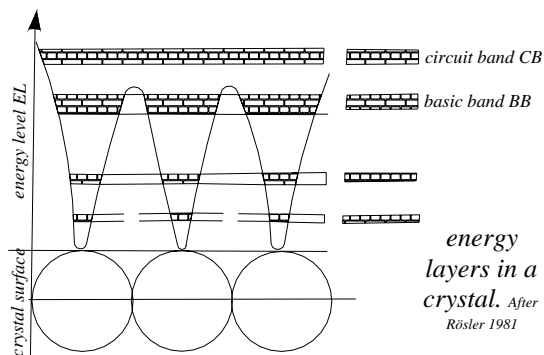
**energy level diagram**; a diagram for energy level (eV) of an atom of sodium with some allowed transitions and ground state to ionized state. Frequently called Grotrian diagram.

**energy states (levels)**; the radius of an electron's circle surrounding the nucleus is called *shell* or *energy level*.

**engagement ring**; generally a solitaire diamond ring given in token of betrothal, so given by a man to his fiancé. Also called betrothal ring.

**engelardito**; a Spanish term for zircon.

**engine-turned ivory**; a descriptive term for special lines

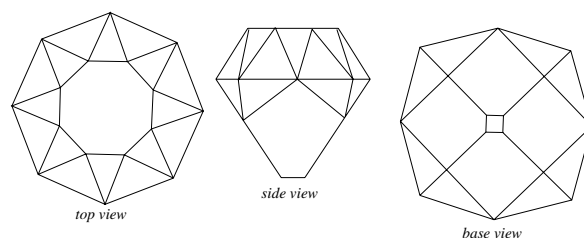


or marks, which can only be seen on the surface of engine-turned elephant ivory spheres, but not in ivory from other animals. The marks seen are like small arc or lozenge-shaped lines, which cross each other.

**English amber**; same as British amber.

**English brilliant**; same as English brilliant-cut.

**English brilliant-cut**; a cushion-shaped brilliant similar

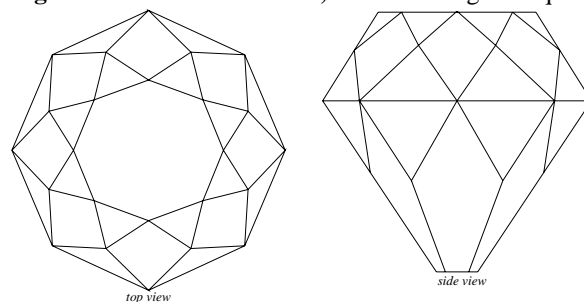


*English brilliant-cut*

to English square cut. Also called English brilliant.

**English crystal**; a misleading term applied to fine tableware and cut glass.

**English double-cut brilliant**; same as English square



*double English square brilliant-cut*

cut brilliant.

**English double-cut**; same as English square cut.

**English Dresden Diamond**; a pure white diamond of 119.50 cts, found in 1857 in Bagagem, Minas-Gerais, Brazil. It is named after Mr. E. Z. Dresden of London who had it cut into a drop-shaped brilliant, weighing 78.53 cts. It was sold in 1864 to an English merchant in Bombay. The present owner is Cursetjee Fardoonji of

Bombay, India. Also called the Dresden Drop diamond, the Star of Dresden diamond.

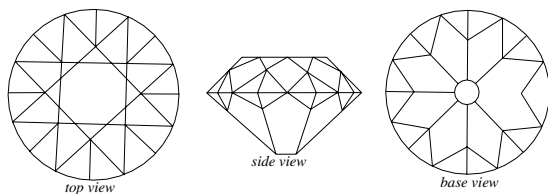
**English earth;** a local term for rottenstone.

**English edged cut brilliant;** → edged English cut.

**English pink;** a paint material made from calcium sulfate or carbonate, used as a pigment to modify the shade of chrome green. Also called Italian pink, or Dutch pink.

**English red;** a commercial term for an abrasive and polishing material made from hematite, an iron-oxide.

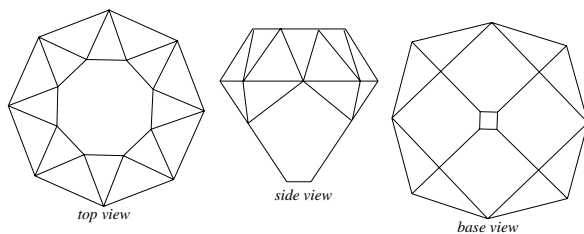
**English round cut brilliant;** a style of round cut form from 19<sup>th</sup> century in England. It looks similar to modern brilliant-cut, when viewed from above the table. Its



English round brilliant

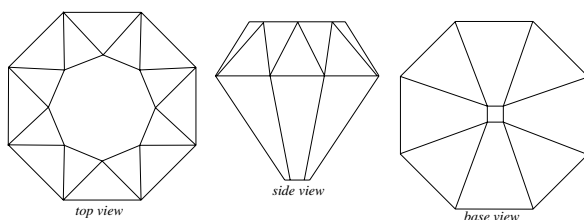
total depth is nearly equal to the girdle diameter.

**English square cut;** a modification of a cushion-shaped brilliant-cut diamond with 8-sided table, to which 8



English square-cut

triangular facets alternating with 8 other triangular facets on the crown were added. Eight isosceles-trapezoid facets on the pavilion and four large facets



English star-cut

that meet at a point at the culet. Totaling 28 facets plus

table and culet. The outline of the girdle is cushion-shaped. It is one of two alternate shapes of the double cut. → English square-cut brilliant.

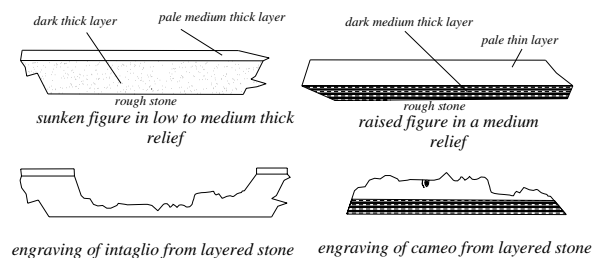
**English square-cut brilliant;** same as English square-cut. Also called English double-cut brilliant.

**English star cut;** a style of brilliant-cut diamond with 16 facets and an 8-sided table on the crown and 8 isosceles-trapezoid facets on the pavilion. The outline of girdle is 8-sided. It is similar to English square cut.

**engage;** slip covering added to a ceramic or faience body for imparting color, opacity, or other characteristics and then covered with a glaze.

**engraved birthstone;** → engraved gemstone.

**engraved gemstone;** an exquisite production of the lapidary arts of miniature sculptures, monogram, design, portrait, or inscription known as engraved gems. There are two types of engraving: *cameos* and *intaglios* but quite large carvings in hardstone. When the subject rises above the base of the gemstone it is a shallow relief carving known as *cameo*. When the subject is created by scooping out material, that is, grinding away cavities below the surface of the gem, it is called *intaglio*. Most often used stones were agate and sardonyx for a two colors effect, and also some diamonds and rubies or emeralds were also engraved.



engraving of intaglio from layered stone engraving of cameo from layered stone.

After Sinkankas 1968

Imitations of engraved stones were produced from earthenware, wedgwood and paste.

**engraved glass;** → engraved gemstone.

**engraved, antique and fake;** most of genuine antique engraved gems will be offered to museum collections, they are seldom offered to the average buyer.

**engraved, cutting centers and charges;** one of the famous shell cameos center is Tore Del Greece, not far from Naples, Italy. The next major center is twin towns Idar-Oberstein, Germany, where there a number of individual engravers and artists for the most part, intaglio in hard to soft stones.

**engraved, evaluation of gems;** most engraved gems of cameos are made from relatively inexpensive shell and intaglios from various types of chalcedony. Some cameos or intaglios have been made from valuable ruby, emerald, sapphire, and opal.

**engraved, imitation of;** the most imitated gems are made from plastics, glasses, and porcelain, generally by casting or molding.

**engraved, material used of;** materials used for engraving are shell, alabaster, calcite onyx, soapstone, chalcedony, moonstone, sunstone, tiger-eye, labradorite, etc.

**engraving;** the art of gemstone block, plate, or other surfaces that have been engraved is generally a branch of the lapidary and jewelry trades. There are two types of engraving: *cameos* and *intaglios* but quite large carvings in hardstone and metals.

**engraving tools;** for exquisite production of the lapidary



arts of miniature sculptures, monogram design, portrait, or inscription used special tools such as chisel, hammer, etc.

**enhancement;** the process to raise a higher value, intensity, color, attractiveness, quality, etc. In the diamond industry enhancement is caused by irradiation, fracture filling, coating, lasering, heating.

**enhancement;** a process of altering the appearance of an image, may be done by photographic or digital methods. Also called treatment.

**enhancement of gemstones;** the process to raise a higher value, intensity, color, attractiveness, quality, etc. In the diamond industry enhancement is caused by irradiation, fracture filling, coating, lasering, and heating.

**enhydrite;** nodules of chalcedony having cavities containing water.

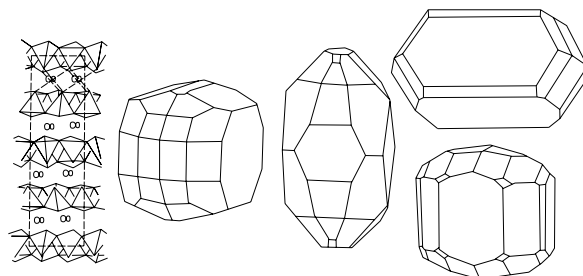
**enhydros;** a cloudy-white chalcedony or agate geode having large running air spaces or drops of included fluid. It is a curio stone prized by collectors. Found in Uruguay Italy, and Brazil. Enhydros means containing water. Also called hydrolyze. → Chalcedony enhydros, water agate.

**Enigma Diamond;** an opaque, brown, rough diamond of 17.83 cts, found in 1987 in California, USA. Whereabouts is unknown.

**enrich, to;** same as to improve.

**enstatite;** a magnesium end-member of the orthopyroxene group of minerals, closely related to

hypersthene. Weak dichroism. *Orthoferrosilite* is a massive dark-green to green variety. *Bronzite* is a massive, nearly opaque, brownish variety of enstatite. Iron-rich enstatite is known as *elite*. Misleadingly the green colored stone from South Africa was named as *green garnet*. *Schiller spar* is a green altered enstatite, composition near to serpentine, which is also known as *basite*. The stone is sometimes faceted, and cut cabochon, when the specimen shows chatoyancy or asterism. Some materials from Sri Lanka contain a 6-



enstatite structure and crystals

rayed star. Pleochroism, strong in pale pink, pink, yellowish and colorless.

System: orthorhombic.

Formula:  $8[\text{Mg}_2\text{Si}_2\text{O}_6]$ . Contain Fr.

Luster: vitreous to pearly.

Colors: colorless, yellowish or greenish white, gray, olive green, and brown.

Streak: colorless, grayish.

Diaphaneity: transparent to nearly opaque, when the iron contains is increased.

Cleavage: {210} good.

Fracture: conchoidal to uneven. Brittle.

SG: 3.10-3.43.

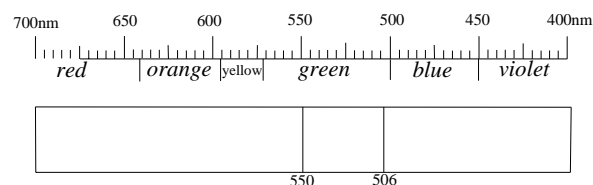
H: 5-6.

RI:  $\alpha$ :1.650-1.662,  $\beta$ :1.653-1.67,  $\gamma$ :1.658-1.68.

Birefringence: 0.010. ⊕.

Found in Mogok (Myanmar), India, Sri Lanka, South Africa in the blue ground with diamond, California, Pennsylvania (USA), Finland, and elsewhere.

**enstatite absorption spectrum;** a sharp, narrow band at



enstatite absorption spectrum

506 nm in brownish stones from India, weaker bands at

548, 483, 450 nm, etc. can also be seen.

**enstatite cat's-eye**; a misleading term for enstatite may become cat's-eye effect, when cut en cabochon.

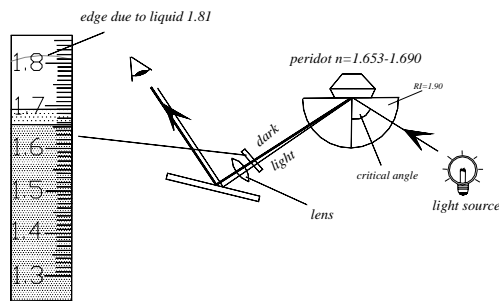
**enstatite cut**; → enstatite.

**enstatite-diopside**; a mineral of  $8[(\text{Mg,Ca})\text{SiO}_3]$  with the ratio of magnesium to calcium quasi 1:1. Magnesium rich variety of diopside. Also called endiopside.

**enstatite pyroxene**; same as enstatolite.

**enstatolite**; pyroxenite rock which consists almost entirely of enstatite.

**entering light refractometer**; after passing light the slit of device strikes the hemisphere prism of known highly refractive index. Usually the critical angle of total reflection as a shadow edge at the surface between



*entering light refractometer and striking a peridot gem liquid and a hemisphere prism is to read. For determination, the refractive index of a gemstone it is placing with the facet or a flat smooth face in contact with the reflecting surface of the hemisphere prism. The calibrated scale of the device can read by eyepiece, which is divided into two part of bright and shadow illuminated. The bright part represents the total reflection and the shadowed portion the reflected rays from the gemstone. refractometer.*

**envelope cut**; → scissors cut.

**envelope diamond**; the specially folded paper packets, in which a diamond or diamonds are held for carrying, or for transporting in a parcel. Same as diamond parcel papers or briefcase.

**envelope stone**; → envelope diamond.

**Eocene**: → Eocene System.

**Eocene System**: an epoch of the lower tertiary period between the Paleocene and Oligocene epochs.

**eolian**; pertaining to the wind such as loess, dune, sand, and some volcanic tuffs. Windblown, windborne.

**eolian corrasion**; the gradational work due to the wind action at or near the Earth's surface.

**eolian erosion**; erosion due to the wind action at or near the Earth's surface.

**eolian marble**; a crystalline granular limestone found in Mount Eolus, Vermont, USA.

**eolian pebble**; same as windblown pebble. → Eolian deposit.

**eolian placer**; placer accumulated by wind action. → Eolian deposit.

**eolianite**; sedimentary rocks, which have been deposited by the wind.

**eolith**; oldest-known stone implements used by primitive men, which are literally known as dawn stone.

**Eolithic Period**; a period, in which the early men manufactured and used eoliths.

**eolotropic**; → crystal anisotropy.

**eolotropy**; → crystal anisotropy.

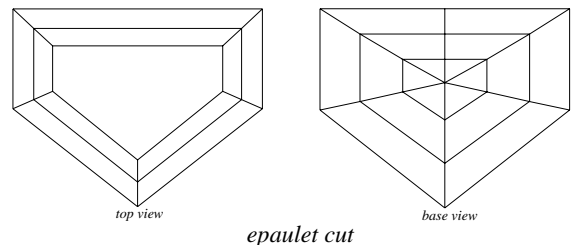
**eosite**; a commercial term for white and rose-colored quartzite rock, containing pyrite crystals. Used for ornamental carvings. Found in twin towns Idar-Oberstein, Germany. Used for ornamental carvings and curio stone. Also called Tibet stone.

**eosite**; a variety of wulfenite mineral, which contains vanadium in substitution for molybdenum.

**esphorite**; a pink to rose-red, pale yellow mineral with the formula:  $8[(\text{Mn,Fe})\text{AlPO}_4(\text{OH})_2 \cdot 2\text{H}_2\text{O}]$ . Monoclinic system. Vitreous to resinous luster. White streak. Transparent to translucent. Cleavage: {100} poor. Subconchoidal to uneven fracture. Optics;  $\alpha$ :1.638,  $\beta$ :1.662,  $\gamma$ :1.669. Birefringence: 0.029-0.035.  $\ominus$ . SG:3.10. H:4.5-5. Absorption spectrum at 410 (strong) and 490 nm (moderate). Found in Minas-Gerais (Brazil), Maine and New Hampshire (USA), and Bavaria (Germany). It is rarely fashioned.

**epaulet**; a shoulder ornament made of gold or silver in various styles usually worn on a uniform. Frequently it is decorated with gemstones. Also spelled epaulette. → Epaulet cut.

**epaulet cut**; a modified 5-sided (by varying the length and angles of the sides) fancy step cut of a diamond or



other transparent gemstone, which resembles a shoulder ornament in outline. French spelling epaulette. Sometimes called tapered pentagon.

**epaulette**; → epaulet.

**epiasterism**; a star effect is in general seen in a cut cabochon by a single reflected light, when light is reflected from suitably oriented inclusion within the stone, as in star ruby or sapphire. It is a contrast to diasterism observed by transmitted light. → Diasterism,

diasteria, epiastria.

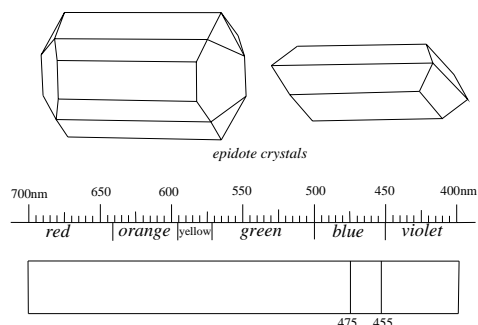
**epiastria**; when a gem, cut cabochon in the correct crystallographic direction is observed by a single reflected light within the stone, exhibits the effect of a star. → Epiasterism.

**epidiascope**; → episcopo.

**epidesmine**; → stilbite.

**epidosite**; a contact metamorphic rock containing a mixture of epidote and quartz with secondary uraltite and chlorite. Sometimes cut cabochon as a curio stone.

**epidote**; a member of clinzoisite-epidote group of related minerals: clinzoisite, orthite, piemontite



epidote crystals and absorption spectrum

(sometimes called piedmontite), mukhinite (contain vanadium), hancockite, and allanite. *Pistacite* is an alternative name. *Tawmawite* is a deep green variety of epidote. Strongly green and brown pleochroism. *Unakite* is an epidote granite rock. Also called tanzanite or zoisite.

System: monoclinic.

Formula:  $4[\text{Ca}_2(\text{Al,Fe})_3(\text{O,OH})(\text{SiO}_4)(\text{Si}_2\text{O}_7)]$ .

Luster: adamantine, vitreous somewhat pearly to resinous.

Colors: yellowish green to brownish green, pistachio-green, grayish-white, gray, greenish black, black, deep green (tawmawite), rarely colorless.

Streak: colorless, to grayish.

Diaphaneity: transparent to nearly opaque.

Cleavage: {001} perfect.

Fracture: uneven. Brittle.

SG: 3.35-3.50.

H: 6-7.

Optics;  $\alpha$ :1.74,  $\beta$ :1.769,  $\gamma$ :1.787.

Birefringence: 0.015-0.049.  $\ominus$

Dispersion: 0.019-0.030.

Found in Italy, Norway, France, Tanzania, Austria, Russia, Japan, Australia, Malagasy, Myanmar (Tawmaw), Finland, Alaska and elsewhere.

**epidote**; a term for a group of related minerals of similar structure and chemical formula.

**epidote absorption spectrum**; it has a sharp line at 455 nm and a weaker at 595, 528 and 475 nm.

**epidote cut**; pale yellow-green pieces are cut as faceted

gems and cabochons. Some stones are included with fibers, when cut cabochon, showing chatoyancy or cat's-eye effects. A mixture of quartz, green epidote, pink orthoclase feldspars cut and sold under local name as unakite. Found in Unaka Range, North Carolina, USA.

**epidote-metarhyolite**; a cuprite-colored epidote-metarhyolite from Pennsylvania, USA. Cut sometimes as cabochons and ornamental objects.

**epigene**; originating, occurring or taking place at the surface of the earth.

**epigene**; a mineral that is not natural to the rock or material, in which it is found. Compare pseudomorph. Same as syngenetic.

**epigenesis**; sometimes used as equivalent to catagenesis.

**epigenetic**; produced on or near the earth's surface.

**epigenetic**; a name applied to ore-deposits of later origin that the rocks among, which they occur.

**epigenetic deposit**; A term applied to mineral deposit of later origin that the rocks, among which they occur. Also called epigenetic ore deposit.

**epigenetic inclusions**; same as post-formed inclusions, which occurred after the formation of the host mineral. Also called post-contemporary. → Protogenetic inclusion, syngenetic inclusion, secondary liquid inclusions.

**epigenetic ore deposit**; same as epigenetic deposit.

**epigranular**; a texture of rocks where the essential minerals are all of one order of size.

**epimorph**; a natural form of a crystal.

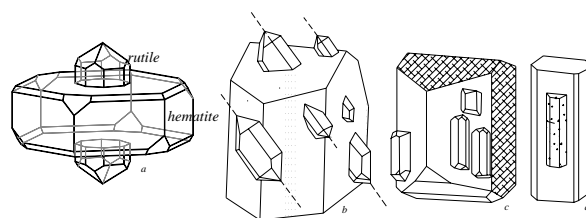
**epinatrolite**; a synonym for natrolite.

**Epiphanius**; Epiphanius Bishop of Constantia in Cyprus (310?-402 A.D.), allegedly first book about precious stones of bible written about 4<sup>th</sup> century by Epiphanius, also who noted Breastplate stones.

**episcopal ring**; another term for bishop ring.

**episcopo**; an optical projection system, which is used for producing an enlarged, real image of a brilliantly illuminated opaque object on a screen. Also called epidiascope.

**epitaxy**; the term applied to oriented overgrowth of a thin layer of a crystal on the surface of another crystal



a: epitaxy of rutile on hematite, b: epitaxy of quartz on feldspar, c: epitaxy of albite on feldspar and d: epitaxy of staurolite on kyanite

so that the layer has the same structure as the

underlying crystal.

**epithelial cell**; small organ of a shell, which formed the complete epithelial cells, which covered the mantle or pallium.

**epithelial sac**; a sac composed of epithelium or the bag of epithelial cells, which surrounds the pearl in the flesh of the mollusk. → Epithelium.

**epithelium**; the surface layer of cells of animal mantle, which cover the pearl mollusk. These mantle of mollusk secretes and produce the pearl-shell and the pearl.

**epithelium of eye**; pigmented portion of eye after cones and rods of eye. That part of light not absorbed by rods and cones will be absorbed by epithelium because of confusing reflections back of light into the eye. → Eye.

**epizone**; the shallow depth zone of regional metamorphism characterized by moderate temperature, low pressure and powerful stress in which the minerals sericite, talc, hornblende, serpentine and chlorite are formed.

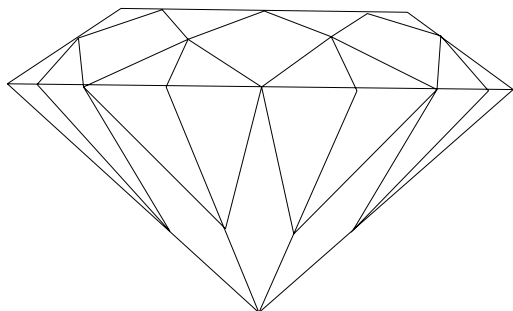
**epoch**; a unit of geological time during which rocks of a particular composition were formed.

**epoxy**; relating to an epoxy resin or consisting of an epoxy resin. → Epoxy resin.

**epoxy esters (plastics)**; → epoxy resin.

**epoxy resin**; any of several thermosetting resins or plastics used in simulants of various stones and jets because of its toughness, strong adhesion and chemical resistance. It gives a black powder on unglazed porcelain. It is easy to distinguish by its carbolic smell, when a hot needle is pressed against it. Vulcanite and bakelite are thermoplastic.

**Eppler brilliant cut**; one of several modifications of ideal brilliant-cut diamond favored in Europe. The table facet width, crown depth and pavilion depth of 56%,



*practical fine-cut or Eppler brilliant*

14.4% and 43.2% compared with the girdle diameter and a crown height to pavilion depth ratio of 1:3. The crown angle is  $33^{\circ}17'$ , and the base angle is  $40^{\circ}83'$ . Also called practical fine cut, Eppler fine cut, European cut. → Scan. D.N. brilliant cut and Tolkowsky brilliant cut.

**Eppler fine cut**; same as Eppler brilliant cut.

**epglyph**; a term applied to a hieroglyphic pattern on the top of a sedimentary layer.

**equant**; in crystallography a crystal form, in which all the faces are of similar dimensions.

**equemarine**; a French term for aquamarine beryl.

**equigranular**; dimensionally equal grains.

**equilibrium diagram**; in phase diagram a graph designed to show the fields of stability of the various phases of a heterogeneous system and effect of temperature and composition on alloy in which two or more metals coexistence in solid solution.

**equivalent grain diameter**; a term applied to an equivalent diameter of a grain sphere which would sink in liquids or water with the same velocity as the irregular particle in question.

**equivalve**; a term applied to bivalve mussels, which have the two halves of the shell of equal size.

**Er**; a chemical symbol for the element erbium.

**e-ray**; an abbreviation for extraordinary ray.

**Erb & Gray refractometer**; the first gemological refractometer designed and made in the USA. It is similar to the Tully refractometer, which has a revolving hemisphere or with the fixed hemisphere of the glass used for spot and regular readings. → Refractometer.

**erbiium**; metallic element, a member of the rare-earth group of the Periodic System with the symbol Er.

**eremeyevite**; → jeremejevite.

**erikite**; same as heath-stone.

**erikite**; a dendritic, yellow-green to brown mineral of  $(La,Ce)_x(Si,P)O_4 \cdot H_2O$ . It is a variety of rhabdophane. Also called heath-stone.

**eremite**; another term for monazite.

**erinide**; a commercial term for yellowish-green synthetic spinel. Also spelled erinite, and emeralda.

**erinite**; same as erinide.

**erinite**; an emerald-green color of  $Cu_5(OH)_4(AsO_4)_2$ .

**erinite**; a yellowish-red calcium ferrous iron aluminosilicate. Resinous luster. SG:2.04. → Thomsonite.

**erinofoil**; a variety of bexoid or cellulose acetate plastics, which are used for imitation of amber, turquoise, ivory, tortoise shell, etc.

**erinoid**; a commercial term for formalized casein plastic used for common objects and inferior gem imitations. RI:1.55. SG:1.325-1.345. H:2-½. It is sectile, when tested with a knife.

**erode**; to wear away the land, by the action of water, waves, wind, or glaciers.

**eroded crystal (diamond)**; those translucent diamonds with matt or pitted surface where the coated layer has worn away due to eroding. Also called frosted diamond.

**erosion**; the combination or process of wearing of the earth's surface by natural agents such as water or wind, under influence of gravity, particularly, when they contain debris.

**erosion by glacial ice**; same as glacial denudation.

**erotic jewelry**; carved gemstone motifs in the form of erotic articles such as phallus have been used on amulets, finger ring, brooches from ancient Egyptian and Roman times.

**erpyglyph**; a term applied to worm casting with a cylindrical mass of earth or mud which were excreted by an earthworm. Prized by collectors.

**erratics**; large stones, pebbles or boulders carried by glacial ice and deposited some distance from their place of origin.

**Erste Österreichische Gemmologische Gesellschaft**; Headquarters for this society are located at: Graben 12, 1010 Vienna, Austria.

**erubescite**; same as bornite.

**eruginous**; same as patina.

**eruption**; the sudden and violent ejection or emission of volcanic materials at the earth surface, through a crater, pipe, or fissure.

**eruptive**; igneous rocks that formed by the solidification of magma either through an extrusive or an intrusive rock.

**eruptive**; some writers restrict the term to igneous rocks that reach the surface of the earth in the molten state. Also called eruptive rock, extrusive rocks.

**eruptive breccia**; same as igneous breccia.

**eruptive rocks**; → eruptive.

**Erythrina corallodendron**; → carat.

**erythrite**; a rose-red, crimson-red, peach-red, or pink-red cobalt mineral. Synonym for erytherine, cobalt bloom, cobalt ocher, rhodoite, and peach-blossom ore. Red cobalt is an old term for erythrite. Isomorphous with annabergite.

System: monoclinic.

Formula:  $2[\text{Co}_3(\text{AsO}_4)_2 \cdot 8\text{H}_2\text{O}]$ .

Luster: weakly adamantine, pearly, also dull.

Colors: deep purplish red to pale pink or nearly colorless.

Streak: same as color but lighter.

Diaphaneity: transparent to translucent.

Cleavage: {001} perfect, {100} indistinct, and {102} indistinct.

SG: 3.09-3.18.

H:  $1\frac{1}{2}$ - $2\frac{1}{2}$  and harder due to impurities.

Optics;  $\alpha$ : 1.622-1.629,  $\beta$ : 1.658-1.662,  $\gamma$ : 1.68-1.701.

Birefringence; 0.066.  $\ominus$  or  $\oplus$ .

Found in Nipissing, Canada, Mexico, Morocco, and Chile.

**erythrite**; a term for flesh-red variety of orthoclase feldspars.

**er-zhui**; a Chinese term for earring made of jade. →

Chinese ritual and symbol jades.

**Es**; a chemical symbol for the element Einsteinium.

**escarboucle**; a French term for carbuncle.

**Escurial Library**; an old library in Madrid Spain, where preserved very old books and documents

**esmeragda**; an old Spanish term for emerald.

**esmeragdita**; a Spanish term for emerald.

**esmeragdo**; an old Portuguese term for emerald.

**esmeralda**; a misleading term for green tourmaline from Haddam, Connecticut, USA.

**esmeralda**; a Spanish and Portuguese term for emerald.

**esmeralda cobre**; a misleading Spanish or Portuguese term for diopside.

**esmeralda da Bahia**; a Portuguese term for emerald from Colombia.

**esmeralda da Colombie**; a Portuguese term for emerald from Colombia.

**esmeralda de Cartagena**; a Spanish and Portuguese misleading term for green fluorite from Cartagena.

**esmeralda de Bahia**; a Spanish term for emerald from Colombia.

**esmeralda de Colombie**; a Spanish or Portuguese term for emerald from Colombia.

**emeralda del Brasil**; a misleading Spanish term for green tourmaline.

**emeralda do Brasil**; a misleading Portuguese term for green tourmaline.

**emeralda falsa**; a Spanish term for false emerald.

**emeralda litio**; a misleading Spanish term for hiddenite.

**esmeraldas Meridionales**; a Spanish term for southern emerald.

**esmeralda nuevas**; an old Spanish term used in past for an emerald not so highly valued as Esmeralda viejas. It means new emerald and called occidental emerald because this kind of emerald originated in Colombia. → Esmeralda viejas. → Colombian emerald.

**esmeralda soldada**; a Spanish term for doublet made of two colored pieces or a colored layer between.

**esmeralda viejas**; an old Spanish misleading term used in past for highly valued emerald. It means old emerald which were actually green sapphire and called oriental emerald. Also spelled esmeralda viejas. → Esmeralda nuevas.

**esmeralda viejas**; same as esmeraldas viejas.

**esmeralda viejas**; an old term used in past for highly valued emerald. Also called old emerald.

**esmeraldite**; a medium coarse-grained igneous rock of the granite family. A white, to gray, various shade of yellow or brown rock.

**esmeraldo**; a Portuguese term for emerald.

**esmeroud**; an old Dutch term for emerald.

**Espaly-Saint-Marcel**; a high modification or normal, tetragonal, red zircon from Espaly-Saint-Marcel,

France.

**espectroscope;** Spanish term for spectroscope.

**espinela;** Spanish and Portuguese term for spinel.

**essence d'orient;** a synthetic, silver-white organic paste used as a coating for imitation pearls prepared from the silvery scales essence of the bleak, a small fish of *Alburnus lucidus* and recently sardine herring, which resembles the luster and orient of natural pearl. The material, which is crystalloids of guanine is grounded, suspended in a solvent in ether-amyl-acetate solution, and mixed with a nitrocellulose lacquer to make a paint substance. The material is used to paint the interior of a glass bead or the exterior of a bead of glass, mother-of-pearl, or other material. Up to 10 times coats are usually applied to make it appear like a pearl. Imitation essence d'orient is made from inorganic tiny platy or needle-shaped crystals of basic lead carbonate, which has a length of 30 micrometers and is used to coat the beads alone or as undercoats of essence d'orient. Another inorganic imitation is made of small crystals of mica covered completely on both sides with sheets of titanium oxide or so-called anatase so that both materials are uniquely spread in pyroxylin, a nitrated cellulose. The nearly parallel oriented layers create the effect of iridescence and interference of light at thin layer, which is called *Bragg lattice*. Essence is a French term for oil, extract or essential. → Guanine.

**essential;** → essence d'orient.

**essential minerals;** one of rock-forming minerals, whose presence or absence decides the name and classification of the rock.

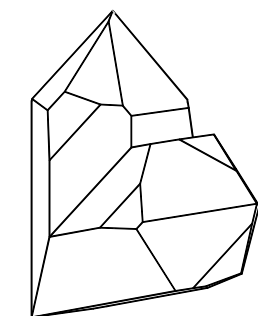
**Essex crystal;** → reverse intaglio crystal.

**essonite;** a yellow-brown, orangey-brown, reddish-brown or cinnamon-colored gem variety of grossular garnet or hessonite containing iron. Synonym for hessonite, cinnamon stone, hyacinth, or jacinth.

**essonite garnet;** same as hessonite.

**estealita;** a Spanish term for soapstone.

**Estérel twin law;** a twin law for contact twins in quartz



*Estérel twin of quartz*

similar to Japanese quartz twin law.

**Estrêla de Minas Diamond;** same as Star of the South diamond.

**Estrêla do Sul;** a minute alluvial diamond deposit in Minas Gerais, Brazil.

**Estrêla do Sul;** also called Estrêla do Sul Diamond.

**Estrêla do Sul Diamond;** same as Star of the South diamond.

**estrelada;** the Brazilian spelling for the mines, in which, diamond are found.

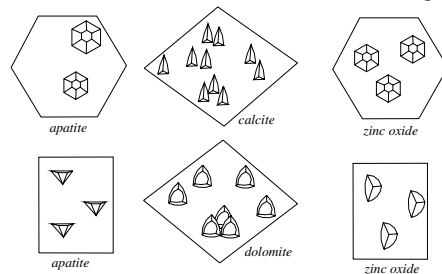
**etalon;** an interferometer made of two semi-silvered glass plates (or quartz plates), optically flat and fixed parallel to one another, and a air film in thickness of a few mm is between both glasses. Used to studying fine structure of spectrum lines by account of its accurate fringes and high resolving power and comparison of wavelength. Also called Farby-Perot etalon, Farby-Perot interferometer.

**etched;** the term applied to worn away the surface of glass, metal, or gems by solution or corrosion.

**etched figures;** → etch figures.

**etched glass;** the method to decorate the glass surface with etching agents or acids, that part of the glass that is not designed is covered with wax the other part that is designed is free and then the glass article is dipped in the etching agent, which corrodes the uncovered parts. → Etching, etch figures.

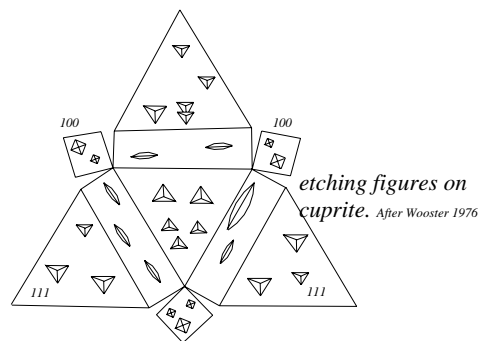
**etch features of crystals;** etching diamond with a hot oxidizing agent produces various small geometrical depression features on various faces. Triangular on



*etch marks*

octahedron faces, boat-shaped on dodecahedron faces (two points), and square in outline on cube faces. → Etch pits (on crystals), growth markings.

**etch figures;** etching with a solvent agent produces

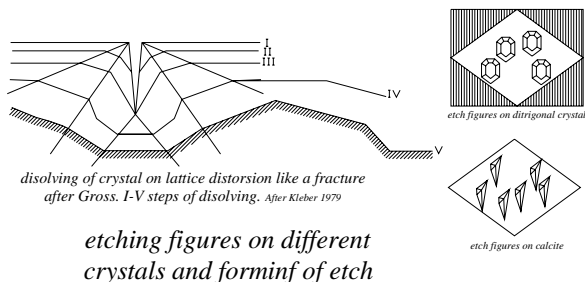


various small geometrical cavities or depressions



features on various faces of crystals, which reveal its internal crystal structure or symmetry. Also called etched figures. Etching figures of cuprite is a sample to seen

**etching**; the reduction of the Earth's surface due to the slow process of different weathering, by which masses washing and deflection are so that areas under-laying



*etching figures on different crystals and forminf of etch*

by resistant rocks would brought into relief as the less resistant rocks.

**etching**; a process of engraving or decorating metal surfaces (frequently glass), in which the lines are produced by the controlled action of an acid or an alkali. Etching acid is used to etch the article, first an acid resistant, substance usually wax or varnish is placed on the design. The article is then immersing in the etching agent, which corrodes the uncovered parts. Also misnomerly called acid etching.

**etching**; a process used to study the composition and structure of crystal and metals. Same as etch marks.

**etching pits**; small cavities or etch marks formed on the surface of metals or crystals during etching. Also spelled etch pits. → Etch marks.

**etch marks**; small regular-shaped pits develop, attacked by suitable reagents on the crystal surface. Used by studying the composition and structure of crystals. Also called etching.

**etch pits**; → etching pits.

**etch pits on crystals**; natural, triangular, small cavities (etch marks) in the flat surface of octahedral diamond crystals, have their points directed to the edge of the octahedral face. → Etch features of crystals, etch figures, etch marks, etch features of crystals.

**eternity ring**; a ring or circle made of gold or platinum set with multi minute diamonds and other colored precious stones. Presented from husband to his wife on special occasions. In Europe the circle is the traditional symbol of eternity. Also called anniversary ring.

**ethane**; a colorless, odorless, highly flammable, water-insoluble, gaseous of  $C_2H_6$ . The second member of the alkalene series. Composed in the gases off by petroleum and in illuminating gas.

**ethanediol**; same as ethylene glycol.

**ethanol**; a technical and commercial name for alcohol  $C_2H_5OH$ . → Ethyl alcohol.

**ethene**; same as ethylene.

**ether**; a colorless, volatile, highly flammable liquid with a characteristic sweetish odor with the chemical formula:  $C_2H_5-O-C_2H_5$ . Used as a test for amber and copal, copal is softened but amber is unaffected.

**ether test for amber**; all substance such as copal and kauri gum having greater solubility in ether, copal is softened. Amber is unaffected by this treatment.

**ethical gemology**; in accordance with principles of conduct that the name of gem is corrects.,

**Ethiopian emerald**; emerald from Ethiopian.

**Ethiopian opal**; any variety of iridescent, precious opal from Ethiopia, usually the term is restricted to all opals from Shewa province ca. 200km far from Addis Ababa in rhyolitic and trachytic tuffs. Some pieces are found similar to thunder eggs. The opal varieties: hydrophane-opal, black-opal, crystal-opal, fire opal, Shewa-opal and milk-opal. Usually, cut in cabochons, flat, polished slabs, with beveled or perpendicular sides. → Shewa-opal.

**ethyl alcohol**; a colorless, volatile, vinous odor, flammable liquid of  $C_2H_5OH$  produced by fermentation of sugar, and used as solvent and cleaning agent. Soluble in water and alcohol. Also called ethanol, grain alcohol, alcohol or spirits of wine. Distinguished from methyl alcohol or wood alcohol.

**ethylene**; a colorless, highly flammable, unsaturated gas of  $C_2H_4$  with a sweet odor. Slightly soluble in water and alcohol. Used in resins and in plastic industry. Also called ethene, ethylene alcohol, bicarburetted hydrogen.

**ethylene alcohol**; → Ethyl alcohol.

**ethylene dibromide**; a colorless, toxic, nonflammable, useful liquid of  $C_2H_4Br_2$  with a low surface tension, having a specific gravity of 2.18 at room temperature, used for testing opals, another organic liquid and determination by direct weighing method, has a density of near 1.17 at  $20\text{ }^\circ\text{C}$  and is, one which will separate amber from most plastic imitation. Slightly soluble in water. Care it is a suspect carcinogenic solution. Also called dibromoethane.

**ethylene glycol**; a highly explosive, colorless, syrupy, sweet tasting liquid, somewhat volatile of  $C_2H_4(NO)_2$ . Miscible with water. Used as antifreeze, and as an immersion liquid as ethylene glycol mono-ethyl ether. Also called ethanediol.

**ethylene glycol mono-ethyl ether**; same as ethylene glycol.

**etnaite**; an alkali olivine basalt from Etna, Italy.

**Étoile du Désert**; a colorless, pear-shaped diamond of 50.67 cts, mounted in a necklace. Present owner unknown.

**Etruscans and amber**; some amber and other fossil

resin artifacts and other objects are found in the tomb of Etruscans tribes in Italy as beads together with gold, ivory, glass, ceramics and bronze.

**ettringite**; a colorless, transparent to translucent mineral of  $\text{Ca}_6\text{Al}_2[(\text{OH})_4(\text{SO}_4)_3]\cdot 26\text{H}_2\text{O}$ . Hexagonal system. Vitreous luster. Optics;  $\omega$ :1.491,  $\varepsilon$ :1.470. Birefringence: 0.021.  $\ominus$ . SG:1.77. H:2-2½. Found in Germany, South Africa, and USA.

**étui**; a small ornamented case for holding cosmetics, or other small articles for women's daily use.

**Etymologiae of Isidore**; → lapidary.

**Eu**; a chemical symbol for the element europium.

**euban**; a variety of rock crystal.

**euchroite**; an emerald green or leek-green copper mineral of  $\text{Cu}_2(\text{AsO}_4)(\text{OH})\cdot 3\text{H}_2\text{O}$ . Orthorhombic crystal. Vitreous luster. Translucent. Cleavage: indistinct. Green streak. Fracture: conchoidal. Brittle. H:3.5. SG: 3.45.  $n_\beta$ :1.698.  $\oplus$ . Frequently used as emerald imitation. Also called Prismatic emerald malachite, emerald malachite.

**euclase**; a very rare gem of light blue color. Sometimes erroneously called prismatic emerald.

System: monoclinic.

Formula:  $4[\text{BeAlSiO}_4\text{OH}]$ .

Luster: vitreous.

Colors: colorless, whitish, pale green, pale blue.

Streak: colorless.

Diaphaneity: transparent to translucent.

Cleavage: {010} perfect, {110} imperfect, and {001} imperfect.

Fracture: conchoidal. Brittle.

SG: 3.05-3.10.

H: 7½.

Optics;  $\alpha$ :1.651,  $\beta$ :1.656,  $\gamma$ :1.673.

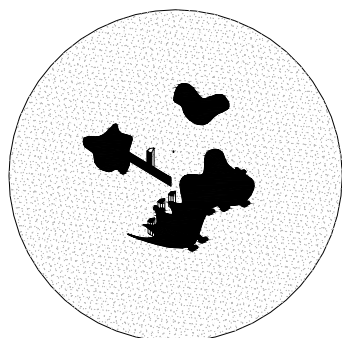
Birefringence: 0.019-0.025.  $\oplus$ .

Dispersion: 0.016.

Found in Russia, Zimbabwe, Brazil, Ireland, Australia, Tanzania, and other sources.

**euclase absorption spectrum**; two weak bands at 468 and 455 nm. Sometimes a doublet at 705 nm.

**euclase cut**; rarely cut as faceted gems with high brilliance but prized by collectors.



*ilmenite  
crystals in  
euclas from  
Minas Gerais,  
Brazil*

**euclase, inclusions in**; usually in euclase from Minas

Grease, Brazil ilmenite crystals as inclusions are seen.

**euclase pleochroism**; deep blue stone from Zimbabwe has azure-blue, dark blue and greenish-blue pleochroism.

**eukotourmaline**; same as eicotourmaline.

**eucriptite**; a colorless to white lithium aluminum silicate  $\text{LiAlSiO}_4$ , which is altered from spodumene, found embedded in albite in Connecticut, USA. Transparent. Trigonal system. SG:2.66-2.67. H:6½. Used in the production of synthetic amethyst to eliminate the smoky purple color caused by aluminum oxide in quartz.

**eu crystalline**; igneous rocks whose mineral grains are holocrystalline and well crystallized. Same as macrocrystalline.

**eu dialyte**; a very rare, weakly radioactive mineral. Red color specimens are similar to garnet. Calcium-rich variety known as euclite.

System: hexagonalic.

Formula:  $4[\text{Na}_4(\text{Ca,Fe,Ce,Mn})_2\text{ZrSi}_{16}\text{O}_{17}(\text{OH,Cl})_2]$ .

Luster: vitreous to greasy, sometimes dull.

Colors: various shade of brownish-red, pink, yellowish-brown, red.

Streak: colorless.

Diaphaneity: transparent to translucent.

Cleavage: {0001} indistinct.

Fracture: uneven. Brittle.

SG: 2.74-3.00.

H: 5-5½.

Optics;  $\omega$ :1.591-1.624,  $\varepsilon$ :1.594-1.633.

Birefringence: 0.003-0.012.  $\oplus$ . sometimes  $\ominus$ .

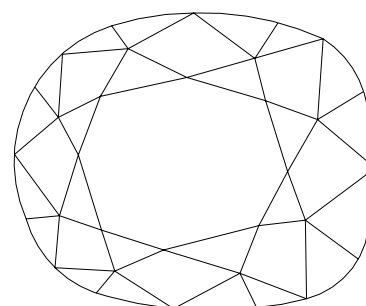
Found in Russia, Greenland, South Africa, Canada, Malagasy, and USA.

**eu dialyte cut**; cut as faceted gems, also cabochon from massive variety.

**eu dialyte pleochroism**; variable pleochroism with body color.

**Eugénie**; → Eugénie Diamond.

**Eugénie Blue Diamond**; a heart-shaped, fancy cornflower blue diamond of 30.82 cts, believed to have



*Eugénie Diamond*

belonged to the Empress Eugénie, wife of Napoleon III of France. In 1910 it was purchased by Cartier's in that same year it went to an Argentinean client and was

renamed Unzue Heart Diamond. It was sold in 1964 to Mrs. Marjorie Merriweather Post, who presented the stone to the Smithsonian Institution in Washington, D.C., USA.

**Eugénie Diamond;** a fine oval-shaped diamond of 52.35 cts, found in Minas Gerais, Brazil, the property of Catherine II of Russia who presented it to Potemkin in 1787, later it was sold to Napoleon III of France and he presented it to his wife Empress Eugénie. Now owned in Antwerp, Belgium. Also called Potemkin Diamond, Eugénie, Empress Eugénie Diamond.

**eugenol;** colorless or pale yellow oily liquid with a spicy taste and an odor of cloves of  $\text{CH}_2=\text{CHCH}_2\text{C}_6\text{H}_3(\text{OH})\text{OCH}_3$ . A phenol homologue, the chief constituent of oil of cloves and cinnamon leaf oil. Slightly soluble in water. Used as immersion oil, RI:1.54. SG:1.07.

**euhedral;** → euhedral crystal.

**euhedral crystal;** same as an exact-formed crystal. Mineral grains displaying fully developed crystal form during crystallization or recrystallization in contrast to anhedral. Also called idiomorphic crystal, automorphic crystal, idiomorphous. → Idiomorph.

**eulite;** → enstatite.

**Eureka Diamond;** the first diamond found in 1866 in South Africa of 21.25 cts, from the Orange River, was named the Eureka. It came into the possession of John O'Reilly a traveling merchant. Purchased by the governor of the Cape Colony, and cut into a 10.73 cts, oval-shaped brilliant. Later it was bought in 1966 by De Beers Consolidated Mines Ltd. and presented to the Parliament of South Africa. Now on display at the Open Mine Museum in Kimberly, South Africa. Also sometimes called O'Reilly Diamond, because he was involved with the examination of the Eureka Diamond.

**European brilliant cut;** a new variation of American brilliant cut or ideal brilliant cut, according to Tolkowsky. It was calculated in 1940 by W. F. Eppler. After new calculation of size and angles was developed in Scandinavia. This was known as Scan. D.N. The table has a diameter of 56%, depth of crown 14.4%, depth of the pavilion is 43.2% according to 100% girdle diameter. The angle of the crown facet is  $33^\circ 12'$ , angle of the pavilion facet is  $40^\circ 48'$ .

**European cut;** → European brilliant cut.

**European emerald;** beryl from Europe.

**European fine cut;** same as practical fine cut.

**europium;** a metallic element of the rare-earth group of the Periodic System with the symbol Eu.

**eutectic;** describing the lowest temperature on a phase diagram, at which a molten mixture forms.

**eutectic alloy;** describing the lowest temperature point, on which an alloy will melt or freeze.

**eutectic point;** having the lowest temperature point, at

which a eutectic mixture or alloy will melt or freeze. Also called eutectic temperature.

**eutectic temperature;** same as eutectic point.

**euxenite;** a member of polycrase group. A niobate (columbite) and tantalite of uranium and several rare earth elements mineral.  $\text{XY}_2\text{O}_6$ , where  $\text{X}=\text{Ca}, \text{Ce}, \text{Er}, \text{Y}, \text{Th}, \text{U}$  and  $\text{Y}=\text{Nb}, \text{Ta}, \text{Ti}$ . Orthorhombic crystal. Black, sometimes with faint brownish or greenish tinge. Opaque. Brilliant, submetallic, vitreous or resinous luster. Optical properties isotropic due to metamictization RI:2.06-2.24. SG:4.30-5.87. H:5½-6½. Found in Kern, California, Pennsylvania (USA), Brazil, Norway, Finland, Zaire, Malagasy, and Australia. Sometimes has been fashioned as a gem. It is isomorphous with polycrase and occurs in granite pegmatite. A variety of this mineral is called loranskite. Cut as a black gem, cabochon and prized by collectors.

**evaluation;** the quality of a diamond is dependent on weight in carat, cutting, proportion of cutting, clarity or imperfection, color grade, and style of cutting or shape. Also called quality.

**evaporate rock;** a nonclastic sedimentary mineral or rock precipitated from water solution due to evaporation such as halite, anhydrite, potash salt, etc.

**evaporation;** the process by which water becomes vapor.

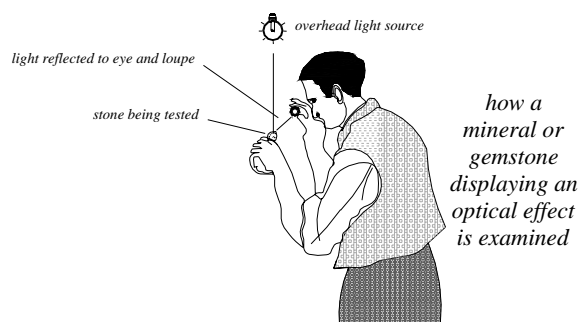
**even fracture;** a type of mineral fracture having a smooth and even appearance.

**evening emerald;** a poetical misleading term for bottle-green peridot or chrysolite (olivine), which loses some of its yellow color due to artificial light. Also called night emerald.

**even-out color;** by dyeing of lapis lazuli because of its variable constitute of calcite, pyrite and lazurite need a highly saturated uniform of blue color for whitish calcite.

**Evyan Aquamarine;** a greenish-blue, scissors cut or cross cut aquamarine of 1,000 cts. It was presented in 1963 by Evyan Perfumes, Inc. to the Smithsonian Institution, Washington, D.C., USA.

**examination of mineral;** for testing a mineral or



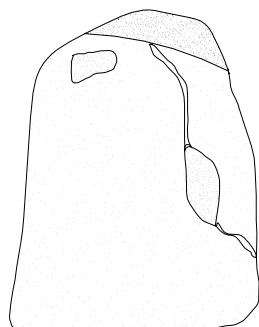
gemstone needing light and a hand loupe by a correct coming light from overhead and an advocated distance between sample and loupe.

**examination of radium-treated diamond;** → scintillation.

**Examolite;** a trademarked term for a diamond lamp designed to provide the approximate equivalent of north daylight, used for grading and displaying of diamonds.

**excavation;** a process of digging or hollowing out materials. Those materials taken from an excavation.

**Excelsior Diamond;** a bluish-white high clarity diamond of 995.20 cts, in rough was found on 30 June



*Excelsior  
Diamond  
in rough*

1893 in the Jagersfontein Mine, South Africa. It was cut by Asscher & Co., Amsterdam, in 1904 and yielded 21 brilliant stones, the largest weighing 69.68 cts, (Excelsior I) to 13.68 cts. The 21 stones that were polished altogether weighed 373.79 cts. The present owner is unknown.

**exceptional white;** a CIBJO color grading system of polished diamonds.

**ex-collection;** the term used by sorters of rough for the finest, extra-white diamonds.

**excited;** a term used for pumping either electrically, optically, or chemically by which emits laser light. Also called pumping. One of the four level laser because rising from ground level. → Inverted population.

**exfoliation;** the process to split or cause to split into thin concentric onion-like shells, flakes, scales, or plates on being heated. Owing to differential expansion and contraction during heating and cooling over the diurnal temperature range. Thickness is less than a centimeter to several meters. Synonym for desquamation, sheeting, and sheet jointing.

**exhalation;** a process of emitting volcanic gases and vaporous at the surface of the earth exposed to the atmosphere. Synonym for emanation.

**exogene;** → exogenetic.

**exogenetic;** the process or event, which takes place at, or very near, the surface of the earth, such as weathering and denudation. Synonym for exogenic, exogenous, and exogene.

**exogenic;** → exogenetic.

**exogenous;** → exogenetic.

**exogenous inclusion;** same as xenolite. → Accidental inclusion.

**exogenous inclusure;** → accidental inclusion

**exoskarn;** a process of forming of skarn by replacement of limestone or dolomite.

**exothermic;** pertaining to a chemical system, which occurs with the evolution of heat with influence of the surrounding environment. Compare endothermic. Also called exothermal.

**exotic;** rocks that has been introduced from other region. Also not autochthonous or allochthonous.

**explosion breccia;** coarse, indurate volcanic debris containing blocks from the walls of the volcanic neck, which is in a matrix of comminuted rock.

**exposing;** same as uncovering, which outcrop at the surface.

**exposure;** a geologic structure area, which is visible.

**exposure meters (photography);** a common instrument for measuring the intensity of light, a certain place upon the microscope, having an adjustable scale for determining the optimum relation of shutter speed and stops at each intensity. Usually used as a photocell by photomicrography from the inclusions. The best type of exposure meter to use is the extinction type such as practos. Also called light meter.

**exsolution;** the separation of individual crystals in solid solution during cooling, such as in plagioclase the perthitic or antiperthitic phase. Synonym for unmixing.

**exsolution mineral;** → exsolution.

**extension;** a measure of length of a line, either vertical or horizontal, specially the ratio of the change in length to the original length.

**external characteristic;** another term for blemish.

**external characteristic;** any surface imperfection.

**external damage on cut diamond;** same as external damage, blemishes. Also called external features on cut diamond.

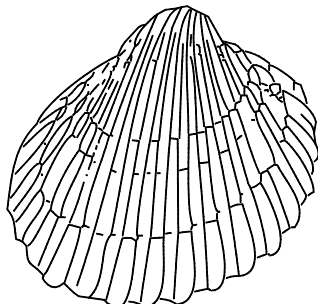
**external damage, blemishes;** a diamond regarded as flawless, when free of external blemishes as well as being clean internally. The main external blemishes are: 1. Scratches, 2. Chips and nicks, 3. Pits or cavities, 4. Flats on the girdle, 5. Naats on the surface, 6. Polishing lines, 7. Burn marks, 8. Natural or naif, 9. Rough girdle, 10. Rough or broken culet, 11. Twinning lines or naat.

**external features on cut diamond;** same as external damage, blemishes.

**external grinding;** grinding the external face of a workpiece by rotation.

**exterior of mussel;** a protective, hard, horny, rigid, outer layer covering of certain salt-water and fresh-water animal such as snail, mollusks, turtles, etc., which consist largely of calcareous, chiefly or partly chitinous, siliceous, or horny. On the exterior hard shell are semiparallel curved lining to seen, which are running from top to outer wings. Shell used as

inexpensive various purposes in jewelry, for carving shell cameos, ornamental objects and utensils. It displays pearly iridescence for making small spoons, knife handles, carving boxes, in jewelry for brooches, finger rings, ear-studs, dress-studs. *Cat's-eye* effect can be produced from black-lip pearl oyster, when cut



*mussel extorjal*

suitably, which misnomerly is called cat's-eye shell. *Paua shell* has bright green and blue colored nacre found on the coast of New Zealand. Some shells are dyed by soaking in organic dyes but the colors are unstable. Other shells such as trochus, pink conch pearl, nautilus, Antilles pearl, sea snail are fished because of their shells. → Shell, using as ornaments. The so-called tortoise shell used as piqué work.

**extinction;** when a doubly refracting crystal is examined between parallel polarized light with the crossed Nicol prisms or polaroid discs and no light is transmitted the mineral must be in an extinction position (the change to dark is known as extinction). There are 4 such positions during a complete rotation of 360°. With isotropic crystals the field remains dark at all positions. Isotropic crystals, when under strain, may show anomalous extinction (anomalous double refraction) always at irregular intervals, rarely orientated at 90°. Also called extinction position.

**extinction area;** frequently on some step-cut, emerald-cut or square-cut stones due to too-steep pavilion angles, which reflects the light on one side and pass out through the opposite side. When viewed through the table it seen as a dark area usually nears the girdle.

**extinction pattern;** anomalous double refraction also occurs in diamonds under strain and it will be determined whether a stone in polarized light to discover the strain in it forms the extinction pattern.

**extinction position;** → extinction.

**extra color;** a classification for diamonds at their source for the second finest color grade.

**extract;** → essence d'orient.

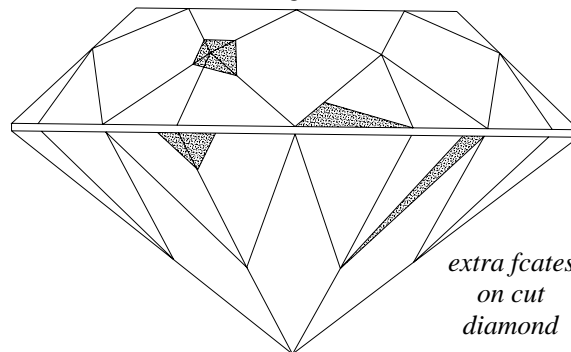
**extraction;** a term applied to removal of diamonds from concentrate.

**extraction;** chemical operation of removing one or more substance from others by means of a solvent. Used in

obtaining a metal from its ore.

**extra dense flint glass;** a variety of flint glass containing potassium and lead oxide, which replaces a considerable part of the lime and soda with RI:1.962. SG:6.33. H:5.

**extra facet;** a small facet, occasionally added to those required by the cut, usually to remove a poor part or blemished part of the stone, such as chips, naturals, and nicks. Sometimes it is caused by errors in the polishing. Usually it is seen near the girdle. When extra facets are relatively large, they downgrade the make, but very small facets do not downgrade the stone in the clarity



*extra fcates  
on cut  
diamond*

scale. Also called false facet. Not to be confused with additional facets.

**extra-fancy gem blue;** a term used for a fine color of diamonds, it is often used for lower grades.

**extraordinary ray;** that ray, for which, in a uniaxial crystal belongs to the hexagonal and tetragonal systems, the refractive index or velocity various according to its direction through the mineral. Synonym: extraordinary wave. Abbr. e-ray or  $\epsilon$ . → Double refraction, ordinary ray, optic sign, Nicol prism.

**extraordinary refractive index;** same as the refractive index of extraordinary ray.

**extremely brittle;** a term applied to a kind or degree of brittleness can be seen in black tourmaline parallel to *c*-axis which can be found in Mysore State, India.

**extrinsic semiconductor;** a term used in crystallography for increasing of semi-conductivity caused by impurities in a crystal or stone. → Semiconductor, intrinsic semiconductor, idiochromatic.

**extrusion;** the process of magmatic material or lava flowing out from the crust upon the earth's surface from vents or fissures. A contrast to intrusion.

**extrusive;** → extrusion.

**extrusive rocks;** an igneous rock that has been ejected onto the surface of the earth, such as lava, and detrital material such as basalt, andesite and volcanic ash. Normally fine grains or even glassy. Synonym for volcanic rock, effusive rock, eruptive rocks. → Intrusive rocks

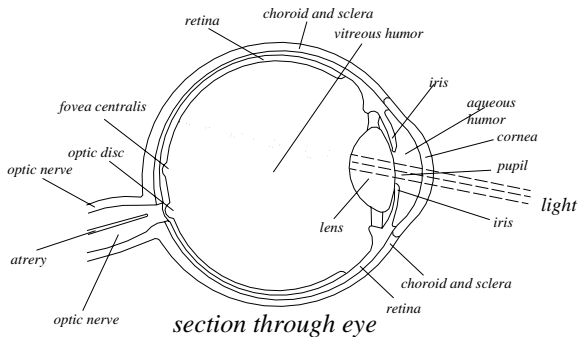
**extrusive andesite;** → extrusive rocks.

**extrusive basalt;** → extrusive rocks.

**extrusive igneous rocks;** → extrusive rocks.

**exuding tree, amber;** an old herbal fable say that the drop of sap flourishing from the trunk of gnarled tree such as an old woodcut of Hortus Sanitatus, 1491.

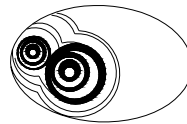
**eye;** the most important instrument for testing a mineral, gemstone, rock, or other material when it is trained. The pair light or photoreceptive sense, spherical organ of animals that is capable of forming impressions or vision, each is located in a bony orbit at the front of the



skull, which is innervated by an optical nerve from forebrain. The eye range from the ocellus with a single lens found in insects and other invertebrates, to the vertebrate eye. In such an eye sight or light is focused by a lens imbedded onto a *retina* consisting of light sensitive cells in the form of rods and cones. The consisting of many layers are as following: *cornea*, *sclera*, *choroids*, retina and *vitreous humor*. *Cornea* is in the front of eye, behind of them is the *aqueous humor*, the part of eye after cornea, consists of dilute slightly saline solution, which passes through pupil, the opening in the adjustable iris. The *iris*, which controlled the size of the *pupil* to determine the amount of entering light. The shape and focus of the lens is controlled by ciliary body which be controlled by automatic nervous system. Light after entering the eye focused on the retina. *Fovea centralis*, a small depression or pit on the retina at the back of eye in the line with the visual axis. *Optic disc*, the small circular area in the retina of eye, which converged the fibrous from the ganglion cell to form the optic nerve. Light passes through the full layers from the front of eye reach the rods and cones at the back of retina, those part of light not absorbed by rods and cones will be absorbed by pigmented epithelium because confusing reflections back of light into the eye. When light absorbed by rod and cone an electrical signal will send along the *axon*, a process of nerve fiber of a neuron that conducts impulses from the nerve cell body. *Synapse*, the contact points with axon of bipolar nerves and influence the dendrites of another nerves of eye. Also called *oculus*.

**eye;** same as eye bead.

**eye agate;** a variety of banded agate, onyx, chalcedony, or sardonyx, in which the delicate colored bands are circularly arranged in such a way that they resemble an eye. The lines of banded colors can be white, pale and dark brown, black, blue, wax-like or some other



eye-agate

shade. Lines are usually wavy, sometimes straight, and concentric. A variegated variety of chalcedony. Source: worldwide. Also called eyed agate. Synonym for Aleppo stone.

**eye bead;** large varieties of beads, which are usually made of glass and resemble an eye. They were always regarded as talisman.

**eye-clean;** an undesirable clarity-grading term that means no internal flaws, which are visible to the unaided eye of a diamond-clarity grader.

**eye, color response of;** → color perception.

**eyed agate;** same as eye agate.

**eye diamond;** a term applied to fish-eye diamond.

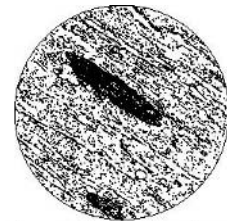
**eye glass;** the term applied to any glass to aid vision.

**eye glass;** lens for aiding or correcting the vision.

**eye glass;** another word for eyepiece or eye loupe used by jewelers.

**eyeglass, watchmaker's;** → watchmaker's eyeglass

**eye-gneiss;** a general term for coarsely crystalline regional metamorphic rock of granitic composition, containing lenticular, eye-shaped masses of feldspar or



section of an eye-gneiss under microscope

quartz embedded in a finer matrix.

**eye lens;** a term for any lens system placed between the viewer's eye and object in the small end of a transit or level (microscope and telescope), which enlarges the image of



eye-loupe

the object. Also called ocular or eyepiece.

**eye loupe;** a convex piece of glass used for magnifying an object mounted for use in the hand (hand loupe). Loupes may consist of two or more pieces, generally of different types of glass in order to improve better image, these are known as compound loupes.

**Eye of Brahma diamond;** same as Black Orloff

diamond.

**Eye of Brahma;** same as Black Orloff (diamond).

**eye of opal;** a term used by Australian miners for a Bug-hole opal with an eye-shaped pattern due to circles of colors around it.

**Eye of Shiva diamond;** same as Nassak Diamond.

**eye perfect;** undesirable term that means no internal flaws that is visible to the unaided eye of a diamond-clarity grader.

**eyepiece;** any lens or combination of lenses acting virtually as a magnifying lens in a microscope nearest the eye of the observer. Also called ocular, or ocular lens. Also spelled eye piece.

**eye piece;** another spelling of eyepiece. → Eye lens.

**eyepiece, binocular;** microscope with a pair of ocular eyepiece.

**eyepiece, goniometric;** → goniometer eyepiece.

**eyepiece, Huygenian;** → Huygenian eyepiece.

**eyepiece, indicating;** → indicating eyepiece.

**eyepiece, microscope;** → microscope eyepieces.

**eyepiece, Ramsden;** a lens system used in microscopes, which consists of two planoconvex lenses both placed with their surfaces toward one another and the incident ray. With this eyepiece 5 minutes of arc be read by means of a Vernier, which is fitted as eyepiece goniometric. Also known as positive lens. → Ramsden eyepiece.

**eyes;** occurring of variscite with eyes of wardite.

**eyes;** → eye agate.

**eye stone;** → eyestone.

**eyestone;** agate, which has a center spot more highly colored than the surrounding concentric layers, therefore resemble the eye.

**eyestone;** same as banded thomsonite.

**eyestone;** → operculum.

**eye visible;** any thing that can be seen with the unaided eye.

**ezteri;** a term employed to a variety of bloodstone or green jasper with reddish veins.

**ezurite;** a term used for fine grained granitic rock.

## F f

**f**; abbreviation for flawless.

**F**; a chemical symbol for the element fluorine.

**°F**; abbreviation for degrees Fahrenheit.

**F**; one of the Fraunhofer lines in the blue part of the solar spectrum. Its wavelength is 486.10 nm. The second line in the Balmer hydrogen series.

**Fa**; an abbreviation for the mineral fayalite.

**Fabergé's Egg**; → Swan-Egg Emerald.

**fabric**; a term applied to the sum of all the structural, textural and orientation features of a rock. Sometimes called orientation. Synonym for petrofabric, structural fabric, rock fabric.

**fabricated gemstones**; same as composite stones.

**fabulite**; a misleading commercial term for synthetic produced strontium titanate. Used as a diamond imitation. When occurring in the natural state with the same composition is called *tausonite*.

**fabulite brilliant**; a misnomer for a brilliant-cut stone of synthetic strontium titanate.

**face**; in crystallography a natural, flat surface characteristic of a crystal, as distinguished from a man-made facet.

**face**; a manufacturer's term used by brilliandeering for a group of facets composed of two star facets and 4 upper-girdle facets, which can be placed on a diamond in the dop. → Set.

**face**; a term used by Australian miners for the end of tunnel where the search of opal takes place.

**face**; a term used by Australian miners for an opal that part of them being polished for exhibition.

**face**; a term used by Australian miners for showing color of the opal when looked directly from any angle.

**face**; same as crystal face.

**face**; same as face up.

**face (mining)**; the outer surface where mining occurs.

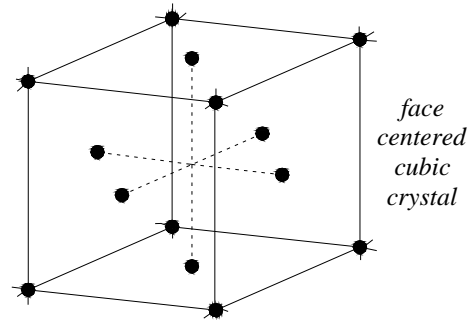
**face-centered cubic crystal**; in crystallography a crystal unit cell in the cubic system, in which an atom is located at each corner and one at the center of each six-faced cube.

**face, crystal**; → crystal faces.

**faceted crystal**; a commercial term for a natural mass of rock crystal bounded by one or more of the original crystal faces.

**face down**; the position of a cut gem or diamond when the pavilion or culet of the stone is facing the viewer, usually the position when diamonds are face down for

color grading. → Face up.



**faces**; in gemology the entire group of geometrical faces that can be placed on cut gemstone or diamond.

**facet**; a term applied to a polished plane-geometrical surface of a cut diamond or other gemstone of various shapes and sizes. In French spelled *facette*.

**facet**; sometimes also used for the inclined facet at the top of a prismatic crystal.

**facet**; the flat side of a crystal.

**faceta**; Spanish spelling for facet.

**facet alignment**; exact replacement of crown and pavilion facets so that the bottom points of the bezel facets are directly above the top points of the pavilion the main facets in regard to symmetry.

**facet angle**; the interfacial angle between the surface plane of two facets and the girdle plane.

**facet cut**; a term used to distinguish faceted gems from cabochon cut or other unaffected stones. Also called faceted cut. → Facet.

**facet design**; fashioning and preparation of the facets on a gemstone or diamond.

**facet diagram**; the geometrical drawing of a gemstone or diamond facets design of both crown and pavilion. In diamond grading, when blemishes and inclusions are indicated on an adequate facet diagram, it is known as a plot or symbols for representation of the external features including lines, dot, letters, icons, and often specific colors is known as plotting symbols. The process of recording on the facets is called plotting. → Blemish external.

**facet, extra**; → extra facet.

**facet rough, examination**; the preliminary examination of facet rough.

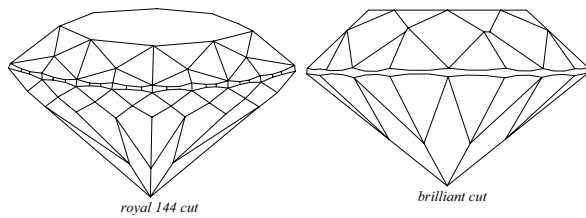
**faceted boulder**; boulders, which are ground flat on one or more sides by the grinding action of a glacial region. → Faceted pebble.

**faceted cut**; → facet cut.

**faceted girdle**; a term employed to the girdle of a diamond cut stone (or other gemstone), on which there are many small facets, planes or nearly planed, then polished to improve the brilliance of a cut gem. A girdle with 40 facets is found on the *amulet-facet diamond* and on a *royal 144 cut diamond*. Also called



girdle facet.

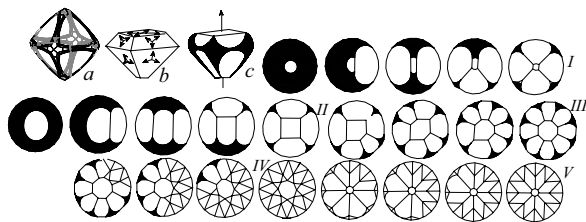


*faceted girdles*

**faceted pebble;** the term applies to a three-edged faceted stone formed by natural agents, such as by wave erosion, the grinding action of a glacial region or wind action in the dessert. The same as windkanter. → Faceted boulder, dreikanter, einkanter.

**faceted stones;** generally a faceted diamond or other stones used as an ornament. The form or style used in the fashioning of gemstones, such as brilliant-cut, emerald-cut and step cut, etc.

**faceting;** the process of placing facets on a gemstone or



*brilliant-cut diamond from an octahedron crystal. a: crystal, b: four and three point on diamond and c: side view for first facets on the stone  
step for step faceting of a round brilliant-cut diamond*

diamond so as to have covered it completely. The proper faceting results in greater brilliance by reducing the amount of reflected light that escapes.

**faceting;** faceting stones results in emphasizing the color rather than brilliance. There are a few of styles of facet cutting such as table cut, pyramid cut, rose cut, brilliant cut, etc. When faceting a gemstone must be avoided over-heating, which results in thermal expansion and the sequence is a defective facet or a split stone.

**faceting heads machine;** an apparatus device used in gem cutting industry, mostly as self-contained units with mechanical faceting heads, in which the small gemstone or diamond is held between steel jaws, which enables the gem to be semi- or fully-automatically adjusted without re-setting. → Master lap.

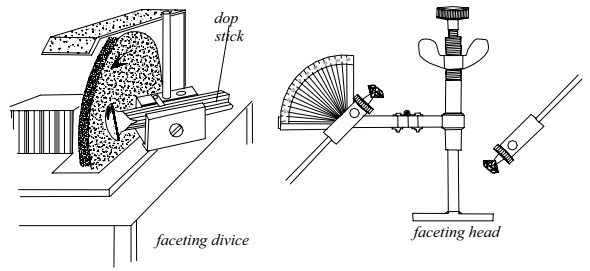
**faceting machine;** any mechanical apparatus for holding diamonds or other stones during grinding or polishing of facets upon them.

**faceting machine;** any automatic apparatus used for

*faceted pebble – facets on a step-cut stone*

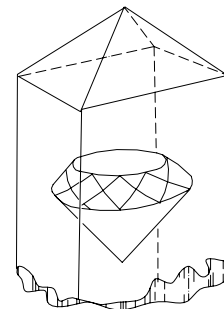
cutting gems. Also called faceting tool.

**faceting tool;** same as faceting machine.



*two different faceting devices*

**faceting zircon from rough stone;** a modified style of



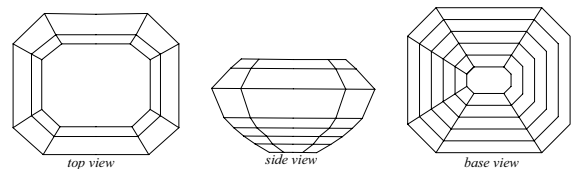
*cutting and faceting of zircon*

cutting a brilliant or transparent stone with an extra row of sixteen (sometimes 8) triangular facets, which replace the culet on the pavilion.

**facet junction;** same as rib line.

**facets of a brilliant-cut diamond;** → situation of facets on a brilliant cut diamond.

**facets on a step-cut stone;** a rectangular or 4-sided (6 or 8-sided) trap-cut with long, parallel, usually narrow facets. Favored for emeralds and diamonds and other transparent colored stones with the corners beveled and all surfaces covered by a series of rectangular or square facets or steps on the crown and pavilion, parallel to girdle. Usually on the crown there are two or three



*step cut*

rows, and two or three rows on pavilion, this may vary, depending on the size of the stone. The table is large and the outline of such a stone can be rectangular, square, octagonal or hexagonal, drop-shaped,

trapezoidal, step-cut bead, lozenge-shaped, oval or semi-circular, which is known as *lunette*. Different forms of step cut are expressed by their outline, such as square step-cut, baguette cut, rectangular step-cut, emerald cut, cross cut, carrée cut, calibré, scissors cut, etc.

**face, to the;** a local term used by English miners for the initial of tunnel where the search of jet takes place.

**facets proportion;** a term employed to the practice of round brilliant-cuts often the lower girdle facets are longer than the proportion of a brilliant-cut.

**face up;** a cut gem or diamond with the table of the stone facing the viewer, usually the position, in which a mounted stone is observed. → Face down.

**face up;** a term used by Australian miners for clean up, grinding and polished stone to enhancing surface. Also called face.

**face-up appearance;** brilliance, color and clarity are observed, when a cut diamond is viewed from above the table.

**face-up color;** the color that is observed, when viewed from above the table.

**face-up well;** observation of higher color grade that occurs when fancy color diamonds are examined face up.

**Fachmitglied der Deutschen Gemmologischen Gesellschaft;** a title awarded by to holders of the fellowship diploma of the German Gemological Association. Abbreviation: FGG.

**facial indices;** the relationships of facets by reference to its crystallographic axis system.

**facies;** a term suggested for the sum total of the lithological and palaeontological characters of sediment exhibited by a deposit.

**facsimile;** an exact copy. Means reproduction, imitation, or synthetic stones.

**facsimile crystallization;** mimetic crystallization.

**factors influencing esteem of gems;** the important factors influencing esteem of gems are attractiveness, durability, rarity, fashion, and size, because these affect the value so directly.

**factory;** the largest Neolithic find of amber and other stone was discovered in north of Liepaja on the Baltic shore in 1960. There are find flint amber and bone tools, some splinters of flint for cutting lumps of amber.

**fade;** to lose brightness, color, or clarity. An oily or whitish surface is the result of faceting.

**fade;** lower saturation of color. Also called whiter. → Color,-definition, saturation.

**fading;** partial or complete loss of color or any undesirable change of color in gemstones. Excessive heat treatment.

**fading stones;** → fading.

**fade test;** partial or complete loss of color or any undesirable change of color in sapphire when it is radiation induced. By carefully heating the stone with a cigar lighter (may damage the stone because thermal shock) or with a spotlight of 150-200 Watt by 1 cm distant the stone will fade within 1-2 hour or less when it is irradiated. Untreated stones are generally not affected.

**Fahrenheit (scale);** thermometer graduation, in which the freezing point of water is 32° and the boiling point is 212°. To convert from Fahrenheit scale to the centigrade grade, subtract 32, multiply by 5 and divide by 9. Symbol° F. Then

$$^{\circ}\text{C} = (^{\circ}\text{F}-32) \times 5/9.$$

**Fahlun brilliant;** another spelling for falun brilliants.

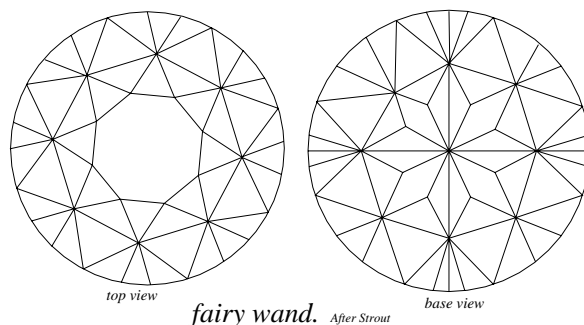
**faience;** tin opacified, glazed porous terra cottas or earthenware, especially made in middle Europe. In ancient times used to imitate opaque stones such as lapis lazuli, and turquoise. Also spelled fayence, fayance. → Ceramic.

**fairburnite;** fortification agate from South Dakota, USA.

**Fairvalley;** a small alluvial diamond mine in Barkly West, South Africa.

**fairy stone;** a fanciful term for cruciform, twinned staurolite crystal or an imitation of it. Also called cross stone.

**fairy wand cut;** a modified round brilliant cut with 48 triangular facets and a 6-sided table in the crown and 32



triangular facets, 8 four-sided lozenge star without culet.

**faisel;** same as fezel.

**faizel;** same as fezel.

**Faith Diamond;** a stone of exceptional size found in 1871 at the old De Beers Mines, South Africa.

**fake;** a gemstone or precious natural article that has been changed or added to improve its market value or sold them, with intent to deceive. For example: heat-treatment, irradiation, etc.

**fake inclusions in amber;** → amber, imitation.

**fake opal;** a variety of opalized quartz.

**fakey rock;** flaggy sandstone. → Flags.

**falcondoite;** → meerschaum.

**falcon's-eye;** same as hawk's-eye. A silica pseudo-morphous of blue crocidolite, which has not suffered oxidation, when cut en cabochon exhibits chatoyancy.

**Falerian;** an ancient city in central Italy, a region of Etruscans, famous for golden-yellow white wine celebrated by Hoarce.

**fales;** any stone with two or more differently colored layers.

**false;** a term used by Australian miners for an opal when it is insufficiently or inefficiently cut and frequently after grinding leaves a blurry surface over the colors.

**false;** a term used by Australian miners for an opal shaft when a level or tunnel of a shaft taken off, not strictly at the right geological position.

**false amethyst;** a misleading term for purple fluorite, when cut as a gem.

**false chrysolite;** a misleading term applied to moldavite.

**false cleavage (parting);** same as parting or pseudo-cleavage. Separation of crystal along certain planes that are not true cleavage planes, due to lamellar twinning such as corundum. Also called pseudo cleavage, fracture cleavage, closely spaced jointing, rift, failure cleavage.

**false cleavage (parting);** a small split in a rock in contrast to true or dominant cleavage.

**false color;** a term applied to the color of stones caused by fluorescence. An earlier term for stone, that was able to change its color in different lights. False color makes infrared differences evident.

**false colored diamond;** a promotion term for a pale yellow diamond that fluorescence blue in daylight and therefore appears better than under incidence light.

**false diamond;** any colorless mineral, when cut and polished makes brilliant gemstones such as zircon, white sapphire, topaz, and quartz. All four, however, are birefringent and can be easily distinguished from true diamonds by optical or other physical tests.

**false doublet;** any assembled stone or composite stone, which is not genuine crystal or simulated crystal cemented together. → Doublet.

**false emerald;** a misleading term for green fluorite.

**false emerald;** a misleading term for malachite.

**false facet;** sometimes used for extra facet.

**false form;** same as pseudomorph.

**false fossils;** mineral structures imitation organisms.

**false hyacinth;** a misleading term for hessonite garnet.

**false jade;** undesired and misleading term for sillimanite.

**false lapis;** another misleading term for lazulite.

**false lapis;** a misnomer for agate or jasper artificially stained blue to imitate lapis lazuli, which is known as Swiss lapis or German lapis.

**false lapis lazuli;** another misleading term for lazulite.

**false lapis lazuli;** a misleading term for dyed agate or jasper.

**false nephrite;** a misleading term for green variety of serpentine, vesuvian, or other green mineral similar to nephrite and jadeite. Also called falso-nephrite.

**false ruby;** a misleading term for red colored fluorite.

**false ruby;** a misleading term for some species of red garnet (cape ruby).

**false ruby;** a misleading term for some species of red spinel such as balas ruby, ruby spinel.

**false sapphire;** a misleading term for blue fluorite.

**false topaz;** a misleading term for yellow variety of quartz or citrine.

**false topaz;** a misleading term for yellow variety of fluorite.

**false triplet;** → false doublet.

**false white stone;** any blue fluorescence stone with tinted yellow complementary body colors, which may cancel each other out so that in the same conditions the stone appears white.

**falso-nephrite;** same as false nephrite.

**falun brilliant;** a commercial term for blue colored lead glass used as a gem or diamond imitation.

**famous diamonds;** all famous diamonds are large by present-day standards and are mentioned in most gemological books. See table 20 end of book.

**famous pearls;** all famous pearls are large such as *The Hanover Pearls*, *La Reine Perle* (Collier de la Reine), *Mancini Pearls*, *La Peregrina* (Philip II Pearl), and *The Orange Pearls*.

**fan cut;** same as fan-shaped cut.

**fancies;** an attractively colored diamond such as emerald green, sapphire blue (of poor color), red, canary, orange, pink (seldom more than a tint), tints of violet, reddish-brown, coffee-brown, golden-brown, blue (the darker rare), and black.

**fanciful cut;** → fancy cut, fancy diamond.

**fancy;** an attractively colored diamond other than white used for a gem. → Fancy diamond.

**fancy;** stones prized for other qualities other than intrinsic value.

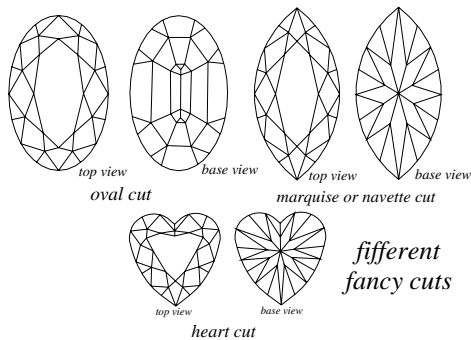
**fancy agates;** a variety of agates showing delicate markings and intricate patterns.

**fancy colored diamond;** same as fancy diamond.

**fancy colored imitation pearls;** after essence d'orient is finished to which a coloring agent is added to provide a material for fancy imitation pearls. → Stained pearl, fancy colored pearl.

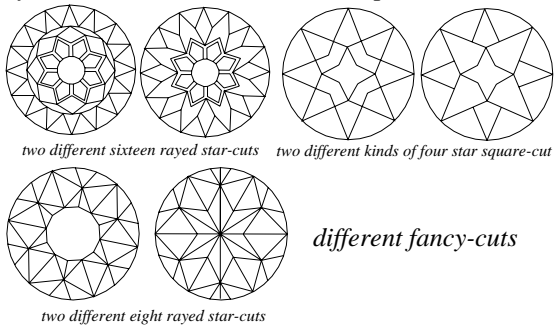
**fancy colored pearl;** pearls that are of unusual natural colors such as yellow, blue, green, bronze, metallic-hued, gray, brown or black. Color of pearls are due to conchiolin-rich center (also called mud center) which affected a dark color, yellow and black caused by organic pigments in nacre. Gold-lipped, silver-lipped and black-lipped oyster produce pearls of comparable hues. Blue color is due to conchiolin-rich center. Gold-colored pearl is fished in Shark-bay, from a smaller *Pinctada carchariarum* oyster. Black-colored natural and cultured pearl is fished from *Pinctada margaritifera* oyster in Tahiti. Value of fancy colored pearl is less than that of rosée pearl of comparable size and quality. → Stained pearl, blue pearl.

**fancy cut;** any style of diamond cutting other than the round brilliant cut, which are rarely used such as marquise, emerald cut, pear-shaped cut, baguette,



pentagon, half moon, mixed cut, irregular forms, unique cut (one-of-a-kind) triangle, key-stone, etc. Synonym for modern cut. Also called fanciful cut. → Fancy shapes.

**fantasy cut;** a term used in jewelry to some carving styles, which are miniature sculptures and unlike



cutting styles and are cut from transparent single-crystal materials with relatively free outline form. → Fancy cut.

**fancy diamond;** any gem variety of diamond with a natural color, which has a definite shade of color, such as emerald green, sapphire blue, red, canary, orange, pink, tints of violet, reddish-brown, coffee-brown, golden-brown, blue, and black. Some green and yellow-colored diamonds may have been treated. Treated

diamonds are not fancy diamonds, but sometimes called treated fancy diamond. → Fancies.

**fancy pearl;** any strongly colored natural pearls such as white, cream, rosé orient, green, blue, blue-green, violet, purple, red, gray, and dead black. → Fancy diamond.

**fancy sapphire;** any hue of sapphire other than blue or colorless, although colorless is included by some.

**fancy sapphire;** a commercial term used for small colored stones with fancy cut.

**fancy shaped diamond;** → fancy shapes.

**fancy shapes;** the term applied to any diamond cut or other transparent gemstones other than round brilliant such as oblong, pentagon, marquise, emerald cut, pear-shaped cut, baguette, half moon, triangle, key-stone, etc. → Fancy cut.

**fancy stone;** any fancy colored diamond with a natural body color such as red, pink, blue, and green, which are very rare, orange and violet are rare, strong-yellow, yellowish-green, brown and black colors are common.

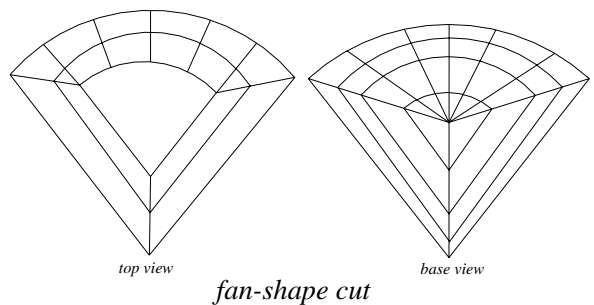
**fancy stone;** gemstone, which is less often encountered in trade, such as a fancy sapphire.

**fang;** the root end of the tooth of mammals. → *Crusta petrosa*.

**fanglomerate;** a term generally applied to a coarse material of conglomerates and breccia formed by the sedimentary in an alluvial fan and later cemented into firm rock.

**fanjieshi;** a Chinese term for green calcite used as jade.

**fan-shaped cut;** a rare style of cutting gemstone, which



resembles an opened fan. Also called fan cut.

**fantasy cut;** blue irradiated topaz or tourmaline, when suitable for cutting or carving. → Fancy cut.

**Farby-Perot etalon;** → etalon.

**Farby-Perot interferometer;** → etalon.

**Faraday dark space;** appearance of a dark region in a gas-discharge tube between the negative glow and the positive column. An illustration under gas-discharge tube. → Positive column, negative glow.

**Farah turquoise;** a fancy commercial term for dark blue turquoise simulant made by Gilson, France. A medium blue colored material is named as *Cleopatra*

*turquoise.*

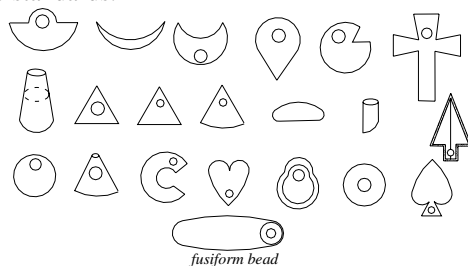
**Farah Diba's Crown;** at the coronation of Mohammed Reza Pahlavi, Shah of Iran in 1967 his wife, Farah Diba wore a crown made by Van Cleef and Arples of Paris. It is a lovely fantasy in red, white, and green-Iran's colors. The crown had been completed of 36 emeralds, 36 red spinels, and rubies. 105 Large, natural, high quality pearls, and 1,469 small diamonds for trim. The principal stones are two carved emeralds. It is now on display at the National Jewel Treasury of Iran, Tehran. Open to the public. Also called crown of the Empress Farah.

**Farah Diba's Tiara;** a platinum, diamonds, emeralds tiara made for Farah Diba upon her marriage in 1959 to Mohammed Reza Pahlavi, Shah of Iran. It is decorated with 324 diamonds and several emeralds, and has below the central emerald the pink Nûr-ul-Ain Diamond. It is now on display at the National Jewel Treasury of Iran, Tehran.

**farming cultured pearls;** a term means the center of pearl fishers.

**fashion;** the value and affecting factor of a gem increase with the rarity, attractiveness and fashion of the stones. A decreasing of interest is seen in garnet from Bohemia (Czech Republic), and an increasing trend is seen in turquoise favor. → Fashion, affecting value.

**fashion, affecting value;** the price and affecting factor of fashioned gem are related to the rarity and attractiveness. The attractiveness is whole-bound on time standards.



*new-fashion-cuts. Cabochon or round cut*

**fashioned gemstone;** any gemstone, which has been cut and polished.

**fashioning;** general name for sawing, cleaving, rounding up, faceting, polishing and other operations of manufacturing of diamonds and other gemstones. Also called fashioning of stones.

**fashioning;** in diamond industry a term for brutting.

**fashioning of stones;** the term applied to the cut form and polish of gemstones, such as cabochon-cut, brilliant-cut, rose-cut, briolette, zircon-cut, cameo, intaglio, cuvette, step-cut, fancy-cut, seal-cut, scissors-cut, cross-cut, mixed-cut, etc.

**fashoda garnet;** any dark red to brown pyrope garnet from Tanzania. → Fashoda-ruby.

**fashoda-ruby;** an incorrect term for iron-rich pyrope garnet, which has been mined in the hornblende-schist in Tanzania and was sold as Cape ruby, or fashoda-ruby. Also called fashoda garnet.

**fashoda-ruby;** a misleading commercial term refers usually to any red garnet.

**fastener;** a hook, button or eye which joins the beads of a necklace together for opening or closing the string. There are many different fastener such as tubular snap, hook, plate, eye, ring, etc., made of precious metals or gemstones.

**fat amber;** a term applied to an opaque yellow to yellowish amber.

**Father of Mineralogy;** a name for German scientist Georg Agricola.

**fathom;** a unit of measurement generally of marine depth, equivalent: 6 feet or 182.88 cm.

**fat stone;** another term for nephelite with greasy luster.

**fatty;** same as greasy mineral luster. → Greasy luster.

**fatty amber;** slightly turbid amber, which contained gas bubbles and then resembling goose fat. Also called flohmig amber.

**fatty luster;** same as greasy luster.

**flaw;** in gemology sometimes used as a synonym for flaw or imperfection.

**fault;** in mineralogy a term for dislocation in a crystal structure. → Faulty structure.

**fault;** a term used by Australian miners for fractures resulting from tectonics in which may opals or other gems are forming or may fill a slide.

**fault gouge;** a term used for cryptocrystalline matrix of soft, pulverized and uncemented mass of clay or clay-like material which is found between faults and their walls in tectonic fracture. Sometimes tourmaline and other gem materials occurring in it.

**faultless;** synonym for flawless or perfect.

**faulty structure;** In mineralogy a term for dislocation in a crystal structure, also subsequent separation or breakage between the atomic plane, such as cleavage, cloudy effect, or feather. → Fault.

**faustite;** a pale green, yellow-green to white-green, zinc-rich member of turquoise group. Triclinic system but cryptocrystalline. Formula:  $[(Zn,Cu)Al_6(PO_4)_4(OH)_8 \cdot 4H_2O]$ . RI:1.612. SG:2.90. H:4.5. Found in turquoise mines Baghu and Neyshabour, Iran.

**favas de zirconio;** in Brazil a local term for rounded pebbles of baddeleyite.

**favas;** in Brazil a local term for many water-worn, bean-shaped, brown pebbles, consisting of tourmaline, kyanite, perovskite, rutile, anatase, and chrysoberyl, which the miners called favas, that is a good indication

of the possible presence of diamonds.

**favosites**; any tabular, slender corallite fossils of the family of Favositidae characterized by massive colonies.

**fayalite**; an end member of the isomorphous of olivine group with chemical formula of  $4[\text{Fe}_2\text{SiO}_4]$ . Orthorhombic crystal. Luster: vitreous to greasy. Greenish, yellow, yellowish to brown color. Streak: colorless. Transparent to translucent. Cleavage: {010} imperfect and {100} imperfect. Fracture: conchoidal. Brittle. Optics;  $\alpha$ :1.827,  $\beta$ :1.870,  $\gamma$ :1.880. Birefringence: 0.053.  $\ominus$ . Dispersion  $\approx$  0.020. SG: 4.32-4.33. H:6½-7. It is pleochroitic. Found in Fayal in the Azores. → Peridot, chrysolite. Synonym for iron olivine. Abbreviation: Fa.

**fayance**; other spelling of faience.

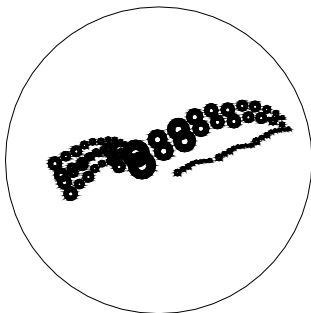
**fayence**; other spelling of faience.

**fazenda fina**; a local term in Brazilian for small, slightly tinted but fine-quality diamond crystals.

**Fe**; a chemical symbol of element iron.

**feasibility**; a scale of six minerals arranged in order of their feasibility, determined by von Kobell as follows: 1-stibnite melting at 525° C, 2-natrolite melting at 965° C, 3-almandine-garnet melting at 1200° C, 4-actinolite melting at 1296° C, 5-orthoclase melting at 1300° C, 6-bronzite melting at 1380° C. Feasibility is not the same as melting point.

**feather**; a series of elongated and irregular liquid or crystalline inclusions that resembles a feather,



*typical feather made of bubbles in a paste*

sometimes found in natural crystals of ruby, sapphire, paste, etc. Some of the cleavage or fracture in diamonds is so shallow that they appear to be a scratches at first glance, such feathering is called *hairline feather*. Also called flag. → Flaws, glets, inclusions.

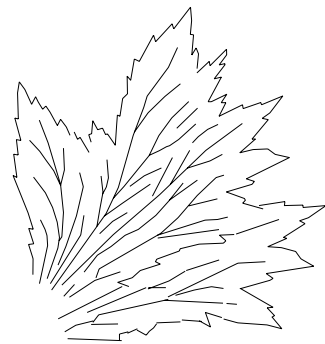
**feather**; generally a commercial term for any flaws inside a gemstone. Also called flag. → Flaws, glets, inclusions.

**feather**; a cleavage crack or a jagged irregularly shaped fracture near the surface in a gemstone that resembles a feather, usually whitish color.

**feather**; → fezel.

**feather agate**; a variety of agate with broken layers, which resembles a black feather.

**feather aggregate**; a kind of aggregate similar to the feather or feather-like.



*feather or plumose aggregate.*  
After sinkankas

**feather amphibolite**; a metamorphic rock of the amphibole (usually hornblende), which tends to form stellate sheaflike groups on the planes of schistosity.

**featheredge**; same as knife-edge.

**feather (glass)**; a cluster of fine particles due to foreign material entering the glass casting or shaping.

**feather gypsum**; another term applied to satin spar.

**feather ore**; a term used for plumose or acicular form of stibnite. Also called jamesonite.

**feather quartz**; a variety of quartz in imperfect crystals, the bases, of which meet at an acute angle along a central plane that resembles a feather when a cross section is cut.

**feather zeolite**; same as hair zeolite.

**feathered girdle**; same as bearded girdle.

**feathering**; feather- or plug-like figures appearing in defective glazes.

**F center**; same as color center. The initial F derived from German word Farbe for color. Hole centers in crystals that are formed by a negative ion vacancy with two bound electrons, which subsequently give the color of minerals, caused by irradiation with X-rays. → Frenkel defects.

**Federal Trade Commission**; a United States government body, which regulating merchandise. Its Trade Practice Rules for jewelry promotion and products of those industries, establish trade-practice rules and eliminate unfair trade practices, specially by advertising and sale of diamonds, gemstones, pearls, gold, silver, and platinum. Abbreviation: FTC.

**Federation of South African Gem & Mineralogical Societies**; Headquarters for this society are located at: 62, Hillcrest Drive, Bluewater Bay, and P.O. Box Swartkops, Cape Province, South Africa.

**Fedorov stage**; same as universal stage.

**feicui**; a Chinese term for Myanmar, (Burmese) jade.

**fei-ts'ui**; an originally Chinese term for an opaque brilliant emerald green or bluish green variety of jadeite from Myanmar (Burma) which means kingfisher because resembling the color of the brilliant

blue-green back of the kingfisher bird hence it is called Kingfisher jade. The term fei-ts'ui originally was given to a green nephrite from Turkistan.

**fei-ts'ui**; now applied to any varieties of jadeite excluding the opaque dark green. → Maw-sit-sit, Chloromelanite.

**feinig**; a term applied to diamond with grains in regular layers.

**feldspar**; → feldspars.

**feldspar apyre**; a French term for andalusite mineral.

**feldspar cleavage**; generally feldspars having an easy cleavage in three directions as {001} perfect, {010} nearly perfect, and {110} imperfect, (orthoclase {100}, {110}, {110}, {210}).

**feldspar group (of minerals)**; → feldspars.

**feldspar varieties**; feldspar varieties are: microcline, orthoclase, plagioclase, oligoclase, anorthoclase, sanidine, moonstone, amazonite, labradorite, albite, bytownite, sunstone, aventurine, peristerite albite, etc.

**feldspar, adularia**; → adularia.

**feldspar, albite**; → albite.

**feldspar, albite-oligoclase**; → albite, oligoclase.

**feldspar, amazonite**; → amazonite.

**feldspar, andesine**; a plagioclase feldspar, massive of greenish color, somewhat resembling jade. → Andesine.

**feldspar, anorthite**; → anorthite.

**feldspar, anorthoclase**; → anorthoclase.

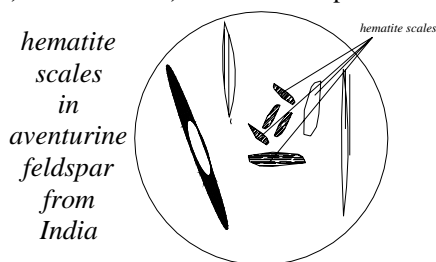
**feldspar, bytownite**; → bytownite.

**feldspar, celsian**; → celsian.

**feldspar, cryptoperthite**; submicroscopic interlamination of cryptoperthite or orthoclase or both as lamellae, which gives marked schiller of feldspars.

**feldspar, cut**; yellow feldspar from Malagasy are faceted finest. The best cabochon are cut from Myanmar (Burmese) moonstones with display bright blue reflection, sometimes with a fairly silver to blue color from Sri Lanka. Amazonite from USA, labradorite from Norway, Malagasy, Labrador, sunstone or plagioclase from Norway, Carolina, India, sanidine from Oregon, Mexico, Texas are cut as cabochons.

**feldspar, inclusions in**; in some feldspars can be seen



scaly hematite crystals which gives the stone red rose,

red or brown color.

**feldspar, in granite**; in all granites consisting always feldspars.

**feldspar, labradorite**; → labradorite.

**feldspar, lauvikite**; → lauvikite.

**feldspar, microcline**; → microcline.

**feldspar, moonstone**; → moonstone.

**feldspar, oligoclase**; → oligoclase.

**feldspar, orthoclase**; → orthoclase.

**feldspar, peristerite**; → peristerite.

**feldspar, perthite**; → perthite feldspar.

**feldspar, plagioclase**; → plagioclase.

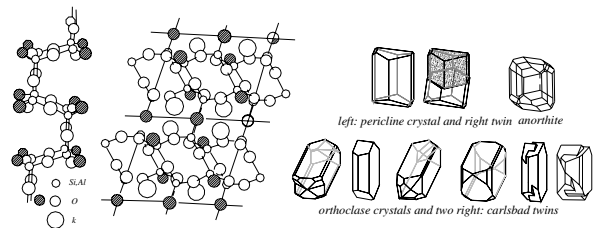
**feldspar, sanidine**; → sanidine.

**feldspar, sunstone**; → sunstone.

**feldspar bearing**; same as feldspathic.

**feldspar-apyre**; a French misleading term for andalusite.

**feldspars**; one of most important group of rock-forming minerals of general formula:  $4[MAl(Al,Si)_3O_8]$ , where  $M=K, Na, Ca, Ba, Rb, Sr, \text{ and } Fe$ , which includes microcline (amazonite), orthoclase (adularia, and moonstone), plagioclase (aventurine, labradorite,



crystal structure of orthoclase feldspar, crystals and twins of pericline and orthoclase

peristerite, and sunstone), oligoclase, anorthoclase. Feldspars are the most widespread of any mineral group and constitute 60% of the Earth's crust and are constitutes of nearly all rocks. Generally RI 1.52-1.57. Birefringence: 0.05.  $\ominus$  or  $\oplus$ . SG  $\approx$  2.5-3.45, H:6-6½. Important mineral yield as several gem varieties, glass and ceramic industries. Also called feldspar, feldspath. British spelling: felspar. See zoning.

**feldspath**; → feldspar.

**feldspathic emery**; a term employed to a similar spinel emery containing 30 to 50% plagioclase feldspar.

**feldspathoids**; a group of rock-forming minerals similar to feldspars, characterized by three-dimensional silicate lattices (tectosilicates) and chemical composition, but deficient in silica. They contain Na and /or K and are unsaturated, hence they can never occur in association with free quartz in a rock such as leucite  $KAlSi_2O_6$ , nepheline  $(Na,K)AlSiO_4$ , cancrinite  $4(NaAlSiO_4).CaCO_3.H_2O$ , sodalite  $3(NaAlSiO_4).NaCl$ , haiüyne  $3(NaAlSiO_4).CaSO_4$ , nosean  $3(NaAlSiO_4).Na_2SO_4$ , and

lazurite  $3(\text{NaAlSi}_3\text{O}_8) \cdot \text{Na}_2\text{S}$ .

**Félicité-Saphir of Burghese**; a sapphire of 99.35 cts, from India set with other stones in a necklace.

**Fellow of the Gemmological Association of Australia**; a suffix or title awarded by holders of the fellowship diploma of the Gemmological Association of Australia. Abbreviation: FGAA.

**Fellow of the Gemmological Association of Great Britain**; a suffix or title awarded by holders of the fellowship diploma of the Gemmological Association of Great Britain. Abbreviation: FGA.

**felsic**; a term applied to an igneous rock dominated by the light colored, silica- and aluminum-rich minerals, feldspars and quartz, such as granite. The light color variation results from presence and absence of small amount of mafic minerals.

**felsic**; this term also applied to light-colored minerals.

**felsic**; sometimes used as a misnomer for acidic rock.

**felsic**; derived from **feldspar** and **silica**. → Mafic.

**felsite**; any light-colored, fine-grained igneous rock of granite series composed chiefly of quartz or feldspar. → Devitrification.

**felsite**; same as orthoclase.

**felsite**; a term applied to a rock with felsic texture.

**felsite**; same as aphanite.

**felsitoid**; → aphanite.

**felspar**; a British spelling of feldspar.

**felstone**; an obsolete name for felsite.

**felted structure**; a crystalline aggregate, in which the crystals are tangled closely together a similarly woven fiber such as nephrite. Also called matted. → Mat.

**female**; once used for the stones with weaker color and weaker brilliance than the male counterpart. → Male ruby, male.

**female carbuncle**; a synonym for weak colored carbuncle.

**femic**; a term derived from **Fe** (for iron), and **Mg** (for magnesium), which applied to the group of standard normative minerals containing these elements such as pyroxene and olivine. Also called ferromagnesian minerals, present in a mafic rock.

**fencatite**; a synonym for predazzite.

**feng huang**; a Chinese term used for phoenix carved on jade. → Chinese ritual and symbol jades.

**fengite**; a term applied in Middle Age for transparent marble or gypsum used as surrogate for window glasses.

**fenster**; means window in German.

**Ferdinand Diamond**; according to a writer (1882) an Indian Diamond of 42 cts, taken to Venice by Edward Ferdinand. During fashioning it broke into numerous pieces.

**fereto**; Spanish term for hematite.

**fergusonite**; a rarely black to brownish-black mineral. It is isomorphous with formanite. Formula:  $8[\text{Y}(\text{Nb},\text{Ta})\text{O}_4]$ . Tetragonal crystal. Streak: variable. Vitreous, submetallic luster. Translucent to opaque. Cleavage: {111} in trace. Conchoidal fracture. Brittle. Optics;  $\omega$ :2.19,  $\epsilon$ :2.28. Birefringence :0.010. SG:5.6-5.8. H:5-6½. Found in Russia, Sweden, Norway, Malagasy, Zimbabwe, East Africa, and USA. Sometimes cut as cabochon.

**fergusonite**; a collective name for six minerals with general formula of  $8[\text{Y},\text{La},\text{Nd},\text{Ce})(\text{Nb},\text{Ta})\text{O}_4]$ .

**fern**; a term used for a pattern similar to tree pinfire. Also called tree pinfire.

**fern**; a term used for a type of inclusion in gemstones similar to fern or tree pinfire.

**Ferouba**; location of an alluvial diamond mine in Guinea, Africa. Now a member of the AREDOR.

**ferozah**; → firuzah.

**Ferrer's emerald**; a misleading term for emerald green glass with the chemical composition similar to emerald. RI:1.618. SG:3.5-3.54. H:5-5½. Also called ferros emerald.

**ferri**; prefix for iron. Denoting trivalent and divalent iron respectively. Also called ferro.

**ferrian**; containing ferric iron.

**ferric**; containing trivalent iron and usually yellow or brown in color.

**ferric-kimzeyite**; a variety of garnet. → Garnet, garnet species and varieties.

**ferric oxide**; same as jeweler's rouge.

**ferricrete**; same as ferruginous.

**ferridravite**; a dark brown to black, magnesium-rich variety of tourmaline. Streak: brown. Resinous luster. Formula:  $3[(\text{Na},\text{K})(\text{Mg},\text{Fe}^{+2})_3\text{Fe}^{+3}_6(\text{Si}_6\text{O}_{18})(\text{BO}_3)_3(\text{OH},\text{F})_4]$ . Optics;  $\omega$ :1.800,  $\epsilon$ :1.743. Birefringence: 0.057. ⊖. → Tourmaline.

**ferriferous**; synonym for ferruginous. Containing iron such as hematite, limonite, and siderite.

**ferri-turquoise**; a variety of turquoise containing 5%  $\text{Fe}_2\text{O}_3$  from Lynchburg, Virginia, USA.

**ferro**; → ferri.

**ferro-actinolite**; actinolite contains iron oxides.

**ferroan dolomite**; another term for ankerite.

**ferroan-vanadian tourmaline**; a term applied to tourmaline containing Fe and V.

**ferro-axinite**; a cinnamon-brown color iron-rich axinite from Sri Lanka. Optics;  $\alpha$ :1.656-1.675,  $\beta$ :1.660-1.685,  $\gamma$ :1.668-1.685. Birefringence 0.007. ⊖.

**ferro-elbaite**; a term used for schorl part of elbaite-schorl series of tourmaline family.

**ferromagnetism**; phenomenon in which type of all magnetic atoms in a domain have same direction of movements, loosely, and any type of magnetic order.



**ferromagnesian minerals**; another term for femic.

**ferro-pumpellyite**; → pumpellyite.

**ferrolite**; a general term for iron-ore rocks or black iron slag used as a gem.

**ferroschorlite**; a term used for schorl part of dravite-schorl series of tourmaline family.

**ferrosilite**; same as iron-hypersthene (FeSiO<sub>3</sub>).

**ferros concretion**; same as ferrous nodule.

**ferros emerald**; same as ferrer emerald.

**ferros mineral**; any mineral containing iron in its composition.

**ferrospinel**; synonym for hercynite.

**ferrous**; containing iron as a divalent (Fe<sup>+2</sup>).

**ferruginous**; minerals or gems colored by iron components or containing iron oxides. Also called ferriferous.

**ferruginous**; containing iron or iron bearing.

**ferruginous jasper**; jasper which containing iron.

**ferruginous limestone**; limestone which containing iron.

**ferruginous sandstone**; sandstone which containing iron.

**fertility symbol**; an object of being fertile was used in many cultures as a phallic symbol to symbolized regeneration. In Egyptian used scarabs made of steatite, other stones, metals and Egyptian faience have been carved to create the form of the scarabaeus beetle, particularly *Scarabaeus sacer*, which was worn by ancient Egyptians as an amulet of fertility, immortality and resurrection. Usually they had an inscription cut into their flat bases. The scarab beetle symbolized the god of the morning sun, called *Khepera*. The quality of the carvings varies from well-formed shapes to only bare outlines, which was frequently carried out the human head. They were used as ornaments, symbols or talismans and worn as pendants or finger rings, also they were buried with the dead by the Mesopotamians and were used by Egyptian, which was symbolized the sun, life, and rebirth. Carved inscriptions on the bases in the form of intaglio were used as seals, such as in finger ring seals. Later, they were copied by other cultures, such as the Phoenicians, the Greeks, and the Etruscans, etc.

**Feruzia**; a Persian term for turquoise. Also spelled firuza, piruza.

**fervidor**; a Brazilian name used for a primitive method of separating diamonds. Also called canoa.

**feuerstein**; a German name for firestone.

**fezel**; a feather-like white inclusion often seen inside a diamond along the twining plane of macles. Also white, gray to black, streamer like inclusions in gemstones. Also spelled vezel, faisel, faizel. And called knot line.

**FGA**; an acronym suffix awarded by fellow of the

Gemmological Association of Great Britain.

**FGAA**; an acronym suffix used by holders of the fellow diploma of the Gemmological Association of Australia.

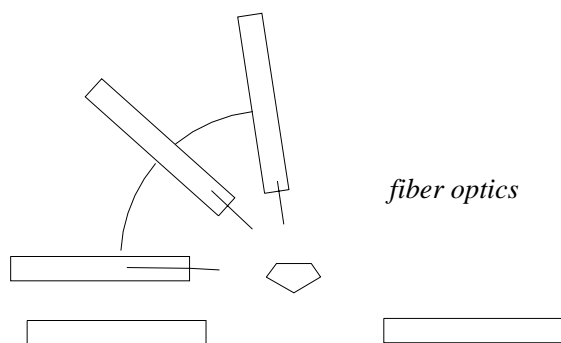
**FGG**; an acronym for Fachmitglied der Deutschen Gemmologischen Gesellschaft.

**fiber**; in crystallography a very narrow, elongated, filament, asbestos-like, hair-like, thread-like crystal.

**fiberglass**; a fine flexible glass fiber used as light-wire in transmitting light. → Fiber optics.

**fiber light-guide**; a fiber light used in microscopy to providing controllable inclined illumination, which can be used in various combinations.

**fiber optics**; a modern innovation of flexible glass or acrylic light-wire (bundles of long transparent glass fibers in transmitting light) used to illuminate the



specimen by piping light through a fiber optic system, that accessory is fixed to a microscope. Also called light guide.

**fibrocristalline**; in crystallography the presence of fibrous crystals.

**fibroid**; commercial term for celluloid.

**fibroid**; containing or resembling fibers.

**fibrolite**; very rarely offered as small gem quality, often a fibrous aggregate of sillimanite. Sillimanite is trimorphous with andalusite, and kyanite. Some specimens display chatoyant effect, which is erroneously known as *fibrolite cat's-eye*. Absorption spectrum weak bands at 462, 441, and 410 nm. Greenish or brownish varieties used as an inferior substitute for jade. Some specimen shows chatoyancy. Synonym for bucholzite. Chatoyant effects.

System: orthorhombic.

Formula: 4[Al<sub>2</sub>SiO<sub>5</sub>].

Luster: vitreous to silky.

Colors: colorless, yellowish, gray, brownish, greenish, bluish, white.

Streak: colorless.

Diaphaneity: transparent to translucent.

Cleavage: {010} perfect.

Fracture: uneven.

SG: 3.23-3.27.

H: 6½-7½.

Optics; α:1.654-1.661, β:1.658-1.660, γ:1.673-1.683.

Birefringence: 0.019. ⊕.

Dispersion: 0.015.

Found in Oklahoma, Pennsylvania, New York, and North Carolina (USA), Canada, Ireland, Germany, India, Sri Lanka, Myanmar, Korea, Malagasy, South Africa, and Scotland.

**fibrolite as inclusions;** as inclusions can be seen in rose quartz, which caused asterism.

**fibrolite cat's-eye;** a misleading term for a pale greenish fibrolite with weak chatoyant effect, when cut en cabochon.

**fibrolite cut;** a fine pale blue color fibrolite from Myanmar is very rarely cut as small faceted gems because of easy cleavage and water-worn gravels are tumbled.

**fibrolite pleochroism;** pleochroism of fibrolite is strong pale-brown to light-yellow green, brown-greenish, and dark-green to blue or bluish-violet.

**fibrolite rough;** found as waterworn pebbles in gem gravels of Myanmar. It is a collector's stone.

**fibrolithoid;** a term applied to a substitute material for celluloid.

**fibrous;** in mineralogy containing or resembling fibers, or having hair-like, asbestos, thread-like, fiber-like form of an aggregate of a crystal. Synonym for asbestiform.

**fibrous asbestos;** same as mineral flax.

**fibrous aggregate;** a style of crystalline aggregate that is composed closely of fibers.

**fibrous barite;** fibrous barite from southeast Missouri, USA.

**fibrous calcite;** semitransparent, silky sheen calcite crystalline aggregate composed closely of fibers. When cut cabochon shows a chatoyant effect, but not a true cat's-eye effects. Also called less correctly satin spar. → Fibrous gypsum.

**fibrous feather ore;** fibrous gray antimonite which is known as jamesonite.

**fibrous green carbonated copper;** same as fibrous malachite.

**fibrous gypsum;** same as satin spar. → Fibrous calcite.

**fibrous habit;** a term applied to tendency of certain minerals to crystallize in needlelike forms or fibers such as asbestos and some tourmalines.

**fibrous jamesonite;** same as fibrous feather ore.

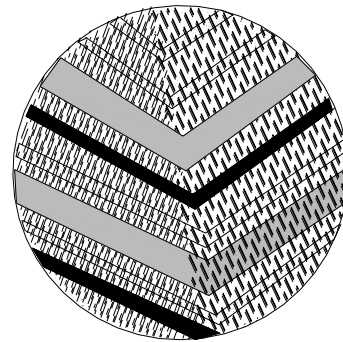
**fibrous lime carbonated;** another term for fibrous carbonated of lime.

**fibrous malachite;** same as fibrous green carbonated copper.

**fibrous of quartz in agate;** in some agates can be seen the fibrous of quartz which are perpendicular to the zone.

**fibrous pyrites;** same as capillary pyrites.

**fibrous quartz;** same as radiated quartz.



*section of agate in which the fibrous of quartz are perpendicular to zones*

**fibrous zeolites;** members of zeolite group with framework structures of silicate-tetrahedron. Minerals are monoclinic or orthorhombic. Series are: natrolite, mesolite, sclocite, thomsonite, gonnardite, and edingtonite.

**ficile;** molded into the form of an artwork or artifacts.

**ficile;** artifacts made of earth or clay.

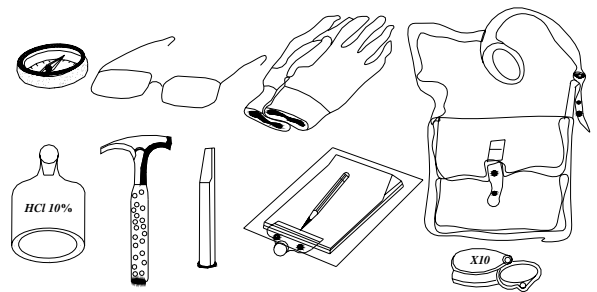
**ficile ivory;** a misleading term for new copies or reproductions of an original famous or artistic ivory objects. Normally it is made by casting in fine *plaster of Paris*, colored with fine yellow ochre (an earthy pigment consisting of iron oxide and silicates), and in the least the surface is treated with a mixture of wax, spermaceti or stearine (stearin).

**ficile mosaic;** a picture design formed by small cubes or fragments of opaque glass, stone, or tile, usually set in a ground of cement or stucco. → Florentine mosaic.

**field;** a term used by Australian miners for opal mining within the limits district.

**Fiery Astrolite;** a trade term for synthetically lithium metaniobate. Used as a diamond imitation.

**field accessories;** for working on the field and quick test of minerals, gems or rocks and preventing needed some



*primary field accessoire*

primary tools, which are easy to carrying and occupying not to much space. These tools are geological hammer, bag, leather gloves, chisels, compass, hand loupe, maps, glasses for protecting the eyes, chlorine acid 10%, paper and pencil.

**field test of beryl;** a quick test of beryllium on the field

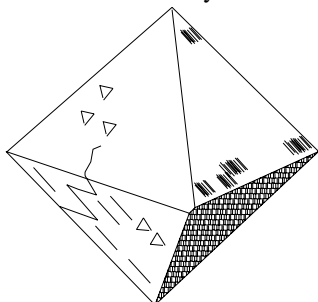
can do in few methods, such as morin test of beryl, alkalinity test, quinalizarin test of beryl, P-nitrobenzene-azo-orcinol, all mentioned in above and below.

**fiery gems;** same as red gemstone after Theophrastus.

**fierry;** to split as slate.

**fifth;** equivalent: 0.20 carat or 1/5 carat.

**Fifty Years of Aeroflot Diamond;** a diamond of 232 cts, found in 1973 in Mirnyi in the Sakha, Yakutia,



*Fifty Years Diamond of formerly USSR*

Siberia, the Russian Federation, CIS. Named in commemoration of soviet Aviation Day. The Star of Yakutia has the same weight ?

**figuier's gold purple;** a tin, gold colored used for porcelain decoration.

**figured chalcedony;** a term used in Texas for amarillo stone.

**figured glass;** a flat glass having an etched pattern on one or both surfaces.

**figured stone;** a term applied to soft talcose rock for carving of small figures and ornaments. Also called soap rock, soapstone, agalmatolite, pagodite, lardite, lard stone and pagoda stone.

**figure stone;** a misleading term used for small stone carvings generally made from agalmatolite by the Chinese.

**Fijian soapstone;** a local term for soapstone of post-tertiary age from Fiji Island, Japan.

**Fiji Islands pearl;** pearl of fine-quality from Fiji Island, Japan.

**filament;** any fine threadlike metallic element such as gold, tungsten or metal carbide.

**filaments;** a term used by Pliny for emerald inclusions.

**file;** a hand steel file or other hardness tester in style of a file, which will not scratch diamond, but scratches glass. Also known as file test.

**Filetto marble;** creamy to yellow fine-grained marble from Italy.

**filiform;** A term applied to a mineral that forms hairlike, branch-like, capillary, thread-like, wiry or fibrous, such as millerite.

**filiform texture;** thread-like crystals embedded in another mineral.

**filigree;** delicate ornamental work of twisted or plaited

fine wire gold and silver used chiefly in decoration.

**filigree;** naturally occurring native metals such as gold, silver, or copper in lacelike form.

**filled cracks;** filled fractures of diamond shows feature similar to fried river. → Revealing fracture filled diamond.

**filled diamond;** surface of laser drilled diamond, cleavage, or fracture, which has been filled with epoxy or glass to conceal them. This method can be used by other gemstones such as rough or polished emerald. Fillings of diamonds or gemstones can be seen by flattened gas bubbles, or flow line features with greasy or oily appearance. When a glass or epoxy filled diamond is examined under rotated dark-field illumination, nearly parallel to the plane of the crack the interference flash effect may be seen. → Laser drilling diamonds.

**film;** any thin coating sheet or layer of any substance given on the surface of gems to sequence more luster or play of color.

**filter;** an optical device or material, which is interposed across a beam of light that partially absorbs incident ray (the visible, ultraviolet, or infrared spectra) to alter its frequency distribution. Also known as optical filter. → Color filter, Chelsea color filter, filtered light.

**filter glass;** a colored glass used in hand shields to exclude harmful light rays.

**filter, Chelsea;** → Chelsea color filter.

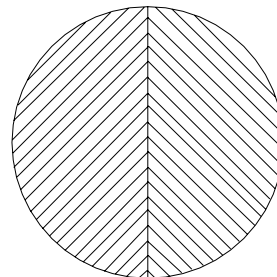
**filter, color;** → color filter, Chelsea color filter, filtering of color.

**filter, copper sulfate liquid;** same as copper sulfate liquid as filter.

**filter, crossed,- technique;** → crossed Nicols.

**filter, infrared;** an infrared filter such as in photography used to distinguish between synthetic emerald and natural emerald. Synthetic emerald shows up a brilliant red, while natural emerald will scarcely show.

**filter in dichroscope;** dichroscope comprising a suitably polarizing double wedged filters and a lens system in a



*intersect filter of two polarizer in dichroscope*

short tube, which enabled two colors can viewed side by side.

**filter, interference;** → interference filter.

**filter, long-wave ultraviolet;** a cobalt glass with about

4% nickel oxide will pass through the wavelengths between 400 and 300 nm. Also called Wood's glass filter. → Ultraviolet lamp.

**filter, monochromatic;** approximately monochromatic of light of one wavelength for example, sodium vapor is 589 and 589.6 nm.

**filter, short-wave ultraviolet;** using the electrical glow discharge through mercury vapor, in a quartz tube will pass wavelengths between 280 to 200 nm that is important in gemology. → Ultraviolet lamp.

**filter, ultraviolet absorbing;** to photograph the fluorescent glow of gemstones an ultraviolet absorbing filter is always placed in the front of the camera lens.

**filter, Wood's glass;** → Wood's glass filter.

**filter, X-ray;** → X-ray filter.

**filtered light;** a piece of colored film or glass which, when white light passes through it, absorbs and filters out certain colors of the spectrum, allowing those of other hues to pass through.

**filtering of color;** a colored gem material absorbs certain wavelengths of white light, and the color of gemstone results from a combination of the unabsorbed wavelengths. → Color filter, Chelsea color filter.

**Finch clay-stone;** a local term used by Australian miners for stratum of opal dirt in north-west.

**finding;** the tools and equipment, which are used in jewelry.

**fine adjustment;** any mineralogical or petrological microscopes, which are also fitted with a fine adjustment focusing arrangement to obtain final sharp focusing. → Coarse adjustment.

**fine aggregate;** aggregate, in which the largest particles are able to pass through a certain numbered sieve of 4.76 mm, or  $\frac{1}{4}$  to  $\frac{3}{16}$  inch.

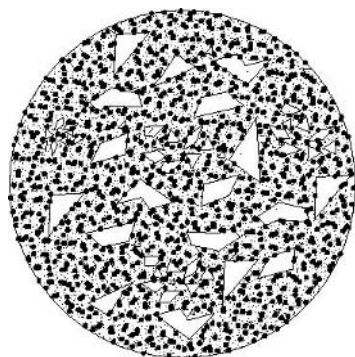
**fine cape;** same as cape.

**fine cleavage;** sorting grade of gem diamonds. → Cleavage.

**fine crystallized gypsum;** same as selenite.

**fine debris;** fine loose rock resulting from weathering by mechanical and chemical means.

**fine gold;** almost pure gold, often 100% gold. Also



*breccia  
with  
fine-ground  
matrix  
and  
coarse  
broken  
parts*

called fineness.

**fine-grained;** description of any crystalline, glassy, or a groundmass of rock, in which the individual minerals are very small with an average size of less than 1 mm that are visible to the naked eye. Synonym for aphanite or fine granular.

**fine granular;** any crystalline particles of an igneous rock that can be observed with the unaided eye. → Fine-grained.

**Fine grinder;** any various type of mechanically grinder machine, which pulverizes substances by means of balls, rods, etc. in a horizontally rotating mill.

**fine light brown;** a color classification of gem diamond. Also called finest light brown.

**fine line spectra;** the term applied to gemstones, which contain rare earth's, they raise the characteristic absorption spectrum of gemstones and they are called fine line spectra. Same as rare earth's spectra.

**fine quality;** → finish.

**fine silver cape;** a classification of gem diamond. Same as silver cape. → Cape.

**fine silver;** almost pure silver. 100% silver.

**fine water;** → water.

**fine white;** color grading of gem diamond.

**fine work;** same as finish.

**Fineberg Jones Diamond;** a fine diamond of 206.50 cts, uncut, found in 1911 in Vaal River, South Africa. Present owner unknown.

**fineness;** the degree of purity of gold, silver or other precious metals, expressed as the number of parts per thousand. In Malaysian is called mutu.

**fineness of gold;** → fineness.

**fine grain;** a term applied to ultra-fine grain.

**fine silver;** almost pure silver, often 100% silver.

**finest water;** → water.

**finest white;** color grading of gem diamond. Also called fine white.

**finest light brown;** same as fine light brown.

**fingerprint;** → fingerprint inclusion.

**fingerprint inclusion;** a type of inclusion commonly seen in sapphire or ruby (rarely in garnet) cloudy, net-like hollow inclusion filled with liquid and gas that form patterns resembling fingerprints around crystal inclusion such as in Thailand (Siam) rubies, spinel, and YAG. It results from interior cracks that have healed. Also sometimes called *butterfly wings*.

**fingerprint inclusion in corundum;** → fingerprint inclusion.

**fingerprint inclusion in garnet;** → fingerprint inclusion.

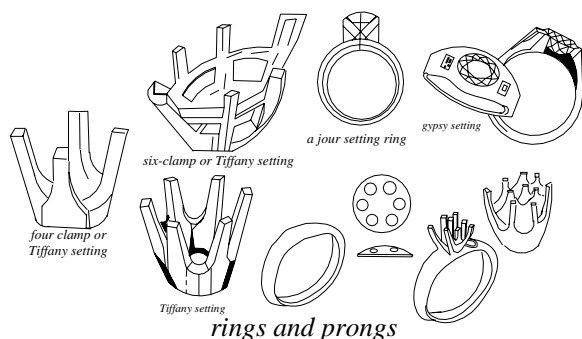
**fingerprint inclusion in peridot;** → fingerprint inclusion.

**fingerprint inclusion in spinel;** → fingerprint inclusion.

**fingerprint inclusion YAG;** → fingerprint inclusion.

**fingerprint inclusion zircon;** → fingerprint inclusion.

**finger rings;** circlets, usually made of precious metals such as gold, silver or platinum worn on any finger,



rarely on the thumb. It was used as signets or seal-rings for personal identification and signature. Now are used as personal adornment for peculiar occasions such as betrothal, marriage, membership, birth-month stones, etc.

**finial;** a term applied to a decorative ornament which is used as a terminating motif in form as a cover of a tea, vessel, coffee top or sometimes as a lamp shade mostly in form a knop, a pineapple or foliage and usually are of jade. Frequently used as a decorative item such as a dragon finial.

**finish;** the term applied to the excellent quality, polish, symmetry, proportions and general fashioning of gem diamond. Also classified as diamond external clarity. In such a system, the external grade is a synonym with finish quality. Also called fine quality.

**finish;** coating, polishing or smoothing of a surface.

**finish faults;** same as surface blemish.

**finisher;** same as brilliandeer.

**Finnish amber;** amber from the coast of Finland.

**Finsch diamond mine;** location of an opencast method diamond mine until 1990, underground working since 1991 in Postmasburg, Cape Province, South Africa. The largest producer of diamond sometimes green diamonds are found there. Named after Allister T. Fincham former owner of mine.

**florite;** a siliceous sinter containing opal from Mount Santa Fiora, Tuscany, Italy.

**fir;** a common term for coniferous trees of the genus *abies* used as a source of the liquid resin, called Canada balsam.

**fire;** the flashing spectrum of colors seen from the crown of a cut diamond, when moved, which is the result of its high dispersion and a high refractive index, emphasized by faceting. The fire in diamonds, is owed to its high dispersion and high refractive index. → Dispersion.

**fire;** incorrectly used in USA by jewelers for *play of color*. This stone has been set in jewelry.

**fire;** the flashing spectrum of colors seen in other gemstones.

**fire;** a term applied to an opal with good play of colors usually vivid red, but often with other vivid contrasts. Also called fire opal, live opal.

**fire agate;** a term applied to much chalcedony occurs as botryoidal, consisting of minute platy inclusion of goethite or limonite minerals over the layers of chalcedony, producing a rainbow, iridescent, fire like appearance. When cut and polished carefully as a cabochon only a very thin layer of chalcedony covers the inclusions. Found in California, and Arizona, USA.

**fire agate;** a misleading term for a type of glass.

**fire clay;** a term applied to clay that is high in alumina or silica. Also called fire stone.

**fire fountain;** another term for lava fountain.

**fire eye;** a commercial term for a glass imitation with chatoyance effect, which contains parallel oriented tubes so that a very sharp band of light similar to an eye is produced on the apex of a cabochon cut. → Glass chatoyant.

**fire jade;** rock consisting mostly of opal, having a tiger's eye effect, when cut cabochon.

**fire damage;** rough whitish surface often seen at the facets of fire-coated (or fire-polished) diamonds, which is the result of failing to protect the stone, or local overheating during the polishing process. → Fire marks.

**fire marble;** a variety of ornamental marble in various colors containing fossil-shell usually ammonites or baculites, which emits red and green fire-like iridescence and resembles opal matrix, when light is reflected from it at the correct angle. Also called lamachelle or lumachella marble, shell marble. Found in Russia, and Austria, and Alberta, Canada.

**fire marks;** small, wavy, roughly parallel cracks are often seen at or near facet edges in natural or synthetic corundums. They are caused by local overheating during the polishing process. They can be seen in synthetic corundums, but are usually more prevalent in the latter. Sometimes called chatter marks or shatter-marks. → Fire damage.

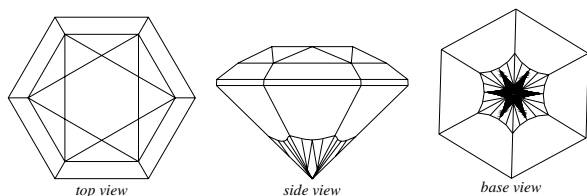
**fire opal;** a transparent to translucent, honey-yellow, orange-yellow, brownish-orange to hyacinth-red or brownish-red variety of opal, which emits fire like reflections in bright light, whether or not it displays a play of color. RI:1.45. Found in Mexico and Australia. Also called *girasol*, *pyrophane* or *gold opal*, fire.

**fire opal glass;** a misleading term for translucent glass imitation with fire opal effects. SG:2.4 or more.

**fire pearl;** a misnomer for billitonite.

**fire polishing;** polishing of glassware, by holding it in a glory hole.

**Fire Rose Cut;** a registered name for one of 5 new Flower style cuts with an exceptional cut style. This was created for special effect for example a hexagonal cut with 61 facets, an octagon with 81, and a 12-sided



Tolkowsky Fire Rose Flower cut.  
Courtesy of De Beers

symmetrical oval with 67 (Dahlia Cut), which is combined with brilliant and step-cut. Designed by CSO consultant Gabi Tolkowsky in 1988. Its proportion is: table 47-62%, crown height 15-20%, pavilion depth 45-51% and the girdle is thin. → Flower Cuts; Dahlia Cut, Marigold Cut, Sunflower Cut, Zinnia Cut.

**fired skin;** a tiny layer upon surface of a diamond due to overheating. Repolishing is possible.

**fire stone;** a term used for a variety of quartz crystal, which has cracks artificially caused by heat and suddenly cooling in dyed water, which imitate rainbow quartz. Also called *rainbow quartz* or *iris quartz*. When cracks of such quartz are dyed green color they are misnomered as *Indian emerald*.

**fire stone;** any fine-grained siliceous stone formerly used for striking fire such as flint.

**fire stone;** pyrite crystal, which was formerly used to striking fire. Also called flint and spelled firestone.

**fire stone;** a term applied to fire clay also known as sagger clay, saggur clay.

**fired stone;** → heated stone.

**fired topaz;** the color change of natural topaz under influence of heat-treatment. → heat-treated stones, heated stone.

**fired zircon;** the color change of natural zircon under influence of heat. The colors caused are often fading. → Heated stone.

**firestone;** → fire stone.

**firing;** the act or process of baking glass or ceramic ware in a kiln or furnace using high temperatures. A coating of porcelain enamel, metal or ceramic coating also is applied.

**firmament stone;** same as precious opal.

**first;** a term used to designate high-quality drill diamond.

**first;** a term used by Australian miners to designate high quality of opal.

**first bye;** a commercial term used for color grading of gem diamond with a faint greenish tint. → Bye

(diamond).

**first cape;** a commercial term used for color classification of gem diamond of white color with a very faint yellow. → Cape, cape stone.

**first water;** the grade of gem diamonds of highest value, which are flawless, perfectly clear and transparent, colorless, or almost blue-white. A slightly lower quality is described as second water. → Water.

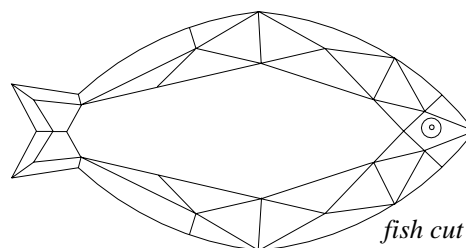
**firuza;** → firuzah.

**firuzah;** a Persian or Farsi term for turquoise derived from the word piruz or firuz means successful, victory, or victorious. Also spelled ferozal, firuza.

**fischerite;** a mineral identical with wavelite.

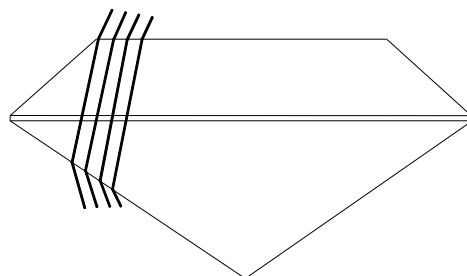
**fish belly jade;** describing of a particular colored grade of jade by the Chinese.

**fish cut;** a motif used in jewelry made of diamond or other stones.



**fisheries, pearl;** a term applied to the finest pearls, which are confined to the fisheries in the Persian Gulf, Gulf of Mannar, and less important from Red Sea. → Oriental pearls.

**fish-eye;** a dark gray ring of light caused by reflection of



the girdle seen around the table of a shallow stone, cut diamond with a pavilion depth of less than 40 percent, making it appear through the table (face-up) like a baleful eye. Also called cod's eye.

**fish-eye;** sometimes used for moonstone with girasol effects.

**fish-eye;** frequently used for opal with girasol effects.

**fish-eye;** a commercial term for any flat faceted diamonds or other transparent stone cut so that its center is dark.

**fish eyestone**; synonym for apophyllite.

**fish pearl**; the common imitation pearl made partly or wholly from fish scale essence. Also called fish silver.

**fish-scale essence**; a substance prepared from the silvery scales of the bleak, a small fish (*alburnus lucidus*), which resembles luster and orient of natural pearl. It is used for the interior coating of a glass bead or for the exterior of a bead of glass, mother-of-pearl, or other material. → Fish scale essence, -synthetic. Also known as *essence d'orient*.

**fish-scale essence, synthetic**; same as synthetic fish-scale essence. → Fish-scale essence.

**fish silver**; an erroneous term for fish-scale essence that for a long time was believed to be silver. The chemical formula of crystallite fish-scale essence or guanine is  $C_5H_5ON_5$ . → Fish pearl, Fish scale essence.

**fish-silver paste**; constituent of essence d'orient, which causes its iridescence. Same as guanine. → Fish-scale essence.

**fish-silver pearl**; same as fish pearl.

**fishtail flame**; a pattern similar to fishtail was seen in a coal gas burner when gas-flame burns with air.

**fissile**; readily split or cleaved as schist, slate, and shale along approximately parallel to surface.

**fissile**; certain heavy elements are also described as fissile they may undergo nuclear fission as a result of the impact of slow neutrons.

**fissility**; a term applied to phenomenon of splitting, fracturing or cleaving.

**fission-track dating**; → fission-track method.

**fission-track method**; the paths of radiation damage made by nuclear particles in a crystal lattice or glass is used as a method of calculating the age of stones and distinguishing between real and synthetically gems. Also called fission-track dating.

**fissure**; in diamond grading a term applied to an elongated crack in a diamond's surface.

**fissure**; an extensive surface of fracture or a crack in rock, along which there is a distinct separation, often filled with other minerals.

**fissure**; geological, a high, narrow, relatively straight opening formed by parting of the earth's crust.

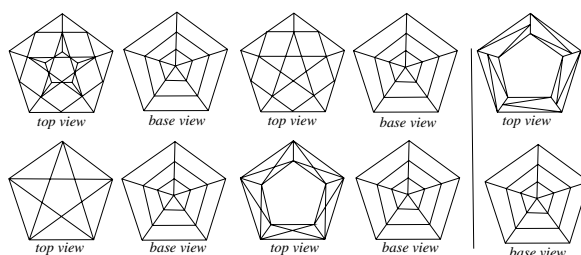
**fissured**; same as fractured.

**Five Great Gems**; a term used in India by the Hindus for Maharatnani, these five gems are diamond, emerald, pearl, ruby and sapphire.

**Five Precious Fragments**; the earliest medicines and pharmacopoeias used five precious stones such as ruby, topaz, sapphire, emerald, and hyacinth (orange-red zircon or hessonite). Diamond was not among them.

**five rayed star-cuts**; modified five sided faceted cut for diamond or other transparent gemstones with lozenge or triangular facet and five-rayed star table in the

crown. In pavilion there are two or three stepped



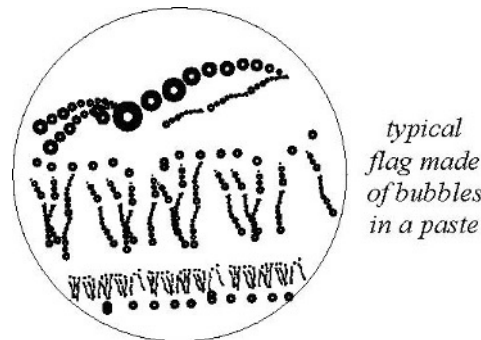
*different five rayed star-cuts*

lozenge cut without culet.

**fixed star emerald-cut**; a term applied to some emerald pieces of cabochon-cut, which show star-like effect as observed in star sapphire due to reflections from numerous bundles of parallel fibers inclusions which cross like spokes in a wheel similar to trapiche emerald. This effect moves when the gem is tilted.

**Fl**; an abbreviation term for flawless. A clarity grading of polished diamonds. Similar term is IF means internally flawless.

**flag**; a series of elongated and irregular liquid or crystalline inclusions that resembles a feather, sometimes found in natural crystals of ruby, sapphire, paste, etc. Some of the cleavage or fracture in diamonds is so shallow that they appear to be scratches at first



*typical flag made of bubbles in a paste*

glance, such feathering is called *hairline feather*. Also called flag. → Flaws, glets, inclusions.

**flag**; in gemology same as feather.

**flag**; a synonym for flagstone.

**flags**; a term applied to hard and thin-bedded sandstone used for flagstones.

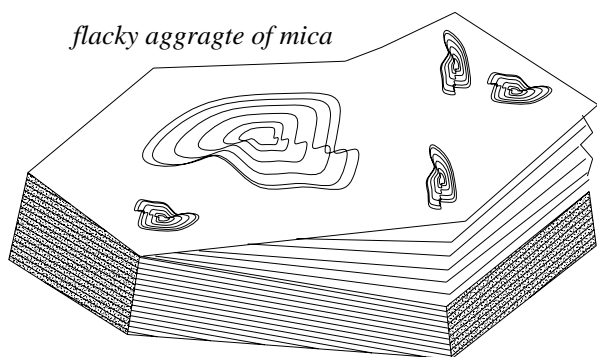
**flagstone**; a fissile, fine-grained, flat, thin-bedded, micaceous sandstone that splits readily into slabs. Used as paving stone. Also called slabstone, tilestone, cleftstone, grayband.

**flagstone**; a term used by Australian miners for an opal pattern with different irregular colors similar to flagstone in nature.

**flakelike mineral**; same as flaky mineral.

**flaky aggregate**; very thin scales of flaky mineral such

as mica or sericite.



**flambé;** a red, yellow lusterware with flamelike splashes of all colors, giving changing tints in different aspects.,

**flambé glaze;** a flow glaze mixed with copper, which gives variegated aspects.

**flame agate;** a variety of plume agate that is called Mexico red Apache or flame agate.

**flame coloration;** to obtain a colored flame may dip a platinum wire into hydrochloric acid to touch the powder of material, hold the wire in gas flame. Produced chlorides from substance will readily vaporized in gas flame and create excitations to higher energy levels. During falling back to the ground state some elements may reveal themselves by emission of characteristic colors such as sodium with bright yellow double lines. → Flame test.

**flame-colored;** same as splashes of red color. → *La spica turgenis*.

**flame-fusion process;** a method of gem synthesis based on Verneuil process (furnace) used in growing synthetic single crystals to distinguish from a melt or flux fusion. → Verneuil furnace.

**flame-fusion synthetic corundum;** characteristic flame-fusion synthetic corundum has spherical gas bubbles, which may be round in cross-section, but are elongated. Found in groups of many tiny bubbles. → Verneuil furnace.

**flamelike inclusions;** two-phase inclusions of flamelike twinning are seen in some hydrothermal synthetic amethyst.

**Flame of Gold Diamond;** a fancy canary-yellow, pear-shaped diamond of 29 cts. Its ultimate disposition unknown.

**flame opal;** a variety of precious opal, in which play-of-color is red over the entire of the stone with sweeping bands and sometimes irregular streaks. → Flash fire opal.

**flame pattern pearl;** a fancy pearl from marine mollusk giant one of the largest of the univalve shell known as giant conch *Strombus gigas* or *giant conch* of the Atlantic coast of the USA, West Indies, or of tropical seas. The pink pearls are non-nacreous and

have a porcelain-like surface with a marking appearance similar to *flames* or like to watered silk. The white to pink pearl from this conch is known as *conch pearl*. Also called flame structure pearl.

**flame-polished synthetic corundum;** a style of polishing synthetic crystals of corundum rods, balls and other flawed surface by revolving them in an oxygen-gas flame, which melts the surface slightly and removes the scratches or blemishes.

**Flame Queen;** same as Flame Queen Opal.

**Flame Queen Opal;** a black opal with bronze-red center and a green border of 253 cts, found in the same mine district, New South Wales, Australia, in 1918. The owner is Milwaukee, a chemist. Also called Flame Queen.

**flame Queen opal;** an opal mining in Australia.

**flames;** a marking structure like flames seen on the surface of conch pearls.

**flame spectra;** the observation of a spectrum of light emitted by a chemical substance when heating by a Bunsen flame without luminescence such as alkali metals or alkaline earth metals. → Flame test.

**flame spinel;** a term applied to a bright yellow to orange-red spinel. Also called rubicelle.

**flame structure pearl;** same as flame pattern pearl.

**flame test;** a qualitative test to detect the presence of an element in a substance by the coloration imparted to a Bunsen burner flame, such as a bead test. Sodium compounds color a flame bright yellow, potassium, caesium, and rubidium give a violet color, strontium and lithium a red color, copper, thallium and tellurium give a green color, except copper haloids, which give blue color. In following table are flame colors of elements with their wavelengths in nm to seen:

table 4: flame color of elements with wavelengths in nm

element	lines (nm)	color
lithium	610,671	dark red
sodium	589	yellow
potassium	405, 767	violet
calcium	432, 559, 616	orange red
strontium	408, 461, 606, 687	crimson red
barium	487,514,543,553,578	yellow-green
thallium	535	green
borates	broad bands	green
arsenic	broad bands	blue
antimony	broad bands	Blue
bismuth	broad bands	Blue
copper	broad bands	Blue
lead	broad bands	blue

→ Flame spectra, flame coloration.



**flambeau;** decorative or ornamental gems in form of a torch end (flame).

**Flaming Star Diamond;** a fine white, pear-shaped diamond of 21.90 cts, found in South Africa. It was cut from an 88 cts, rough diamond. The white color in normal light changes to a very intense brilliant orange color under ultraviolet light. It was purchased and cut in 1967 by Baumgold Bros., New York City, USA. Last it was sold in 1979.

**flammeus;** same as flame-colored. → *La spica turginis*.

**flange;** any internal or external projection appertaining to an edge or rim, which support to another part such as a collet of a finger ring upon which a precious stone is set.

**flaser;** streaky parallel arrangement of scaly mica as a thin film in gneisses.

**flaser gabbro;** a coarse-grained gabbro containing mica, quartz, feldspar or chlorite, used as ornamental stone.

**flash;** to break into a sudden short flame or light, especially one suggestive of brilliant.

**flash;** to coat a glass with a layer of colored, opalescent, or white glass. → Flash effects.

**flash;** a descriptive term used by Australian miners for opal, also frequently as a definitive term.

**flash;** a general term for opal or other gemstones break into a sudden short flame or light in various colors as they are moved.

**flashed glass;** a glass colored by application of a thin layer of densely dyed glass to a thicker colorless, base layer.

**flash effect;** when a filled diamond is examined under dark-field illumination, almost parallel to the plane of the crack a single mono-color interference flash effect may be seen. → Filled diamond, flash.

**flash fire opal;** same as flash opal.

**flashing glass;** → silver-yellow glass.

**flashing stone;** → bareketh.

**flash opal;** a variety of precious opal with streaks or rows of a single-hued or play-of-color only in one direction, when the stone is moved. Also called flash fire opal. → Flame opal.

**flask;** a short steel or glass tube, which fits exactly into the rim flange of the crucible former. → Crucible former.

**flask-shaped;** a style of inclusion, which occurs in curved lines of synthetic corundum in the form of round elongated bubbles.

**flat;** a horizontal ore body, regardless of formation type.

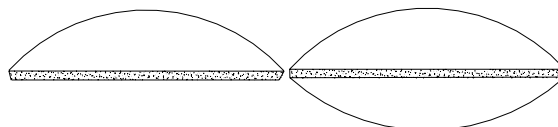
**flat;** in northern and central of USA used for bottom. → Flats.

**flat;** a term used by Australian miners for a black opal, which is believed to be replaced by marine life such as corals and sponges. Also called flat nobby.

**flat;** a term used by Australian miners for an opal which can be found in horizontal seam as distinguish from vertical seam opal, generally with true color which crosses the stone.

**flat buff;** a long flat hand buff used for abrasion and polishing.

**flat cabochon;** a form of cabochon cut with comparatively thin convex top and base. Same as flat double cabochon or lentil.



*flat cabochon and flat double cabochon cuts*

**flat double cabochon;** synonym for lentil. → Flat cabochon.

**flat end;** a term applied to thin diamond cleavage.

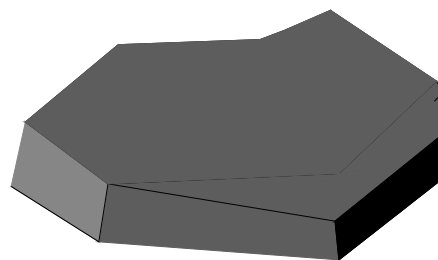
**flat gemstones;** flat stones are book ends, pen bases, plaques, paper weights and thin slabs used for windows and lamp shades. Also called flat-surfaced objects.

**flat mound amber;** a term applied to pieces of amber in form of spindle whorls in the graves of females to empower to prevent evil spirits.

**flat nobby;** same as flat.

**flat-surfaced objects;** same as flat gemstones.

**flats;** one of the five sorting grades of rough diamond. A



*flats*

classification for the shape of relatively thin but cuttable rough diamond crystals, which may include parts of macles.

**flats;** a term, which is used in the price of pearls or other stones per carat, regardless of size.

**flats;** a term applied to diamond crystals of distorted octahedral with parallel sides like pieces of broken glass.

**flats;** a dull diamond bit.

**flats;** a synonym for macles.

**flat stone;** fashioned diamond with a very shallow crown, or a very shallow pavilion, or both.

**flattened rose cut;** → marcasite.

**flattened trapped;** filled fractures of diamond shows flattened trapped gas bubbles in filled portion. → Revealing fracture filled diamond.

**flavone;** an aromatic, colorless, needle crystal, insoluble in water of flavonoid ketone  $C_{15}H_{10}O_2$ . Found as dust on the leaves, stems, and seed capsules of many primroses yellow plants. Occurring as yellow, red, and blue pigment in plants and fruits, generally in the form of glycosides. It melts at  $100^{\circ}C$ . Fluoresce in concentric acid. Also, produce synthetically. Used as dyes.

**flawless;** a term used to describe a diamond or other gemstone, which is free from all internal and external blemishes or flaws of every description as observed with a 10x magnifier. Often abbreviated: Fl or IF (internal flawless).

**flawless diamond;** a clarity grade used by GIA for polished diamond, which is free from blemishes and inclusions invisible to unaided eye and under 10x magnification corresponds to Scan. D.N. clarity grade with FL.

**flaws;** internal imperfections or faults in diamonds or other gemstones. Cracks, inclusions of other substances, internal twinning, cleavage, a liquid-filled cavity, or fracture of visible imperfect crystallization. A term to distinguish from a blemish, which is a surface imperfection. Synonym for imperfection. In some specimens of ruby or sapphire the inclusions caused the effect of asterism, or a structure of an opal, or dendritic inclusions in a moss agate. → Feather, blemish, imperfection.

**flaws in rough;** sometimes the ordinary cracks and fissures arise during trimming of the rough by miners and dealers.

**flaws, reduction;** the examination of internal or external flaws of diamond crystals to decide on the fancy cut of a nice balance to produce an optimum value. This description can be observed with an 8- or 10-power magnification by looking through polarized light.

**fleas in amber;** → inclusion in amber.

**flèches d'amour;** a French word meaning love arrows in literal translation. Needles, acicular, hairlike crystals of red-brown or golden-colored rutile are often embedded in a colorless quartz in apparently random orientation. Used as a gem. Also called *cupid's darts*, Venue's hair stone and rutilated quartz or sagenitic quartz.

**Fleischman Star Diamond;** a canary-yellow, emerald-cut diamond of 74.44 cts, it was recut into 71.07 cts, and mounted in a clip-pendant. Present owner unknown.

**flesh glow;** some beryl from Newry Maine fluoresce light peach or yellow to flesh color when contains cesium.

**flesh-red;** a local misleading term for spessartite of flesh color from Morehead, Mine, USA.

**Fleurus diamond;** a misleading term for quartz crystal from southwestern Belgium. Used as a diamond imitation.

**flexible matted;** a kind of fibrous aggregate of white tourmaline especially dravite parallel to *c*-axis which can be found in Rutherford, Virginia, USA.

**flexure;** folding of a member in a surface, usually a line.

**flies in the amber;** in some ambers consisting of resin exuded from pine trees are pine needles, flies or insects, moss, and lichens included.

**Flimmeropal;** a misleading German term for colorless precious topaz from Tasmania, Australia.

**Flinder's diamond;** a misleading term for white topaz from Tasmania, Australia. Used as a diamond imitation.

**flint;** a name widely is used as a synonym for chert of homogenous, dark-gray or black of a translucent to opaque, dull-colored variety of chalcedony, subvitreous luster, conchoidal or less splintery fracture, giving sharp cutting edge, usually occurring in concretion, gray, brown, or black. Tough very compacts. Contains mainly chalcedony with small particles of opal silica and sometimes organic remains, whitened from mixture with chalk. It is similar to chert. SG:2.65. H:7. Cut and polished by amateurs, but mostly used in porcelain industry as earthenware. Widespread. → Chert, hornstone.

**flint glass;** same as lead glass. A group of glasses characterized by relatively high refractivity and dispersion (fire), with sparkle, in which lead and potassium replace a considerable part of the lime and soda (54%  $SiO_2$ , 37%  $PbO$ , and 6%  $K_2O$ ). RI:1.54-1.78. SG:3.1-4.2. H:5. Dense flint glass has a refractive index of RI:1.775. SG:5.12. Extra dense flint glass has RI:1.962, and SG:6.33. When thallium is added in the composition it increases the dispersion of glass or can obtain colored glass, when annexing color agents such as copper, selenium and gold for red color, cobalt for blue, uranium oxide for yellow. Sometimes it is translucent to opaque glass is produced by adding opacifier materials. Used for paste or imitation stones, refractometer spheres, cut as glass or misnomerly crystal ornaments. → Crown glass, strass, beryl glass, thallium glass, borosilicate glass.

**flint glass;** a term used for colorless glass.

**flint hand;** a term used by Australian miners for a clay layer under bandstone, which has become extremely hard due to opalization in its mass.

**flint optical glass;** an optical glass with high dispersion and index of refraction used to form the diverging elements of an optical system. Also called optical flint glass.

**flint pebbles;** colloidal, rounded quartz stones, which have chemical and physical properties suitable for use in ball mills.

**flint ware;** another term for stone-ware.

**float;** a separated, displaced fragment of mineral or rock with other minerals or rock on the surface down slope from their origin. Also called floater.

**float;** tourmaline shows four shadow edges on the refractometer, which float above the normal values. It caused by overheating during heat treatment or by local overheating during polishing. Also known as *Kerez effect*, or *satellite readings*. This effect can be removed by repolishing.

**float;** a term used by Australian miners for color-floater. → Floater.

**floater;** loose fragment of well-quality weathered opal lying detached upon the earth's surface in the Australian opal mining districts. → Float stone.

**floater;** a term used by Australian miners for color-floater, loose, small opal of varying value which indicate the presence of good deposits. Also called float opal, float stone.

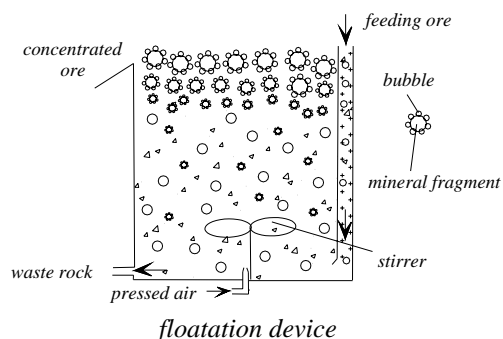
**floater;** a term used by Australian miners for slab of boulder occur in 15 to 30cm thick and flat in lower sandstone beds.

**floater;** → color-floater.

**floaters;** → doubly terminated elbaite.

**float gold;** gold particles which are very fine that will float on the surface of water when crushed or washed. Also called flour gold, powder gold, dust gold, floury gold, fold flower, gold powder, floatation gold, powdered gold.

**floating;** minerals or ores particles grounded very fine



so that will float on the surface of water or other chemical substances used for floatation. → Floatation.

**floatation gold;** same as float gold.

**floating light;** same as cymophane.

**floating reef;** floating surrounding rock that can be found in kimberlite in diamond mines.

**float mineral;** any minute particle of ore minerals transported away from their sources by water or gravity.

**float opal;** same as float stone, floater.

**float stone;** a lightweight, porous, friable variety of opal that floats on water and is in grayish color, spongy, and concretionary or tuberous mass. Synonym for swimming stone, float opal. Also spelled floatstone, floater.

**float stone;** a cellular or honeycomb quartz rock.

**floatstone;** same as float stone.

**flocculation;** aggregation of a finely divided precipitate into larger particles, said especially of soils and colloids.

**flohmfet amber;** → flohmig amber.

**flohmig amber;** a German term for fatty amber, slightly turbid, full of bubbles and resembling goose fat. Also spelled flohmfet amber.

**flohmgig Bernstein;** a German term for fatty amber or oily dim amber. → Flohmig amber.

**flood plain;** the flat ground along a stream covered with sedimentary deposits. The flood gravels are often used to indicate the presence of gemstones, diamonds and precious metals.

**floor;** an area, on which the diamond-bearing rock is the upper surface that was once weathered as a step. Also called weathering floor.

**floor;** in England a term applied to gypsum minerals that are found in thick nodular beds in Derbyshire. → Cakes.

**floor-wall;** the floor of mine working.

**flora inclusions in amber;** trapped remains of flora enclosed in amber resin are firs, pine, junipers, cypresses, spruce, arbor vitae, beech, chestnut, oaks, maple, magnolia, cinnamon, mosses, ferns and flowering herbaceous plants.

**floral;** a term used by Australian miners for a pattern of opal which appeared like a floral design because of rounded irregular units of color usually larger than pinfire.

**floran tin;** exceedingly small grained tin. Flower tin.

**flor de liz;** famous elbaite tourmaline from Queen mine of San Diego County, California, USA.

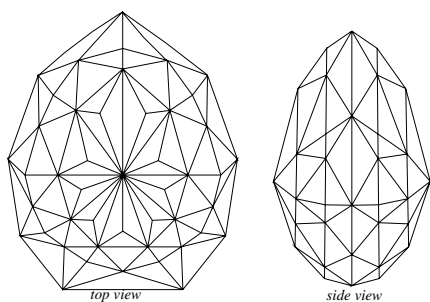
**Florence marble;** same as florentine marble, ruin marble. → Landscape marble.

**florentine marble;** same as ruin marble. → Landscape marble.

**Florentine Diamond;** a citron-yellow, diamond of 137.27 cts, from India, it was cut in the form of an irregular 9-rayed briolette, double rose cut with 126 facets. Also called Tuscan Diamond, Grand Duke of Tuscany Diamond, Austrian Diamond, Yellow Diamond, and Austrian Yellow Diamond. Present owner unknown.

**florentine marble;** a brecciated pictorial variety of yellow to brown marble with markings resembling the

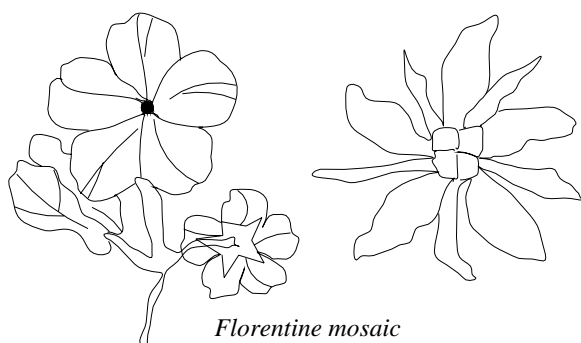
outlines of ruins on polished surface, which is known



Florentine Cut

as ruin marble or paesina marble.

**Florentine mosaic;** a picture or pattern design formed by small, opaque, geometrically shaped, varicolored fragments of ornamental hardstones such as lapis,



Florentine mosaic

turquoise, malachite, azurite, marble, and coral, which is named as florentine mosaic. The patterns are usually of flowers, or natural scenes and are cemented on a background of white or black marble. Used for making boxes, and plaques, or sometimes as ornaments. Materials used for florentine mosaic are pieces of colored stones such as marble, malachite, opal, turquoise, lapis lazuli, coral, etc. Also known as *inlay work*, *intarsia* or *pietre dure* or spelled *pietra dura*. → Fictile mosaic.

**florespar;** same as fluorite.

**flos-ferri;** a variety of aragonite, snow-white like coral in appearance. Found in Austria, and Iran. Also called flower of iron.

**flotation;** the floating of lighter weight crystals in a body of magma.

**flotation;** a process to separate and concentrate the valuable minerals. Froth is created in water under a variety of reagents, floats some finely crushed minerals, which are then skimmed off. Because some particles of minerals do not absorb water, while other minerals do.

**floating-zone process;** a system of melt-growth process of synthetic gemstones, which produces in blue, red, and orange by Hattori in Japan and red by Novosibirsk in Russia.

**flour gold;** same as float gold.

**floury gold;** same as gold flour, float gold.

**flow;** lateral or surficial outpouring of lava from a vent or fissure. Also called as lava flow.

**flowability;** in contrast to viscosity. The ability of a substance to flow.

**flower;** a form of setting of baroque fresh-water pearls in jewelry.

**flower agate;** a variety of moss or chalcedony with flower-like inclusions found in Oregon, USA. Also called flower stone.

**flow cleavage;** same as slaty cleavage.

**Flower Cuts;** a registered name for 5 new diamond cuts of an exceptional cut style especially effective to improve the appearance of fashioned diamonds of the lower color ranges and to increase the yield of stone. Designed by CSO consultant Gabi Tolokowsky in 1988. These five flower cuts are: Fire Rose Cut, Dahlia Cut, Marigold Cut, Sunflower Cut, and Zinnia Cut.

**flower of iron;** same as flos-ferri.

**flower of jove;** a term used by Pliny the elder for garnet or so-called carbuncle from Lychnis (Minor Asia) of purple to red color. In Latin *agrostemma flos jovis*.

**flowers of zinc;** same as zinc oxide, zinc bloom, zinc white, philosopher's wool, nihil album, lana philosophica. Produced when zinc is burned in air.

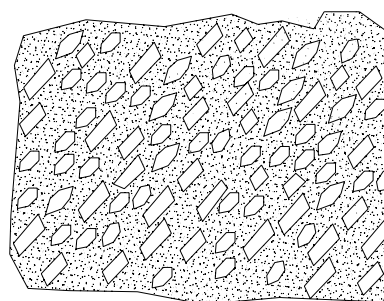
**flower stone;** same as flower agate.

**flower stone;** a misnomer for beach pebbles of chalcedony.

**flower twins;** → twinning in chrysoberyl.

**flowering obsidian;** a variety of white to grayish-black matrix of obsidian, in which white spherulitic mineral are included. Cut cabochon, beads and polished. Also called snowflake obsidian.

**flow lines;** any internal structure or inclusion in an



flow structure of phenocrysts in igneous rock

igneous rock, produced by the orientation of crystals formed by movement of lava or magma.

**flow obsidian;** a common glasslike volcanic rock of brown, reddish-brown, and black used for tumbled gems.

**flow resistance;** same as viscosity.

**flowstone;** any calcium carbonate minerals that formed usually by precipitation as excess carbon dioxide diffuses from water droplets dripping from the wall or

roof of a cave or cavern.

**flow texture;** same as fluidal texture such as glasses or gneisses. Also called fluidal texture.

**fluid;** having the property of flow, move freely. It can offer no permanent resistance to change of shape. → Liquid.

**fluidal texture;** same as flow texture.

**fluid energy mill;** when blocks of minerals or rocks were tumbled to produce spheres. After 25 minutes there is no detectable difference in the weight of diamond samples, but large reductions in weight were seen in diamond substitutes.

**fluid inclusion;** a general term for tiny amount of liquid or gas in a host mineral. A partly synonym of liquid inclusion. → Inclusions.

**fluograms;** a photograph from a fluorescent glowing substance or gem, which is placed on a photographic film in a dark chamber. Also called luminograms.

**fluolite;** a greenish-black variety of pitchstone, found in Iceland.

**fluor;** another term for fluorite.

**fluor;** an obsolete term for any mineral belonging to fluorite group used as metallurgic fluxes.

**fluorapatite;** a common form of apatite varieties of saamite, and francolite.

**fluorescein;** an orange-red colored, crystalline powder of  $C_{20}H_{12}O_5$ , obtained by adding of one oxygen, bridge to phenolphthalein, which fluoresce by reflected light. In alkaline liquid intense greenish-yellow and reddish-orange by transmitted light. Soluble in alkalis, in boiling alcohol, ether and acids. Used as dyes.

**fluorescence;** a variety of luminescence. Certain materials display an effect of producing visible electromagnetic light, when irradiated by ultraviolet light, cathode ray or X-rays, or other forms of radiation of an appropriate wavelength. The emitted light has another form of energy different to absorbing light. The fluorescence phenomenon ceases immediately, when the source of ray is removed, if the effect continues after removal of the energy source it is then termed *phosphorescence*.

**fluorescence by X-ray;** → X-ray fluorescence.

**fluorescence, characteristic of gemstones;** same as characteristic fluorescence of gemstones.

**fluorescence microscope;** a special microscope for investigating naturally fluorescent materials, in which the objects are illuminated by ultraviolet light, violet and blue light, which causes the gemstone to fluoresce and as reveal the structure of the stone.

**fluorescence of alexandrite;** alexandrite shows a red fluorescence between crossed filter, when the light is directed on to the stone through a copper sulfate liquid.

**fluorescence of amber;** → amber fluorescence.

**fluorescence of apatite;** some yellow apatite shows long-wave under ultraviolet rays and a yellow fluorescence.

**fluorescence of aragonite;** a pseudo-hexagonal crystal of aragonite, which mixed with native sulfur at Girgenti in Sicily shows a lovely rose-pink fluorescence.

**fluorescence of black pearl;** natural black pearls shows between crossed filter a dim red fluorescence, when the light is directed onto the stone through a copper sulfate liquid and a red filter. Treated black pearls with silver nitrate remain inert. → Fluorescence of pearls.

**fluorescence of calcite;** some calcite from favored localities shows a rose-red glow under long-wave ultraviolet rays.

**fluorescence of carborundum;** carborundum shows particularly after roasting an orange-yellow fluorescence, which is a useful identification for its presence as an inclusion in diamond powders.

**fluorescence of cultured pearl;** when the beads of cultured pearls are made from fresh-water mother-of-pearls they contain traces of manganese, which causes a greenish fluorescence under X-ray.

**fluorescence of diamond;** a great part of gem diamonds exhibits a sky-blue to violet fluorescence under daylight, and incandescent light (long-wave ultraviolet). Some stones have the presence of nitrogen in Type I, in fact are virtually inert. Also called fluorochromatic.

**fluorescence of emerald;** natural emerald with chromium content shows red fluorescence, while emerald transmits a quantity of red spectrum, and it is the red color that can be seen through the Chelsea filter. The presence of iron in emerald causes dimming or suppressed fluorescence (displays practically no fluorescence) and may not exhibit red through filter and remains green, which is known as *poison*, such as emerald from South India and Africa. Most synthetic emeralds and imitation emerald exhibits a stronger green glow through filters except older type *soudé* emerald, and some varieties of demantoid garnet, green zircon, and green fluorite are see as red through the filter.

**fluorescence of fluorspar;** the fluorspar or fluorite display under ultraviolet rays is a violet fluorescence.

**fluorescent of fresh-water pearl;** all fresh-water pearls, natural or cultured have trace element of manganese, which caused fluorescence and phosphorescence under X-ray.

**fluorescence of glass;** generally the fluorescence of glasses is not too helpful and usually only weakly fluoresces. Glasses colored by uranium fluorescing bright apple green.

**fluorescence of grossular;** massive greenish hydrogrossular garnet display under X-rays orange

fluorescence.

**fluorescence of kunzite;** kunzite from Brazil displays under long-wave ultraviolet rays rather a weak orange glow.

**fluorescence of pearls;** fresh-water pearls glowing under influence of X-rays shows greenish high luminescence. Biwa pearls or cultured pearls glow with a greenish yellow fluorescence, which is caused by the bead core of mother-of-pearl made of dull Mississippi mussels shell, which contain traces of manganese. True salt-water pearls do not glow under influence of X-rays. → Fluorescence of black pearl.

**fluorescence of pink topaz;** pink topaz shows a distinct glow under crossed filter, emending from a fine unresolved doublet at 682 nm.

**fluorescence of ruby;** natural and synthetic ruby have the same fluorescence spectrum, in which the doublet at 692.8 nm and 694.2 nm appear as a single intense line.

**fluorescence of sapphire;** yellow and off-white sapphire from Sri Lanka (Ceylon) displays apricot-yellow fluorescence under long-wave ultraviolet rays.

**fluorescence of scapolite;** massive scapolite mineral from Ontario, Canada displays bright yellow fluorescence under long-wave ultraviolet rays.

**fluorescence of scheelite;** any natural scheelite shows strong bluish-white to green fluorescence under short-wave ultraviolet rays.

**fluorescence of spinel;** synthetic red spinel are strongly fluorescent under crossed filters, in which the doublet at 692.8 nm and 694.2 nm appear as a single intense line. Natural spinel shows several narrow lines, like a set of organ pipes.

**fluorescence of synthetic emerald;** synthetic emerald displays under crossed filter a stronger glow than most natural stones, while emeralds from India or South Africa, which contain iron, shows no fluorescence.

**fluorescence of synthetic gemstones;** → fluorescence of synthetic emerald, ruby, sapphire, and spinel.

**fluorescence of synthetic ruby;** synthetic ruby normally displays a distinctly brighter red fluorescence than natural ruby under short-wave ultraviolet rays. → Fluorescence of ruby.

**fluorescence of synthetic sapphire;** synthetic sapphire display green bluish-white to green glow under short-wave ultraviolet rays due to titanium traces.

**fluorescence of synthetic spinel;** under long-wave ultraviolet rays synthetic spinel displays bright fluorescence due to trace of manganese and the same effect may be seen under X-rays.

**fluorescence of topaz;** yellow topaz from Brazil displays weak orange glow under long-wave ultraviolet rays.

**fluorescence of ultraviolet;** → ultraviolet fluorescence.

**fluorescence of yellow sapphire;** → fluorescence of

sapphire.

**fluorescence of yellow topaz;** yellow topaz from Brazil displays rather weak orange glow under long-wave ultraviolet rays.

**fluorescence of zircon;** yellow topaz from Brazil shows a weakly orange fluorescence under long-wave ultraviolet rays.

**fluorescence spectrum;** the spectrum may be seen, when a fluorescentable substance is influenced to emit radiation of one kind, when irradiated with radiation of another kind as in X-ray fluorescence spectroscopy. Used to detect ruby from red spinel and frequently from some diamonds.

**fluorescence, diamond separator;** the separation of diamonds or minerals according to their fluorescence properties, when exposed to an X-ray beam is utilized in a separator.

**fluorescence, X-ray spectroscopy;** → X-ray fluorescence spectroscopy.

**fluorescent;** exhibiting or having the property of fluorescence.

**fluorescent color of stones;** colors emitted from fluorescent materials or gemstones.

**fluorescent lamp;** a glass tube or electric lamp, which emits ultraviolet rays. The tube contains small amounts of mercury and inactive noble gas, usually argon at low pressure. The inner surface of this lamp is coated with a fluorescent substance that produces visible light.

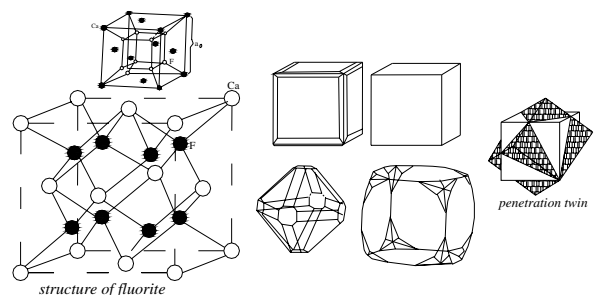
**fluorescent light;** rays, which are produced by a fluorescent lamp.

**fluorescent opal;** common opal emit fluorescence, when exposed to an ultraviolet light.

**fluorescent screen;** surface of a screen coated with fluorescent substance, which produces and emitted the portion of the spectrum, which the eye can view directly, such as X-rays.

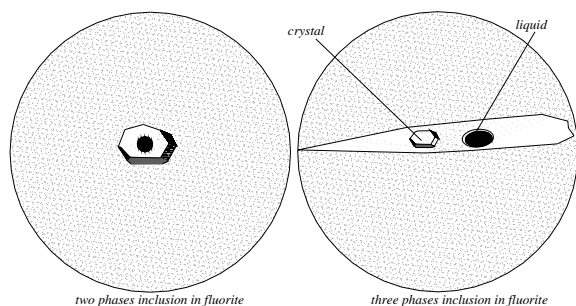
**fluoride coating;** some diamonds and colored gems are coated with an extremely thin layer of fluorite substances, which improves the phenomenal effect or color of the stones. → Coated stone, coated crystal (diamond).

**fluorite;** a suitable mineral for collectors and is rarely



structure, crystals and twin of fluorite

cut as gem. The most natural colored varieties may fluoresce strong under ultraviolet rays. Massive variety is carved as ornamental objects, which is known as *Derbyshire spar* or *blue John*. Yellow fluorite from



two and three phases inclusion in fluorite

Derbyshire, England is known as *yellow Ashover spar*. Also called flourspar, florspar, fluor. Often misnomered as blue John, false sapphire, false amethyst, false topaz, false ruby, false emerald or green quartz.

System: cubic.

Formula:  $4[\text{CaF}_2]$ .

Luster: vitreous.

Colors: colorless, commonly shades of purple, blue (blue John), green (green John), yellow, reddish, brown, bluish, green, black.

Streak: colorless.

Diaphaneity: transparent to translucent. Often zonar.

Cleavage:  $\{111\}$  perfect.

Fracture: subconchoidal to splintery. Brittle.

SG: 3.1-3.18.

H: 4.

RI: 1.432-1.434.

Dispersion: 0.007.

Found in Arizona (USA), Canada, Germany, Italy, Poland, Switzerland, blue john from England, and the Czech Republic.

**fluorite absorption spectrum;** absorption spectrum is weak in the green at 634, 610, 582, and 445 nm, and a strong band at 427 nm.

**fluorite as inclusions;** fluorite crystals are included in topaz and opals.

**fluorite cut;** sometimes are cut as faceted gems, while refractive index is low but frequently faceted in form of trap-cut. Faceted gems are misnomered as *South African emerald*. Sometimes roughly shaped samples, which are polished using water called *Ayr stone* can be seen.

**fluorite luminescence;** most fluorite crystals shows fluorescence under LWUV light in several colors (yellow, blue, green, reddish, violet and white) caused by presence of europium. Those stones with a green glow contain divalent ytterbium. Blue John from Illinois, USA and some peculiar fluorite crystals are inert. Some pieces phosphorescent and some glows

under X-rays. Some fluorite fluoresce blue because impurity of  $\text{En}^{2+}$  or color centers or both.

**fluorite, synthetic;** synthetic fluorite crystals in several colors containing dopants are usually grown by the pulling method from a pure melt devised by Czochralski process or by the somewhat analogous Bridgeman-Stockbarger technique.

**fluorochromatic;** → fluorescence of diamond, fluorescence.

**fluoroscope;** an instrument consisting of a fluorescent screen and a source of ionizing radiation to make the direct observation of the effect of X-rays, cathode rays, etc. possible. Opaque object such as pearl are placed in a closed chamber.

**fluoroscopy;** inspection by fluoroscope. → Fluorescent screen.

**flourspar;** same as fluorite.

**flute;** a thin folding parcel paper used to put a diamond in.

**fluted;** a parallel channeled, or grooved, structure or texture.

**fluvial;** the term applied to any sediments formed by the action of streams and rivers. Also called fluviate.

**fluvial;** pertaining to a river or stream.

**fluvial denudation;** erosion of land surface by stream or rivers.

**fluvial deposit;** applied to any sedimentary accumulation formed by a river stream. Also called fluvial gravel. Spelled as fluviate deposit.

**fluvial gravel;** same as fluvial deposit.

**fluviate;** relating to, or occurring in rivers and stream beds. → Fluvial.

**fluviate deposit;** same as fluvial deposit.

**flux;** in metallurgy a substance or mineral material, which is used to reduce smelting temperature.

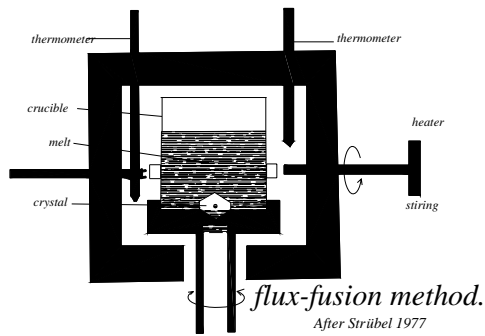
**flux;** a resin or other similar material, which is used in soldering, welding and brazing such as borax-base or salt compound used to remove undesirable substances or prevent the formation oxides.

**flux;** in ceramic or glass industries any substance or mixture, which lowers the normal vitrifying temperature of a composition.

**flux;** a stream or river of flowing water. → Flux stone.

**flux-fusion method;** this is a technique used to make certain synthetic gemstones such as emerald, ruby, spinel, quartz, Alexandrite, YAG, etc., man-made crystals growing in a high melting solvent or flux. The material or composition of desired synthetic crystal (beryllium and aluminum oxides) is mixed with flux material (lithium molybdate) that reduces the melting temperature to a point where it becomes supersaturated. At this temperature the source material is precipitated out and grows on the seed crystals. Used by Chatham,

Gilson and others. Also called flux-fusion process,



flux-melt method. → Verneuil process.

**flux-fusion method, corundum;** → flux-fusion method.

**flux-fusion method, emerald;** → flux-fusion method.

**flux-fusion method, of crystal;** growing of crystals in flux-fusion method. → Flux-fusion method.

**flux-grown synthetic alexandrite;** synthetic alexandrite crystals are made by flux-fusion method by annexing Fe, and Cr manufactured in USA and Japan.

**flux-grown synthetic ruby;** a method same as flux-fusion used to make certain synthetic gemstones such as ruby manufactured by Chatham and Kashan Laboratories of Texas, USA. → Flux-fusion method.

**flux-grown synthetic emerald;** → synthetic emerald, flux-fusion method.

**flux-grown synthetic spinel;** → synthetic spinel.

**flux inclusion;** inclusions, which are produced by hydrothermal synthetic emeralds by presence of wispy or veillike groups, manufactured by Chatham (USA), Gilson (France), and Zerfass (Germany). That is an unmistakable characteristic of flux-fusion or flux-melt method.

**flux-melt method;** → flux-fusion method.

**flux-melt synthetic;** a term used by Gilson flux-melt synthetic emerald same as Chatham method.

**flux powder;** a substance or mineral material, which is used to lower the fusion temperature.

**flux stone;** cryolite, limestone, or other mineral (or rock such as dolomite) used to lower the melting point of ore. → Flux.

**Fly Diamond;** a white, octahedron diamond crystal of 60 cts, found in 1872 in Vaal River, Cape Province, South Africa. An inclusion centered in this stone resembles a fly. The Stewart Diamond or Spaulding diamond was also found in this deposit.

**fly in the amber;** → flies in the amber.

**Fm;** a chemical symbol for the element fermium.

**foam;** same as pumice.

**foam glass;** cellular glass blocks usually manufactured by fusing powdered glass with carbon particles or gasifying material, used as a structural heat insulating material. Also called frothy glass.

**foam glass;** another term for pumice rock.

**foam spar;** same as aprite.

**foam stone;** same as aprite.

**foamy;** pertaining or consisting to/of foam.

**foamy amber;** a soft, white, chalky almost opaque amber which will not take a polish. Also called frothy amber. Are used in inlay works.

**focal distance;** → focal length of a lens.

**focal length of a lens;** the distance from a focal point (center) of a hand lens is the focal length of the lens. Also called focal distance.

**focus;** a point, at which light meets after passing through a lens or optical system or after being refracted.

**focusing of microscope;** the movement of a microscope for fine adjustment in the clockwise direction will bring the tube closer to the stage and slide or object until the image is clearly resolved through the eyepiece, when it is not focused it must be racked up.

**fog;** another term for turbid clouds. → Rain.

**Foguete;** a pale-red elbaite tourmaline of 320 kg from Minas Gerais, Brazil. Found in 1978? Also called rocket. Present whereabouts unknown.

**foid;** a collective term for feldspathoid such as leucite, analcime, nepheline, etc.

**foil;** a thin leaf of metallic sheet of gold, silver, copper, or an alloy usually of 0.01-0.02 mm or less, used as a backing to a certain mounted glass or inferior gemstone to improve the color and brilliance.

**foil;** frequently has been used deceptively to improve some inferior material or stone the appearance of a gemstone. Also known as leaf. → Foil back.

**foil;** a thin coat of tin amalgam applied to glass to make it into a mirror.

**foil back;** diamonds or other gemstones backed with colored foil or thin silver leaf to impart or improve its color of brilliancy or both. Same as chatons. Also called imitation foil back.

**foil back, green;** foil back is made from an alloy of fine copper 10 carats, silver 6 carats and gold one carat.

**foiled stone;** pale-colored gemstone mounted with a backing of silver in order to improve its brilliancy or color or both. Easily detected by examining with lens. → Mirror foiling.

**foiling;** a method of altering or improving the color, brilliancy, or both of certain gemstones by backing with foil. → Foil, foil back.

**foil stone;** a term applied to imitation jewel.

**fold;** a flexure in rocks.

**fold flower;** → float gold.

**folgerite;** an old name for pentlandite.

**folding diamond paper;** → envelope diamond.

**folding stone paper;** → envelope diamond.

**folia;** a thin flake or leaflike stratum or layer. A lamella.



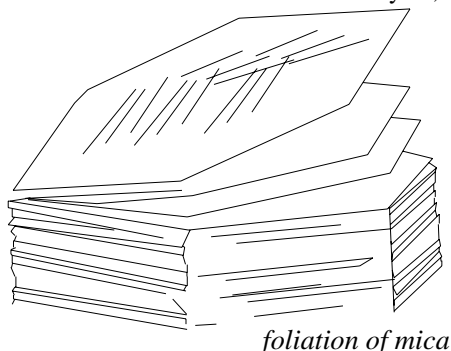
**foliated;** having a layered form same as onionskin. Interfoliated structures are interleaved and split easily into, thin plates or flakes.

**foliated beryl;** a misleading term for pycnite a light pink variety of topaz.

**foliated zeolite;** zeolite split easily into, thin plates or flakes.

**foliated structure;** rock which has bedding fissility and schistosity. → Foliation.

**foliation;** a general term for splitting up or arrangement of certain mineral or rock in leaflike layers, such as



mica, chlorite, and talc.

**foliation;** ornamental objects cut in form of leaves, vines, etc.

**foliation;** laminated structure or parallel fabrics in metamorphic rocks.

**folkstone marl;** a rigid or firm fossilized marl, varying in color from gray to dark blue.

**Fontainebleau sandstone;** a sandstone with cement of crystalline calcite from Fontainebleau in Paris, France.

**fool's gold;** a popular misleading term for pyrites that resemble gold in color by native prospector.

**fool's gold;** sometimes misnomerly applied to marcasite.

**foot;** a unit of length equal to 0.3048 meter.

**footwall;** the floor of a working ore mine.

**forcherite;** an undesirable term for orange-yellow opal colored by colloidal  $\text{As}_2\text{O}_3$  or orpiment.

**forehead ornament;** ornamental objects made of silver or gold in various style sometimes set with stones worn by women on the forehead.

**foreign inclusion;** → accidental inclusion

**foreshore mining;** same as beach mining.

**foresite;** → stilbite.

**forest marble;** limestone marble from Jurassic epoch in England used as cladding stone. Also called landscape marble.

**forgery;** presenting a counterfeited article as a genuine.

**form;** a term used in crystallography for a restricted sense to designate a specific type of crystal face or group of similar faces.

**formaldehyde;** a colorless, poisonous, suffocating

pungent gas of  $\text{HCHO}$ . Soluble in alcohol, water and ether. Usually derived from methyl alcohol by oxidation. Aqueous solution is known as formalin. Used as a disinfectant and preservative and as a hardening agent for various resins and plastics.

**formalin;** → formaldehyde.

**formanite;** → fergusonite.

**formation;** a term applied to the group of related strata that were form a geologic period. The formation is a body of rock recognized by lithologic homogenous characteristics. The process taking place in the earth's crust resulting of formation of valuable minerals or potentially valuable deposits.

**formation of gemstones;** the formation of gemstones taking place in the earth's crust in all three processes, such as igneous, metamorphic, and sedimentary.

**formation of diamond;** diamond crystallizes directly from rock melts rich in magnesium at a depth of 150 km or more in the earth. The melt is essentially saturated in carbon dioxide gas at extreme high pressures and temperatures nearly  $1400^\circ\text{C}$ . Thus rocks, which contain natural diamonds are of the deep mantle of the Earth and have similar composition. Also called diamond occurrence, diamond, genesis of.

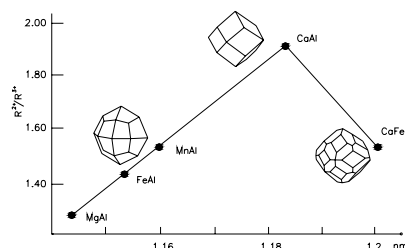
**formation of pearls;** some shelled mollusks (not all mollusks) with a pearly nacreous can produce a pearl in the biological processes for ornamental use.

**formation striae;** curved, colored, nearly parallel bands often seen in synthetic corundum, differ from the straight color zones in natural corundum. Also called formation striation.

**formation striation;** → formation striae.

**form birefringence;** a small double refraction commonly seen in minerals of one refractive index included in another mineral, which has another refractive index. The sub-parallel fibers of chalcedony would have a positive uniaxial form birefringence.

**form change of garnet crystals;** because of large radius deficiency between Mg and Mn and between Mg, Fe and Mn and also Ca in garnet lattice minerals change



*garnet crystal form change depend on cation radius and unitcell. After Kostov 1968*

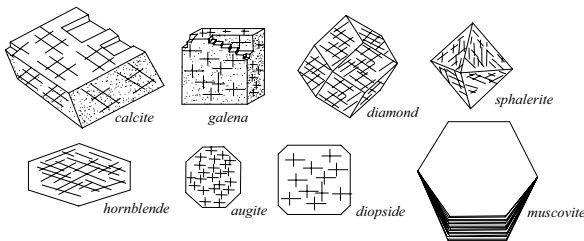
their appearances as seen in figure below. Ca and Al minerals having simpler crystals as those containing Mg, Fe and Mn such as andradite.

**form crystal;** a group of all the like faces possible on a crystal of given symmetry elements of a particular crystal class, such as a cube, or octahedron in cubic class.

**form, general;** hexagonal bipyramid form has a general relationship to the elements of symmetry.

**FORMINIÈRE;** an acronym for Société Forestière et Minière du Congo.

**form of cleavages;** cleavage meaning the tendency



forms of cleavage

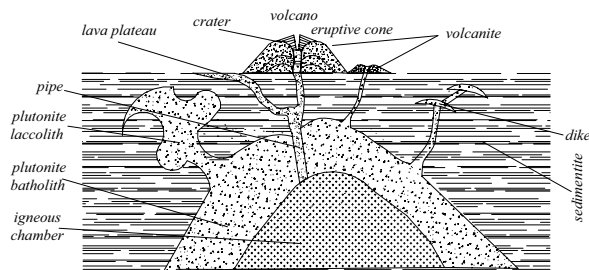
possessed by many minerals being that they are rather easily divided or cleaved along or parallel to one or more certain plane of weak molecular bonding. Different crystals have different cleavage directions, which depend upon molecular bonding such as diamonds cleaved parallel to the octahedron faces. Cleavage is important in measuring the process of cleaving of stones.

**form, open;** same as open-end form such as hexagonal prism.

**form, special;** hexagonal prism and pinacoid form has a special relationship to the elements of symmetry.

**forms, crystal;** → crystal form.

**forms of igneous activity;** volcanic lavas are commonly erupted through piped or other similar conduits, and dikes. Tuffs are composed of lava edged fragments



forms of igneous activity

which is deposits like sedimentary fashion. Plutonic rocks solidify in large masses in interior of the Earth in few kilometers long, which is called batholith, and those in lenticular form known as laccolith. Dikes or sills are shallow-dipping thin sheets normally driven from volcanic pipes during the extrusive activity of lava.

**forsterite;** an end member of olivine group. Trimorphous with ringwoodite and wadsleyite. → Peridot, fayalite.

System: orthorhombic.

Formula:  $4[Mg_2SiO_4]$ . Contain Fe or sometimes Cr.

Luster: vitreous to greasy.

Colors: green, lemon yellow, white.

Streak: colorless.

Diaphaneity: transparent to translucent.

Cleavage: {010} imperfect, and {100} imperfect.

Fracture: conchoidal. Brittle.

SG: 3.34.

H: 7.

Optics;  $\alpha$ :1.635,  $\beta$ :1.65,  $\gamma$ :1.67.

Birefringence: 0.035. ⊕.

Found in Brazil Germany, Norway, Sweden, China, Russia, and USA.

**forsterite marble;** a metamorphic limestone containing silica and crystalline calcite together with forsterite.

**fortaleza aquamarine;** a term used in Brazil for finest blue quality of aquamarine.

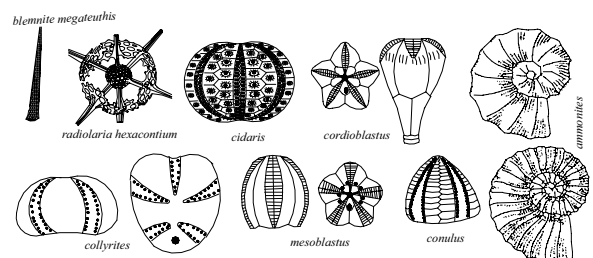
**fortification agate;** a variety of agate that shows, on a polished surface, sharp angular concentric marking or parallel zigzag bands, which resemble the plan of a fortification. Sometimes called *bastion agate*. May be used as topographic agate, ruin agate, or landscape agate.

**forward bias;** the moving of electrons of a semiconductor substance in the conduction band in the n-region toward the p-region by the electric field, these electrons will combine with holes of valence band in the junction region. It is a relationship of *p-n* semiconductor junction or *n-p-n* or *p-n-p* configuration, which produced small current.

**foss;** in some gray zones of a diamond irregular furrow or grooves can be seen.

**fossicker;** an Australian term for one who digs sporadically or only in a minute way and usually on the ground for opal or previously worked by other miners.

**fossicking;** an Australian term for hunting for gold or precious stones, which requires some mineralogical and



different fossils

geological knowledge.

**fossil;** an organic trace of past geological periods of animal or plant remains preserved in a rock or mineral in the earth's crust, usually in a sedimentary rock. Such fossilized material is found in fossilized agate, jasper, and opal. Sometimes it has been worked into gem articles, including opalized mussels and snails, turrilite, lumachella, ammonite, etc. → Fossil ivory, odontolite, belemnite.

**fossil agate;** when chalcedony is pseudomorph after wood, sometimes cut and polished for ornamental stones. → Fossil wood.

**fossil algae;** when chalcedony (silica) or calcium carbonate in the form of marble is pseudomorph after seaweed.

**fossil alkali;** same as mineral alkali, alkali mineral.

**fossil ammonite;** → ammonite, fire marble.

**fossil bearing;** same as fossiliferous.

**fossil bone;** same as odontolite.

**fossil bryozoa (marble);** a variety of marble containing fossils of bryozoa, which belong to the phylum Bryozoa and are characterized chiefly by colonial growth with hardened exoskeleton.

**fossil content;** a rock containing fossils.

**fossil copal;** same as copalite.

**fossil coral;** chalcedony or silica or marble pseudomorphous after coral (structure has been replaced by agate or calcium carbonate). A silicified coral. Also called beekite.

**fossil crinoids;** → encrinital marble.

**fossil dinosaur bone;** fossilized dinosaur bone from Colorado, USA used for ornamental purposes. Also called dinny bone.

**fossiliferous;** containing organic remains of animals, or plants.

**fossil flour;** → diatomite.

**fossil gastropod;** a rare marble consisting of univalve mollusks or sea snails with an unusual pattering. → Gastropod.

**fossil ivory;** a variety of ivory obtained from the tusks of mammoths *Elephas primigenius* or the walrus, whose body are buried in the frozen mud. It differs little from elephant ivory. It is found in Siberia (Russia), Alaska (USA), Canada and elsewhere. → Odontolite.

**fossilized;** to convert into a fossil buried in rock or in the earth's crust.

**fossil limestone;** fossil limestones are usually mosaic-like consisting of shelly, coralline, sea lilies, and crinoidal fragments. Also called encrinital limestone. → Encrinite.

**fossil marble;** fossil marbles are usually fawn to reddish-brown consisting of shelly, coralline, sea lilies, and crinoidal.

**fossil opal;** opal pseudomorphous after wood, fresh-

water mollusks, marine shells, belemnites, and animals bones, sometimes cut as gems.

**fossil pineapple;** opal pseudomorphous after radiating crystal of glauberite, gypsum, calcite, gaylussite and other minerals found in South Wales, Australia.

**fossil resin;** various natural occurring resin or gum remains preserved in geologic deposits such as amber, flagstaffite, copalin, glassite, and posepnyte. → Amber.

**fossil salt;** same as rock salt.

**fossil stromatolite;** a variety of marble consisting of laminated structure formed in shallow waters, which has a specular mushroom shaped mass of blue-green color.

**fossil tooth;** same as odontolite.

**fossil tripoli;** → diatomite.

**fossil turquoise;** a misleading term for odontolite.

**fossil wax;** same as ozokerite.

**fossil wood;** when chalcedony is pseudomorph after trunks and limbs of wood, in which the wood cells have been entirely replaced by inorganic materials, silica such as agate or opal, or other substances. Frequently cut and polished for ornamental stones. Found at the Petrified Forest National Museum in Arizona, California, New Mexico, and Oregon, USA. Also called petrified wood. → Fossil agate.

**foundation of the new Jerusalem;** → foundation stones.

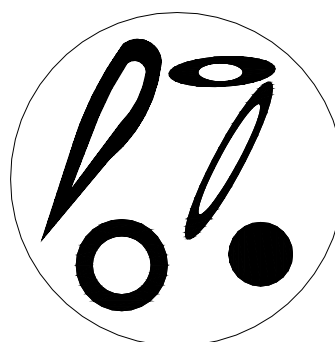
**foundation stones;** it is reported that the wall of the New Jerusalem is built on twelve stones as described in Apocalypse, Revelation XXI, same as Breastplate of the High Priest's. Also called foundation of the new Jerusalem. → Breastplate of the Jewish High Priest.

**founder of chemistry;** same as Hermes or Hermon Trimegetus. → Tabula Smaragdina, the.

**four C's of diamond grading;** a catch phrase for fashioned diamonds, which are graded by four factors: color, clarity, cut and cts, (weight).

**four grainer;** same as one-cts, stone. → Grainer.

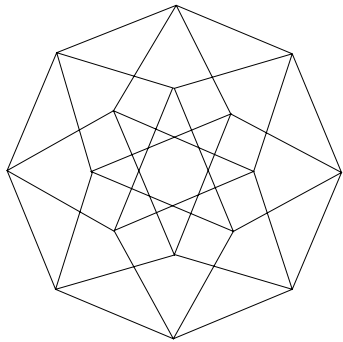
**four bubbles in glass;** to distinguish the glass are found



*four  
typical  
bubbles in  
glass*

different round or elongated types of bubbles.

**four dimensional cut;** a modified 8-sided cut with 32 triangular facets and a 8-edged table in which there are

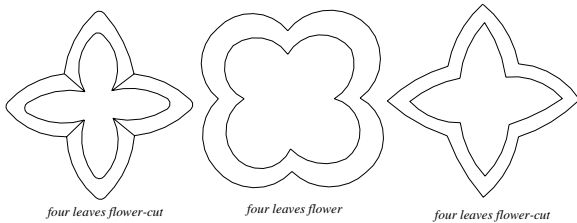


four dimension square-cut

two 8-rayed stars. This is an exhibition of Mathematical Institute of the University of Regensburg, Germany.

**four-level laser;** → inverted population level.

**four leaves flower cuts;** modified flower cut with four rayed wings. There are four star facets in the crown and

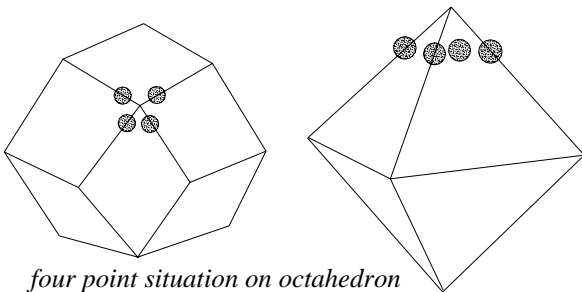


three different kind of four leaves flower-cuts

a big four rayed table.

**furling;** a twinned crystal, which consist of four individual crystals.

**four-point;** a cube face as the table in a brilliant-cut diamond, when the table of a cut stone is parallel to the



four point situation on octahedron and dodecahedron diamond

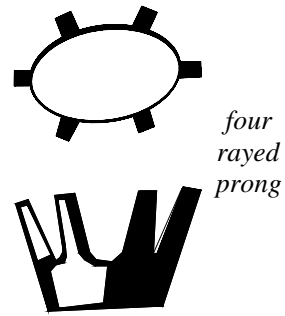
face of the cube with a fourfold symmetry, which has 2 directions of cleavage traces. Also called four-point diamond. → Point-cut diamond, three-point.

**four-point;** a gemstone or diamond, which weighs four one-hundredths of a carat or 0.04 carat.

**four-point diamond;** same as four-point.

**four-rayed prong;** one of several curved, sharp pointed, finger-like narrow metal support of claws used to fasten

and hold a gemstone in place.



four rayed prong

**four-square diamond;** → cross work.

**four-square stone;** → cross work.

**forty-five degree dop (adapter);** the 45° position of a dopstick used for cutting and polishing crown table.

**fovea centralis;** a small depression or pit on the retina at the back of eye in the line with the visual axis, which is the central spot of visual field made of rods. → Eye.

**fowlerite;** a massive variety of light red to brown-red rhodonite containing zinc. Chemical formula:  $10[(\text{Mn}, \text{Zn})(\text{SiO}_3)]$ . Frequently cut as gems.

**foyaite;** a fine-grained plutonic rock of nepheline syenite group. A rock with trachyoid texture consisting of orthoclase, nepheline, hornblende, and accessory mica, sodalite, zircon, nosean, and pyroxene. Also called nepheline syenite.

**Fr;** a chemical symbol for the element Francium.

**fractional crystallization;** separation of magma into two phases, liquid and crystal.

**fractional magma;** → fractional crystallization.

**fractionation;** → fractional crystallization.

**fracture;** a general term for the freshly broken surface of gemstones and minerals other than along planes of cleavage, not to be confused with cleavage directions. That is sometimes a useful identifying feature. Some typical fractures are described: conchoidal (shell-like), even, uneven, hackly, fibrous, silky, and splintery. Thus calcite has a perfect rhombohedral cleavage, but conchoidal fracture. → Cleavage.

**fracture;** an irregular curved splintery chip or break on a diamond along a direction other than cleavage plane.

**fracture;** in structural geology a general term for any break in a rock which include cracks, joints and faults.

**fracture cleavage;** same as false cleavage.

**fracture, conchoidal;** → conchoidal fracture.

**fracture filled diamond;** → filled diamond.

**fracture filling;** a series of imperfections, caused by the too-rapid polishing on diamond girdle, which produces very fine hair-like fractures, small cleavages or lines on or within the girdle. The lines are fuzzy, the diamond without the normal, smooth and waxy polish, which can be filled with high refractive materials such as epoxy or

lead-based glass and capable of obscuring the tiny cleavages. → Laser drilling diamonds, filled diamond.

**fracture in glass;** typical fractures in glass and in amorphous minerals are shell-like fracture or conchoidal fracture, hackly or splintery fracture and fibrous fracture.

**fracture of plastics;** fracture is generally conchoidal. → Plastics properties.

**fracture plane;** surface along which a mineral or rock fail.

**fragment;** a piece of a mineral or a rock that has been detached or broken from a pre-existing mass.

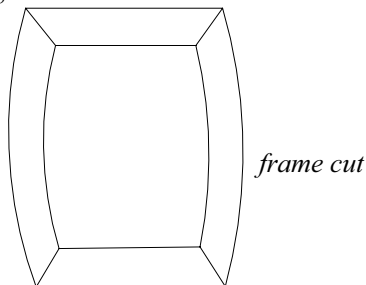
**fragmental deposit;** a term described a deposit, which consists of fragments of minerals, gemstones, or rocks.

**fragmental rock;** → clastic.

**fragmentation;** reduction of mineral, ore or rock into small pieces.

**fragmented;** breaking into fragments.

**frame cut;** a frame-like cut with four curved 4-sided



facets with a big table.

**framesite;** a gray to black, cryptocrystalline to granular diamond similar to carbonado from Premier Mine in South Africa and elsewhere. → Black diamond, bort, and carbonado. Also called framesite bort.

**framesite bort;** → framesite.

**framework silicate;** same as tectosilicate.

**francium;** an element of alkali metal of the Periodic System with atomic number 87 with the symbol Fr.

**francolite;** a stalactitic variety of colorless fluor-apatite containing amounts of carbon oxide. Synonym for satellite, kurskite, carbonate-fluorapatite, carbonate-apatite. Found in England.

**frangible;** breakable, fragile, or brittle.

**Frankfurt Solitaire Diamond;** a fine-quality, brilliant-cut diamond of 44.62 cts, which once belonged to Francis I, Grand Duke of Tuscany, it was mounted in his belt buckle and later in a tiara. Present owner unknown.

**Franklin furnace;** gem quality of zincite found at mines of Franklin furnace, Sussex County, New Jersey, USA.

**Franklin Roosevelt Aquamarine;** same as Roosevelt Aquamarine, Franklin.

**franklinite;** a mineral of the spinel group. Slightly

magnetic. Prized by collectors.

System: cubic.

Formula:  $8[(Zn, Mn, Fe^{+2})(Fe^{+3}, Mn^{+3})_2O_4]$ .

Luster: metallic to dull.

Colors: iron black.

Streak: reddish-brown to black.

Diaphaneity: opaque.

Cleavage: {111} parting, fair.

Fracture: uneven to subconchoidal. Brittle.

SG: 5.07-5.22.

H: 5½-6½.

RI: 2.36.

Found in Franklin and Sterling Hill, Sussex County, and New Jersey, USA.

**Frank Smith Mine;** location of a minor diamond deposit in the Barkly, Cape Province, South Africa.

**fraudulent coloration of rough diamonds;** a style of coating diamond or other gemstones to improve the diamond color. It is detected by boiling the stone in concentrated sulfuric acid, which removes the coating layer and revealed its true color. → Gem diamonds fraudulent color.

**Fraunhofer lines;** a group of dark absorption lines of the solar spectrum, due to the absorption of light by vapor of elements in the chromosphere in the outer layer of the sun or other stars. The principal lines are follows:

table 5: Fraunhofer absorption lines of the solar spectrum

<i>A</i>	<i>oxygen</i>	760.6, nm
<i>B</i>	<i>oxygen</i>	687.0, nm
<i>C</i>	<i>hydrogen</i>	656.3, nm
<i>D1</i>	<i>sodium</i>	589.6, nm
<i>D2</i>	<i>sodium</i>	589.0, nm
<i>D3</i>	<i>helium</i>	587.56 nm
<i>E</i>	<i>iron</i>	527.0, nm
<i>F</i>	<i>hydrogen</i>	486.1, nm
<i>G</i>	<i>iron</i>	430.8, nm
<i>H</i>	<i>calcium</i>	396.9, nm
<i>K</i>	<i>calcium</i>	393.37, nm

The difference in refractive index of diamond or other gemstones, are measured between the B and G Fraunhofer lines. Also called Fraunhofer spectrum.

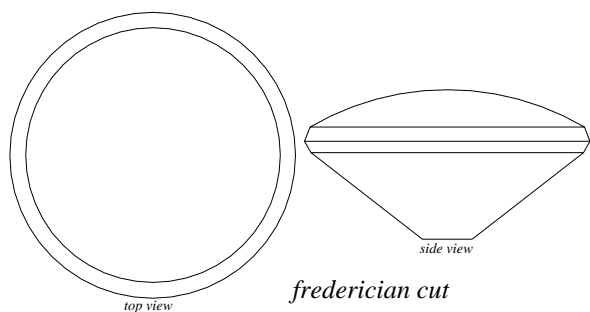
**Fraunhofer spectrum;** same as Fraunhofer lines.

**freak;** a term used by Australian miners for an opal which is of unusual form or quality.

**Frederician cut;** a flat cabochon cut frequently applied to chrysoprase with one or two rows of facets around the girdle.

**free;** a descriptive term for naturally occurring metallic

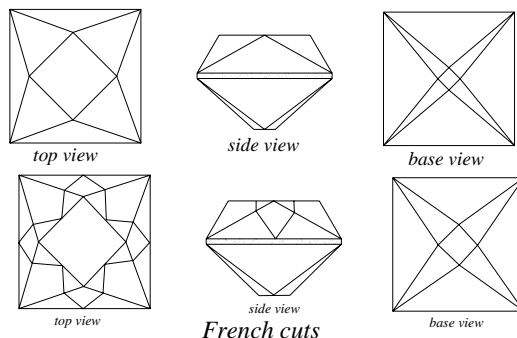
gold, silver, copper, etc.



frederician cut

- free electron gas;** → band theory in metals.
- free gold;** pure gold found in nature consists of placers.
- free pearls;** same as cyst pearls. Pearl occurs within the tissue or not attached to the mollusk shell. These pearls are the most perfect and also called true pearl or mantle pearls.
- free silica;** rock crystal occurring in granites.
- freestone;** any fine-grained, thick-bedded, even-textured sandstone, which can be freely worked or quarried that may be cut free in any directions without a tendency to split. Used as a building and cladding stone.
- freezing rain;** same as glaze.
- Frémy rubies;** a misleading term for synthetic ruby once manufactured using the Frémy method (1891) in France made by a chemical process of heated aluminum fluoride. Also called scientific ruby.
- French Blue Diamond;** a blue, heart-shaped diamond of 67.50 cts, it believed was cut from a rough stone of 112.50 cts. It was among the stolen jewels from the French Royal Treasury and believed to have been recut into 45.52 cts, than renamed, the Hope Diamond. Also called Blue Diamond of the Crown. → Tavernier Blue Diamond.
- French chalk;** a soft, white, compact variety of talc, soapstone or steatite used for marking lines on fabrics, crayons, as a grease remover in dry cleaning and polishing.
- French cliff;** a variety of chalk from Seine valley of France, used as a bleaching powder.
- French color;** a misleading term for ruby of light color.
- French color rubies;** another term for light red rubies.
- French Coral Diamond;** a yellowish, rough diamond of 7.25 cts, found in Nevada County, California, USA. Its ultimate disposition unknown.
- French Crown Jewels;** the French Royal Treasury was founded by Francis I in 1530, and expanded by Louis XIV. Part of the jewels was stolen in the robbery from Grand Meuble in 1792. Some of them have been repurchased by the French Government. ; → Apollon Gallery of the Louver Museum, Anne of Austria, Cardinal Mazarin, Grand Mazarin Diamond,
- French cut;** a variety of mixed cut, in which the girdle

and the table are both square in outline, while the two squares are mutually inclined at 45°. Also on the crown

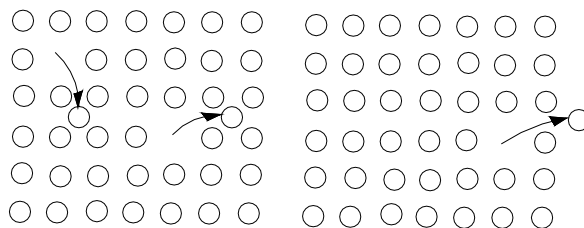


French cuts

24 small facets, consisting of 8 star facets, 4 bezel facets and 12 girdle facets. However, the base may be either brilliant-cut or brilliant step-cut. Also called French cut stone.

- French cut stones;** → French cut.
- French Gemological Association;** same as Association Française de Gemmologie.
- French glass;** various glass types produced in France in various colors from verde de fougère.
- French jet;** same as Vauxhall glass. A variety of black glass used in Medieval time as a jet imitation in jewelry and particular for decorating clothes. Beads made of black glass are commonly faceted.
- French jet;** a misleading term used in England for soft jet, in depend on its origin, which has no connection with either its country or with black glass which is called French jet. Also known as bastard jet.
- French polish;** furniture finish, containing shellac dissolved in methyl alcohol.
- French stone;** a misleading term for glass imitation stones.
- French Sudan;** same as Sudan Republic. A number of kimberlite pipes in West Sudan were discovered in the cliffs of Tambouara. A new union between former Senegal and French Sudan, which is calling Mali Federation.

**French tip;** alternate replacement of the large bezel facet at the point with a few number smaller facets on pear-shape, heart-shape, and marquise cuts.



defect in a two dimensional ionic crystal, right: Schottky and left: Frenkel

**Frenkel defect;** a crystal with defect point in the atomic structures, which produces an electronic transition by removing of an ion from its structure. → F center, defects in crystal and color effect, color centers.

**frequency factor;** a term applied in crystallography for the number of different group of planes, which have the same form.

**frequency of light;** the number of cycles, vibrations, or oscillations of a wave of light in unit of time in one second. The unit of frequency of light is the hertz.

**fresh-water pearl;** a variety of pearls found in various fresh-water mussels with varying degrees of fine luster of species *Unio margaritifera* that are known as *mussel pearl*. Found in rivers of Europe, such as *Scotch pearl*, North America and USA. Fresh-water pearls obtained from other genera of shellfish such as bullhead *Pleurobema oesopus*, niggerhead *Quadrula ebena*, buckhorn *Tritogonia verrucosa*, and three-ridge *Quadrula plicata* or *Quadrula undulata*.

**fresh-water pearl;** *Clam pearl* a variety of fresh-water bivalve pearls of inferior quality in relation to oyster pearl in various colors. These fresh-water pearls are common in North America, Amazon basin, Mississippi River, Scandinavia, Scotland, and European waters. Mississippi region pearls are found in bivalve mussels such as *Alasmodon margaritifera*. Some fresh-water bivalves are more interesting for the production of cultured blister pearl such as *Cristaria plicata* from Chinese rivers the Chinese insert pieces of bone, wood, brass and leaden images of Buddha between the shell and mantel. Fresh-water pearls from Bangladesh river are pinkish in color. Usually fresh-water pearls are baroque in shape, have a strong color and orient, hence they are called *dogtooth pearl*, *wing pearl*, and *petal pearl*. Fresh-water pearls are usually fluorescent under X-rays, salt-water pearls are inert.

**fresh-water pearl, cultured;** suggested the first cultured pearl was tried on fresh-water mussel in China. They put pieces of bone, wood, brass and leaden images of Buddha between the shell and mantel. → Fresh-water pearl.

**fresh-water pearl fluorescent;** → fluorescent of fresh-water pearl.

**fresh-water pearl, oldest;** the oldest fresh-water pearl are known from China.

**fresh-water pearl mussel;** → fresh-water pearl.

**fresh-water pearl shell;** → fresh-water pearl.

**Fresnel equation (optics);** an equation in crystal optics, which gives the intensity of each of both polarization components of incident light, which is approximately reflected from a smooth surface or transmitted at the boundary between two media such as transparent media with different indices of refraction. Also known as Fresnel formula.

**Fresnel formula;** → Fresnel equation (optics).

**friable;** a mineral that crumbles naturally or is easily broken into grains, or powders between the fingers either wet or dry. Or decomposition by abrasion.

**friable amber;** a misleading term for gedanite.

**friable formation;** a rock that crumbles naturally or is easily broken into grains, or powders, hence a formation, from which compound core cannot be obtained.

**friability;** → friable.

**frictional electricity;** an electrostatic charge that develops by rubbing amber, glass, tourmaline, topaz, diamond and some plastic simulant caused by attraction of the surface atoms of the two materials rubber and rubbed become ionized. Both the rubber and rubbed that are electrically charged are known as *electrostatics*. Diamond and tourmaline are positively charged, when rubbed with cloth and the electrical sign of charged gems are measured by an *electroscope*. Also called triboelectricity. Formerly it was known as *electrification*. → Triboluminescence.

**friedelite;** a massive, cleavable, hydrated manganese silicate of formula:  $6[(\text{Mn,Fe})_8(\text{OH,Cl})_{10}(\text{Si}_6\text{O}_{15})]$ . Crystal in hexagonal system. Vitreous luster. Optics;  $\omega$ :1.654—1.664,  $\epsilon$ :1.625-1.629. Birefringence: 0.034.  $\ominus$ . SG:3.06-3.07. H:4-5. Translucent to opaque. Orange-red, red-rose, pale pink, brown. Fracture uneven. Brittle. Generally reddish luminescence under LWUV and SWUV. In some pieces yellow under LWUV and green under SWUV. Found in France, Austria, Russia, Sweden, New Jersey, USA. Very rarely cut as gem but as a suitable mineral for collectors.

**frifol;** a Mexican term for a red conglomerated rock.

**frigger;** an ornament made of glass.

**fringed girdle;** → bearded girdle.

**fringe necklace;** a term used for flattened beads of jet on one side and convex on other side.

**frit;** a glass mixture containing fluxing substance used as pastes or glazes, ceramics, porcelain or other ceramic composition. In ancient Egypt composed of a crystalline silica, a copper compound (which may be calcium carbonate, malachite, azurite, and soda or natron) was used as a turquoise imitation.

**frit, colored;** same as colored frit.

**frit maker;** another term for glaze workman.

**fritted porcelain;** a term used as a synonym for soft paste.

**fritting;** the partial melting of rock crystal or glass grains forming an imperfectly melted or fritted mass.

**frog in jet;** a jewel style of mosaic or inlay work made of jet and turquoise made by American Indians in form of a frog with turquoise eye used as a pendant, ring or amulet.

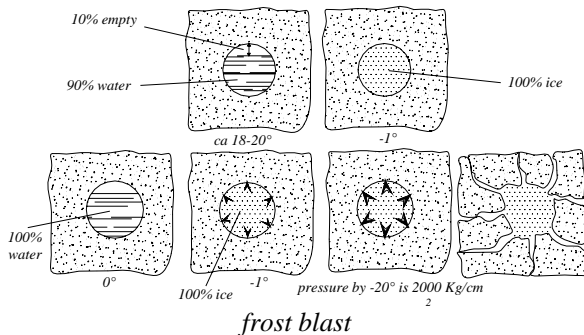
**front;** a term used by Australian miners for that side of opal, which faces upwards in contrast to behind or underside. Also called top.

**front;** in gemology same as crown.

**frost agate;** a gray agate with white markings resembling patches of snow or snowflakes. Also called frost stone.

**frost crystal;** same as rime crystal. → Frosted diamond.

**frost blasting;** a term used to mechanical disintegration, splitting, or break up of a rock because of great pressure exerted by the freezing of water (2000 kg/cm



pressure by  $-20^\circ$ ), contained in cracks or pores of rocks. Also called congelifraction, frost shattering, frost bursting.

**frost bursting;** same as frost blasting.

**frosted;** the surface of certain opaque glass made frostlike in appearance by acids or sand blasting.

**frosted crystal;** → frosted diamond.

**frosted crystal diamond;** → frosted diamond.

**frosted diamond;** those translucent diamond crystals, which have a dull surface. Also called frosted crystal diamond, frost crystal, frosted crystal, eroded crystal.

**frosted girdle;** the girdle of an unpolished, uncut, or bruted diamond appeared frosty.

**frosted quartz;** a frosty appearance of quartz due to several growth hillocks on a face. Also called cobbled quartz.

**frost glass;** thin glass that has been matted or crushed for use as a decorative material.

**frost shattering;** same as frost blasting.

**frost stone;** a local commercial name for agate contains white inclusions of opal found near Barstow, California, USA. Same as frost agate.

**froth;** a term applied to light foam.

**frothy amber;** another term for soft, opaque, chalky white foamy amber, which take no polish. Also called foamy amber. Are used in inlay works.

**frothy glass;** same as foam glass.

**frozen beryl;** when heated beryl plunged into cold water became fractures parallel to the prism face and parallel to the basal plane. Similar fracture can be seen in beryl crystal in pegmatites.

**fruit;** an informal term used by Australian miners for kernel of opal in a nobby, which is covered by rough stone.

**fruit flesh jade;** a term used by the Chinese to describe the particular color grade of jade.

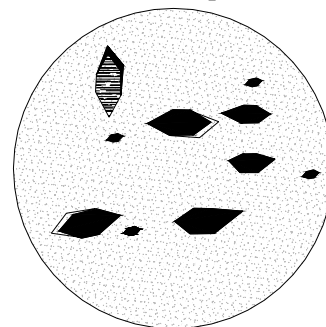
**FTC;** an acronym for Federal Trade Commission in the USA.

**fu axe;** a Chinese term for axe with flat, wide blade a sign for wealthy.

**fuchsite;** a bright-green to emerald-green chromium-rich variety of muscovite with up to 6%  $\text{Cr}_2\text{O}_3$ . Monoclinic crystal. Luster: vitreous to metallic. SG:2.77-2.88. H:2-2.5. Cleavage {001} perfect. Large and small scaly aggregate. Also called chrome mica or fuchsite mica.

**fuchsite mica;** → fuchsite.

**fuchsite scales in aquamarine;** fuchsite scales as



*fuchsite  
scales in  
aquamarine*

inclusions are in aquamarine.

**fuggerites;** same as gehlenite.

**fuh yu;** a Chinese term for abalone shell and pearl.

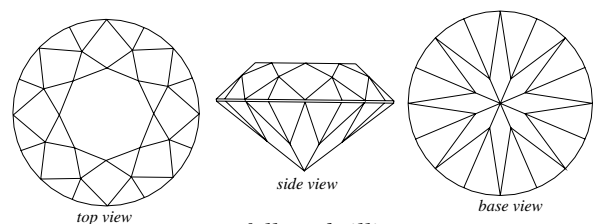
**fu-I;** a Chinese term used for bat with the symbol of happiness. → Chinese ritual and symbol jades.

**fukien jade;** a misleading term for brown soapstone.

**fulgurites;** an irregular, glassy, often tubular or rod-like structure of fused silica formed in the desert (or crust produced) by intense heat of a lightning strike. Found especially on exposed mountain tops or in dune areas or lake shores, which may measure 40 cm in length and 5-6 cm in diameter. Also called lightning tubes, lightning stone, sand tube, fused sand glass, fulgurite glass.

**fulgurite glass;** → fulgurites.

**full-color;** a term used by Australian miners for a good





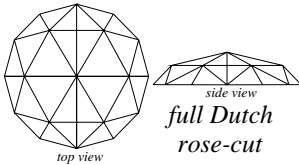
color of opal clearly to seen without viewing from special sides or angled.

**full crystal;** a misleading term for English crystal.

**full cut;** → full cut brilliant.

**full cut brilliant;** a round brilliant-cut diamond or other colored gemstone with a total of 58 facets including the table and culet. Consisting of 32 facets above the girdle, and 24 facets below the girdle or at pavilion. On the colored gemstones, the girdle is usually polished, but seldom on diamonds. The term used as a synonym for *mêlée*. Also called full cut. → Triple cut brilliant.

**full-Dutch rose cut;** a rarely used rose cut, which has a rounded girdle and flat un-faceted base. The crown is pointed, vault-shaped with 24 triangular facets. Also called full-Holland rose cut, Dutch rose cut.



**fuller's earth;** a very fine-grained aluminum-poor montmorillonite and palygorskite clay. It is used for degreasing wool and for clarifying oil.

**full gauge;** fashioned diamond that has the proportion of the Tolokowsky theoretical brilliant cut.

**full-Holland rose cut;** same as full-Dutch rose cut, or Dutch rose cut.

**full lead;** → crystal glass.

**full lead crystal;** → lead glass.

**full-red gold;** gold containing high percents of copper.

**fumarole;** a small vent or hot volcanic spring, from which crystal material, vapors or gas is released.

**fundamental;** the oldest known rock.

**fundamental colors;** same as primary colors.

**fundamental form;** same as unit form.

**fundamental particle;** same as elementary particle.

**fundamental series;** series of optical spectrum lines seen in the spectral analyzing of alkali metals.

**fundos;** a term applied in Brazilian for extremely imperfect or broken diamonds, they are mixed with second quality carbonados.

**funnel pipe;** same as volcanic vent.

**furniture men;** who worked alone in carving or in engraving and may in inlay. Also called cameo men.

**furong;** a Chinese term for carved lotus made of jade.

**furrow;** same as foss. → Kerf.

**furrowed;** having scratches, grooves or striations. → Foss, kerf.

**fuse;** same as melt. Generally different materials mix together on fusion.

**fused alumina;** same as aluminum oxide.

**fused basalt;** same as molten basalt.

**fused beryl;** → beryl glass.

**fused emerald;** → beryl glass.

**fused magma;** same as molten magma.

**fused rock;** same as molten rock.

**fused quartz;** a transparent, amorphous, fused silica glass (SiO<sub>2</sub>). RI:1.45. SG:2.21. Also called fusible quartz, quartz glass.

**fused sand glass;** → fulgurite.

**fused silica;** → vitreous silica.

**fused stone;** any material that is fused to an amorphous mass, used as a gem imitation.

**fused stone;** same as soldered emerald or assembled stones.

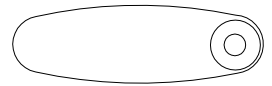
**fushanishi;** a Chinese term for vesuvianite used as jade.

**fusible;** capable of being fused or melted by the blowpipe flame.

**fusible porcelain;** synonym for cryolite glass.

**fusible quartz;** same as fused quartz.

**fusiform bead;** an elongated, toward each end tapered and spindle-shaped bead, mostly made of jet.



**fusing point;** melting point.

**fusion;** the act or process of liquefying. A union by melting. Converting of a solid into the liquid state by employing pressure or heat or both. The reverse of freezing.

**fusion point;** melting point.

**fustafi;** a corrupt Persian term for pistachio used in Arabic for emerald in which green color is mixed with black.

**futuran;** a commercial term for synthetic phenol aldehyde resin plastic. Used as an amber imitation.

**Fuxian Pipe 50;** location of a kimberlite diamond pipe in Fuxian District of Liaoning Province, China.

**fuzzy edge;** some circular zones of glassy, slightly diffuse and sharp edged fracture can be seen in heat treated sapphire from Sri Lanka, which occur due to high-temperature color changing and surrounded negative or solid crystals.

**fuzzy girdle;** same as bearded girdle.

**fuzziness;** same as bearded girdle.

# G g

**G**; a pair of Fraunhofer lines in the deep blue of the solar spectrum, one of the wavelengths is measured at 430.80 nm, and is caused by iron, and the other of wavelength at 430.79 nm, is caused by calcium.

**Ga**; a chemical symbol for the element gallium.

**GA**; an acronym for the Gemmological Association of Great Britain.

**GAA**; an acronym for the Gemmological Association of Australia.

**GAAJ**; an acronym for the Gemmological Association of All Japan.

**GAAJ refractometer**; a semi-acronym for a refractometer made in Japan, which is similar to a Rayner-refractometer.

**gabbro**; a coarse-grained, dark-green to black basic



*gabbro*

intrusive igneous rock consisting essentially of plagioclase, near labradorite, and clinopyroxene, with or without olivine, low in silicate (45-55%) but rich in magnesium.

**gabbro**; a term for a rock clan, which includes also norite, troctolite, kentalinite, eucrite, etc.

**gabbro**; any coarse-grained, dark-colored, igneous rock.

**gabbroid**; the texture of a typical basic plutonic rock similar to that of gabbro.

**gabbro syenite**; another term for orthoclase gabbro.

**Gablonz jewelry**; a term for a variety of inexpensive imitation jewels made from glass in Gablonz, the Czech Republic. Also called Providence jewelry.

**Gabon**; location of an alluvial diamond deposit of Gabon in West Equatorial Africa.

**Gaby Delys Diamond**; a yellow, pear-shaped diamond of 28.25 cts, that was presented to actress Gab Delys by an Indian maharajah. Present owner unknown.

**Gachala Emerald**; a single terminated emerald prism of 858 cts, from Gachala mine, Chivor area, Colombia.

It was presented from Harry Winston to National Museum of Natural History in Washington, D.C., USA. Also called Harry Winston Emerald.

**Gachala emerald**; those Chivor-like emeralds from the Gachala mine, Chivor area, Colombia.

**gad**; a short, pointed mining chisel used to break up rock.

**gadding**; in mining quarry, the drilling for taking out dimension stone.

**gadolinite**; a rare mineral formulation:  $2[(Y,Ce,La,Nd)_2Fe^{2+}Be_2Si_2O_{10}]$ . Monoclinic crystal. Vitreous to greasy luster. Black, brown, greenish-black, green. Streak: greenish. Transparent to translucent. Conchoidal fracture. Brittle. Optics;  $\alpha$ :1.77-1.78,  $\gamma$ :1.78-1.81. Birefringence: 0.01-0.04.  $\oplus$ . Dispersion: 0.014. SG:4.00-4.47. H:6½-7. Found in USA, Sweden, Russia, Japan, Norway, Greenland, Switzerland, and Australia. Used as a source of rare earth and cut cabochon.

**gadolinium**; a silvery-white metallic element of rare-earth group of the Periodic System with the symbol Gd.

**gadolinium gallium garnet, synthetic**; → synthetic gadolinium gallium garnet.

**gaelic**; an old Irish term for jet.

**gagat**; a German term for gem quality jet.

**gagatite**; a jetlike coalified woody material.

**gahnite**; a mineral of spinel group, often containing some magnesium. Cut as gems and is a suitable mineral for collectors. Synonym for zinc spinel. Synthetic gahnite has been produced.

System: cubic.

Formula:  $8[ZnAl_2O_4]$ .

Luster: vitreous to greasy.

Colors: greenish, deep green, blue, reddish-violet, yellowish, and brown.

Streak: grayish.

Diaphaneity: translucent to opaque.

Cleavage: {111} indistinct.

Fracture: conchoidal to uneven. Brittle.

SG: 4.00-4.607.

H: 7½-8.

RI: 1.794-1.805.

Found in Sri Lanka, India, Brazil, New Jersey (USA), Malagasy, Finland, Sweden, Italy, and Australia.

**gahnite**; misnomered as idocrase, vesuvianite.

**gahnospinel**; a blue green, dark blue or violet variety of spinel containing a high proportion of zinc,  $8[(Mg,Zn)Al_2O_4]$ . RI:1.725-1.753. SG:3.58-4.06. Found in Sri Lanka (Ceylon). Used as a gemstone. Also called spinel zinciferous, zinc-rich spinel.

**gaicone**; a corrupt term of Farsi term zargoan for zircon.

**gailushi**; a Chinese term for grossularite used as jade.

**gaing**; an old Irish term for jet.

**gair**; a Burmese term used for opaque, large and impure

corundum stones. → Corundum classification in Myanmar.

**galactite**; same as novaculite.

**galactite**; described by Pliny as emerald surrounded with white. Also spelled as galactitis.

**galactitis**; same as galactite

**galalith**; a commercial term for a casein plastic apart from cellulose. RI:1.55. SG:1.325-1.45. H:2-2½. Used as an amber, jet, ivory, and tortoise shell imitation. Also spelled galanith and called milkstone. → Casein.

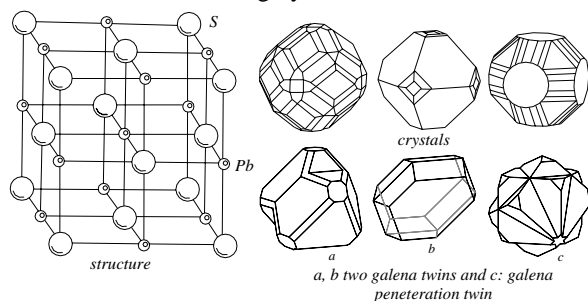
**galanith**; same as galalith.

**galatom**; a commercial term for diatomaceous earth.

**galaxite**; a rarely bright reddish-brown to black mineral of the spinel group. Formula:  $8[(\text{Mn}^{+2}, \text{Fe}^{+2}, \text{Mg})(\text{Al}, \text{Fe}^{+3})_2\text{O}_4]$  containing considerable ferrous oxide. Cubic system. Massive, coarse or granular aggregate. Black streak. RI:1.923. SG:4.03-4.07. H:7½-8.

**galena**; same as galenite.

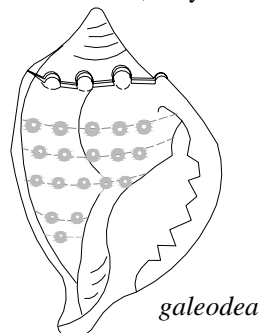
**galenite**; a  $4[\text{PbS}]$ , lead-gray to reddish, cubic mineral. Metallic luster. Streak: gray-back. SG:7.2-7.6. H:2.5-3.



*galenite crystals structure, crystals and twins*

Cleavage  $\{001\}$  perfect. Found in some stones as inclusions. Prized by collectors. Also called galena, lead glance, lead sulfuret, sulfuret of lead.

**Galeodea**; actually galeodea echinophora linné a salt-water helmet shell which resembling a gladiator's helmet of the Mediterranean, only 10 cm in size. It has



sports spiral rows of small knobs with horny operculum. Living on sandy bottoms. Also called prickly helmet.

**galeodea echinophora**; → galeodea.

**galliant**; a commercial term for synthetic gadolinium gallium garnet (GGG). Often used as a diamond

imitation.

**galliard**; a hard, smooth, close-grained sandstone. Also called calliard.

**gallium**; a rare, silvery-gray, metallic element with the symbol Ga.

**gallium aluminum garnet**; a synthetic substance with the chemical formula:  $\text{Ga}_3\text{Al}_5\text{O}_{15}$ , Used as a gem imitation. No counterpart exists in nature. Abbreviation: GAG.

**gallium tourmaline**; a synthetic tourmaline contain gallium which is known as a synthetic stone.

**galmei**; same as hemimorphite.

**galvanizing**; coating of metals with zinc, generally by immersion in a bath of zinc, which resists corrosion.

**galvanoluminescence**; emitting of light from the anode can be seen in some electrolytic cells such as aluminum or tantalum when immersed in suitable electrolytic current.

**$\gamma$ -chrysotile**; a term for basic variety of chrysotile.

**gamal**; same as gamma alumina used in metallographic polishing and in Verneuil flame-fusion method. Also called gamma alumina.

**gamma cell testing**; same as prescreening method, irradiation.

**Gamanose shell**; a variety of shells found in the river Yangtze, China, from which beads for cultured pearls are produced.

**Gambia shell**; a green nacre variety of large pearl-oyster from Gambia, Tahiti, and Auckland, and around the islands of the southern Pacific Ocean.

**Gambier pearl**; pearl from Gambia, South Pacific Ocean has a chalky white appearance.

**gamella**; a term employed to a wooden bowl used in Brazil to wash gold.

**gamma alumina**; a cubic modification of aluminum oxide used in Verneuil flame-fusion method. Also called gamal.

**gamma crystal**; the largest index of refraction in a biaxial crystal or the angle between the  $a$  and  $b$  axes.

**gamma decay**; the emitting of gamma rays hence transformation of an atomic nucleus during radioactive decay, without a change in the atomic number. Also called gamma emission. → Gamma radiation.

**gamma emission**; → gamma decay.

**gamma index**; the highest index in an optically biaxial crystal is called gamma ( $\gamma$ ), and the lowest index is called alpha ( $\alpha$ ).

**gamma mineral**; a polymorphous modification of a mineral that is stable at a higher temperature than  $\alpha$  and  $\beta$  modifications, such as  $\gamma$ -quartz.

**gamma radiation**; high-frequency, short-wavelength penetrating electromagnetic radiation emitted from an atomic nucleus corresponding to X-ray and visible

light. Also called gamma ray. → Gamma decay.

**gamma ray**; same as gamma radiation.

**gamma ray spectrometer**; an instrument for measuring the energy distribution of gamma rays or spectrum of gamma rays.

**gamma ray spectroscopy**; the observation of a gamma-ray spectrum using a gamma spectrometer.

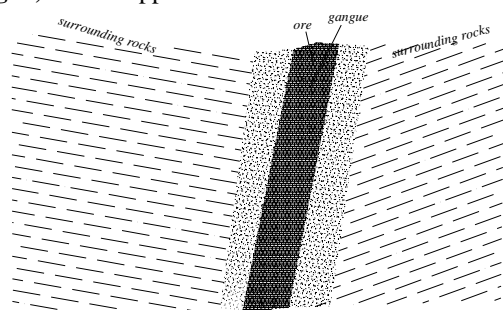
**gamma ray treatment**; the artificial color change of diamond or gemstones by the bombardment with gamma rays. Diamond changes color to blue or bluish green. Green irradiated diamond turns color often to yellow or cinnamon brown this process takes some hours at about 500-900 C.

**gamma zircon**; an obsolete term in mineralogy for lower properties than high (alpha) and low (beta) zircon, which is amorphous or nearly so. RI:1.78-1.85. SG:3.9-4.1. Also called intermediate zircon. Sometimes used as gem. → Low zircon.

**ganglia**; → nervous system of oyster.

**ganglion cell**; a group of nerve cell bodies composed with structure, usually located outside the brain and spinal cord or central nerve system, which formed the optic nerve. → Eye.

**gangue**; a term applied to a valueless non-metalliferous



gangue with metallic ore insurrounding rocks

ore mineral associated with ores in a vein such as apatite or fluorite as gangue minerals.

**gangue mineral**; a worthless metallic mineral (non-metallic) associated with other ores.

**ganister**; a fine, hard quartzose sandstone used to make cladding bricks to line certain furnaces.

**gánjha**; an Indian term for emerald of less clarity due to inclusions.

**Ganspan**; location of a small alluvial diamond mine in Schweizer Reneke, Transvaal Province, South Africa.

**gaping**; in cultural pearl farming, when the valves are gaping this indicates that the oyster is healthy and vigorous enough to withstand the operation of inserting the nucleus.

**Garalàri**; a Sanskrit term meaning anti-poison. Also spelled garalàrih.

**garalàrih**; another spelling of garalàri.

**garamantica**; „gara“ is a Turkish word for black, and mantic a Greek term for art science of divination, also

black magic. A term used by magician for green colored stones similar to emerald with a cross white line. Probably the word is derived from the ancient Hamitic tribe of eastern Sahara from Roman Times?

**Garamantic**; a term mentioned by Theophrastus for a variety of carbuncle garnet, which were the Carthaginian carbuncle gem. Also known as Garamantic carbuncle.

**Garamantic carbuncles**; allegedly location of garnet in ancient Carthaginian mined in the mountains of the Nasamones. → Garamantic.

**garden**; inclusions in gems appear as a mossy garden, which are produced by combinations of the three inclusions, typical of fine Colombian emerald. Also called jardin.

**gargun**; an undesired German term for pale-yellow zircon from Sri Lanka. Drived from the Persian or Farsi term zargoon for zircon.

**Garimpeiro**; unlicensed individual miner or prospector in Brazil, working singly or in minor team.

**garland**; a headband made of gold, silver, gemstone such as diamond, ruby, sapphire, emerald, etc., or made of flowers or costly materials.

**garland**; a coronet worn as a mark of representation such as royal crown.

**garlic**; → odor varieties.

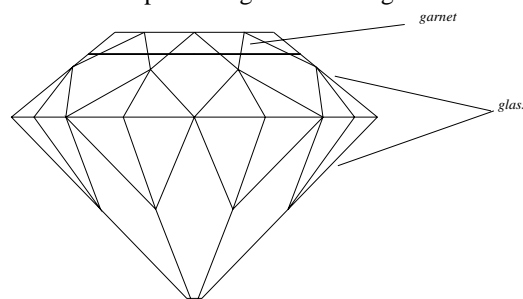
**garnet**; → garnets.

**garnet blende**; another term for sphalerite.

**garnet cut**; once cut en cabochon (when carbuncle) but today cut faceted as step cut, mixed cut, etc. and as slide for inlaid articles.

**garnet, demantoid**; → demantoid.

**garnet doublet**; a common composite stone, made of a thin crown or top of red garnet and a glass base. Also



garnet-glass doublet

called garnet-topped doublet, garnet-glass doublet.

**garnet, formation of**; that means occurrences of garnets during the metamorphism of rocks and commonly in schists.

**garnet forms**; change garnet doublet.

**garnet-glass doublet**; same as garnet doublet.

**garnet, grossular**; → grossular.

**garnet, hessonite**; → hessonite.

**garnet, hydrogrossular**; → hydrogrossular.

**garnet, inclusions;** inclusions in garnets are in the form of silk, rounded stubby, horsetail, three-phase inclusions, sometimes hematite plate and elongated actinolite may be seen.

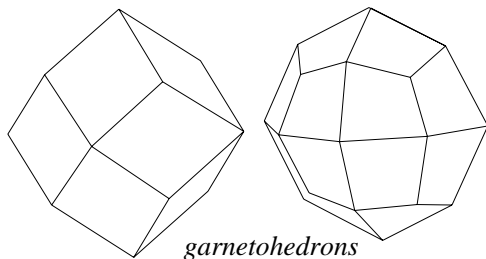
**garnetiferous;** containing, producing garnets.

**garnetite;** a contact metamorphic rock consisting chiefly of garnet grains.

**garnetization;** replacement by or introduction of garnet in association with contact metamorphism.

**garnet jade;** a misleading term for jadelike variety of massive green grossularite from Transvaal, South Africa. Also called Transvaal jade.

**garnetohedrons;** crystal forms of deltoic-icosi-



*garnetohedrons*

tetrahedron and trapezohedron that can be seen in garnet family.

**garnetoid;** group of minerals, which has a structure similar to garnet and are not primarily silicates. Group included hydrogarnet, plazolite, berzeliite, griphite, and hibschite.

**garnet paper;** a type of sandpaper having powdered garnet as abrasive coating material.

**garnet peridotite shell;** → mantle of the earth.

**garnet, pyrope;** same as pyrope.

**garnet, pyrope/spessartite;** same as pyrope/spessartine.

**garnet pyroxene;** a coarse-grained garnet and clinopyroxene rock with or without olivine or phlogopite. Found as xenoliths in Kimberlite pipes and dikes in Griqualand, South West Africa. Also called griquaite.

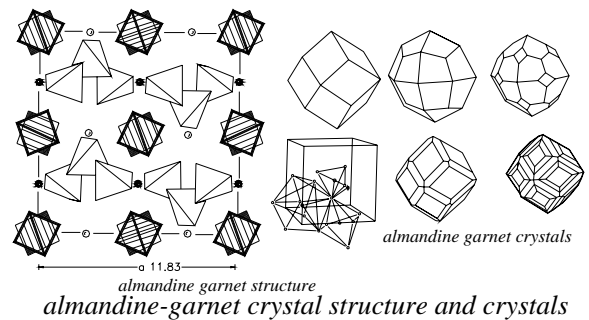
**garnet pyroxenite;** same as griquaite.

**garnet, rhodolite;** same as rhodolite.

**garnet rock;** a metamorphic rock composed mainly of garnet.

**garnets;** an isomorphous group of minerals with general formula  $8[A_3B_2(SiO_4)_3]$ , where  $A = Ca, Mn^{+2}, Mg, Fe^{+2}$ , and  $B = Al, Fe^{+3}, Mn^{+3}, Ti, Cr^{+3}, Ti, V^{+3}$ , and Zr. Cubic system. Mainly dodecahedral or tetragonal trioctahedral crystals. Vitreous to resinous luster. No cleavage. Conchoidal to uneven fracture. Brittle to tough. Garnets are divided in 2 groups; *ugrandite* an isomorphous intermediate group of uvarovite-grossularite-andradite and *pyralspite* an isomorphous intermediate group of pyrope-almandine-spessartine. Some garnets show anomalous double refraction

between crossed polarizing microscopes due to stress. Granular, massive, lamellar, compact, disseminated crystal or sand.  $N=1.73-1.89$ . Dispersion:  $0.020-0.028$ . SG:  $3.15-4.30$ . H:  $6\frac{1}{2}-7\frac{1}{2}$ . Species or varieties of garnet



are: almandine, andradite (demantoid, melanite, topazolite), grossular (hessonite, rosolite, hydrogrossular, African jade), pyrope (rhodolite, malaya), spessartite, uvarovite, henritermierite, kimzeyite, yamatoite, majorite, knorringite, and schorlomite. Any garnet is a *birthstone* for January. Also local misnomered as *Cape ruby* and *Bohemian ruby*. Cut in various styles and sizes and fashioned as jewelry as *roses*, when cut in dome-shape is named *carbuncle*. Synthetic garnet is a misleading term for a kind of colorless or in various colored synthetic stone, which has no counterpart in nature but a similar structure to garnet such as YAG, etc. Also spelled grenate, garnet. → Synthetic ruby, garnet species and varieties.

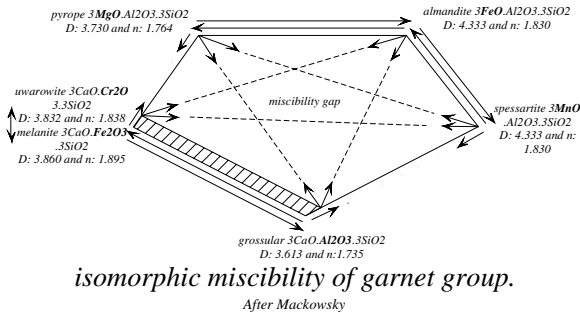
table 6: chemical and physical properties of important garnets

mineral	composition	SG	hardness
pyrope	$Mg_3Al_2(SiO_4)_3$	3.70-3.90	7-7.5
almandine	$Fe_3Al_2(SiO_4)_3$	3.95-4.20	7.5
spessartine	$Mn_3Al_2(SiO_4)_3$	4.12-4.20	7-7.5
grossular	$Ca_3Al_2(SiO_4)_3$	3.60-3.68	7-7.5
anderadite	$Ca_3Fe_2(SiO_4)_3$	3.81-3.87	7-6.5
uvarovite	$Fe_3Cr_2(SiO_4)_3$	3.51-3.77	7.5
hessonite	$Ca_3Al_2(SiO_4)_3$	2.60-3.68	7-7.5
demantoid	$Ca_3Fe_2(SiO_4)_3$	3.81-3.87	7-6.5
melanite	$Ca_3Fe_2(SiO_4)_3$	3.81-3.87	7-6.5
goldmanite	$Ca_3V_2(SiO_4)_3$	3.74	6-7

**garnet shell;** hollow cabochon of garnet, which is hollowed out from the back to improve the color and eliminate the undesirable inclusions within the crystal. → Shell cut.

**garnet species and varieties;** varieties of garnet are: almandine, pyrope-almandine (trade name rhodolite, malaya), pyrope, spessartite-almandine, spessartite, grossular (gem varieties: hessonite, tsavorite),

andradite (gem varieties: demantoid, topazolite), uvarovite, yamatoite, khoharite, calderite, knorringite, blythite, skiagite, goldmanite, kimzeyite, ferric-

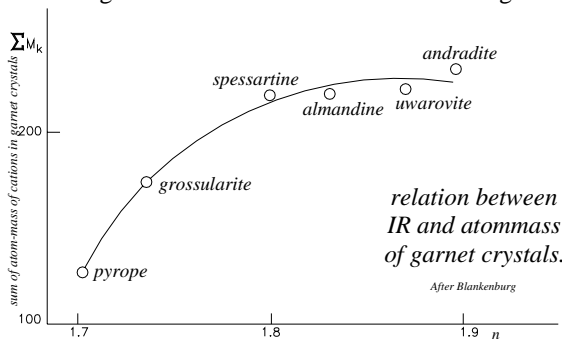


kimzeyite, hydrogrossular, hydroandradite, schorlomite, ytrogarnet (an imitation garnet which has no counterpart in nature. Also called yttrium iron garnet).

**garnet, spectra;** spectrum of garnets are: dark almandine shows very strong band in the blue-green at 505, weaker bands in green at 527 nm, and yellow at 576 nm. Pyrope shows in the yellow-green at about 575 nm.

**garnet, spessartite;** same as spessartite.

**garnets relationship of RI and atom-mass;** refractive index of garnet mineral increased with the higher of



atom mass of mineral for sample pyrope has small RI than andradite because of lesser atom mass of pyrope.

**garnet, synthetic;** a misleading term for synthetic red to dark red corundum similar to garnet.

**garnet-topped doublet;** most common and important types of doublet, in which the thin slice top part is true almandine garnet and the base is formed of various colored glass according to the particular stone represented, garnet tends to easily fuse to glass. The colored glass on the base improves the color and appearance of the stone. Used to imitate colorless stones, spinel, ruby, emerald, sapphire, topaz, amethyst, chrysolite, etc. Such stone are easily to distinguished by means of a microscope, which shows the inclusions in top and bubbles in the cementing plane, different refractive index between top and glass on the base.

Under SWUV glass may exhibit whitish to yellow fluorescence but the top part is inert. If such a doublet is immersed in oil it release the different relief between base and top, when viewed sideways. → Garnet doublet.

**garnet-type synthetic stones;** there are many non-silica synthetic stones, which have a garnet-like structures such as YAG, GAG, GGG, YIG, etc.

**garnet, uvarovite;** same as uvarovite.

**garnierite;** an alteration product of serpentine, talc, or chromite group. Sometimes a group name for poorly defined hydrous nickel-magnesium silicates. Sometimes considered to be a nickel-rich antigorite. Synonym for noumeite, genthite, and nepouite. Used as a gemstone.

System: amorphous, but it may be monoclinic.

Formula:  $(Ni,Mg)_3Si_4O_{10}(OH)_2$ .

Luster: porcelain to greasy.

Colors: emerald-green, apple-green, pale green to nearly white.

Streak: pale green-blue.

Diaphaneity: translucent to opaque.

Fracture: conchoidal to uneven. Brittle.

SG: 2.30-2.80.

H: 2-4.

RI 1.63.

Found in Carolina, and Oregon (USA), Russia, and Spain.

**garuda;** a Sanskrit term for several green gemstones similar to emerald, but also bird and vehicle of Vishnu is included. Also spelled garudmata, garutmatam, garudodgara, garudottirna, garuram.

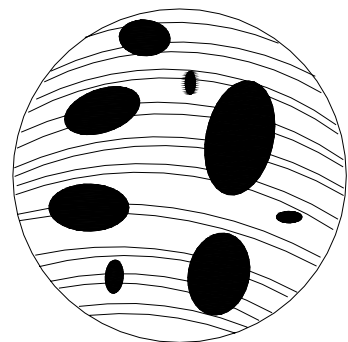
**Garry Moore Diamond;** a yellow, trisoctahedron diamond crystal found in 1960 in Diamond State Park, Arkansas, USA. Named in honor of entertainment personality Garry Moore.

**garuda;** a Sanskrit term probably for emerald. May spelled garura.

**garudmata;** a Sanskrit term probably for emerald.

**garudodgara;** a Sanskrit term probably for emerald.

**garudottirna;** a Sanskrit term probably for emerald.



a typical gas-bubbles in a synthetic ruby

**garura;** a Sanskrit term probably for emerald.

**garuram**; a Sanskrit term probably for emerald.

**garutmatam**; a Sanskrit term probably for emerald.

**gas bubbles**; spherical but sometimes elongated gas bubbles as an inclusion can be seen in paste, doublets, in flame-fusion Czochralski-pulled synthetic corundum, sapphire, and spinels. They have another form of bubbles different to natural corundum and spinel. In genuine stones inclusions are more angular cavities. Often visible to the naked eye. → Gas inclosure.

**Gascion's powder**; a white powder of amber used in cordial medicine.

**gas enclosure**; → gas inclosure.

**gas inclusion**; same as gas inclosure.

**gas inclosure**; a gas bubble inclusion within gemstone can be found in all synthetic corundums. Often visible to the naked eye. Also called gas inclusion and spelled gas enclosure.

**gash fracture**; a small-scaly tension fracture which occurs at an angle to a tends to remain open.

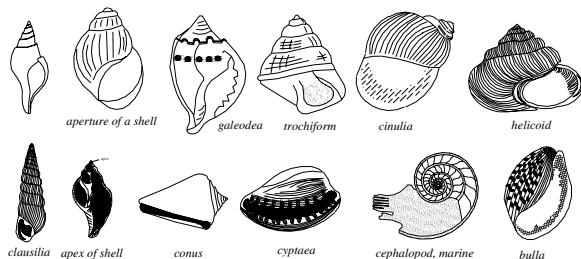
**gaspéite**; a carbonate mineral belonging to calcite group. It is prized by collectors. Chemical formula:  $6[(\text{Ni}, \text{Mg}, \text{Fe})\text{CO}_3]$ . Trigonal system. Translucent. Vitreous to dull luster. Light green to yellowish green. Yellowish green streak. Cleavage: {1001} good. Uneven fracture. Optics;  $\omega$ :1.830,  $\epsilon$ :1.610. Birefringence: 0.022.  $\ominus$ . SG:3.71. H:4½-5. Found in various colored siliceous dolomites at the peninsula of Gaspé, Canada.

**gasteropod**; → gastropoda.

**gastrolith**; a term applied to highly polished and well-rounded pebbles associated with saurian skeletons. Synonym for stomach stone.

**gastropod**; → gastropoda.

**gastropoda**; a member of univalve mollusks, slugs, conches, sea snails and abalones with a distinct head



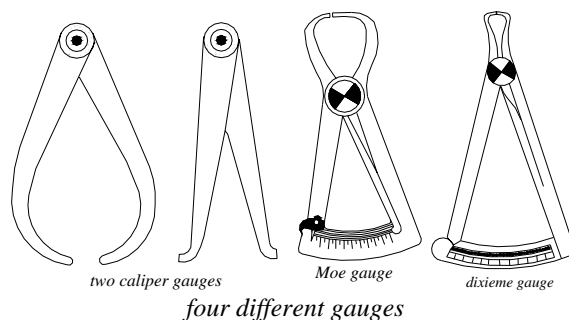
*gastropods and cephalopods*

bearing tentacles and eyes, and flattened foot. Also spelled gasteropod or gastropod. → mollusks.

**gauges**; various instruments used in the trade to help measure the weight, dimension, distance (thickness, height), capacity, properties or a devise of estimation of diamond, and pearls, and other gems. Also called indicator gauge, micrometer.

**gauge, diamond**; → diamond gauge.

**gauge for diamond and stones**; → diamond gauge.



**gauge plate**; a plate gauge consisting of a thin sheet of metal or other material estimating of weight of mounted and unmounted stones. → Diamond gauge.

**gaungsa**; a Burmese term used for yawya a pale inferior mixed corundum stone up to six cts. → Corundum classification in Myanmar.

**gava gem**; a commercial term for synthetic rutile used as a diamond imitation.

**gaw-cho**; same as gaw-done.

**gaw-done**; same as gaw-cho star sapphire stones. → Corundum classification in Myanmar.

**gawdone**; a Myanmar (Burmese) term for star sapphire.

**gaylussite**; a rare, transparent to translucent, colorless, white, to grayish-yellow mineral. Chemical formula:  $4[\text{Na}_2\text{Ca}(\text{CO}_3)_2 \cdot 5\text{H}_2\text{O}]$ . Monoclinic crystal. Vitreous luster. Fracture: conchoidal. Brittle. Cleavage: {110} perfect, and {001} indistinct. Optics;  $\alpha$ :1.445,  $\beta$ :1.515,  $\gamma$ :1.522. Birefringence: 0.077.  $\ominus$ . SG:1.995. H:2½-3. Found in USA, Kenya (Africa), and China. It is rarely fashioned. Weak creamy-white luminescence under SWUV, may be it is triboluminescent.

**Gd**; a chemical symbol for the element gadolinium.

**Ge**; a chemical symbol for the element germanium.

**Gedania**; another name for Danzig, Poland.

**gedanite**; a brittle, pale-yellow variety of amber found in Gdansk, Poland, near Baltic Sea. A fossil resin of an extinct pine species with the name *Pinites stroboides* that contains no or little succinite acid. RI:1.50. SG:1.06-1.07. H:1½-2. Sometimes used as gem and beads. Frequently called unripe amber. Misleadingly called friable amber, mellow amber. The name gedanite comes from old name of Danzig, Gedania.

**Gdansk**; old name of Danzig, Poland.

**ge**; a Chinese term for carved dagger made of jade.

**geeser**; an erroneously term used by Australian miners for geysir.

**geat**; an old term for jet.

**geate**; an old term for jet.

**gegat**; another term for jet.

**G.E. synthetic diamond**; a semi-acronym for General

Electric synthetic diamond. Also called as Gegem.

**Gegem;** synthetic diamond made by General Electric Research and Development Center in 1970.

**gehlenite;** a mineral of mellilite group isomorphous with akermanite with chemical formula of  $(Al,Mg)(Al,Si)SiO_7$ . Also called fuggerite, stilboite, stylboite.

**Geiger counter;** an instrument for detecting and counting ionizing radiation (essentially gamma ray or other ionizing particles) given off by radioactive substances. It consists of a discharge gas-field chamber, which responds to the ionization produced by the rays. Used to detect radioactivity in minerals such as ekanite, zircons, and rock formations. Also called Geiger-Müller counter.

**Geiger-Müller counter;** same as Geiger counter.

**Geissler tubes;** a rare-gas field chamber made of fluorescent glass used for showing the luminescent effect of an electrical discharge.

**geizer;** an erroneously term used by Australian miners for geyser.

**gel;** an often colorless, colloidal suspension of a liquid in a solid or semi-solid or jellylike. Also called or spelled, jell, jells, jel, gels, jelling, gelling, gelled.

**gel;** a term used by Australian miners to a form of opal is believed that colloid form of opal filled cracks, space, etc., and eventually hardened.

**gelatin;** a colorless, odorless, tasteless, transparent to translucent, hard, brittle, colloidal substance obtained from animal skin, tissues, hoof, and horns in form of flakes or powder.

**gelatin;** formation of a gel from sol due to coagulation or by precipitation with an electrolyte.

**gelatin;** turning from a fluid to a solid state.

**gelivity;** a term used for property of a rock being readily split by frost.

**gel mineral;** a mineraloid or colloid mineral which occurring naturally from inorganic material that is amorphous, therefore not considered to be a mineral.

**gem;** generally a fine-quality or superlative, rarity and durability specimen usable in gem industry to make jewels or ornaments. The chemical makeup of such specimens can be of inorganic or organic origin.

**gem;** a fashioned stone, which possesses quality, beauty and durability for in jewelry, such as diamond, pearl, etc.

**gem;** sometimes it means a fine specimen such as *gem diamond*.

**gem;** as an adjective prefix: *gem crystal* or *gem quality*.

**gem;** the term *gem* applied to any gemstone of quality, but exclusive of glass and synthetic gemstones. → Gemstone.

**gem;** a term used by Australian miners and dealers for fine-quality or superlative opal usable in gem industry

to make jewels or ornaments.

**gem analyzer;** a promotion term for an infra-red reflectivity meter, which is powered by a voltage stabilizer.

**Gem and Mineral;** a monthly periodic published in Mentone, California, P.O. Box 687.

**Gem and Mineral Society of Zimbabwe;** Headquarters for this society are located at: P.O. Box 712, Harare, Zimbabwe (former Rhodesia).

**gemast;** a Farsi (Persian) term for amethyst.

**gem collections;** → museum gem collections.

**gem collector;** a person who (or thing) collects any fine specimen of mineral or gems as a hobby or because of scientific interest or for museum.

**gem color;** a trade term used for colorless diamond and nearly synonymous with *perfect color* or *good color*.

**gem crystal;** a promotion applied to the crystal form, in which a gem can be cut.

**gem-cut diamond;** an export definition term used in the USA for diamonds, which are cut as a gem.

**gem cutter;** person who employed in the cutting, and polishing of gemstones.

**gem detector;** another term for an inexpensive binocular microscope mounted on a dark-filled illuminator. → Gemolite, or diamondscope.

**GEMDATA;** a computer data bank used to identify gemstone constants developed by Peter Read, England.

**gem diamonds;** rough diamonds suitable for gem use with relationship to color, quality, and shape.

**gem diamonds;** the sorting of gem diamond depends upon on size (cts. weight), color, shape, and purity, which are suitable for use in jewelry.

**gem diamonds artificial color;** → diamond artificial coloration, artificial treatment of gemstones.

**gem diamonds fraudulent color;** a style of coated diamond, which improves the diamond color, it is detected by boiling the unmounted stone in concentrated sulfuric acid, which removes the coating layer and revealed its true color. This method may be practiced by rough diamonds. → Fraudulent coloration of rough diamonds.

**gem diamonds sorting;** → diamond sorting.

**gem diamonds synthetic;** → diamond,-synthesis of.

**gemelo;** another Colombian-Spanish term for trapiche emerald, which consist of segmented emerald crystals.

**generalad;** a commercial term for Lechleitner or coated emerald or for a beryl composite (doublet).

**gemeter;** a promotion term for a reflectivity meter.

**gemette;** a promotion term for man-made sapphire.

**gem gravels;** a gem-bearing gravel or placer containing amounts of gem minerals that were formed from pre-existing rocks found in river or lake beds associated with other minerals such as garnets, sapphires, rubies,



etc. Also called alluvial gravel.

**geminair**; a commercial term for colorless or colored synthetic yttrium aluminum garnet (YAG) used as a diamond imitation.

**gemmaite**; an undesirable trade term for synthetic yttrium aluminum garnet (YAG). Used as an imitation diamond.

**geminate crystal**; another term for twin, or twinning.

**Gem Instruments**; → GIA Gem Instruments.

**gem jade**; same as emerald jade.

**Gemma divi Iacobi**; another term for jacobian quartz.

**gemma sapphires**; a synthetic sapphire from Freyung, Bavaria, Germany used as cabochon with less sharp stars than the Linde sapphire. Also called Star of Freyung or gemma star.

**gemma star**; a commercial term for synthetic sapphire from Germany. → Gemma sapphires.

**Gemmastar**; a commercial term for a horizontal microscope with a vertically positioned stone holder made by Eickhorst, Germany.

**gemmary**; means the science of gems.

**gemmary**; a collection- or museum of gems.

**gemmary**; person who engraved the gems.

**gem material**; the term applied to any rough minerals or substances, either natural or artificial, which can be fashioned into a jewel. It includes any organic origin substances such as coral, amber, pearls, ivory, jet, etc. → Gem mineral, gemstone.

**gem mineral**; any rough minerals, which can be fashioned into a jewel. Also called rough gem. It excludes any organic origin substances such as coral, amber, pearls, ivory, jet, etc. → Gem material, precious stones, gemstone.

**gemmiferous**; bearing- or containing gems.

**gemmiferous**; producing gems.

**Gemmological Association of All Japan**; Headquarters for this society are located at: Tokyo, Biho-Kaikan, 1-24 Akashi-cho, Japan. Abbreviation: GAAJ.

**Gemmological Association of Australia**; Headquarters for this society are located at: P.O. Box 5133AA, Melbourne 3001, Victoria, Australia. Abbreviation: FGAA.

**Gemmological Association of Great Britain**; Headquarters for this society are located at: Saint, Dunstan's House, 2, Carey Lane, London, EC2V, 8 AB, England. Abbreviation: FGA.

**Gemmological Association of Hong Kong**; Headquarters for this society are located at: University of Hong Kong, Department of Physics, Hong Kong.

**Gemmological Association of Korea**; Headquarters for this society are located at: No. 244-39 Hoo Am-dong, Yong San Ku, Seoul, Korea.

**Gemmological Association of Switzerland**;

Headquarters for this society are located at: Multergasse 20, CH-90000, St. Gallen, Switzerland.

**Gemmological Institute of India**; Headquarters for this society are located at: 29-30 Gurukul Chambers, 187-9 Mumbaderi Road, Bombay 2, India.

**Gemmological Institute of Korea**; Headquarters for this society are located at: 30-7, 3-ka, Namaemunro, Chungku, Seoul, Korea.

**Gemmological Institute, International**; Headquarters: Schupstraat 1/7 - 2018 Antwerp, Belgium. For North and South America: IGI, 579 Fifth Avenue, New York N.Y. 10017, USA. Abbreviation: IGI.

**gemmological Instrument Ltd.**; a Department of the Gemmological Association of Great Britain. Headquarters of society: → Gemmological Association of Great Britain.

**gemmological polariscope**; → polariscope.

**Gemmological Society of Japan**; Headquarters for this society are located at: Institute of Mineralogy, Petrology and Economic Geology, Tohoku University, Aoba, Sendai, Japan 980.

**Gemmological Society of South Africa**; → Federation of South African Gem & Mineralogical Societies.

**gemmologist**; → gemologist.

**Gemmologist' Association of Sri Lanka**; Headquarters for this society are located at: 63 Bristol Buildings, York St. Colombo 1, Sri Lanka.

**gemmology**; → gemology.

**gemmy**; like a gem or having the characteristics desired in a gem.

**gemmy**; a gemmy and richly green-colored mineral, such as emerald spodumene (hiddenite), emerald jade (jadeite), and emerald malachite (diopside).

**gemmy**; an informal term used by Australian miners for an opal deposit of better quality.

**Gem of Lithuania**; a term used for artifact articles made of amber from Lithuania.

**Gem of the Jungle Sapphire**; a colossal deep cornflower-blue sapphire of 958 cts, found in 1929 on the surface of the earth just below the grass, in Myanmar, (Burma). The purchaser Albert Ramsay cut it into nine gems weighing 66.5 to 4.33 cts.,

**GemoLite**; a commercial term for a binocular microscope with zoom magnification manufactured by Gemological Institute of America (GIA), used for observing imperfections and internal features of diamonds and other gems. In this microscope gemstones can be viewed in both, incident and transmitted light, as well as with dark-filled and light-filled illumination. Also known as gemolite microscope. → Diamondsopce.

**gem opal**; same as precious opal.

**gem orchid**; a fine opal from Australia known as the

Gem Orchid was obtained by J. Pierpont Morgan, USA.

**gem peg;** same as jamb peg.

**gem placer;** → placer.

**gem quality;** any rough minerals or materials, which possess the qualification of a gemstone.

**gem quality;** frequently used to describe fine diamond.

**gem quality tourmaline;** a term applied to transparent in nearly all distinguish color hues and lustrous.

**gem refractometer;** → refractometer.

**gem saws;** a cold-rolled metal saw to keep the blade cool during cutting, so they don't warp or overheat the gems.

**Gem Society of Ceylon;** Headquarters for this society are located at: Melbourne Estate, Tummodera, Colombo, Sri Lanka.

**gem species;** gem-bearing minerals. Also called gem variety. → Gem quality.

**gem stick;** a wooden holder, on which a stone is with a special cement mounted, while cutting its facets.

**Gem Testing Laboratory;** → gemological laboratory.

**Gem Trade Laboratory, Gemological Institute of America;** the two research and testing laboratories for identification of diamonds, gemstones, and pearls (natural, cultured pearls and imitations), grading for the jewelry industry. A subsidiary of GIA in New York City, USA.

**Gem Testing Laboratory of Great Britain;** a gem testing laboratory in Great Britain.

**gem variety;** same as gem species. The variety of a mineral species, which possess the qualification of a gemstone. Also called gemstone variety.

**gemolite microscope;** → GemoLite.

**Gemological Institute of America;** a non-profit institution. World Headquarters for this society are located at: 5355 Armada Drive, Carlsbad, California 92008. USA. Used the suffix GIA.

**Gemological Institute of America Color-Grading System;** → GIA color-grading system.

**gemological microscope;** → microscope.

**gemological polariscope;** → polariscope.

**gemologist;** one who has qualified as a specialist in the identification, grading, etc. of gemstones. Also spelled gemmologist.

**gemologist diploma;** one who has qualified specially in the study, identification, and grading of gemstones and successfully completed recognized courses by a gemological institute.

**gemology;** the science, classification, and historical study, of all natural and artificial gem materials. Gemology is concerned with investigating and establishing facts about gems. English spelling is gemmology.

**gemolux;** an instrument constructed in Switzerland

incorporating a lighting device used for examination of stones in dark-filled and light-filled illumination.

**gemoscope;** same as binocular microscope used for examination of stones in dark-filled and light-filled illumination constructed in Switzerland for jewelers.

**Gemprint;** a commercial term for an instrument designed and manufactured in Israel. It uses a laser beam of light to produce a polaroid photograph of the reflection of the polished facets and surface of diamond and other transparent gemstones, mounted or not. The produced photo is called fingerprint or laser photography. → Crystalprint.

**Gems & Gemology;** a special periodical journal published by Gemological Institute of America.

**gems color;** the color of the gems results from the combining of the colors, which are not absorbed.

**gems, artificial;** → artificial gems.

**gems, imitation;** → composite stones, artificial stones.

**Gemsbok;** location of alluvial diamond deposits along the Namibia coast between Oranjemund and Lüderitz, Africa. Also called Area G.

**gemscope;** a trademark name for Gemolite.

**gemstone;** any rough mineral or other material natural or synthetic, which possesses the necessary attractiveness, brilliance, beauty, rarity, color dispersion, refraction, color or colorless, flawless, portability, fashionably, and durability for use in gem industry. For identification gems are superficially examined by color, optic qualities, sight, and coolness, but require some scientific examination such as determination of specific gravity, hardness, refractive index, crystal system (when crystallized), dichroism, absorption spectra, etc. All minerals, as well as the opal are gemstone, but all type of glass and plastics are excluded. → Gem, gem mineral.

**gemstone as curatives;** by the Middle Ages the medical curative power of minerals or gemstones become more pronounced and had developed into a mass of superstitions about planetary, medical and alchemichal influences (mystical power).

**gemstones as medicine;** the use of gemstones, minerals, rocks, fossils, etc is very old and real home of gemstone homeopathic medicine is India such as lapis lazuli, sapphire, emerald, bloodstone and may pearl. → Pharmaceutical products.

**gemstone as symbol;** in Ancient and Middle Ages it was suggested that an anagram of the name of God, had mystical power. It was believed that there was a relationship between the twelve ornamental stones in the breastplate of the Jewish High Priest gemstones and the twelve months of the year. It was believed that the wearing of one stone representing the birth month bestowed an extra measure of virtue on the bearer.

**gemstone as talismans;** obviously, believing that

gemstones also protect from the ill effects of a combination of influences, which can be seen in the Roman times practice of giving gemstones and gem materials for religious or spiritual significance.

**gemstone classification;** classification of gems based on the same classification as minerals. A descriptive category is the *name* of gems (natural, or synthetic, inorganic or organic). A basic category of gems are *species*, mostly of these are minerals, which mean a class of gems with particular chemical and physical properties (usually a crystallographic structure), which distinguish them from others, and within which may be numerous, for example corundum is a mineral species, In organic gem species are seen pearl, coral, amber, jet, ivory and shell. Species are divided into *varieties*. Varieties are based on color, color distribution, diaphaneity, and optical properties. Corundum is a gem mineral species of  $Al_2O_3$ , the red to purplish-red variety is called ruby, the blue variety is known as sapphire and all other colors are named as fancy sapphire. Chalcedony is fine-grained variety of quartz, when it has quasi parallel black and white banding named as onyx, whereas the bands are curved and angular known as agate. The translucent reddish chalcedony is termed as carnelian. A fine-grained, reddish and nearly opaque variety of quartz named jasper. Some optical effect of gems such as *asterism* is classified as variety for example a sapphire with star effect is known as star sapphire variety. Sometimes found the term *group*, which means two or more chemically related gem mineral species with the same structure and physical properties such as feldspars group or garnets group.

**gemstone constant;** the physical properties identifying a gemstones are: refractive index, double refraction, specific gravity, and hardness.

**gemstone cuts;** any forms or styles used in the fashioning of gemstones such as antique cut, brilliant cut, emerald cut, baguette, cabochon, rose cut, etc.

**gemstone, definition;** → gemstone or gem.

**gemstone price factors;** usually gems are objects of monetary value and have some of the qualifying characteristics such as brilliance, beauty of color, durability, rarity and portability.

**gemstone variety;** → gem variety.

**Gem-Trade Laboratories, Gemological Institute of America;** three research and testing laboratories for identification of diamonds and other gemstones and of grading jewels for the jewelry industry.

**gemulet;** a commercial term for a colorless glass embedded with fragments of synthetic opal, give low relief and the play-of-color appears much better.

**genera;** the plural of genus.

**General Electric Company;** General Electric Company

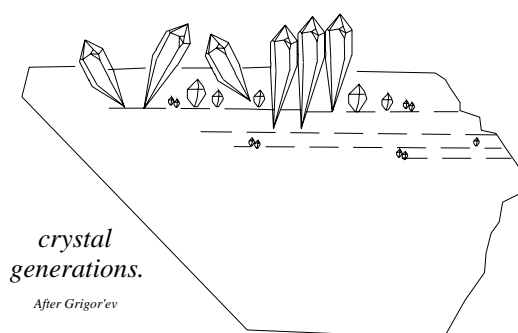
was the first laboratory where successfully made a synthetic diamond in New York, USA in 1954.

**General Electric synthetic diamond;** → General Electric Company. a semi-abbreviation: G.E. Synthetic diamond.

**general form;** in each crystal class there is a form, in which the faces, of which intersect all of the crystallographic axes at different lengths with the symbol  $\{hkl\}$ . In the orthorhombic, monoclinic, and triclinic crystal system  $\{111\}$  is a general form. All other forms other than general form, which may be present are special forms.

**general X-radiation;** same as white X-radiation in analogous to white light of the visible spectrum, or according to being mixture of all wavelength.

**generation of minerals;** a term applied to all the crystals of the same mineral species that crystallized at the same period. When the sizes of the crystals in the



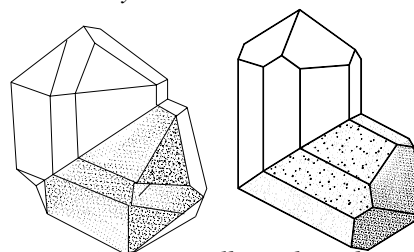
different groups are conspicuously different such as olivine phenocrysts are embedded in a groundmass containing crystals of olivine, they are indicated in two generations of olivine.

**genesis;** the formation of a gem mineral.

**genesis of diamond;** certain visible inclusions in the diamond is an indication of great heat and pressure, it is likely that it was formed at depths of 90-150 or more km.

**genesis of rock;** rock formation.

**Geneva ruby;** a misleading and obsolete term for once thought to be an artificially created ruby, made by fusing together of natural ruby fragments with the addition of potassium dichromate, which was called *reconstructed ruby* or *reco*. Now it has been indicated



geniculate or elbow-shaped twin of cassiterite and rutile

as reconstructed flame-fusion rubies. Also once was called *Wyse ruby*.

**genéville**; synonym for idocrase.

**geniculate twins**; knee-shaped crystal twins such as rutile TiO<sub>2</sub> crystal may be twinned on the second order pyramid (101). Also can be seen in cassiterite, spinel, and zircon. Known as elbow twins.

**Genoa**; a seaharpor and industrial city, capital of Genoa Province and Liguria Region. Lying on the Golf of Genoa, northwestern Italy. There is the famous Cathedral of San Giovanni. → Holly Gral.

**gentar**; an old Prussian term for amber.

**genthite**; a variety of garnierite. Amorphous. Pale apple-green to yellowish. Greenish-white streak. Resinous luster. SG:2.20-2.80. H:3-34. Found in Switzerland, Lake Superior, USA. It is prized by collectors.

**gentian violet**; an USA patent term for methyl violet.

**genuine doublet**; an assembled stone, in which both parts (crown and base) are cut from similarly colored stone of the same species.

**genuine pearl**; same as natural pearl. A term used to distinguish it from cultured pearl.

**genuine triplet**; an assembled stone from, in which both parts (crown and base) are cut from colored genuine gemstones plus a binding layer.

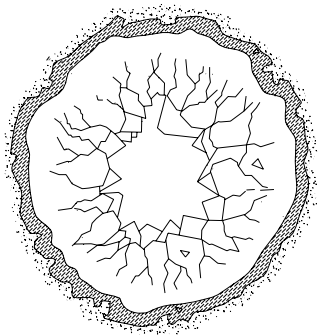
**genus**; a group or subgroup of two or more species in the classification of plants and animals.

**geochemistry**; the science dealing with the chemical changes in and composition of the earth's crust and in major classes of rocks and minerals.

**geochronologic**; of or pertaining to geological time.

**geochronology**; the measurement of time intervals in relationship to the history of the earth, or a geological scale.

**geode**; an often crystal-lined, hollow, quasi rounded cavity, in which gem minerals are projecting towards



*an amethyst  
geod  
surrounded  
by  
chalcedony  
rings.* fter  
Sinkankas 1964

the center, which usually differ in composition from surrounding material. Amethyst or quartz agate sometimes occurs this way. → Druse, vugh, miarolitic rocks.

**geode**; rounded cavities of ironstones with hollow interior.

**geodesic dome**; a geometrical dome formed of many

flat straight-sided surfaces made by framework of triangle or polygon bars, such as Mogul-cut, dome ct, etc.

**geode tuff**; a term used for geode-bearing material, originate from pyroclastic deposit of volcanic ejection.

**geognosis**; an earlier term for science dealing with the solid of the Earth as a whole, occurrences of minerals rocks, and the origin of these which is now replaced by geology.

**geological era**; the succession of periods from the oldest to the youngest time dealt with by historical geology. Also called geological time. → Precambrian, Paleozoic, Mesozoic, and Cenozoic.

**geological explanation**; same as geological legend.

**geological hammer**; a hand hammer which is used to breaking rock, consisting of a firmly head of hardened steel with a sharpened point at one end and a blunt surface at the other end, which is set crosswise on a handle. Also called rock hammer. → Field accessories.

**geological legend**; a brief explanatory list of symbols attached to geological maps which shows the correct sequence of formations. The youngest formation is shown at the top and the oldest at the bottom. Also called geological explanation, key, legend, explanation.

**Geological Museum Aquamarine**; an excellent cabochon cut chatoyant aquamarine of 114 cts. Now on display at the Geological of London.

**geologic time**; → geological era.

**geologist**; an informal term used by Australian miners to a geologist's pick. Another term for pick.

**geologist's pick**; same as geologist.

**geomagnetism**; a term applied to the magnetism of the Earth.

**geology**; the science that deals with the structure, origin, history, and mineral and rock compositions of the earth.

**geology of mineral deposits**; the science that deals with geological investigations of economic geology or economic mineralogy of commercial value. Also called economic geology, mineral economics.

**geominalogy**; the science that deals with rocks, deposits, mineral topography and mineral paragenesis.

**geomorphic**; pertaining to the form of the Earth surface features.

**geonomy**; a name variously recommended as a synonym for geology, which deals with the dynamic Earth, physical forces relating to the Earth and study of the Earth's upper mantle.

**georgeite**; a mineral dimorphous with malachite.

**georgiaite**; greenish tektite from Georgia, USA.

**geoscience**; same as earth science. A term embracing all part of the science of geology such as geophysics, geochemistry, paleontology, petrology, geography, geodetics, climatology, meteorology, oceanography and the astronomical aspects of the Earth-Moon

system.

**geoselenic**; aspects of the Earth-Moon system

**geosphere**; a term applied to lithosphere, hydrosphere and atmosphere. Same as lithosphere.

**geosphere**; any spheres or layers of the Earth.

**Geradia**; a species of coral. → Gold coral.

**German cut**; another term for pyramid cut.

**German diamond**; a misleading commercial term for variety of quartz crystal.

**German Gemmological Association**; same as Deutsche Gemmologische Gesellschaft.

**German gold**; a misleading term applied to a variety of amber from Germany.

**germanium**; a brittle, white, nonmetallic element of the Periodic System with the symbol Gr, used as semiconductor.

**germination**; same as breeding.

**German jet**; an inferior quality jet from Saxony, Germany.

**German lapis**; a misleading term for fraudulent imitation of lapis lazuli made of blue-stained jasper. Colored by potassium ferrocyanide and ferrous sulfate (components of Prussian blue or Berlin blue). It is to distinguish by its high luster, small gray knot of quartz that does not take the dye, and the lake of pyrite sprinkles. Also known as Swiss lapis. → False lapis.

**German mochas**; a commercial term for a moss agate imitation.

**German onyx**; a commercial term for agate onyx.

**German Royal Treasures**; there are famous treasures in Dresden, Berlin, Munich, in which many gemstones and precious objects from members of ruling Royal families are on display.

**German silver**; a misleading term for a white alloy of copper, nickel and zinc in varying proportions. Also known as nickel silver, argentan, argenyine plate, copper-nickel-zinc.

**German South-West Africa**; → Namibia.

**germanates**; a transparent synthetic product similar to silicon germanium, if lead is added a fine yellow-colored mass can be obtained. Formula:  $Pb_3Ge_3O_{11}$ , which is called lead germanate. → Bismuth germanate.

**germicidal effect of amber**; believing that amber possessed germicidal effect was used in the Middle East as mouthpieces and smoker objects.

**geschenie**; a term applied to apple green beryl, which is rich in sodium.

**gette**; an old term for jet.

**getter**; in synthetic diamond industry which take the nitrogen impurity away.

**geuda**; a Sinhalese term to describe different low-grade quality of pale blue, yellow or pink color sapphire which is found mostly in Sri Lanka. This

variety of stone is not suitable for cutting gemstone because of exsolved rutile silk clouds in it, which after heat-treatment change its color to cornflower-blue sapphire. Geudas sapphire in Sri Lanka are classified as: (a) *blue geuda* a semitransparent to sub-translucent stone with powder-blue color or with light diesel effect in transmitted ray, (b) *diesel geuda* a semitransparent to sub-translucent stone of tea-color to diesel effect in transmitted ray, (c) *waxy geuda* a semitransparent to sub-translucent stone of waxy appearance and a slight diesel effect in transmitted ray, (d) *silky geuda* a translucent to sub-translucent stone of silky appearance which is caused because of whitish bands impurity follow the crystal form and (e) *milky geuda* a semitransparent to sub-translucent stone of milky appearance with slightly diesel effect in transmitted ray.

**geyser**; a term used by Australian miners for a hard pebbly cement material mixed with opal matrix through it. Also erroneously spelled geizer, geeser.

**geyserite**; a porous, loose, concretionary, whitish to grayish variety of common opal deposited around some hot springs or geysers. Found in New Zealand, Wyoming, USA. Also called siliceous sinter.

**GG**; an acronym for someone who has successfully passed the course and examinations of the Gemological Institute of America.

**GGDO**; an acronym for Government Gold and Diamond Office (Sierra Leone).

**GGG**; an acronym for gadolinium gallium garnet.

**Ghana**; an important alluvial diamond producing country in West Africa. Formerly called Gold Coast.

**Ghana diamond**; diamonds from the third biggest diamond mine in the world.

**Ghana Consolidated Diamond Ltd.**; a government diamond company in Ghana, this company has managed mining operations since 1972. Formerly called the Gold Coast. Production is marketed through Precious Minerals Marketing Corporation. Using the acronym GCD.

**Ghana Diamond Marketing Corporation**; one of the diamond companies in Accra, Ghana. This company is licensed by the government to buy diamonds from native miners since 1965. Now called Precious Minerals Marketing Corporation.

**ghost crystal**; same as phantom crystal.

**ghost-like**; feather like arrangement of thousands very minute crystals seen in spinel as inclusions.

**ghost picture**; same as host image.

**GIA**; an acronym for Gemological Institute of America.

**giacinto**; an Italian term applied to a recipe of zircon or hyacinth, which is used as medicine combined with plants and animal materials. Also called confection of hyacinth, hyacinth confection.

**GIA clarity-grading scale;** a scale established by the Gemological Institute of America, which runs from flawless (FL), internally flawless (IF) through very, very slightly included (VVS), very slightly included (VS), slightly included (SI), and 3 grades included (I).

**GIA color-grading system;** a color-grading scale for colorless to yellow diamonds the letters D represent colorless diamonds, through Z for yellow to light gray range. This scale is set in relation to a series of master diamonds that are maintained in the CIA's Carlsbad Laboratory. Colors such as yellow and brown not found in range Z master diamond are considered to be fancy colors. Also called GIA color-grading scale.

**GIA color-grading scale;** → GIA color-grading system.

**GIA Diamond Grader;** same as gemological microscope designed and manufactured by Gemological Institute of America.

**GIA dichroscope;** a dichroscope made by Gemological Institute of America.

**GIA Gem Instruments;** a subsidiary company of the Gemological Institute of America. Headquarters for this society are located at: 5355 Armada drive, Carlsbad California 92008, USA.

**GIA Gem Trade Laboratory;** a subsidiary company of the Gemological Institute of America Enterprises, which provides professional grading and identification for the diamond and colored stone industries. Headquarters for this society are located at: 5355 Armada drive, Carlsbad, California 92008, USA.

**GIA spectroscope;** a handy pocket spectroscope with a draw-tube focus and slit-adjusting ring made by Gemological Institute of America.

**GIA thermal reaction tester;** a hot-point tester instrument constructed by Gemological Institute of America. → Hot-point tester.

**GIA utility lamp;** a monochromatic yellow light instrument lamp for refractometers constructed by the Gemological Institute of America.

**giant clam;** a fancy pearl-producing marine mollusk, which provides the largest and heaviest univalve shell known called *Tridacna gigas*. Found along the coast of Florida, West Indies, Bahamas, Gulf of California, and Mexico. The pearls are white, non-nacreous and have a porcelain like surface. Some orange colored pearls like conch pearl are found in Malaysian and Vietnamese waters.

**giant conch;** a fancy pearl from marine mollusk giant one of the largest of the univalve shell known as giant conch *Strombus gigas* of the Atlantic coast of the USA, West Indies, or of tropical seas. The shells are used particularly to make banded cameos. The pearls are non-nacreous and have a porcelain-like surface with a marking appearance similar to flames. The white to pink pearl from this conch is known as *conch pearl*.

Also known as queen conch. → Great conch, flame pattern pearl.

**giant granite;** same as pegmatite.

**giant granite vein;** same as pegmatite vein.

**gibbsite;** a white or tinted mineral of  $8[\text{Al}(\text{OH})_3]$ . Monoclinic system. White-grayish, grayish to reddish-white. Pearly to vitreous luster. White streak. Optics;  $\alpha:1.568$ ,  $\beta:\alpha$ ,  $\gamma:1.587$ . Birefringence: 0.020. ⊕. SG:2.40. H:  $2\frac{1}{2}$ - $3\frac{1}{2}$ . Polymorphous with bayerite, nordstrandite, and doyleite. Used by flux-melting process of synthetic corundum and sapphire. Sometimes gibbsite is coated with plastics to imitate turquoise and added pyrite as inclusions and apparent dendritic matrix, which is known as *coated gibbsite*. Also called hydrargillite.

**gibbsite, coated;** → gibbsite.

**Gibraltar stone;** a translucent, waxy luster, stalagmitic, banded as sinuous veins, amber-brown to brown calcite material found in limestone caves at Gibraltar. Those from Austria are misnomered as *Tyrolese onyx*. Used as small ornamental objects. → Mexican onyx.

**gibsonite;** fibrous pink variety of thomsonite.

**Gibsonville emerald;** a misnomer for greenish quartz. Used as emerald imitation. Also called greenish quartz.

**gidgee opal;** a variety of opal, which is mixed with ironstone and impregnated with roots of the gidgee tree (an acacia). SG: 2.65-3.00. Cut cabochon.

**giessenite;** an orthorhombic mineral of copper, lead, bismuth, antimony sulfide found as inclusions in quartz crystal.

**gigaku;** a term used in Japanese for jade. Also called tama.

**gika;** same as jiqq.

**Gika of Nadir Shah;** an aigrette of 781 grams in the National Jewel Treasury of Iran, Tehran in the form of a plume with several cabochon, and drop cut, the entire gika studded with diamonds. Also spelled Jiqq of Nadir Shah.

**gilding;** the method of overlaying or coating the surface of metal, wood, etc. with a thin layer of gold or gold alloy.

**gilding;** overlaying or coating the surface by electroplating.

**gilding;** coating the metallic surface by fire gilding (mercury gilding).

**gills of oyster;** respiratory organs of invertebrates or water-breathing animals such as bivalve mollusk, which is covered with microscopic feather-like structure, frequently named as cilia.

**Gilson-created coral;** an ox-blood, salmon pink coral imitation made by Gilson in France from calcite and pigment by high pressure and heat. It has no *wood-grain structure* like true coral. SG:2.40-2.50. Specific gravity of true coral is 2.60-2.70.

**Gilson-created emerald;** same as Gilson-synthetic emerald.

**Gilson emerald;** a type of synthetic emerald produced by P. Gilson, Pas de Calais, France. → Gilson-synthetic emerald.

**Gilson-synthetic emerald;** a commercial term for a flux-melting process synthetic emerald made in France by P. Gilson, Pas de Calais. Also called Gilson-created emerald, and Gilson emerald.

**Gilson-synthetic lapis lazuli;** a so-called synthetic lapis lazuli manufactured by P. Gilson, Pas de Calais, France with or without pyrite inclusions. Stone has some properties of true lapis lazuli. RI:1.50. SG:2.36-2.46. H:4½.

**Gilson-synthetic opal;** a high quality synthetic white opal, black opal, fire opal or water opal manufactured by P. Gilson, Pas de Calais, France. Made by dehydrating a sodium silicate or a silicon ester.

**Gilson-synthetic stones;** stones made in France by P. Gilson, Pas de Calais such as Gilson-synthetic emerald, Gilson-synthetic lapis lazuli, Gilson-synthetic opal, and Gilson-synthetic turquoise.

**Gilson-synthetic turquoise;** an imitation turquoise made from copper phosphate and calcium carbonate, manufactured by P. Gilson, Pas de Calais, France. RI:1.592. SG:2.635. The fancy promotion name for dark blue is *Farah turquoise*, and medium blue named as *Cleopatra turquoise*.

**gilsonite;** a jet-black, brittle variety of asphaltite or solidified hydrocarbons. Used as lacquers. Same as uintahite.

**gingerbread palm;** → doom palm nut.

**ginger-whisker;** a term used by Australian miners for fault in rough opal. Fractures are in sharp right angle where breaks, which indicate more, break away due to grinding.

**gintaras;** a Lithuanian term applied to amulet made of amber to protect a person based on the belief in amber efficacy. Gintaras meaning protector.

**giobertite;** same as magnesite.

**giogetto;** an Italian term for black coral from Mediterranean. Also spelled giojetto.

**giojetto;** → giojetto.

**gipsy;** same as gipsy setting.

**gipsy setting;** same as gypsy setting.

**girandole;** earring or brooch, which is ornamented with several pendants, often diamond or other gemstones.

**girasol;** sun turning. A variety of precious opal displaying many bright red color. → Chatoyant effect, cymophane, cat's-eye.

**girasol;** frequently used term for fire opal.

**girasol;** water opal with bluish floating light.

**girasol;** a term applied to moonstone.

**girasol;** a commercial term for glass spheres used as imitation pearl beads.

**girasol;** a term applied to a few gemstones that exhibit flashes of fire, for example *girasol scapolite* or *girasol sapphire*. → Chatoyant effect, cymophane, cat's-eye.

**girasol chrysoberyl;** same as cymophane with girasol effects.

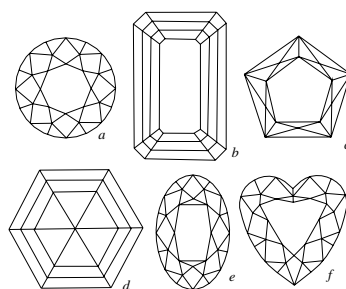
**girasol opal;** some varieties of opal described under girasol.

**girasol pearl;** a misleading term for imitation glass pearl.

**girasol sapphire;** a term applied to sapphire cat's-eye.

**girdle;** the outer edge or periphery of a polished diamond or other gemstone, which divides the crown (top), from pavilion (base).

**girdle;** the girdle on round brilliants is not polished, but of step-cut diamonds, almost fancy brilliant cuts, and some round brilliant-cut diamonds are polished to



*girdle outline of different cuts, a: round-brilliant crown, b: emerald-cut crown, c: five rayed star-cut crown d: hexagon-cut crown, e: oval cut and f: heart cut*

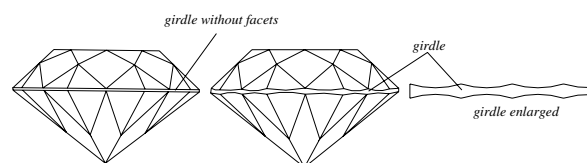
achieve more brilliance, such girdles are called *ground girdle*, *faceted girdle*, or *polished girdle*.

**girdle;** the edge of a polished gemstone, to which the setting is attached. → Girdle thickness.

**girdle, bearded;** internal faults of gemstones, sometimes may be included with external ones. Caused during manufacturing, which looks like a series of fine hair-like cracks extending a short distance radially into the stone from girdle. → Bearded girdle.

**girdle blemishes;** blemishes on girdles occur usually as chips, conchoidal fractures, cleavage, flats, fissures, etc.

**girdle diameter;** same as diameter.

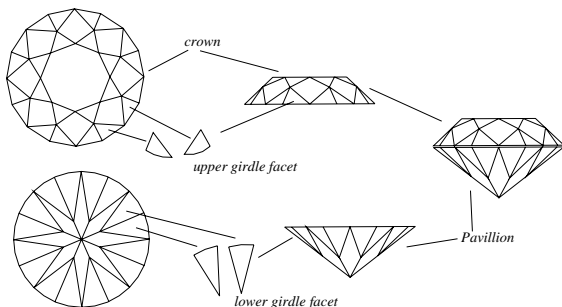


*two brilliant-cut with facets on girdle and without facets*

**girdle facet;** minute and plane or nearly plane facets,

which are insert open the girdle, especially on a brilliant. Also called faceted girdle, skew facets, skill facets, cross facets, break facets. Also frequently named as half facets or little halves. Not to be confused with girdle facets.

**girdle facets;** the 32 triangular facets, which are adjacent to the girdle of a round brilliant-cut gem. There are 16 facets above the girdle, which are called



situation of girdle facets on crown and pavilion

upper girdle facets and 16 facets below it called lower girdle facets. Girdle facets on the crown are also known as upper girdle facets, upper break facets, top break facets, top-half facets. Those girdle facets on the pavilion are also known as lower girdle facets, lower break facets, bottom-half facets, bottom-break facets. Not to be confused with girdle facet.

**girdle faceted or polished;** girdles of faceted gemstones that are not round, such as emerald, pendeloque, and square cuts, are polished.

**girdle outline;** sketching the girdle edge of the outermost of a gemstone, which dividing line between crown and pavilion. Girdle outline are: rounds, ovals, rectangulars, squares, marquises, heart, and pear.

**girdle plane;** a plane parallel to the table surrounding the girdle of a gemstone dividing the crown from the base.

**girdle proportions;** the girdle should not be too thin, neither should it be too thick, it should be even all round and not thicker on one side than the other.

**girdle reflection;** when viewed through the table of some brilliant-cut diamond or other cut-stones the reflection of the girdle in the internal surface of the pavilion facets can be seen. When pavilion depth is less than 40 percent. → Fisheye.

**girdle rondisting;** practice makes estimation of girdle proportion easy and they can be made perfectly round in an operation.

**girdle thickness;** the width girdle proportion of a diamond or other gemstone. The ideal thickness of a girdle does not exceed 1% of the girdle diameter in stones of approximately 0.50 to 2.00 cts, also not to narrow as being knife edged. The relative thickness of girdle depends on the largeness of the stone. Thickness

is classified as slightly thick, thick, very thick, and extremely thick.

**grinding;** the technique girdling of round diamonds. → Grinding diamonds.

**girdling diamonds;** the grinding of diamonds is now done mechanically, this is carried out by mounting the stone on the headstock of a special holder. Also called rounding up, bruting, cutting, rondisting.

**glacial;** produced by ice action.

**glacial;** same as glacial age.

**glacial abrasion;** same as glacial erosion.

**glacial boulder;** those boulders, which has been transported by a glacier. Also called ice boulder.

**glacial denudation;** the process of erosion due to agency of glacier. Also called erosion by glacial ice.

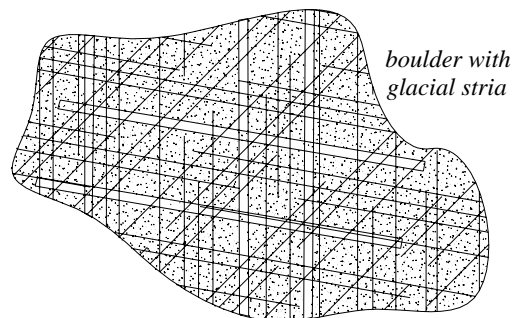
**glacial erosion;** the scratching, grooving, grinding, polishing, etc. by movement of soil or rock by the action of moving ice of a glacier. Also called glacial abrasion, glacier erosion.

**glacialite;** a commercial term for a white clay from Oklahoma, USA marketed as a fuller's earth.

**glacial polish;** smooth bedrock surface produced by glacial abrasion.

**glacial scratch;** same as glacial stria.

**glacial stria;** commonly straight and parallel furrows or



lines inscribed on smooth bedrock surface due to glacial abrasion. Also called glacial scratch, drift scratch.

**glacier erosion;** same as glacial erosion.

**Gladstone and Dale relationship;** the linear relationship between specific gravity and refractivity of liquids determined as a diagram by Gladstone and Dale.

**glaes;** same as gles.

**glance;** a term used to describe various minerals with a high metallic- or splendent luster, as lead glance, etc.

**glass;** a hard, brittle, usually transparent but often translucent to opaque, noncrystalline consolidated product or mixture of silica (SiO<sub>2</sub>), with the addition of alkali, lead oxide, boron and aluminum oxide, or other metallic oxide to increase durability, resistance and the dispersion. Most glasses are supercooled liquids, and metastable and after a long time they may crystallize, which is called *devitrification*. Artificial and natural



glasses having similar properties and composition as fused obsidian or borax. RI:1.44-1.90. SG:2.00-6.00. H:5-6½ sometimes about 7. It is to be detected by microscope examination, when it contains whorls *cooling striae* and *air-bubbles*, and consequent lack of dichroism. There are two principal types of glass: (a) the *flint* glasses made of silica, potash, soda, and lead, which are used as ornaments colored by copper, cobalt, selenium, and uranium, cut glass, and refractometer



prisms by adding the element thallium obtains very high dispersions. → Flint glass. (b) The *crown glass* is made of silica, potash, soda, and lime. Used very widely in jewelry as inexpensive imitations. Glass jewels are readily distinguished from genuine gemstones. Glass feels warmer than other gemstone and is easily scratched. Also called pastes or strass. Obsidian and moldavite, etc. are natural glasses. → Crown glass, beryl glass, borosilicate glass, strass, flint glass, Libyan glass, beryl glass, meta-jade, Victoria stone, tektite, devitrification of glass.

**glass;** natural glass such as obsidian it constitute the whole of rock.

**glass;** → glassy, hyalite.

**glass;** a name used indiscriminately for diamond imitations.

**glass agate;** a misleading term for transparent to translucent obsidian.

**glass, alabaster;** → alabaster glass.

**glass as beads for imitation pearls;** → imitation pearls.

**glass, aventurine;** a translucent reddish-brown glass paste containing soda-lime silica colored by copper oxide, which precipitates. Characterized by thin geometrical plates (triangular or hexagonal) of crystalline copper that exhibit bright reflections. Used as an imitation of sunstone or aventurine a variety of plagioclase feldspar or aventurine quartz. RI:1.53. SG:2.50-2.80. Not to be confused with golden stone. It is also manufactured in blue color. Also called goldstone. Same as aventurine glass.

**glass bead;** a type of bead, made of colorless or colored glass, usually transparent but often translucent to opaque, smooth or faceted, enameled, solid or hollow, gilded or iridescent glass of various shape and size.

**glass, beryl;** → beryl glass.

**glass body;** a commercial term used for transparent and best color ruby from Myanmar, which is extremely rare.

**glass-bonded mica;** a glass material, in which fine particles of mica are embedded.

**glass, borosilicate;** → borosilicate glass.

**glass-bottomed cell;** a glass cell or glass dish used to immerse the stone containing a liquid of refractive index fairly near to that stone.

**glass, bubbles in;** → bubbles.

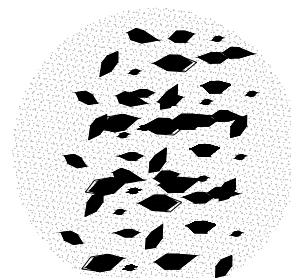
**glass cell;** → glass-bottomed cell.

**glass ceramic;** a material melted and formed as a glass.

**glass, chatoyant;** a number of glasses with chatoyancy effect or has a changeable luster or color which is characterized by a thin narrow band of light resembling the cat's-eye, which contains parallel oriented tubes so that a very sharp band of light similar to an eye is produced on the apex of a cabochon cut and marketed as *fire eye*. Other peculiar glass is made of parallel glass fibers with the name *catseyte*, which shows hexagonal honeycomb pattern in cross section. Other glass is Victoria stone, which is partially devitrified and shows a silky texture.

**glass colors;** glass is colored by chemicals or mixtures of metal oxides of small amounts used to confer special properties on glass such as selenium, copper, gold for red, cobalt for blue, uranium for yellowish-green. → Glass, coloring agents of.

**glass, coloring agents of;** there are many metallic elements used to obtain colored glasses, when they are



*copper scales in glass as color agent*

mixed with *batches* as impurities or traces, such as iron, chromium, manganese, copper, titanium, cobalt, vanadium, and nickel. → Glass color.

**glass, color change;** glasses with the effect of change color in their body during determining under different type of illuminations such as alexandrium which is a glass made of lithium aluminum silicate and made in a variety of colors. Neodymium as a coloring agents yields pink lavender colors, which appears pink under normal light and violet under fluorescent lamps. Other kind of this paste is tourmaline-like glass, which appears light pinkish-orange under normal light and yellowish

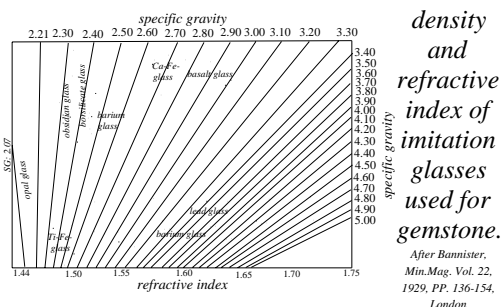
green under fluorescent ray. A vivid, laser blue variety blue is colored by copper.

**glass, conch pearl imitation;** → conch pearl imitation.

**glass, Crookes;** → Crookes glass.

**glass cutter;** a hand tool set with diamond to cut glass, which also called vitriers. → Diamond set.

**glass densities;** glass density is very variable because of



chemical components, which may depend from 2.00 to 6.00.

**glass, devitrification of;** → devitrification of glass, glass.

**glass dishes;** → glass-bottomed cell.

**glassen;** coating with a glaze.

**glass enamels;** a colored (or uncolored) glassy substance, translucent or opaque, fused to a base or to the surface by heat of articles, glass, ornament, pottery, etc.

**glass etcher;** one who etched glass in a bath of hydrofluorite acid.

**glass fiber;** a term applied to fibers manufactured from glass.

**glass filled fracture;** → filled diamond.

**glass, fluorescence of;** → fluorescence of glass.

**glass, fracture in;** → fracture in glass.

**glass frost;** → frost glass.

**glass gems;** same as imitation gems from glass.

**glass grinder;** one who grinds and polishes the edges of glass or windows glass.

**glass, haematinon;** a semitranslucent, dark-red aventurine glass (or goldstone), which was known to ancient. Also called purpurine glass. RI:1.53. SG:2.50-2.80.

**glassie;** a diamond sorting grade for transparent and well shape-edged octahedral diamond crystals with flat glass-like faces. Also spelled glassy, and called a *point-cut diamond*.

**glassie;** adjective for a diamond, which lacks brilliancy.

**glassite;** a fossil resin.

**glass, imitation;** → imitation glass.

**glass imitation pearls;** glass coated with fish-scales extract known as *essence d'orient* on surface to provide a nacreous appearance or hollow spheres lined

with essence d'orient and filled with wax to imitate the natural pearl or cultural pearl. Such pearls were called *Roman pearls*. Up to 10 times coats of essence d'orient are usually applied to make a bead appear pearl-like. Imitation pearls are made from a special opalescence glass, which is misnomered as alabaster such as Mallorcan pearl from island Majorca or Mallorca, Spain. Due to immersion or spray, the exterior of solid glass beads having a string hole with essence d'orient, which were called *Venetian Pearls*. Usually, glass imitation pearl will feeling smooth by rubbing lightly against the cutting edges of front teeth, while natural and cultured pearls will feel gritty. Bubbles may see in the coating layer on the surface and in fractures, some chips are seen especially around the drill-holes. Recently made imitation pearls that feel gritty, distinguish with a pin pressed into the surface, which scratches the coated bead or indent it. → Imitation pearls.

**glass, inclusions in;** → inclusions in glass.

**glass iridescence;** → iridescence of glass.

**glass jewelry;** various personal adornments decorated with glass or made of glass, beads, finger rings, pendants, necklaces, bangles, etc.

**glass lava;** same as obsidian.

**glassmaker's soap;** decolorizing agents such as MnO<sub>2</sub> used in glass industries to produce colorless glasses.

**glass meteorite;** same as moldavite.

**glass, natural;** → natural glass.

**glass opal;** same as hyalite.

**glass opal;** → glassy.

**glass, opalescent;** → alabaster glass.

**glass opalite;** a composite stone made from black onyx or a black glass in base and a thin film of opal in top.

**glass, play-of-color;** play of the soft rainbow colors seen in some glasses made to imitate opal due to adding metal foil or fragments of mother-of-pearl to the molten glass. So called Slocum stone is an opal imitation made by Slocum Company. It is made in various colored pieces from sodium-rich silicon glass containing some magnesium and calcium. It is fused together in the form of cabochon to imitate fire opals. RI:1.49-1.52, G:2.40-2.50, H:6.

**glass polisher;** one who polishes glass.

**glass purpurine;** a dark red variety of aventurine-glass, which is known as haematinon or purpurine. → Aventurine glass.

**glass quartz;** a term sometime used for quartz.

**glass, radioactive;** → radioactive glass.

**glass, refractive indices of;** → refractive indices of glass, Banister's graph.

**glass rock;** a pure cryptocrystalline limestone of Trenton, USA.

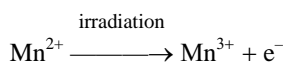
**glass rock;** a local term applied in northern Illinois and southern Wisconsin to a cryptocrystalline limestone.

**glass schorl;** same as axinite.

**glass, silica;** pure silicon dioxide (SiO<sub>2</sub>) found in Libyan desert in pale green yellow color. RI:1.46. Dispersion:0.001. SG:2.21. H:6. Cut as gems. Also called quartz glass or silica glass.

**glass smoother;** same as glass polisher.

**glass solarized;** old glass was made in past contains iron and impure with manganese because to provide both physical and chemical colorizing. When such glass is exposed to ultraviolet radiation a part of sun light or to another energetic radiation, obtain a dark purple colored glass by involving manganese



This glass known as *desert amethyst glass*, because its color. Also called solarization of glass. → Desert amethyst glass, amethyst, glass.

**glass specific gravity indicators;** a useful accessory is small glass indicators, each marked with its appropriate specific gravity used to check the specific gravity of liquids before use.

**glass, specific of;** → densities of glass.

**glass stone;** synonym for axinite.

**glass tile;** tile made of colorless or colored glass.

**glass, transparency to X-ray;** lustrous lead glass is opaque to X-rays due to heavy lead atom, but some other glasses are transradiant to X-rays.

**glass, types of;** → types of glass.

**glass, uranium;** → canary glass, uranium glass, radioactive glass.

**glassy;** a term applied to certain texture of extrusive igneous rock which is similar to that broken glass, such glass is developed as a result of rapid cooling of the lava, which is not crystalline.

**glassy;** any other volcanic rock that resemble those properties of glass such as hardness, luster or composition. Also called vitreous or hyaline. → Glassies.

**glassy;** a term applied to diamonds, which lack brilliancy.

**glassy;** a term used by Australian miners to a transparent to translucent variety of common opal with sometimes a bluish light reflected from inside the stone, which occurs in botryoidal or globular (resembling drops of melted glass), crusts or stalactitic shape. Synonym for *water stone*, *water opal*, *Müller's glass*, *hyalite*, *hyalite opal*, *glass opal*. Also spelled glass.

**glassy;** glassy luster or vitreous. → Glassies.

**glassy;** of the nature of glass.

**glassy diamonds;** diamonds, which lack brilliancy.

**glassy feldspar;** some alkali feldspars such as sanidine and adularia both occur in transparent glassy crystals embedded in unaltered acid volcanic rock, sometimes in yellow color but it is very rare.

**glassy ivory;** it means hard ivory or bright ivory, which seen more glassy than soft ivory.

**glassy luster;** same as vitreous luster.

**glassy rock;** a term applied to any rocks that are the most evident result of rapid cooling from magma such as acidic rhyolites and dacites. Commonest glasses are the obsidian in black, red and brown colors, which may be assumed rapid cooled rhyolites or dacites. *Pumice* is cellular obsidian. *Perlite* is a shot-like spheroids or sub-spherical variety of obsidian.

**glassy rock;** same as vitreous luster.

**glassy stone;** a term applied to a stone of dark gray color and black edges.

**glatts;** same as gles in diamond.

**glatze;** same as gles in diamond.

**glauberite;** a monoclinic mineral of 4[Na<sub>2</sub>Ca(SO<sub>4</sub>)<sub>2</sub>]. Gray, yellow, colorless, sometimes red. Streak: white. Transparent to translucent. Fracture is conchoidal. Brittle. Cleavage: {001} perfect, and {110} distincts. Vitreous, pearly to wax luster. Optics; α:1.514, β:1.534, γ:1.536. Birefringence: 0.022. ⊖. SG:2.80-2.85. H:2½-3. Opal is often found as pseudomorphous after glauberite.

**glaucanite;** a dull-green, yellowish-green to blue-green. Monoclinic crystal of hydrated magnesium, aluminum, potassium, ferric and ferrous iron aluminum-silicate mineral of the mica group. α:1.592-1.610, β:1.614-1.641, γ:1.614-1.641. Birefringence: 0.016. ⊖. SG:2.2-2.40. H:2. The so-called blue glaucanite sands, in which amber is found in green sands on the Baltic coast. Also called blue earth.

**glaucanite;** a name used for a green sedimentary rock of high glaucanite content.

**glaucophane;** a blue, bluish-black or grayish-blue mineral of the amphibole group. Monoclinic crystal. Chemical formel Na<sub>2</sub>(Mg,Fe<sup>+2</sup>)<sub>3</sub>Al<sub>2</sub>(OH)<sub>2</sub>(Si<sub>4</sub>O<sub>11</sub>)<sub>2</sub>. H:6. SG:3.00-3.20. γ:1.622. It has a fibrous or prismatic mineral aggregate. Occurs only in certain crystalline schists in regional metamorphism of sodium-rich igneous rocks.

**glaucophane schist, jadeite in;** jadeite found in glaucophane schist in Sonoma County, USA.

**glaze;** a glass-like product manufactured essentially from fusible clay to coat ceramic or pottery bodies. Also called glaze ice, glazed frost, freezing rain.

**glazed frost;** same as glaze.

**glaze ice;** same as glaze.

**glazier's diamond;** minute fragments or bort of diamond crystals, which are used for cutting glass.

**glazing;** ceramic coating or pottery bodies with a thin layer of frit mixed with some clay, followed by firing.

**glazing;** a sanding process of abrasive grains between grinding and polishing used in the cutting and faceting of gemstones other than diamond.

**glazing marble;** a fine translucent variety of marble, which was used for windows by the Romans.

**glazy;** same as vitreous or glassy.

**gles;** a term was applied in early times in northern Europe to amber. The name became confused with glass in many tales and histories. Also called glese, glez, glaes.

**glese;** same as gles.

**gles in diamond;** a term of Dutch origin applied by polishers for feathers in the form of black spot (carbons), some other included minerals, cleavage, cracks, and splits. Also called gluts, glatts, glatzte, gletz.

**glessite;** a light brown variety of retinite similar to amber occurring with succinite on the Baltic Sea shores. Nearly opaque. Conchoidal fracture. Greasy luster. SG:1.015-1.027. H: 2. Gles is an ancient term for amber.

**glesson;** an obsolete term for feathers as imperfection occurring in gems.

**glets;** same as gles in diamond.

**gletz;** a Dutch origin term for a feather like cracks in diamond. → Gles (in diamond), feather.

**glez;** same as gles.

**glide direction;** a term applied to crystallographic direction of glide translation.

**glide plane;** in a crystal deformation, a symmetry plane along, which transition of one part of the crystal take place.

**glide plane;** the plane of the two axes of a twin crystal.

**glide reflection;** a term applied to a symmetry element in a crystal which relates parts on opposite sides by reflection including translation parallel to the crystallographic plane.

**gilding;** transition along a plane in a crystal due to plastic deformation. Often produce crystal twin. Also called crystal gilding, slip, and transition gilding.

**glimmering (luster);** denotes a still more feeble luster. Also called glistening, medium luster, diffuse luster.

**glimmerite;** a German term used as a synonym for biotite

**glist;** a local term used in Cornwall to a black to deep-brown, iron-rich variety of biotite. Also called lepidomelane, iron mica.

**glistening (luster);** → glimmering (luster).

**globigerina;** a genus of foraminifers of the family Globigerinidae having calcareous shells and living near

the surface of the sea with radiated calcite crystal. Their



stratigraphic range is middle Jurassic to present

**Glob of the World;** the famous glob made of gold and paved in gemstones of various colors to represent seas and lands, inscribed Indian Ruler Jahangir Shah (1609-1610 of 1018 Hegra). Now on display at Collection of the National Jewel Treasury of Iran, Tehran.

**globular;** same as spherulitic.

**globulite;** an aggregate of usually dark colored, minute size globular or spherical shaped crystallite commonly found in volcanic glass such as obsidian or pitchstone (natural glass), when examined under microscope, while fused bead-like string or globulites crystallite are known as *margarites* and those rod-shaped or elongated globulites crystallites are known as *belonite*.

**glockerite;** same as lepidocrocite.

**glory;** radiant, colored glory or rings surrounding the shadow of observer head caused by diffraction of water droplets in the mist. Also called specter of the Brocken.

**glosarite;** a term used for zinc vitriol  $ZnSO_4 \cdot 7H_2O$ . Also called white copperas, white vitriol.

**gloss;** a term applied to the property of high smooth or polished surface.

**glow stone;** same as chalcedony.

**glucina;** → glucinum.

**glucinite;** synonym for herderite.

**glucinum;** an old term for sweet component of beryllium oxide, which used to distinguish true beryl from other stones. Also called glucina, beryllium, beryllia, beryllium oxide.

**glued;** same as composite.

**glued stone;** same as composite stone.

**glycerin;** a clear, sweet, warm taste, colorless or pale yellow, syrupy liquid of  $C_3H_5(OH)_3$  obtained from oils, fat, etc. RI:1.47. SG:1.2653. Soluble in water and alcohol. Used as an immersion liquid. Also spelled or called glycerol, glycerine, glycy alcohol.

**glycerine;** → glycerin.

**glycerol;** → glycerin.

**glycol;** a colorless, sweet, toxic, dihydric alcohol liquid of  $CH_2OHCH_2OH$ . Soluble in water and ethyl alcohol.

Used as solvent for waxes and resins. Also called glycol alcohol, ethylene glycol.

**glycol alcohol**; same as glycol.

**glycyl alcohol**; same as glycerin.

**glyph**; engraving or carving of a figure, a monogram, or inscription on a gemstone or ornament in the form of a cameo or intaglio such as hieroglyphic.

**glyptic**; engraving on gems or ornaments.

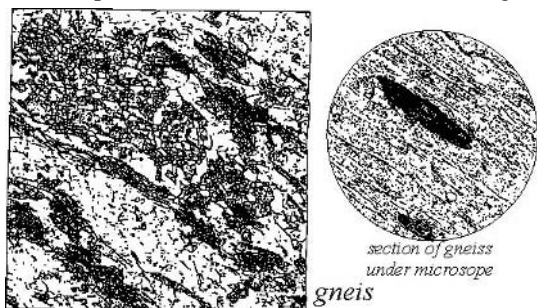
**glyptography**; the art, process, or operation of gem carving and engraving. Also the study of engraved gems or other stones.

**glyptolith**; same as faceted pebbles polished by wind action. Also called ventifact, wind-worn stone, wind-cut stone, windkanter, wind-shaped stone, wind-polished stone. Same as glyptolith.

**Gnaga Boh Ruby**; a fine ruby of 44 cts, in the rough from Myanmar, (Burma) it was cut into a 20 cts, gemstone. Also known as Dragon Lord Ruby.

**gnat stone**; same as moss agate, mocha stone with small black inclusions. Also called midge stone.

**gneiss**; a coarse-grained, foliated, phenocrystalline metamorphic rock, in which lentils or bands of granular



minerals, dark minerals such as mica and hornblende are separated from light minerals such as quartz and feldspars.

**Godavari River**; location of an ancient alluvial diamond source river in Hyderabad, India.

**godly system**; a diamond mining method whereby chambers were cut into a staggered plan so that the top of the blue ground formed a small hill underneath the overburden. This hill was supported at the sides like an arch, which reduced the pressure.

**Goddess of Emeralds**; a fabulous pyramidal emerald crystal from Peru, as large as an ostrich egg, which was worshipped by American Indian natives of Manka valley. Until today, whereabouts is unknown. → Cortez Emerald, Tezucuo.

**Goedehoop**; location of a small alluvial diamond mine in Christiana area, Transvaal Province, South Africa.

**Goedgedacht**; location of a small alluvial diamond mine in Ventersdorp area, Transvaal Province, South Africa.

**Goedvoorzicht**; location of a small alluvial diamond mine in Lichtenburg area, Transvaal Province, South

Africa.

**goethite**; an alpha hydrated iron-oxide, polymorphous with lepidocrocite, feroxyhyte, and akaganeite. Also called  $\alpha$ -goethite, allcharite, xanthosiderite, göthite. As inclusion in quartz and in plagioclase causes the sunstone varieties.

System: orthorhombic.

Formula:  $4[\alpha\text{-FeO}(\text{OH})]$ .

Luster: adamantine-metallic to dull.

Colors: crystals blackish-brown, yellowish-brown, reddish, yellow to ochre yellow.

Streak: variable from orange to brownish yellow.

Diaphaneity: opaque, thin fragment translucent.

Cleavage: {010} perfect, and {100} distincts.

Fracture: uneven. Brittle.

SG: 3.3-4.3.

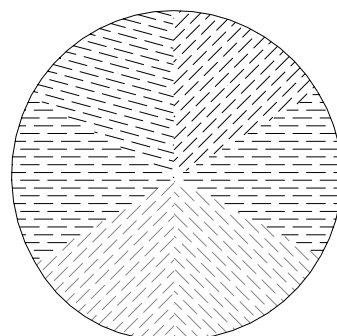
H: 5-5½.

Optics;  $\alpha$ :2.260,  $\beta$ :2.391,  $\gamma$ :2.398.

Birefringence: 0.138.  $\ominus$ .

Found: widespread.

**goethite as inclusions**; it occurs in plagioclase as inclusions, which cause the sunstone varieties, and as



*star quartz  
with fine  
oriented  
goethite  
needles*

needles in quartz or star quartz, spinel, and epidote.

**goethite quartz**; yellow and orange quartz containing fibers and crystals of goethite. Also called star quartz.

**Goiás**; location of a small diamond mine in state Goiás, Brazil.

**Goiás Diamond**; a rough diamond of 600 cts, found in 1906 in Verissimo River, State of Goyaz, Brazil. One of its cleavage fragments was cut into an 80 cts, brilliant and the others together weighed 130.00 cts, Also spelled Goyaz Diamond.

**Gokhran**; location of a diamond deposit in the Russian Federation, CIS.

**Golconda**; Golconda (now Hyderabad) mythical capital of Indian diamonds – but it was never a production center. The deposit is located to Hyderabad which is a part in the State of Andhra Pradesh, India. Location of an ancient (about 800 BC) alluvial diamond mines between the Godavari and the Krishna River in the south of former kingdom of Golconda, where the, Regent, Great Mogul, Tavernier Blue, and other world

famous diamond were found.

**Golconda;** an old color name sometimes used for highly transparent, colorless diamond, or with slightly bluish tint.

**Golconda;** a city in India for Indian diamonds trading.

**Golconda Diamond;** a fine, emerald-cut diamond of 30 cts, from India. It was purchased by R. J. Reynolds in 1960.

**Golconda "D" Diamond;** a brilliant-cut diamond of 47.29 cts, from Golconda, India. No further information available.

**Golconda diamond;** any diamond from Golconda, India.

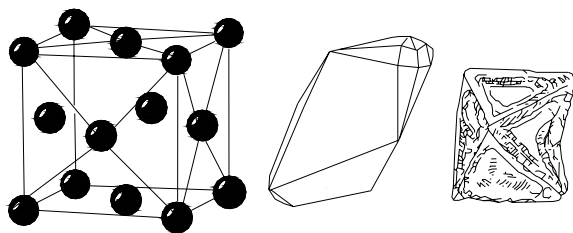
**Golconde Doré;** a golden colored, emerald-cut diamond of 95.40 cts, from India. It was recut by Asscher of Amsterdam from its original 130.00 cts, having been taken from the Mogul's treasures, when Dehli was sacked in 1739 by Persian invaders Nadir Shah, it was later handed down to the Sultan of the Ottoman Empire (Turkey). In 1909 Mustafa Kemal Atatürk, sold the diamond. In 1962 it was purchased by the Australian jewelers Dunklings. Also spelled Golconde Doré or Golconda Doré.

**Golconda Doré;** → Golconda d'Or Diamond.

**golcondas;** a term applied to diamonds from Golconda, India.

**Golconde Doré;** → Golconda d'Or Diamond.

**gold;** a heavy, soft, yellow, ductile, precious metallic element used in jewelry mainly as a mount for gems, and for decorating in porcelain and pottery. Unalterable by moisture, heat and most corrosive agents, or free



gold structure and crystals

from liability or rust. Is unattached by most acids but dissolves in *aqua regia*. Chemical symbol: Au. Pure metallic gold is too soft for use in jewelry or coin, but as an alloy with copper, palladium, silver, or other metals, depending on the hardness and the desired color and intended use. The unit of purity or fineness of solid gold or an alloy used in jewelry expressed in Karat. In trade it is based on a scale of twenty-fourths, 24 karat means pure gold, 18 karat gold, etc. → Karat, carat, gold alloys.

System: cubic.

Formula: 4[Au]. Rarely pure, usually alloyed with silver.

Luster: metallic.

Colors: gold yellow, orange-red, silver white due to impurities.

Streak: same as color.

Diaphaneity: opaque.

Cleavage: none

Fracture: hackly. Malleable and ductile.

SG: 19.3.

H: 2½-3.

Found: widespread in quartz veins and stream deposits.

**gold alloys;** pure gold is too soft for use but as an alloy with various metal such as copper, silver, nickel, iron or other metals it s more useful. Gold alloys can assume many colors depending on their composition. The unit of fineness of solid gold or an alloy used in jewelry is expressed in Karats. In trade based on a scale of twenty-fourths, 24 (100%) karat means pure gold, 18 (75%) karat gold, 14 (58.50%), and 9 (37.50%). → Carat, karat.

**gold amalgam;** a plastic variety of native gold containing mercury. Found in Colombia.

**gold à quatre couleurs;** gold of 4 different shades sometimes 3 or 5 shades, used in jewelry. Usually those shades are green, gold, blue gold, red gold, and white gold.

**gold argentide;** synonym for electrum.

**gold assay balance;** balance for weighing gold.

**gold bearing;** same as gold pieces.

**gold bearing quartz;** nearly flawless rock crystal from gold-bearing gravels found in Mokelumne Hill, Calaveras county, California, USA. During the II, war was used as piezoelectric supply.

**gold beryl;** synonym for chrysoberyl. Not to be confused with golden beryl.

**gold chloride;** a red crystal of AuCl<sub>3</sub>, used in gold plating, in ceramics, in glass as gilding ruby glass.

**gold citrine;** gold-yellow colored citrine, sometimes is misnamed as gold-topaz. Also spelled gold quartz.

**Gold Coast;** → Ghana.

**gold coral;** → golden coral.

**gold color;** US term for minute gold particle.

**gold colour;** British term for minute gold particle.

**gold covered;** same as inaurate or covered with gold. Also called gold film.

**gold digger;** same as gold hatter.

**gold dust;** fine particles, flakes, or pellets of gold.

**Golden Age of Amber;** influence of Baltic amber during the Roman times was great and historians described Golden Age of Roman Empire.

**golden amber;** a term used in China for sherry or gold color amber from Thailand. In Chinese called Ching Peh.

**golden beryl;** a translucent, golden-yellow gem quality

of beryl (heliodor). Not to be confused with gold beryl. Also called golden emerald.

**golden coral;** a misleading term for a green-brown to greenish-black coral variety, which is partially coated with a gold sheen glue-like material to cover white spots on surface, when cut and polished. RI:1.55-1.57. SG:2.12 ( .10). The species from Hawaii is identified as *Geradia* and *Parazoanthus* and called *whip coral*. Also found in Tasmania, Australia.

**golden coral;** a misleading term used in USA as a standard for transparent, gold colored amber beads during the early 1900.

**Golden Dawn Diamond;** a diamond of 133 cts, found in Vaal River in South Africa in 1913. It weighed 61.50 cts, after cutting. The owner is Aga Khan.

**Golden Door Diamond;** a golden-yellow, shield-cut diamond of 104.95 ct from unknown origin. No further information available.

**golden emerald;** same as golden beryl.

**golden fancies;** full-bodied yellow diamonds are known as golden fancies, and other colors such as deep blues, pinks, ambers, etc. are called fancies.

**golden gem of the ages;** same as amber.

**Golden Hue;** a golden-yellow cushion-shaped diamond of 132.42 cts, probably from South Africa. Present owner unknown.

**golden jade;** same as hornbill ivory.

**Golden Maharaja Diamond;** an unusually golden-yellow color, pear-shaped diamond of 65.60 cts. Last sold in New York, USA in 1991.

**golden nugget;** same as gold nugget.

**golden one;** → Caciques of Guatavita.

**golden obsidian;** a variety of obsidian with iridescent effect caused by reflections from small inclusions, which is cut as beads and necklaces.

**Golden Pelican Diamond;** a golden colored, emerald-cut diamond of 64 cts. Named after Pelican Street (Pelikaanstraat), Antwerp, North Belgium. Present owner unknown.

**Golden Prague;** → Zlata Prata Diamond.

**golden quartz;** a hybrid term for a variety of milk quartz containing very small grains of native gold. Used as a gemstone, been cut cabochons.

**golden quartz;** a commercially misnomered citrine with the yellow color.

**golden quartz;** also misnomered as gold topaz.

**Golden Queen;** → Golden Willows Sapphire.

**golden sapphire;** yellow to yellowish-green sapphire.

**golden-star sapphire;** a term used for star sapphire of golden color from Khao Ploi Waen and Bank Kha Cha, Thailand.

**golden stone;** a green to greenish-yellow peridot. Not to be confused with goldstone.

**Golden Triolette Diamond;** same as Incomparable Diamond.

**golden vein;** a commercial term for pale colored limestone from Israel.

**Golden Willows Sapphire;** a golden-yellow sapphire rough of 322 cts, found in the Willows field, Anakie district, Australia (1952). After cutting the largest piece weighted 91.35 cts, it was known as Golden Queen.

**gold filled;** a composite layer of gold backed with a base metal (usually brass) and other articles.

**gold filled;** a composite consisting of gold plating and rolled with a backing of brass, in which the total thickness of the gold sheet is at least 1/20 of the overall thickness. → Rolled gold.

**gold film;** same as gold cover.

**gold fluss;** same as goldstone.

**gold flour;** finest gold particles or dust, which will float on water. Also called floury gold, float gold.

**gold foil;** pure gold beaten or rolled out into a very thin sheet (thicker than goldleaf).

**gold glass;** → goldstone.

**gold in quartz;** a gold-bearing vein of quartz milky white in color with included gold grains. Used as a gemstone, cut cabochons and plates. Also called gold matrix. → Golden quartz, gold quartz.

**gold in synthetic spinel;** → lapis lazuli imitation.

**gold in synthetic emerald;** → Biron hydrothermal synthetic emerald.

**gold jewelry;** an American term for jewelry made entirely or principally of pure gold.

**gold leaf;** very thin, bluish green by translucent light. Layers of gold manufactured by beating or rolling. Used for gilding or decorative purpose (thinner than gold foil). It can be beaten into leaves of 0.0001 to 0.005 mm thick, this being less than the 300 to 700 nm wavelength of light.

**gold lipped oyster;** a large oyster of genus of *Pinctada maxima*, which is fished from the tropical waters of Australia mainly for the shell proposal. This term used to the mantle of oyster due to protein in the environment of the food

**gold litharge;** same as red litharge.

**gold marble;** → Porto marble.

**gold matrix;** same as golden quartz or gold in quartz.

**gold nugget;** a more or less water worn lump of native gold that is deposited in a river or stream. Sometimes minute nuggets are set on brooch or finger rings. Also called nuggety gold, golden nugget.

**gold obsidian;** a variety of obsidian with golden iridescent effect caused by reflections from small spangly inclusions from Mexico, which are cut as beads and necklaces. Also called gold sheen obsidian.

**Gold of the North;** a term was used in the Near East for

amber from Baltic Sea.

**gold opal**; another term for fire opal that exhibits an overall sheen of golden yellow.

**gold pan**; same as gold washing pan.

**gold placer**; same as placer gold.

**gold powder**; same as float gold.

**gold quartz**; a variety of colorless milk quartz containing very small grains or fibers of native gold. Also called golden quartz, rarely gold matrix. Sometimes polished as a gem.

**gold ruby glass**; same as ruby glass.

**gold rush**; a sudden, large-scale and hasty movement of people into a region where gold has been discovered.

**gold sapphire**; a misleading term for lapis lazuli consisting of flecks of pyrites.

**gold sheen obsidian**; an obsidian containing numerous minute spangly inclusions from Mexico, which create shinning effects.

**gold shell**; another term for Abyssinian gold.

**gold silver**; gold containing silver.

**gold solder**; an alloy for uniting metals, usually composed of gold-silver-copper, or brass.

**gold stone**; → goldstone.

**goldstone**; → glass, aventurine.

**gold topaz**; a misnomer for heat-treated golden quartz.

**gold topaz**; a misleading term for naturally yellow-colored citrine.

**gold-tin purple**; a brown chemical composition used in the glass industry of ruby glass and coloring enamels and in painting porcelain.

**goldmanite**; a mineral of garnet group with the composition:  $\text{Ca}_3(\text{V,Al,Fe})_2(\text{SiO}_4)_3$  from the Laguna Uranium mining district, Mexico.

**goldstone**; a translucent reddish-brown glass paste containing soda-lime silica colored by copper oxide, which precipitates. Characterized by thin geometrical plates (triangular or hexagonal) of crystalline copper that exhibit bright reflections. Used as an imitation of sunstone or aventurine a variety of plagioclase feldspar or aventurine quartz. RI:1.53. SG:2.50-2.80. Not to be confused with golden stone. It is also manufactured in blue color. Also called gold fluss, aventurine glass, or sometimes gold glass.

**goldstone glaze**; → aventurine glazes.

**goleh-kasni**; a Farsi (Persian) term meaning dandelion. Turquoise of greenish color mostly bought by Afghans. → Turquoise classification in Iran.

**Golf of Persian**; → Persian Golf.

**gonad**; sexual part of oyster where nuclei are positioned in cultured pearl industries.

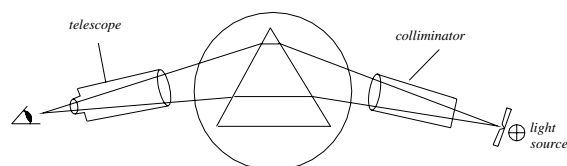
**gondite**; high grade regional metamorphic rock containing fine-grains of spessartite, quartz and apatite. Found in Gonds, Bombay, India. → Gondite series.

**gondite series**; a series of manganiferous metamorphic rocks belonging to Dharwar system of India. → Gondite.

**gongbi**; a Chinese term for carved jade in style of painting.

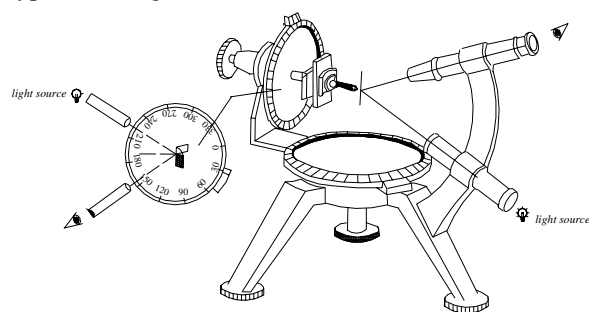
**Gong Gong**; location of a minor alluvial diamond deposit on the Vaal River, Cape province, South Africa.

**goniometer**; an instrument for measuring the angles



*compound goniometer*

between faces of crystals or gem facets. There are two types of goniometers: reflection and contact



*two circles reflection goniometer*

goniometer. The horizontal reflecting goniometer consists of a light source (so called collimator) that is channeled to the crystal holder. A radially rotateable telescope viewer having an eyepiece fitted with cross-hairs. The specimen being turned on a calibrated table, which is used to measure the index of refraction and dispersion of gemstones. Contact goniometer is a type of incorporating protractor at the center, of which is a revolving straight-edged moveable arm. Also known as crystal goniometer, table spectrometer, reflecting goniometer.

**goniometer, contact**; → contact goniometer.

**goniometer eyepiece**; an additional instrument set up in an ordinary monocular microscope, to which is fitted a goniometric ocular or eyepiece Ramsden.

**goniometer, hand**; → contact goniometer.

**goniometer ocular**; → goniometer, Huygenian ocular.

**good**; a term designating medium quality of drill diamonds.

**good**; a term designating used by Australian miners for sandstone with certain physical properties to find opal.



**good color;** same as gem color.

**Good Hope;** location of a small alluvial diamond mine in the Barkly West area, Cape Province, South Africa.

**Good Hope Diamond;** same as Star of Persia Diamond.

**Good Hope Mine;** location of emerald green grossular or tsavorite in California, USA.

**goodletite;** an Australian-New Zealand local term for a green matrix rock consisting of pyroxene or amphibole, in which rubies are embedded. It occurs in Tanzania and Carolina (USA).

**goods;** same as close goods. A commercial term for a lot, parcel, or shipment of diamonds without regard to quality, quantity, and composition. Goods are divided as *goods*, as in *rough goods* and *polished goods*.

**gooseberry stone;** a synonym for yellow-green varieties of grossularite.

**Gordon Diamond;** a pale yellow rough diamond of 30 cts, found in 1862-1866 in Belfast Land, South Africa. Its destiny after cutting is unknown.

**Gordon Orr Diamond;** an exceptional quality diamond of 62 cts, found in 1883 in India. It was cut into a 24.85 cts, brilliant. Present owner unknown.

**gorgulho;** a native term in Brazil for the diamond bearing clay in plateau deposits. → Cascalho.

**Gornyak Diamond;** a diamond of 44 cts, found in Sakha, Yakutia, the Russian Federation, CIS. Exhibited in the Russian Diamond Fund, Moscow.

**goshenite;** a colorless, white, pale-green, apple green, to bluish variety of beryl rich in sodium from Goshen, Massachusetts, USA. It has been used for a backing of green foil or paint to imitate emerald.

**Gospel Emerald, Russia;** numerous green emeralds worked as stud on the enameled gold, which covers a gospel. Now on display at Moscow Museum in Russia. It weighs together ca. 26 kg.

**gossan;** same as capping.

**gota de aceite;** a Spanish term for best clear quality of emerald.

**gouge;** a term used rarely by Australian miners in opal mining for a pointed piece of iron about 15cm, a screwdriver or something like that applied in an area near of opal pieces.

**gouge;** a term used by Australian miners for a small excavation of a hole by gouging in opal shaft.

**gouge;** a term used by Australian miners for excavation under the roof of opal shaft searching for a ridge of potch so that the drive can begin.

**gouger;** a term used by Australian miners for an opal miner who penetrates the soft ground or band.

**gouging;** a term applied to a working of a mine without any plane or system by which only the high grade mineral or ore is mined.

**gouging-pick;** a term used rarely by Australian miners in opal mining for a handpick or chisel pointed at both

ends, which can be used in a restrict space.

**goutte d' eau;** a French/Brazilian term literally means *drop of water*. An old term applied to water-worn pebbles of colorless topaz crystal in Brazilian. → Pingo d' agoa.

**goutte de sang;** a term applied to blood-red spinel.

**goutte de suif;** another term for tallow top cabochon.

**gouttes de suif;** a term applied to drop of tallow shaped tourmaline. → Nodules.

**gouverneurite;** a local term for brown magnesia-rich tourmaline from Gouverneur, New York, USA.

**Governador Valadares diamond;** same as Benedito Valadares diamond I, II, and III.

**Government Gold and Diamond Office (Sierra Leone);** a government department, which was responsible for issuing licenses, sale, exporting diamonds. Founded in 1959. Abbreviation: GGDO.

**gowan;** a term used for a granular soil resulting from the decomposition of granite, which consisting of quartz, feldspar and mica. Also called decayed granite, decomposed granite.

**Goyaz Diamond;** same as Goiás diamond.

**gozzan;** same as capping of gissan.

**gr;** abbreviation for grain.

**gr;** abbreviation for gram.

**gr.;** abbreviation for gram.

**grab lots;** one of the two buying plans gives to customers, the second one is called selection.

**Grace cut;** a trade term for fancy-cut diamond with 62 facets, which straight-edged, derived from heart shape. Designed in Israel.

**grade;** the quality or percentage of diamond weight of broken kimberlite, or alluvial material, or ore-mineral in effect, the metal content.

**grade;** the relative quantity or the percent of mineral or ore in a mine or an ore-body.

**grade;** having the same quality or value.

**grade B jade;** a commercial term for bleached jadeite. Same as B-jade.

**graded goods;** fashioned diamonds that have been graded of their *four C's* before sale to the retailer. → Grader.

**grader;** who separates polished diamonds into size, quality grades by weight, clarity, color, and cutting. → Four C's.

**grading;** → Four C's.

**grading lamp;** an instrument which simulates north daylight constructed by GIA, which also known as DiamondLite. Used for color grading of polished diamonds and colored gems in a neutral background. Also called diamond grading lamp.

**grading of diamonds;** it means the grading of polished diamond by color, clarity, cut and weight (carat),

popularly known as four C's. In diamond grading there are many divisions and subdivisions, into which diamonds may be color-graded. Also called grading standards. → Color grading of diamond, color grading, four C's.

**grading of pearl;** the pearls are graded for their color and shape. Color grading depends from white to silver and yellowish tinges. Such nuances as rosée, rose-pink, blue, green, yellow, brown, bronze, gunmetal, and black are called fancy colors. The shapes of pearls ranges from spherical, pear-shaped, which are known as drop pearls, button shape, which is one side flat used as ear-ring, stud and ear-stud, and baroque pearls (irregularly-shaped). Very small pearls are known as seed pearls. When a number are drilled and are of suitable size they are strung together and known as a Bombay bunch.

**grading standards (diamonds);** → grading of diamonds.

**graduated cut;** same as step cut.

**Graduate Gemologist;** one, who has successfully passed the course and examinations of the Gemological Institute of America. Abbreviation: GG.

**graduated necklace strings of gemstone;** a number of drilled beads gradually increasing in size toward a large central bead (graduated), suitable for a necklet and strung together. Necklace strings are made of many gem materials also in pearl, coral, jet, amber, ivory, shell. Necklace consisting beads all of one size are known as uniform.

**graduated necklace strings (pearl);** necklaces consisting only from pearl beads, which are all round or nearly round, of one size (uniform) or graduated diameter.

**Graff Imperial Blue Diamond;** a fancy-blue, flawless, pear-shaped diamond of 39.81 cts, cut from a 101.50 cts, rough stone from Guinea. Present owner unknown.

**graft tissue (cultured pearls);** non-nucleated cultured pearl is produced by inserting a graft tissue of an oyster into the gonads (sex organ) of the mussel. The graft tissue are cut from the mantle of a oyster in same technique as for normal culture pearl. The non-nucleated cultured pearls are baroque in shape and pale colored. → Non-nucleated cultured pearl.

**grain;** a small unit of weight equal to 50 milligrams or ¼ metric carat. Also called metric grain. → Carat.

**grain;** mineral particles in rock.

**grain;** a small hard seed.

**grain;** small, hard fragments of sand, gold, etc.

**grain;** state of crystallization.

**grain;** a second direction of splitting.

**grain;** a trade term for cleavage direction of a gem or mineral.

**grain;** a cleavage direction of diamond parallel to the

four octahedral faces. In the diamond industry, when the term used, it refers to a polishing direction.

**grain;** a unit of weight for pearl equal to ¼ or 0.25 metric carat.

**grain;** a pattern of color flashes such as harlequin, triangles, bands, etc. seen in opals.

**grain;** sometimes misnomerly *carat grain* or *pearl grain* is used.

**grain;** a term used by Australian miners for particles pattern on the opal face.

**grain center;** spot or a minute location of concentrated crystal structure a deformation in a diamond.

**grain (diamond);** a small unit of weight equal ¼ metric cts, used for rough diamond.

**grain (gold);** a unit of weight for precious metals, such as 1 ounce troy = 480 grains, 1 tola=0.375 ounce troy=180 grains.

**grain (gold);** gold particles become granular shape by heating.

**grain grade;** → grain.

**grain line;** same as twinning line. → Growth line, knot lines, graining.

**grain marks;** same as twinning line. → Growth line, knot lines, graining.

**grain marks;** scratches or lines on the facet of a cut gemstone due to imperfect polishing.

**grain (pearl);** a small unit of weight equal to ¼ metric cts, used for pearl weighing.

**grain shape;** same as particle shape.

**grain size;** same as particle size or granularity. An average size of the grain of crystals in rock or metal.

**grain size;** the grain-size is expressed by such term as fine-, medium-, or coarse-grained, phanocrystalline, micro-crystalline, etc.

**grain stone;** a term used for a mud-free, grain-carbonate sedimentary rock.

**grainer;** diamonds, which weigh a fourth of a carat or a diamond of one grain in weight is a fourth of a carat.

**graining;** a type of twinning, which is usually internally visible as phantom parallel lines and sometimes can be seen like polishing lines through the pavilion of brilliant-cut diamond but not whitish, colored or reflected. These lines cannot be removed by recutting or polishing. External blemishes may also be visible. Also called grain lines, growth line, knot lines, twinning wisp, and twinning lines. → Inclusion types.

**grain lines;** same as graining.

**grainy texture;** mineral particles in rock being described on basis of grain type.

**gram;** a unit of weight in the metric system is equal to the weight of a cubic centimeter of water at 4° C. Also spelled gramme. Abbreviation is gr. or gr.

**grammatite;** a undesirable synonym for tremolite.

**gramme;** → gram.

**grammite;** a term used as a synonym for graphic jasper.

**Grampian Highlands;** a local term for cairngorm bearing district in Scotland.

**granada;** a Spanish term for garnet.

**grand antique marble;** black marbles from the North of Pas de Calais, France. → Noir français, noir belge.

**granat;** a German term for garnet.

**Grand Coeur d'Afrique Diamond;** an internally flawless, white color, rough diamond of 278 cts, found in 1982 in Guinea. It was cut into three stones, one of them is a heart-shaped brilliant of 70.03 cts. A heart-shaped of 25.22 cts, and the smaller is a marquise-shapes of 14.25 cts.,

**Grand Duke of Tuscany Diamond;** same as Florentine Diamond.

**Grand Mazarin Diamond;** a yellowish, square-cut Diamond of ≈ 19.10 cts, from the French Crown Jewels. It was among Mazarin Diamonds, which were recovered after the robbery of the Garde Meuble in 1792. It is now on display at the Louver Museum in Paris, France.

**grande antique marble;** black marble from Departments of North, France is known as grande antique marble.

**Grande Condé;** same as Grande Condé diamond.

**Grande Condé Diamond, Le;** a light pink, pear-shaped diamond of 9.01 cts, was awarded to Prince Condé, when he became national hero during Thirty Years' War, it was bequeathed to the French government in 1643. Also called Chantilly Pink diamond now it remain in the Musée Condé in Chantilly. Also called Le Grande Condé diamond, Grande Condé, Condé diamond.

**grandidierite;** a massive mineral suitable for collectors and cut as gems.

System: Orthorhombic.

Formula:  $4[(Mg,Fe)Al_3(BO_4)(SiO_4)O]$ .

Luster: vitreous.

Colors: greenish-blue.

Streak: same as color.

Diaphaneity: translucent.

Cleavage: {100} perfect, and {010} distincts.

Fracture: uneven. Brittle.

SG: 2.976-3.000.

H: 7½.

Optics:  $\alpha$ : 1.590-1.602,  $\beta$ : 1.616-1.634,  $\gamma$ : 1.623-1.64.

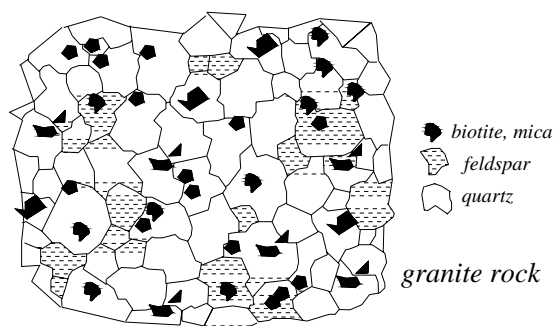
Birefringence: 0.039-0.050.  $\ominus$ .

Found in Malagasy, Norway, Zambia, Russia, and New Zealand.

**grandidierite pleochroism;** strongly pleochroic: deep blue-green, colorless and deep green.

**grandite;** a term applied to garnet, the intermediate chemical composition between grossular and andradite.

**granite;** a coarse-grained plutonic igneous rock



principally containing megascopic quartz, alkali-feldspar and plagioclase, and mica. Sometimes cut and polished as dimension stone.

**granite diorite;** same as granodiorite.

**granite, graphic;** → graphic granite.

**granite greisen;** a plutonic rock of the granite clan with a coarse-grained appearance, consisting of quartz, orthoclase, microcline, oligoclase, and mica.

**granite jewelry;** cut cylinder or prism articles made of pink or gray granite rock, used in a bracelet.

**granite layer;** → sal, sail.

**granites layer;** → sal, sail.

**granitic;** resembling granite or holocrystalline texture.

**granitic;** consisting of, pertaining to granite.

**granite worker;** → stonemason.

**granitization;** a term used to metamorphic process or group of processes by which a rock is converted into a granite rock by the entry and exit of material.

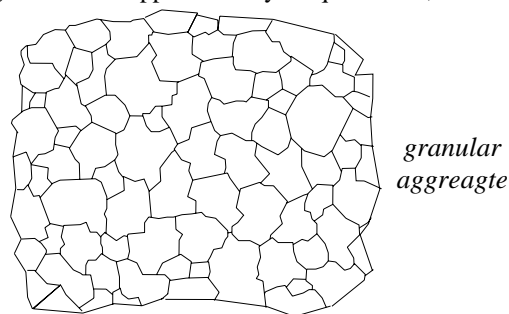
**Granny's chips;** a term used by British Royal Family to refer to Cullinan III and IV.

**granodiorite;** a visibly coarse-grained plutonic rock containing quartz, alkali-feldspar, plagioclase, and dark-colored minerals such as biotite, hornblende, and pyroxene. → Diorite.

**Grand Sancy;** same as Sancy Diamond.

**Gran Sabana;** location of an alluvial diamond deposit in Venezuela.

**granular;** texture of a rock composed of crystalline grains of approximately equal size, resembling



crystalline grains of approximately equal size. Also called granitic texture.

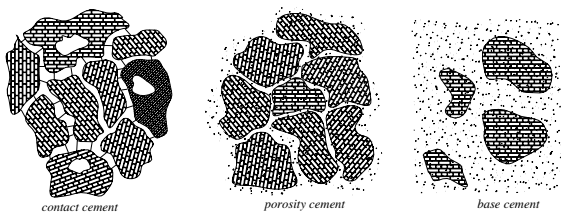
**granular chert;** a compact, homogeneous, hard to soft, dull to glimmering luster of cryptocrystalline quartz. Composed as granulars or druses distinguish by uneven or rough fracture surface. Synonym for crystalline chert.

**granular crystalline;** a rock composed as fine-crystal granulars.

**granular fracture;** an irregular surface characterized by a rough, granite-like appearance.

**granular gypsum;** gypsum composed as granulars.

**granularity;** the feature of rock texture relating to the size of grains or crystals which expressed by the terms



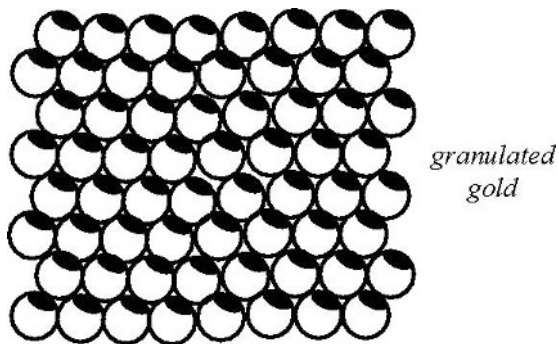
granular growth of rocks of carbonates, silicate, clays and other cemented materials. After Smirnov

as fine-, medium-, or coarse-grained, phano-crystalline, microcrystalline, etc.

**granular quartz;** same as quartzite.

**granular structure;** a type of structure, in which the mineral shows crystalline grains, but not external crystal faces such as marble or quartzite.

**granulated gold;** minute sphere or grains of gold used as decoration on the surface of jewel articles made by



soldering the beads on to the metal base.

**granulite;** a high grade regional metamorphic rock consisting of even-sized granular minerals. Containing quartz, feldspar, pyroxene, and garnet. In French it means a muscovite granite. Also called leptite in Scandinavia.

**granulite;** a term applied to a fine-grained muscovite-bearing granite.

**granulite;** a sedimentary rock composed of sand-sized aggregates, which is formed of lapilli or of oolitic grains (also nonclastic).

**granulitic;** a term applied to a composed of, or pertaining to granulite.

**granulitic;** a term used for a texture of a micro-crystalline, xenomorphic igneous rock. Also called microgranular, fine-granular, euritic, intergranular.

**granulose;** composed of, or pertaining to granulite texture due to the presence of granular minerals.

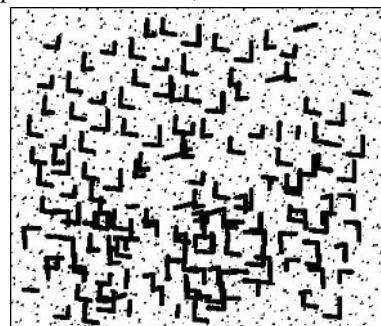
**grão;** a Brazilian weight unit for gemstones, equivalent of about 3/4 cts.

**Grão Mogol;** formerly a diamond producing district in Minas-Gerais, Brazil.

**grape formation;** synonym for botryoidal. clusterite.

**grapestone;** an aggregate style of pellets form botryoidal clusters formed of smooth, nodular, calcareous deposits on cavern walls. Also called botryoidal, clusterite, grape formation, botryoidal stalactite. Also spelled grape stone.

**graphic granite;** a variety of granite (pegmatite) characterized by intergrowth of two minerals quartz and feldspar or microcline, which has the appearance of



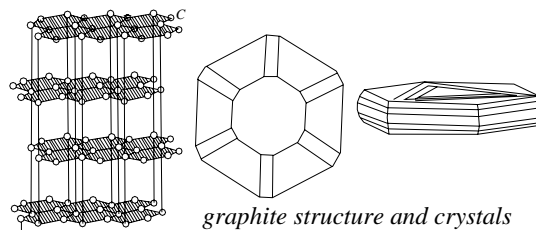
graphic granite

cuneiform or Semitic writing on a background of feldspar. Also called Hebraic granite, Hebrew granite, Hebrew stone, runite.

**graphic intergrowth;** an intergrowth of crystals such as feldspars and quartz (schorl and quartz), which formed a type of poikilitic texture in which the large crystals have fairly regular geometric outline and or orientation such a cuneiform characters. Also called hieroglyphics intergrowth.

**grape stone;** another spelling for grapestone.

**graphite;** a polymorphous (or allotropic) mineral with



graphite structure and crystals

diamond, chaoite, and lonsdaleite. An inclusion mineral

in diamond. Having a greasy feel. Also called black lead, plumbago.

System: hexagonalic.

Formula: 4[C].

Luster: metallic, dull, and earthy.

Colors: iron black to steel gray.

Streak: same as color.

Diaphaneity: opaque.

Cleavage: {0001} perfect, easy.

Fracture: flexible, inelastic. Greasy feel. Sectile.

SG: 2.10-2.255.

H: 1-2.

Optics;  $\omega$ : 1.93-2.07.

Found: widespread.

**graphite as inclusions**; it is found in jades, rubies, sapphires and as plates in spinels.

**Grasfontein**; location of important alluvial diamond deposit in Transvaal Province, South Africa.

**Graspan**; location of small alluvial diamond deposit in Transvaal Province, South Africa.

**grass**; a term used by Australian miners for an opal with thin units and lineal striation similar to straw pattern. Also called grass opal.

**grass opal**; an opal phytolith apart from grass.

**grass opal**; another term for grass.

**graticule**; a cell, or network of fine wire (cross-hair), in the eye-piece of a microscope, used to locate or determinate object in the field of view. Also called reticule.

**grating spectroscope**; → diffraction grating.

**grave jade**; same as tomb jade.

**grave mine**; same as placer mine. The extraction and concentration of gold or heavy metal from sand.

**gravel**; unconsolidated or loose grains of small stones and pebbles, accumulated by water worn particles larger than sand between 2 mm and 4 mm in diameter. In Scotland termed as channer.

**gravel deposit**; an alluvial deposit or placer.

**gravels diamondiferous**; → diamond-bearing gravels, diamondiferous.

**gravelstone**; same as pebble

**gravitation**; → gravity.

**gravity**; the force of nature which manifest itself as a mutual attraction in the universe between masses and whose mathematical expression was first given by Newton.

**gravity attraction**; same as force of gravity or pull of gravity.

**gravity concentration**; separating grains of diamonds from another minerals by a virtue of the differences in density of various minerals and various reactions to the separating agent, in South Africa rotary washing machine pans are used.

**gravity separation**; same as gravity sorting.

**gravity sorting**; separation of roughly sized mineral grains because of differences between specific gravity of them, while lighter grains are washed away. Also called gravity separation.

**gravity, specific**; → specific gravity.

**gravure**; an intaglio process on gemstone, metal and other materials.

**gray**; a color grade of gemstones in color nomenclature system. Also spelled grey.

**gray**; a term used by Australian miners for poor opal, which occurs in white or grayish forms.

**gray antimony**; same as stibnite.

**grayband**; same as flagstone.

**gray-blue**; a color, which respectively is midway between gray and blue.

**gray diamond**; a natural gray or fancy color diamond.

**gray gold**; an alloy of gold containing 15%-20% iron and silver.

**gray-green**; a color, which respectively is midway between gray and green.

**gray hematite**; same as specularite.

**gray lead ore**; same as gray pyromorphite.

**gray-purple**; a color, which respectively is midway between gray and purple.

**grayish blue**; a color, which respectively is more grayish than vivid blue.

**grayish green**; a color, which respectively is more grayish than vivid green.

**grayish manganese ore**; same as manganite.

**grayish purple**; a color, which respectively is more grayish than vivid purple.

**gray pyromorphite**; pyromorphite with gray color. Also called gray lead ore.

**gray sapphire**; an asteriated, gray sapphire.

**gray zircon**; same as zirconite.

**grease belt**; → grease table.

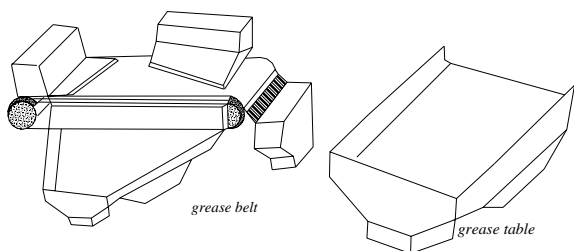
**greaser**; a mechanism pulsator, which separates using a rapid up-and-down motion of minerals. Also called jigger, chute conveyor, pan conveyor.

**grease stone**; a dense gray-green rock similar to basalt which containing feldspar and augite.

**grease stone**; a synonym for steatite.

**grease table**; a large, sloping grease table with steps to facilitate the continuous separation of diamonds or other minerals from other heavy minerals, ores, rocks and gravels, which occurs in some mines. This process is based on the fact that diamond surfaces are preferentially grease or oil wettable (none water-wettable), diamond sticks to grease. A continuously rotating belt has a layer of grease applied to it at one end, and this is scraped off at the other end. While the minerals, or gravels with wettable surface are washed

away. The recovered grease is then melted to release



*grease belt and grease table*

the diamonds. → Petroleum jelly, vaseline.

**greasy**; same as greasy luster.

**greasy-back**; a term used by Australian miners for sandstone above opal dirt, when water penetrated it this type of sandstone slip away so that may fall in opal dirt.

**greasy-back**; an informal term used by Australian miners for an old miner who has been a long time in the opal mining fields.

**greasy gold**; synonym for fine gold.

**greasy luster**; luster of mineral resembling that of oily glass such as nephelite, nephrite, soapstone and quartz.

**greasy quartz**; same as milky quartz with a greasy luster.

**greasy stone**; synonym for steatite.

**Great Beginning Diamond**; a rough diamond of 135.12 cts, from Mir Pipe in Sakha, the Russian Federation, CIS. It is now on display at the Museum in Moscow.

**Great Blue Diamond**; same as Wittelsbacher Diamond.

**Great Brazilian Diamond**; a diamond of 130 cts, belonged to the Crown Jewels of Portugal. Present owner unknown.

**Great Chrysanthemum Diamond**; a pale honey color to golden-brown, rough diamond of 198.28 cts, found in 1963, in South Africa. Purchased by Julius Cohen, New York, USA. it was cut into a pear-shaped brilliant with 189 facets of 104.15 cts.,

**great conch**; one of the largest of the univalve mollusks of the *Strombus gigas*, the shell, of which may measure 30 cm in diameter or 3 Kg in weight. Light orangey-red or pink pearls obtained from them. → Conch giant.

**Great Dyke (chalcedony)**; dark-green chalcedony (colored by chromium and nickel) from western slope of the Great Dyke in central Zimbabwe (formerly Rhodesia).

**Great Exhibition**; a public exhibition of The Koh-i-Nûr Diamond in Hyde Park in 1851, London, England.

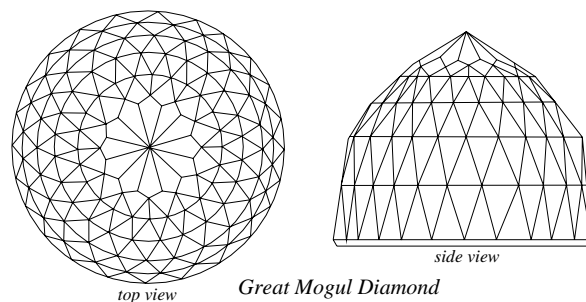
**Great Globe, the**; the famous glob made of gold and paved in gemstones of various colors to represent seas and lands. It was manufactured in Iran during Nasser-al-Din Shah (1874-1875 of 1291 Hegra) reign, 108 cm high, 45 cm in diameter with more than 51.000 pieces

of gemstones. Now on display at Collection of the National Jewel Treasury of Iran, Tehran.

**Great Harry Diamond**; a lozenge-shaped diamond belonged to King Henry II of France (1519-1559). Inherited by his son Francis II, who presented it to his wife, Mary Queen of Scots, then became part of Scottish Crown Jewels, and is believed she named it in memory of her late father-in-law. Signed as Mazarin IX with 15.27 cts.,

**Great Mogul**; an empire founded in India by Barber the Mongol who conquered in the 16<sup>th</sup> Century to 1857. Also called Mogul Dynasty.

**Great Mogul Diamond**; third biggest gem diamond from India, which saw at the Court of Aurangzib in 1665, weighing 280 old cts, in rose-cut and a faint bluish tinge, when seen by Tavernier (1605-1689). It is said the Great Mogul weighed in rough 787.50 cts, in rough. It was brought to Iran by Nadir shah (1688-1747) Persian ruler. It is believed that the Koh-i-Nûr diamond or Orloff may be the same stone. The stone



was named after Shah Jehan, who built the Taj Mahal in Agra. Also called Mogul Diamond. → Great Table Diamond.

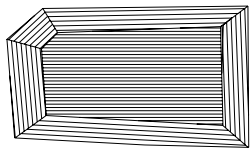
**Great Mogul Emerald**; an emerald of 362.45 cts, mounted in a diamond pendant. Once belonged to an Indian Family.

**Great Southern Cross Pearls**; consists of nine large pearls, natural units in the form of a cross. It was found in a pearl oyster in 1886 in Western Australia. It is believed that originally there were only eight pearls and later the ninth was added to make it look like a cross. Now it is in possession of the Vatican. Also called Southern Cross Pearl.

**Great Star of Africa Diamond**; same as Cullinan I Diamond.

**Great Table Diamond**; a legendary pale pink, table-cut shape diamond of 250 old cts, from India was seen by Jean Baptiste Tavernier at Golconda in 1642 and it become known as the Great Table. It is believed to have been taken to Persia by Nadir Shah in 1791. It is suggested that the Darya-i-Nûr in the Tehran treasury is indeed the Great Table or rather a part of it and another

part is The Nûr-ul-Ain Diamond. Also called White Tavernier Diamond. → Darya-i-Nûr diamond, Nûr-ul-Ain Diamond.



Great Table. Redrawn from author

**great top shell;** a conical spiral shells of the *trochus* with beautiful nacre, which is used for ornaments and small articles.

**Great White Diamond;** a diamond of 469 cts, in rough found in Jagersfontein, South Africa in 1884. It was cut in Amsterdam into two stones, with the larger, an oval brilliant of 185 cts, and the smaller a circular brilliant of 20 cts, The larger stone was sold about 1900 to Nizam of Hyderabad, India. Known as Imperial White Diamond, Victoria White Diamond, or Victoria Diamond. Also called Imperial Diamond, Jacob (I) Diamond.

**Greater Bear Diamond;** a rough diamond of 114.37 cts, found in Mir Pipe in Sakha, the Russian Federation, CIS. It is now on display at the Museum in Moscow.

**Greater Namaqualand;** same as Namaqualand.

**green agate;** same as zonochlorite.

**green agate;** a misnomer for chrysoprase.

**green agate;** a gray agate that has been colored green.

**green agate;** same as prase.

**green amber;** a variety of opaque amber with vast number of microscopic gas bubble inclusions, which also caused variations of color and brittleness. Also glauconite is responsible for green and greenish-blue colors.

**green beryl;** light-green or pale-green gem variety of beryl, as distinguished from the full-green or emerald and the light-green aquamarine.

**green-blue;** a color, which respectively is midway between green and blue or blue green.

**green bolts;** a local term for an emerald and hiddenite deposit in North Carolina, USA.

**Green Brilliant Diamond;** an apple green, brilliant-cut diamond of 40 cts, reportedly been worn by the king of Saxony (1697-1733) as a bottom on his hat. Not to be confused with the Dresden Green Diamond.

**green carbonate of copper;** same as malachite.

**green chalcedony;** a term applied to naturally green chalcedony.

**green chalcedony;** a misleading term for chalcedony that has been artificially colored green.

**green chalcedony;** a misleading term for chrysoprase that has been artificially dyed.

**green chrome;** → green rouge.

**green copper carbonate;** same as malachite.

**green corundum;** a greenish variety of corundum which is frequently used as gemstone. Also called green hard

spar.

**green diamond;** naturally fancy-green color diamond can be found in yellowish-green, olive-green, apple-green, or green, which is rare. Pale green diamonds are mined in Sierra Leone, Africa. Artificial diamond can be changed to green by emanation of radium or exposure to its salt.

**Green Dresden Diamond;** same as Dresden Green Diamond.

**green ear;** a popular misleading term for ear-shaped freshwater pearls.

**green earth;** any green sedimentary soil generally containing glauconite, chlorite and celadonite from Verona, Italy.. Used as pigments and green basic dyes. Also called terra verde, terre verte, Veronese green, Verona green.

**green earth;** same as mountain green.

**greened amethyst;** a green synthetic quartz, which is colored pink by iron and grown in a reducing atmosphere. Frequently called praseolite.

**greened amethyst;** a commercial term for natural amethyst, which changes its color to pale or medium green by careful heat-treating. Also called prasiolite.

**green feldspar;** synonym for microcline or amazonite.

**green flash;** filled fractures of diamond shows interference by testing by rotation the stone into a position when the background seen bright, these flash effect can be seen in untreated fractures of stones. → Revealing fracture filled diamond.

**green foilback;** a kind of foil composed of one carat of fine gold, 10 carats of fine copper and six carats of silver. Also called foil back, green.

**green foil back;** another spelling for green foilback.

**green garnet;** green variety of andradite garnet, which is known as demantoid garnet.

**green garnet;** grossularite garnet also known as gooseberry garnet.

**green garnet;** a misleading term for green enstatite from South Africa.

**green garnet;** a green variety of uvarovite.

**green glass;** a misnomer for emerald green glass from Brighton, England. Used as imitation gem. Also called Brighthorn emerald.

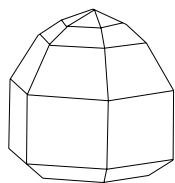
**green glass;** a green variety of glass containing chromic oxide. Used as imitation gem.

**green gold;** a greenish tinged gold alloy, which contains ca. 60%-75% gold, and 25%-40% silver, and small amount of zinc, cadmium and copper. Generally three types of green gold are made; *vert d'eau* or water gold, *vert de pré* or meadow gold, and *vert feuille* or leaf gold.

**green-gray;** a color, which respectively is midway between vivid green and gray.

**green hard spar**; same as green corundum.  
**green hornblende**; same as green hornblende.  
**greenish blue**; a color, which respectively is more green than blue.  
**greenish gray**; a color, which respectively is more green than gray.  
**greenish quartz**; greenish quartz which misnomerly called Gibsonville emerald. Used as imitation gem.  
**greenish yellow**; a color, which respectively is midway between yellow and green-yellow.  
**green jadeite**; a misnomer for chromium artificially made using green colored jadeite.  
**green jasper**; jasper, which is green due to its impurity of iron silicate, chromium salt or chlorate from Ural Mountains of Siberia, Russia. Used as an ornament and carved by Chinese as gems.  
**green john**; a massive green variety of fluorite. Named as an analogy to blue john.  
**green marble of Shrewsbury**; a deep-green variety of verdite from Shrewsbury in Vermont, USA, it is an ornamental, massive muscovite rock colored by fuchsite.  
**green marble**; a trade term for serpentine.  
**green microcline**; a misnomer for amazonite.  
**green microcline feldspar**; a misnomer for amazonite. Also misnomerly called amazonite jade.  
**green mineral**; a term applied to green carbonate of copper minerals.

**greenockite**; a yellow or orange hexagonal mineral of  $2[\text{CdS}]$ . Adamantine to resinous luster. Yellowish to brick-red streak. Conchoidal fracture. Optics;  $\omega$ :2.506,  $\epsilon$ :2.529. SG:4.82-4.90.



greenockite  
crystal

H:3-3½. Found in Scotland, California, New Jersey (USA), Greece, and Bolivia. A suitable mineral for collectors. It is

dimorphous with hawleyite. Also called cadmium blende, cadmium sulfide, cadmium ocher, cadmium yellow, xanthocroite.

**greenockite, synthetic**; orange-yellow single crystal of greenockite, which is grown synthetically. A suitable stone for collectors. RI:1.25. DG:4.90. H: 3½.

**green onyx**; a commercial misleading term for artificial green colored chalcedony.

**Greenough microscope**; a binocular microscope using paired objectives linked to inclined binocular eyepieces. → Microscope, Greenough binocular.

**greenovite**; a rose, reddish or pink-colored variety of sphene containing manganese.

**Green, Paddy**; who in 1878 found the Aladdin opal mine in Thacharinga Hills, Queensland, Australia.

**green pigeon emerald mine**; an emerald mine in South Africa.

**green quartz**; a misleading term in China for carved green fluorite.

**green quartz**; any green transparent variety of quartz.

**green quartzite**; a fine-grained pale green quartzite from Brazil and Africa, used as an ornament.

**green rouge**; a green abrasive powder of chromium-oxide used as a polishing agent for gemstones and metals, glasses, glazes, and enamels. Also called green chrome.

**green sand of Peru**; another term for atacamite.

**green sandstone**; sandstone with green color.

**green sapphire**; a misnomer for oriental emerald.

**green snail shell**; a genus of *turbo marmoratus* mollusks fished from the Australian coast used as pearl buttons and other articles. Also called turbo, green turban.

**green spinel**; another term for chlorospinel.

**green starstone**; another term for chlorastrolite used as a gemstone.

**green stone**; a misleading term for chlorastrolite. → Greenstone.

**greenstone**; another term for nephrite.

**greenstone**; another term for diorite an intrusive rock.

**greenstone**; sometimes used as an informal term for greenish gemstone such as chiastolite (variety of andalusite).

**greenstone**; a fuchsite (variety of green mica).

**greenstone**; a term used by quarryman's for freshly cut stone, containing water.

**greenstone**; a term used in Cornwall for blue elvan.

**queenstownite**; another term for darwinite.

**green tourmaline**; a green variety of tourmaline resembling to emeralds from South Africa. Also misnomerly called Brazilian emerald, African emerald.

**green turban**; same as green snail shell.

**green turquoise**; another term for Aztec stone.

**Green Vault, Dresden**; a museum in Dresden, Germany, which is called *Grüne Gewölbe*, which exhibits the gem collection of August II.

**green yellow**; a color, which respectively is midway between green-yellow and yellow.

**green zircon**; an olive-green color variety zircon of lower types from Sri Lanka which is known as beccarite. RI: 1.93-1.98, SG: 4.7.

**green zoisite**; another term for anyolite.

**Gregory Ruby Mine**; a ruby mine near Franklin State, USA. Also called Carter Ruby Mine, Holbrook Ruby Mines, Dale & Demoko's Mine, and Sheffield Corundum Mine.

**greigite**; a cubic mineral with spinel-like structure of  $\text{Fe}_3\text{S}_4$ . Light cream-white color. SG:4.08. →



Melinkovite.

**greisen**; a fine to coarse-grained granular plutonic rock, which is a pneumatolytically altered rock of granite. Composed largely of quartz, green alkali-mica, or lepidolite, topaz, and minor amounts of rutile, wolframite, cassiterite, tourmaline, and fluorite.

**grenat**; a French term for garnet.

**grenat noble**; a French term for almandine garnet.

**grenat Siriam**; an old French commercial term for any red garnet from Siriam, now Myanmar, (Burma).

**grenate**; another spelling for garnet.

**grenatite**; another term for staurolite or cross-stone.

**grenatite**; another term for leucite. It is often called white-garnet while it resembles. Also called amphigene, vesuvian, vesuvian garnet.

**grenz rays**; a German word for threshold. It means soft X-rays of long wavelength 0.5-1.0 nm, which reach up to SWUV radiation.

**grey**; alternate spelling of color gray.

**greyish**; alternate spelling of grayish.

**Grima Diamond**; a fine white, pear-shaped diamond of 55.91 cts, was purchased by Andrew Grima in 1972, in Geneva, Switzerland.

**Grimaldi's theories of light**; theory of diffraction of light.

**grinder**; one who grinds cutting tools.

**grinder**; any of various machine used for grinding, normally rotated by force of helical water currents in a stream.

**grinding**; the final stages in the preparation of diamonds and other colored gemstones are polishing and grinding. The flat surfaces or facets on a rotating wheel or scaife are charged with diamond powder.

**grinding**; comminution of minerals by wet or dry methods, generally in rod, ball, or pebbles mills.

**grinding and polishing**; same as grinding.

**grinding fluid**; any cutting fluid that is used in grinding.

**grinding machine**; an electro-mechanical machine, on which a grinding disk wheel is mounted.

**grinding mineral liberation**; liberation of minerals due to grinding.

**grinding pebbles**; gravels or pebbles used for grinding in mills, etc. Usually are compounds of quartz, chert or other minerals to avoid contamination with iron.

**grinding plate**; a rotated disk of steel or iron used to grind or polish ore or plate glass.

**grindings**; synonym for cutting.

**grinding wheel**; a rotated grinding disk wheel of steel or iron used to grind or polish ore or plate glass.

**grindstone**; a circular block of natural stone or composite abrasive, which is rotated and used for sharpening, grinding, etc. Also called millstone.

**griotte d'Italia marble**; a misleading French term for

marble of griotte marble.

**griotte marble**; a French term for morello cherry, applied to the marble of fine-grained, brecciated limestone of dark red color and often variegated with small dashes and spots or streaks of white or brown. Used as an ornamental stone.

**Griqualand West**; location of alluvial diamond mining in Cape Province, South Africa.

**Griqualand West Diamond Mining Co.**; a diamond mining corporation in South Africa, controlled by De Beers Consolidated Mines Ltd.

**griquaite**; named after Griqualand, South West Africa. A coarse-grained intergrowth of augite pyroxene (diopside) and garnet rock that may or not may contain olivine or phlogopite, occurs as nodules xenoliths in Kimberlite pipes and dikes. griquaite. Also called garnet pyroxenite. Same as griquaite.

**griquaite nodular**; → griquaite.

**griqualandite**; a variety of yellow silicified crocidolite, which appears in parallel sheets in tiger's-eye. Occurs in Griqualand, South Africa.

**Griquatown**; location of silicified crocidolite, which has been known as tiger's-eye and hawk's-eye, found near Griquatown, South Africa.

**Griquas**; first time discovered diamond in the interior of South Africa.

**grisaille**; a French term meaning gray shading. A decorative method used on pottery of vases, etc., where different shades of gray were used.

**grit**; a coarse-grained sandstone powder used for grindstones.

**grit (diamond)**; a synonym for diamond powder suitable for polishing and industrial uses. Also called gritstone. → Micro-diamonds.

**gritrock**; an old term for gritstone.

**gritstone**; same as grit. Also called gritrock.

**gritting**; to give a smooth surface on blocks of marble, or other natural stones other than rubbing. It is accomplished with aluminum oxide, silicon carbide or other material.

**gritty**; resembling grit.

**grizzley**; same as grizzly.

**grizzly**; screens of 1½, 2, and 5 inch, which is used for sorting blue-ground at the diamond mines. Also spelled grizzley.

**Grodzinski indentation hardness test**; a micro-indentation test similar to the Knoop indentation hardness test but with double-cone indenter developed by Grodzinski. → Knoop indentation hardness test.

**Grootdoorns**; location of a small alluvial diamond mine in Transvaal Province, South Africa.

**Grootlaagte**; location of a small alluvial diamond mine in Transvaal Province, South Africa.

**Grootpoort;** location of a small alluvial diamond mine in Transvaal Province, South Africa.

**grosspydite;** an igneous rock containing grossular garnet, pyroxene, plagioclase, kyanite, spinel or olivine. It is named from the initial letters of grossular, pyroxene, and disthene (kyanite).

**grossular garnet;** a variety of garnet mineral normally characterized by a green color. The orange to orange-brown color is called *hessonite* (essonite). The green color is known as grossularite (green gooseberry) or gooseberry stone. Massive variety of grossularite is named as *hydrogrossularite*. The other green color variety is *tsavorite* (also spelled tsavolite) from East Africa. The golden-yellow is called cinnamon stone. The pink or purple colors are known as landerite, rosolite, and xalostocite. *Succinite* is an amber-colored variety of grossular. The reddish-brown variety misnomerly called *hyacinth*. The reddish-orange variety is erroneously named *jacinth*. The massive pale green variety of grossular from Transvaal, South Africa is known incorrectly as *Transvaal jade* or *African jade*. Some grossular are included, show oil streaks and sometimes are called *treacle*. A *birthstone* for January.  
→ Garnet.

System: cubic.

Formula:  $8[\text{Ca}_3\text{Al}_2(\text{SiO}_4)_3]$ .

Luster: vitreous to resinous.

Colors: colorless (when pure), yellowish, gray, yellow, green, brown, pink, red, and black.

Streak: white.

Diaphaneity: transparent to opaque.

Cleavage: none.

Fracture: uneven to conchoidal. Brittle.

SG: 3.40-3.60.

H: 7-7½.

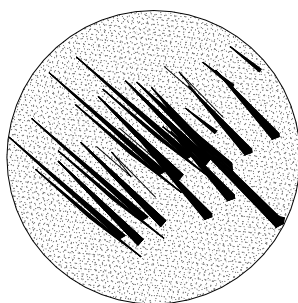
RI: 1.734-1.749.

Dispersion: 0.028.

Found: widespread.

**grossular-idocrase;** an intergrowth of grossular and idocrase, which occur in Pakistan, California, USA and South Africa.

**grossular inclusions;** in some grossular from Tanzania



*grossular with cedar tube inclusions from Tanzania*

are seen cedar-like tube inclusions. → Grossular.

**grossularite;** → grossular.

**grossular, massive;** a massive green variety of grossular found in Buffelsfontein, South Africa has been misnomered as Transvaal jade. Sometimes has been found in pink to rose-red. Cut as beads and cabochons. Massive white grossular found in Myanmar (former Burma), and carved in China.

**grossularoid;** mineral with structures similar to that of garnet, such as brezellite, and griphite.

**grothite;** synonym for sphene.

**Grotrian diagram;** synonym for energy level diagram.

**ground;** synonym for foundation, or foundation ground.

**ground color;** a term used by Australian miners for foundation color, usually a fine milky opal to provide contrast for the foundation opal color.

**groundmass;** in igneous rock, relatively fine-grained crystalline body, in which large crystals of phenocryst of another stage are forming. Synonym for matrix.

**ground state level;** → inverted population level.

**group;** a rock unit. A group includes two or more contiguous or associated formations of lithographic features.

**group of gems;** sometimes found the term group, which means two or more chemically related gem mineral species with the same structure and physical properties such as feldspars group or garnets group.

**groups;** a subdivision of minerals into a series.

**group silicate;** another term for sorosilicate, a silicate structure characterized by the linkage of two  $\text{SiO}_4$  tetrahedra sharing one oxygen to form  $\text{Si}_2\text{O}_7^{6-}$ , with a Si:O ratio of 2:7. An example is hemimorphite.

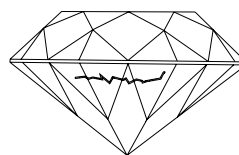
**grown old;** a term used for some opals when lost its water.

**grown together;** same as intergrowth.

**growth chicken tracks;** → chicken tracks.

**growth hillocks;** → tourmaline growth hillocks.

**growth lines;** banding as light effect seen in synthetic or natural origin of corundum or sometimes within a



*growth lines seen on a brilliant-cut diamond*

diamond, parallel to the octahedral faces. Also called grain line, graining, knot line, twinning line, and internal graining. → Striae.

**growth markings (on diamond);** on the surface of some diamond crystals *markings* can be seen that are characteristic for this substance. On the octahedral faces, stone shows characteristic triangular depressions, reverse to the orientation of the crystal face, which is known as *trigons*. On the dodecahedral planes usually grooved parallel to the long direction of each face. On the cubes faces are square or rectangular depression at 45° angles to the edges of the crystal face. → Etch

features of crystals, natural.

**growth of quartz;** same as quartz crystallization or crystallization of quartz.

**growth steps;** → tourmaline growth steps.

**growth tube;** a term used for some thread-like cavities or channels which are formed as inclusions in some stones when tubes are filled with liquid and bubbles of gas. Also called tube.

**growth twin;** a twined crystal, which is developed during its formation by change in crystal structure during growth.

**growth zoning;** visible oriented internal growth in diamond may be straight, angular, or irregular in appearance.

**Grubstake Opal;** a fine precious opal pseudomorphous after wood is exhibited in the American Museum of Natural History in New York.

**grubstakes;** a term used by Australian miners for some who return to work only for short time to survive on.

**Grünes Gewölbe;** German term for Green Vault.

**Grupiara;** location of alluvial diamond-bearing deposits in Grupiara, Brazil.

**grupiáras;** a Brazilian term for diamond-bearing detritus formed on the spot also accumulated from waterborne deposits.

**gu;** a Chinese term for wine vessel made of bronze.

**guadalcanal cat's-eye;** a misleading term for shell cat's-eye or operculum.

**guan;** a Chinese term for carved tabular beads made of jade.

**guang;** a Chinese term for carved pouring vessel made of jade.

**Guaniamo;** location of small kimberlite diamonds deposits in Guaniamo in Quebrada Grande, Venezuela.

**guanine;** a crystalline, colorless, solid, water-soluble derivate of purin ( $C_5H_5ON_5$ ), which is responsible for the iridescence found in guano and occurs in the pancreas of animals. It is a decomposition product of yeast nucleic acid, actually it is a waste substance, which is secreted by the fish and is closely similar to uric acid. SG:1.6. Guanine is chemically inert, non-corrosive and non-soluble in neutral solvent. Used as essence d'orient for the interior and exterior coating of a glass bead to produce imitation pearls. → Essence d'orient.

**guanine essence;** same as fish scale essence.

**guanine 2-aminohypoxanthine;** → bleak fish.

**guard;** a former name for a long row necklace made of jet.

**guardian-angle stone;** a term used rarely by Australian miners for angle stone.

**guarnaccine garnet;** a commercial term for yellow red garnet or vermeille garnet. Also called guarnaccio.

**guarnaccio;** same as guarnaccine garnet.

**Guatavita Lagoon;** → Caciques of Guatavita.

**guest;** same as inclusion mineral, metasome, or trace mineral.

**guest mineral;** same as inclusion mineral, metasome, or trace mineral.

**Gübelin's jewelers' microscope;** the first spectroscope for gemological testing, which consists of a built-in adjustable source of illumination for both the specimen and the wavelength scale made by Gübelin in 1950, Switzerland.

**gueda stone;** a Sri Lankan (Ceylonese) term for inferior quality of sapphire stones, which have patches of milky-white or milky-yellow opalescence caused by network of usual rutile inclusions. Some of these stones are called *diesel* gueda, when they are heated to improve their appearance and color.

**guest;** a mineral introduced into and usually replacing a preexisting mineral, which grows in size at the expense of other mineral (the host or palosome). Also called metasome.

**guest;** any inclusion such as gas, liquid or hard substance included in a gemstone (the host or palosome).

**guest element;** a trace element replacing a preexisting common element in a mineral or a rock mineral.

**guest mineral;** a mineral grain formed by metasomatism. Also called metasome.

**guest mineral;** any included mineral in a gemstone (the host or palosome). Also called metasome.

**gui;** a Chinese term for a scepter in the form of a blade carved from jade. → Chinese ritual and symbol jades.

**gui be;** a Chinese term for a tablet adorned with disc carved from jade, used as worship celebration of the God of the Sun, moon and stars. → Chinese ritual and symbol jades.

**guide fossil;** any fossil, which has most characteristic potential value in identifying the age of the strata. Also called index fossil.

**guide mineral;** same as index mineral.

**guiding mineral;** same as index mineral.

**Guild, cutter;** a guild of all diamond cutters in the Netherlands.

**Guilds;** a periodical journal of American Gem Society.

**Guinea;** an alluvial diamond bearing areas of Guinea, West Africa. Formerly French Guinea. Mined by Association Pour la Recherche et L' Exploitation du Diamant et de L' Or. (ARETOR).

**Guinea diamonds;** → Guinea.

**Guinea Star Diamond;** a white, internally flawless, shield-cut diamond of 89.01 cts, one of three polished from 255.10 cts, rough stone found at the ARETOR Mine in 1986. The other two are a pear-shaped of 8.23

and a heart-shaped diamond of 5.03 cts.,

**Guise Diamond;** a white, fiery, flawless rectangular-cut diamond of 33.25 cts, once belonged to Duke of Guise. It was recut into 29.10 cts, in 1665. Stolen in 1792 from the French Royal treasury, but recovered. Current whereabouts unknown.

**Gulf of Mannar;** pearls from pearl oyster the genus *Pinctada* from Gulf of Mannar between Sri Lanka and India.

**gully raking;** a term used by Australian miners for going into old gullies in the hope to find some opal. This term is now replaced by noodling.

**gum;** an organic, viscid amorphous exudation from certain plants hardening on exposure to air, which may or may not be soluble in water. Dry form is hard and brittle. Used in the manufacture of varnishes, lacquers, and similar products. → Kauri resin.

**gum anime;** a recent fossil resin similar amber, sometimes containing plants and insects. → Copal, kauri gum.

**gum Arabic;** a fine yellow or white powder or lumps exuding from *Acacia senegal* plants hardening on exposure to air, soluble in water, coming from Sudan and Senegal, Africa. Used as adhesive and polishers. Also called acacia gum, Senegal gum.

**gum diggers;** copal diggers prefer large and clear pieces of copal resin, they polished such pieces or carved into ornaments by using the natural surfaces.

**gumanite;** other term for uranium ocher.

**gum copal;** → copal.

**gun-metal pearl;** a variety of black pearl, which resembles polished gun metal.

**gun-metal pearl;** a misleading term for simulant pearl from gun metal.

**guest elements;** same as trace elements.

**gujarati;** same as rajavaral.

**gutta percha;** a natural plastic obtained from *Dichopsis gutta* tree, which has a milky secretion rather similar to rubber. Used as jet imitation.

**Guyana;** some alluvial diamond deposits of good quality are mined in Guyana, South America. The first discovery was in 1890.

**Guyana diamonds;** → Guyana.

**gymnite;** same as dewelite.

**gymnosperms;** a major component of Baltic Sea amber produced by coniferous evergreen.

**Gympie gold;** a local term for reef gold from Gympie Eldorado Gold Mines, Queensland, Australia. A rare, natural and unique gold, which is spread on and into quartz specimen pieces, used as jewelry, cut as cabochons and ornamental stones.

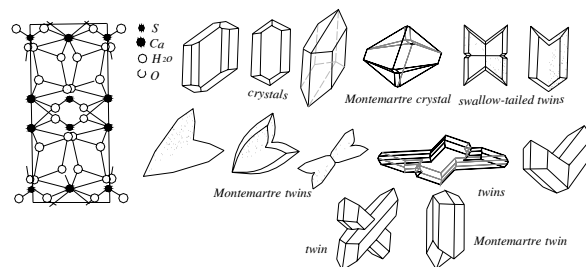
**gyou;** a Tibetan term for emerald.

**gyprock;** same as rock gypsum.

**gypsiferous;** same as gypsum bearing.

**gypsite;** an earthy variety of gypsum containing sand and grit, which occurs and is found in arid climate. Synonym for gypsum earth, earthy gypsum.

**gypsum;** a widely distributed, decorative, curio, and ornamental mineral. Varieties are *alabaster* (massive), *satin spar* (fibrous), and *selenite* (crystalline), *helictite*



*gypsum structure, crystals and twins*

a grotesque shaped variety. Twinned in *swallow-tailed* form. Some species exhibit moonlike-sheen caused by cleavages. Massive variety or alabaster is porous hence it takes color easily. In England some specimens of gypsum minerals are found in thick nodular beds, which are called *floors* or as lenticular masses known as *cakes*. The pink color alabaster from South Wales is named as *pink Welsh alabaster*. Also spelled gyp, gypsite, plaster stone, gyps, or plaster of Paris. See swallow-tail twin.

System: monoclinic. Often twinned in swallow-tailed forms.

Formula:  $4[\text{CaSO}_4 \cdot 2\text{H}_2\text{O}]$ .

Luster: subvitreous to pearly on cleavages.

Colors: colorless (selenite), yellowish, gray, brownish, greenish, bluish, reddish, white (when massive).

Streak: white.

Diaphaneity: transparent, translucent to opaque. Some crystals fluorescent and phosphorescent greenish white under ultraviolet light.

Cleavage: {010} perfect and easy, {100} distinct, and {011} distincts.

Fracture: splintery. Flexible but not elastic.

SG: 3.32-2.40.

H: 2. Scratched by fingernail.

Optics;  $\alpha$ : 1.5207,  $\beta$ : 1.5230,  $\gamma$ : 1.5299.

Birefringence: 0.010. ⊕.

Dispersion: 0.033.

Found: widespread.

**gypsum, alabaster;** → alabaster.

**gypsum cut;** it takes a good polish and is used as a decorative, curio, and ornamental mineral, the fibrous variety or satin spar cut as cabochon, beads, and slabs. Used for electrical lighting.

**gypsum, formation of;** gypsum minerals fills veins in

rock formations across the vein from side to side, in which the crystals are parallel and fibrous, known as satin spar.

**gypsum luminescence;** frequently brownish-green glow under UV light. Inert under X-rays.

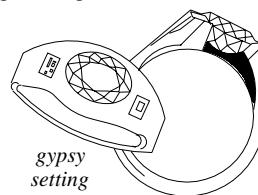
**gypsum, satin spar;** → satin spar, gypsum, formation of.

**gypsum plate;** a thin gypsum plate, which can be obtained for purposes of uniaxial or biaxial crystals by microscopical examination. Also called selenite plate.

**gypsy ring;** a gold band finger ring and a stone or stones mounted in a gypsy setting.

**gypsy setting;** a mounting style for securing poor

quality gemstones, diamonds or diamond imitations in a finger ring, in which the stone is deeply set into a



circular or oval metal claw (without collet) so that almost the table facet is almost level with the metal surface. Also

spelling gipsy, or gipsy. → Setting, crown setting, half brilliant cut.

**gyre;** circular course or motion of crystals.

**gyu;** a Tibetan term for turquoise.

# H h

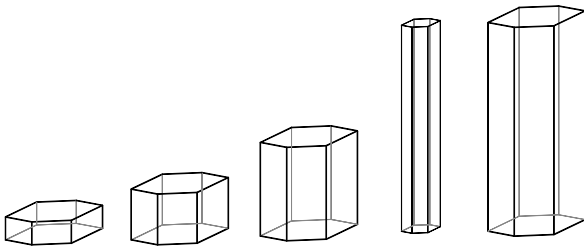
**H**; an abbreviation for the degree of hardness in minerals or gemstones.

**H**; a chemical symbol for the element hydrogen.

**H**; one of the strongest pair of Fraunhofer lines, almost at the limit of visibility in the extreme violet of the solar spectrum, one of the wavelengths measures (H) is at 396.86 nm, which is caused by calcium, and the other wavelength measures (K) at 393.38 nm, caused by ionized calcium.

**Habachtal emerald**; prismatic, well-colored emerald crystal, which occurs in biotite schist found in Habachtal in the Salzburg Alps, Austria.

**habit**; in crystallography the characteristic crystal form or combination of forms displayed by a mineral. For



*crystal habits of aragonite*

example diamond has an appearance of an octahedron or beryl is elongated. Various habits include bipyramid, columnar, prismatic, tabular, mammillary, massive, botryoidal, dendritic, acicular, which may vary with locality. Also spelled habitus.

**habitus**; same as habit.

**hackle back pearl**; a fresh-water, pearl-bearing mussel genus *Symphynota complanata*. Known as hackle back, heel splitter, hatchet back. Also called hatchet back pearl.

**hackly**; a mineral or rock fracture having an irregular surface with sharp angular projections.

**hackly fracture**; minerals, which break into an irregular surface with sharp angular points. → Pearl surface.

**hackmanite**; a transparent, pink calcium and sulfur rich variety of sodalite found at Mont Saint Hilaire, Canada. RI:1.485-1.587. SG:2.30-2.32. It is photochromatic.

**Haddam**; a green, pink and parti-colored tourmaline mine from Haddam, Connecticut River, USA.

**Haddam Connecticut**; location of grossular(ite) in California, USA.

**hadrons**; a term applied to elementary particles with strong interactions. → Meson.

**haematinon**; → haematinon glass.

**haematinon glass**; a semitranslucent, dark-red aventurine glass or goldstone, which was known to ancient people. RI:1.53. SG:2.50-2.80. Also called purpurine glass and spelled hematinon glass, hematinon. → Aventurine glass, goldstone.

**haematite**; the original English spelling of hematite.

**haematoconite**; same as rosso antico. Marble colored red by hematite.

**haemin**; → porphyrin.

**hafnium**; a silvery metallic element resembling zirconium of the Periodic System with the symbol Hf.

**hafnium in zircon**; invariably contains small amount of hafnium, together with some other elements, which cause lower thermal expansion.

**haibauk**; same as the-bauk. → Corundum classification in Myanmar.

**haida slate**; same as argillite.

**Haidinger loupe**; same as dichroscope.

**haieh**; a Chinese term for black nephrite. → Nephrite colors in Chinese, Chinese ritual and symbol

**hailstone boart**; a gray, grayish-black variety of rounded diamond crystals. Composed of concentric shells of clouded diamond and cementlike material. → Bort.

**hair**; a commercial name for hairlike fracture or acicular inclusions in gems.

**hair amethyst**; amethyst with hairlike inclusions. Also called sagenitic amethyst.

**hair amethyst**; a misleading term for amethyst colored tourmaline from Montana, USA.

**hairband**; a term used by Australian miners to an opal with a capillary, acicular or hairlike color running up from the center.

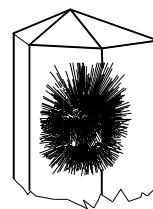
**hair crystal**; another term for hair stone.

**hairlike**; same as capillary or acicular.

**hairline feather**; → feather, bearded girdle.

**hair pyrite**; same as millerite or capillary pyrite.

**hair jewelry**; an ornamental article of jewelry made of gold or other precious metal worn as a pendant, in



*hairstone quartz*

which bunches of human hair are inserted, usually valued for personal reasons. Used in brooches, bracelets, pendants, rings, chains, lockets, etc.

**hair lines**; a term rarely used for absorption line.

**hairpins**; → U-shaped inclusions in Kashan rubies.

**hair stone**; a variety of transparent quartz thickly

penetrated with hairlike, fibrous, threadlike or acicular crystals of rutile or actinolite. Also called hair crystal, sagenite quartz or needle stone and spelled hairstone. → Venus hairstone, thetis hairstone.

**hairstone;** → hair stone.

**hair pyrites;** same as millerite. Also called capillary pyrite.

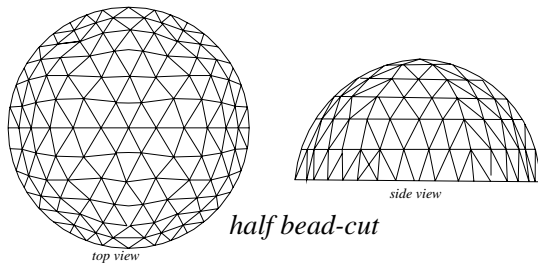
**Haiti pearl;** pearls from the South and West Coasts of Haiti.

**hakik;** an Indian Hebrew general term for agate.

**halbanita aquamarine;** an indigo-blue beryl variety of Maxixe-type, from Minas Grease, Brazil, which is colored due to Cobalt-oxide impurity.

**half (carat);** a commercial name for 0.50 carat.

**half bead-cut;** a half spherical bead cut, which is



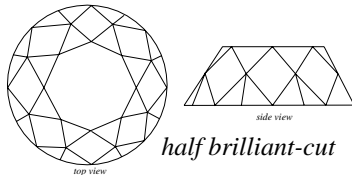
*half bead-cut*

entirely covered with varying three-sided facets without pavilion.

**half-bored pearl;** pearls, which are only partly drilled for use in ear-rings, scarf pins, etc.

**half brilliant;** same as half brilliant cut.

**half brilliant cut;** a standard brilliant-cut without pavilion, in which the crown consists of 32 facets and a table, a circular girdle outline, and a flat base. Also called half brilliant

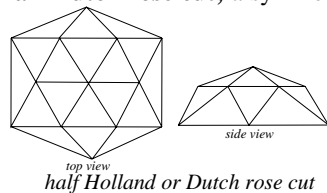


*half brilliant-cut*

or brillionette. Used for gypsy setting.

**half carnelian;** a misleading term for natural occurring yellow carnelian.

**Half-Dutch rose cut;** a symmetrical cut half rose design covered with 18 triangular facets on the hemisphere and a flat base. The girdle is six-sided in outline and pointed with dome-shaped crown.



*half Holland or Dutch rose cut*

Also called half-Holland rose cut.

**half facets;** same as break facet. → Girdle facets.

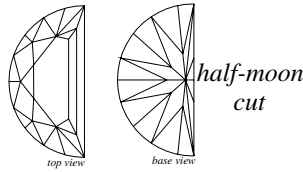
**half finish;** in the ceramics industry the first cover coat

of enamel in a two cover coat system.

**half-Holland rose cut;** → half-Dutch rose cut.

**half lead;** → crystal glass.

**half-moon cut;** a fancy style of gem or brilliant cut has the shape of a half moon. It divided in half vertically from crown to the culet. Also called half-moon brilliant cut, half lunar brilliant-cut, half brilliant-cut.



*half-moon cut*

**half-moon brilliant cut;** same as half-moon cut.

**half opal;** same as semiopal.

**half pearl;** when a round pearl is sawed in half.

**half pearl;** frequently a description for Japanese cultured pearls, when they are grown with a hemisphere against the shell. To make an exact sphere it is glued to a mother-of-pearl rounded bead of the same diameter.

**Half Regent Diamond;** a half-moon-shape diamond of 60 cts. No additional information is available.

**half tin;** one-half of a simulant stone, the crown been polished on a tin lap.

**halilith;** same as halite.

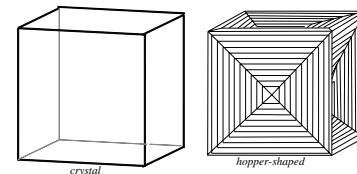
**haliotidae;** a family of gastropods such as ormers or ear shells of brilliant hues such as green, blue and yellow occurring in California, Japan, New Zealand. In America called abalone or abalone clam.

**haliotis;** a highly iridescent genus of haliotidae mollusk. → Abalone.

**haliotis pearl;** a highly colored, iridescent baroque pearl from haliotis shell. → Abalone pearl.

**haliotis shell;** an iridescent mother-of-pearl of haliotidae mollusk often used as opal doublet imitation, which has been cemented on the back of cabochon cut glass or quartz. Also called paua shell, abalone shell.

**halite;** a mineral found in variety of colors including colorless, white, yellow, reddish, and blue. Common native salt has chemical formula: 4[NaCl]. It occurs as minute cubic



*halite crystal and hopper shaped*

crystals as inclusions in emerald. SG:2.2. H:2.00. Also called rock salt, common salt. Also spelled halilith.

**hallmark;** an official series of mark or stamps indicating a standard of purity, used in marking gold, silver, or platinum or other precious metal articles to guarantee purity, date of manufacture, etc.

**halloysite;** a porcelain-like clay of aluminum silicate  $2[Al_4(Si_4O_{10})(OH)_8 \cdot 4H_2O]$ . Monoclinic or triclinic system. Polymorphous with nacrite, kaolinite, and

dicomite. Transparent to translucent. Colorless, white. Pearly to earthy luster.  $n=1.555$ . SG:2.00-2.20. H:2-2.5. Used to some extent in white-wares, such as translucent china. Also called meta-halloysite, endellite.

**halloysite**; a group term used for all naturally occurring halloysite minerals (hydrated, nonhydrated and intermediate).

**Hallstatt Amber**; a city in Austria during 1800's a large hoard of amber was found which was dated to Early Iron Age may was used by peasantry.

**halo**; in gemology a cloudy colored zones occurring around radioactive inclusions such as zircons in tourmaline or cordierite. Also called pleochroic halo.

**halo**; in geochemistry, diffusion into surrounding rock formation of traces of mineral being sought.

**halo**; a type of head ornament made of metals in the form of a crescent-shaped band.

**halo**; a metal ring in the shape of a nimbus, disk, or rayed form above or around the head.

**halochromism**; a term used color change of an organic compound in acidic and in alkalic medium such as phenolphthalein which acidic medium is colorless and alkali medium produce a deep-red color.

**Halo Cut**; a trademark name for polished girdle.

**halogen deficient**; → color centers.

**halotrichite**; same as iron alum.

**halogens**; members of the non-metallic group of group VII of the Periodic System, very active chemical elements astatine, chlorine, bromine, fluorine, and iodine.

**Halphen Diamond**; a rose-red diamond of 22.50 cts. No additional information is available. Also called Halphen Red Diamond.

**Halphen Red Diamond**; same as Halphen Diamond.

**halves facets**; same as half facet. → Break facet.

**hamaage**; a Japanese term for the crop of cultured pearls prior to processing.

**hambergite**; a beryllium borate mineral. A suitable mineral for collectors but rarely cut as gems. Resembles quartz. Strong birefringence.

System: orthorhombic.

Formula:  $8[\text{Be}_2(\text{OH},\text{F})\text{BO}_3]$ .

Luster: vitreous to dull.

Colors: colorless, white, white grayish, yellowish white.

Streak: colorless.

Diaphaneity: transparent to translucent, semi-opaque.

Cleavage:  $\{010\}$  perfect, and  $\{010\}$  good.

Fracture: conchoidal to uneven. Brittle.

SG: 2.365.

H: 7½.

Optics;  $\alpha:1.553$ ,  $\beta:1.59$ ,  $\gamma:1.631$ .

Birefringence: 0.078. ⊕.

Dispersion: 0.015.

Found in Malagasy, the Czech Republic, Cashmere, India, Romania, USA, and Norway.

**hammer pearl**; a type of baroque pearl, which is shaped like the head of a hammer.

**hammered pearl**; pearls with a surface, which resemble the hammer marks on hammered copper, silver or other metals.

**hammering**; the technique used in noble metal working to make gold sheet jewelry by beating the metal to stretch and flatten it. This process is alternated with annealing.

**hampshirite**; a soapstone pseudomorphous after olivine found at Chester, Massachusetts, USA.

**Han**; same as Han jade, or Han Yü. A Chinese term for jade of the time Han dynasty.

**han**; a Chinese term for carved cicada made of jade.

**han**; a Chinese term for flat disc or tear-drop shaped piece with a central hole carved from jade for inserting in mouth. → Chinese ritual and symbol jades.

**Han badao**; a Chinese term for Han Dynasty feudal rule in china.

**Hancock Red Diamond**; an exceptional pink red diamond of 0.95 cts. It was sold for \$ 880,000 in New York, USA in 1987.

**hancockite**; a transparent, red, maroon, brownish to yellowish-brown mineral of epidote group with chemical formula:  $(\text{Pb},\text{Ca},\text{Sr})_2(\text{Al},\text{Fe})_3(\text{SiO}_4)_3(\text{OH})$ . Monoclinic crystal. Vitreous luster. Cleavage:  $\{001\}$  perfect. Uneven fracture. Brittle. Optics;  $\alpha:1.788$ ,  $\beta:1.810$ ,  $\gamma:1.83$ . Birefringence: 0.042. ⊖. SG:4.03. H:6½-7½. Found in New Jersey, USA. Also spelled hancockite. → Epidote.

**hancockite**; another spelling for hancockite.

**hand blocking filter**; → color filter, Chelsea color filter, filtered light.

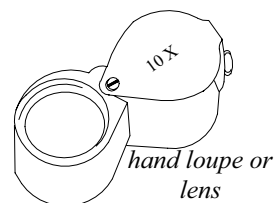
**hand boring**; a term used by Australian miners for boring the matter by means of a fishtail bore to excavating an opal deposit.

**hand cutting**; same as hand digging.

**hand digging**; removal by hand of the natural ground. Also called manual excavating, hand cutting, hand excavating. Same as hand digging.

**hand excavating**; Same as hand digging.

**hand lens**; a small magnifying glass for inspection of the internal and external features of gemstones, or used in the field or in other preliminary investigations of a mineral. Most hand



loupe used in gemology are corrected loupes. Also called loupe, hand loupe or pocket lens, magnifier,



magnifier glass.

**hand loupe;** same as hand lens.

**hand mined;** manually mined.

**hand pass filter;** → color filter, Chelsea color filter, filtered light.

**hand picking;** manually picking.

**band reflecting filter;** → color filter, Chelsea color filter, filtered light.

**hand specimen;** a piece of selected mineral chosen for megascopic study or collection.

**hand spectroscope;** same as spectroscope.

**Hanger Diamond;** a pale yellow rough diamond of 123 cts, from South Africa. Was purchased by E. S. Hanger.

**Hanging wall;** the roof of rock of a working mine.

**Han Hsiang;** a Chinese term used for a human symbol carved from jade as a musician plying flute. → Chinese ritual and symbol jades.

**Han jade;** same as Han, or Han Yü. A Chinese term for jade of the time Han dynasty.

**Hanneman balance;** a simple beam balance supplied by Hanneman used to give direct indication of specific gravity.

**Hanneman penlight torch;** a very intense illuminator in the form of a pen torch used in gemology suitable for small spectroscopes.

**Hanneman reflectance meter;** a device made by Hanneman Lapidary, California, USA to calibrate stones and their scale in terms of their refractive indices, which is called Jeweler's Eye.

**Hanover Pearls;** a pearl necklace composed of 6 long ropes of pearls with large 25 drop pearls. Present whereabouts is unknown.

**Han Yü;** a Chinese term for jade of the time Han dynasty.

**Han Yü;** a commercial term for tomb jade, sometimes for any jade, which resembles it.

**haplite;** a quarryman's term for aplite.

**haplitic;** having the fine-grained texture of haplite.

**haplogranite;** a kind of tourmaline-bearing granite characterized by large quartz and feldspar particles in fine-grained texture.

**Hapsburg's Crown Jewels;** → Kunsthistorisches Museum, Vienna.

**Hapsburg's Jewels;** → Kunsthistorisches Museum, Vienna.

**hard-band;** a local term used by Australian miners to a very thin sheet of sandstone or hardstone lying above the conglomerate and clay, which may contain some opals.

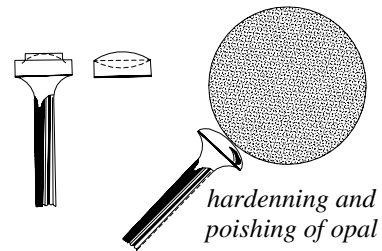
**hardbank;** a descriptive term for kimberlite or blue ground, which is unweathered, also harder than usual.

**hard clam pearl;** pearls from clam-pearl for instance the quahog *Venus mercenaria* of the Atlantic Coast,

USA.

**hard coal;** same as anthracite.

**hardening;** after mounting rough stone on dopstick especially opal it must be go harden for next cut and



polishing.

**hard glass;** a glass of high softening point.

**hard glass;** a glass, which is hard to scratch.

**hard glass;** a borosilicate glass that is resistant to heat and chemical actions.

**hard-glass emerald;** green glass rapidly cooled, which is resistant to heat and chemical actions. → Hard glass.

**hard ivory;** a trade term for bright ivory, which is distinctly harder to cut and has more glassy surface than the soft ivory. → Soft ivory.

**hard jet;** → jet varieties.

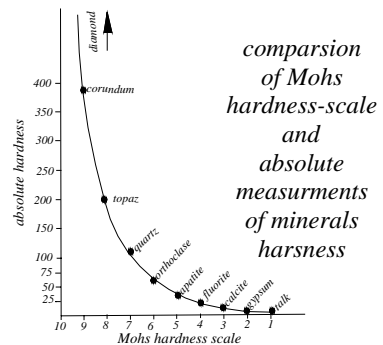
**hard mass;** a commercial term for imitation gems of hard glass, which have an unusual hardness of 6 or more.

**hard mass;** sometimes means synthetic sapphire or spinel.

**hard mineral;** a mineral, which is hard or is harder than quartz (seven) according to Mohs' scale.

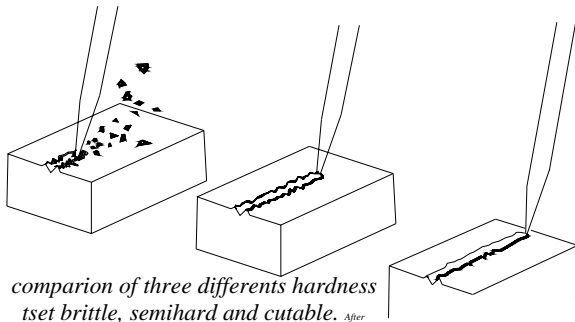
**hard needles;** the inclusion of large needlelike crystals in quartz give the appearance of being hard.

**hardness;** the quality of resistance or property of minerals, gemstones, etc., which is determined by



reference to an empirical scale of standard of minerals. Hardness is the resistance of a mineral offered to abrasion or scratching (sclerometric). The absolute hardness is determined with the aid of a sclerometer. Hardness varies according to crystallographic direction in certain minerals, such as cyanite or disthene three

different hardnesses in three different crystallographic directions: 4.5, 6, and 7. The hardness of a gemstone



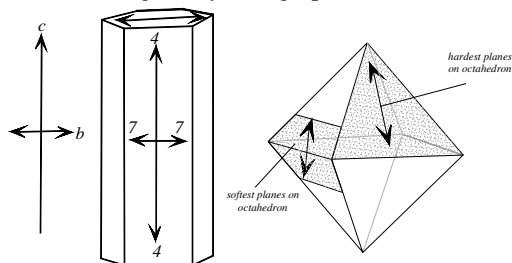
can be determined using a hardness plate or hardness points. The general scale used as standard by mineralogist and gemologist due to Mohs' is as follow:

table 7: hardness, composition and equivalent

hardness	composition	equivalent
1-talc	$Mg_3Si_4O_{10}(OH)_2$	Fingernail
2-gypsum	$CaSO_4 \cdot 2H_2O$	fingernail
3-calcite	$CaCO_3$	teeth, copper coin, brass pin
4-fluorite	$CaF_2$	teeth, copper coin, brass pin
5-apatite	$Ca_5(PO_4)_3(F,Cl,O,OH)_3$	teeth, copper coin, brass pin
6-orthoclase	$KAlSi_3O_8$	window glass
7-quartz	$SiO_2$	penknife
8-topaz	$Al(SiO_4)(F,OH)_2$	steel file
9-corundum	$Al_2O_3$	
10-diamond	C	

Also called Mohs' scale.

**hardness direction;** hardness in minerals and gemstones varies according to crystallographic direction in certain



left: hardness planes on kyanite, c (basal) b-direction. Right: hardness planes on diamond

minerals, such as cyanite or disthene three different hardnesses in three different crystallographic directions: 4.5, 6, and 7.

**hardness gauge;** it means hardness point.

**hardness, indentation;** → indenter test for hardness.

**hardness, indentater test;** → indenter test for hardness.

**hardness of plastics;** hardness is less 1.50-3.00. → Plastics properties.

**hardness pencil;** small pieces of conical metal with pointed fragments of the different hardness in the Mohs' scale. Minerals of hardness 6 to 10 on Mohs' scale are usually used. The test is destructive and should be used only on rough stones. Also called hardness points, hardness points pencil.

**hardness plates;** same as hardness pencil but polished flat, and set side by side in cement, for testing hardness of minerals by checking their ability to scratch a plate. Also called hardness test plate.

**hard platinum;** an alloy of 90% platinum and 10% iridium, used in alloys with platinum in jewelry. → Iridium.

**hardness points;** same as hardness pencil.

**hardness points pencil;** same as hardness pencil.

**hardness scale;** a general scale used as standard by mineralogists and gemologist, by, which the hardness of a mineral is determined as compared with the Mohs' scale. → Hardness, Mohs' scale.

**hardness, scratch test;** → scratch hardness.

**hardness table;** any listing of minerals and substances in the order of their hardness according to Mohs' scale. → Hardness, Mohs' scale.

**hardness test plates;** same as hardness plate.

**hardness tester;** any device that is used for the testing of minerals.

**hardness, variation in;** → variation in hardness.

**hardness wheel;** an instrument in wheel form, in which hardness points are mounted equidistant according to hardness table from 6 to 10 on Mohs' scale.

**hardpan;** a term used by Australian miners to a bottom or bedrock which lying under opal dirt.

**hard paste;** same as porcelain.

**hard rays;** same as beta rays or gamma rays.

**hard rock;** a name applied frequently to igneous or metamorphic rock, as distinguished from sedimentary rock.

**hard rock;** a rock which is relatively resistance to erosion than other stones.

**hard rock;** a rock which must be drilled or blasted for its commercial removal.

**hard soldering;** the process of uniting metals by high-temperature with brass or other hard alloys. → soldering, brazing.

**hard spar;** same as corundum.

**hard spar;** same as andalusite.

**hardstone;** a misnomer but sometimes used for any opaque stone, which is used to produce mosaics, such as agate, carnelian, onyx, sardonyx, etc. Also spelled hard stone.

**hard stone;** same as hardstone.

**harinmani;** a Sanskrit term for emerald. Also spelled harinmanih.

**harinmanih;** same as harinmanih.

**harlequin;** a term used by Australian miners to a precious opal containing many varied sharply angular squares of colors on the surface of the stone with distortion of the angles and uneven in arrangement. Also called harlequin opal.

**harlequin opal;** same as harlequin.

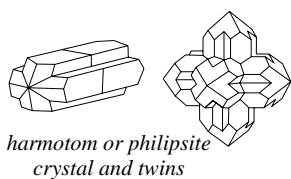
**harlequin opal;** a variety of oriental opal or harlequin.

**Harlequin Diamond;** a pear-shaped diamond of 22 cts, now set in a pendant in a three-row of 97 diamond necklace, now on show in Baden-Württemberg Landesmuseum, Stuttgart, Germany.

**harlequin opal;** usually a precious opal containing many varied sharply angular patches or mosaic-like, tile-like play of colors of miniature tile-like patches on the surface of the stone. Rarely can be seen cat's-eye effect with chatoyant band, usually green color.

**Harlequin, Prince Opal;** a fine, black opal with play-of-color of red, yellow, orange, blue, violet and green, of 215.85 cts, of harlequin clan. Exhibited by the American Museum of Natural History, New York City, USA.

**harmotome;** a monoclinic zeolite mineral of  $2[\text{BaAl}_2\text{Si}_6\text{O}_{16}\cdot 6\text{H}_2\text{O}]$ . Monoclinic crystal. Vitreous luster.



*harmotome or philipsite crystal and twins*

Transparent to translucent. Colorless, white, gray, yellow, red, and brown. White streak. Cleavage: {010} distinct, and {001}

indistincts. Fracture: subconchoidal to uneven. Brittle. Optics;  $\alpha$ :1.503,  $\beta$ :1.505,  $\gamma$ :1.512. Birefringence: 0.009.  $\oplus$ . SG:2.44-2.50. H:4½. Found in Norway, Finland, New Zealand, Italy, and USA. A suitable mineral for collectors. Also called cross-stone, hercynite.

**Harpoceras exeratum;** a kind of ammonite fossil found in the jet rock.

**Harrogate diamond;** a misleading term for quartz crystal from West Yorkshire, England.

**Harry Winston Emerald;** same as Gachala Emerald.

**Harry Young Diamond;** a pale yellow, octahedron diamond of 269.50 cts, found in 1913 on the Vaal River, Cape Province, South Africa.

**Hartebeestlaagte;** location of a small alluvial diamond mine in Transvaal Province, South Africa.

**Hartglas Smaragd;** a misleading German term for an emerald green glass, which will rapidly cooled.

**Hartridge revision spectroscope;** a spectroscope constructed by Beck where absorption bands are seen in contiguous reversed images of the spectrum, which coincide by turning a calibrated cylinder.

**Harvard Diamond;** a yellow perfect octahedron crystal diamond of 82 cts, exhibited in Harvard University

Museum, Massachusetts, USA. It was stolen in 1962 and never recovered.

**harzburgite;** a medium-grained, ultrabasic igneous (plutonic) rock, consisting of olivine, ortho-pyroxene with serpentine, magnesite, and calcite. Also a variety of peridotite. → Saxonite.

**Harz cat's-eye;** a variety of quartz cat's-eye of inferior quality from Harz Mountains, Germany.

**Hastings Diamond;** reportedly a diamond of 101 cts, was presented to King George III in 1786 by Warren Hastings, Government General of India, from the Nizam of Deccan. No additional information is available.

**hatchet back pearl;** same as hackle back pearl.

**hatchet stone;** another term for nephrite.

**hatchettolite;** a brown, uranium-rich variety of pyrochlor. Also called betafite, ellsworthite.

**Hatton Garden;** the diamond and jewelry center in London.

**hauerite;** a reddish-brown to black mineral of  $\text{MnS}_2$ , occurs massive or octahedral or pyritohedral. It is prized by collectors.

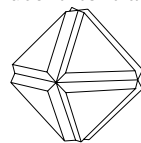
**haughtonite;** a black variety of biotite, which is rich in iron.

**Haute-Guinea;** location of a diamond-bearing area in Upper Guinea, Africa.

**Haute-Sangha;** location of a diamond-bearing area in Upper Guinea, Africa.

**haüyne;** another term for haüyinte.

**haüyinte;** a blue feldspathoid mineral of sodalite group that is a component of lapis lazuli. A complex mineral of sodium, calcium, aluminum silicate and sulfate:  $(\text{Na,Ca})_8(\text{Al,Si})_{12}\text{O}_{24}(\text{Cl},\text{SO}_4)$ . Cubic crystal system. Translucent to translucent. Vitreous to greasy luster.



*haueyne twin*

Usually blue but shade of green, red, yellow. Colorless to slightly blue streak. Cleavage: {110} distincts. Conchoidal to uneven fracture. Brittle.

RI:1.496-1.508. SG:2.44-2.50. H:5½-6. Found in Italy and Germany. A suitable mineral for collectors. Also called haüyne, haayne, roebingite.

**haayne;** same as for haüyne.

**Haversian system;** oval or circular cavities surrounded with minute dot-like or seed-like spaces of thin section of bone seen under microscope by low magnification.

**Hawaiian diamond;** a misleading term for rock crystal from Hawaii.

**Hawaiian angle skin coral;** rose colored corals from Molokai canal, Hawaii.

**Hawaiian golden yellow topaz;** a misleading term for

natural yellow clear plagioclase feldspar.

**Hawaiian peridot;** pale green variety of peridot from Hilo, Hawaii.

**Hawaiite;** pale green, iron-poor gem variety of peridot from the lavas of Hilo, Hawaii.

**Hawaiite;** an obsolete term for andesine or trachyte basalt variety from Hawaii Island.

**hawksbill;** a genus of marine turtle *Chelone imbricata*, which is the main source of commerce shell. Also called tortoise shell, hawksbill turtle.

**hawksbill turtle;** → hawksbill.

**hawk's-eye;** a transparent to translucent, colorless to greenish-blue, pseudomorphosed variety of cat's-eye quartz after parallel fibrous of crocidolite (a variety of blue serpentine), which resembles the eye of a hawk, when cut en cabochon. These minerals are not oxidizes, in contrast to tiger's-eye. Synonym for hawks-eye, falcon's-eye, sapphire-quartz, azure-quartz, siderite. Formerly named sapphire-quartz, and azure-quartz. → Tiger's eye, zebra.

**haystack;** → haystack pearl.

**haystack pearl;** a term applied in the USA for a freshwater, high-domed button pearl. Also called haystack.

**haytorite;** a variety of chalcedony pseudomorphous after datolite.

**He;** a chemical symbol for the element helium.

**head;** a setting part comprising of 4 or 6 fingers, into which a stone is mounted.

**head;** a name used for heel of a rounded end or a pear-shaped diamond, used also as opposite to the end terminating in a point.

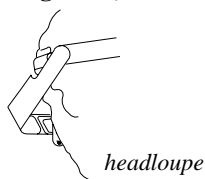
**head;** a band spectrum emission consists of fine lines, which are wide apart in one end and closer in the other end so that they appear to be one dense line at the head.

**head amber;** a local term for amber deposit near Yajalon in Simojovel region, Mexico. Mexican spelling is Hool Babuchil.

**heading;** a term used by Australian miners for a tunnel or digging face and its work area driven off at right angles to the shaft according to good color of opal are seen.

**head loupe;** same as head magnifier.

**head magnifier;** a binocular lens mounted side by side on a head band having the hands free used for sorting diamonds and gemstones, and therefore both hands to be free. Also called head



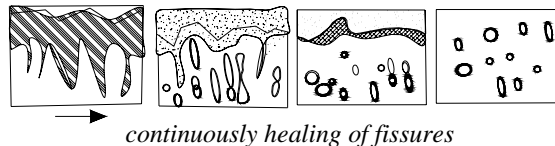
loupe, binocular head loupe.

**healed pearl;** pearls where surface or deeper layers cracks are repaired by experts.

**healing;** same as healing stone.

**healing stone;** a fissile sandstone used for roofing slates, etc. Also called healing.

**healing of fissure inclusions;** healing the irregular



continuously healing of fissures

cracks in the internal or surface of stone after growth.

**heart;** heart shape articles of many types used in jewelry.

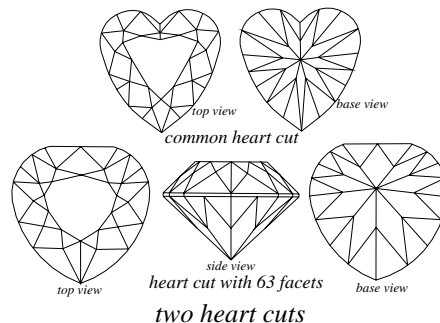
**Heart Diamond;** reportedly Tavernier saw this heart-shaped diamond of 35 cts, in the treasure of Emperor Aurangzib of India.

**heart brilliant cut;** same as heart-shaped brilliant cut.

**Heart of Antwerp Diamond;** a heart-shaped diamond of 38.40 cts, was exhibited in 1979 in Antwerp, Belgium due to 75th Anniversary of the Diamond Bourse in Antwerp.

**heart scarab;** a type of scarab made in ancient Egypt worn as an amulet or talisman.

**heart-shaped brilliant cut;** a modified fancy brilliant cut, a variety of the pendeloque. Usually with a large table and shallow bezels, and a shield-shaped culet.



Consisting of 36 facets on the crown, and 27 facets on the pavilion, plus a table and a culet. Related to the pear-shaped diamond. Also called heart brilliant cut, heart shaped diamond.

**heart shaped diamond;** → heart-shaped brilliant cut.

**heart shaped emerald;** a variety of step-cut with a heart-shaped outline.

**heart shaped talisman in Egyptian;** several heart-shaped talismans carved of different gems, minerals, and materials seen in ancient Egyptian, which may used as amulets and each one has its own sign. Those made of beryls are signified as power of living and

will.

**heat;** usually most minerals or gemstones are conductors of heat and so, when touched on the tongue or held in the hand, they feel colder than glass or imitation glasses.

**heat conductance;** → thermal conductivity diamond tester, thermal conductivity.

**heat conduction;** the capability of heat transfer through minerals or solid substance, from a higher temperature to lower temperature through the stone without transfer of the matter itself, such as diamond Type I have twice the thermal conductivity of copper, while Type IIa diamonds have six times conductivity of copper. This is to conduct heat away from substances and delicate instrument. Also called thermal conductivity, or conduction. → Thermal conductivity.

**heat conductivity;** same as thermal conductivity.

**heat conductivity of plastics;** is similar to glass feel warm. → Plastics properties.

**heat crack;** any cracks in rock or stones, caused by vigorous temperature changes, causes it to fall apart into two or more pieces.

**heated gem;** same as heated stone.

**heated gemstone;** same as heated stone.

**heated stone;** any gemstone that has been heated to change its color or improve the color, such as blue zircon, hyacinth, burnt amethyst, white chalcedony, smoky quartz and many aquamarines. Also called heated gem or gemstone. → Stained stone, heat-treated stones.

**heath-stone;** same as erikite.

**heath-wave hessonite;** a term used for peculiar rounded low-relief inclusions of apatite and calcite crystals in hessonite so that they give the heat-wave appearance to the material.

**heat probes;** → thermal conductivity diamond tester, thermal conductivity.

**heat radiation;** → infrared radiation.

**heat treated;** a term used sometimes for tempered stones. → heat-treated stone.

**heat-treated amber;** some ambers with iridescent circular cracks have in clear appearance induced by heat treatment.

**heat-treated amethyst;** most citrine stones have been produced from amethyst by heat treatment to change their color, that color changing being permanent. → Burnt amethyst.

**heat-treated apatite;** some yellow apatite from Mexico can be heat-treated to greenish cat's-eye available from Brazil. It is prized by collectors.

**heat-treated beryl;** some brownish-yellow, green or greenish-yellow varieties of beryl can be heat-treated to pure blues, the blue color is depended upon the original

hue.

**heat-treated carnelian;** brownish carnelian from India is heat-treated to improve its color.

**heat-treated quartz;** → burnt quartz.

**heat-treated smoky quartz;** smoky quartz from Malagasy, Brazil, California can be heat-treated to lighten or drive off color completely to yellow citrine. heat-treated smoky quartz is often misnomered as smoky topaz. Cut as gems. → Burnt smoky quartz.

**heat-treated stone;** certain rough gemstones improved or completely changed in color by means of controlled heat-treating. The induced colors are permanent in varieties such as burnt amethyst to produce yellow, green or brownish-red. Brown and yellow topaz from Brazil changed to pink. Greenish aquamarine altered to blue. dark-green tourmaline improved to emerald green. Zoisite turns to a sapphire blue. Brown zircons from Cambodia altered to blue and golden brown, red, and colorless depending on the temperatures and the conditions of heating such as in air or reducing atmosphere. Green irradiated diamond change to yellow or cinnamon brown for some hours at about 500-900 C, but the stone is left radioactive for varying periods of times. Heat-treatment of stones increases the risk of splitting or fracture of rough material during fashioning. → Stained stone, coated stone. heated stone.

**heat-treated tiger-eye;** brown and yellow variety of tiger-eye change to pale yellow, straw-yellow, and other colors by heat-treated.

**heat-treated yellow quartz;** a term applied to heat treated yellow, transparent quartz, which, unlike poorly colored yellowish citrine, is produced by heating natural amethyst or brownish hues of quartz. → Burnt quartz, burnt amethyst.

**heat treatment;** → heat-treated stone.

**heat treatment and irradiation of topaz;** generally topaz will become strongly electrified by friction or heat or some stones by stroking. heat-treated reddish-brown topaz from Brazil in a sand bath of 500° C turns color to pink *pinking* due to traces of chromium, which entered the crystal structure during the heating process in brown stones. Some fluorine-bearing topaz from Russia, Japan, and USA with light brown color fades in sunlight. Irradiation with gamma-rays changes colorless topaz to blue and yellow color and than heat-treatment to eliminate the unstable yellow color, which in trade has become the name *cobalt blue topaz*. The linear is often used accelerator to change blue topaz and than it is heat-treatment to eliminate the unwanted yellow color the stone is named as *sky blue topaz*. *Inky topaz* is a dark grayish-blue irradiated topaz without heat-treatment, this material in trade is known as *London*

*blue topaz*. The induced topaz is radioactive, therefore it must be stored for one to two years to decay to a safe level. *Super blue topaz* is a commercial term for dark blue topaz colored by combination of radiation in reactor and linac and than heat treatment. Also marketed as super American blue topaz, super Swiss blue topaz. *Ocean green topaz* is a commercial term for irradiated topaz in a nuclear reactor, which turns its color to green. *Aqua aura topaz* is a trade name for a blue topaz, which is coated with gold with a superficial iridescence. → Dumelle's heat-treatment of topaz.

**heat treatment and irradiation of tourmaline;** heat treatment used to lighten dark colored tourmaline, for example red or pink stone, when heated to 260° C loses its color. Numerous are stable over 400° C, or some green colored stone lightens and the pink stone is colorless at about 700° C. Heating of tourmaline caused more brittleness in the stone. The lightening of dark-green and blue tourmaline from Brazilian known as *opening the color* or *abrir a cor*. Certain green tourmaline from Namibia takes emerald-green color with heat-treatment. Pale pink, blue or colorless tourmaline turns its color to red or pink or lilac colors by irradiation.

**heat treatment detection;** some heat-treated stones such as rubies and sapphires can be exposes using a microscope, absence of silk as inclusions in the stone, stress fractures, and banded color can be seen. It exhibits chalky glow under SWUV light, or sometimes multi-planed girdles seen of fashioned stone.

**heat treatment of amber;** heat-treated amber become brown color which is known as antique amber.

**heat treatment of aquamarine;** greenish-yellow, greenish-blue or brownish-yellow aquamarine changes color to a lovely blue when heated between 300-500° C.

**heat treatment of chalcedony;** some red to brownish chalcedony are heat-treated to improve the color, when they contain iron impurities, the heat-treatment caused oxidation.

**heat treatment of diamond;** → heat-treated stone.

**heat treatment of ekanite;** → ekanite.

**heat treatment of gemstones;** natural gemstones or diamond that has been heated to change its color eliminating the color or improving the color by controlled heating, such as blue zircon, hyacinth, burnt amethyst, many aquamarines, and irradiated green diamond may be changed to other colors. Also called annealing. → heat-treated stone.

**heat treatment of metals;** the technique of altering the color of a metal by heating, gold changes color to reddish with the presence of copper in a low-carat alloy, etc.

**heat treatment of morganite;** → morganite.

**heat treatment of odontolite;** → odontolite.

**heat treatment of quartz;** purplish or violet natural topaz, which has had its color altered to red-orange by heat treatment is known as pinking. → Burnt quartz, heat-treated amethyst.

**heat treatment of ruby;** natural ruby turns its color by heating. Heat-treated rubies are distinguished by lack of silk inclusions, lack of banded color, induced fingerprint in true or synthetic ruby. → heat treatment of sapphire and ruby.

**heat treatment of sapphire and ruby;** violet sapphire turns to pink color when heated. Some inferior quality stones having patches of milky-white or milky-yellow opalescence are objected to heat to improve their appearance and color, which is known as *geuda*. A network of usually rutile inclusions, which can be used to produce synthetic star sapphires by means of heat-treatment, when cut cabochon, causes silk effect or milky-white or milky-yellow effect in stone. Heat-treated rubies or sapphires are distinguished by absence of silk inclusions, lack of banded color, induced fingerprint in true or synthetic sapphire. Heat-treatment involves some complex turning to the stones as following: temperature is at maximum depending to stone ascent or descent in corporation with time. Depend on chemical nature of stone may oxidizing or reducing at atmosphere or without atmosphere frequently used pressure. Chemical elements of stone, impurities, their states and presence are important for the kind of heat, pressure and atmosphere (oxidizing or reducing). There are five major kind of heat-treatment technique that used for rubies and sapphires: (a) blue color development of *geuda* and Kashmir sapphire happen by 1600-1900 °C in a reducing atmosphere, also pale silky pieces become clear dark blue, (b) removal of dark blue or inky, purplish and greenish-yellow sapphires happen by 800-1900 °C in an oxidizing atmosphere, (c) development of yellow color of pale-yellow sapphires to gold or intense yellow happen by 1600-1900 °C in an oxidizing atmosphere. Purple stones turned to orange, (d) removal of cloudy silk in sapphire happen by 1000-1900 °C and cooling rapidly and (e) development of silk and star in sapphire happen by 1300-1900 °C for 1 to 14 days and more. → Linde synthetic star corundum, sapphire heat-treatment, *geuda*.

**heat treatment of spodumene;** some yellowish-brown spodumenes change color to purple on heating.

**heat treatment of synthetic quartz;** when synthetic quartz is subjected to heat turns its color. → Burnt quartz, **heat-treated** amethyst.

**heat treatment of synthetic rutile;** → synthetic rutile.

**heat treatment of synthetic sapphire;** → heat treatment of sapphire, synthetic sapphire

**heat treatment of synthetic spinel;** → synthetic spinel.

**heat treatment of topaz;** → heat treatment and irradiation of topaz.

**heat treatment of zircon;** mostly zircon stones in trade are subject to heat treatment such as reddish-brown zircon from Indo-China turns to colorless, blue, dark red, bluish green, pink, golden yellow. Green zircon from Sri Lanka improves much paler, or some reddish-brown turn colorless. The heated stone in a closed furnace turns color to blue or colorless by passing air through the furnace their color changes to red or golden yellow, usually such color turned stones are stable rarely revert to their origin color. → Zircon.

**heat treatment of zoisite;** green, blue, brown, yellow, pink colored zircon from Tanzania turns color to blue by heat-treatment at 380 C.

**heat-treated stable sapphire;** heat-treated stabilize sapphire color from Sri Lanka. → Sapphire color centers.

**heat treatment, surface diffusion;** → sapphire surface diffusion.

**heaven stone;** same as benitoite.

**heavily spotted;** a term used in Great Britain for clarity grade of polished diamonds.

**heavy gold;** gold found in large particles.

**heavy hydrogen;** → deuterium.

**heavy liquids;** certain dense liquid suitable for measuring the specific gravity of minerals and gemstones. Commonest heavy liquid, which can be diluted using in determination:

table 8: heavy liquids

LIQUID	FORMULA	SG
<i>bromoform pure</i>	<i>CHBr<sub>3</sub></i>	2.90
<i>methylene iodide</i>	<i>CH<sub>2</sub>I<sub>2</sub></i>	3.42
<i>Clerici's</i>		4.15
<i>thallium malonite</i>		4.25

Other liquids are: common salt solution SG:1.12-1.14, acetylene tetrabromide SG:2.95, Sonstadt's SG:3.18, Klein's SG:3.28, Rohrbach's SG:3.58, Retger's salt 4.6. Retger's salt is solid at room temperature and melts in water to a yellow liquid by 75 C. Synonym for specific-gravity liquids. Also used to separate gems or ores.

**heavy liquid for measurement of specific gravity;** → specific gravity, heavy liquid.

**heavy liquid separation for diamond;** separation of sinking diamond from other floating particles such as crushed kimberlite and gravel using a series of patented heavy liquids of fine ferro-silicon powder (SG:6.7)

suspended in water to obtain a solution of SG of 2.7-3.1. The lighter particles float off and allow the diamonds to be drawn off from the bottom of the cone shaped container. → Hydrocyclone, heavy mineral separation, hydrocyclone separation.

**heavy liquid, type of;** → heavy liquid.

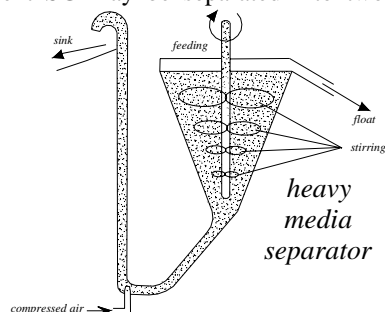
**heavy metal;** such metals that react readily with dithizone principally zinc, copper, cobalt, lead, bismuth, gold, cadmium, iron, manganese, nickel, tellurium, platinum, silver, etc.

**heavy minerals;** minerals having a high specific gravity, which are separated in the laboratory from light minerals by use of heavy liquid, such as bromoform. Generally grains heavier than bromoform constitute the heavy minerals. Also called heavy mineral separation.

**heavy minerals;** rock-forming minerals generally having a specific gravity greater than 2.90, which means mafic minerals.

**heavy minerals in blue ground;** in the blue ground with average of SG around 2.8, are some minerals with much higher SG concentrated, such as magnetite, zircon, ilmenite, rutile, garnet, corundum, spinel, diamond, epidote, olivine, and apatite.

**heavy mineral separation;** a mixture of mineral grains of different SG may be separated into two fractions.



Sinking are heavy minerals, and those floating are light minerals (according to bromoform). → Heavy minerals.

**heavy spar;** synonym for barite.

**Hebrew granite;** another term for graphic granite.

**Hebraic granite;** another term for graphic granite.

**Hebrew stone;** another term for graphic granite.

**Hebron;** location of a small alluvial diamond mine Cape Province, South Africa.

**hebronite;** another term for amblygonite.

**hecatolite;** another term for orthoclase moonstone.

**hecatolite;** another term for albite feldspar.

**hecatolite;** another term for intermediate between albite and anorthite feldspar.

**hedenbergite;** a brownish green, dark green, grayish green, black mineral of clinopyroxene group with chemical formula:  $4[\text{CaFeSi}_2\text{O}_6]$ . Monoclinic crystal. Vitreous luster. Streak white to gray. Conchoidal to uneven fracture. Brittle. Cleavage: {110} good. Optics;

$\alpha$ :1.721,  $\beta$ :1.727,  $\gamma$ :1.746. Birefringence: 0.025-0.031.  $\oplus$ . Dispersion: 0.017-0.020. SG:3.5-3.58. H:6. Found in Sweden and Norway. Used as ornamental stone.

**hedgehog stone;** rock crystal containing needle-shaped inclusions of goethite.

**heel;** a term applied to the rounded end of a pear-shaped gemstone opposite to point. → Head, pear-shape, belly.

**heel splitter pearl;** same as hackle back pearl.

**heft;** that feeling of weightiness or lightness of a mineral or other solid, when balanced in the hand, by which one can roughly estimate its density. This method and feeling can be developed considerably by practice and often serves as a valuable guide.

**hei tiki;** a Maori term for flattened alluvial jade pebbles used for ornamented purposes or amulet by Maoris of New Zealand, a flat pendant in the shape of a human figure. Flattened alluvial jade pebbles known as *mere*.

**hei matua jade;** a Maori term for a stylized fishhook carved by Maoris of New Zealand on the jade used as a neck gem.

**heishi beads;** a US Indian term for costume jewelry made of dyed minute salt-water shells or other stones beads, which are strung as beads through the center hole of shell that may be hand drilled or have naturally existed.

**heiyunmu;** a Chinese term for green biotite used as jade.

**Helam Mine;** location of a kimberlite fissure diamond-bearing in Zwartruggens, South Africa.

**helictite;** a term used for a grotesque shaped variety of gypsum or calcium carbonate found in caves, which resembles a stalagmite in origin. Also known as heligmite. Also called eccentric.

**heligmite;** same as helictite.

**heliocite;** same as aventurine feldspar.

**heliodor;** a synonym for golden-yellow, greenish-yellow transparent gem quality variety of beryl found in Southwest Africa. Also called *golden beryl*. Also spelled heliodore.

**heliodor;** an obsolete synonym for chrysoberyl, the yellow color is caused by traces of iron, or a trace of uranium. Heliodor means sun-gilded.

**heliodore;** another spelling for heliodor.

**heliodoro;** Spanish spelling for heliodor.

**heliolita;** Spanish spelling for aventurine.

**heliolite;** a translucent red or green variety of labradorite feldspar, flaky inclusions of hematite arrange the delicate red color. RI:1.57. SG:2.7. H:6. Used as gem.

**heliolite;** same as sunstone.

**heliotrope;** an old term for green to dark-green variety of plasma (chalcedony), which contains spots or patches of red jasper. Also called bloodstone, oriental jasper, blood jasper.

**heliotrope;** an obsolete term for earthy hematite.

**helium;** an inert, monatomic, colorless and odorless gaseous element of the Periodic System with the symbol He.

**helium in beryl;** frequently show small amounts of helium in beryl mineral.

**helium laser;** same as helium ion laser. → laser.

**helix in quartz;** helically arrangement of SiO<sub>4</sub> tetrahedron on the three-folded axes of the crystal space group of quartz with right-handed or left-handed structures.

**helmet conch;** same as conch pearls.

**helmet shell;** a species of the genus *Cassis madagascariensis* found in the warm waters of the West Indies used for carving cameo.

**helvine;** same as helvite.

**helvite;** an end member mineral, isomorphous with danalite and genthelvite. A pale-yellow to red-brown mineral of (Mn,Fe,Zn)(BeSiO<sub>4</sub>)<sub>6</sub>S<sub>2</sub>. Transparent to dull. Luster: glassy. Streak: white. Cleavage: (111). H:6-6.5. SG:3.20-3.44. Fracture: uneven. Also spelled helvine.

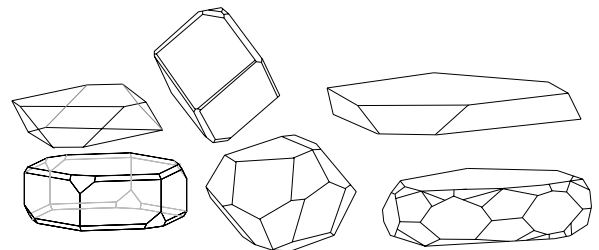
**hemachate;** a light-colored agate spotted with red jasper, which is known as blood agate.

**hematine;** a commercial term for sintered simulant of hematite. The material is attracted by magnet and has a black streak. It is used as intaglios of ancient cultures warrior's heads, which are pressed instead of being carved, as with natural hematite. Also called scientific hematite. Also spelled hemetine.

**hemetine;** another term for hematine.

**hematinon;** another term for haematinon glass.

**hematite;** fashioned minerals as intaglios of ancient cultures warrior's heads and other carved objects, which are black to dark gray with metallic luster. A massive mineral with metallic luster called *specularite*. A botryoidal or nodular aggregate, sometimes called *kidney ore* and misleadingly *kidney stone*. Thin flakes, which form rosettes called *iron rose*, or *Alpine rose*.



*hematite crystals*

When kidney ore or sometimes hematite breaks up into pointed fibrous fragments it is known as *pencil ore*. Used in jewelry as a seal carved in cameo, or as intaglio for single ring and as a cabochon, as beads for



necklaces or bracelets and as powder in polishing abrasive material known as *jeweler's rouge*. It is an inclusion in some sunstone and aventurine quartz. Sometimes used to imitate the black pearl. It is polymorphous with maghamite. Hematite imitations are made from magnetite, which attracts iron, hematine, hematiron, iserine, ilmenite, etc. *Hematite garnet* is a synthetic iron-rich garnet. Also called haematite, bloodstone (ancient name), red hematite, red iron, iron glance, oligist iron, oligist, red ocher, kidney ore, micaceous hematite, specular hematite, rhombohedral iron ore. Misnomerly called black diamond. Usually hematite is not magnetic but some specimens from Brazil exhibit magnetic effects.

System: hexagonalic.

Formula:  $6[Fe_2O_3]$ .

Luster: metallic or dull.

Colors: reddish-brown to iron-blackish.

Streak: deep red to brownish red.

Diaphaneity: opaque.

Cleavage: none.  $\{0001\}$  parting, and  $\{1011\}$  parting.

Fracture: subconchoidal to uneven. Brittle.

SG: 4.95-526.

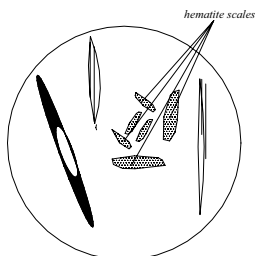
H:  $5\frac{1}{2}$ - $6\frac{1}{2}$ .

Optics;  $\omega$ :3.22,  $\epsilon$ :2.94.

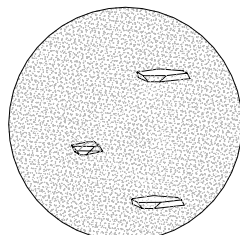
Birefringence: 0.280.  $\ominus$ .

Found: widespread.

**hematite as inclusions;** it is an inclusion in some sunstone and aventurine quartz also in diamond, iolite,



*hematite scales in aventurine feldspar from India*



*hematite crystals in quartz*

opal, enstatite, emerald, topaz, and sapphire.

**hematite cut;** fashioned as trap-cut, brilliant-cut, cut cabochon and beads to imitate black pearl, carving seal stones, and intaglios of ancient cultures warrior's heads and other carved objects, when black to dark gray with metallic luster. Cameos are made as curvette, which is known as *chevee*.

**hematite garnet;** a term applied to deep-red synthetic iron-rich garnet, which when viewed with a strong the almandine spectrum can be seen. SG:4.16. Used as a hematite imitation.

**hematite imitation;** hematite is imitated in various form

*hematite as inclusions – hemimorphic crystal*

with the appearance and color similar to natural stone. Some imitation hematite is attracted by magnetic.

**hematite imitation;** a term for steel-gray synthetic titanium dioxide. SG:4.00, H:5.5. Cherry red streak.

**hematite imitation;** a synthetic stone made of lead sulfide with some silver. G:6.50-7.00. H: $2\frac{1}{2}$ -3. Readily fusible.

**hematite imitation;** an imitation is made from silicon using the pulling method. SG:2.33. H:7.

**hematite imitation;** a steel-gray synthetic *hematite garnet* is made, has an appearance like hematite. SG:4.16.

**hematite imitation;** same as hematine.

**hematite imitation of black pearl;** → hematite.

**hematite quartz;** blood-red plates of hematite as inclusion in some sunstone and aventurine quartz.

**hematite rose;** a group of concretion of hematite crystals



*hematite rose*

resembling a rose.

**hematite scientific synthetic;** same as hematine.

**hematite, synthetic;** → synthetic hematite.

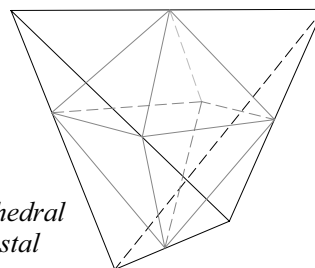
**heme;** → porphyrin.

**hemicon;** means alluvial cone.

**hemicrostalline;** same as hyalocrystalline, partly crystalline or semicrystalline. → Holocrystalline.

**hemicrostalline rock;** a rock, which contains both crystals and glass. Partly crystalline. → Holocrystalline.

**hemihedral;** crystals, which having a lower grade of symmetry and exhibiting half the number of faces



*hemihedral crystal*

required for normal symmetry for that system. Also termed hemihedral crystal, hemisymmetric, merohedral.

**hemihedral crystal;** → hemihedral.

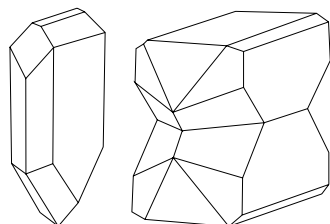
**hemihedral forms;** crystal, which shows only half the number of faces required to correspond in the form of full or normal symmetry for the system, or having only half the number of possible symmetry elements.

**hemimorphic crystal;** a crystal having polar symmetry

or different forms at the two ends of an axis of symmetry. Also called polar crystal or doubly terminated crystal.

**hemimorphism**; the peculiarity of a crystal to have polar symmetry.

**hemimorphite**; a mineral usually associated with smithsonite. Synonym for calamine, electric calamine, galmei. Misleadingly used as a synonym for



*hemimorphite or calamine crystal and twin*

smithsonite. A suitable mineral for collectors and cut cabochon.

System: orthorhombic.

Formula:  $2[\text{Zn}_4(\text{Si}_2\text{O}_7)(\text{OH})_2 \cdot \text{H}_2\text{O}]$ .

Luster: vitreous frequently slightly silky or dull.

Colors: colorless, pale yellowish, greenish, gray, brown, pale blue.

Streak: colorless.

Diaphaneity: transparent to translucent.

Cleavage: {010} perfect, {010} imperfect, and {010} in trace.

Fracture: subconchoidal to uneven. Brittle.

SG: 3.4-3.5.

H: 4½-5.

Optics;  $\alpha$ : 1.614,  $\beta$ : 1.617,  $\gamma$ : 1.636.

Birefringence: 0.022. ⊕.

Dispersion: 0.016.

Found in Spain, Greece, Namibia, Mexico, and USA.

**hemimorphite**; a characteristic example for hemimorphism.

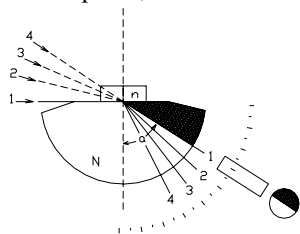
**hemimorphite cut**; → hemimorphite.

**hemin**; → polyene.

**hemiopal**; another term for semiopal.

**hemiprismatic schiller-spar**; same as bronzite.

**hemisphere**; half a sphere, which means half glass or



*hemispheres with different incident light and total reflection*

other mineral sphere of high refractive in nonrotatable mount in the top of refractometer for the measurement

of the refractive index (RI) of any substance, either liquid or solid. Usually determines the critical angle of total reflection as a shadow edge at the surface between liquid and a hemisphere prism of known highly refractive index. *Critical angle* is that angle, at which a ray of light is passing from a dense medium such as a gemstone to one less dense, is reflected at an angle of 90 degrees to the normal. For determination the refractive index of a gemstone it is placing with the facet or a flat smooth face in contact with the reflecting surface of the hemisphere prism. To obtain a good contact between stone and hemisphere prism, a drop of certain contact liquid of highly refractive is placed on the surface of the prism.

**hemisymmetrical**; same as hemihedral, merohedral.

**hemisymmetrical crystal**; same as hemihedral crystal, merohedral.

**hemitetragexahedron**; same as pentagondodecahedron.

**hem pearl**; a type of dark colored pearl frequently found near the margins of the mantle of a shell. They contain a high portion of conchiolin.

**heng**; a Chinese term for a tassel or central top piece of a girdle pendant carved from jade. → Chinese ritual and symbol jades.

**henritermierite**; a member of garnet group.

**Henrietta Maria Queen of England**; who took her jewels to France (1644) to raise money for the Royalists during the Civil War.

**Henry II King of France**; Catherine de Medici's was the dominating wife of Henry II of France.

**Henry IV Portrait**; portrait of Henry IV, King of France engraved on a Beryl.

**hen's egg**; a formerly size expression for hen egg large.

**henwoodite**; a turquoise to greenish-blue copper aluminum-phosphate mineral from Cornwall, England.

**hepatic cinnabar**; a compact, liver-brown variety of cinnabar and idrialite mixture. Also called liver stone.

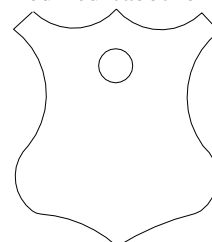
**hepatic mercurial ore**; same as cinnabar.

**hepatic pyrite**; same as pyrite.

**hepatic pyrites**; a mixture of pyrite and marcasite.

**Heracleian stone**; another term for Hercules stone.

**heraldic cut**; a modified cabochon cut form similar to



*heraldic figure-cut*

coats of arms used as amulets and pendants.

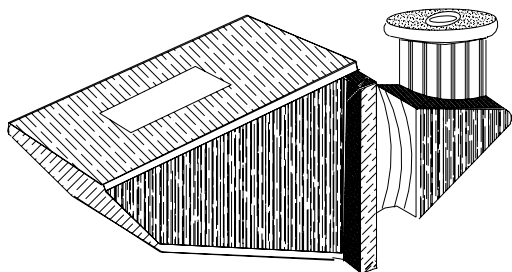
**herapatite**; an active part of polaroid made of quinine

iodosulfate crystallized in hexagonal plates found in very thin plates as 0.12-0.13 mm absorb one ray completely and transmit the other with hardly any absorption.

**herbeckite**; the term applied to the jasper variety of quartz.

**Herbert**; a town in Cape Province, South Africa, in which many small alluvial diamond deposits are located.

**Herbert Smith refractometer**; a small gemological refractometer constructed by Herbert Smith in 1906 as an improved version of the Bertrand refractometer (1885). It employed a segment of a hemisphere of high



*Herbert Smith refractometer*

refractive glass in nonrotatable mount. → Birefringence, refractometer, Tully refractometer, Rayner refractometer, Erb & Gray refractometer, duplex refractometer.

**Hercules stone**; another term for lodestone (magnetite). Also called Heracleian stone.

**Hercules Mine**; location of grossular in San Diego County, USA.

**hercynite**; an opaque, black mineral of the spinel group with the formula  $8[\text{FeAl}_2\text{O}_4]$ . Cubic crystal. Vitreous luster. dark-green streak. Conchoidal fracture. RI:1.77-1.78. SG:4.39. H:7½-8. Found in New York, Virginia, USA, Australia, and Germany. Synonym for iron spinel, ferrosipinel. Also synonym for harmotome, ferrosipinel, iron spinel. It is prized by collectors. Variety is chrome-hercynite.

**hercynite**; a misnomer for harmotome.

**herderite**; a colorless to pale yellow or greenish-white mineral of  $4[\text{CaBe}(\text{PO}_4)(\text{OH},\text{F})]$ . Monoclinic crystal. Transparent to translucent. Vitreous to subvitreous luster. Cleavage: {110} interrupted. Subconchoidal fracture. Optics;  $\alpha$ :1.592,  $\beta$ :1.612,  $\gamma$ :1.623. Birefringence: 0.030.  $\ominus$  or  $\oplus$ . Dispersion: 0.017. SG:2.95-3.02. H:5-5½. Glows orange under UV light and X-rays. Found in Brazil, Russia, Germany, Maine, USA. A suitable mineral for gem cutting. Also called glucinite.

**Herkimer diamond**; a misleading term for gem quality quartz from Herkimer County in New York State, USA. → Hickory Hill diamond, Middleville diamond.

**Herkimer quartz crystal**; gem quality quartz from Herkimer County in New York State, USA.

**hermatype**; same as hermatype coral.

**hermatypic coral**; a term applied to reef-building coral. Also called hermatype.

**Hermes**; → Tabula Smaragdina, the.

**Hermes Trismegetus**; → Tabula Smaragdina, the.

**Hermon Trismegetus**; → Tabula Smaragdina, the.

**heroides**; a variety of aeroides.

**herrerite**; a blue and green copper-stained variety of smithsonite.

**herringbone texture**; a texture showing rows of parallel patterns resembling the lateral skeletal configuration of a herring, which in any two successive rows slope slightly in reverse directions. This pattern may be seen in some gems as inclusions. Also called chevron (mark) cast, zigzag (mark) cast, Vee (mark) cast.

**herringbone cast**; → herringbone texture.

**herringbone mark**; → herringbone texture, chevron pattern.

**herringbone pattern**; → herringbone texture.

**Herscheimer diamond**; a corrupt spelling for Herkimer diamond from Herkimer County in New York State, USA.

**Hertfordshire puddingstone**; the conglomerate consisting of well-rounded pebbles cemented together by a fine-grained ground. Also called puddingstone.

**hesperus**; a term applied to Bohemian emerald. Also spelled hesphorus.

**hesphorus**; same as hesperus.

**hessite**; a term applied to silver telluride in which gold is often present.

**hessonite**; a transparent to translucent yellow-brown or reddish-brown sub-variety of grossular garnet containing iron. Under artificial light it become fiery red. It contains small inclusions that appear as oily-streaks known as treacle. Also called *cinnamon stone* or hessonite garnet (reddish-brown), essonite, hessonite garnet. Misnomerly called Ceylon hyacinth, false hyacinth.

**hessonite garnet**; another term for cinnamon stone. → Hessonite.

**heteroblastic**; a term applied to a type of crystalloblastic texture in a metamorphic rock in which the essential mineral constituents are two or more distinct sizes.

**heterogenous**; a system composed of, or concerned with more than one phase. Unlike. → Homogenous.

**heterogenous equilibrium**; equilibrium in a chemical system consisting of more than one substance or one phase.

**heterogranular**; same as inequigranular.

**heterosite**; → purpurite.

**heteromorphic**; having diversity of form. Also called

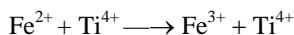
heteromorphous.

**heteromorphous;** same as heteromorphic.

**heteromorphic rock;** a rock of similar chemical composition, but consisting of different minerals.

**heteromorphism;** two magmas of identical chemical composition may crystallize into two different mineral aggregate because of different cooling histories.

**heteronuclear intervalence charge transfer;** involving of two or more metals in a mineral or material such as sapphire in which iron and titanium replacing some aluminum atoms in  $Al_2O_3$  structure. Iron has two different valences  $Fe^{3+}$  and  $Fe^{2+}$ , while titanium has four  $Ti^{4+}$ . If both  $Fe^{2+}$  and  $Ti^{4+}$  are together present, an interaction between both is possible when are located on adjacent Al sites,  $Ti^{4+}$ .  $Fe^{2+}$  by losing one electron converted to  $Fe^{3+}$  now this electron will gaining by  $Ti^{4+}$ , which converted to  $Ti^{3+}$  as describe:



The energy of right hand of equation is greater than left hand, the falling light on blue sapphire is absorbed during the charge transfer of equation. When  $Fe^{2+}$  and  $Ti^{4+}$  are present in some minerals or rocks such as Allende meteorite and regolith containing iron and titanium the color would be dark or black.

**heteropolar bond;** same as electrovalent bond. A molecule, having unequal distribution of bonded electrical charges, so that the constituent atoms differ in their polarity.

**Hetian-jade;** a term misleadingly used for green tremolite from Hetian in Xinjiang, China.

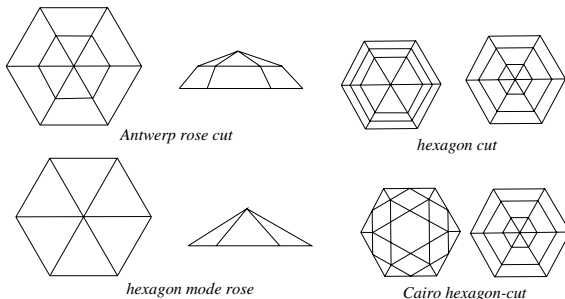
**heulandite;** → stilbite.

**hexa-;** abbreviation used for having 6 atoms, groups or hexagonal crystal system.

**hexad axis;** same as hexagonal axis.

**hexagon;** any polygon shape having six sides.

**hexagon cut;** a style of equi-dimensional six-sided step



*different kind of hexagon-cuts*

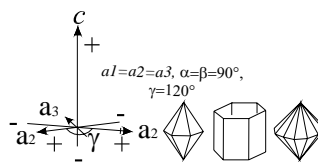
cut of diamond or other transparent gemstones where the outline of the girdle is six-folded, and is bordered by 6 isosceles-trapezoidal facets. Also called hexagonal

cut, oblong hexagon cut, pointed hexagonal cut. → Window cut.

**hexagon cut, oblong;** same as oblong hexagon cut.

**hexagonal;** a solid crystal, in which one long axis intersects other three at right angles, but these three axes are equal, horizontal, and intersect at 60 degree. Also a crystal, which has a six fold symmetry axis. → Hexagonal. crystal system.

**hexagonal crystal system:** a crystal is referred to a system of four axes; three lateral axes are equal, horizontal, and intersect at 60 degree and the fourth one longer or shorter axis,



*hexagonalic system*

intersects the other three at right angles. Also called hexagonal system. → Hexagonal.

**hexagonal cut;** → hexagon cut.

**hexagonal diamond;** same as lonsdaleite.

**hexagonal mineral;** a mineral, which referred to the hexagonal system.

**hexagonal pitting;** large diamond stones with hexagonal pitting, which seem to be typical.

**hexagonal stone;** a stone, which referred to the hexagonal system.

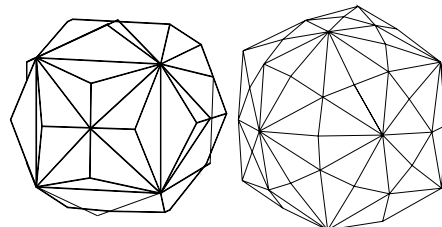
**hexagonal system:** same as hexagonal crystal system.

**Hexagonaria;** → Petoskey stone.

**hexagonite;** an attractive, chatoyant, transparent, pink to purple manganese rich variety of tremolite found at Fowler, St. Lawrence County, New York, USA.

**hexahedron;** a crystal, which referred to the cubic system bounded by six plane faces or a cube.

**hexakis-octahedron;** an equivalent, triangles 48-sided



*hexakis-octahedric crystals*

crystal of cubic system (isometric system) with indices  $\{hkl\}$ .

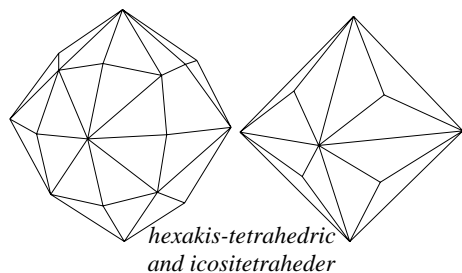
**hexavalent;** a chemical element having six valences for example, manganese with valences of 1, 2, 3, 4, 6, and 7.

**hexoctahedral class;** the highest symmetry class of the cubic system (isometric system). Also called holohedral class, normal class. → Hexakis octahedron.

**hexoctahedron;** one of the seven basic forms of the

cubic system with equivalent, triangles 48-sided crystal with indices  $\{hkl\}$ .

**hextetrahedron**; an equivalent, 24-sided crystal of cubic



*hexakis-tetrahedric  
and icositetraheder*

system (isometric system) with indices  $\{hkl\}$ .

**heyrovskyite**; an orthorhombic mineral of  $2[\text{Pb}_{10}\text{AgBi}_5\text{S}_{18}]$  found as inclusions in some quartz crystal.

**Hf**; a chemical symbol for the element hafnium.

**Hg**; a chemical symbol for the element mercury (Latin: hydrargyrum).

**hibschite**; synonym for hydrogrossular.

**Hickory Hill diamond**; a misnomer for gem quality quartz from Hickory Hill in New York State, USA. It is an alternative term for Herkimer diamond.

**hidaka jade**; a variety of chrome diopside from Hokkaido, Japan, containing small amount of uvarovite, chromite, and pectolite.

**hiddenite**; an emerald-green, yellowish-green, transparent gem variety of spodumene containing chromium from North Carolina, USA. It has strong



*needle-like  
tubes in  
hiddenite*

pleochroism. Erroneously called lithium emerald.

**hidden stone**; in a parcel of stones individual quality of stones collected together. Therefore there may be one or more of worse or better quality, which is hidden until the units are separated.

**hiding power**; → vehicle.

**hieroglyphics intergrowth**; another term for graphic intergrowth. → Graphic granite.

**higa**; a term used for a carving style similar to phallic hand used in 10<sup>th</sup> century in England as an amulet whose importance stretching till today. Also called phallic hand.

**Higgshope**; location of a small alluvial diamond mine in Cape Province, South Africa.

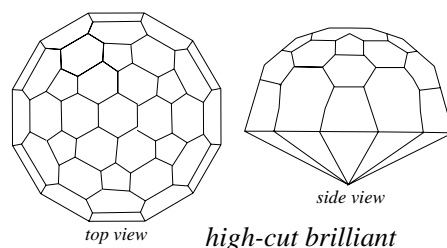
**high-alumina ceramics**; a fired ceramic material, in which the major crystal phase is corundum or alpha alumina.

**high clarity**; a GIA clarity-grading scale for diamonds, which range from flawless (FL) to very slightly included (VS).

**high color**; colorless or nearly colorless diamond.

**high color**; a commercial term for colorless or nearly colorless polished diamond, when set in jewelry.

**high cut brilliant**; a modified brilliant cut, relative high crown similar to cabochon with 36 facets and a 6-sided



*top view*

*high-cut brilliant*

small table and low pavilion with 12 three-sided facets.

**high grade metamorphic**; regional metamorphism accomplished under conditions of high temperature and pressure and resulting in the growth of new minerals and development of completely new textures, for example hornfels or gneiss. Also called high-rank metamorphic,

**high-grade ore**; a term applied to rich ore.

**high-grader**; a term used in USA for one who steals ore from a mine.

**High Priest's Breastplate**; same as Breastplate of High Priest's.

**high purity dolomite**; a term applied to dolomite with more than 97% carbonates.

**high quartz**; same as beta quartz.

**high (temperature) quartz**; same as beta quartz.

**high-rank metamorphic**; → high grade metamorphic.

**high relief**; a technique used in immersion method, when a gemstone such as a colorless quartz with refractive index  $\approx 1.55$  is immersed in water (immersion index of water 1,33), the stone is clearly visible or it has *high relief* or *sharp relief* because of refraction and reflection of light as it moves from one medium to the other medium. If the same stone or colorless quartz immersed in a solution of 1.55 it will be nearly invisible.

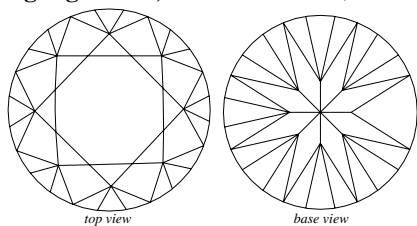
**high relief**; → repoussé.

**high shoulders**; a heart-shaped or pear-shaped cut diamond or other gemstone such has a cross section like tourmaline semi-circular triangle outline. This cut is made in order to retain more weight.

**high zircon;** same as normal zircon. A zircon crystal structure, which is relatively not broken down with maximum values. Optics;  $\omega$ :1.920-1.940,  $\epsilon$ :1.970-2.010. Birefringence: 0.059.  $\oplus$ . Dispersion: 0.039. SG:4.67-4.70. Same as alpha zircon. → Low zircon.

**highlight brilliant cut;** → highlight cut.

**highlight cut;** a brilliant cut, modifies the normal brilliant cut by the addition of eight extra facets to both crown and pavilion. Also called highlight



highlight brilliant-cut

brilliant cut.

**Hill of Precious Stones;** location of sapphire and ruby in Tschantabun, Thailand.

**hillocks;** growth feature seen on the surface of some gemstones which occurring as etch figures, are minute shallow raised areas with the name hillocks such as tourmaline, beryl, etc. → Beryl surface growths features, frosted quartz, tourmaline growth hillocks, tourmaline surface growths, vicinal hillocks on tourmaline.

**Himalaya Mine;** location of spessartite in San Diego County, USA.

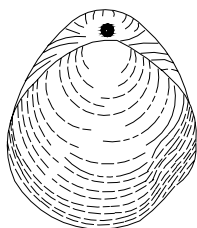
**Hindoo cut;** an Indian style of unsymmetrical over-all faceting diamond to preserve maximum weight and size of the rough material. Also spelled Hindu cut.

**Hindu cut;** same as Hindoo cut.

**Hindustan-jade;** a term used to nephrite, which is cutting in Indian style. Also called Mogul jade.

**hinge;** in conchology a flexible joint between the two valves of the mussel.

**hinge pearl;** pearls of irregular baroque shape from near the hinge of the freshwater mussel. They have two



hinge mussel

pointed ends. Known as dog-tooth pearl or wing pearl.

**Hinjosa topaz;** a misleading term for yellow, yellowish-brown, yellowish-red citrine from Hinjosa del Duero, district of Córdoba, Spain.

**hippopotamus ivory;** a variety of dentine ivory from the incisor and canine teeth of the African

hippopotamus, *Hippopotamus amphibius* a genus of *Pachydermatous quadrupeds* or thick skinned. It is harder and whiter than elephant ivory and it fluoresces a bright violet-blue color under ultraviolet rays.

**historical gemology;** a part of archaeological mineralogy, which studies discovery and production of stones used in man life as ornaments or personal properties.

**historical geology;** a major branch of geological sciences, which is concerned with the evolution of the Earth.

**historical stones;** some gemstones are prized through the ages and legends are built around them and are mentioned or are exhibits today in museums.

**history of gemstones trade;** using of gemstones as mineral varieties, and rock as object of adornment is going back to 40.000 to 50.000 years. Gemstones with a vivid color, metaphysical believing and some other properties be chosen. Gems have played a remarkable influence and role in commercial and cultural life from the beginning throughout history (from ancient times until today). The trade of precious stones as import, export and exchange-trade were very important from ancient time, because of transport of this valuable and compact material such as gemstones, silks, spices, fabrics and other products needed quasi security or safeguard routes. Oldest trade route around precious stones was between Afghanistan because of beautiful blue color of lapis lazuli and ancient Egyptian. → History of synthetic gemstones.

**history of synthetic gemstones;** may be from the beginning of gemstone trade the dealer tried to make synthetic Lapis lazuli and began to glazed steatite with blue enamel and sell as Lapis lazuli because of similar blue color, but modern science considered it as an imitation, however it was first step of the birth of synthetic gems. → Synthetic.

**Hittorf tube;** an early form of X-ray vacuum tube as used by Röntgen in his experiment. When the tube was switched on it fluoresced brightly the screen, during the course, of which he discovered the X-rays.

**hkl indices;** same as Miller indices.

**hmyawdwin;** a Myanmar (Burmese) term used by miners for a mine in a gently sloping hillside, where gems are sorted by hand, when the light loose earth is washed away but heavier gravels and sand remains. Also spelled hmyaudins.

**hmyaudins;** same as hmyawdwin.

**Ho;** a chemical symbol for the element holmium.

**hodgkinsonite;** a very rare purplish-pink to reddish-brown mineral of  $4[\text{Mn}_{+2}\text{Zn}_2\text{SiO}_5 \cdot \text{H}_2\text{O}]$ . Monoclinic system. Transparent to translucent. Vitreous Luster. Cleavage: {001} perfect. Brittle. Optics;  $\alpha$ :1.720,

$\beta$ :1.741,  $\gamma$ :1.746. Birefringence: 0.026.  $\ominus$ . SG:3.91-3.99. H:4½-5. Distinct pleochroitic in lavender, colorless and lavender. Luminescence: dull red under LWUV.

Found in New Jersey, USA. It is prized by collectors.

**hoe into the toe**; an informal term used by Australian miners pick down towards the bottom of the face, there may be opal in the toe and under the roof.

**hog ivory**; a variety of ivory obtained from hogs of genus *Suidae* such as boar and the wart-hogs curved teeth, the ivories are coarse grained and small.

**Hoge Raad voor Diamnat vzw, Belgium**; a non-profit organization of Belgium diamond industry formed in 1973. Also called Diamond High Council, Belgium. Abbreviation: HRD.

**hogtooth spar**; same as dogtooth spar.

**ho Hsien-Ku**; a Chinese term used for a woman symbol carved on jade with a stem of lotus flower as an immortality sign. → Chinese ritual and symbol jades.

**ho Hsien-ku**; an immortal Chinese female figure made of Jade after she ate one of the magic peaches of immortality.

**Hokkaido**; a jadeite bearing rock found from central Hokkaido, Japan.

**hold**; a term used by Australian miners for color of opal remains when the stone is viewed from different directions slightly than fade away quickly or may die.

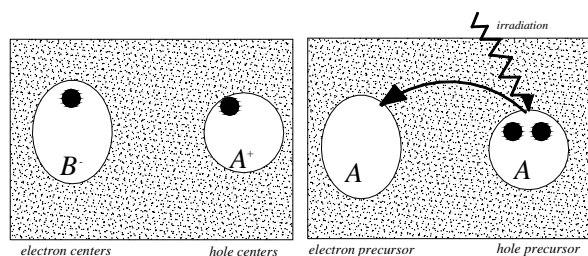
**hole color center**; → hole center.

**Holbrook Ruby mine**; same as Gregory Ruby mine.

**hole**; in crystallography: vacancy. → Lattice, defect in, F center.

**hole**; in geology, gallery or chamber or series of them beneath the Earth's surface, sometimes in the side of a mountain hill which is open to the surface.

**hole center**; in crystal optics, displacing of one of pair electrons from an atom, ion, molecule, impurity or



*hole and electron centers in crystal.*

*After Nassau 1983*

blemish formed a hole due to irradiation. When the both centers (hole center and electron center) were neutral, displacing of electron formed a negative charge in electron center and a positive charge in hole center, therefore leaving a single unpaired electron in

each center. Now one or both unpaired electrons may be excited by absorbing energy from white light, which produced color. If the hole center is responsible for color named as *hole color center*.

**hole gauge**; a diamond gauge constructed of a thin sheet of metal or celluloid (the metal types often being in the form of folding leaves), in which are a series of differently sized holes or circulars marked in cts, weights. Usually used for unmounted diamonds. → Diamond gauge

**Holland Diamond**; reportedly a conical-shaped diamond of 36 cts, belonging to the Crown Jewels of the Netherlands. Possibly, this is the Bantam Diamond, Auckland Diamond, Cone Diamond.

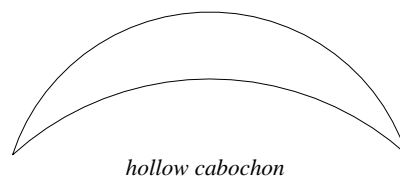
**Holland rose cut**; same as Dutch rose cut.

**Hollebak Mine**; location of marine diamond deposits along the Namaqualand coast, South Africa.

**hollow**; same as shell crystal.

**hollow doublet**; a doublet, with a concave depression hollowed out of the bottom section of the stone or of the top section and filled with colored liquid or other material to improve the effect or lightened the color.

**hollow cabochon**; a cabochon-cut, which has a concave



depression hollowed out of the bottom section to improve or lighten the color.

**hollow dop**; a cup-shaped copper dop to hold the culet of a diamond, when bruting.

**hollow pearl**; a misleading term for wax-filled pearl imitation made of glass.

**hollow relief**; → intaglio.

**holmium**; a rare-earth metallic element of the Periodic System with the symbol Ho.

**holmium-aluminum-oxide**; a gold-yellow, garnet-type synthetic diamond substitute made of  $\text{Ho}_3\text{HoO}_{12}$  or  $3\text{Ho}_2\text{O}_3 \cdot 5\text{Ho}_2\text{O}_3$ . Cubic. RI:1.863. SG:6.30. H:6. No counterpart exists in nature.

**holo**; a prefix used as complete, whole, or entirely.

**holoaxial**; classes of crystals refer by axes of symmetry only. → Holohedral.

**Holocene**; same as Quaternary or Recent.

**holocrystalline**; same as holocrystalline rock. Also called pleocrystalline.

**holocrystalline rock**; an igneous rock consisting entirely of crystalline particles, having no part glassy.

**holocrystalline porphyritic**; a porphyritic igneous rock

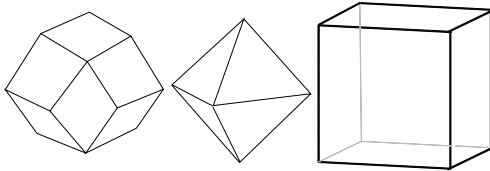
having completely fine crystalline groundmass.

**holohedral;** a crystal of a crystal class, which has the full or maximum symmetry of its crystal system.

**holohedral class;** same as hexoctahedral class.

**holohedral crystal;** → holohedral.

**holohedral forms;** a form of crystal, which exhibits the entire number of symmetrically arranged faces. →



*holohedral crystal forms*

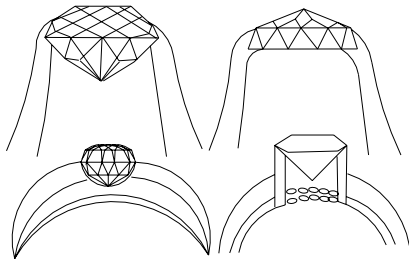
Holohedral.

**holohedron;** those crystals, which exhibit the entire number of faces. → Holohedral.

**holohedral crystal;** → holoaxial, holohedral.

**holohyaline;** an igneous rock that consists completely of glass.

**hololith ring;** a finger ring fashioned in the form a



*hololith rings*

single piece of stone such as quartz, jasper, jade, etc.

**holomorphic;** a form of holocrystalline crystals.

**holosiderite;** an iron meteorite consisting of metallic iron without stony material.

**holosymmetrical crystal;** same as holohedral crystal. → Holohedral.

**holosymmetric classes;** → holohedral.

**Holpan;** location of a small alluvial diamond mine in Cape Province, South Africa.

**holstein;** a term applied to fossil wood or petrified wood.

**holtite;** a silicate mineral related to dumortierite. It is rarely fashioned.

System: orthorhombic.

Formula:  $4[(Al,Fe)_7O_3]BO_3[(AS,Si)O_4]_3(O,OH)_3$ .

Luster: vitreous, resinous to dull.

Colors: white to cream, brownish, greenish to olive-green.

Streak: colorless.

Diaphaneity: translucent.

Cleavage: {010} distinct.

SG: 3.90.

H: 8½.

Optics;  $\alpha$ :1.742-1.746,  $\beta$ :1.756-1.758,  $\gamma$ :1.758-1.761.

Birefringence: 0.021. ⊖.

Dispersion: 0.015.

Found in Western Australia.

**holtite luminescence;** dull orange fluorescence under SWUV light and pale yellow under LWUV light.

**holtite pleochroism;** yellow, colorless and colorless.

**Holy Grail;** a famous shallow, circular Grail or dish made 12.5cm high and 36cm in diameter made of antique green glass with gas bubbles. Preserved in the sacristy of the Cathedral of San Giovanni in Genoa, Italy. Also called Sacra Catina, Sacred Vessel. It was declared as emerald.

**Holy Roman Crown Jewels;** in the Weltliche Schatzkammer of Hofburg in Vienna, Austria are gem-studded crown of Istvan Bocskay and other pieces on display. The crown was a present from Sultan Achmed I., Turkey, in which some emeralds are seen.

**Holzstein;** a German term applied to fossilized wood or petrified wood.

**Homansvlei;** location of a small alluvial diamond mine in Transvaal Province, South Africa.

**homogeneous;** a gem mineral, which is composed of similar chemical elements. → Heterogenous. Also called uniform.

**homogeneous equilibrium;** equilibrium in a chemical system consisting of only one phase.

**homogranular;** a term applied to a texture of a rock having crystals of nearly the same size.

**homojunction laser;** a term used for a laser diode, which is composed of *n-p* type regions from the same semiconductor.

**homonuclear intervalence charge transfer;** in a crystal structure involved charge transfer colors derived from interaction between two metal atoms of same element but in different valence with a single transition such as moving from iron, which has two different valences  $Fe^{3+}$  and  $Fe^{2+}$ , so as change their charges by itself and no change in the energy. In this process result no absorption of light. There will be energy different between the two iron atoms arrangements when they are on different types of sites.

**homopolar bond;** one, in which two atoms share electrons to form an electron pair so that the dipole moment equals zero, for example diamond. Also called covalent bond. → Heteropolar, atomic bond.

**homopolar crystal;** a crystal, which consists entirely of covalent bonding.

**Honan jade;** a misleading term for serpentine or soapstone. → Soochow jade.



**Hondeklip Bay;** location of marine diamond deposits along the Namaqualand coast, South Africa.

**Hondsriever;** location of a small alluvial diamond mine in Transvaal Province, South Africa.

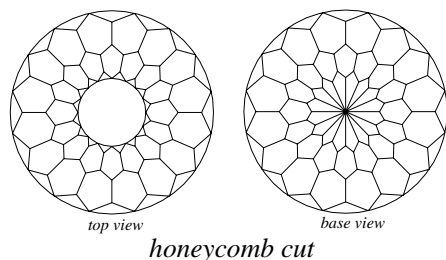
**Honduran opal;** opal of gem quality from Honduras

**hone;** a block of fine abrasive material used to sharpen cutting tools, generally synthetic SiC.

**hone;** indurated sedimentary rock, which is used for fine grinding, particularly of internal bores and flat faced lap. Hone or honestone has been largely replaced by emery, silicon carbide, borazon, etc. Also called honestone. → Novaculite, whetstone.

**honestone;** a stone suitable for making hone.

**honeycomb cut;** a style of cut, which presents a mixture



between the brilliant and rose cut.

**honeycombed;** having a small cell-like or pitted surface, as a honeycomb. Also called alveolar. → Honeycomb structure.

**honeycomb pattern;** → quench crackled synthetic corundum.

**honeycomb stone;** any fossils that compound corals.

**honeycomb structure;** a rock which having cell-like forms similar to a honeycomb. Also called alveolar structure.

**honey opal;** a translucent honey colored, non-iridescent opal with fire effect from Querétaro, Mexico.

**honey stone;** synonym for mellite. Also spelled honeystone.

**honeystone;** → honey stone, mellite.

**Hong Kong Diamond Bourse, Ltd.;** Chinese or Asian diamond bourse. a member of the world Federation of Diamond Bourse.

**Hong Kong Gemmological Association;** same as Gemmological Association of Hong Kong.

**Hong Shan-jade;** a misleading term for antigorite.

**Hool Babuchil;** a Spanish-Mexican local term meaning head amber.

**hooked up for air;** an informal term used by Australian miners when two shafts on one claim are joined by an air drive in which air may flow down one and up the other.

**Hooker Emerald;** a square step-cut emerald of fine quality of 75 cts, once set in a belt buckle of Abdul-Hamid II of Turkey. It was presented from Mrs.

Stewart Hooker to National Museum of Natural History in Washington, D.C. USA.

**Hope Aquamarine?;** allegedly an aquamarine of Hope Collection of 341.00 cts, from Russia. Now on display at Chicago field Museum of Natural History, USA.

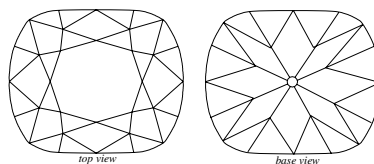
**Hope Blue diamond;** → Hope diamond.

**Hope Cat's-eye;** a chrysoberyl cat's-eye effect nearly a hemisphere in shape with a diameter of 37mm, once belonged to the Henry Philip Hope Collection.

**Hope Chrysoberyl;** a yellowish-green, oval brilliant-cut chrysoberyl, absolutely flawless of 45 cts, once in the Henry Philip Hope collection. And now exhibited in the British Museum Gallery Minerals (Natural History), since 1866. → Hope Collection.

**Hope Collection;** gems and diamond collected by wealthy British Banker Henry Philip Hope in the early 19<sup>th</sup> century, which included a in 65 mm and 114 mm length pearls, a in 37 mm cat's-eye chrysoberyl, a fine fire opal of 32 cts, carved as the head of Mexican sun god, and a of 45 cts, absolutely flawless chrysoberyl. 41 Pieces of uncut fancy diamonds, and numerous other diamonds. The collection was inherited by Henry Thomas Hope (1808-1862). Later Francis Hope (1866-1941) who in 1928 became the 8<sup>th</sup> Duke of Newcastle, and after bankruptcy sold the Hope Diamond in 1901, and chrysoberyl had been sold in 1866. The 62 piece uncut diamonds bought by James Tennant and later sold to British Museum, Museum of Natural History in 1849.

**Hope Diamond;** a deep sapphire-blue, cushion-shaped diamond of 45.52 cts, with 60 facets plus facets on the girdle from India.



Hope Diamond

It is believed to have been a part of the Tavernier Blue. Probably cut from a stone of 112.25 cts, so-called Mogul-cut

Tavernier Blue Diamond or Blue Diamond of the Crown. Named after Henry Philip Hope, who bought it in 1830. It was inherited by Thomas Hope and later by Francis Hope. In 1949 purchased by Harry Winston and in 1958 presented to the Smithsonian Institution in Washington, D.C. Known as Hope Blue Diamond. → Hope Collection.

**Hope Emerald;** between Hope Collection it was a square cushion-cut emerald of light green of approximately 172 cts, from East Indies. One belonged to Sultan of Mysore.

**Hope of Africa;** a yellow brilliant-cut diamond of 151.91 cts, from South Africa.

**Hope Opal;** same as El Aguila Azteca opal.

**Hope Pearl;** a nearly cylindrical pearl of 450 cts, (1800 pearl grains), 51 mm in length and 114 mm in circumference at the thicker end, 8.30 cm at the thinner end with a slight swelling at one end similar to an aubergine. White at one end and greenish-brown at another end with a fine orient. Once in the Hope collection. It is believed that it may have been one of the French Crown jewels. → Hope Collection.

**Hope Persian Emerald;** among Hope Collection was an emerald of 22 x 18 mm engraved with Persian script. Now on display at Townshend Collection of the Victorian Albert Museum, London.

**Hope sapphire;** a commercial misleading term for blue synthetic sapphire, which turns color to purple in artificial light.

**Hope sapphire;** a misleading trade term for blue synthetic spinel, which changes color to pink in artificial light.

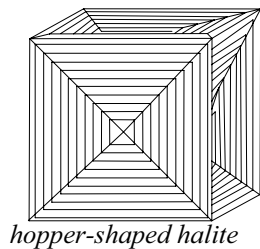
**Hope star;** a commercial term for various colored synthetic star sapphires made in Freyung, Germany.

**Hope stone;** a commercial term used by Americans for synthetic corundum or spinel.

**Hopetown;** location of a minor alluvial diamond deposits in Cape Province, South Africa.

**Hope Town diamond mining;** location of a diamond mining company from South Africa.

**Hopper crystal;** cube-shaped crystal of halite (rock salt) where the faces of the cube are grown more at the edges than in the center.



**Hopton marble;** same as Hopton wood marble.

**Hopton Wood marble;** a granular marble, in which the markings assume the appearance of a bird's-eye, caused from encrinital fossils. Also called *petite granite*. → Encrinital marble.

**Horatio diamond;** a misleading term for rock crystal from Arkansas, USA.

**horizon;** a term used by Australian miners for the horizon along which opal is expected. A shortened term for opal horizon.

**horizon glass;** a glass that is a half silvered and the other half plain, used to measure angles up to about 120°. Also called sextant.

**horizontal banding;** a term used by Australian miners for horizontally stratified of different kind opal gel

tending to settle in layers to form opal or potch.

**horizontal microscope;** a type of microscope constructed in the horizontal position used in gemology for study of internal and external features of stones with a special holder for gems in a vertical position.

**horizontally layered;** horizontally stratified.

**horn;** bones of certain rhinoceros or the deer family that have been used instead of ivory or amber for small carvings, and particularly for inlays, netsukes of Japan. RI 1.56. SG:1.70-1.85. H:2½.

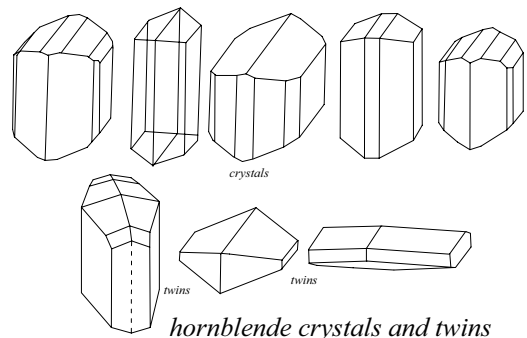
**horn;** black stained horn used as a jet imitation because it is light in weight, easy to work and thermoplastic. After staining become glossy black color but not a jet deep black color, often resembles vulcanite. Some pieces are inlaid with mother-of-pearl. Also used as amber imitation for making beads may stained in yellow gold color.

**horn;** a horn shaped gem.

**horn beads;** → horn.

**hornbill ivory;** a horny material obtained from the beak of the helmeted hornbill bird *Rhinoplax vigil* from Indonesia. RI 1.55. SG:1.28-1.29. H:2½. Used for snuff bottles and other objects.

**hornblende;** an important rock forming mineral of amphibole group of double chains silicates. Obsolete synonym of hornstone. Varieties are anophorite,



carinthine, and kaersutite. Pleochroism is variable shade of green and brown. → Actinolite.

System: monoclinic.

Formula:  $2[\text{Ca,Na,Mg,Fe,Al}]_{7-8}(\text{Al,Si})_8\text{O}_{22}(\text{OH})_2$ .

Luster: vitreous to silky.

Colors: greenish-black or black, brown-black.

Streak: colorless.

Diaphaneity: translucent to nearly opaque.

Cleavage: {110} good.

Fracture: subconchoidal to uneven. Brittle.

SG: 3.02-3.27.

H: 5-6.

Optics;  $\alpha$ :1.615-1.705,  $\beta$ :1.618-1.714,  $\gamma$ :1.632-1.730.

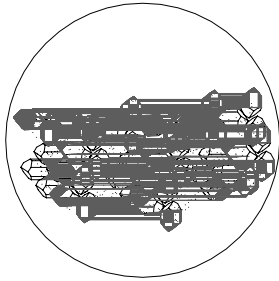
Birefringence: 0.085. ⊕.

Found: widespread.

**hornblende andesite;** an andesite rock containing

abundant hornblende. Formerly was named as hungarite.

**hornblende as inclusions;** hornblende as inclusions are seen in topaz, tourmaline, almandine and opal.



*disordered hornblende in almandine-garnet*

**hornblende gabbro;** another term for orbicular diorite.

**hornblende gneiss;** a coarse-grained metamorphic rock, containing hornblende, which changes the color of the rock together with feldspar, quartz, etc.

**hornblende granite;** a type of granite, or granodiorite, containing hornblende.

**hornblende jade;** sometimes used for smaragdite.

**hornblende labrador;** a synonym for hypersthene with labradorite effects.

**hornblendite;** a coarse-grained granitoid igneous rock composed essentially of hornblende and analogous to pyroxene.

**horn coral;** same as black coral.

**Hornby Diamond;** reportedly a diamond of 36 cts, from India, it is now believed to be in Iran Treasure, Tehran. However reported in 1966 (V. B. Meen) that a trapezoid diamond of 38.18 cts, was among the National Jewel Treasury of Iran, Tehran, and this could be the Hornby.

**hornfels;** a fine-grained granular rock formed from shales and impure limestone in contact metamorphism (rarely regional), consisting essentially of quartz, micas, and feldspars, and rarely andalusite, cordierite, and pyroxene or amphibole. Generally is a holocrystalline rock.

**horn of the unicorn;** tooth ivory obtained from the incisor tusk of the narwhal.

**hornstone;** a compact, fine-grained, translucent, gray to brown, brittle flint variety of chalcedony, which was artificially colored blue and used as an imitation of lapis lazuli by the lack of pyrite inclusions. Varieties are apricotine and jasper. Also called chert, novaculite. This name should not longer be used.

**hornstone;** an obsolete term for hornblende. This name should not longer be used.

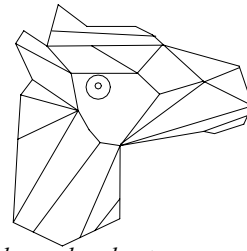
**horse-flesh ore;** a term applied by Cornish miners to bornite.

**horse head cut;** a modified fancy form of diamond cut

*hornblende as inclusions – hot point test*

with outline similar to a horse.

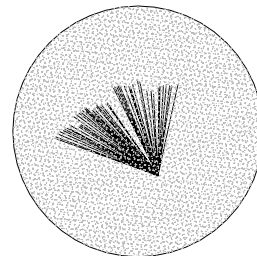
**horse-radish odor;** when selenium compound minerals are



*horse-head cut*

heated smelling like decaying horse-radish.

**horsetail inclusion;** tiny silky asbestos fibers forming



*horsetail inclusions in demantoid*

often radiating horsetail inclusion in demantoid garnet.

**Hortensia Diamond;** a fine five-sided, peach-colored diamond of 20.53 cts, from India. It was stolen in the robbery from French Royal Treasury in 1792, but recovered. Worn by Hortensise de Beauharnais, daughter of the Empress Josephine and Queen of Holland. Now exhibited in the Louver Museum, Paris, France.

**host;** a term applied to an essential crystal, base substance, or matrix of luminescence. Also called palosome.

**host crystal;** a crystal or mineral that contains the inclusions of smaller crystals of different minerals or may be is the same as host mineral. Also called palosome mineral.

**host mineral;** → host crystal.

**hot-cast porcelain;** same as opalite.

**hot cathode;** another name for electron microscope and electron microprobes, which are used as cathodoluminescence of gemstones. → Cold cathodes.

**hot mill;** to heat metal for forming or shaping.

**hot mold;** a technique of forming glassware when it is hot.

**hot-point reaction of plastics;** peculiar because it will melt or char when touched with the heated usually point with acrid odor or vinegar, formaldehyde, sweet fruit, sour milk, fish, camphor, and carbolic acid. → Plastics properties.

**hot-point test;** if an electrically heated hot metal point is brought near of the surface of an unknown mineral the

nature of the vapors given off may be analyzed for color and odor, such as sulfur or selenium consisting minerals or wax- and plastic-impregnated gemstones such as turquoise, amber, jet, etc. → Hot-point tester.

**hot-point tester;** an instrument, which is built for the hot-point test unknown or wax- and plastic-impregnated gem material. → Hot-point test.

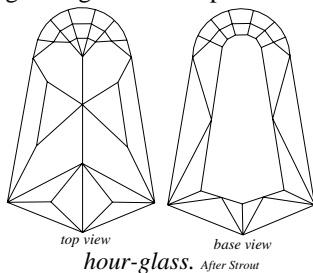
**hot spot;** an area or point caused by external and internal reflections from the facets in a transparent gemstone when light passes through the stone, which may sometimes darkened the interior part of the brilliant-cut gemstone during testing under gemological microscope when a gemstone placed table down on the microscope stage except for culet, if it is present. For passing more light through the gem used resting the stone on a pavilion facet while a large portion of interior cannot be examined but the stone can turned several times. The problem will be more less by using of immersion liquid or specialized illumination device and techniques.

**hot spot;** an area or zone of highest temperature caused within a glass melting furnace.

**hot spot;** a small area or zone in a furnace shell which is higher in temperature than the rest.

**Hot Spring diamond;** a misleading term for quartz crystal from Arkansas, USA.

**hourglass cut;** a term used for a modified brilliant cut resembling hourglass in shape with 29 facets in the



crown and 24 facets in pavilion with a large culet.

**hourglass-shaped inclusion;** a term used for hourglass-shaped feature seen as internal graining in Itami synthetic diamond from Japan.

**house cat stripes;** → cross-hatch effect.

**howdenite;** large crystals of chiastolite, a variety of andalusite from Mt. Howden, South Australia.

**Howeson Diamond;** reportedly a sapphire blue diamond of 24 cts, which belonged to John Howeson of London.

**howlite;** an opaque, massive mineral used for ornamental and utilitarian articles. Sometimes stained blue as a simulant for turquoise, because of porosity.

System: monoclinic.

Formula:  $4[\text{Ca}_2\text{B}_5\text{SiO}_9(\text{OH})_5]$ .

Luster: subvitreous.

Colors: white veined brown or black and dendritic.

Streak: colorless.

Diaphaneity: opaque.

Fracture: porcelaneous, even and smooth.

SG: 2.45-2.58.

H:  $3\frac{1}{2}$ .

Optics;  $\alpha$ :1.584,  $\beta$ :1.597,  $\gamma$ :1.605.

Birefringence: 0.021.  $\ominus$ .

Found in California, USA, and Mexico.

**howlite absorption spectrum;** absorption spectrum 680 nm.

**howlite luminescence;** brownish-yellow fluorescence under SWUV, some pieces from California glows deep orange under LWUV.

**HRD;** an acronym for Hoge Raad voor Diamnat, Belgium.

**Hsi jade;** a Chinese term for clear water or clear black jade.

**Hsieh jade;** a Chinese term for ink black jade.

**Hsichwan-jade;** a Chinese mislabeled term for tiger-eye or crocidolite variety of asbestos.

**Hsiu Yen;** a Chinese term for green and white jasper.

**Hsiu Yen-jade;** a misleading term for antigorite.

**Hsiu Yen-jade;** a misleading term for chrysotile. Also called new jade.

**Hte long sein-jade;** a Chinese term for jadeite rock consisting almost of jadeite with some amphibole and kosmochlor. Also called Maw-sit-sit.

**hu;** a Chinese term for a carving tiger figure made of jade used as an offering to the god of the West. → Chinese ritual and symbol jades.

**huan;** a Chinese term for a carving disc of jade with a hole in center for a rim equal to both sides of the central hole used as a symbol of unity or reunion, also used as bracelet. → Chinese ritual and symbol jades.

**huang;** a Chinese term for a carving half disc jade used in worship celebrating of the God of the North. Frequently carved from black jade. → Chinese ritual and symbol jades.

**huang ritual jade;** a Chinese term used for possibly a semi-circular looked like half a pi with the black color to symbolize the water and reverence to the North. → Chinese ritual and symbol jades.

**huashi;** a Chinese term for green talc used as jade.

**hue;** The characteristic color that is determined by its wavelength as red, green, blue, purple, yellow, etc., and excludes white, black, and shades of gray in reference to the visible spectrum of light; tint: a shade of color, special a pale one; pale hue. → Color,-definition.

**hübnerite;** or huebnerite. An end-member mineral of wolframite series with formula  $2[\text{Mn}^{+2}\text{WO}_4]$ . Monoclinic crystal. Transparent to translucent. Reddish-brown, brownish-black to deep red. Streak: yellowish to reddish brown or greenish. Cleavage: {010} perfect.

Uneven fracture. Brittle. Optics;  $\alpha$ :2.18,  $\beta$ :2.22,  $\gamma$ :2.30-2.32. Birefringence: 0.014.  $\oplus$ . SG:7.25. H: 4-4½. Found in Peru, the Czech Republic, Nevada, Idaho, Arizona, USA. It is prized by collectors Also spelled huebnerite.

**huebnerite**; another spelling for hübnerite.

**hu fu**; a Chinese term for a carving tiger figure made of jade used by authorities in the mobilization of troops. Same use as yu fu. → Chinese ritual and symbol jades.

**Huge Tourmaline Crystal**; a black tourmaline or schorl of 8 kg from Overlook, New York, USA. Found in 1942? Present whereabouts unknown.

**Hughes emerald**; synthetic greenish-blue emerald manufactured by Hughes Research Laboratories, Malibu, California, USA. Optics;  $\omega$ :1.561-1.562,  $\epsilon$ :1.566-1.567.

**huinzo**; a Peruvian Indian term for lapis lazuli.

**hulls**; a descriptive term for very thin outer covering of a pearl or tooth.

**humboldtine**; same as oxalite.

**humidity determination with cobalt salt**; → cobalt salt as humidity determinant.

**humite**; a member of humites group. Yellowish to deep red pleochroism. Fashioned as gem. → Humites (group).

System: orthorhombic.

Formula:  $4[(Mg,Fe)_7(SiO_4)_3(OH,F)_2]$ .

Luster: vitreous.

Colors: white, deep orange, yellow.

Streak: colorless.

Diaphaneity: transparent to translucent.

Cleavage: {110} distincts.

Fracture: subconchoidal to uneven. Brittle.

SG: 3.20-3.30.

H: 6-6½.

Optics;  $\alpha$ :1.607-1.642,  $\beta$ :1.639-1.675,  $\gamma$ :1.639-1.675.

Birefringence: 0.029-0.031.  $\oplus$ .

Found in Spain, Italy, Sweden, Norway, and New Jersey (USA).

**humites (group)**; a term for mineral Humite.

**humites (group)**; a name applied to a group of minerals such as humite, norbergite, chondrodite, and chondrodite.

**hammer stones**; quartz pebbles from Millstone grit, Yorkshire, England.

**hummocky**; small uneven knolls of mineral or rock. Lumpy.

**Hungarian cat's-eye**; a misleading term for an inferior greenish quartz with cat's-eye effect from Bavaria, Germany.

**Hungarian opal**; a milky-white precious variety of opal with fine play-of-color from Cervencia (Czerwenitz) mines in the Czech Republic. Also called white opal.

**Hungarian Opal, the**; pear-shaped opal of 481.933 grams or 2,409.75 cts, (17 oz) from Cervencia (Czerwenitz) mines in the Czech Republic. It was mounted in a gold pendant. Now on display in the Schatzkammer of the Hofburg, Vienna, Austria.

**hungarite**; a misnomer for hornblende andesite.

**hunzanite**; a local term for emerald-green chrome diopside from Hunza Valley, Pakistan. Some cloudy pieces shows cat's-eye effect, when cut cabochon.

**hu peh**; a Chinese term for tiger amber, a kind of transparent, brown striped amber.

**hu-p'o**; a Chinese term for amber, meaning soul of tiger.

**hupomorphic mineral**; minerals are typically formed in only a narrow of temperature and pressure.

**huréaulite**; a hydrous phosphate mineral. Cut as beads and cabochons. Also called bastinite, palaite.

System: monoclinic.

Formula:  $4[(Mn,Fe)_3H_2(PO_4)_4 \cdot 4H_2O]$ .

Luster: vitreous to greasy.

Colors: colorless, pale yellowish to pale rose, yellowish-red, violet-rose.

Streak: nearly white.

Diaphaneity: transparent to translucent.

Cleavage: {100} good.

Fracture: uneven. Brittle.

SG: 3.20.

H: 3½.

Optics;  $\alpha$ :1.637-1.652,  $\beta$ :1.645-1.658,  $\gamma$ :1.649-1.663.

Birefringence: 0.012.  $\ominus$ .

Found in USA, France, Poland, Germany, Portugal, and Austria.

**hu ritual jade**; a Chinese term used for a pattern similar to tiger with white color to symbolize the metal and reverence to the West. → Chinese ritual and symbol jades.

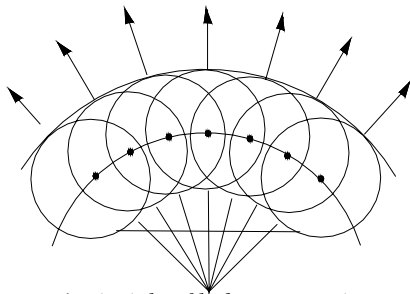
**hurlbutite**; a suitable mineral to cut. Formula:  $4[CaBe(PO_4)_2]$ . Orthorhombic crystal. Transparent to translucent. Vitreous to greasy luster. Colorless, to greenish-white. Streak white. Conchoidal Fracture. Brittle. Optics;  $\alpha$ :1.595,  $\beta$ :1.600,  $\gamma$ :1.604. Birefringence: 0.009.  $\oplus$ . SG:2.88. H:6. Found in New Hampshire, Newport, Chandler's Mill, USA.

**Huygenian eyepiece**; a lens system used in microscopes, which consists of two planoconvex lenses both placed with their surfaces opposite the incident ray by the half sum of their focal lengths. Also known as a negative eyepiece. → Huygenian ocular, Huygenian principle.

**Huygenian ocular**; an eyepiece constructed by Huygenian for use in microscopes consisting of two planoconvex lenses placed with their domed surface towards the incident light. The distance of the two lenses from each other is equal to half the sum of their

focal lengths. Also called Huygenian eyepiece. → Ramsden eyepiece.

**Huygenian principle;** a wave theory of light in optics means that every element of a wavefront acts as a



*Huygens' principle of light propagation. After Nassau 1983*

source of secondary waves, which applied to propagation of light or any wave motion. → Huygenian ocular.

**huzrul haiya;** an Egyptian term emerald.

**hyacinth;** an orange-red, reddish-orange, or reddish-brown gem variety of transparent zircon. Many of them are heat treated. The term is applied interchangeably to jacinth, it mean yellow-orange, yellow, red, or brown zircon. Misnomerly a variety of hessonite garnet is called as *false hyacinth*, *Ceylon hyacinth* or *oriental hyacinth* Also spelled jacinth. → Giacinto.

**hyacinth;** a misleading term for red-orange, or brownish gem variety of hessonite (essonite). Also called hyacinth garnet, hyacinthoid, jargon, hyacinth topaz.

**hyacinth;** an old popular collective term for sapphire which was listed with other stones of not always blue color such as topaz, quartz, zircon, etc.

**hyacinth;** loosely used to signify any zircon.

**hyacinth;** → sapphire, name of.

**hyacinth confection;** → giacinto.

**hyacinth de Ceylon;** a term used by French jewelers for gem quality hyacinth garnet.

**hyacinth garnet;** same as hessonite.

**hyacinth of Compostela;** a misleading term for opaque, reddish-brown quartz citrine from Santiago de Compostela, Spain.

**hyacinth of Vesuvius;** a misleading term for brown to yellow variety of vesuvianite from Mt. Vesuvius, Italy.

**hyacintozontes;** a sapphire-blue variety of beryl. Also spelled hyacintozontes.

**hyacinth quartz;** a misleading term for a reddish to reddish-brown variety of quartz citrine.

**hyacinth sapphire;** a misleading term for a red to reddish-orange sapphire.

**hyacinth topaz;** a misleading term for reddish-brown hyacinth a variety of zircon.

**hyaline;** the texture of certain extrusive igneous rock,

which is similar to broken glass. It is formed as a result of rapid cooling of the lava. Glassy, or non-crystalline. Any transparent to translucent glassy substance. Also called glassy, vitreous.

**hyaline;** synonym for hyaline quartz.

**hyaline;** a term applied to amorphous mineral.

**hyaline quartz;** a bluish opalescent milky quartz caused by the presence of chalcedony, used as a gemstone.

**hyalinocrystalline;** an igneous porphyritic rock textures, in which the phenocrysts are embedded in a nearly equal glassy groundmass. Synonym crystallohyaline.

**hyalite;** a colorless, transparent to translucent variety of common opal with sometimes a bluish light reflected from inside the stone, which occurs in botryoidal or globular (resembling drops of melted glass) crusts or stalactitic shape. Synonym for water stone, *water opal*, *glass opal*, *Müller's glass*, *glassy*.

**hyalite;** a technical term used by Australian miners for *glass opal*, *water opal*, *glass opal*, *Müller's glass*, *glassy*.

**hyalite;** also undesirable synonym of axinite. → Hyalite opal.

**hyalite opal;** a clear glass variety of common opal is found in the coating or filling of geodes of basaltic igneous rocks. → Hyalite, glassy.

**hyalithe;** a commercial term for a red, green, black, brown opaque glass, which resembles porcelain.

**hyalo-;** a prefix that indicate a glassy nature, clear, transparent.

**hyalocrystalline;** a rock, which contains both crystals and glass. Also called hemicrystalline, semicrystalline.

**hyalography;** any engraving, writing or art on glass either with a diamond, emery, or hydrofluoric acid.

**hyalomelane;** a volcanic basaltic glass. A basaltic vitrophyre.

**hyalo-ophitic;** a term applied to a rock fabric of glassy nature, which molded around crystals of plagioclase.

**hyalophane;** a rare barium feldspar intermediate in composition between celsian and orthoclase. Formula:  $4[(K,Na,Ba)(Al,Si)_4O_8]$ . Monoclinic crystal. Transparent to translucent. Colorless, white, reddish. Vitreous luster, on cleavage pearly, resembling adularia. Conchoidal to uneven fracture. Brittle. Cleavage: {001} perfect, and {010} distincts. Optics;  $\alpha$ :1.52-1.542,  $\beta$ :1.524-1.545,  $\gamma$ :1.526-1.547. Birefringence: 0.05-0.010.  $\oplus$  or  $\ominus$ . SG:2.58-2.88. H:6-6½. Found in Russia, Switzerland, and USA. A chalky or glazed coating variety is called magic stone. Sometimes cut cabochon and prized by collectors.

**hyalopside;** a synonym for obsidian.

**hyalosiderite;** an olive-green variety of chrysolite (olivine) with 30-50% molar proportion of ferric silicate ( $Fe_2SiO_4$ ).

**hybrid**; composed or formed by mixture of other rocks or chemical composition.

**hybrid magma**; contaminated magma.

**Hydarabad**; a new name for Golconda. One of the headquarters of diamond merchants in India.

**Hydarabad, Nizam of, Collection**; → Collection of Nizam of Hydarabad.

**hydraulic gold mine**; the extraction of gold by means of strong jet of water. Also called hydraulicking gold mine.

**hydraulicking**; same as hydraulic mining.

**hydraulicking gold mine**; same as hydraulic gold mine.

**hydraulic mining**; the excavation of ore, placer or gravel by means of strong jet of water. Also called hydraulicking, jetting.

**hydraulic rock fragmentation**; rock crushing by means of strong jet of water.

**hydrargillite**; same as gibbsite.

**hydrargyrum**; chemical name for mercury with the symbol Hg.

**hydrate**; a chemical composition containing water combined such as  $\text{Na}_2\text{SO}_4 \cdot 7\text{H}_2\text{O}$ .

**hydrated**; containing water in chemical composition or water, which is crystallized.

**hydrated halloysite**; same as hydrohalloysite or endellite.

**hydrated silicon**; a white, amorphous precipitate mass, which is used to bleach waxes, fats and oils.

**hydration**; the incorporation of molecular water into anhydrous minerals.

**hydraulic mining**; mining by washing sand, gravel, and other materials away with high-pressure water, which leaves the desired minerals, used at alluvial deposits.

**hydride**; a binary compound of an element or complex with hydrogen.

**hydro-**; a prefix meaning water or presence of hydrogen in compound.

**hydroapatite**; a milky-white variety of apatite containing hydrous.

**hydrochloric acid**; a clear, colorless, poisonous, highly corrosive, fuming, pungent liquid or gas (HCl) soluble in water, ether, alcohol, benzene. It is a strong acid and one of constituents of aqua regia. Used to clean polished diamonds. Also called muriatic acid. → Hydrogen chloride.

**hydrocyclone separation**; any of various apparatus for recovering of diamonds consisting of a cone-shaped tank, in which diamonds are classified from crushed kimberlite. Principally a heavy media separator, in which gravels or broken blue ground are fed in from the side are centrifuged in a continuously circulating ferro-silicon slurry, when the heavy fragments sink and the lighter one is extracted from the top. → Heavy media

separation for diamond, heavy mineral separation.

**hydrofluoric acid**; a colorless, corrosive, toxic, liquid or gas of HF, soluble in water. Dissolves many metals with evolution of hydrogen and attacks glass. Used in polishing, etching, frosting of glass, cleaning stones, picking; copper, brass, stainless steel, and other alloys, to improve diamond appearance by bleaching the dark blemishes, testing, etc. Also called hydrogen fluoride.

**hydrogarnet**; group of garnet minerals related to garnet but with  $2\text{H}_2\text{O}$  substitute silica in the structure.

**hydrogen**; the lightest element, and gas  $\text{H}_2$  of chemical table, symbol H.

**hydrogen chloride**; colorless, fuming gas condition of HCl, which dissolves in water to form hydrochloric acid, also soluble in alcohol, and ether. → Hydrochloric acid.

**hydrogen fluoride**; a synonym for hydrofluoric acid.

**hydrogarnet**; same as hydrogrossular garnet.

**hydrogarnet**; a group of garnet minerals with  $2\text{H}_2\text{O}$  replacing silica structure. Main types are plazolite and hibschite.

**hydrogrossular**; a synonym for hydrogrossular garnet.

**hydrogrossular garnet**; a massive green grossular garnet having an OH group in its silica lattice from Transvaal, South Africa, which commercially is called *Transvaal jade*. It contain magnetite or chromite as inclusions. The green color is due to chromium and lilac to manganese. RI:1.70-1.73. SG:3.36-3.55. Cut as gems and carved in objects. Also called hydrogrossularite.

**hydrogrossularite**; → hydrogrossular garnet.

**hydrohalloysite**; a hydrated halloysite.

**hydrolite**; same as enhydros.

**hydrolite**; a silicate sinter.

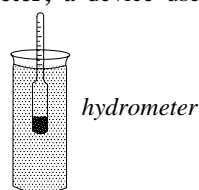
**hydrolite**; a zeolite mineral gmelinite.

**hydrolith**; a term applied to a rock or deposit that is relatively free from organic substances.

**hydrolith**; an aqueous rock that is chemically precipitated such as rock salt or gypsum.

**hydromancy**; a method of divination by water or other liquid due to vision seen therein because of ebb and flow of tides. → Margaritomancy, crystallomancy, lithomancy, crystal gazing, speculum.

**hydrometer**; a device used for quickly measuring the specific gravity of a liquid, it has a glass bulb filled with shot or mercury, on which is marked the specific gravity scale.



**hydrometry**; measuring the specific gravity or density of a liquid.

**hydrophane;** a pearly lustered, semitranslucent to opaque, white yellowish variety of common opal, which has a low refractive index and is virtually iridescent and transparent, when placed in water, as implied in the name. Also called oculus mundi, lapis mutabilis or hydrophane opal, informally lick.

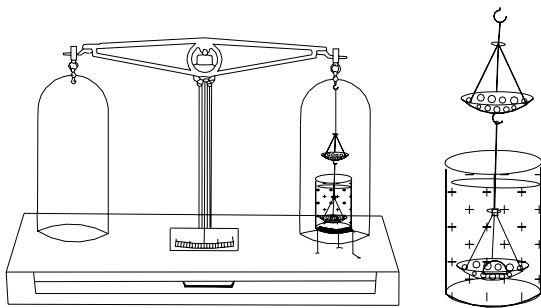
**hydrophane opal;** → hydrophane.

**hydrophane, synthetic;** → synthetic hydrophane.

**hydrorhizae;** a solitary or, more commonly, growing in colonies of countless individuals are embedded in a gelatinous mass known as *coenosarc*. → Coral.

**hydrosphere;** the water on the surface of the Earth as distinguish from the lithosphere, biosphere and atmosphere.

**hydrostatic weighing of specific gravity;** a direct measuring method for the specific gravity of a



*hydrostatic balance with enlarged basket*

gemstone by weighing it first in air, then in water. The specific gravity is obtained by dividing the weight in air by difference between the weights. There are many hydrostatic balances such as Hanneman balance, Westphal balance, Penfield balance, etc.

**hydrothermal;** an igneous process, in which hot chemical solution plays a mainly part as an important reactant. Such processes formed the rocks or mineral deposits, alteration products around an intrusion.

**hydrothermal;** → hydrothermal method.

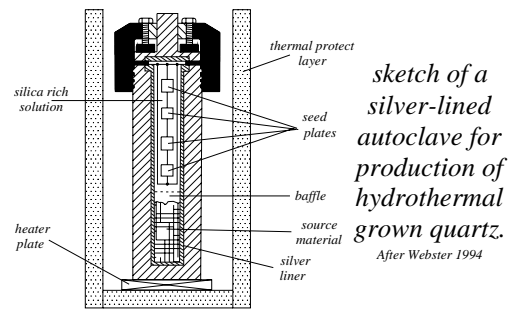
**hydrothermal alteration;** reaction and altering of rocks and minerals by means of hydrothermal water with pre-existing rocks or minerals.

**hydrothermal corundum;** synthetic corundum grown using hydrothermal method success by Bell Telephone Company Laboratories of America. Also called hydrothermal rubies. → Hydrothermal sapphire.

**hydrothermal deposit;** mineral deposits, which were formed by hot, ascending solutions derived from magma by varying condition of pressure and temperature.

**hydrothermal method;** a crystal synthesis method whereby their constituents are dissolved in superheated and saturated water solution. This method is used for growing quartz and Linde synthetic emerald and rubies. Also called hydrothermal process, hydrothermal crystal

growth.



*sketch of a silver-lined autoclave for production of hydrothermal grown quartz.*  
After Webster 1994

**hydrothermal process;** → hydrothermal method.

**hydrothermal synthetic;** → hydrothermal method.

**hydrothermal synthetic rubies;** → hydrothermal method.

**hydrothermal synthetic sapphire;** → hydrothermal method.

**hydrous;** a mineral containing water or hydrogen.

**hydrous mica;** a commercial term for illite, hydromica, illidromica, grundite.

**hydroxyl-annite;** an iron-rich variety of biotite or mica. Also called annite.

**hydroxylapatite;** a mineral of the apatite group  $\text{Ca}_5(\text{PO}_4)_3(\text{OH})$ .

**hydroxylapatite;** a mineral variety of apatite in which hydroxyl predominates over fluorine and chlorine.

**Hymenaea;** → leguminous tree *Hymenaea*, amber forest.

**hypabyssal rock;** igneous rocks that are not quite abyssal (deep-seated), occurring as small intrusions near the base, or root, such as dikes and sills of a kimberlite pipe.

**hyperchromic;** a radical or group of atoms added into dye compounds to increase the coloring intensity.

**hypersthene;** an important rock-forming mineral of pyroxene group of single chain related to enstatite and bronzite. When the iron content of enstatite increases than it is converting into hypersthene, therefore it is opaque. It has a metallic or bronzy luster. It is prized by collectors and sometimes faceted into gemstones. Symbol: Hy.

System: orthorhombic.

Formula:  $8[(\text{Mg},\text{Fe})_2\text{Si}_2\text{O}_6]$ .

Luster: vitreous, pearly, silky, or bronzy.

Colors: brownish green, gray, black, greenish black, brown.

Streak: grayish to brownish.

Diaphaneity: translucent to opaque.

Cleavage: {210} good, {100} parting, and {010} parting.

Fracture: uneven. Brittle.

SG: 3.42-3.50.

H: 5-6.

Optics;  $\alpha$ :1.692-1.755,  $\beta$ :1.702,  $\gamma$ :1.705-1.772.



Birefringence: 0.018.  $\ominus$  or may be  $\oplus$ .

Dispersion: 0.014.

Found in Mysore, India.

**hypersthene cut;** hypersthene has sometimes a metallic or bronzy luster hence can cut cabochon with cat's-eye effect and is prized by collectors and sometimes faceted into gemstones.

**hypersthene-enstatite;** a brown intermediate stone, which when the iron content increases the enstatite changes to hypersthene. RI:1.699-1.680. SG:3.30. Found in Mysore, India. Suitable to cut faceted gemstones.

**hyperstheneite;** a coarse-grained igneous rock, which is composed mainly of hypersthene.

**hypocrystalline;** an igneous rock, which consists partly of crystalline and partly amorphous or crystalline components, which lie in a glass matrix. Synonym for semicrystalline, hemicrystalline, hypohyaline, microcrystalline, merocrystalline.

**hypogene;** rocks or minerals formed under the earth's surface.

**hypogene;** ores or minerals formed by ascending hydrothermal solutions of magmatic origin.

**hypohyaline;** same as hypocrystalline or partly glassy.

**hypostilbite;** → stilbite.

**hypostracum;** the fourth and innermost calcareous layer of a shell wall of a bivalve mollusk, which is secreted completely by the epithelium of the mantle, consists of layers of columnar calcium carbonate crystals at right-angles to the outermost layer surface of shell, which is found between the muscle and shell.

**Hyriopsis schlegeli;** a large fresh-water bivalve with green-black periostracum of fine color and luster from Lake Biwa, in Honshu, Japan it is site of several pearl-culturing farms. The shell used for producing nucleated and unnucleated cultured fresh-water pearls.

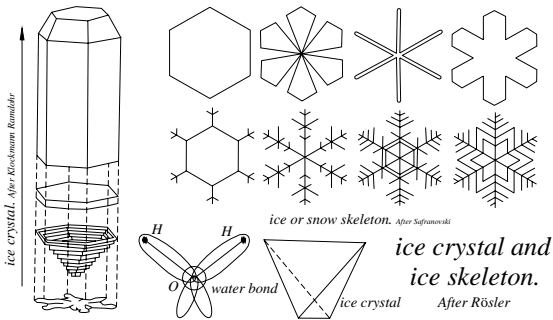
**hyprite;** a plutonic rock being intermediate in composition between gabbro and norite, which is composed of hypersthene, plagioclase, augite, olivine or diallage.

**hypsochrome;** a radical, which shifts the blue absorption spectrum of stuff towards a shorter wavelength of the violet end of the spectrum. Also called blue shifting.

**hypsochromic;** same as blue shifting. → Hypsochrome.

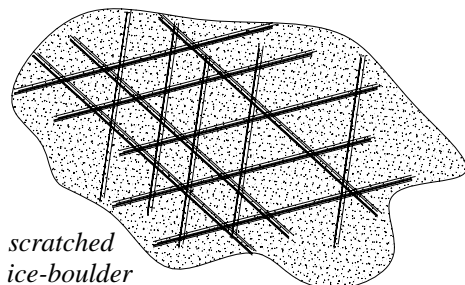
# I i

- I**; a chemical symbol for the element iodine.  
**I**; abbreviation for imperfect.  
**iaspeh**; a biblical term for the twelfth stone in the breastplate of the High Priest. It was translated and generally believed to be green jasper. It was engraved with the name Assher. Also spelled yashpheh.  
**Icabarú**; location of alluvial deposit in the Gran Sabana, Venezuela.  
**ice**; water in solid state formed by the freezing of water, which has skeleton, regular structure of hexagonal



crystal. It is colorless or pale blue, the blue color of ice and water in bulk consisting of pure vibration or rotation or both. When the ice or snow is white, because included gas bubbles. Specific gravity: 0.916. → Ice crystal.

- Ice Age**; a common name for the Pleistocene epoch. Also called Great Ice Age. → Pleistocene.  
**ice boulder**; those boulders, which has been transported



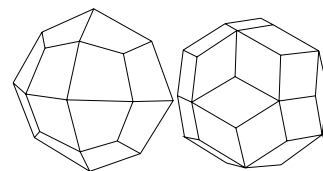
by a glacier. Also called ice boulder.

- ice color**; → ice.  
**ice-colored clear amber**; a German commercial term for the pale-colored, fine-quality transparent amber.  
**ice crystal**; macroscopic particle of ice, which shows a regular structure of hexagonal pattern. → Ice.

- ice crystal**; same as frazil crystal.  
**Iceland agate**; a misleading term for any obsidian from Iceland.  
**Iceland agate**; a local misleading term for a gem-quality variety of iridescent obsidian from Iceland.  
**Iceland agate**; a commercially misleading term for any obsidian from Japan, Hawaii, Lipari Island, etc., where cut gems are marketed as Iceland agate. Also called Icelandic agate.  
**Iceland crystal**; same as Iceland spar.  
**Iceland spar**; optically are colorless, very pure, transparent and easily cleavable rhombus of calcite. Due to its strong double refraction and flawless quality, is used in optical instruments and in construction of the Nicol prism. Synonym for a variety of calcite. Also called Iceland crystal, double-refracting spar, optical calcite.

- Icelandic agate**; same as Iceland agate.  
**Ice Queen Diamond**; a diamond of roughly 426.50 cts, after cutting weighed 128.25 cts, from South Africa. After cutting was called Niarchos Diamond. Also called Pretoria.  
**ice spar**; a white or colorless, glassy, transparent sanidine a different variety of orthoclase.  
**ice spar**; a confusing term sometimes applied to moonstone.  
**ice stone**; an American Indian (Native American) term for white flint.

- ice stone**; a term applied to rock crystal.  
**ice stone**; same as cryolite.  
**I-centered**; in crystallography a body-centered crystal.  
**ichthyophthalm**; (fish eye stone) a fancy term applied to a variety of apophyllite with fish-eye effects.  
**icicle**; a narrow cone-shaped, hanging spike of dripstone formed in caves by dripping water from the roof.  
**icositetrahedron**; a 24-sided crystal of trapezoidal faces belongs to the isometric system. Also called



icositetrahedron crystals

trapezohedron, leucitohedron.

- icy flakes**; a commercial term for small cracks along twin planes, which may also be caused by overheating during polishing by some diamond stones.  
**icy flakes**; frequently applied to a natural frosted surface on diamond stones.  
**IDA**; an acronym for the journal called International Diamond Annual.

**Idar agate;** small, colorful agates from Idar-Oberstein, Germany.

**Idar-Oberstein;** twin towns southeast of Mainz near River Nahe, a tributary of the Rhine, Germany. It is known as the center for cutting colored gemstones and a major diamond-cutting industry.

**Idar-Oberstein Topaz;** a navette-cut topaz of 9600 cts, from Brazil. Roughly weighed 5 kg.

**IDB;** an acronym for an illicit diamond buyer.

**IDC;** an acronym for the International Diamond Council.

**IDC clarity-grading scale;** a scale applied by the International Diamond Council range of diamond clarity grades which range from loupe clean through to piqué, corresponding to grades and terms on the CIBJO scale.

**IDC International color-grading scale;** a scale applied by the International Diamond Council range of diamond color grade ranging from colorless to light yellow, light brown, light gray, corresponding to grades and terms on the CIBJO scale.

**IDC Rules for grading polished diamonds;** a standard scale for diamond-clarity grading, color grading, and nomenclature, cut description, and certification applied by the International Diamond Council.

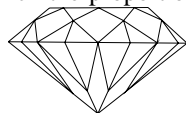
**ideal angle and proportion;** to improve the brilliancy and fire of a gemstone, when the ideal angle of reflection of light takes place in the correct proportion and angles of cut form.

**ideal brilliant;** same as ideal cut. → American brilliant cut, practical fine cut.

**ideal crystal form;** a term applied in crystallography to the crystal form, like faces are the same size and shape, and contain no foreign atoms. Also called ideal form. → Crystal form. → Real crystal.

**ideal crystal;** a term applied in crystallography to a crystal in which there are no imperfection or alien atoms.

**ideal cut;** a term applied to a modern diamond cut, in which the proportion and angles are correctly designed



*ideal brilliant-cut.* After Johnson and Roesch

for maximum brilliance and fire. Also called ideal brilliant, American cut. → Brilliant cut, Tolkowsky brilliant cut, American

brilliant cut, practical fine cut.

**ideal form;** same as ideal crystal form.

**identification;** → identification of gemstones.

**identification for records of gemstones;** there are two methods of recording gems for future identification: the fluorescence picture and surface topography photography.

**identification of artificial colored diamonds;** when

looking down through the table of a cyclotron-treated diamond can be seen a shape similar to that of an open umbrella. Those diamonds, which are heated through the side have a zone of color near the girdle.

**identification of cut diamond;** diamonds are usually cut much more exactly than other gem materials and the accurate meeting of the facets corners on stones is one form of identification for diamond.

**identification of gemstones;** the determination of gem materials depends on the physical properties of the rough state or the stone may be cut and polished to test whether genuine or not. Different physical methods are use in testing such as reflectivity meter, thermal conductivity tester, X-ray testing, water contact angle, fingerprint, breath test, dot-ring test, light spill test, etc.

**identification of hardness and wear (gems);** after a few years of wear most gems other than diamonds loose their sharp edges and have rounded edges between facets, while diamonds preserve their sharp corners and edges.

**identification of minerals;** another term for mineral identification.

**identification of rocks;** another term for rock identification.

**identification of specific gravity;** specific gravity determination of mounted stones are impossible, but for loose stones special apparatus must be used. → Specific gravity.

**identification refractivity of diamond;** the refractive index of diamond is very high (2.42) these is a quantity that can be measured to distinguish the stone from other simulants.

**identification, blemishes;** → internal damage, blemishes, external damage on cut diamond.

**identification, by ultraviolet light;** → identification, fluorescence.

**identification, color;** → colored diamond, fancies.

**identification, double refraction of gems;** → double refraction, double refraction measurement, double refraction detection, double refraction anomalous.

**identification, fluorescence;** → fluorescence, and below fluorescence of...

**identification of imitation pearls;** imitation pearls when they are drilled they have their mark at the drill hole, which is not as precise as in natural or cultured pearl because they are uneven and individually drilled. Sometimes the dick tears of the coating material may appear at the drill hole as coagulation masses.

**identification, simulants;** any stones than diamond, which simulate them, under normal conditions of lighting, such as zircon, white sapphire, quartz, topaz, synthetic materials, and composite stones.

**identification symbol;** abbreviation of characteristic

signs or letters for identification of an object, diagram, map and chart such as blemishes identification of a cut diamond.

**identification, tilt test (diamond);** the refractive index of diamond is too high (2.42) makes it possible to quality test the mounted stone to determine quickly from simulants with lower refractive index.

**identifying characteristics;** a term used in broadest sense in microscopically determination for all visible features seen internally inclusions and externally blemishes of a gemstone. Internally and externally factors used for examining the quality and value of a gemstone which both together is known as clarity characteristics.

**identifying characteristics;** a term sometimes used for any inclusion, or an internal imperfection or flaws.

**identigem;** in diamond grading same as the *fingerprint* based on Scan. D.N. System, which consist eight separate tests: cut, clarity, color, color print, crystal print, goniometer contour print, and grades of polishing.

**idio;** of itself.

**idioblast;** a mineral of a metamorphic rock formed by recrystallization and is bounded by its own crystal contours. Same as idiomorphic crystal.

**idiochromatic;** a term applied to a crystal which is free from impurity. Some minerals are colored by transition elements, which are major and essential ingredient, and substances are colored by small amount of transitional element as impurity. Best method to distinguish is to examine the color of powder, which in mineralogy called as *streak-test* by rubbing the mineral across a porous ceramic plate. Generally most colors caused by impurities are not saturated and mostly are not seen in the powder or streak. Most idiochromatic compounds have their own colors and are saturated and are not seen in the powder or streak. Also called self-colored, dopants, activators, chromophores. → Idiochromatic minerals, intrinsic semiconductor, idiochromatic, extrinsic semiconductor.

**idiochromatic coloration;** same as idiochromatic minerals.

**idiochromatic gems;** → idiochromatic minerals.

**idiochromatic minerals;** minerals, in which the coloring is due to its chemical composition, the color being constant. Makes it helpful for identification of the mineral content. For example azurite, malachite, chrysocolla, turquoise, etc. The ions of elements copper, iron, chromium and manganese are responsible as idiochromatic color agents in idiochromatic minerals. The other ions of elements such as cobalt, nickel, vanadium and titanium are as allochromatic agents, which occurs as impurities in minerals and

lighten increase the colors. Self-colored minerals. Colored crystal free from impurity. Also called idiochromatic stones. Opposite of Allochromatic.

**idiochromatic stones;** → idiochromatic minerals.

**idiomorph;** synonym of syngenetic.

**idiomorph;** a crystal grown in igneous rock, sharply bounded by some or all its characteristic crystal faces. Synonym for euhedral crystal, automorphic.

**idiomorph;** applied to a texture of an igneous rock having mineral entirely bounded by some or all its characteristic crystal faces.

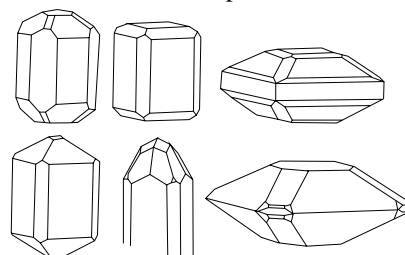
**idiomorph crystals;** an individual crystal, which has grown according to its normal habit. Also known as euhedral crystal.

**idiomorph (euhedral) crystals;** same as idiomorphic crystals.

**idiomorph granular;** the granular texture of an igneous rock.

**idiophanous;** a term applied to a crystal that exhibits an interference figure to the naked eye.

**idocrase;** a variety of gem mineral in diverse colors, which is prized by collectors. A compact green variety resembling jade is known as *californite*. A greenish-blue or sky-blue variety is named *cyprine* because it contains copper. A transparent yellowish-brown is known as *xanthite*. The transparent varieties of idocrase



*idocrase crystals*

are frequently named *vesuvianite*. Also called vesuvian, genevite, wiluite, duparcite, laurelite, and pyramidal garnet.

System: tetragonal.

Formula:  $4[\text{Ca}_{10}(\text{Mg}, \text{Fe}^{+2}, \text{Fe}^{+3})\text{Al}_4(\text{SiO}_4)_5(\text{Si}_2\text{O}_7)_2(\text{OH})_4]$ .

Luster: vitreous to resinous.

Colors: colorless, pale yellowish to yellowish green, green, brown, white, red, pink, violet, blue to blue-green.

Streak: colorless.

Diaphaneity: transparent to translucent.

Cleavage: {110} indistinct, {100} very indistinct, and {001} very indistinct.

Fracture: conchoidal to uneven. Brittle.

SG: 3.33-3.45.

H:6-7.

Optics;  $\omega$ :1.703-1.752,  $\epsilon$ :1.700-1.746.

Birefringence: 0.008-0.018.  $\ominus$  or  $\oplus$ .

Dispersion: 0.019-0.025.

Found in Finland, Korea, Tanzania, Japan, Austria, Norway, Canada, Russia, Austria, Switzerland, Pakistan, Sri Lanka, and California, Maine, and New Jersey (USA).

**idocrase absorption spectrum;** a strong band at 461 nm, and a weak band at 528.5 nm.

**idocrase cut;** fine, greenish-yellow, transparent gems, which have been cut from fine crystal coming from Laurel, Quebec, Canada, or greenish-golden color with small veil-type inclusion from European sources. The massive stones are cut cabochon.

**idocrase pleochroitic;** weakly pleochroitic: green, orange and yellow-green.

**Idol's Eye Diamond;** a fine light blue, modified oldmine cut diamond (pear-shaped or semi-round,) of 70.21 cts. It believed to be from India. In 1906 it was owned by Sultan Hamid II of the Ottoman Empire (Turkey), which sacrificed as the eye of a sacred idol in the temple of Benghazi and later sold it in Paris. Later in 1947 it was purchased by Harry Winston New York, USA. It was sold in 1980 to Laurence Graff in London.

**IF;** an acronym for internally flawless grade by GIA clarity-grading scale.

**IGI;** an acronym for International Gemmological Institute; Headquarters for this society are located at: Schupstraat 1/7, 2018 Antwerp, Belgium. For North and South America: 579 Fifth Avenue, New York, N.Y. 10017, USA.

**igmerald;** a commercial term for the variety of synthetic emerald made in 1934 by I.G. Farbenindustrie in Bitterfeld, Germany.

**igneous;** major types of rock formed by solidification from a molten or partly molten magma, crystalline or glassy, or both. Found in extrusions (on the surface as lava) and intrusions (inside the Earth as granite). Classification of igneous rocks is generally based on mineral composition and texture. Also called pyrogenous, ingenious. → Metamorphic rock, sedimentary rock, forms of igneous activity.

**igneous breccia;** any angular breccia, which is composed of fragments of igneous rock. Also known as eruptive breccia and pyrogenous breccia is an obsolete term.

**igneous intrusion;** the process of replacement of igneous magma in pre-existing rock, which produces a thermal or contact metamorphism rock. Igneous magma forced through and into pre-existing rock.

**igneous magma;** igneous rock-forming, mobile mass of plastic liquids, solids, and gases generated beneath the Earth's or upper mantle of the Earth.

**igneous quartz;** same as silixite.

**igneous rock;** a rock formed by the solidification of a

molten magma, which may be extrusive on the Earth's surface (volcanic) or intrusive inside the Earth (plutonic). → Igneous, rocks.

**Iimori glass imitation;** one of the two glass type used to produce cat's-eye imitation, which is made in Japan and marketed as *Victoria cat's-eye*. → Iimori stone.

**Iimori jade;** fine green jade from China.

**Iimori jade;** a misnomer for artificial jade-green glass.

**Iimori stone;** semi-opaque, various colored glass-like material, in which the fibrous actinolite inclusion are grow in a radiated structure, made by Iimori, S., Japan. When cut cabochons shows cat's-eye effects. RI:1.50-1.62. SG:2.66-2.75. H:6. Iimori stone is produced from quartz, feldspar, calcite, fluorite, magnesite, etc. in green, blue, citrine-yellow, brown-red, brown and simulated jade, turquoise, lapis-lazuli, and other ornamental objects. It is sold under the name victoria stone, victoria cat's-eye. It floats in methylene iodide or di-iodomethane. Also called *meta-jade*, *kinga-stone*. Also misspelled Limori stone. → Iimori jade, cat's-eye imitation.

**ike-chogai;** a Japanese local term for a large bivalve fresh-water mussel of *Hyriopsis schlegeli* with a greenish-black periostracum found in Shiga Province of Honshu, Japan.

**illam;** a Ceylonese or Singhalese term for gem-bearing stratum gravels from Sri Lanka containing kornerupine, corundum, spinel, zircons, etc. These have been driven from pegmatite veins on the island. → Dullam

**illicit diamond buyer;** one who purchase rough diamonds from those who hold the stones through illegal channels or buys from native diamond laborers.

**illicit diamond diggers;** → pork knockers (diamond miners).

**illidromica;** same as illite.

**illinition;** a very thin extraneous crust setting-up on the gem or mineral surfaces.

**illiquation;** infusing or melting.

**illite;** a general term for a group of three-layer, mica-like clay minerals, fine-grained, gray, light green or yellowish-brown color.  $\alpha$ :1.579,  $\beta$ :1.602  $\gamma$ :1.618. Birefringence:0.039.  $\ominus$ . SG:2.6-2.9. H:1-2. Also called glimmerton. Also called illidromica, hydromica, hydrous mica, grundite.

**illumination;** the science of the application of visible radiation throw the light into or light up. → Dark-filled illumination, light-filled illumination.

**illumination for microscope;** → dark-filled illumination, light-filled illumination.

**illumination for refractometer;** to obtain sharper and more accurate edge and shadow with a standard refractometer it must used monochromatic light.

**illumination for spectroscope;** spectroscop instrument

needs high intensity, cool illumination, and flexible reflected or transmitted light.

**illuminator for polariscope;** a movable light source, through which light enters the portal at the back of the polariscope.

**illusion cut;** a modern fashioning and engraving of stones produced by cutting of some transparent stones such as rock crystal into a triangular block and placing grooves of varying widths and inclinations into one edge of the block. A three-dimensional effect can be seen when observed from the other two surfaces due to reflection of the grooves.

**illusion head;** same as illusion setting.

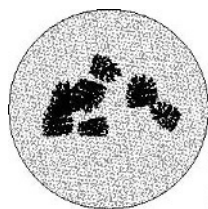
**illusion setting;** a setting style of polished small diamonds or other colorless stones on a large mount narrow ring made of metal designed to increase the reality size. Also called illusion head, miracle crown, miracle top, or miracle head.

**illustration of crystal lattice;** same as illustration of crystal structure.

**illustration of crystal structure;** the regular, orderly, periodic or repeated arrangement of atoms, molecules, or ions in a crystal structure are exhibit in form of an open *ball-and-stick* model, which used to visualize crystal lattices in realistic arrangement to show the relation of the component ions, which is made by coordination polyhedron such as tetrahedron and octahedron. Also called illustration of crystal lattice.

**illuviation;** redeposition of suspended material and small mineral particles which have been leached out of an overlying layer.

**ilmenite;** an opaque slightly magnetic mineral used as substitute for hematite. It is rarely fashioned but it is



*skeleton  
inclusions  
of ilmenite  
in  
aquamarine  
from Brazil*

prized by collectors. Readily to distinguish from the red streak of hematite. While ilmenite has a brown streak. Also called titanite iron

ore, mohsite, menaccanite, titanoferrite.

System: trigonal.

Formula:  $6[\text{FeTiO}_3]$ .

Luster: metallic to dull.

Colors: iron-black.

Streak: black.

Diaphaneity: opaque.

Cleavage: none.

Fracture: conchoidal to uneven. Brittle.

SG: 4-72-4.80.

H:5-6.

RI : 2.72.

Birefringence: very strong.

Found in Russia, USA, France, Norway, Sweden, Canada, and Switzerland.

**ilmenite as inclusions;** it is found in garnets and beryl. → Ilmenite.

**ilmenitite;** a medium-grained igneous rock of the ultrabasic origin contained almost majority of ilmenite and minor pyrite, chalcopyrite, and pyrrhotite. An indicator mineral associated with kimberlite.

**ilmenomagnetite;** magnetite, which is intergrown with ilmenite.

**ilmenorutile;** a black columbium rich variety of rutile.

**ilvaite;** an opaque, orthorhombic sorosilicate mineral from the hemimorphite group with the formula:  $4[\text{CaFe}^{+3}\text{Fe}^{2+}\text{Si}_2\text{O}_8.\text{OH}]$ . Glassy to dull submetallic luster. Black to grayish-black. Streak: black to brownish-green. Cleavage: {001} distinct, and {010} distincts. Fracture uneven. Brittle. Optics;  $\alpha$ :1.727,  $\beta$ :1.870,  $\gamma$ :1.883. Birefringence: 0.153.  $\ominus$ . SG:3.80-4.02. H:5½-6. Found in Massachusetts-(USA), Greenland, Italy (Island of Elba), Saxony (Germany), Algeria, and Japan. Also called lievrite, yenite.

**image;** in optics a reproduction of an objects. Images are evolved by refraction or reflection of light if focused by lens or lens system or mirror. Two kind of images exist real or virtual. Also called picture.

**image stone;** an Indian variety of agalmatolite or steatite, known as pratima culler.

**imbrication;** a term applied to a sedimentary rock fabric characterized by disc-shaped or elongated fragments or flat pebbles in a stream bed or on a beach like a tiles or shingles on a roof.

**imbye;** a term applied in ruby mining in Myanmar, (Burma) for a large square pit which can be over 60 meters deep with sides of 6-9 meters. → Kobins.

**imitation;** to result something of a genuine article or natural gemstone or simulate it from any material (other than genuine material) that imitate by its color, the appearance of a natural gemstone. Imitation gemstone having wholly different physical properties and chemical composition, and hence distinguish from synthetic gemstone. Physical properties, which determine differences are hardness, specific gravity, refraction or double refraction, color dispersion, and dichroism. Imitation gemstones are known as called *simultants*, which are mostly made of glass, paste or strass, faience, porcelain, and plastics. Also called imitation stone, simulate stone. → Reproduction, assembled stone, imitation gemstones. All simulate stones are molded and are not cut. → Imitation gemstones.

**imitation amber;** imitation amber made from kauri gum (formerly kauri pine), copal resin, ambroid, glasses, and

plastics. Also called amber antique.

**imitation amber, Chinese;** → Chinese amber, imitation.

**imitation ambers labeling of;** same as labeling of imitation ambers

**imitation cameo;** → cameo.

**imitation composites;** → imitation doublet, composite stone, assembled stone, soudé emerald, and imitation triplet.

**imitation coral;** coral is imitated by stained vegetable ivory, which is distinguished by dot-like cell mixture of gypsum and rubber, barium sulfate, dyed marble or colored powder of marble mixed with isinglass and those created by Gilson. It is also made from glass, porcelain, and plastics. → Gilson-created coral.

**imitation cultured pearls;** a little bizarre term for imitation pearl beads consisting of a mother-of-pearl coated with essence d'orient. Also called shell-based imitation pearls.

**imitation diamonds;** there are several natural and synthetically materials with high refractive indices used to imitate diamond such as zircon, fabulite, YAG, etc. → Imitation gemstones.

**imitation doublet;** an assembled stone consisting of two pieces of colorless glass, closed together with a colored or non-colored cement.

**imitation emerald;** imitations emerald are made from assembled stones such as doublets, triplets from different materials for sample garnet-topped doublet and as soudé emerald, which is made from two pieces of colorless quartz, synthetic spinel or beryl and a green layer in the middle of both to cemented together. Glass imitations of emerald green color are made but are easily distinguished by flaws and feathers. Ferrous emerald and Ferrer's emerald are misleading terms for emerald green glass with the chemical composition similar to that of emerald. Sometimes the back of pale true emerald is painted with a green lacquer to improve the color. → Emerald.

**imitation essence d'orient;** → essence d'orient, synthetic fish-scale essence.

**imitation foil back;** → foil back.

**imitation gemstones;** simulation of gemstones and precious objects by substances of much less values were tried in ancient Egypt and possibly even earlier. Imitation gemstones or jewels are mostly made of glass, faience, porcelain, and plastics. Also called imitation stones. → Imitation, composite stones, artificial stones, synthetic stones.

**imitation gemstones;** frequently a natural gemstone used to imitate another natural gemstone such as phenakite, or periclase.

**imitation glass;** imitation stones are mostly

manufactured of glass The process consists of mixing the raw material, with adding any coloring agents.

**imitation hematite;** same as scientific hematite.

**imitation ivory;** any substance resembling natural ivory, such as vegetable ivory, bones, deer horn, bakelite, celluloid, cederon, invelite, micarta, mixture of gypsum and stearic acid.

**imitation jade;** same as jade imitation.

**imitation lacquerback;** when imitation stones been treated or covered with colored lacquer, or other substances to improve their color. → Lacquerback.

**imitation, lapis lazuli;** → lapis lazuli imitation.

**imitation opal;** a composite stone constructed of two or more pieces of material, which may be made of poor-quality opal with a cabochon of glass, quartz, abalone, mother-of-opal cemented or otherwise joined together. A composite stone for this propose is a glass covered with a metallic layer on the back or on one surface of other materials.

**imitation opal;** a triplet made of layers of fish skin stained in red or blue, which is known as *Schnapperskin triplet*.

**imitation opal;** an assembled stone made of ironstone opal, on which a piece of common opal is cemented.

**imitation opal;** imitation opala are made from various substances such as *opal essence* or *slocum stone*, which is made of glass with laminated inclusions, it has RI:1.49-1.50. SG:2.40-2.50. It is to distinguish by gas bubbles and typical glass swirls which are made from polystyrene or other plastics resembled opal with RI:1.485, SG:1.18, which has a whitish-blue fluorescence.

**imitation opal;** sometimes the pure quality opal are improved by soaking in n-butyl methacrylate plastic with RI:1.41 and SG:1.85.

**imitation opal;** a piece of black glass or black opal, which is used as back of an opal doublet, and which is called *myrickite*. Imitation opals are made from polystyrene plastic with RI:1.50-1.51, and SG:1.20. It is similar to lizard skin with shrinkage by cracks which are visible when viewed through a microscope both are known as *opalite*. Probably the stones are made from different plastic layers, whereby the outer layers coated with a base substance, such as acrylic plastic and then covered with the polystyrene base opal imitation. Opalite is warmer than true opal and hydrophobic.

**imitation opal;** a term used for *Gemulet* a colorless glass embedded with fragments of synthetic opal, which provide low relief and the play of color.

**imitation pearls;** beads of glass, mother-of-pearl, abalone, vegetable ivory, celluloid, or other substance coated with fish-scales extract known as *essence d'orient* on surface to provide a nacreous appearance or

hollow spheres filled with wax to imitate the natural pearl or cultural pearl. Such pearls were called *Roman pearls*. Another method is to spray the exterior of solid glass beads having a string hole with essence d'orient, which were called *Venetian Pearls*. Up to 10 times coats of essence d'orient are usually applied to make a bead appear pearl-like. Imitation pearls are made from a special opalescence glass, which is misnomered as alabaster. Plastics as polystyrene or perspex are molded as cheap imitation pearls. Covered vegetable ivory core can be used as imitation pearl but the nucleus is opaque to produce commercially pearls. Mother-of-pearl or abalone can be coated with plastic and essence d'orient but with a peculiar iridescence effect from the core, which are named as *shell-based imitation pearl* or *imitation cultured pearl*. Imitation pearls have an unrigged surface and feel smooth between of teeth, when natural pearl and cultured pearls feel chalky and gritty. By study of the surface with a hand loupe can be seen that the surface looks like *blotting paper*. Recently made imitation pearls that feel gritty, distinguish with a pin pressed into the surface, which scratches the coated bead or indent it. The best and simplest test to distinguished is to examine the edges of drilled pearl with a hand lens. Also X-ray study used for identification, by which due to opacity of glass the beads gives a black pattern on a positive print or white on the negative. Also examination for specific gravity are identifiable. There are many commercial terms for imitation pearls. Also called simulated pearl. → Guanine, operculum.

**imitation star sapphire;** an assembled imitation stone.  
→ Star doublet.

**imitation stones;** → imitation gemstones.

**imitation triplet;** → imitation doublet, composite stone, assembled stone, soudé emerald, and triplet.

**imitation turquoise;** imitation turquoise is made from various natural, artificial, and non-mineral compounds. Artificially imitations of turquoise are made from glass, frit, enamel, porcelain, various compressed powders some, of which have a similar composition to that of turquoise. *Frit* was in ancient times known as *kyanos* or *caeruleum*, which was made from silica and copper and was carved as objects. *Faience* is made from a gritty core, which is coated with one or two and frequently of three layers of turquoise colored glass. Such glasses are colored with copper, cobalt, or iron, usually with a specific gravity of 3.30. *Porcelain* imitation is turquoise a translucent mass with a porcelaneous luster, which is glazed. SG:2.30-2.40. *Vienna turquoise* is a pressed and dyed mixture of aluminum phosphate colored by copper oleate or made of aluminum hydroxide, malachite and phosphoric acid heated to over 100° C. Also called Viennese turquoise. Turquoise

colored *glasses* are used in imitation and sometimes misnomerly are called *Vienna turquoise*. Another imitation is *neolite* a mixture of bayerite and copper phosphate with an amorphous iron compound to give the product matrix appearance. RI:1.45-1.55 and SG:2.30-2.60. Also imitations are made from different plastics.

**imitation turquoise;** turquoise substitutes from natural stones such as stained chalcedonies, which are artificially dyed in various colors and a translucent turquoise-colored mass of RI:1.53. SG:2.63. H:6½. Turquoise dyed jasper is common, which is also used as a lapis lazuli imitation with the name Swiss lapis or German lapis. Other imitations are blue colored howlite and plaster of Paris, surface dyed limestones, callinite a variety of variscite and natural turquoise colored fluorite.

**imitation turquoise;** natural non-mineral compounds such odontolite or fossil tooth, fossil bone and powdered ivory, which is dyed by copper, cemented and pressed together.

**imitation turquoise;** a semi-natural compound is made of fragments of natural turquoise bonded with a type of plastic together, manufactured in Arizona, USA.

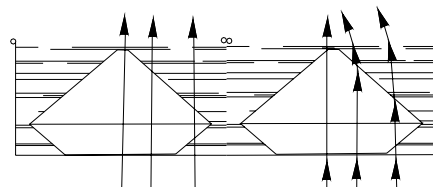
**imitation turquoise;** occasionally so-called doublets can be seen, which have been made from opacified glass with turquoise color as cabochon and cemented to a bottom made of blue-dyed chalcedony or it is made from blue colored bone as cabochon. → Turquoise, synthetic turquoise.

**immature conglomerate;** a term applied to the unsorted or poorly sorted debris and unstable material.

**immersion;** the act of submerging an object in a liquid.

**immersion cell;** any transparent small, hollow cuvette made of glass or from other material used as container or as an immersion cell to examine the internal inspection of gems by reducing surface reflections and refraction. The cell is filled with an appropriate liquid and the gemstone is immersed in it. Some immersion glass cells are attached with a stopper arranged so that the gemstones may easily be rotated the about one axis. Also called immersion cup, glass dishes, petri dishes.

**immersion contact method;** a method used in

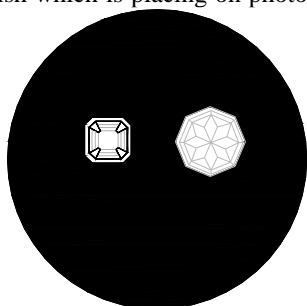


*immersion gems and passing light. Left same RI for gem and liquid. Right gem have slightly lesser RI than the left gem*  
gemology and mineralogy for determination of



refractive indices of gems and its relationships. A gem of unknown refractive index will be immersed in turn in a series of liquids of known index till the index of gem and liquid are identic. → immersion contact photography.

**immersion contact photography;** a method to reveal the difference between refractive index of gems and its relationships. The polished or faceted gemstones are immersed in a dish, which is filled with a appropriate liquid. Light from an overhead source is passed through the dish which is placing on photographic paper. When



*immersion contact photograph of different gemstones in monobrom-naphatlene*

the paper is developed, paper cut stones or shaped beads with a refractive index higher than the immersion liquid display a white marginal rim and the facet edges are marked by dark lines. Stones with a refractive index lower than the liquid, shows the inverse effects. A further stage of this practical method is using to reveal the internal features such as curved structure lines (striae) in synthetic stones.

**immersion contrast;** a method to identify the coated and sandwich stones by immersion in a liquid of similar refractive index.

**immersion cup;** same as immersion cell.

**immersion lens;** same as immersion objective.

**immersion liquids;** a list of known refractive index that is used in an immersion cell by immersion method of determining a mineral refractive index such as benzene. Synonym for index liquid.

table 9: immersion liquids

liquid	refractive index
water	1.330
alcohol	1.360
petroleum	1.450
carbon tetrachloride	1.460
benzene	1.500
monochlorobenzene	1.526
clove oil	1.540
ethylene dibromide	1.540
monobromobenzene	1.560
ortho-toluidine	1.570
aniline	1.580
bromoform	1.590
iodobenzene	1.620

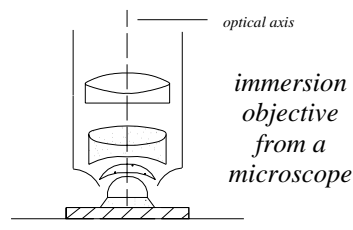
<i>monobromonaphthalene</i>	1.660
<i>iodonaphthalene</i>	1.705
<i>methylene iodide</i>	1.745
<i>phenyl-di-iodoarsine</i>	1.850
<i>West's solution</i>	2.050

Care should be taken when using phenyl-di-iodoarsine because it is very poisonous, and has a violent blistering action on the skin. Care should also be taken when using benzene as it is suspected of being carcinogenic.

**immersion method;** a method of measuring the refractive index of a mineral or gemstones in order to identify it. A gemstone immersed in a liquid of known refractive index close to the gemstone invisible. The immersion liquid is a contact medium between a short focal length objective and a microscope slide. Known as immersion technique. → Beck line method, Wild method.

**immersion method of composite stones;** all assembled stones can be easily distinguished from genuine stone, when they are immersed in water, di-iodomethane, or mononaphthalene with RI:1.74, which causes the join to be revealed by different light refraction.

**immersion objective;** a high-power microscope objective uses of the principle of aplanatic refraction to reduce the refraction at the front lens, those lens system



being immersed in a drop of cedar-wood oil placed upon the slide to be examined. Also called immersion lens.

**immersion sphere;** a hollow glass sphere, which is placed on a ring on the microscope stage allowing the gemstone be rotated about one axis for observing the immersed stone from different direction. The hollow glass sphere is filled with a liquid with the same refractive index as the glass. A similar stone holder was made by Gemological Institute of America, which named it as interference figure bulb.

**immersion stage;** a microscope stage for study of sample in immersion liquid.

**immersion technique;** same as immersion method.

**immiscible;** the property of two or more liquids at mutual equilibrium which cannot dissolve partly or completely in one other.

**immortality;** → ambrosia.

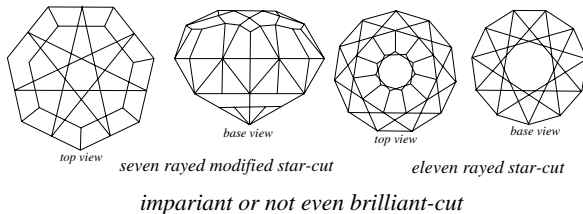
**impact;** a forceful collision or some contact between bodies or elastic spheres such as the production of

meteorite crater or cryptoexplosion structure.

**impact crater;** a crater formed on a surface due to forceful collision impact of an unspecified body such as meteorite, asteroid, comet, etc.

**impact glassy;** same as glassy impact.

**impariante;** a brilliant cut with unpaired facets. Also



called imparilliante.

**imparilliante;** → impariante.

**imperfect;** a term applied to the diamond clarity grade, which ranges from *flawless* to *imperfect*. These characteristic are visible to the unaided eye and, which have a serious effect on the stones. The scale is subgraded into three as I<sub>1</sub>, I<sub>2</sub> and I<sub>3</sub>. Abbreviation: I.

**imperfect crystal;** a term applied to a mosaic form of a crystal value, in which principal extinction is inconsequential.

**imperfection;** any interior or exterior flaw, blemish, or inclusion in a diamond or other gemstone examined under 10x magnifier.

**imperfection grade;** another term for clarity grade.

**imperial Chinese jade;** → emerald jade.

**Imperial Crown Jewels of England;** same as British Crown Jewels.

**Imperial Diamond;** a cushion cut brilliant of 184.50 cts, found in 1884 in Jagersfontein mine, South Africa. Its rough weight was 468.9 cts, and a smaller circular brilliant weighed 20 cts. Also called Victoria Diamond, Great White Diamond. The larger stone was sold to the Nizam of Hyderabad, India.

**imperial jade;** a popular and commercial term for a fine, translucent to translucent, highly intense emerald-green variety of jadeite from Myanmar, (Burma). It is the most valuable variety of jade.

**imperial jade cut;** cut cabochon, also beads or small carving objects be seen.

**imperial Mexican jade;** a misleading term for green-dyed calcite (marble). Also called Mexican jade.

**imperial nephrite;** a term used in Myanmar, (Burma) to choicest mutton fat, white nephrite.

**imperial sodden snow jade;** same as white nephrite.

**imperial topaz;** yellow to golden or golden reddish-orange to sherry-brown topaz, which occurs in cavities

of rhyolite rocks found in Brazil. Metallic Cr<sup>+3</sup> element is responsible for the color of topaz. Often cut as faceted gems.

**Imperial Topaz;** a cherry colored Brazilian topaz of 2kg. Now on display at National Museum, Rio Janeiro, Brazil.

**Imperial Topaz;** a cherry colored Brazilian topaz of 218 gram. Now on display at National History Museum, London, England.

**Imperial Topaz;** a cherry colored Brazilian topaz of 129 cts. Now on display at Smithsonian Museum, USA.

**Imperial Topaz;** a cherry colored Brazilian topaz of 93.6 cts. Now on display at Smithsonian Museum, USA.

**Imperial Topaz;** a cherry colored Brazilian topaz of 41.4 cts. Now on display at Smithsonian Museum, USA.

**Imperial White Diamond;** same as Imperial Diamond or Victoria Diamond.

**imperial Yü-stone;** a Chinese descriptive term for a green variety of aventurine quartz.

**impermeability;** the condition of a rock that does not permit liquids to transmitting through it under pressure. Synonym of imperviousness.

**imperviousness;** → impermeability.

**impregnated;** a term applied to epigenetic minerals which are diffused in the host rock.

**impregnated diamond dressing tool;** same as dresser. A diamond holder, wheel or tool that contain small diamond crystals (embedded or bonded electroplated), which is used to correct and retain grinding wheels. Also called dressing, diamond dressing tool, or impregnated diamond dressing tool.

**impregnation of gemstones;** to improve the appearance and color of strengthened porous stones they may be impregnated with an organic inorganic color agent such as silicon, opticon, paraffin wax or other polymers to fill the pores or fractures.

**impregnation of stones;** the irregular distribution of introduced mineral material (epigenetic) through a host rock. Filling the pores of pre-existing rock by liquid or by mineral materials. → Impurity elements.

**improve, to;** the process to raise a higher value, intensity, color, attractiveness, quality, etc. In the diamond industry enhancement is caused by irradiation, fracture filling, coating, lasering, heating. Same as enhancement.

**improve, to;** enrichment of ore, or other mineral or gemstone samples by enlarging of the mine. → Upgrade.

**improve, to;** to increase the commercial value of gems, precious metals, etc.

**impurity;** a small amount of an element or composition

is added to a crystal, rock, or ore.

**impurity**; a sample, which contains elements other than carbon in diamond.

**impure gold dust**; a term used for commercial gold.

**impurity**; same as contaminant.

**impurity atoms**; same as impurity elements.

**impurity elements**; when a small amount of an element other than carbon is added to a crystal of diamond, which are not a part of chemical composition. When boron and nitrogen are present in diamond structure they create the color of the stone.

**In**; a chemical symbol for the element indium.

**INAA**; an acronym for instrumental neutron activation analysis.

**Inamori padparadschah**; a fancy term for synthetic orange sapphire made by Kyocera company, Kyoto, Japan.

**Inamori synthetic pulled corundum**; a promotion term for synthetic red, orange corundum or sapphire made by Kyocera company, Kyoto, Japan.

**Inamori synthetic pulled alexandrite**; a promotion term for synthetic alexandrite or alexandrite cat's-eye made by Kyocera company, Kyoto, Japan.

**Inamori synthetic pulled star ruby**; a promotion term for synthetic white 6-rayed star ruby made by Kyocera American Corporation.

**inanga**; a Maori term for gray variety nephrite jade from New Zealand. → Pounamu.

**inaurate**; gold covered or covered with gold. Also called gilded.

**in-byses**; → ins.

**Inca emerald**; a term applied to emeralds from Ecuador.

**incandescence**; a term used for temperature radiation or light from hot object.

**Inca rose**; a fancy commercial term for banded rhodochrosite found in Argentina, which was known to Incas. Also called rosinca.

**Inca stone**; another term for pyrite.

**incandescence**; the emission of light by a substance due to high temperatures: white or bright-red heat. When objects such as iron placed in fire it become dull red (*red hot*) by 700° C. From 700° C to 1500° C, the color shifted from red to orange and definitely yellow (*yellow hot*); by the time the iron melts. Objects higher than 1500° C will be seen white such as sun surface on the day, which has a temperature of about 5700° C. This white color is called *white hot*. When temperature increasing caused by energy increasing, the object emitted colored light from black body (cold body) to red and yellow to bluish-white depend on energy increasing. It means hotter the object therefore more vibration energy of the atom and higher the frequency of the light in equilibrium with it.

**incandescence lighting**; → incandescence.

**inch**; a traditional unit of length equivalent to 2.54 centimeters or  $\frac{1}{12}$  foot.

**incident angle**; → incident, angle of.

**incident illumination**; illumination, in which the light strikes the surface of a stone. → Incident light, dark-filled illumination, light-filled illumination.

**incident light**; arriving, falling, or striking of light directly on the surface of a gemstone or when light enters a gemstone nearest to the viewer's eye. In most cases the light has been reflected or refracted. Also called incident ray.

**incident ray**; same as incident light.

**incident, angle of**; the angle of incidence and the angle of reflection are equal and both are in the same plane.

**incineration**; to burn to ash. Same as reduction to ash.

**incipient fusion**; same as sintering. Also called angle of incident.

**incise**; a term applied to cut lines or engraved initials into the surface of gemstones or other materials by a sharp tool.

**inclosed**; embed, imbedded, enclosed in a matrix.

**included**; same as included crystal.

**included crystal**; any crystal or mineral, which is enclosed during the growth process of a diamond or other gemstones. In diamond clarity grading is known as piqué. → Inclusion.

**included gas**; bubbles of gas or air in isolated interstices in stones.

**included (I)**; a GIA clarity scale for diamonds, in which included crystals are visible to the naked eye. These are subdivided in three categories: I<sub>1</sub>, I<sub>2</sub>, and I<sub>3</sub>. → Inclusions.

**inclusions**; a general name for any small visible foreign matter such as gas, liquid, glass, or mineral enclosed within a gemstone or rock, which is a growth phenomena. Fracture or cleavage in a gemstone are not classed as inclusions. The nature of inclusions are used to indicate the origin of a stone. Inclusions are very helpful in distinguishing synthetic stones from their counterparts. Inclusions are divided into two categories: (I) primary inclusions and (II) secondary inclusions. Inclusions may result in 3 formations: (a) *pre-temporary inclusions*, *pre-existing inclusions*, or *protogenetic inclusions*, (b) *contemporary inclusions*, or *syngenetic inclusions* and (c) *post-temporary inclusions*, *post-formed inclusions*, or *epigenetic inclusions*. Some types of inclusions type are: feather, silk, horsetail, veil, fused or treacle, negative crystal, halo, fingerprint, dendrite, centipede, pleochroic halo, zircon halo, two-phase, three-phase, etc. Inclusions are divided in 4 shapes: ( $\alpha$ ) solid inclusions, ( $\beta$ ) internal cavities, ( $\gamma$ ) cracks or fissures, and ( $\delta$ ) growths.

Synonym for enclave, enclosure or internal characteristic. Also called enclosure, enclave, metasome. → Xenolith, included crystal, autolith.

**inclusions;** a clarity grading scale of polished diamonds those are cleavages, fractures, feathers, carbon spots, clouds, knots, bubbles, bearded girdle, etc. Also called enclosure.

**inclusions as color agent;** presence of inclusions in minerals may caused color such as in quartz and in large number of chalcedony. For example presence of hematite in red variety of carnelian, or chrysocolla is responsible for the green color in greenish blue variety of chalcedony. Or presence of fuchsite inclusions in quartz is responsible for green color in green aventurine or colored clay mineral produce different hues in various types of jasper. Platy green inclusions of chlorite in quartz caused greenish color. Some labradorite feldspars are colored by inclusions of copper.

**inclusions, autogenetic;** → autogenetic inclusions.

**inclusions, classification of;** → inclusions.

**inclusion, contemporary;** inclusions, which were present at the same time as the host mineral. Also called syngenetic inclusions.

**inclusion, coated stones;** examination of a coated diamond show many small inclusions, which may be make the coating flacks. The coating of stones creates a diverse range of colors such as gray, black, brown, greenish, and green.

**inclusions, cracks or fissures;** those inclusions that are filled with liquid or gas or both, often called flags or feathers.

**inclusion, epigenetic;** post-formed inclusions, which occurred after the formation of the host gem-mineral or diamond.

**inclusion, fluorescence;** some diamonds are fluorescing under long-wave ultraviolet rays, but least glow weakly under short-wave ultraviolet rays. The colors of fluorescence are: blue, green, yellow, violet, and orange.

**inclusion, fingerprint;** many small cloudy hollow inclusions filled with liquid and gas that form patterns resembling fingerprints. → Fingerprint inclusion.

**inclusion, fluid;** during the crystallization or re-crystallization of gems take some small portions of fluids, which frequently contain a small bubble of gaseous phase or their become the form of feather, which can be seen in Sri Lanka sapphires.

**inclusion, flux;** → flux inclusion.

**inclusion, growth lines;** → growth lines.

**inclusion, growth phenomenon;** → growth lines.

**inclusions, growths;** an appearance may be seen in some stones, which occurs as an irregular distribution

of color and zonar structures such as natural sapphire with parallel and straight lines occur in synthetic sapphire they are parallel and curved.

**inclusions, healing fissure;** → healing of fissure inclusions.

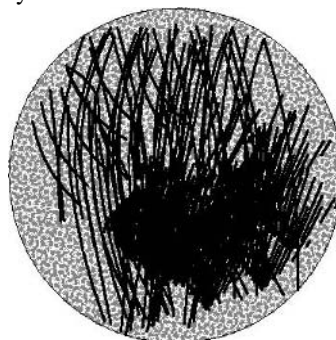
**inclusion, heat-wave effect;** a swirled heat-wave pattern or over-hot-pavement effect may be seen in hessonite a variety of grossularite under microscope.

**inclusion, horsetail;** → horsetail inclusion.

**inclusion in agate;** agate contains some dark inclusion as dendritic (tree-like) or moss agate, and as vegetation in green (colored by chlorite), black (colored by manganese oxide), red (colored by iron oxide).

**inclusion in alexandrite;** the internal features of alexandrite a variety of chrysoberyl is same as chrysoberyl but usually consists of other inclusions such as cavities filled with liquid and bubbles of gas. Sometimes can be seen as so-called *stepped twin planes*. → Inclusion in chrysoberyl.

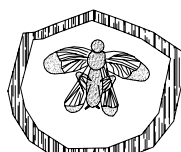
**inclusion in almandine garnet;** the inclusions, which may be seen in almandine and garnets are *zircon*



*bissolite fibers inclusion in almandine with double refraction from Zambia*

*haloes*, rod-like crystal parallel to the octahedral faces of the host, which sometimes intersect at an angle of 60° similar to silk. 4-rayed star may be revealed when the needles project through the stone. Other inclusions are irregular shaped *lumps*, spinel, quartz, biotite, apatite, and phlogopite.

**inclusion in amber;** inclusions in amber are remains of insects or flies, which known as *flies in amber*, plants



*fly inclusion in amber*



*fly anthropoda in amber*



*fly and insect inclusions in amber*

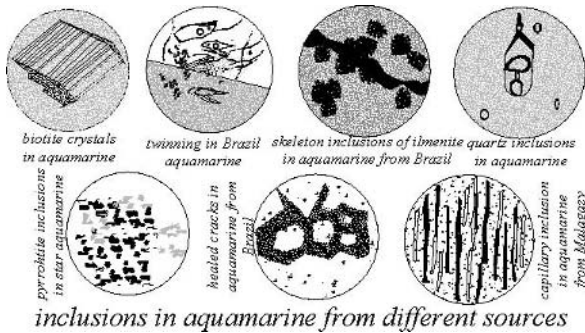
or pin needles or other organic or inorganic material

from prehistoric times and *stress marks* resembling cracked. → Insects in amber, flora inclusions in amber.

**inclusion in amethyst;** inclusions in amethyst appear feather-like and are made of negative cavities, groups of prismatic crystals, tiger-stripe, thumb print, and sometimes cacoxenite crystals are seen.

**inclusion in apatite;** orthorhombic crystals may be seen in some blue apatite as inclusion.

**inclusion in aquamarine;** small or thin needle-like crystals, snowflakes, negative crystals, or tube containing liquid sometimes with bubble of gas. An example of two phases inclusion in aquamarine is *rain feature* parallel to main axis of the apatite crystal.



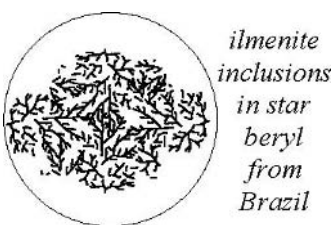
Snowflakes in aquamarine are known as *chrysanthemum* inclusions.

**inclusion in aventurine feldspar;** → inclusion in sunstone.

**inclusion in aventurine glass;** the artificial inclusions in golden brown aventurine glass are or give more spectacular to the glass than any natural aventurine.

**inclusion in aventurine quartz;** green aventurine quartz contains small flakes of green fuchsite mica, the reddish-brown quartz contain spangles of an iron oxide.

**inclusion in beryl;** the internal features in beryl are



feathers of negative crystals, straight rod tubes in parallel arrangement, snowflake or chrysanthemum can also be seen, which are like aquamarine

inclusions. Ilmenite dendritic small inclusions seen in star ruby. → Inclusion in aquamarine, inclusion in emerald.

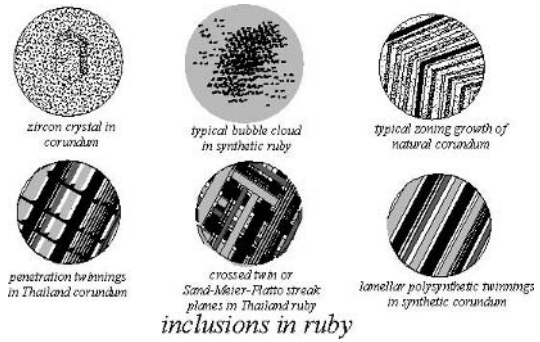
**inclusion in brown quartz;** these are formed of negative crystal cavities and two-phase as inclusions as in brown quartz.

**inclusion in chrysoberyl;** the chrysoberyl crystal is penetrated by microscopic tubes, two-phase or relatively short needles parallel to the vertical or *c*-axis

of the crystal, suitable for cut en cabochon. In brown and yellow varieties can be seen. The so-called *stepped twin planes*, which may lie parallel to the brachydome. Other inclusions are quartz, apatite, actinolite needles, mica plates, and goethite needles. → Inclusion in alexandrite.

**inclusion in cinnamon stone;** same as inclusion in hessonite.

**inclusion in corundum;** the internal features of corundum vary from one locality to another locality such as in *Myanmar, (Burma)* corundum are tiny short rutile needles arranged in three directions parallel to the hexagonal prism, which intersect at an angle of 60° and 120°. In some cases consists canal-like cavities, which are known as silk. In some Myanmar, (Burma) corundum can be as seen well-shaped crystals of rutile, spinel, and mica platelets or rounded crystals of garnet, zircon and corundum inclusions. In bright red rubies from Myanmar, (Burma) swirls can be seen. *Thailand (Siam)* corundum usually consists of hexagonal shaped slabs, tube-like liquid inclusions arranged to a script-like design. In *Sri Lanka (Ceylon)* corundums are seen as rutile needles but longer and wider than Myanmar, (Burma) corundums. Also zircon crystals with a halo of brown color caused by stresses can be seen in host



stone. Irregular liquid filled cavities and color-zoning can be seen. *Cashmere* sapphires show a fine veil-like formation of hazy lines when intersect at an angle of 120°. The corundums from *Montana, USA* shows negative crystals surrounded by flat liquid films. Common inclusions usually seen in various corundums are Long rods and tubes appear, which feather-shaped, repeated twinning (growth lines) are occasionally seen in corundums. An interesting inclusion found in corundum is the so-called *silk* inclusions. Formed from exsolved needle-like rutile crystal or hematite plate inclusions, which occur parallel to the hexagonal prism at 60 and 120. In stone they run parallel or criss-cross and subsurface reflection produce a whitish sheen resembling that of woven silk fabric. Other inclusions are negative crystals, *fire marks* ( small, wavy, roughly parallel cracks are often seen at or near facet edges in

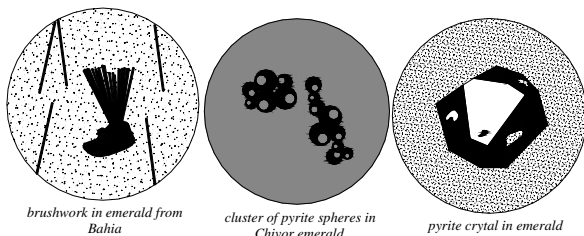
natural or synthetic corundums), polysynthetic twinning, exsolved boehmite crystals, which are seen in synthetic corundum, calcite, zircon, mica, spinel, apatite, garnet, pyrochlore and uranium.

**inclusion in demantoid garnet;** the inclusions in demantoid are byssolite which are fibers a variety of asbestos, which is characteristic of *horse-tails*, with a radiating arrangement of fibers.

**inclusion in diamond;** the internal features of diamonds apart from cleavage, cracks and feathers are graphite, garnet, hematite, magnetite, enstatite, quartz, zircon or diamond itself is a common flaw in diamond plus tiny silky asbestos fibers, often forming radiating horsetail inclusion invariably present in demantoid garnet.

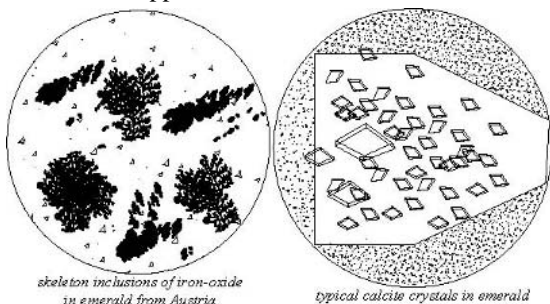
**inclusion in diopside;** the inclusion in brownish-black variety of diopside are rod-like, which cause a four-rayed star effects.

**inclusion in emerald;** the inclusions in emerald crystals are not easy to tabulate, and from locality to locality are numerous. The typical internal inclusions of emerald are: *Muzo* and *Chivor* mines from *Colombian* flat cavities containing liquid, gas and small crystal of rock-salt (three-phase) sometimes with single spike, calcite



three inclusions in emerald

rhombus, and pyrite crystals. *Ural*, Russia emeralds contain flakes of mica, and blades of green actinolite fibers, which appear as a bamboo. *Habachtal*, Austria



two inclusions in emerald

emeralds contain green actinolite or grammatite fiber. *Sandawana*, Zimbabwe emeralds contain green actinolite or curved tremolite fibers. *Transvaal*, South Africa emeralds contain green mica or fuchsite flakes. *India* emeralds contain hexagonal cavities of negative

crystals filled with liquid and gas parallel (two phases) to the main axis of the host crystal. *Pakistan* emeralds have several flakes of mica and small crystals of phenakite within. An unusual radical arrangement of inclusions of albite separates clear emerald segments of six dark spokes radiating from the prism faces of a dark central core seen in Colombian emerald, which named as *trapiche emerald*. Other inclusions are needed of actinolite and two-phase. → Inclusion in aquamarine, inclusion in beryl.

**inclusion in garnet-topped doublet;** → garnet-topped doublet.

**inclusions in glass;** typical inclusions in glass are: bubbles, swirls or cooling striae, sweeper curved lines, hexagonal or trigonal copper plates as in aventurine glass, fibrous with cat's-eye effect in Iimori stone.

**inclusion in grossular garnet;** same as inclusion in hessonite.

**inclusion in hessonite garnet;** inclusions in the stones have a peculiar rounded oily appearance due to inclusions of numerous of minute transparent crystals often accompanied with a *treacle inclusion*, epidote, zircon are included.

**inclusion in iolite;** the so-called bloodshot iolite contain hexagonal platelets of hematite or goethite usually in parallel orientation.

**inclusion in labradorite;** the internal features of labradorite may be seen as needle-like and platelets of magnetite and hematite, which are darkened and produce some blue flashes of color or schiller with a degree of cat's-eye effect, when cut cabochon, it is misnomerly called *black moonstone*.

**inclusion in moldavite;** moldavite contain round or torpedo-shaped bubbles and show swirl striae.

**inclusion in moonstone;** moonstone contains lath-like cracks, which run parallel to the vertical axis of the stone, stress cracks, Chinese aeroplanes, pseudo-insect, oriented needles, which are due to the cat's-eye effect in some crystals, and cavities of negative crystals.

**inclusion in natural gemstones;** → inclusion, inclusion in gemstones.

**inclusion in obsidian;** the internal features of obsidian are small crystallites, which has the form as rod-shaped (belonites), rounded (globulites), twisted hair-like or coiled is known as *trichites*. Also rounded or torpedo-shaped bubbles may also be present.

**inclusion in oligoclase;** → inclusion in sunstone.

**inclusion in opal;** opals from Mexico contain frequently limonite, hornblende, fluorite, quartz, goethite, hematite, pyrite, cristobalite, fluid, etc. as inclusions.

**inclusion in painite;** painite contains very small cavities and large hexagonal tabular crystals.

**inclusion in peridot;** peridot contains inclusions of

biotite flacks, water-lily leaves or lily pads, which are discs like decrepitation haloes frequently with small chromite crystal at the center, and small fluid drops, and gas bubbles.

**inclusions in prehnite;** in some prehnite or a mixture of prehnite and chlorite from Sri Lanka can be found copper as inclusions, which caused the pink color.

**inclusion in pyrope garnet;** the internal features of pyrope garnets are occasionally quartz, augite, crystal needles, snowball pattern, and octahedral-shaped crystals.

**inclusion in quartz;** the internal features of quartz to be seen hair-like needles of red or golden colored rutile included in quartz known as *sagenitic*, *flèches d'amour*, *cupid's darts*, and *Venus hair* or caused star effect in rose quartz, which is known as diasterism and used as imitation star sapphire. Black crystal of tourmaline, or green actinolite fibers, which is called *thetis hair stone*. Sillimanite needles are seen in some rose quartz, which produced star effects. Some crystal shaped cavities containing liquid and bubbles of gas. Green chlorite, which shows as mossy-like, blue to violet dumortierite, red to orange hematite and goethite, green chrysocolla has been reported. Rainbow quartz or iris quartz is caused by interference of light at the thinly films of gas or air in the cracks.

**inclusion in quartzite;** in some quartzite from Korgon, Tomsk area, Russia are seen minute crystal of pyrite, used as small ornamental articles.

**inclusion in rock crystal;** → inclusion in quartz.

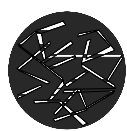
**inclusion in rose quartz;** → inclusion in quartz.

**inclusion in ruby;** → inclusion in corundum.

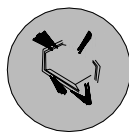
**inclusion in sapphire;** the internal imperfections or features of sapphire vary from one source to another; in Sri Lanka sapphire are rutile needles or hematite plates, which are known as *silk* but longer and more widely



liquid inclusion in form of flag in sapphire



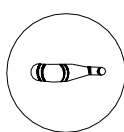
a typical net system of liquid channels in Montana sapphire



metamict zircon kernel with hallo in Sri Lanka sapphire



elongated capillary channels filled with liquid in Sri Lanka sapphire



### inclusions in sapphire

found than Myanmar, (Burma) sapphires. Silk is exsolved very small to microscopically, needle-like of rutile crystal or hematite plate inclusions forming parallel to the hexagonal prism intersecting at 60° or 120°. Also seen never curved but vary straight angular

growth lines as a general inclusion in inside of stone. Solid inclusion such as zircon crystals with a typical halo of brown color caused by stresses in host stone. Other solid inclusions are mica, apatite, calcite, garnet, spinel, uranium pyrochlore, etc. Other example of inclusions are irregular liquid filled cavities known as *negative crystal*, or long stretched three phases inclusions and color-zoning, repeated twinning in form of polysynthetic twin, which exhibit interference figures, parallel cracks, which look like *fire marks* of wavy form caused by overheating by rapid polishing, which is in mostly synthetic stone to seen, sometimes exsolved white boehmite crystals. → Inclusion in corundum.

**inclusion in silica glass;** silica glass contains strings or single spheres or spherulites of cristobalites.

**inclusion in spessartite garnet;** spessartite garnet contains minute liquid drops with a peculiar wavy feather or *shredded* appearance. Also seen silk, but less than almandine.

**inclusion in spinel;** inclusions in spinel are less common than in similar other stone like ruby or sapphire. Rarely silk inclusions, and angular inclusions that is named as *spangles*, which are inclusion crystals with iridescent stress features surrounded the spots. The internal features seen in some blue spinel from Myanmar, (Burma) are cracked, negative hollow cavities of octahedral crystals, which may be a member of the spinel group very interesting like a fingerprint, which known as *ghost-like* feather (arranged of thousands very minute crystals), very seldom silk unlike ruby. Sri Lanka (Ceylon) spinel contains zircon haloes, cracks caused by unequal thermal stress in host stone. Red to black star spinels are usually a rarity, when four-pointed caused by needle-like inclusions of rutiles oriented parallel to the cube axis. Sometimes are seen other solid inclusions such as apatite prisms, calcite or dolomite, sphene, quartz, olivine, spinel, limonite crystals. → Spinel inclusions.

**inclusion in sunstone;** an attractive gem variety of oligoclase feldspar known as aventurine, which contain parallel oriented thin platelets of red or orange hematite or goethite (or both), which cause the reflective iridescence.

**inclusion in synthetic alexandrite;** the internal features of synthetic alexandrite are white acicular and fibrous inclusions.

**inclusion in synthetic corundum;** the internal features of synthetic corundum are two-phase, curved lines or bands with gas bubbles in the form of tadpole-shaped, flask-shaped, bubble clouds, fire-marks, and silk. → Inclusion in corundum.

**inclusion in synthetic cubic zirconia;** inclusions in

synthetic cubic zirconia are translucent cavities to form of isometric pseudo-crystals.

**inclusion in synthetic diamond;** inclusions in synthetic diamond are dust-like dispersed of nitrogen and nickel present with the tend to the axis, when growth is slower.

**inclusion in synthetic emerald;** inclusions in synthetic emeralds consist of veil-like or lace-like feathers. Phenakite crystal are frequently seen. Other inclusions are twisted feather in new flux-fusion emeralds, liquid wisp-like feathers in Chatham emerald, and crack-like marking in Lechleitner emerald,

**inclusion in synthetic sapphire;** → inclusion in synthetic corundum.

**inclusion in synthetic spinel;** in synthetic spinel inclusions are in the form of broad curved lines or bands, which are called *Venetian blinds* and may contain gas bubbles. *Strain knot*, pseudo-interference, and anomalous double refraction or tabby extinction are caused by the presence of alumina in the synthetic spinel. Sometimes gas bubbles have a twisted or turned appearance known as *proflated bubbles* these may be seen as *worm-like* tube inclusions.

**inclusion in three phase;** same as inclusion in topaz and emerald from Colombian.

**inclusion in topaz;** some topaz contains drop-shaped cavities with two or three unmixed liquids (three phase). White topaz from Nigeria, Africa contains cubic crystals. Solid materials found as inclusions as mica, spessartine garnet, monazite, quartz, monzonite, limonite, fluorite, albite, and brookite. In Brazilian topazes needle-like inclusions of limonite-stained etched dislocation channels or cavities in trade are known as *rutilated topaz*. → Topaz inclusion.

**inclusion in tourmaline;** tourmaline contain thread-like cavities, which are formed when tubes are filled with liquid and bubbles of gas. The tubes usually run parallel to the *c*-axis, which causes a cat's-eye effect, when cut cabochon. Occasionally fractures and flat films reflect light from these tubes, which then appears as black patches. Other solid inclusions are apatite, hornblende, tourmaline, quartz, zircon and may sulfide minerals.

**inclusion in tsavorite;** inclusions in tsavorite are group of yellowish fibers of demantoid garnet.

**inclusions, internal cavities;** those cavities that contain gas, liquid or both (two phases) or sometimes with solid materials (three phases).

**inclusion, laser treatment;** diamond treated by laser beams which leaches out the inclusions to make them light in color.

**inclusion, phenakite;** → inclusion in synthetic emerald.

**inclusions, position of;** → position of inclusions.

**inclusion, protogenetic;** already existing inclusion

substances incorporated in gemstone during its genesis.

**inclusion, primary;** primary inclusions are divided into 2 cases: autogenetic inclusions, and xenogenetic inclusions.

**inclusion, repeated twinning;** repeated twinning occasionally seen as inclusions in corundum.

**inclusion, rutile crystal;** rutile needles as inclusion in many gemstones are known as silk, which caused a star effect, etc.

**inclusion, secondary;** inclusions are divided into 2 cases: healing fissure inclusions or exsolution inclusions.

**inclusions, solid;** → inclusions, solid.

**inclusion, syngenetic;** the inclusions are formed at the same time and similar manner as the host gemstone and included in it, when the host grew more rapidly. Also called contemporary inclusions.

**inclusion, three-phase;** → three-phase inclusions.

**inclusion, two-phase;** → three-phase inclusions, inclusions.

**inclusions, xenogenetic;** → xenogenetic inclusions.

**inclusion, zircon halo as;** → inclusion in sapphire.

**inclusion in zircon;** → zircon inclusions.

**inclusion pointer;** in microscopy a needle used to indicate the position of any visible features.

**inclusion spinel octahedron;** tiny spinel octahedral with typical eight-sided crystals may be seen in corundum from Myanmar, (Burma), and Sri Lanka.

**inclusion striae, curved;** inclusions in natural and synthetic rubies and sapphires are curved striae or growth line which is a characteristic phenomenon of natural and synthetic rubies and sapphires.

**inclusion silk (needlelike);** needlelike inclusions of rutile in gemstones are known as *silk*, which consist of very small to microscopically parallel threads that intersect each other at 60° or 120°. Hornblende, tremolite, and chrysotile needles are seen in several stones.

**inclusion types;** inclusions and other blemishes in gemstones are solid, bubble, liquid, cloud, crack, cleavage, graining, feather, glets, butterfly, bearded girdle, fezel, fringe, growth line, etc.

**incoherent;** loose or unconsolidated condition of rock or deposit, commonly applied to recent sediments.

**incoherent light;** a term used in optics for electromagnetic radiation from various wavelengths and phase other than a laser.

**incombustible;** cannot be burnt, in contrast to charcoal.

**Incomparable Diamond;** a fancy-brown, internally flawless, triolette-cut diamond of 407.48 cts, from West Africa. Was cut from an 890 cts, rough stone along with 14 other diamonds. Also known as the Golden Triolette Diamond.



**inconel**; a nickel based white alloy used as a white gold imitation.

**incrustate**; to coat various objects with a hard substance.

**incrustation**; coating or covering with a hard surface layer.

**incrustation**; a setting technique of securing a precious stone in a finger ring by sinking into a collet or other space cut in the metal. In such a ring the metal is pushed inward over the girdle of the cut stone.

**incrustation**; decorative articles formed by small opaque, geometrical shaped, varicolored fragments ornamental hardstones or precious metals, which are incrustated on the surface of the articles.

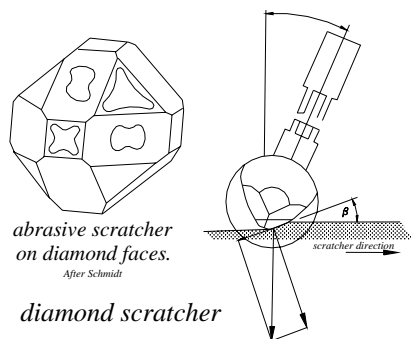
**indanthrene blue R**; same as indanthrone.

**indanthrone**; a blue dye or pigment based on a contraction of indigo  $C_{28}H_{14}N_2O_4$ . Soluble in concentric  $H_2SO_4$  and dilute in alkaline solutions. Used as dyes in enameling. Also called indanthrene blue R.

**indentation test**; same as Knoop indentation hardness test.

**indented natural**; skin or part of the original surface of a rough diamond is left on the surface of a polished diamond. Also called natural.

**indenter test for hardness**; a reliable and alternative test to the scratch test to measurement the hardness of



new or unknown gem or mineral: Test of the Knoop is to make small invisible marks in the surface of material and the impression determined to record hardness.

**indenter test for hardness**; micro-abrasion test usually carried out by using a cone-shaped grinding wheel coated with diamond powder to measure the depth of abrasion after a certain time.

**indenter test for hardness**; using a fluid energy mill, which was developed to determined abrasion rates. Fragments of certain minerals were tumbled for 25 minutes to produce spheres, after tumbling they were weighed and the losses taken as a measure of resistance to abrasion. → Knoop indentation hardness test.

**Independencia Diamond**; a diamond of 106.82 cts, rough weight found in 1941 in Brazil.

**inderite**; a borate mineral dimorphous with kurnakovite. Monoclinic crystal. Chemical formula:  $2[MgB_3O_3(OH)_5 \cdot 5H_2O]$ . Vitreous luster. Colorless. Streak: colorless. Transparent. Cleavage: {110} good, and {110} indistinct. Fracture: conchoidal to even. Brittle. Optics;  $\alpha$ :1.488,  $\beta$ :1.490,  $\gamma$ :1.505. Birefringence: 0.018.  $\ominus$ . SG:1.78-1.80. H:2½-3. Found in arid regions in USA, and Russia. Often cut and polished by amateurs. Also called lesserite.

**indestructible pearls**; a misleading commercial term for solid opalescent glass beads coated with essence d'orient.

**index ellipsoid**; crystallographic indicatrix of a crystal other than an isotropic crystal. Also called indicatrix.

**index glass**; a double-reflecting, hand instrument which measures angle between distant objects up to  $120^\circ$  in any plane, but now applied to similar instruments regardless of range. Also called mirror index, sextant.

**index liquid**; same as immersion liquid.

**index mineral**; a mineral, formed in a series of higher grade of metamorphic rocks, it is a mineral whose first appearance marks the outer limit of the zone in question. Also called guide mineral.

**index mineral**; a small sample of a mineral (inclusion free) used as indicators in gemology and mineralogy of known specific gravity of heavy liquids. Used to indicate the approximate specific gravity of heavy liquids. → Indicator mineral.

**index of refraction**; in crystal optics, a number indicating the speed of the velocity of light in a vacuum or air to its velocity in a given crystal. The refractive index of a crystal can be expressed as ratio of the sine of the angle of incidence to the sine of the angle of refraction from Snell's law for any two media. Its conventional symbol is  $n$ . In gemology and mineralogy RI is an abbreviation for refractive index:

$$RI = \frac{\text{sine of incidence light}}{\text{sine of refraction light}}$$

The higher refractive index of a stone, the greater brilliance, such as diamond with RI: 2.4173 for sodium light at 589.3 nm. When a velocity of light is decrease in a gemstone (dense material) it is always inversely proportional to the optical density. In single refractive or uniaxial mineral the indices are  $\omega$  for ordinary-ray and  $\epsilon$  for extraordinary-ray. In the double refractive biaxial stones the indices are  $\alpha$  a minimum value,  $\beta$  an intermediate value and  $\chi$  a maximum value. Also called Refractive index or refractive index of medium. → Optical character, birefringence optical density, optical sign, optical positive, optical negative.

**India;** once an important producer of diamonds from about 1000 A.D.

**India;** same as India stone.

**India cut;** → Indian cut.

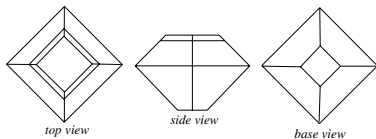
**India pearl;** → Indian pearl.

**India stone;** a remarkably fast-cutting, long-wearing oil stone, a smooth fine-grained stone used to sharpening edged tools, made from alundum. Also called India.

**Indian agate;** an alternate name to moss agate, mocha stone or dendritic agate.

**Indian cat's-eye;** same as chrysoberyl cat's-eye.

**Indian cut;** an asymmetrical and clumsy *single-cut* approximately in the form of a brilliant cut in India and Sri Lanka. To retain as much weight as possible the table is usually



*old Indian-cut or Ceylon cut*

double the size of the culet. This cut form was adopted in the past by East Indian cutters. Sometimes called Mogul (Mughal) cut. Also known as India cut, Ceylon cut.

**Indian Diamond;** a tinted white, pear-shaped diamond of 250 cts, from India, it is believed to be the Nizam Diamonds. Present owner unknown.

**Indian diamond;** alluvial diamonds found in compact sandstones, conglomerates and gravels of river-beds from several mines were mined as early as around 800 BC. Some sources such as the Panna area in the north are still mined.

**Indian elephant;** → elephant ivory.

**Indian emerald;** a misleading term for green-dyed cracked quartz. → Cracked stone, dyed stone.

**Indian garnet;** another term for almandine.

**Indian Gemmological Institute;** → Gemmological Institute of India.

**Indian jade;** a misleading term for green aventurine quartz contains fuchsite, which resembles jade. Found in the form of quartzite in India.

**Indian kyanite;** kyanite from India used as gemstone.

**Indian limestone;** same as spargenite.

**Indian necklaces;** necklaces, which are cut and strung in India on temporary or permanent cord, sometimes with or without fittings or clasps. Mostly are characteristically non-uniform but the modern productions of these are spherical and uniform. Usually the faceted beads are ready to wear.

**Indian oilstone;** an abrasive material used as grinding and polishing.

**Indian pearl;** mostly faint rosy tint pearls fished from the Sri Lanka coast are merely marketed at Madras,

India.

**Indian pearl;** pearls from Bombay and Madras. Also spelled India pearl.

**Indian pearl;** a term applied to Oriental pearls.

**Indian pipestone;** same as catlinite.

**Indian pondstone;** a term applied to sharpening stones from Indian Pond.

**Indian red;** a yellowish-red to ocher-red soil from the Persian Gulf containing red pigment of ferric oxide used in painting and polishing. Also called Persian red.

**Indian rule;** same as Tavernier rule.

**Indian topaz;** a local misleading term for yellow corundum (sapphire) from India.

**Indian topaz;** a misleading term for citrine quartz.

**Indian topaz;** a misleading term for any yellow topaz from Sri Lanka (Ceylon).

**Indiana diamond;** a misnomer for rock crystal from Pecos-River, New Mexico, USA.

**Indiana limestone;** a trade term for spargenite, which is quarried in southern Indiana.

**Indiana limestone;** same as Bedford limestone

**Indianite;** a granular variety of anorthite feldspar, which occurs with corundum in Carnatic, India.

**indicating eyepiece;** an eyepiece that is fitted with a movable pointer (often used the clock-face type), which may be turned to indicate the position of inclusions.

**indicator gauge;** same as gauge.

**indicator minerals;** in geology or mineralogy a feature, which indicates the presence of a mineral deposit. The red, green, and yellowish minerals such as garnet, ilmenite, diopside, and zircon may indicate the presence of diamond. Also called in South Africa *batman*, and in Russian *sputnik*.

**indicators;** in gemology and mineralogy small sample of minerals or other materials (inclusion free) of known specific gravity used to indicate the approximate specific gravity of heavy liquids. The following substances are usually used:

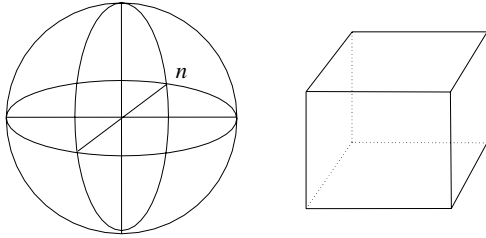
table 10: mineral indicators

mineral	specific gravity
quartz	2.65
calcite	2.71
tourmaline	3.05
fluorite	3.18
peridot	3.34
diamond	3.52
topaz	3.56
chrysoberyl	3.72
demantoid	3.85
corundum	3.99
sphalerite	4.09

→ Heavy liquids, diffusion column.

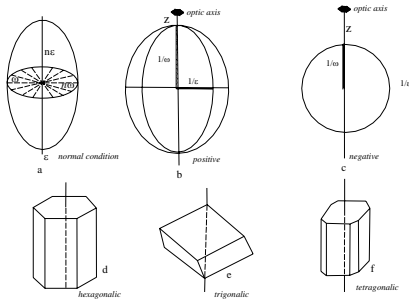
**indicators for heavy liquids;** → indicators.

**indicatrix;** in crystal optics, a geometrical figure used to



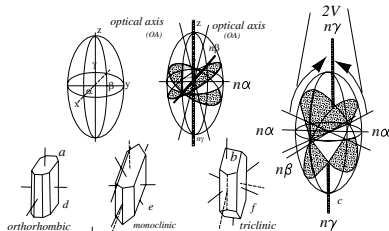
a sphere with three propagation of light with same speed and refractions in all directions such as in cubic crystals or amorphous minerals

represent the refractive indices of a crystal. It is an



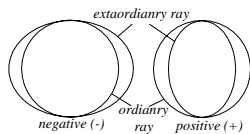
a: an ellipsoidal sketch of an uniaxial crystal with two different refractive indices,  $n_o$  and  $n_e$ . b: positive condition and c: negative condition with three (d-f) uniaxial crystal systems

ellipsoid with three rectangular axes, whose lengths of the axes represent the refractive indices for those



a three axial ellipsoid of an biaxial crystal with three different refractive indices,  $n_\alpha$ ,  $n_\beta$  and  $n_\gamma$ . Two circular section are perpendicular to each other, b shows positive condition and c negative condition and d-f three different biaxial crystal systems

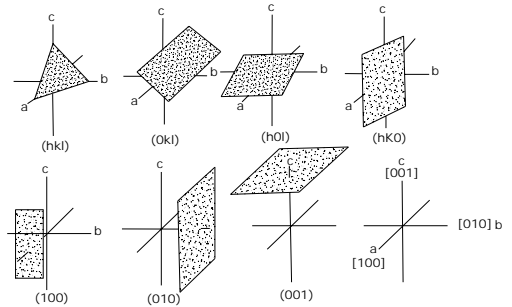
vibration directions. These axes are commonly named a, b, c, or X, Y, Z, or  $\alpha$ ,  $\beta$ ,  $\gamma$ . In this publication  $\alpha$ , for the



light velocity surface of uniaxial in positive and negative crystals

the smallest refractive index and fast ray;  $\beta$  for the intermediate refractive index and intermediate ray;  $\gamma$  for the largest refractive index and the slow ray. Synonym for optic indicatrix, index ellipsoid.

**indices of crystal faces;** various methods of notation of



indices of crystal faces or Miller indices. After Niggli 1941

crystallographic form and faces have been devised to express the intercept ratios. The most commonly used the system of Miller. Indices of a face consist of a series of whole numbers, which are derived from the parameter by their inversion. → Miller indices.

**indices of refraction;** → index of refraction.

**indicolite;** a light-blue, violet-blue blue to deep red or deep green sodium-rich variety of tourmaline used as a gemstone. Also miscalled Brazilian sapphire and indigolite.

**indigo;** an important blue dye extracted from species of the *indigofera* bush of chemical formula:  $C_{16}H_{10}N_2O_2$ . Soluble in water and alcohol. Used as a dye and for ink. In Sanskrit: *nilangandhi*. A variety of them called blue wood, logwood. Also called blue indigo, blue dye indigo, C.L. vat blue, blue dye. An active indigoid chromophore known as H-chromophore. because of its peculiar structure.

**indigo as dye;** blue indigo used as dye (with a kind of resin together), to improve the color of gemstones such as quartz, beryl. Also called C.L. vat blue. → Acetate of copper.

**indigo as dye for beryl;** indigo used as dye with a kind of resin together to produce an aquamarine color beryl. → Acetate of copper.

**indigo copper;** → covellite.

**indigo sapphire;** a very dark blue variety of sapphire.

**indigolite;** a misleading term for indicolite.

**indirubin;** a dark red crystalline compound of  $C_{16}H_{10}N_2O_2$ , which is isomer with indigo. Obtained from natural indigo because it is present in indigo. Used as dyes.

**indium;** a soft, silvery-white, malleable, easily fusible, metallic element of the Periodic System with the symbol In.

**indochinite;** a variety of tektite from Southeast Asia.

**Indonesian diamonds;** a small diamond deposit in Indonesia, which is still mined. → Borneo, Kalimantan.

**Indore Peras;** two high color, pear-shaped diamond of 46.95, and 46.70 cts, from Indore, India. Was bought by

Harry Winston in 1946 and recut into 46.39, and 44.14 cts, and sold to a private buyer. They were auctioned by Christie's in 1987.

**indra;** a variety of casein resin.

**indrâjudha;** a Sanskrit term meaning, diamond Indra's weapon.

**induced emission;** → stimulated emission.

**induced radioactivity;** → artificial radioactivity.

**indurated;** any artificially restricted compact rocks, which are create by the action of pressure, cementation, air and heat, which made hard.

**induration;** any process of hardening of rock by heat, pressure, air, or cementation. → Indurated.

**industrial diamond;** a general term for rough diamonds of nongem-quality in relation to flaws, poor color, shape, and quality. Used as tools, drills, abrasive grinding, cutting, or other industrial applications. Synonym for industrial stone.

**Industrial Diamond of South-West Africa, Ltd.;** a diamond company founded in 1945 in the Luderitz Province, South-West Africa. Also known as Indosia an abbreviation. Also called industrial stone.

**Industrial Distributors, Ltd.;** an organization founded in 1946, belonging to the De Beers-Diamond Corporation, which purchases industrial diamonds for classification and marketing through Industrial Distributors (Sales), Ltd.

**Industrial Distributors (sales), Ltd.;** an organization founded in 1946, belonging to the De Beers-Diamond Corporation, which classifies and markets industrial diamonds to other industrial diamonds traders.

**industrial diamond grit;** same as synthetic diamond grit.

**industrial mineral;** any mineral, rock or other naturally occurring material of economic interesting except gemstones, and metallic ores or minerals. Minerals and rock mined for its nonmetallic, value such as salt, sulfur and stone.

**industrial stone;** same as industrial diamond.

**inert;** having little or no ability to react either to stimulation by ultraviolet or X-ray irradiation, or cathode rays, or to any chemical reagents.

**inert gases;** same as noble gases or rare gases.

**inferior cleavage:** a grading name used at claim state for a diamond block, or cleavage. It is poor colored and mostly spotted.

**infilling;** material or substances used for filling in.

**infrared;** the part of electromagnetic invisible spectrum whose wavelengths lie beyond the red end of visible spectrum (750 nm) and before the microwave end of the radio spectrum (1,000,000 nm or 1 mm). The spectrum consists of so-called heat rays, which produces in certain gems a luminescence. It is very

useful to quality of film sensitivity. All commercial diamond manufactured lasers produce infrared radiation. Also called infrared radiation, long-wave radiation, long-wave.

**infrared absorption;** → infrared spectrum.

**infrared filter;** substance of high infrared transmittance that is used as a filter in infrared photography. Applied to distinguish between natural and synthetic emeralds, natural emerald show dull, while synthetic emerald look brilliant red.

**infrared glass;** a black to reddish amber-colored glass or quartz glass that transmits invisible infrared rays containing iron oxide, which is the effective bar to the passage of infrared rays.

**infrared lamp;** an illuminating high-power incandescent lamp working at a lower filament temperature.

**infrared photography;** a method of aerial photography during misty weather and darkness, which is used as a special film that is more sensitive to infrared rays than to visible light rays.

**infrared photospectrometer;** a spectrophotometry in infrared region used in determinative gemology and mineralogy, for the purpose of chemical analysis by means of their interaction with infrared radiation. The absorption spectra is associated with rotational and vibrational energy level of molecules after passing through the material.

**infrared radiation;** electromagnetic invisible radiation whose wavelengths lie in the range of red end 740 nm to 1 mm, which are emitted by hot bodies. Also called heat radiation.

**infrared spectrometer;** any instrument similar to an optical spectrometer with a source of infrared radiations these are rarely used in determinative spectroscopy.

**infrared spectrophotometer;** → infrared photospectrometer.

**infrared spectrum;** the intensity of infrared radiation, which is absorbed or emitted by a substance as a function of the wavelength, which lies in the range of the red end from 740 nm to 1 mm.

**infusible;** having a very high melting point such as quartz. In the fusibility scale the matter does not fuse in temperature of up to 1500° C.

**ingrain azo dye;** → ingrain dye.

**ingrain dye;** an insoluble dye obtained by impregnating a material with some intermediates and creating a dye by reaction with different intermediate compounds. Also called insoluble dye, ingrain azo dye.

**inherent vice;** a term applied to characteristic weakness in diamond stone, which may result damage to the stone during cutting, polishing, or when it is worn.

**inhomogenous;** not homogenous in properties or composition.

**injected electroluminescence;** → intrinsic electroluminescence.

**injection electroluminescence;** when in a semiconductor junction electrons and holes are injected. → Intrinsic electroluminescence, charge injection electroluminescence.

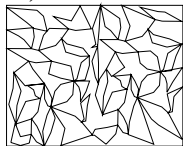
**injection;** the process of intrusion or replacement of an ore-bearing magma into pre-existing rock. Also called intrusion, replacement, irruption.

**ink stone;** stone containing melanterite used in ink making. Also called atramental stone, killow, atramentum.

**inky sapphire;** dark blue sapphire.

**inky topaz;** a dark grayish-blue irradiated topaz, which is produced in a reactor. The resulting color is suitable blue without applying heat-treatment. This material in trade is known as *London blue topaz*.

**inlay work;** decorative articles embedded by small dark, hard and fine stones used as basic stone, which has been inlaid with other colored or colorless geometrical shaped gemstones and



*inlay or mosaic of different stones*

sometimes precious opal or ivory flowers. Also called pietre dure (pietra dura), intarsia, florentine mosaic.

**inlier;** an older stratified rock completely surrounded by younger rocks.

**in line;** → tourmaline bent.

**in line with the run;** an informal term used by Australian miners for production of opal in a shaft sunk in line with other shaft of opal.

**inner core;** a term applied to central iron part of the Earth's Core (one third of the whole core), which extended from a depth of about 5100 km to the center of the Earth 6371 km. Also called siderosphere, lower core. → Core.

**inner crust;** a term applied to the inner area of the Earth crust. Also called internal crust, interior crust.

**inner septa;** inner part of nautilus shell, which is divided up into chambers, which are used for mosaic or inlay work.

**inner structure;** → structure.

**inner transition elements;** the lanthanide element series are involved with 4f electrons starting with Ce and ending with Lu. The next row is actinide series are involved with 5f electrons starting with Th and ending with higher transuranic element Lw. These two rows of lanthanides and actinides labeled as *inner transition elements*. These elements are very rare on the earth's surface to seen and are not as much important as outer transition elements. The color of trivalent ion of

lanthanide elements are mentioned in below table:

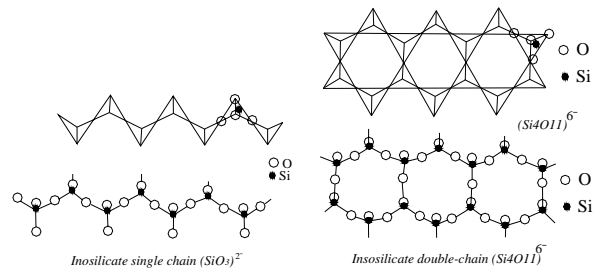
table 11: color of trivalent ion of lanthanide elements

element	color	element	color
lanthanum	colorless	lutetium	white
cerium	yellow, colorless	ytterbium	yellowish
praseodymium	green	thulium	greenish
neodymium	pink, lilac	erbium	reddish
promethium	yellow, pink	holmium	light yellow
samarium	light yellow	dysprosium	light yellow
europium	pink	terbium	reddish
gadolinium	colorless		

**inorganic;** any substances that are not produced by vital processes or once vital organisms.

**inorganic substances, colors in;** color in solid compounds are caused by the nature of atoms involved, chemical bonding and electrical forces between the atoms. → Color.

**inosilicates;** a group of silicate structures, in which the  $\text{SiO}_4$  tetrahedral may link into linear single or double chains of indefinite lengths by the sharing of oxygens of indefinite length, the ends, of which are at the surface of the crystal. Single chain such as pyroxenes, double chain or band such as amphiboles. Synonym for



*inosilicate single and double-chain*

chain silicate, and obsolete as metasilicate.

**inro;** a Japanese term for small button-like ornament made of beryl or emerald, which is worn by Japanese used to suspend small tobacco or medicine box. → Netsuke.

**ins;** a Myanmar (Burmese) term for excavations in ruby mines, larger than kobins. Also called in-byes.

**insects in amber;** fauna inclusions mostly insects in amber are: *Arachnoidea* such as spider, mites, scorpion, centipede, *Coleoptera* such as beetles, *Diptera* such as two-wing flies, *Hymenoptera* such as bees, ants, wasps, *Microlepidoptera* such as little moths, *Neuroptera* such as caddis, *Orthoptera* such as cockroach, grasshopper, *Pseudoneuroptera* such as termites, mayflies, *Rhynchota* such as lice, gnats, etc. → Amber, inclusion in amber.

**inset;** igneous rock, in which the crystal grains are

relatively large enough to be distinguished with unaided eye. Also called, phenocrystalline, phaneritic, coarse-grained phanocrystalline.

**inshore mining;** beach mining close to the shore.

**in situ;** a gem mineral found in their original position of formation. In geology in original place. → Autochthonous.

**in situ;** a term used for original jade mines.

**insolation;** exposure to the sun's irradiation. Sunstroke.

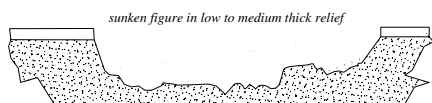
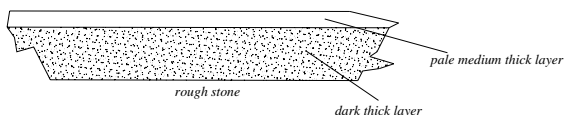
**insoluble azo dye;** → ingrain dye.

**insoluble dye;** same as ingrain dye.

**insulator;** → electroconductivity.

**Instituto Gemológico Español;** address of Headquarters for this society are located at: Victor Hugo 1, 3, Madrid 4, Spain.

**intaglio;** an Italian term for a style of incised gemstone



*engraving of intaglio from layered stone. After Sinkankas 1968*

or diamond created by carving or engraving below the surface so that the carved symbols, monograms, and objects are hollowed out and appear as a negative relief. It is in contrast to cameo. Used as finger rings, brooch, pendants, buttons, seals, etc. Also called *hollow relief* or *coelanaglyptic*.

**intaglio doublets;** a counterfeit doublet consisting of two pieces of glass, the upper piece either engraved or often molded, the top piece is then joined on to a base plate, usually a red-brown porcelain or other material used as cement to imitate carnelian. → Cameo doublet.

**intarsia;** embedding of a formed pattern with small colored ornamental tones fragments to make a non-geometrical picture. The term is a contrast to Parquetry. Also called inlay work, Pietra dura, or a mosaic. → Inlay work, mosaic.

**intensity;** → definition of color.

**intensity, color;** the strength or sharpness of a color, which express brightness or dullness of a hue.

**inter alia;** among other things.

**interbedded;** rock or minerals laying between beds parallel to other beds of different mineral or rock. Synonym of interstratified.

**intercapillary;** inclusions are located between capillaries.

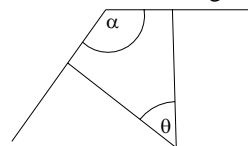
**intercrystalline;** situated between the crystals of a

substance.

**intercrystal porosity;** porosity between equal sized crystals. → Intracrystal porosity.

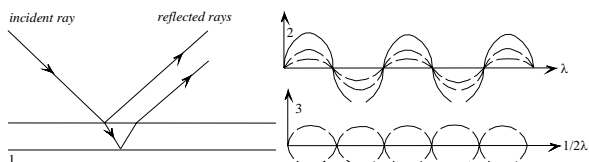
**interfacial angle;** the angle between two faces of a crystal, which adjoined two faces.

**interference;** → interference of light.



*interfacial angle.θ: angle between normals to faces*

**interference and diffraction colors;** the turning back of interference light from surface or from interior of a stone may produce different spectral color when the angle of incident light changes. Such a spectral color caused from interference of light and from reflected light from thin surface layers. This phenomenon is rarely seen in cut and polished stones but interference colors are produced by internally diffracted light caused by thin layers surfaces as fractures, cleavages,



*color caused in a thin layer (1) due to mutual interference between reflected rays by one wavelength ( $\lambda$ ) phase (2), by 1/2 wavelength ( $1/2 \lambda$ ) phase of rays occurs color cancellation (3)*

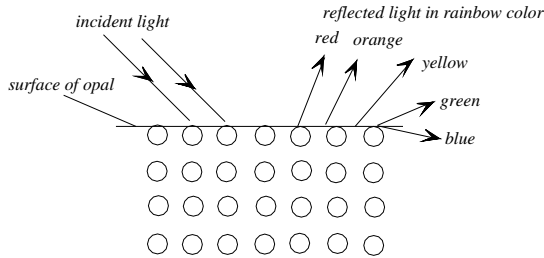
twins, exsolution lamellae, liquid and gas, such iridescence colors in opal are caused by interference of light on cleavage planes of closely packed spheres rather than by selective absorption, which produced the *play-of-color* in opal. Such effect can be seen in iris agate, opal, and some feldspars of gem quality. Iridescence, flame, labradorescence, schiller are caused by interference and diffraction colors. → Flame agate, flame obsidian, flame opal. Also called color interference and diffraction.

**interference at thin films;** → interference of light.

**interference colors;** the visible spectral colors formed by reinforcement of a birefringence mineral in crossed polarized light such as quartz. Also called polarization colors. → Interference phenomena, constructive reinforcement, interference and diffraction colors.

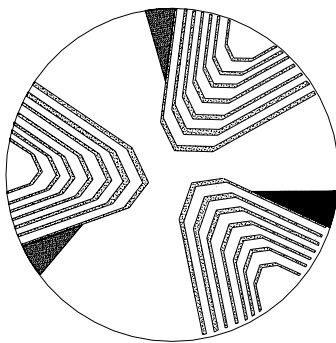
**interference colors in opal;** the iridescence colors of

opal are caused by interference of light rather than by selective absorption, such effects causes as the play-of-color in opal.



*interference effect of white light from the opal surface in rain-bow color due to quasi ordered silica spheres in submicroscopical sizes*

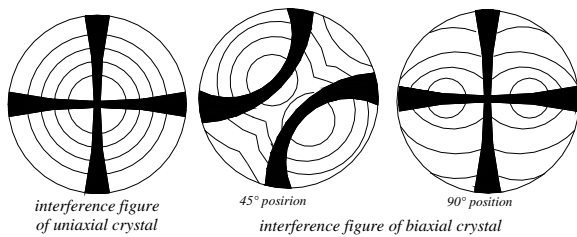
**interference colors in quartz;** the interference band colors seen in natural quartz or amethyst are caused by



*colored interference bands seen in natural quartz or amethyst due to twining through in the direction of optic axis by crossed Nicols. After Read 1997*

twining through in the direction of optic axis by crossed Nicols.

**interference figures;** a series of specially light and dark colored phenomenon, quasi symmetrical concentric optical patterns combined with a blank cross due to the



*interference figures*

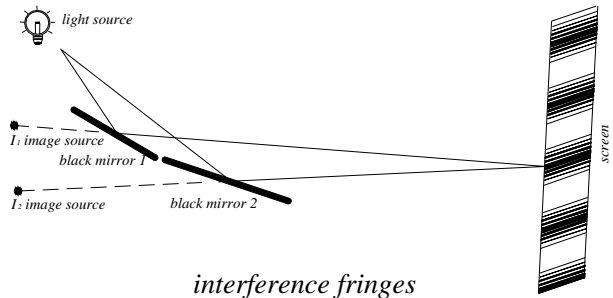
interference of light, when a thin section of a crystal, cut perpendicular to the optic axis of uniaxial mineral such as tetragonal and hexagonal (trigonal) or to the acute bisectrix of biaxial mineral such as orthorhombic, monoclinic and triclinic, specially colored curves or rings of optical patterns combined with two black parabolic curves known as isogyres. These phenomenon are viewed in polarization light under

strongly convergent light. Interference figures are useful for examine of the optical properties of unknown stones. Sometimes called directions image. → Conoscope, interference phenomena.

**interference figure bulb;** a spherical stone-holder was made as an immersion sphere in gemological microscopy, constructed and marketed by the Gemological Institute of America.

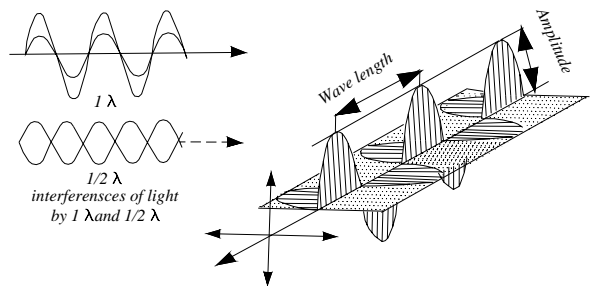
**interference filter;** a color filter used in gemology to produce certain yellow monochromatic light to determined the refractive index of crystals.

**interference fringes;** an optical term used for a series of bright and dark bands formed by interference of light



wave produced by two Frensel's black glass mirrors to reflect the light.

**interference of light;** when two or more light waves pursuing the same path, in which the waves are out of phase, after traveling different path, they complain interference and tend to destroy one other (destructive cancellation), if they are in phase they reinforce each other (constructive reinforcement). Iridescence colors



*interferences of light*

that are seen in some stones or thin film air-filled transparent stones such as in precious opal. The iridescence effect is caused by cleavage, cracks known in *rainbow quartz*, which is a form of interference. Interference or iridescence in gemstones caused by diffraction of light from a lattice, at thin films and ultramicroscopic spheres such as cristobalite or silica with a diameter of 150-400 nm within precious opal. Also called optical interference → Play of color, schiller, orient, destructive cancellation, constructive

reinforcement.

**interference pattern;** → interference of light.

**interference phenomena;** in crystal optic, one of the spectral colors made visible by the reinforcement of a birefringence mineral in crossed polarized light. Thickness and orientation of the thin section or fragments and the nature of light are important for characteristic of colors and their intensity. For example the colors seen reflected from labradorite and opal are caused by interference. In uniaxial minerals the optic pattern looks like a series of colored rings, which is intersected by a black cross due to the interference of light with a thin section of a crystal, cut perpendicular to the optic axis. In case of biaxial crystals the optic figure specially colored curves or rings optical patterns combined with two black parabolic curves known as isogyres. → Constructive reinforcement, destructive cancellation, interference colors in opal, interference colors in quartz, interference figures.

**interference test in a thin film;** an optical term used for a *optical flat* for this purpose a glass disk is polished thin as less than as wavelength of light, which placed to the optical flat and illuminated with laser beam, interference phenomenon such as fringes reveal any gap and unevenness between two surfaces. → Interferometer.

**interferometer;** an optical device designed to split a beam of light into two or more beams and re-unites them to produce interference.

**interferometry;** the using of optical interferometer to determining of wavelength of very small distances and thickness.

**interfoliated;** situated between leaves. Interleaved.

**intergranular;** → granulitic.

**intergranular porosity;** a term applied to the porosity between the particles and grains of rock. → Intracrystal porosity.

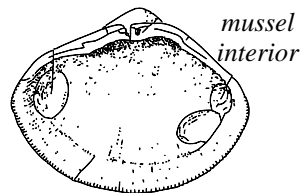
**intergrowth;** the interlocking arrangements of two different minerals or more as a result their simultaneous crystallization. Also called grown together. Perthite is an example of intergrowth. → Graphic granite.

**intergrowth in tourmaline;** the interlocking arrangements of two different minerals or more with tourmaline as an inclusion result due to simultaneous crystallization. → Graphic granite.

**interior;** the central or inner area of a structure.

**interior of mussel;** a hard, horny, rigid, inner part of certain salt-water and fresh-water animal such as snail, mollusks, turtles, etc., which consist largely of calcareous, chiefly or partly chitinous, siliceous, or horny. Shell used as inexpensive various purposes in jewelry, for carving shell cameos, ornamental objects and utensils. It displays pearly iridescence for making

small spoons, knife handles, carving boxes, in jewelry for brooches, finger rings, ear-studs, dress-studs. *Cat's-eye* effect can be produced from black-lip pearl oyster,



when cut suitably, which misnomerly is called *cat's-eye shell*. *Paua shell* has bright green and blue colored nacre found on the coast of New

Zealand. Some shells are dyed by soaking in organic dyes but the colors are unstable. Other shells such as trochus, pink conch pearl, nautilus, Antilles pearl, sea snail are fished because of their shells. → Shell, using as ornaments. The so-called tortoise shell used as piqué work.

**interior structure;** → structure;

**interlaced;** confusedly to cross one fiber over another such as fibers or needle crystals in minerals. Also called interwoven.

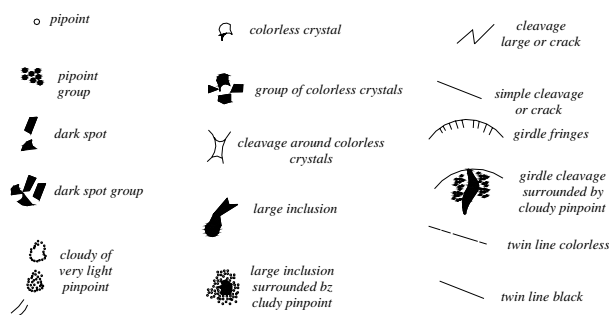
**interlayer;** a layer placed between beds parallel to other beds of different mineral or rock.

**intermediate igneous rock;** igneous rocks containing 52-66 % SiO<sub>2</sub> such as diorite, which is between the acid (granitic) and basic (gabbroic or basaltic) rocks. The name includes syenite and trachyte (subacid), andesite (subbasic). Also known as intermediate rock.

**intermediate rock;** → intermediate igneous rock.

**intermediate zircon;** intermediate zircon range in whose constant ranges from the high to the low type.

**internal blemish signs of cut diamond;** internally



#### internal blemish signs of cut diamond

imperfections of a fashioned diamond depending on the flaws of cut stone.

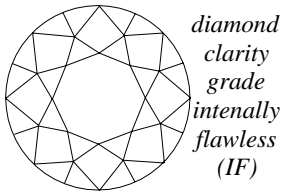
**internal characteristic;** a name used for internal imperfections or flaw, which are enclosed within a host gemstone.

**internal epitaxy;** an inclusion crystal grown in host crystal in the same direction.

**internal graining; grain line;** → twinning line, growth line.

**internally flawless;** a GIA clarity grade and Scan. D.N.





diamond  
clarity  
grade  
internally  
flawless  
(IF)

clarity-grading scale of polished diamonds, which are internally free from features visible under 10x magnification, but with small external

blemishes such as scratches, minor naturals, etc. Abbreviation: IF.

**internal paragenesis;** interwoven of minerals with another. → Inclusions.

**internal reflection;** a describing term for reflection of rays from the internal of a gemstone.

**internal strain;** a stress set up inside a gemstone results in structure irregularities such as twinning or distortion, or inclusion in the stone. Also called internal stress.

**internal stress;** same as internal strain.

**internal structure;** → structure;.

**International Confederation of Jewelry, Silver-ware, Diamonds, Pearls and Stones;** same as Confédération internationale de la bijouterie, joaillerie, et orfèverie des diamants, perles et pierres. Which was founded in Paris in 1961. Abbreviation: CIBJO.

**International Diamond Council;** an organization founded by the World Federation of Diamond Bourses and International Manufacturer's Association in 1975 to establish rules for nomenclature, and grading of diamond. Abbreviation: IDC.

**International Diamond Manufacturer's Association;** an international trade organization founded in 1946. This association promotes cooperation and coordination between diamond manufactures and all other supplies, companies, and institutions. Abbreviation: IDMA.

**International Gemmological Institute;** Headquarters: Schupstraat 1/7 - 2018 Antwerp, Belgium. For North and South America: IGI, 579 Fifth Avenue, New York N.Y. 10017, USA. Abbreviation: IGI.

**International Pipe;** kimberlite diamond pipe in south Mirnyi in Shake, Yakutia, the Russian Federation, CIS.

**International metric carat;** the International metric cts, is equal 0.2 gram or 200 milligrams. → Carat, karat.

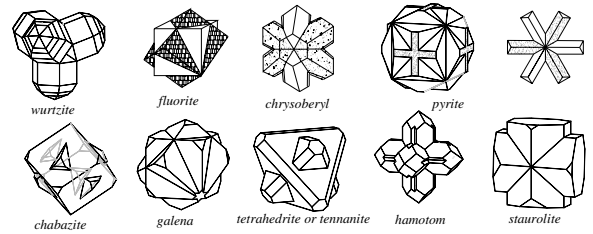
**International Standard Organization;** an international organization, which stabilizes manufacturing and trading standard for products in international trade. Abbreviation: ISO.

**interparticle porosity;** the porosity between the fragments and grains in a rock. → Intergranular porosity, intracrystal porosity.

**interparticle crusher;** a type of crusher used to increase the recovery of minute diamonds fragments from alluvial and in situ sources.

**interpenetrant twin;** same as interpenetration twin.

**interpenetration twin;** when two or more individual crystals penetrate each other with multiple twinning



different kind of interpenetration twinning crystals

along a common twinning direction during changes in physical conditions such as fluorite. The degree of hardness of diamond or other gemstones changes across the twin plane. The separation of such diamond by sawing is impossible. Also spelled penetration twin or interpenetrant twin. → Twin, contact twinning.

**interphase;** a transition zone between two phases in a system such as liquid/ liquid, solid/liquid, and liquid/gas.

**intersection line;** line of intersection.

**interstitial;** filling the pores of a host rock by minerals of a mineral deposit.

**interstitial;** → defects in crystal, color effect.

**interstitial defect;** filling of a normal space interstice with an extra atom in a crystal structure. → Defects in crystal, color effect.

**interstratified;** → interbedded.

**interstitial;** between striae.

**interval;** the distance or difference between any two points or qualities.

**intervalence charge transfer;** the moving of an electron from one transition metal into another that caused energy by absorption of light, which produce an instable change in the valence state of both ions. This can be seen in blue sapphire as result of transfer. It may be caused black or dark colors due to many metal ions such as magnetite ( $\text{Fe}_2\text{O}_3$ ). Frequently called cooperative charge transfer. Intervalence charge transfer normally happen in two ways, homonuclear intervalence charge transfer and heteronuclear intervalence charge transfer.

**interwoven;** same as interlaced.

**in the round;** a style of cutting that has the full form.

**intracrystalline;** across the crystals or grains. Within the crystals or grains. Also called transcrystalline. → Intracrystal porosity.

**intracrystal porosity;** pores within individual crystals, such as fluid inclusions. → Intercrystal porosity, intracrystalline.

**intratelluric**; formed or occurring deep within the Earth.

**intratelluric water**; same as juvenile water.

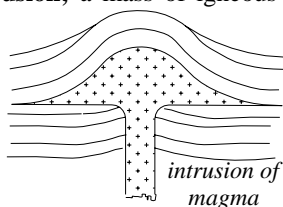
**intrinsic crystal**; a crystal whose photoelectric conditions do not depend on impurities.

**intrinsic electroluminescence**; a term used in crystallography for electroluminescence in crystals or stones in which the color depends on the nature of phosphor as well as on the electric frequency. The reverse process of that is known as injected electroluminescence. Also called Destriau effect. → Charge injection electroluminescence.

**intrinsic semiconductor**; a term used in crystallography for conductivity of a semi-conductor of crystal or metal in which impurities and crystal defects are in very small concentration or are absent. → Semiconductor, intrinsic semiconductor.

**intrusive**; → intrusive.

**intrusion**; a mass of igneous rock of varying size and structure, in the condition of magma has forced itself through and into pre-existing rocks, perhaps along lines of weakness such as



faults and bedding planes under high pressure. Such rocks are known as intrusive rocks, intrusive igneous rocks. Also called invasion. → Extrusive rocks.

**intrusive**; having molten materials, which penetrated into opening or between layers of other rocks before reaching the surface. Synonym for irruptive.

**intrusive breccia**; a heterogeneous mixture of angular and rounded fragments created during the process of intrusion of igneous masses into pre-existing rocks.

**intrusive igneous**; molten matter or magma, which intruded into fissures in the Earth's crust.

**intrusive mountain**; another term for batholith.

**intrusive rocks**; rocks formed from magma beneath the surface of the Earth. Also called plutonic rock, plutonic igneous rock → Igneous rock, intrusive.

**intumescence**; the property of some minerals, when heated to form vesicular structure. Swelling or bubbling upon fusing resulting from escaping of gas upon heating.

**invelite**; a trade term for phenolic resin plastic similar to bakelite.

**Inverell**; a diamond and corundum region of Inverell, New South Wales, Australia.

**Inverell sapphire**; blue sapphire from Inverell, New South Wales, Australia.

**invernite**; a granite-like holocrystalline intrusive rock.

**inversion**; in crystallography rotation point of an object about a common center of symmetry.

**inversion**; transformation in crystalline form and structure by changing the temperature as beta quartz to alpha quartz at 575 C. Also called transformation.

**inversion**; forming of an inverted pattern with an optical system.

**inversion axis**; rotation axis in a crystal.

**inversion center**; same as center of symmetry.

**inversion point**; a change in the internal structure of a mineral at a given temperature.

**invertebrate**; any animal without backbones such as mollusks, anthropods, and coelenterates.

**inverted population level**; a term applied to one of the four-level laser. A simulated emission to produce a beam of laser light, which lies between long-lived metastable and lower, shorter-lived terminal level. In this state there are more units waiting to emit laser light transition. The four-level laser is metastable level, long-lived metastable, shorter-lived terminal level, and inverted population level. The are also four energy states with the name: absorption state level, metastable state level, terminal state level, and ground state level,

**investment value of gems**; cut gems such as diamonds, rubies, emeralds, sapphires, or pearls are often considered to be good investment.

**invisible light**; a term applied to certain radiation of electromagnetic light of short-wave or long wave, which are not visible by the human eye such as X-ray, ultraviolet, and infrared.

**iochroite**; a term applied to a violet tourmaline without boron. Also was named as jochroite.

**iodine**; a nonmetallic, grayish-black element of halogen group of the Periodic System with the symbol I.

**iodobenzene**; a liquid used in immersion and contact microscopy RI:1.62. → Immersion liquids.

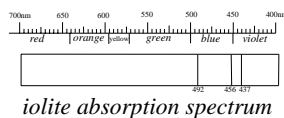
**iodoethylene**; same as tetraiodoethylene.

**iodonaphthalene (α type)**; a liquid used as contact liquid RI:1.704.

**iolanthite**; a commercial local term for banded reddish jasper from Crooked River, Oregon, USA.

**iolith**; same as iolite.

**iolite**; a transparent to translucent, light blue, dark blue to violet, sometimes yellowish gem quality of cordierite. Vitreous luster. Strong dichroism. Usually transparent stone are faceted, semitransparent are cut cabochon. Some iolite shows aventurine effect caused by flaky inclusions of hematite or



asterism owing to silky inclusions. Chemical formula:  $4[(\text{Mg}, \text{Fe}^{+2})_2\text{Al}_4 \text{Si}_5\text{O}_{18}]$ . Optics;  $\alpha$ :1.522-1.558,  $\beta$ :1.524-1.574,  $\gamma$ :1.537-1.578. Birefringence: 0.008-0.012.  $\ominus$  may  $\oplus$ . Dispersion: 0.008-0.017. Varieties

are lux-sapphire, lynx sapphire, lynx stone. Also called dichroite and it was misnomered as water sapphire. Also spelled iolith.

**iolite cut;** in variously faceted cut and cabochon be seen.

**ion;** an electrically charged atom or group of atoms caused by the gain or loss of one or more electrons. Negative charged ions known as *anions*, and positive charged ones are called *cations*.

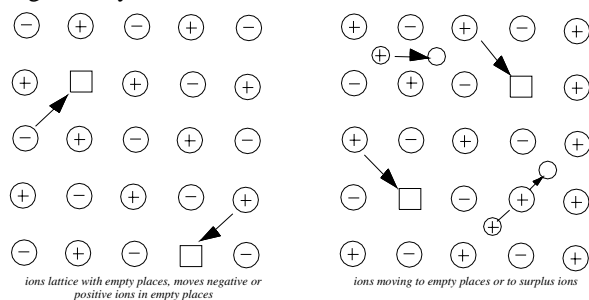
**iona stone;** serpentinous limestone or marble from Iona, Scotland.

**ion cathode;** another term for cold cathode in X-rays.

**ionic bond;** a bond results from the electrostatic attraction between ions of opposite charge in a crystal, one of which is an electron donor and the other an electron acceptor. Common salt is an ionic bond crystal and usually dissolve in solution. Also called electrovalent bond.

**ionic bond crystal;** → ionic bond.

**ionic crystal;** a lattice of crystal, which attracted together by the electric forces between ions therefore



*ions conduction in a crystal lattice*

caused the electroconductivity. → Ionic bond.

**ionic radii;** those ionic radii that determine the dimensions of ionic crystal.

**ionic substitution;** the replacement of one or more kinds of ions or atoms in a crystal structure when ions or atoms have similar size and charge. Also called proxying, diadochy, replaceability.

**ionoluminescence;** → radioluminescence.

**Ir;** a chemical symbol for the element iridium.

**Iran lapis;** → Persian lapis.

**Iran Crown Jewels;** one of the world's famous diamond and other jewels collections. Collected in Iranian treasury of the Central Bank in Teheran, Iran. Among the stones are famous diamond as Nûr-ul-Ain, Darya-i-Nûr, Hornby ?, and the Taj-e-Mah. It is said that the last Shah; Mohammed Reza Pahlavi took numerous jewels with him into exile after he was deposed in 1979. Later he sold them. Also was called Iranian Royal Treasury or Iranian Crown Jewels. Now is called National Jewel Treasury of Iran. → Peacock Throne.

**Iranian Crown Jewels;** same as Iran Crown Jewels.

**Iranian Diamonds;** among the countless number of stones are a group of 23 famous diamonds in National Jewel Treasury of Iran from 152.16 cts, to 38.18 cts, of various shapes. There are three very famous diamonds: Nûr-ul-Ain, Darya-i-Nûr, and Taj-e-Mah and see below.

**Iranian I (cape);** a, silver cape, yellow, rectangular old cut brilliant of 152.16 cts, from South Africa, belongs to the collection of the National Jewel Treasury of Iran.

**Iranian II (cape);** a silver cape, yellow, high old cushion brilliant of 135.45 cts, from South Africa, belongs to the collection of the National Jewel Treasury of Iran.

**Iranian III (cape);** a silver cape, yellow, high old cushion brilliant of 123.93 cts, from South Africa, belongs to the collection of the National Jewel Treasury of Iran.

**Iranian IV (cape);** a yellow, multifaceted octahedron brilliant of 121.90 cts, from South Africa, belongs to the collection of the National Jewel Treasury of Iran.

**Iranian V (cape);** a silver cape, yellow, high old cushion brilliant of 114.28 cts, from South Africa, belongs to the collection of the National Jewel Treasury of Iran.

**Iranian VI (cape);** a yellow, rounded triangular brilliant of 86.61 cts, from South Africa, belongs to the collection of the National Jewel Treasury of Iran.

**Iranian VII (cape);** a yellow, irregular Mogul cut brilliant of 86.28 cts, from South Africa, belongs to the collection of the National Jewel Treasury of Iran.

**Iranian VIII (cape);** a yellow, high old cushion brilliant of 78.96 cts, from South Africa, belongs to the collection of the National Jewel Treasury of Iran.

**Iranian IX (cape);** a yellow, high old cushion brilliant of 75.29 cts, from South Africa, belongs to the collection of the National Jewel Treasury of Iran.

**Iranian X (cape);** a silver cape, yellow, pendeloque brilliant off 75.00 cts, from South Africa, belongs to the collection of the National Jewel Treasury of Iran.

**Iranian XI (cape);** a silver cape, yellow, pendeloque brilliant of 75.00 cts, from South Africa, belongs to the collection of the National Jewel Treasury of Iran.

**Iranian XII (cape);** a champagne, irregular pear-shaped brilliant of 72.84 cts, from South Africa, belongs to the collection of the National Jewel Treasury of Iran.

**Iranian XIII (cape);** a yellow, rectangular old brilliant of 65.65 cts, from South Africa, belongs to the collection of the National Jewel Treasury of Iran.

**Iranian XIV (cape);** a yellow, cushion brilliant of 60.00 cts, from South Africa, belongs to the collection of the National Jewel Treasury of Iran.

**Iranian XV (cape);** a silver cape, yellow, rounded

brilliant of 57.85 cts, from South Africa, belongs to the collection of the National Jewel Treasury of Iran.

**Iranian XVI (cape);** a silver cape, yellow, cushion brilliant of 57.15 cts, from South Africa, belongs to the collection of the National Jewel Treasury of Iran.

**Iranian XVII (cape);** a silver cape, yellow, cushion brilliant of 56.19 cts, from South Africa, belongs to the collection of the National Jewel Treasury of Iran.

**Iranian XVIII (cape);** a yellow, cushion brilliant of 55.67 cts, from South Africa, belongs to the collection of the National Jewel Treasury of Iran.

**Iranian XIX;** a colorless, irregular oval Mogul cut brilliant of 54.58 cts, from India ?, belongs to the collection of the National Jewel Treasury of Iran.

**Iranian XX (cape);** a peach colored, high old cushion brilliant off 54.35 cts, from India, belongs to the collection of the National Jewel Treasury of Iran.

**Iranian XXI (cape);** a silver cape, high old cushion brilliant off 53.50 cts, from India, belongs to the collection of the National Jewel Treasury of Iran.

**Iranian XXII;** a colorless, elliptical Mogul brilliant-cut of 51.90 cts, from India ?, belongs to the collection of the National Jewel Treasury of Iran.

**Iranian XXIII;** a colorless, multifaceted trapezoid brilliant-cut of 38.18 cts, from India ?, belongs to the collection of the National Jewel Treasury of Iran.

**Iranian lapis;** → Persian lapis.

**Iranian nummulitic marbles;** same as nummulitic marble from Meshed.

**Iranian paesinite;** → paesinite, -Iranian.

**Iranian paesinite sandstone;** → paesinite sandstone from Meshed.

**Iranian Royal Treasury;** same as Iran Crown Jewels.

**Iranians;** a study of former Crown Jewels of Iran written in 1966 by V.B. Meen, and A.D. Tushingham, they detailed many diamonds and other gemstone such as 23 diamonds from I to XXIII, above.

**Iranian Treasury;** same as National Jewel Treasury of Iran.

**Iranian turquoise;** → Persian turquoise.

**Iran turquoise;** → Persian turquoise.

**iridescence;** the exhibition of prismatic colors with the play of the soft rainbow colors in some gemstones caused by interference of light beneath the surface or layers of different refractive index of the stone as seen in the corundum.

**iridescence;** a thin film air-filled stone such as in precious opal, the iridescence effect is caused by cleavage, cracks as in *rainbow quartz*.

**iridescence;** an ultramicroscopic spheres of cristobalite or silica (150-400 nm) within precious opal, which caused interference of light.

**iridescence of pearls;** iridescence of natural pearls

caused by diffraction of light from translucent outer layers of pearls. When the translucent increases and has greater iridescence, by less translucent decreased the iridescence, such pearls are white and known as *chalky*.

**iridescent cat's-eye;** a misleading term sometimes given to the chrysoberyl cat's-eye to distinguish it from other cat's-eye minerals.

**iridescent glass;** glass with the iridescent effects.

**iridescent marble;** some marble exhibiting iridescence effect because containing shells.

**iridescence of glass;** some old buried glasses often showing iridescence derived from interference because of thin surface layer create from the attack of water, which made hydration and also bleached surface of glass. This effect used to produce iridescence glassware with thin film layers to the surface with the name lusterware first made by Tiffany Co. New York, USA.

**iridescence of grossular-garnet;** in some grossular the cause of iridescence is due to different compositions within the lamellae. In iron-rich lamellae  $An_{92}Ge_7Sp_1$ , while the iron-poor lamellae were  $An_{88}Ge_{10}Sp_2$ .

**iridescent quartz;** → iris quartz.

**iridic gold;** an alloy made of gold (62.1%), iridium (30.4%), platinum (3.8%), and silver (2.1%).

**iridio-platinum;** an alloy made of platinum 90% and the remaining of 10 percentage is iridium.

**iridium;** a silvery-white, brittle, hard, metallic element, corrosion resistant of the Periodic System with the symbol Ir. SG:22.4. Used in alloys with platinum in jewelry. *Hard platinum* has 10% iridium and *medium hard platinum* contain 5% iridium.

**irididium aurate;** aurate of iridium. → Iridic gold.

**iridosmine;** → osmiridium.

**iris;** a transparent rock crystal with rainbow effect caused by fractures or artificially produced fractures in quartz by suddenly cooling a heated crystal. Also known as iridescent quartz.

**iris;** a mechanical device of a microscope that controls the amount of light.

**iris agate;** a variety of banded agate, in which the very thin concentric layers are so close that in transmitted light displays iridescence. When cut in thin slices and polished on both sides the structures contain elements, which acted like a diffraction grating. Also called rainbow agate.

**iris diamond;** a misleading term for an artificially coated diamond with iridescence effect, which increases the dispersion of stone.

**iris of eye;** a pigmented diaphragm part of eye, which controlled the size of the pupil to determine the amount of entering light reaching the retina. → Eye.

**iris opal;** a variety of water opal or hyalite from Mexico

with the play of colors, which is caused by interference on very small spheres of silica or cristobalites (150-400 nm).

**iris opal;** a misleading term for a variety of transparent brown natural glass with iridescence effect, found in San Luis, Mexico. → Iridescence.

**iris quartz;** a rainbow quartz containing thinly air-filled cracks, which produce rainbow colors by interference of light at the thin layers of air. Also called rainbow quartz.

**Irish black marble;** a variety of black marble (same as Noir Belge or Noir Français) found in County Carlow, Eire. → Kilkenny black fossil marble.

**Irish diamond;** a misleading term for transparent or nearly transparent quartz that is very pale colored or colorless from Ireland.

**Irish green marble;** a serpentinous green marble from County Galway, Eire. Also known as Connemara marble.

**Irish pearls;** a natural fresh-water pearl from the river Conway in north Wales and some other streams in Ireland.

**Irktusk;** water worn boulders of nephrite found in rivers south of Irktusk, the Russian Federation, CIS.

**iron;** a heavy, silver-white, metallic element responsible for color in minerals of the Periodic System with the symbol Fe. It has been used for making some jewelry.

**iron-aluminum garnet;** synonym for almandine.

**iron alum;** a term applied to a double sulfate of iron and potassium, which is known as halotrichite. Not to be confused with mountain butter. Also called alum feather, feather alum, butter rock.

**iron andradite;** an iron-rich variety of andradite from Scotland and India.

**iron carbonate;** synonym for siderite.

**iron chlorite;** an iron-rich variety of chlorite.

**iron coloration;** → iron influence on color.

**iron cordierite;** an iron rich, violet variety of cordierite, in which magnesium is replaced by ferrous iron. Also known as sekaninaite

**iron flint;** brown or red varieties of iron-rich chalcedony.

**iron glance;** a variety of hematite. Synonym of specular hematite.

**iron hat;** same as capping of gossan.

**iron hypersthene;** an iron-rich variety of hypersthene ( $(\text{Fe}, \text{Mg})_2(\text{Si}_2\text{O}_6)$  with 42% FeO.

**iron influence on color;** iron is one of the eight metallic elements mainly responsible for color in minerals. There are two types of iron-oxides and specters: one, in which the ferrous iron is divalent, and those, in which the element is trivalent. The caused colors are shades of red, green, inky blue, and blue.

**iron jack;** a flinty rock from Missouri, USA.

**iron meteorite;** same as siderite. → Widmanstätten pattern.

**iron mica;** micaceous variety of hematite.

**iron mica;** same as lepidomelane

**iron mineral;** any mineral, which is composed of iron oxides such as hematite, magnetite, limonite, siderite, chamosite, micaceous hematite, ilmenite, greenolite, and laterite. → Iron ores.

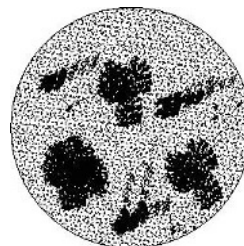
**iron monticellite;** an iron-rich variety of monticellite.

**iron-olivine;** same as fayalite.

**iron opal;** a semitranslucent red or yellow jasper opal. Also called jaspopal.

**iron ores;** rocks or deposits containing iron-oxide or iron-carbonate in commercially amounts. → Iron mineral.

**iron oxides skeleton as inclusions in emerald;** in emeralds from Austria seen some iron oxide skeleton



*skeleton  
inclusions of  
iron-oxide in  
emerald from  
Austria*

inclusions similar to dendritic aggregates.

**iron pyrites;** a misleading popular term for pyrite, or marcasite. Also called fool's gold mundic, common pyrite.

**iron rhodonite;** synonym for pyromanganite.

**iron roses;** crystal habit of hematite or ilmenite where crystal aggregates of platy radiate from a center in a rose-like form.

**iron saffron;** same as Indian red.

**iron sand;** a term applied to a sand which containing fragments of iron ore.

**iron sandstone;** same as ferruginous sandstone.

**iron silicate;** any minerals containing silicate such as hypersthene, diopside, augite, bronzite, and crocidolite.

**iron spar;** same as siderite.

**iron spectrum;** spectrum bands of iron are mostly in the blue and violet range and are also formed in brown to green range. The divalent ferrous iron ( $\text{FeO}$ ) caused red, green or blue color stones and trivalent ferric iron ( $\text{Fe}_2\text{O}_3$ ) caused yellow blue to green stones. Divalent and trivalent iron oxides having two different spectrums, the first often replaces magnesia with green and blue spectrum such as peridot, true blue spinel, almandine garnet, etc. The second mentioned iron oxide replaces aluminum and has shorter wavelength and absorption spectra in the blue-green at 450 nm, such as aquamarine, chrysoberyl, blue sapphire, etc.

**iron spinel;** same as hercynite.

**ironstone;** any minerals contain a high percentage of iron-compositions, from which usually the metal may be smelted.

**ironstone noodle;** same as ironstone opal noodle.

**ironstone opal;** any opal containing some percentage of iron-compositions.

**ironstone opal noodle;** a term used by Australian miners for hard pebbles of ironstone similar to nobbies to a beginner. Also called ironstone noodle. Also called glass iridescence. iridescence of glass

**iron-stony meteorite;** → stony iron meteorite.

**iron vitriol;** same as melanterite.

**irony ore;** same as iron ore.

**irradiate;** those minerals or rocks expose to radiation.

**irradiated black diamond;** artificial very dark-green diamond colored by irradiation with atomic particles or gamma rays, such a diamond appears black. The bodycolor is visible only when light is passed through a thin edge for sample girdle or culet. Irradiated black diamond remains radioactive. → Irradiation of diamond, irradiation for color change.

**irradiated blue diamond;** colorless, light brown, or pale yellow color diamond, which has been artificially changed to blue-green color by treating with high energy electrons from linear accelerator. Irradiated blue diamonds do not conduct electricity, but natural blue (Type IIb) diamonds are usually conductive. → Blue diamond, colored diamond, irradiation of diamond.

**irradiated brown diamond;** annealed diamond altered its color from green of reactor-treated to yellow orange, or brown range by heat treating. → Black diamond, colored diamond, fancy colored diamond, irradiation of diamond, cyclotroned diamonds, irradiation for color change.

**irradiated diamond;** → irradiation of diamond.

**irradiated green diamond;** artificial green diamond colored by irradiation with atomic particles or gamma rays. → Brown diamond, colored diamond, irradiation of diamond, cyclotroned diamonds, irradiation for color change, fancy colored diamond, irradiation for color change.

**irradiated orange-yellow diamond;** annealed diamond altered its color from green of reactor-treated to yellow orange, or brown range by heat treating. → Black diamond, colored diamond, fancy colored diamond, irradiation of diamond, cyclotroned diamonds, irradiation for color change.

**irradiated pearl;** some pearls change their colors, when they are irradiated by negative charged electrons, alpha particles, neutrons or gamma rays, such as cultured pearl, which turned its color from yellow cream to gray or black.

**irradiated pink diamond;** annealed diamond altered its color from green of reactor-treated to pink by heat treating. Irradiated pink diamond may exhibit absorption lines at 594, 619, 637, and 575 nm fluorescent line. Often the color of fluorescence is orange under long wave ultraviolet rays. → Green diamond, colored diamond, fancy colored diamond, irradiation of diamond, cyclotroned diamonds, irradiation for color change.

**irradiated yellow diamond;** annealed diamond altered its color from green of reactor-treated to yellow orange, or brown range by heat treating. → Brown diamond, colored diamond, fancy colored diamond, irradiation of diamond, cyclotroned diamonds, irradiation for color change.

**irradiation;** the process of exposing certain diamond or other pale or poorly colored gemstone to radiation, such as in a nuclear reactor, X-rays, neutrons from an atomic pile, deuterons a nucleus of the heavy hydrogen atom, gamma rays from a cobalt-60, electrons positive or negative from a linear accelerator or a cyclotron, protons a particle in the core of all atoms from cyclotron. With the effect of artificially altering the color by artificially creating color centers due to crystal defect in the space lattice. Green irradiated diamond often changes the color to yellow or cinnamon brown for some hours by heat-treatment.

**irradiation for color change;** the color of some gemstones is caused by irradiation. When the stone is exposed to a radioactive substance, or treated in a nuclear reactor.

**irradiation of beryl;** some colorless to yellow, blue to dark blue, pale lilac, and green beryl minerals will be exposed to radiation for color improving.

**irradiation of diamond;** artificially altering the color of diamonds by bombardment with fast atomic particles or gamma rays in a nuclear reactor, cyclotron, or linear accelerator to improve the appearance of stones. When diamond is radiated turned its color to green and this turned the color often to yellow or cinnamon brown for some hours by heat-treatment. Treated diamond and stones show certain absorption lines in their spectra, which do not exist before treatment hence these spectra used to distinguished from them unprepared stones. Good trade practice dictates that irradiated gemstone or diamonds of any kind be disclosed to a buyer. Also called irradiated diamond. → Cyclotroned diamonds, diamond radium treated, diamond neutrons, diamond pile treated, diamond radium treated, diamond artificial coloration.

**irradiation of topaz;** color change observed in topaz due to irradiation, which can be seen in the below table:

**irradiation stains;** a natural discoloration of brown or green on the surface, or skin, of a rough diamond. Such diamonds has been exposed to radiation during formation. Irradiation stains are often seen near natural stones and rarely penetrates deep into the stone.

**irregulars;** minerals without symmetry or exterior form. Same as broken. → Irregulars and shapes.

**irregulars and shapes;** a grading name used at the mines for diamonds of irregular shape of crystal particles of minerals or diamonds. It comes before cleavage and after goods. Also called irregulars.

**irregular crystal;** crystals without recognizable exterior form.

**irreversible;** a process which travels in one direction.

**irreversible thermochromic;** a phenomenon in which the turn of color indicate highest thermometer in the system by which a substance has been exposed to air such as cobalt pentaamine chlorodichloride  $[\text{Co}(\text{NH}_3)_5\text{Cl}]\text{Cl}$ . This component convert from purple at room temperature to violet at 120°C, to turquoise at 170°C and to black up to 230°C. The color of highest temperature retain (no return), after cooled back to room temperature. This compounds are designate into temperature indicating crayons and paints. → Reversible thermochromic.

**irreversibility;** does not return to the ancestral condition, or a process, which travels in one direction.

**Isabella Diamond;** a pendant cut diamond of 65/8 cts, belonged to Queen Isabella of Spain.

**Isabella Queen of England;** the wife of King Richard II of England, he gave her a number of jewels presents such as a collar diamonds, pearls, and rubies.

**ISCC;** an acronym for Inter Society Color Council in USA.

**iserine;** a blackish variety of ilmenite with high metallic luster found in Iserwiese, Bohemia, the Czech Republic. SG:4.50-5.20. H:5½-6. Used as substitute for hematite. Also called iserite.

**iserite;** same as iserine.

**ishkyldite;** a term for basic variety of chrysotile-δ.

**Isidore of Seville Etymologiae;** → lapidary.

**isinglass;** an old term for mica, specially muscovite.

**Isis, Holy;** an ancient Egyptian mythological fertility goddess, generally depicted as a woman with a cow's horns between the horns a disc of sun can be seen, she was the wife and sister of Osiris and the mother of Horus. Several gems, minerals, rocks, and other material are carved as Isis or the image of her is engraved at bottom of other gem pieces.

**Isle of Wight diamonds;** a misleading term for fine clearly variety of quartz from England.

**Isle Royal greenstone;** same as chlorastrolite.

**iso;** a prefix: equal.

**ISO;** an acronym for International Standard Organization, Headquarters for this society are located at: 1 Rue de Varembé Geneva, Switzerland.

**isoamyl acetate;** same as amyl acetate.

**isochemical;** having the same chemical compound.

**isochemical metamorphism;** in petrology a metamorphic processes, in which no import material from other external origin takes place. Also called treptomorphism.

**isochore;** in chemistry a line connecting points of a constant volume such as in P-V-T phase diagram.

**isochromatic;** processing the same color or tint.

**isochromatic;** in optics having the same lines of color of interference figure, which can be seen by biaxial crystals.

**isochromatic curve;** in crystal optics an effect of biaxial and uniaxial minerals, in which a band of colored circle indicated the emergence of those composition of light equal path difference. → Isochome.

**isocon;** a line indicating equal concentration.

**isodesmic;** ionic bonding of equal strength.

**isodiametric;** having lateral axes of equal length in hexagonal and tetragonal system.

**isoelectronic;** in chemistry those transition elements have the same number of electrons in the d-shell. In this constituent the strength of the ligand field increase in the octahedral oxygen coordination with the valence of central metal such as  $\text{V}^{\text{II}}$ ,  $\text{Cr}^{\text{III}}$  and  $\text{Mn}^{\text{IV}}$ , with the eV-value 1.7, 2.2, and 3.0. By the same coordination number ligand field increased with different valence as in the elements  $\text{Cr}^{\text{II}}$  have the same number of electrons in the d-shell, in octahedral eV-value is 1.1, while  $\text{C}^{\text{III}}$  is 2.0, which is called *octahedral cobalt*. In *tetrahedral cobalt* coordination is the same but the  $\text{Cr}^{\text{II}}$  have a ligand field eV-value of 0.5, while  $\text{C}^{\text{III}}$  is 0.9.

**isoflex;** a trade term for a variety of bexoid or cellulose acetate plastics, which are used for imitation of amber, turquoise, ivory, tortoise shell, etc.

**isolated silicates;** → nesosilicates.

**iso-geometry;** having the similar shape.

**isogyre;** a black brush-like area of an interference figure of double-refractive crystal, in which the polarization of light passing through and from a black cross-seen under microscope.

**isometric;** same as cubic system. Also called isometric system, isometric crystal system.

**isometric crystal;** → isometric, cubic system.

**isometric crystal system;** → isometric, cubic system.

**isometric mineral;** crystal, mineral or stone of cubic system.

**isometric stone;** → isometric mineral.

**isometric system;** → cubic system.

**isomorphic;** having similar or identical form, structure.

→ Isomorphism.

**isomorphic replacement;** replacement of one element in a chemical composition or mineral by another element of the same valence in the chemical composition of a mineral by retain the structure, form of the crystal and properties as in garnet or feldspar group. Also called isomorphous replacement.

**isomorphism;** the characteristic of crystals, when they have similar crystal structure and similar external forms but variable chemical proportions as in garnet group. Also being able to form a series of solid solutions. Also called allomerism.

**isomorphous;** of isomorphism.

**isomorphous replacement;** → isomorphic replacement.

**isomorphous substitution;** a term used also for solid solution.

**isoprene units;** a kind of hydrocarbon compound of (C<sub>5</sub>H<sub>8</sub>) which is found in amber, natural resins, waxes and in some living plants. Isoprene units link together to forming complex of organic compound, which is known as terpenoid.

**isopyre;** an impure opal from St. Just, Cornwall, England. → Isomorphic replacement.

**isothermal;** a process of changing the thermodynamic state of a crystal, pressure and volume with constant temperature. Occurring of a mineral at constant temperature.

**isothermal piezoelectric;** change of piezoelectric properties of a mineral at constant temperature.

**isothermal pyroelectric;** change of pyroelectric properties of a mineral at decreasing of temperature and increasing of pyroelectric effect.

**isostructural;** having the same crystal structure with the same arrangement of atoms, but with little tendency for isomorphous substitution.

**isostructural groups;** minerals having the same crystal structure with the same arrangement of atoms such as garnet or spinel group.

**isotope;** a member of the same chemical-element family but having two or more different atomic weights and nuclear properties. These dissimilarities are caused by different numbers of neutrons, while the number of protons are the same in the atomic nucleus. As carbon 12 (<sup>6</sup>C<sub>12</sub>), carbon 13 (<sup>6</sup>C<sub>13</sub>), and carbon 14 (<sup>6</sup>C<sub>14</sub>) are isotrops of element carbon.

**isotopic age;** radiometric age, absolute age. → Isotope.

**isotropic;** in crystallography the light or rays travel with the same speed in any direction. All cubic and amorphous minerals are isotropic and have the same optical properties in all directions, which are known as singly refractive.

**isotropic;** crystals, which have single refractive index such as cubic system or amorphous materials.

**isotropic;** minerals or gemstones crystallized in cubic system.

**isotropic;** any amorphous materials.

**isotropic media;** → isotropic materials.

**isotropic materials;** any substance, which crystallized in cubic system or amorphous materials such as paste (glass), resins (amber), and gel (opal).

**isotropic zircon;** → amorphous zircon.

**isotropy;** material with same properties in any directions.

**isotypic;** crystalline substances that have similar structures and analogous chemical compositions, such as galena and NaBr or zircon and xenotime.

**Istrian stone;** a variety of marble near Trieste, Italy.

**Istituto Gemmologico Italiano;** (Italian Gemmological Institute); Headquarters for this society are located at Viale Gramsci 228, 1-20099 Sesto S. Giovanni, Milano, Italy.

**ita;** Japanese term for gold-washing board.

**itabirite;** a term applied to specular iron ore.

**itabirite;** banded quartz-hematite.

**itacolumite;** a fine-grained micaceous sedimentary sand-stone or schistose quartzite (metamorphic), which is slightly flexible in thin slabs, owing to a ball-sand-socket arrangement of loosely interlocking grains of mica, chlorite, talc, and cement. Found in Itacolumi Mountain, Brazil. Articulite is an obsolete term this rock.

**Itacolumy series of rocks;** a rock series in Itacolumy, Brazil, which is crossed by pegmatite and dikes and intrusions of altered rock, which is overlaid by lavas series that consist of conglomerates, phyllites, and sandstones, in which diamond are found.

**Italian;** a classification of coral, it means good-quality in all shades ranges from white to red.

**Italian asbestos;** a term applied to tremolite asbestos to distinguish it from chrysolite asbestos.

**Italian chrysolite;** a misleading term for idocrase.

**Italian Gemmological Institute;** → Istituto Gemmologico Italiano.

**Italian Gem Treasury;** enormous gem collection in Vatican Museum, Roma, such as Crown of King Agilulf, Great Southern Cross Pearls, etc.

**Italian lapis;** a misleading term for artificial stained jasper. → Swiss lapis, German lapis.

**Italian pink;** same as Dutch pink.

**itatli;** Aztec term for obsidian.

**Ituiutaba Diamond;** a diamond of 105 cts, found in 1940 in Ituiutaba Mines, Minas-Gerais, Brazil.

**Ituiutaba Mines;** a diamond bearing district in Ituiutaba-Mines, Minas-Gerais, Brazil.

**ivorine;** an artificial plastic used as ivory simulant.

**ivorite;** a black tektite found in Ivory Coast, western



Africa.

**ivory**; a translucent to opaque, hard, fine-grained, white to creamy-white, organic substance from the tusk of elephant, hippopotamus, hog, sperm whale, narwhal, walrus, mammoth and frequently fossil ivory. But the name *ivory* refers only to elephant ivory. RI:1.535. SG:1.70-1.85. H:2½-2¾. The color varies from white to yellow to brownish tinge. Different ivories exhibit



*elephant ivory*

different colors under ultraviolet light. Elephant ivory obtained from male and female elephants, from Africa *Elephas africanus*, and South East Asia *Elephas maximus* (in Asia only male elephant has tusks), which is also called *Indian elephant*. The tusks of elephants have fine longitudinal canals containing gelatinous material, which provides the polish effects. *Bastard ivory* is an intermediate type and soft ivory comes from Thailand. Thin sections of elephant ivory under microscope show *wave-like* canals and undulating fibers across the field. Ivory is used without preparation for a wide variety of ornamental objects, beads, finger rings, netsuke, brooches, etc., carved, polished, smooth, and as inlay. Brush holders made from ivory tasks in China are called *pei-tung*. Ivory can be dyed in white bright colors, mostly in Tibet. Imitation ivory is made from bone, beer-horn, seed of a variety of palm is called *vegetable ivory*, or is simulated in celluloid. Also called dentine ivory. → Ivory, corozo nut, doum palm nut, elephant ivory,

dentine ivory.

**ivory, imitation**; → imitation ivory.

**ivory carving**; in gemology working of ivory material, or a figure or design produced by carving, such as vases, statues, artistic objects, etc.

**Ivory Coast**; a formerly French colony, a part of West Africa, is a producer of alluvial diamonds. Also called Côte d'Ivoire.

**ivory cut**; ivory is seldom cut as cabochon and ovals, but found mostly as beads in necklaces and carvings.

**ivory jade**; a Chinese term for jade of particular color and texture.

**ivory, dentine**; → ivory.

**ivory palm**; the kernel of the nut of certain palm trees. Also called vegetable ivory.

**ivory palm nut**; → corozo nut.

**ivory pearls**; a misnomer for ivory beads found in tusk cavities.

**ivory porcelain**; any porcelain ware having a surface resembling the ivory.

**ivory turquoise**; a misleading term for odontolite.

**ivory, vegetable**; same as vegetable ivory.

**iztac chalchihuitl**; a white or greenish Mexican onyx. → Chalchihuitl.

**iztli**; an Aztec term for a variety of obsidian used by Mexican Indians for arrowheads, implements, mirrors, masks and later named as *teotetl* or divine stone because of its various uses.

**izoumrud**; same as izoumrud.

**izumrud**; a Persian-Soghdian term for emerald. Also spelled izoumrud.

# J j

**J** or **j**; an abbreviation for joule.

**JA**; an acronym for Jewelers of America.

**jaca**; a Brazilian term for dark-colored spots or inclusions in diamond such as dark carbon spots in Brazilian diamonds.

**jacinth**; a term applied to a transparent yellow to reddish-brown variety of zircon. Formerly was an alternate name for hyacinth, when reddish-orange.

**jacinth**; a reddish to cinnamon-colored variety of grossular (hessonite) garnet and spinel. It has been proposed that the name discarded. → Hyacinth.

**jacinto**; Spanish spelling for hyacinth.

**jack**; same as sphalerite or zinc ores.

**jackass copal**; same as Zanzibar copal.

**jacket**; same as mantle (crystal).

**Jackson tube (X-ray)**; a focus tube with concave cathode, which was constructed by Jackson in 1896 for use in X-ray studies.

**jackstraw-like**; a term applied to a group of fibrous mineral, which are heaped without any property or order such as tourmaline aggregate. Also called spillikins.

**Jacob**; same as Jacob Diamond.

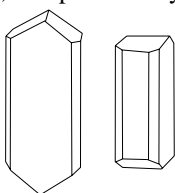
**Jacob Diamond**; reportedly a white cut, but not blue diamond of 100 cts, probably from India.

**Jacob Diamond**; same as Victoria Diamond, Imperial Diamond or Great White Diamond. → Collection of Nizam of Hyderabad. Also called Jacob.

**Jacob's Well Emerald**; a fine altarpiece in which part of the religious Holly Land scene and Jacob's Well engraved. It is made from a large emerald crystal, now on display at the Kunsthistorisches Museum, Vienna, Austria.

**jadder**; same as stonecutter.

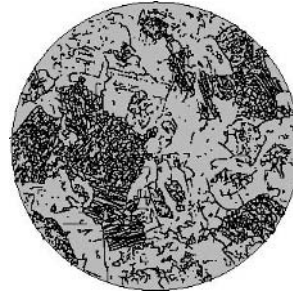
**jade**; a collective term for a hard, white, pale green, emerald-green to dark-greenstone often with white markings, compact variety of jadeite and nephrite, both resemble each other but have no relation. Both varieties can be found in any range of colors and are hard to carve. In the Far



*jadeite crystals*

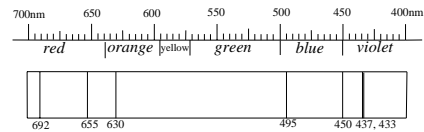
East jade was used for tools, ornaments, weapons, and

jewelry as beads, finger rings, combs, and hair needles. Many different natural minerals and artificially substances may simulate jade, also jade may be dyed with organic compositions to improve or change the



*thin section of jadeite*

color. Synonym for jadestone. Rarely called nephritoid. In Spanish called *pedra de hijada*. *Yü* is a Chinese term for jade. *Chinese jade* is a misleading term for jadeite from Myanmar. *Mutton fat jade* is a yellowish-green to



*jade absorption spectrum*

creamy buff, translucent variety of nephrite-jade with greasy luster resembling mutton fat. Bleached jadeite is commercially classified as *grade B jade* or *B jade*. *Red jade* is a misleading term for red, dyed quartzite, which is also miscalled *tourmaline*. *Hei tiki* is a Maori term for flattened alluvial jade pebbles used for ornament purposes or amulets. Flattened alluvial jade pebbles known as *mere* are found in New Zealand. Also called jadestone (in China), axestone, axe stone, water stone (an obsolete term). A synthetic jadeite was made by General Electric in USA (1984), which has very similar properties to natural jadeite, but which has rather more intense color than natural. Imitations are made from different materials, see jade imitations. → Jade identification.

**jade-albite**; an opaque, green, cryptocrystalline albite rock containing chrome-riche jadeite. RI:1.42-1.54. SG:2.46-3.15. H:6½. Found in Myanmar. Also called *maw-sit-sit* after the location. → Jade matrix.

**jade amulet**; an amulet of carved jade that was made and used in China.

**jade, California**; → California jade.

**jade, coloring**; → jadeite, coloring.

**jade cut**; mostly jade material is fashioned into carving objects, beads, or as cabochons and other small objects such as earrings, brooches, and rings. → Jade.

**jade fisher**; a Chinese term for an alluvial jade miner.

**jade glass**; a green, transparent to opaque lead-glass. SG:3.73.

**jade hammer**; → kuru jade.

**jade identification**; to distinguish jade from other substitutes, the majority use the refractive index of jadeite 1.654-1.677, specific gravity 3.32, and three step-like lines spectrum in the red at 630, 660, and 690 nm in rich-green jadeite.

**jade imitations**; many different natural minerals and artificial substances may simulate jade. They vary in luster, hardness and can be easily distinguished: chrysoberyl, grossularite, californite, idocrase, saussurite, malachite, sillimanite, chlorastrolite, smithsonite, tourmaline, prehnite, faustite, nephrite, smaragdite (a foliated variety of amphibole or diallage), verdite, fuchsite, astridite, beryl, pseudophite, variscite, serpentine and varieties such as bowenite, which are misnomered as *new jade*, chrysoprase, agalmatolite, quartz, green aventurine quartz, steatite, chalcedony, chrome chalcedony, stained chalcedony, albite, microcline, plastic, glasses, opal, fluorite, verde antique (Connemara marble), etc. A dark-green variety of antigorite serpentine used by the Maoris of New Zealand to make ornamental objects is called *tangiwaite*. *Korean jade* is a misleading term for bowenite serpentine. *Transvaal jade* is a local misnomer for compact, fine-grained green variety of grossular garnet from Transvaal, South Africa. *Amazon jade* is a misnomer applied to the bright green, laminated variety of microcline-feldspar. *Indian jade* is a misnomer for green aventurine quartz. *Imperial jade* is a fine, translucent, highly intense emerald-green variety of jadeite from Myanmar. Bleached jadeite is commercially termed as *grade B jade* or *B jade*. It has been simulated from artificial substances such as glasses and plastics, but they can be readily distinguished from jade. Many minerals and other materials have also been stained with organic compositions to enhance or change the color, but it does not penetrate and the color soon fades. An imitation of jade or ivory made from calcined beef or animal bone, which is named as *oxalite* or *oxolite*. Doublet and triplet jadeite are made and cut as cabochon.

**jade, imperial**; → imperial jade.

**jade matrix**; a rock consisting of mixture of tremolite a variety of amphibole and albite feldspar. RI:1.56. SG:2.80-2.95. Also called snowflake jade or Wyoming jade. → Jade albite.

**jade, mountain**; a nephrite-bearing mountain from Barrow region, Alaska.

**jade, mutton fat**; a misnomer for nephrite consisted of

tremolite-actinolite series.

**jade, New Zealand**; a misnomer for nephrite from New Zealand.

**jade, Soochow**; same as fine-grained bowenite

**jade spectra**; → jadeite spectrum.

**jade, synthetic**; → synthetic jadeite.

**jadestone**; same as jade.

**jade tenace**; a misleading term for green saussurite.

**jade, Transvaal**; a misnomer for massive, fine-grained grossularite (actually hydrogrossular) from Transvaal, South Africa.

**jadeite**; a rare member of pyroxene group, in which is one of the two gemstones referred to is jade. Normally found in fine-grained and massive minerals, which are suitable to cut cabochon, beads, and other objects, fine-quality jadeite is known as *jewel jade*. Varieties are *jade* in white, pale green, emerald-green is called *imperial jade* or *true jade* the Chinese term is *fei-ts'ui* for dark green, and very dark-green to black is called *chloromelanite*. Also called jade stone, Chinese jade but not found there. In 1984 a synthetic jadeite made by General Electric in USA, the properties are nearly similar to the natural jadeite but color is rather more intense than natural.

System: monoclinic.

Formula:  $4[\text{NaAlSi}_2\text{O}_6]$ . Contains trivalent iron.

Luster: subvitreous to pearly luster.

Colors: colorless, all shade of green, pink, lilac, brown, red, orange, yellow, black and white.

Streak: colorless.

Diaphaneity: transparent, translucent to opaque.

Cleavage: {110} good.

Fracture: splintery. Extremely tough.

SG: 3.30-3.36.

H:6½-7, (nephrite: 6-6½).

Optics;  $\alpha$ :1.640,  $\beta$ :1.645,  $\gamma$ :1.652.

Birefringence: 0.012-0.020. ⊕.

Found in Maw-Sit-Sit and Upper Myanmar, (Burma), Russia, Mexico, New Zealand, Japan, Guatemala, California, USA.

**jadeite**; same as Chinese jade.

**jadeite, coloring**; artificially coloring of white or gray jadeite to green color, which shows similar as *imperial jade*.

**jadeite colors in Burmese**; *kyauk ame* for green to black, *mya yay* for translucent grass green, *shewlu* for light green, *lat yay* for cloudy jadeite, *konpi* for red or brownish, *kyauk atha* for translucent white, *pan tha* for translucent white, and *yay kyauk* for translucent grass green.

**jadeite cut**; the mainly jadeite material fashioned as carving objects, beads, or as cabochons and other small objects as earrings, brooches, and rings. → Jade.

**jadeite-aegirine**; an aegirine-like pyroxene containing jadeite molecule. Found in Golling, Salzburg, Austria.

**jadeite doublet**; a true or genuine doublet where both pieces, top and bottom made from jadeite and cemented together. Usually the top layer is thin green jadeite, while bottom are made of thick paler jadeite.

**jadeite, lemon-peel surface on**; a special effect on the surface of jadeite cabochon caused by improper polishing technique, which resembles an orange or a lemon peel.

**jadeite imitations**; → jade imitations.

**jadeite-like minerals**; → jade imitations.

**jadeite luminescence**; it has pale white luminescence under LWUV. Under X-rays may exhibits intense blue-violet, light yellow and mauve color.

**jadeite-nephrite**; a mixture of both occur sometimes which is a reason for not resolving the problem jade.

**jadeite, orange-peel surface on**; a special effect on the surface of jadeite cabochon caused by improper polishing technique, which resembles an orange or a lemon peel.

**jadeite rock**; a rock consisting essentially of jadeite.

**jadeite rough**; rough material of jadeite be obtained from Myanmar, (Burma), Russia, Mexico, New Zealand, Japan, Guatemala, and California, USA.

**jadeite spectrum**; in rich-green jadeite three step-like lines spectrum in the red at 630, 660, and 690 nm can be seen. Light green jadeite shows frequently strong sharp line spectrum at 437 nm.

**jadeite staining**; → jadeite, coloring.

**jadeite rock**; same as jadeite.

**jadeite, synthetic**; → synthetic jadeite.

**jadeite triplet**; a composite translucent cabochon of jadeite cemented with an organic green substance or a jell-like dye of imperial green or a green-stained cabochon into a white hollow cabochon of the same stone, which improves the color of fine-quality jadeite (or jade). The base is closed with a third piece of jadeite. It is readily detectable because dye agent absorption spectrum occurs in the red part.

**jadeitite**; a metamorphic rock consisting almost of jadeite (a pyroxene) and occurring with small amounts of feldspar or feldspathoids.

**jadeolite**; a misleading term for deep-green chromiferous syenite rock, which resembles jade in appearance and been cut as gemstone. Found in Bhamo, Myanmar, (Burma). Also spelled jadolite.

**jadine**; a commercial misleading term for Australian chrysoprase.

**jadolite**; same as jadeolite.

**jadeologist**; a term applied to jade specialist.

**jag**; a term used for notch.

**Jagdalek ruby**; a fine quality, pinkish or raspberry-red,

strongly fluorescence ruby from Jagdalek, Afghanistan, resembling Myanmar and Sri Lankan rubies.

**Jager**; the highest classification in the color grading of diamonds, which described colorless to blue-white or over-blue diamonds with strong blue ultraviolet fluorescence. Jager has light blue bodycolor and looks pale bluish in daylight. Named after those found in the Jagersfontein mine in South Africa. Also classified as *blue-white diamond*.

**Jagersfontein**; → Jagersfontein diamond mine.

**Jagersfontein Brilliant Diamond**; → Pam Diamond.

**Jagersfontein diamond mine**; location of the third kimberlite diamond mine in Orange Free State, South Africa, which are associated with garnets. Diamonds from this mine appear faintly blue in daylight. The Jubilee Diamond, Julius Pam Diamond and Excelsior Diamond are also found in these mine. In 1971, the Jagersfontein was closed.

**Jagersfontein mine**; → Jagersfontein diamond mine.

**Jagersfontein Rough Diamond**; a rough diamond of 215 cts, found in 1881 in Jagersfontein Mine, South Africa.

**jagged fracture**; same as hackly fracture of mineral.

**jahaji**; an Indian term for a variety of emerald.

**Jahan Akbar Shah**; → Akbar Shah Diamond.

**Jahan Shah**; once Emperor of Mogul Baber Dynasty (1569-1627) who possessed the so-called Timur Ruby.

**Jahangir Diamond**; a drop-shape cut and engraved diamond of 83.03 cts, from India. It belonged to the Jahangir Shah, Emperor of Mogul Dynasty 1605-1627 and later his son Shah Jahan 1627-1658. It is believed to have been suspended from the beak of the peacock on the *Peacock Throne*. It was sold in 1954 to Greek Stavros S. Niarcos, and in 1957 sold to an Indian businessman. Also spelled Jehangir Diamond. → Jahangir Shah.

**Jahangir Shah**; an Emperor of Mogul dynasty (1605-1627) who once possessed the so-called Timur Ruby and his name is engraved on the stone.

**jai**; a French term for jet. Also spelled jai, and jayet.

**Jaipur**; a cut and merchandising city of Indian gems.

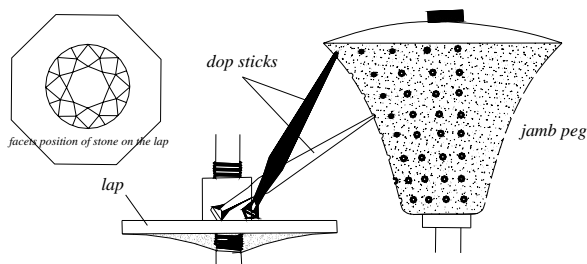
**Jaipur**; a term applied to almandine garnet of gem quality from Jaipur, India.

**jais**; → jai.

**Jakutian diamond mine**; diamond mines in region Jakutsk, East Siberia, the Russian Federation, CIS, which are found in pipes and alluvial deposits since 1954.

**Jalmeida Diamond**; a pale-yellow diamond of 109.50 cts, in the rough and 45.50 cts, after cutting. Found in 1924 in Brazil. The owner is unknown.

**jamb-peg;** an electrically faceting machine, in which a vertical rod holding a piece of hard wooden capped metal in the form of a cone, which is used by lapidary



polishing device or jamb peg

to anchor one end of the gem stick or gemstone holder, the stone touches the lap at exactly the correct angle to grind the face of facets.

**jamb-peg machine;** → jamb-peg.

**James I, King of England;** king of England, in 1604 bought the Sancy diamond.

**James II, King of England;** king of England, which he eventually sold in 1688 the Sancy diamond to king Louis XIV of France.

**jamesonite;** → feather ore.

**Japan earth;** same as ochre.

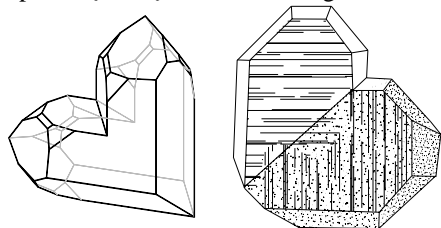
**Japanese coral;** an Italian trade classification term for corals from Japan waters, which are mottled dark red and white core. → Coral,-trade classification of.

**Japanese culture pearls;** cultured pearls, which are produced largely in Japan. The pearl-producing mollusk is the small oyster *Pinctada martensii*, about 8 cm. long. → Cultured pearls

**Japanese Gemmological Association;** → Gemmological Association of Japan, Gemmological Association of all Japan, Gemmological Society of Japan.

**Japanese jade;** a misleading term for gem quality of green prehnite.

**Japanese law;** penetration of two quartz crystal with the twin plane {1122}, re-entrant angles. 4 varieties are



Japanese law twins of quartz

possible. → Quartz.

**Japanese pearls;** any pearl from Japanese waters such as cultured or genuine.

**Japanese pearls;** a term for cultured blister pearls.

**Japan pearl;** same as Japanese pearl.

**Japan twinning;** a twinning form of quartz crystals with inclined axes. → Japanese law.

**Japanese twin law;** → Japanese law, quartz.

**jardin;** a French term for garden, applied to the typical three-phase, moss-like inclusions that are found in almost every emerald. → Garden.

**Jardin de Plantes, Paris;** mineral and gemstones collection in the Jardin de Plantes, Paris, contains two rough fine-quality sapphires: the one is a brownish color, which is known as Rospoli of 135 cts, and the other is 5 x 3.8 cm.

**jargon;** a natural yellowish colored low quality diamond.

**jargon;** → Jargoon.

**jargon de Ceylon;** jargoon from Sri Lanka.

**jargoon;** a commercial term for colorless, pale yellow, yellow, smoky-colored gem quality of zircon from Sri Lanka, usually as a result of heat-treatment. Used as imitation diamond. Also spelled jargon. A Persian term for gold colored. Also called cerkonier, hyacinth of Ceylon, Ceylon hyacinth.

**jarra gem;** a commercial term for synthetic rutile used as diamond imitation.

**jaspachate;** → jaspagate.

**jaspagate;** a microcrystalline, translucent, alternation silica stone that is midway between jasper and agate or chalcedony and agate. Also spelled agate jasper and called jaspe fleuri or jasper fleuri and sometimes spelled jaspachate. → Jasponyx.

**jaspe;** a French or Spanish term for jasper.

**jaspe fleuri;** an old and misleading term for jaspagate.

**jasper;** a dense, fine crystalline, translucent to opaque, red, brown, yellow, green, grayish-blue, lavender, and brown, normally spotted or banded of impure variety of chalcedony or chert. Banded jasper is planar rather than concentric as agate. Dull to greasy luster. Fracture is uneven and angular. The various colors are caused by impurities of iron oxides. Hematite is responsible for red color and goethite for yellow to brown color. If contains clay it becomes white yellowish color and had a porcelainous appearance. The varieties are *ribbon-jasper*, which appear similar agate in stripes bands or zones, *Egyptian jasper* or *orbicular jasper*. The blue variety is called *porcelain jasper*. Jasper is frequently found as patches in other stones that are called *Blood stone* or *jasper agate*. Irregular inclusions frequently create the impression of *picture jasper* or *scenic jasper*, *trees jasper* such as ocean wave, etc. Found in Utah, and Wyoming, USA, may be it is a jasperized rhyolite. Often the porous chalcedony or jaspers are stained blue to imitate lapis lazuli and sold incorrectly as German lapis, or Swiss lapis. Also called jasperite, jaspis,

jasperoid. The difference between jasper, chalcedony and agate is based upon the transparency of light. Jasper is an opaque variety, when the stone is translucent named as chalcedony, those translucent and bright colored stones are known as agate. A fine-grained, compact, velvet-black variety of chert into jasper, or flint named as *Lydian stone*, which are also called basanite, lydite, and touchstone. Novaculite, and hornstone are translucent varieties of jasper. An opaque, banded microcrystalline of stone that is midway between onyx and jasper or chalcedony is known as *jasponyx*, ribbon jasper, striped jasper or banded jasper. *Jaspilite*, a banded variety of jasper occurs as metamorphic rock, which is alternated with hematite. RI  $\approx$  1.54. SG:2.58-2.90. Hardness near quartz. Used as ornaments, beads, cut cabochon, buttons, brooches and to simulate cameo. Found also in Uralian, Russia.  $\rightarrow$  Quartz, chert.

**jasper**; a name used for a translucent, fine grained, hard, unglazed stoneware developed in 1775 by Wedgwood. The surface can be stained with different metallic oxides for several colors. Used as beads, buttons, brooches and to simulate cameo.

**jasper agate**; agate with alternating bands of jasper. Also known as agate jasper.  $\rightarrow$  Jasper.

**jasper, banded**;  $\rightarrow$  banded jasper, jasper.

**jasper bar**;  $\rightarrow$  jaspilite.

**jasper, brecciated**;  $\rightarrow$  brecciated jasper.

**jasper, chalcedony**;  $\rightarrow$  chalcedony.

**jasper, Egyptian**;  $\rightarrow$  Egyptian jasper, jasper.

**jasper fleuri**; same as jasper fleuri.

**jasper jade**; a misleading Chinese term applied to simulations of jade such as green quartz such as jasper.

**jasper jade**; a misleading Chinese term for serpentine.

**jasper jade**; a mixture midway of quartz and jade.

**jasper jade**; a misleading term applied to green quartz, jasper or chalcedony such as jasper, found in Oregon, the USA. Also called Oregon-jade.

**jasper, name of**; a term derived from Assyrian term Ashapu, or from Hebrew term Iashpeh, for jasper.

**jasper opal**; an almost opaque, red, yellow, reddish-yellow, or yellow-brown variety of common opal consisting of iron oxides and other impurities, resembling jasper. Also called opal jasper, jaspopal.

**jasper, orbicular**;  $\rightarrow$  orbicular jasper.

**jasper, picture**;  $\rightarrow$  picture jasper, jasper.

**jasper, ribbon**; a variety of banded jasper, in which the colors of the stone run in strips. Also called banded jasper, jasponyx.

**jasper rough**;  $\rightarrow$  jasper.

**jasper sanguine**; a French term for black jasper.

**jasper stained**; dyed jasper is used as turquoise and lapis lazuli simulant (Swiss lapis or German lapis).  $\rightarrow$

Jasper.

**jasperated**; mixed with jasper or a product resembled jasper such as jasperated agate or jasperated glass.

**jasperated agate**; same as jaspagate.

**jasperated glass**; a vitreous, opaque, colored product resembling jasper.

**jasperine**; the term applied to banded various colored jasper.

**jasperite**;  $\rightarrow$  jasper.

**jasperize**; to change into or cause to resemble a form of jasper.

**jasperization**; the alteration or conversion of igneous or sedimentary rocks, into banded jaspilite-like rocks by metamorphic (metasomatic) process of iron oxides and fine-crystalline silica.

**jasperized rhyolite**; a rock with irregular inclusions, which frequently creates the impression of *picture jasper* or *scenic jasper*, *trees jasper* such as ocean wave, etc. Found in Oregon, Utah, and Wyoming, USA.

**jasperized wood**; jasper pseudomorph after wood or a variety of silicified wood, which resemble any jasper. The most famous locality is from Arizona petrified forest, USA.

**jasperoid**; a rock consisting usually of cryptocrystalline, gray, chert-like, chalcedonic or silica, which has developed as the gangue of metasomatic process of some other material, usually carbonate minerals of limestone or dolomite. A silicified limestone.

**jasperoid**; sometimes used for jasper or resembling jasper.

**jasper ware**; a vitreous, opaque unglazed ceramic ware white or constructed relief decorations.

**jasper with colorless spherulites**; same as bird's-eye quartz.

**jaspery**; like jasper. Resembling or containing jasper. Also called jaspidean, or jaspideous.

**jaspery iron ore**; a mixture of hematite with a jasper fracture.

**jaspidean**; same as jaspery.

**jaspideous**; same as jaspery.

**jaspillite**; a compact, alternately banded, ferruginous variety of jasper occurs as metamorphic rock alternated with hematite. Also called jasper bar and spelled jaspilyte.

**jaspilyte**;  $\rightarrow$  jaspillite.

**jaspis**; a German term for jasper or jasperoid.

**jaspis terebinthizusa**; in Roman times various colored composite stone were cemented together with Venice turpentine.

**jaspoid**; like jasper. Resembling jasper.

**jaspoid**; same as tachylite.

**jaspopal**;  $\rightarrow$  jasper opal, opal jasper.

**jasponyx**; an opaque, banded microcrystalline stone that is midway between onyx and jasper or chalcedony. Also called ribbon jasper, banded jasper. → Jaspagate.

**jaspure**; dyed marble, which is used as jasper imitation.

**Jathara**; an Indian term for emerald, which has an ugly appearance leads one liable to bites. → Emerald colors and superstitious in Indian.

**jaulingite**; a succinite resembled resin from Jauling, Austria.

**java gem**; a commercial term for synthetic rutile used as a diamond simulant.

**Java (natural glass)**; → javaite.

**java onyx**; a dull stalagmitic, waxy banded marble, white in color or variegated with amber-like colored mass. Found in Kediri, Java.

**javaite**; a number of button-shaped, small pieces of natural glass has been found in Java, Indonesia. Also called javanite. → Tektite.

**javanite**; → javaite.

**jaw crusher**; an instrument used to crush mineral ores, rocks, etc.

**jayet**; → jai.

**Jeanne d'Evreux Emerald**; → Queen Jeanne d'Evreux Emerald.

**jeaters**; an old miners term used in England for jet.

**Jebel Zabarah mines**; an ancient Egypt emerald mine from Jebel Zabarah in Upper Egyptian in referring to papyrus.

**jeffersonite**; a dark-green to greenish-black of manganese and zinc-bearing mineral of the clinopyroxene group. Found in New Jersey, USA.

**Jefferson Sapphire**; a rough, dark blue sapphire of 1,743 cts, from Anakie, Queensland, Australia. Was carved into a bust of former US President Thomas Jefferson, after carving weighs 1,381 cts. This stone, together with those of Presidents Lincoln, Washington, Eisenhower and the Black Star of Queensland, were presented as a gift to the American people in 1957 by the Kazanjian Foundation of Pasadena, California. It is presently on display at the Smithsonian Institution, Washington, D.C., USA. → Washington Sapphire, Eisenhower Sapphire, Lincoln Sapphire, and Black star of Queensland.

**jeqa**; a Farsi (Iranian) term for an ornament, or piece of jewelry or crest with which a wrestler or champion is adorned. Also spelled jiga, gika, jiqqa. Same as aigrette.

**Jehan, Shah**; → Shah Jehan.

**Jehangir Diamond**; → Jahangir Diamond.

**jelinite**; another term for a fossil resin named kansasite.

**jell**; to become a clear, colloidal aggregate or semi-solid or jellylike, used as colorless or colored cement in assembled stones. Also called gel, jell, jells, gels, jelling, gelling, gelled. → Gel.

**jellette**; → jelletite.

**jelletite**; a term applied to a green variety of andradite garnet. Also spelled jelletite.

**jells**; → jell.

**jelly**; a structureless, colloidal, semisolid mass or compound.

**jelly**; → jelly opal.

**jelly opal**; an inferior, almost transparent variety of opal with whitish body color. When held against the light, been to see that cracks penetrate the structure. Also called jelly, light opal, light.

**jeremejevite**; a rarely used gem mineral resembling aquamarine. Also called eremeyevite.

System: hexagonalic.

Formula:  $2[Al_6B_5O_{15}(F,OH)_3]$ .

Luster: vitreous.

Colors: colorless, pale blue, pale yellowish-brown, and cornflower blue.

Streak: colorless.

Diaphaneity: transparent to translucent.

Cleavage: none.

Fracture: conchoidal to uneven.

SG: 3.28-3.29.

H:  $6\frac{1}{2}$ - $7\frac{1}{2}$ .

Optics;  $\omega$ : 1.649-1.653,  $\epsilon$ : 1.637-1.644.

Birefringence: 0.011.  $\ominus$ .

Found in Cape Cross, (Namibia), Pamir Mountain and East Siberia, the Russian Federation, CIS.

**jeremejevite absorption spectrum**;

**jeremejevite pleochroism**; pleochroitic: pale cornflower-blue, colorless and pale yellow.

**jet**; a compact, homogeneous, hard, glossy surface and black interior variety of fossilized lignite or coal. Used as carved and engraved articles as seal, beads, buttons and finger ring or faceted. Also used as a mourning jewelry, have been used as mirror in medieval time and suitable for craving. Jet is warm to the touch, light in weight, induces electricity when rubbed on wool or silk. It burns readily with a sooty blue flame. Imitations are black tourmaline (schorl), black andradite (melanite), black zircon, albertite, Kimmeridge shale, bog oak, horn, lignite, shale, vulcanite a hardened rubber, black-dyed chalcedony is called *black onyx*. Other jet imitations are made of glasses, and obsidians. A type of black glass material is known as *Paris jet*. It can be distinguished from other black stone or material simulants by touching its surface with a heated needle, which releases an odor of coal, or when it is rubbed, it gives off a strong odor. Misnomerly called black amber or referred ad black turquoise. Sometimes applied to a black marble. Also called scorpion stone, jet coal, gagate, agstein. Also spelled jett. → Cannel coal, jet names.

System: amorphous.

Formula: C. Major impurities are oxygen 12.5%, hydrogen 7%, sulfur 4.6% and nitrogen 0.7%. Similar to brown coal or lignite.

Luster: dull, and vitreous after polishing.

Colors: velvet black to dark brown.

Streak: same as color.

Diaphaneity: opaque.

Cleavage: none.

Fracture: conchoidal to uneven. Brittle.

SG: 1.30-1.35.

H: 3½-4. Depend on impurities increase the hardness to 4.

RI: 1.64-1.68.

Found in France, Russia, Poland, Colorado, Utah, New Mexico (USA), India, Turkey, China, Spain, Germany, Cambodia, and Whitby, Yorkshire (England).

**jet**; a synonym for black color, as black as jet.

**jet association**; pyrite and sphalerite were associated with the jet.

**jet coal**; → jet.

**jet black**; same as onyx.

**jet glass**; a black, opaque crystal glass, used in cheap jewelry. Hardness about 5.

**jet,- heat conductivity**; jet has very low conductivity, while it feel warm to touch. Heat conductivity is not a good test for distinguishing of jet from other stone or simulants.

**jet identification**; it has been much confusion in the past between jet, lignite, cannel coal and shale.

**jet names**; jet's name is derived from Greeks and Roman word gages, which is the name of a town and also a rive Lycia in Asia Minor. Also in old English called geate or geat and later become jeat and in Medieval time used gette. In French called jaiet, jayet, jyet, jais and in past was called gest, getz. In German called Gagat and Augstein. In Spain called azabache may be it is a Farsi name (an Iranian term for Azara-Padegan or Azar-Pad where the eternal fire for Zarathustrian people was protected and also made fire from this coal-variety because the fire was relatively permanent. Also it means fire protector ?) or Arabic term ?. In Portuguese called azeviche.

**jet preservation**; stones should be kept separate from harder material such as metal, etc., because scratching the jet. It may wash in warm water mixed with soap and cleaned with a soft brush.

**jet rock**; mostly jet rock are a group of black laminated shales.

**jet skin**; rough jet has a skin or spar of bluish-brown color which muss be removed.

**jet stone**; another term for black tourmaline or schorl used as a jet imitation.

**jett**; another spelling for jet.

**jettie**; an old local term used in England for some turned out a large number of stereotype pattern.

**jetting**; same as hydraulic mining.

**jet varieties**; according to its toughness there are two varieties, hard and soft. Hard variety is tough and durable which can be carved and polished, retain its shape and luster for long time, and is named as plank jet. Soft variety is brittle and crackled or split due to rapid temperature change and known as cored jet.

**jewel**; a fashioned and polished gemstone.

**jewel**; a fashioned ornament for personal adornment, which is made of noble metals mounted with natural, synthetic, or imitation gemstones.

**Jewel Box**; a name applied to a section of Kimberlite in the old Robert's-Victor Mine, South Africa.

**jeweled**; fitted with jewels.

**jewel enamel**; an enamel made of special porcelain used in jewelry as insignia and art objects.

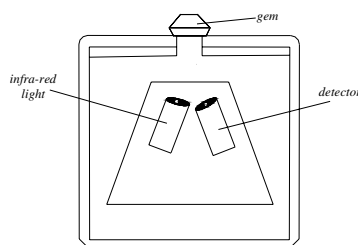
**jeweler**; who designs, manufactures, deals or repairs gemstones or jewelry.

**Jewelers of America**; an American jewelers association founded in 1957 by the merger of the American National Retail Jewelers' Association and National Jewelers' Association to promote the interest of retail jewelry industry. Acronym: JA.

**jeweler's citrine**; citrine crystal used in jewelry. → jeweler's topaz, jeweler's topaz-quartz.

**jeweler's diamond**; diamond used in jewelry. → Jewelry,-diamonds in.

**Jeweler's Eye**; when using refractometer for determination of refractive index of flat or cabochon pieces, the eye should be at a distance of 13-20 cm from the eyepiece.



sketch of a Jeweler's Eye

**Jeweler's Eye**; a commercial term for reflectivity meter. → Refractometer, distant vision method, Hanneman reflectance meter.

**jeweler's rouge**; a brown-red abrasive powder produced from purified hematite (Fe<sub>2</sub>O<sub>3</sub>) or calcinated ferrous sulfates. Used in polishing of gems and theatrical rouge. Also called ferric oxide, crocus.

**Jeweler's Security Alliance of the United States of America**; a non-profit security alliance was organized in 1883 for the protection of the jewelry industry. Headquarters for this society are located at: 6 East 45th

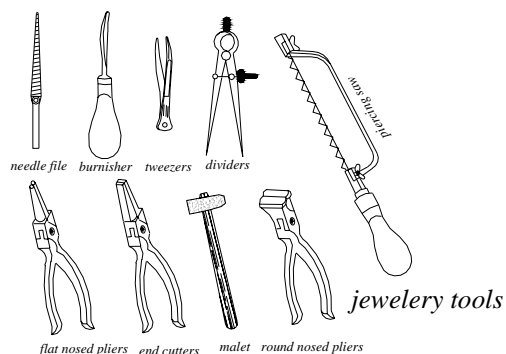


street, New York, City, New York 10017. Acronym: JSA.

**jeweler's shop;** an informal local term used by Australian miners when found a rich gold mining.

**jeweler's spectroscope;** → spectroscope.

**jeweler's tools;** those tools that may during working by



jewelers will use.

**jeweler's topaz-quartz;** → citrine.

**jeweler's topaz;** a misleading term for citrine.

**Jewelers' Vigilance Committee;** a non-profit association founded in 1917 to advance ethical practice in jewelry trade. Headquarters for this society are located at: 919 Third Ave., New York, City, New York 10022. Acronym: JVC.

**jewelite;** a commercial term for a colorless synthetic rutile used as a diamond imitation.

**jewel jade;** → emerald jade.

**jewel land;** same as gem-bearing district Mogok, Myanmar, (Burma). → Mogok stone tracts.,

**jewel of the Caribbean;** same as larimar.

**jewelry;** a number of decorative articles made artistically of gold, platinum, silver, and precious stones (natural stones and artificial substances) that are worn for personal adornment, such as bracelets, rings, necklaces, etc.

**jewelry;** the business or the art of a jeweler. → Costume jewelry, plastic jewelry.

**jewelry, diamonds in;** the first diamonds were regarded as talismans later they became a means of acquirement of wealth and magical protection in a conveniently portable form.

**Jewelry Industry Council;** a public nationwide organization of the entire industry, with the membership consisting of jewelry retailers and suppliers founded in 1946. Headquarters for this society are located at: 608 Fifth Ave., New York City 10020. Abbreviation: JIC.

**jewelry, selling;** generally giving two principles of selling of gemstones, either rough (diamond loose) or in jewelry (cut stone).

**jewels;** jewels that have been prepared for mounting in

jewelry or other objects of art.

**jewels;** any precious or fashioned stones or pearls.

**Jewels of Austria;** → Kunsthistorisches Museum, Vienna.

**Jewels of England;** → British Crown Jewels.

**Jewels of France;** → Apollon Gallery of the Louver Museum, Paris, French Crown Jewels, etc.

**Jewels of Germany;** → Grüne Gewölbe, Bavarian Imperial Treasury.

**Jewels of Hope Collection;** → Hope Collection.

**Jewels of India;** → Indian gem lore was from ancient times famous for its good quality and richness. There are several famous gems in other museums such as Timur Ruby, Koh-i-Nûr Diamond, Darya-i-Nûr Diamond, etc. Most famous part of Indian jewels was in possession of Maharajah Duleep Singh (1837-1893), son of Ranjit Singh or Tiger of the Punjab with the name *royal treasury of Lahore*, formerly Indian region, now in Pakistan. → Lahore Royal Treasury.

**Jewels of Iran;** → National Jewel Treasury of Iran, Iranian Treasury, Iran Crown Jewels.

**Jewels of Italy;** → Italian Gem Treasury, Vatican Museum, Roma.

**Jewels of Russia;** → Russian Treasury of Diamonds and Precious stones, Russian Diamond Fund.

**Jewels of Turkey;** → Topkapi Museum in Istanbul.

**Jewels of USA;** → Chicago field Museum of Natural History, American Museum of Natural History in New York, USA.

**jewel tweezers;** the tweezers used in jewelry to hold a jewel or gemstone.

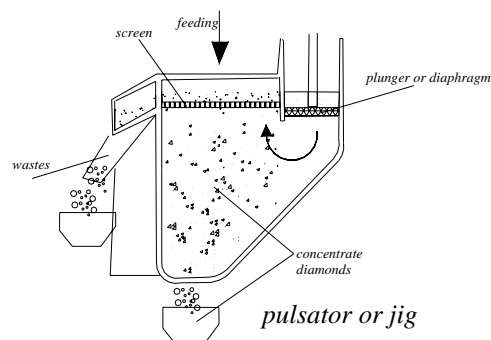
**jew's-stone;** some marcasite crystals used as ornaments, specially in costumes jewelry.

**JIC;** an acronym for Jewelry Industry Council.

**jiga;** same as jeqa.

**jigger;** who sorts or cleans ore by the jiggling. → Greaser.

**jig (mining);** a mechanical shaking machine or pulsator sieve, which separate diamond and other heavy



minerals by a quick up-and-down motion of the sieve usually in water. Generally concentrating of minerals or

ores according to relative gravity. Also called pulsator jig, or pulsator.

**jigsaw puzzles;** a term used for fitting together pieces of fragmented crystals that are separated from originally adjacent parts.

**jin;** a Chinese term for jade.

**Jinquan-jade;** a term used incorrectly to refer to antigorite from Gansu, China.

**jiqa;** jeqa.

**Jiqa of Nadir Shah;** same as Gika of Nadir Shah.

**joaillerite;** a French term for jewelry.

**João Neto de Compos Diamond;** a diamond of 201 cts, found in 1947 in Catalao district, Goyaz, Brazil. Present owner unknown.

**Job's tears;** rounded grains of chrysolite, a variety of olivine (peridot) associated with garnet found in Arizona, USA, and Mexico.

**jobber;** an independent wholesaler of gems and gem materials. It is distinguished from a manufacturer and importer. Usually they are paid on a commission basis.

**jobbing stone;** a term applied by jewelers for assortment of unmounted gemstones, kept for use in repair, etc.

**Joblong River;** location and river in Liberia, Africa where mined diamonds are found in the alluvial gravel.

**jochroite;** same as iochroite.

**Johan II, King of France;** he was very fond of jewels and owned very famous pieces jewels.

**Johan VI, King of Portugal;** who owned the mines of Brazil (1816-26) and had drilled through the rough diamond and wore it on special occasions.

**johannsenite;** a pyroxene mineral with chemical composition of  $4[\text{Ca}(\text{Mn}^{+2}, \text{Fe}^{+2})\text{Si}_2\text{O}_6]$ . Monoclinic crystal. Clove brown, grayish or greenish color. Translucent to opaque. Cleavage: {110} good, {001} and {010}. Fracture: uneven to conchoidal. Brittle. Optics;  $\alpha$ :1.703-1.716,  $\beta$ :1.711-1.728,  $\gamma$ :1.732-1.745.  $\oplus$ . Birefringence: 0.029-0.039. SG:3.44-3.55. H;6. Found in Mexico.

**Johannes gem;** a commercial term for a man made rutile used as a diamond imitation.

**johnite;** a term applied to a vitreous scaly variety of turquoise.

**Johnson and Rösch brilliant cut;** an old cut of several ideal brilliant cuts diamond, which has a table facet width, crown depth and pavilion depth of 56%, 19.2% and 40% that of the girdle diameter. The crown angle is 41.08%, and the pavilion angle is 38.67°. → *Eppler brilliant cut, Scan DN brilliant cut, Parker brilliant cut and Tolkowsky brilliant cut.*

**jolite;** synonym for iolite.

**Jolly balance;** a delicate spring balance, occasionally used to determinate the specific gravity of rough minerals and gemstones by the method of weighing in

water and air, in which the change of the weight is on vertical scale as spring varies. Also called Jolly's spring balance.

**Jolly Green Giant, the;** a green elbaite tourmaline of 27x10 cm from Newry, Maine, USA. Found in 1975? Present whereabouts unknown.

**Jolly's spring balance;** → Jolly balance.

**Jonah stone;** a term used by Australian miners for hard gray gypsum lumps from tennis ball to boulder, which is a sign of poor opal.

**Jonaskop;** a small alluvial diamond mine in Cape Province, South Africa.

**Jonker Diamond;** a flawless, fine colored, rounded diamond crystal with a cleavage face of 726 cts, in rough found in 1934 in the alluvial deposits of Elandsfontein, near Pretoria, South Africa. It was found by Jacobus Jonker. It was sold to Harry Winston, who cut it into one marquise and 11 other stones, all being emerald-cuts. The largest stone weighed 142.90 cts, with 66 facets and was called the Jonker. After recutting it weighed 125.35 cts. King Farouk of Egypt bought it in 1951, he sold in 1959 to the Himalayan state of Nepal. Last sold in Hong Kong in 1977. It is to mention that the Jonker II weighs 40.46 cts, and Jonker IV weighs 30.70 cts.,

**joplin jig (mining);** a device with shaker trays used to concentrate the heavy minerals or diamonds for final sorting.

**Joule;** a Standard Internal (SI) unit of work or energy or quantity of heat that is equal  $10^7$  ergs or approximately 0.7375 foot-pound or 0.2390 gram calorie or one watt-second.

**Jourado diamond;** an incorrect commercial term for a colorless synthetic spinel used as a diamond imitation.

**Jourado diamond;** a misleading term for colorless imitation stone.

**JSA;** an acronym for Jeweler's Security Alliance of the United States of America.

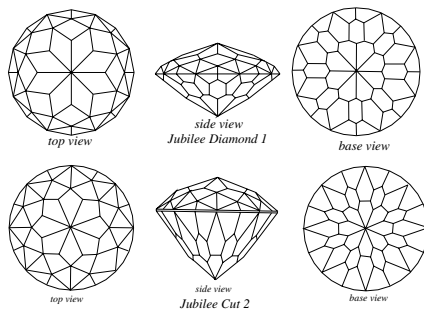
**ju;** a Chinese term for a carved bead, which is used as an ornament in central lower piece of a girdle. → Chinese ritual and symbol jades.

**juan jade;** a Chinese term applied to a mixture of white and red jade.

**juanyunmu;** a Chinese term for green sericite used as jade.

**Jubilee cut;** a modified form of diamond cut for large diamond devised in America was named in commemoration of the sixtieth anniversary of the Queen Victoria's accession to the throne in 1897. The table and the culet disappear completely and are each replaced by the eight extended trapezium-shaped bezel facets, meeting in a point on the crown and pavilion. There is thus a total of 80 facets (sometimes 88 facets);

40 facets on crown and 40 facets on pavilion. It was



*Jubilee Diamond-Cut*

named in honor of Queen Victoria's jubilee (1897). Also sometimes called Twentieth-century cut. → Jubilee diamond.

**Jubilee Diamond;** an exceptional whiteness and clarity, irregularly octahedron shaped diamond of 650.80 cts, in rough was found at the end of 1895 in the Jagersfontein Mine in South Africa. It was named as Reitz diamond after President of the Orange Free State. Its name was changed to Jubilee after the stone had been cut in commemoration of the sixtieth anniversary of the Queen Victoria's accession to the throne in 1897. A splendid faultless cushion-shaped brilliant, weighing 245.35 cts, was cut in the form of a pendeloque brilliant weighing 13.34 cts. The present owner is Paul-Louis Weiller of Paris and loaned (1961) to the Smithsonian Institution, Washington, D.C., which is put on exhibition. Also called Reitz diamond. → Jubilee cut.

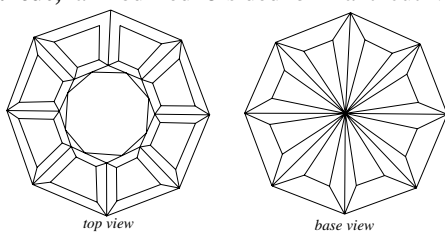
**Jubilee Mine;** location of a kimberlite diamond mine in Sakha, Yakutia, the Russian Federation, CIS.

**jue;** a Chinese term for a carved ring segment made of jade forming a wedge-shaped seal. → Chinese ritual and symbol jades.

**ju-i;** a Chinese term used for a scepter carved on jade. → Chinese ritual and symbol jades.

**julgoldite;** → pumpellyite.

**Juliana cut;** a modified 8-sided brilliant cut with 56



*Juliana cut. After Hartley*

facets in the crown and a large 8-sided table, 32 facets in the pavilion without culet.

**Julia Portrait;** portrait of Julia, daughter of Roman Emperor Titus (40?-81 A.D.) engraved on a so-called oriental aquamarine, (because of its fine color) of 50 x 35 mm. On display in the Cabinet des Médailles, Paris, France. → Oratorium of Charlemagne.

**Julius-Pam diamond;** a large yellow diamond of 246 cts, in rough was found in 1889 in the Jagersfontein Mine in South Africa in addition to the Excelsior and the Jubilee diamond. After cutting weighed 123 cts. Not to be confused with the Pam diamond. Also called Jagersfontein diamond.

**June Briolette Diamond;** a pale greenish-yellow, briolette-cut diamond of 48.42 cts. It is mounted in an oval, round pin. Present owner unknown.

**jungari;** a Persian term for emerald like green pepper. Also in Arabic spelled junjari.

**junjari;** same as junjari.

**junk;** a poor quality or low grade drill diamond.

**junk box;** a jewel box, in which are collected some damaged or temporary useless gemstones, sometimes used for worn-out or out-moded jewelry.

**junkerite;** same as siderite.

**Juodkrante amber;** an amber bearing region from Baltic Sea, where found the oldest amber from Neolithic Age in form of beads, necklace, button, pendant, etc.

**Jurassic;** age of cycads.

**Jurassic System;** the second or middle period of the Mesozoic era, in which rocks of this age are 195-136 million years old.

**Juscelino Kubitschak Diamond;** a diamond of 174 cts, in rough weight was found in 1954 in Estrêla do Sul, Minas-Gerais, Brazil. Present owner unknown.

**Jussupow Diamond;** same as Polar Stern diamond.

**Justinian;** some evidence suggests that Justinian the Byzantine emperor (527-565) returned the high breastplate to Jerusalem, where the Persians took it in the capture of the city in 615. It believed to be somewhere in Persia now.

**juvenile;** water, steam, and gases that are known to be emanations directly from magmatic material and come to the earth's surface for the first time.

**juxtaposition;** two or more crystals joined together in accordance with a twin law side by side (on a plane). → Interpenetration twins.

**JVC;** an acronym for Jewelers' Vigilance Committee.

**Jwaneng Diamond Mine;** location of kimberlite diamond deposit found at Jwanang south of Botswana, Southern Africa in 1973.

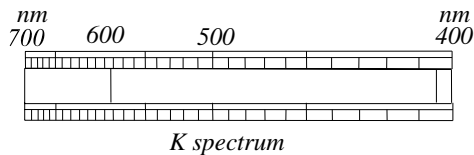
**jyet;** an old term for jet.

# K k

**K**; a chemical symbol for the element potassium.

**k**; symbol for one of the Miller indexes in crystallography.

**K**; one of the strongest Fraunhofer lines, almost at the limit of visibility in the extreme violet of the solar



spectrum, of wavelength (K) 393.38 nm, caused by calcium. → H.

**k**; an abbreviation for the word kilo.

**K** or **k**; an abbreviation for Karat.

°**K**; an abbreviation for Kelvin temperature.

**Kaalvallei Mine**; same as Samada Mine.

**Kaalfontein Mine**; location of minor diamond deposit in the Orange Free State, South Africa.

**Kaalpan**; location of a minor alluvial diamond deposit in Transvaal Province, South Africa.

**Kaalpalaats**; location of a small alluvial diamond deposit in Transvaal Province, South Africa.

**Kaal Valley Diamond Mine**; location of a minor diamond deposit in the Orange Free State, South Africa.

**Kaapse Tijd**; a Dutch term meaning the Cape Period.

**Kaapvaal**; an area in central South Africa with a number of kimberlitic pipes.

**Kadei River**; → Central African Republic.

**kaemmererite**; same as kämmererite

**Kafferpan**; location of minor diamond deposit in the Orange Free State, South Africa.

**kaersutite**; a titanium-rich black variety of hornblende.

**Kahama pipes**; location of three minor diamondiferous kimberlite pipes in Tanzania, Africa.

**kahi**; an Indian term for emerald with black tinge.

**Kaho Raukaraka**; a Maori term for green variety nephrite jade with olive-green to yellow green bands from New Zealand. → Pounamu.

**kahurangi**; a Maori term for the pale-green, translucent variety of nephrite from New Zealand. → Pounamu.

**Kainozoic**; → Cainozoic.

**Kaiser & Bond**; two scientists who discovered free nitrogen as a constant impurity in Type I diamonds.

**Kaiser yellow glass**; a yellow glass made by addition of cadmium sulfide, and zinc oxide. When adding cadmium selenide become orange-to-red, by which  $3\text{CdS}.\text{CdSe}$  is responsible for orange color and  $2\text{CdS}.3\text{CdSe}$  is responsible for red color. By adding of selenium sulfur and tellurium sulfur obtained blue, lilac, or purple colloidal colored glass. Used for filters. Also called Cadmium yellow glass.

**Kaiyéral**; a Ceylonese (Sri Lanka) term used in trade for dark-colored treble and not quite round pearls

**kakortokite**; a white, coarse-grained, banded igneous rock of the nepheline syenite group spotted with red eudialyte crystals. Containing alkali-feldspar, whitish nepheline, eudialyte, red arfvedsonite, and aegirine. SG:2.7-2.8. Found in southern Greenland. Used as ornamental rock, cut cabochon and other objects.

**Kalahari**; → Kalahari Desert.

**Kalahari Desert**; a term used in South West Africa for the desert district of Botswana. In 1968 the first diamond-bearing pipe was found in this region. Also called Kalahari.

**Kalahari Desert emerald**; allegedly there are some emerald sources in Kalahari Desert, Africa?

**kalanchu**; a Sri Lanka (Ceylonese) unit of weight for pearls used in trade; equal to 67 grains troy.

**ka-la-ngoh**; a Burmese term used for fifth class or bottom of rubies is a ruby with dark-red color, labeled as ka-la-ngoh, which means crying Indian quality. → Corundum classification in Myanmar.

**kalbaite**; a local term for hypothetical tourmaline molecules  $\text{M}_8\text{Al}_4\text{B}_2\text{Si}_4\text{O}_{21}$ .

**kalette**; German spelling for culet.

**kali**; a prefix used in terminology of igneous rock to signify the absence of plagioclase or a plagioclase content of less than 5%.

**kaligranite**; a term applied to plagioclase-free granite.

**Kalimantan**; location of a minor diamond-bearing area on the island of Borneo, Indonesia. Also called Kalimantan Mine. Kalimantan means: river of diamonds.

**Kalimantan Mine**; → Kalimantan

**Kaliningrad**; an amber industry province between Russia and Poland. In German the name Königsberg.

**kalinite**; a mineral of alum group with chemical formula:  $\text{KAl}(\text{SO}_4)_2.n\text{H}_2\text{O}$ .

**Kalkfontein Mine**; location of small alluvial diamond deposits in Transvaal Province, South Africa.

**kallipo**; a Ceylonese (Sri Lanka) trade term to distinguish lens-, or elongated-, or flattened-shaped pearls from other quality pearls. Nearly similar to

massanku. Also spelled kalippu.

**kalippu**; same as kallipo.

**kallainite**; same as callainite.

**kallait**; → turquoise.

**kalmuck agate**; → cacholong.

**kalmuck opal**; → cacholong.

**Kameelkuil**; location of small alluvial diamond deposits of north Kimberley in Cape Province, South Africa.

**Kamfersdam Mine**; location of diamond-bearing deposits in Cape Province, South Africa.

**kämmererite**; a rare gem mineral variety of penninite (a chrome-rich clinoclone of chlorite group). Also spelled kaemmererite.

System: triclinic.

Formula:  $Mg_5(Al,Cr)_2Si_3O_{10}(OH)_8$ . It contain ca. 5% chromium-oxide as color donation.

Luster: vitreous to pearly on cleavages.

Colors: red to purplish red, cranberry red.

Streak: colorless to reddish.

Diaphaneity: transparent to translucent.

Cleavage: {001} perfect.

Fracture: none. Flexible.

SG: 2.645.

H: 2-2½.

Optics;  $\alpha$ : 1.597,  $\beta$ : 1.598,  $\gamma$ : 1.5996.

Birefringence: 0.002-0.006.  $\ominus$  or  $\oplus$ .

Found in Gumushane in Erzincan (Turkey), Biserksk (Russia), California, and Texas, USA.

**kammgranite**; a term applied to porphyritic hornblende granite.

**kan**; a Japanese commercial term for 1000 momme in weight.

**kang mao**; a Chinese term for carved pendant seal from jade.

**Kan Huang jade**; a Chinese term for light yellowish jade.

**Kan jade**; same as kan Yü.

**kan Yü**; a Chinese term for boiled jade similar to chestnuts color.

**kan (weight)**; a Japanese term for a weight about 3.75 Kg.

**kanase**; a hereditary right for women in Myanmar, (Burma) that they try to scrape up the gravel from the stream bed with bamboo trays sorting for rubies.

**Kan C'hing jade**; a Chinese term for pale blue jade.

**Kanchanaburi sapphire**; most important sapphire mine in Kanchanaburi province, Thailand with blue color and slightly milky.

**kand**; a Cornish term for blue-john or fluorite. → Cand.

**kandeh-kari**; a Farsi term meaning engraved. Mostly engraved stones are provided with poesy, religious aphorisms or figures. → Turquoise cut in Iran.

**Kandy Cat's-eye**; a chrysoberyl cat's-eye of 313.50 ct,

set in a gold circle with other stones. It belonged to King of Kandy, in Sri Lanka (Ceylon), When conquered by the British in 1815 was presented to Queen Victoria in 1886.

**Kandy spinel**; a misleading term for reddish-violet almandine garnet from Sri Lanka (Ceylon).

**kaneelstein**; a German term for hessonite.

**Kanese**; the women working with bamboo trays to obtain rubies from gravels in streams in Myanmar, (Burma).

**kandite**; a suggested general term for the kaolin group of clay minerals. These included kaolinite, dickite, nacrite, halloysite, meta-halloysite, allophane, and anauxite.

**kann**; → Cand.

**Kansas diamond**; a misleading term for smoky quartz crystal from Hill River, Kansas, USA.

**kansasite**; a variety of fossil resin found in shale together with coal. Also called jelinite.

**Kao mine**; location of a diamondiferous pipe at Kao in Lesotho, Southern Africa.

**Kaokoveld**; a coast area for diamonds and quartz crystal of gem quality in South-West Africa.

**kaolin**; a soft, fine, white, or slightly colored, clay due to the decomposition of a highly concentrate feldspar in pegmatite, granite or gneiss rock having approximate composition:  $Al_2O_3 \cdot 2SiO_2 \cdot 2H_2O$ . The kaolin minerals include kaolinite, nacrite, dickite, and anauxite. Used as an abrasive and in manufacture of porcelain. Sometimes same as kaolinite. Also called porcelain earth, lithomarge, China clay, bolus alba. → Koalinite.

**kaolinite**; a fine common clay mineral of kaolin group. Trimorphous with halloysite, dickite, and nacrite. A weathering or hydrothermal altering product of feldspars → Kaolin, kaolinization.

System: triclinic.

Formula:  $2[Al_2Si_2O_5(OH)_4]$ .

Luster: pearls to earthy dull.

Colors: colorless, white, often tinted reddish, bluish, yellowish, and brownish.

Streak: colorless to white.

Diaphaneity: transparent to translucent.

Cleavage: {001} perfect.

Fracture: none. Inelastic, scales flexible, often plastic, when moist.

SG: 2.60-2.63.

H: 2-2½.

Optics;  $\alpha$ : 1.553-1.565,  $\beta$ : 1.559-1.569,  $\gamma$ : 1.56-1.57.

Birefringence: 0.013.  $\ominus$ .

Found: widespread

**kaolinization**; the process whereby feldspars, and other alumo-silicate minerals or other clay minerals, are altered into kaolin. The active agents being, apparently, magmatic water and carbon oxides.

- kaolinized rock;** pegmatite rocks, in which the feldspars other alumo-silicate minerals are altered into kaolin condition, in which are sometimes emeralds embedded, found in New South Wales, Australia.
- kaolite;** a commercial local term used in Arizona for simulant cameos molded in clay and baked in a variety of colors.
- Kao Valley;** an area in northern Lesotho, Southern Africa, there are numerous of kimberlitic diamond deposits located.
- Kapaus River;** location of an unimportant alluvial diamond deposit in Borneo, Indonesia.
- kapeu jade;** a Maori term used for a flat gem piece with curved ends made of nephrite or any greenstone from New Zealand.
- Kapiolani Diamond;** same as Star of Denmark Diamond.
- kaps;** a Dutch term for a diamond, which has been not polished but cleaved, split, or sawn.
- Kara kara;** an Indian term for emerald with gritty fragments leads to death to owner's son. → Emerald colors and superstitious in Indian.
- Karakara;** another spelling of Kara kara.
- karang;** a term used in Malay State, and Indonesia for an emerald green terrace composed of reef material.
- karang;** a term used for coral limestone.
- karat;** in metallurgy a unit that expresses only to the purity of solid gold used in jewelry. In trade based on a scale of twenty-fourths, 24 karat means pure gold, 18 karat gold means, containing 18 parts gold to 6 parts of alloy (18/24), and 9 karat gold means, containing 9 parts gold to 15 parts of alloy (9/24). A term that expresses only to the purity of solid gold used in jewelry. In some countries, the proportion is expressed as part per thousand: 24 Karat gold is equal 1000 parts, 18 karat gold 750. Sometimes spelled karate. → Carat.
- karat;** the word karat applied to alloys of metals, and carat, when referring to weight. Sometimes spelled karate. → Carat.
- Karate;** fineness of solid gold and gold alloy is spelled karat. → Karat, carat.
- karcite;** a substance having similar appearance as kermesite, which is used as an artificial cordierite.
- Kareboom;** location of a small alluvial diamond mine in Transvaal Province, South Africa.
- Kareepan;** location of a small alluvial diamond mine in Transvaal Province, South Africa.
- Kareepoort;** location of a small alluvial diamond mine in Transvaal Province, South Africa.
- Karfunkel;** a German term for carbuncle.
- Karlsbad spring stone;** an alternate term for banded, red, white and brown gypsum used for carving of small objects.
- Karlsbad twin;** → Carlsbad twin law.
- Karlsbad twin law;** → Carlsbad twin law.
- Karma Purani;** an Indian authority of treatise of gems in Hindu for belief of celestial influence upon gemstones.
- Karneol;** a German term for carnelian.
- Karnul River;** location of a diamond-bearing district in South-East at Karnul, India.
- karnul working;** location of a minor diamond production in South-East at Karnul, India.
- karpbolite;** a term applied to an amphibolite or prismatic augite-spat.
- kar rock;** same as circus rock, kettle rock.
- karst;** any uneven limestone topography.
- Kasai;** → Kasai District.
- Kasai District;** location of an alluvial diamond-breeding area in southern Zaire, near the border with Angola. Also called Kasai. → Luebo, Kasai Diamond Field.
- Kasai Diamond Field;** location of an alluvial diamond-bearing area in Southern of Zaire, Africa. → Luebo.
- Kashan flux-grown rubies;** → flux-grown synthetic ruby, flux-fusion method.
- Kashan synthetic ruby;** → flux-grown synthetic ruby, flux-fusion method.
- kashatriya emerald;** an Indian term for dark-green emerald.
- Kashgar;** → Kashgar jade.
- Kashgar jade;** a nephrite of inferior quality from Kashgar, Chinese Turkestan, which was sold for a long time as jade to cutters.
- Kashmere sapphire;** another spelling for Cashmere sapphire.
- Kashmir;** beautiful sapphire and rubies occur in various parts on Kashmir, Pakistan. Also spelled Kashmere, Cashmere.
- Kashmir sapphire;** another spelling for Cashmere sapphire.
- Kashmir type;** an old commercial term for a fine, rich blue but slightly milky sapphire from Kashmir, which used as comparing when stone was mined elsewhere.
- Kaşıklı Diamond;** a pear-shaped, rose-cut diamond of 84 cts, from India, mounted in a frame with 49 smaller diamonds. Once belonged to the Sultan of the Ottoman Empire (Turkey). Now it is on display at the Topkapi Museum in Istanbul. Also called Spoon-maker's Diamond, or Turkey II Diamond. Spelling of Turkey is Kaikçi.
- katagenesis;** same as catagenesis.
- katamorphism;** the change of the rock by weathering, in which chemically simple minerals are formed from more complex ones, that are not usually included under the head of metamorphism. A destructive process of metamorphism. Contrast word is anamorphism.

→ Catamorphism

**katathermal ore deposits;** hydrothermal ore minerals formed at high temperatures.

**Katanga;** location of an azurite and malachite occurring district in the Congo, Africa.

**katazone;** another spelling for catazone.

**Katdoornkraal;** location of a small alluvial diamond-bearing area in Transvaal Province, South Africa.

**katouti;** a gold-washing trough used in north west India.

**Katsha River;** location of a diamond-bearing area on Bécéka concession in the Zaire, Africa.

**kau;** a Chinese term for yellow nephrite. → Nephrite colors in Chinese, Chinese ritual and symbol jades.

**Kaufersdam Farm;** location of a diamond mine, of the de Beer's Fame, neighboring of Dutoitspan mine (Dortsfontein farm), at Kimberly, South Africa.

**kauri;** → kauri copal.

**kauri copal;** → kauri gum.

**kauri gum;** a light-colored, whitish yellow to brown copal found as a fossil resin from the kauri pine *Dammara australis* or *Agathis australis* from Australia, New Zealand and other sources. Smells like turpentine. Used as inferior imitations of amber and varnishes. It can be distinguished by its fusibility. Also called kauri copal, kauri resin, kauri (Maori), agathocopalite, copal, copal resin. Large and clear pieces are prized by *gum diggers*, they polished such pieces or carved into ornaments by using the natural surfaces. Transparent and clear pieces used as pipes, cigar and cigarette holders. → Copal.

**kauri resin;** → kauri gum.

**Kavalier glass;** a chemically resistant glass rich in potash, it was first made by F. Kavalier at Sazava, the Czech Republic.

**Kavir;** a Farsi (Iranian) term for salt desert, a desert with a saliferous soil. Also spelled Kevir.

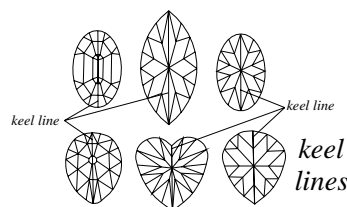
**kawakawa;** a Maori term for ordinary green variety of nephrite from New Zealand. → Pounamu.

**kawk;** a Cornish term for fluorite.

**kayselite;** a local synonym in Turkey for diaspore.

**keatite;** a high-pressure man-made form of silica. No counterpart exists in nature.

**keel line;** it means a line at central fore-and-aft-structure



in the bottom of a Sailboat or ship's hull. Such

intersection can be seen of the pavilion facets of a fancy pear-shaped, heart-

shaped, marquise, oval, and emerald-cut gemstone, running the length of the base.

**Ke Ploi;** a Thai term used for gem-bearing gravels in

which a narrow circular pit of 1m diameter sunk down.

**keffekilite;** a Turkey term for sepiolite, pipe soil.

**Keiskama;** location of a small alluvial diamond-bearing area in Cape Province, South Africa.

**kelve;** a Cornish term for fluorite. Also called kilve.

**kelvin;** another spelling of Kelvin.

**Kelvin;** same as Kelvin temperature scale. Also spelled kelvin. → Absolute temperature.

**Kelvin temperature scale;** a System International (SI) unit of thermodynamic temperature scale, commences at absolute zero, equal to  $1/273.16^{\circ}$  C. → Absolute temperature.

**kemite;** a commercial term for a ceramic containing synthetically cordierite and a little silicon carbide and carbon to fill the pore spaces.

**Kempen;** location of a diamond industry around the towns of Herentals, Nijen, and Grobbendonck, near Antwerp, Belgium.

**Kenema;** a town in southeastern Sierra Leone is also the location of the Government Diamond Office, and near there are some alluvial diamond deposits.

**Kenilworth farm;** location of a diamond mine in South Africa.

**Kenja River;** location of a diamond-bearing area in Sierra Leone, Africa.

**Kenneth Lane Jewel;** a commercial term for strontium titanate used as a diamond imitation.

**kentallenite;** a coarse-grained, dark variety of basic igneous monzonite rock composed of olivine, pale-green augite, biotite, plagioclase, and orthoclase.

**Kentucky diamond;** a misleading term for quartz crystal from Kentucky, USA.

**Kenya;** kyanite, sapphire, and epidote (clinozoisite) occurred in Kenya.

**Kenya Gem;** a commercial term for man-made rutile used as a diamond imitation.

**kenyte;** a fine-grained igneous rock, essentially an olivine bearing phonolite. Occurring on Mt. Kenya, Africa.

**keratophyre;** a term applied to any salic dike, lava rocks characterized by the presence of highly sodic feldspars such as albite or albite oligoclase, chlorite, epidote and calcite.

**Kerbehuk;** location of an alluvial diamond-bearing area along the Namibian coast, Africa. Also known as Area K.

**Kerez effect;** an optical effect that is observed in some tourmalines, in which are multiple shadow edges (up to eight shadows) to instead of two edges on a critical-angle refractometer. The new shadow edges caused by local overheating during polishing and can read only by outer zones. This effect can be removed by repolishing. Also called *float*, or *satellite readings*.

**kerf (diamond working);** a term applied to small notch or groove cuts in a rough diamond with another sharp edged piece to prepare it if there is cleavage. Also called kurf, furrow, and kirve. A term used as a verb.

**kermes;** a Farsi (Persian), term for colorant obtained from the dried bodies of females of *Kermes ilicis*, a hemipteran insect. Also called crimson. Kermes or ghermez in Farsi meaning red or red color, the name is combined with the city Kerman, South-East Iran.

**Kermes ilicis;** a hemipteran insect from the dried bodies of females of them obtained red dye with the name kermes.

**kermesite;** a triclinic pseudomonoclinic, cherry-red colored mineral with the formula  $8[\text{Sb}_2\text{S}_2\text{O}]$ . SG:4.68. H:1-1½. Also called pyrostilbite, red antimony, purple blende, antimony safran, safran of antimony, kermesome. It is prized by collectors.

**kernel;** a term used by Australian miners for those opals found inside a kernel boulder. Also called kernel opal.

**kernel boulder;** a term used by Australian miners for precious opal found forming in kernel of small nodule of siliceous ironstone.

**kernel boulders;** same as nest.

**kernel opal;** same as kernel.

**Kerouane;** location of a diamond-bearing area in Guinea, Africa. The deposits in this area are Kissidougou, Beyla, and Macenta. → Guinea.

**keshi;** a Japanese slang for smallest particle imaginable such as a poppy seed or a grain of sand. Any oyster seed used in Japan in cultured pearl industry from akoya oyster. → Biwa pearls, keshi pearl.

**keshi pearl;** a small, non-nucleated, baroque-shaped, poor-quality cultured pearl, which form in a large oyster *Pinctada martensi*, when it is returned to the sea. Sometimes produce round-shaped pearl. → Biwa pearls, keshi.

**ketu;** an Indian legendary fearful figure together with other figure namely *rahu*, are able to influence emanating of evil, by using emerald will appear the wrath and ward off evil.

**Keuper series;** a stratigraphic stage term for the West European upper Triassic system. The rocks are clays, marls, and sandstones, with salt deposits.

**Keweenaw agate;** a local term applied to a variety of agate or chalcedony found near Lake Superior, Canada.

**Kevir;** another spelling for Kavar.

**key;** same as legend.

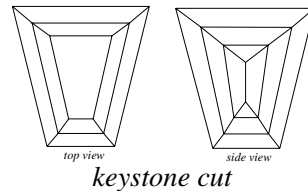
**key color;** primary bodycolor seen, when a diamond is in a face-up position.

**key cut (mining);** in alluvial diamond mining man-made channel excavating, or paddock in the overburden for the full length of the area, thus exposing the diamond-bearing placer.

**key diamonds;** same as master diamonds.

**keying oysters for culturing;** by opening the oysters and inserting a graft like a bamboo wedge or *key* to be inserted into the *antero-ventral region*. For sufficient opening of two *gapes* of valves used pincers or forceps, which are known as the *shell speculum*. The keying process itself needs more care, for the edge of the mussel can be broken.

**keystone;** a style of four-sided symmetrically step-cut diamond or other transparent gemstones with the outline in the form of the conventional keystone or isosceles trapezoid, at the center of the



crown of an arch. There are two or more rows. A short tapered baguette. Also called keystone cut.

**keystone cut;** → keystone.

**keystoneite;** a term applied to chalcedony or chrysocolla colored by copper silicate.

**K-feldspar;** a misnomer for potassium feldspar as orthoclase or microcline.

**khagi;** a Farsi term used for *tokhom-morghhi* (mean egg-shaped). → Turquoise cut in Iran.

**khake;** a Farsi (Iranian) term applied to Persian Gulf pearls, which sold in miscal weight (ca. 4 grams).

**khake;** a Farsi (Iranian) term for dust or anything small or minute.

**khaki;** a term applied to a peculiar brown shades of zoisite.

**khaki;** a term applied in Nishabur turquoise mine, Iran to kind of mining by digging in the detritus of rock washed down toward the bottom of valley.

**khaki;** a Farsi term used for sky-blue colored turquoise. → Turquoise classification in Nishabur, Iran.

**Khao Ploi Waen sapphire mine;** a sapphire gem-bearing district in Chanthaburi province of Thailand.

**Khasumi diamond;** same as Arabic diamond.

**Khediye Diamond;** a flawless, champagne-colored, emerald-cut diamond of 36.61 was recut from a stone of 43 cts, said to have been presented from Ismail Pasha, Khedive of Egypt to France's Empress Eugénie, in honor of the opening of the Suez Canal in 1869. It was sold in 1986. Present owner and location unknown.

**khesbet;** an Egyptian term for lapis lazuli.

**Khiraj—i-Alam Ruby;** (it means The Tribute of the World). An unfaceted, fine red spinel of 352.50 ct from India with the inscription in Persian indicating six of its royal owners the Mogul dynasty. Also called Timur ruby. Now among the British Crown Jewels.

**khoharite;** a variety of garnet. → Garnet.

**Khondallite series;** a garnet-bearing metamorphic rock



consisting of garnet-quartzite-sillimanite rocks.

**Khorassan;** Khorassan a region of North-East Iran, it is famous for its turquoise.

**Khorog lapis;** lapis lazuli from Khorog, Tadjikistan near the border Badakhshan of Afghanistan. Also called Russian lapis, Badakhshan lapis.

**Khotan;** → Khotan jade.

**Khotan jade;** a nephrite of inferior quality from Khotan region, China Turkestan, which was sold for a long time as jade, to cutters.

**Kiani Crown;** an Iranian crown probably made for coronation of Fath-Ali Shah of Qajar dynasty (1797-1834) in Isfahan, which is topped by 1,800 pearls, 300 emeralds (one of them weighed 80 cts.), 1,500 spinels, and a fine pink diamond of 23 cts, The crown weighs 4,500 grams. Exhibits in Treasury Jewels of Iran, Tehran. Open to the public.

**kidney-like;** → reniform.

**kidney limestone;** same as reniform limestone.

**kidney ore;** a variety of hematite ( $Fe_2O_3$ ) occurring in reniform nodule masses. The internal structure of the kidney-shaped pieces is usually radiating fibrous, or concentric.

**kidney-shaped;** → kidney stone, kidney ore, reniform.

**kidney stone;** a misleading term for reniform pebble or nodule of nephrite or greenstone, so-called perhaps because of some jade.

**kidney stone;** a misleading term for reniform hematite. Also called kidney ore.

**Kiel;** location of a small alluvial diamond-bearing deposit in Transvaal Province, South Africa.

**kiripaka abrasive-stone;** a term used by Maori native of New Zealand for abrasive material for cutting grooves in the jade. It is compound of quartz-bearing mica schist.

**kies;** a German term for the sulfide ores.

**kiesel;** a German term for rock-crystal.

**Kieselgur;** a German term for diatomite.

**Kiev Synthetic Diamond Research Institute;** a laboratory founded in Kiev for produce synthetic diamonds in the Russian Federation, CIS.

**Kiku-ishi (chrysanthemum stone);** a Japanese term for an ornamental flower-like radiating zircon, and xenotime crystals, which occurs in igneous basaltic rock in Maru-Yama, Japan. Kiku-ishi means *chrysanthemum stone*. It is a radial aggregated variety of zircon, and xenotime is called Kikukwaseki. Found in Malagasy, Japan, Canada, Brazil, Norway, South Africa, New Zealand, and India. → Xenotime.

**Kikukwaseki;** → Kiku-ishi.

**kilkenny black fossil marble;** a black marble from Ireland containing remains of brachiopod fossils.

**kilkenny coal;** same as anthracite.

**Killircrankie diamond;** a misleading term for colorless topaz from Tasmania, Australia. Used as a gem imitation.

**killers;** → phosphor in zinc sulfide.

**killow;** an obsolete term for vitriol. Same as ink stone.

**kilve;** → kelve.

**kima gem;** a commercial term for man-made rutile used as diamond imitation.

**Kimberley;** an industry town in the center of South Africa where there are four diamond pipes and a few mining camps. Named after Earl of Kimberly, Secretary of State for the British Colonies. Also one of the Big Five diamond bearing mines from Cape Province, South Africa. Also called *Diamond City*, Kimberley Diamond Mine → Big Five.

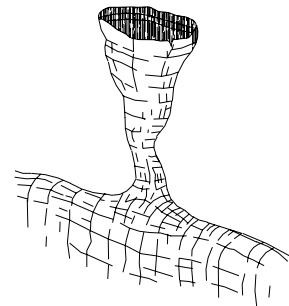
**Kimberley Central Diamond Mining Company;** one of the diamond-mining corporations that worked at the Kimberley Mine. → Kimberley, Big Five.

**Kimberley Diamond;** a champagne colored diamond of 490 cts, in rough. After more times recutting at least in 1958 was fashioned in a flawless emerald-cut of 55.09 cts. Found in Kimberley diamond mine in South Africa. Last sold to an undisclosed collector.

**Kimberley Diamond Mine;** same as Kimberley.

**Kimberley District;** → Western Australia.

**Kimberley Mine;** famous diamond-bearing kimberlite mine in South Africa, discovered in 1871, which is



*Kimberlite volcano pipe. After Cloos, H. 1936*

located at Colesberg Kopje, Cape Province. This mine originally was known as De Beers New Rush, and later as New Rush, finally it was named Kimberley. Also called *big hole*. → Kimberley, Big Five.

**Kimberley Mines;** a term applied to a group of five diamond pipes around the town Kimberley in south Africa: Bultfontein, De Beers, Dutoitspan, Kimberley, and Wesselton. Also called *De Beers Mines*, or the *Big Five*. → Kimberley, Big Five.

**Kimberley Museum;** a remarkable museum surrounding Kimberly Big Hole, which is devoted to old Kimberly and the history of diamond digging. Also known as Old Mines Museum.

**Kimberley Octahedron Diamonds;** a huge yellow

well-shaped octahedron diamond of 616 cts, of poor quality found in 1974 in Dutoitspan mine, Kimberly, South Africa. It is the largest octahedron and the ninth largest rough diamond ever found. It is exhibited in the, Old Mines Museum.

**Kimberley Octahedron Diamonds;** a big yellow octahedron diamond of 253.70 cts, found in 1964, sold to Harry Winston and then presented to the Smithsonian Institution, Washington, D.C., USA in memory of Ernest Oppenheimer.

**Kimberley Plateau;** → Western Australia.

**Kimberley Pool;** a local term applied to the three original De Beers mines: Bultfontein, Dutoitspan, and Wesselton.

**Kimberley pyrope;** an ultramafic igneous rock of mica-peridotite, which fills the diamond pipes in Kimberly, South Africa.

**Kimberley shale;** black shale from Kimberly.

**kimberlite;** a coarse-grained, ultramafic igneous rock of mica-peridotite containing phenocrysts of olivine, phlogopite, garnet, apatite, spinel, ilmenite, carbonate, clinopyroxene, and possibly geikielite and chromian pyrope. Occurring in volcanic pipes tends to be carrot-shaped in South Africa, etc., which is the host rock of diamonds. Kimberlite is one of only two rocks known to host diamond, the other is lamproite. Alteration of Kimberlite known as *blue ground*, which weathers by oxidation at the surface downward to *yellow ground*. Also called blue earth or blue ground by miners.

**kimberlite gem;** a commercial term for synthetic rutile. Used as a diamond imitation.

**Kiminina River;** the world's biggest source of alluvial diamonds of the Kiminina River in Zaire (former Belgian Congo) extended into the Angola. First diamond was found in 1910.

**Kimmeridge shale;** a highly bituminous bluish-gray to brownish-black clay, containing marine fossils, occurring in the Isle of Purbeck in Dorset, England. SG: 1.285. Conchoidal fracture. Used as a jet imitation.

**kimpi;** a term applied to red or brownish variety of jadeite.

**kimzeyite;** a dark brown mineral of garnet group with chemical formula:  $8[\text{Ca}_3(\text{Zr},\text{Ti})_2(\text{Al},\text{Si})_3\text{O}_{12}]$ . Vitreous luster. Streak: pale brown. SG:4.00-4.02.  $H \approx 7.00$ . Found in Kimzey, Arkansas, USA. Also known as calcium-zirconium garnet.

**kind;** → kindly.

**kindradite;** a misleading term for kinradite.

**kindly;** a term used for rock or belt of ground that given indications of containing valuable minerals. Also called likely, promising, kind.

**kinetics of growth;** kinetic growth of crystals.

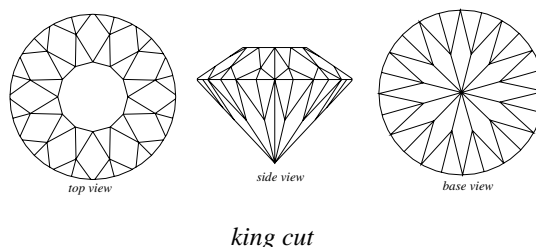
**kinga-stone;** a semicrystalline glass made to imitate

jade, it is made in different colors and degrees of devitrification. Also called victoria stone, meta-jade, victoria cat's-eye. If the fibrous inclusion are parallel it shows chatoyancy effect, when cut cabochon. → Iimori stone, cathay cat's-eye.

**King Charles I Seal Diamond;** a legendary diamond of unknown weight and origin, which was carved in the Royal Arms of England. Prior to his death in 1649, Charles I gave this diamond to his son Charles II. Present owner unknown.

**King Croesus stone;** another term for simav opal.

**King cut;** a trade term rarely used for modification of a near rounded brilliant cut for large stones, which has a symmetrically twelve-sided table (instead of eight-fold)



with 48 surrounding facets to form the crown of the stone, and 37 facets, no culet on the bottom, with a total of 86 facets. The crown consists of 12 small triangular facets touching the table and 24 small triangular facets touching the girdle, between both are 12 lozenge-shaped facets. → Magna cut.

**King Edward VII;** Cullinan Diamond was purchased by the Transvaal Government and presented to King Edward VII of England on his birthday in 1907.

**kingfisher jade;** green to bluish-green jadeite that resembles the back of the kingfisher. Also called feits'ui. → Maw-sit-sit.

**King George IV;** a colorless, round-shaped, diamond of 32.23 cts, set in a crown for King George IV of England in 1821. It was reset in a crown for King William IV. It was later reset in a tiara. Sold to Duke Westminster in 1837. Purchased by Harry Winston in 1959 and repolished to a 26.77 cts, round brilliant and sold in New York in 1970.

**King Midas Opal;** an Australian opal of fine-quality obtained by Czar Nicholas II of Russia it is now believed to be at the St. Petersburg (Leningrad) Museum.

**King of Portugal Diamond;** → Braganza Topaz, Braganza Diamond.

**king's blue;** same as cobalt blue.

**king's coral;** a horny, thin branch-like variety black to dark-brown coral of *Antipathes spiralis*. The Italian

term is giogetto also spelled giojetto. It is used in beads, necklaces, bracelets, art objects, etc., Fashioned and prized by the native people of the West African coast, and East Indian Islands. Also used as amulet against poisoning, to prevent disease. SG:1.37. H:2-3. In Malay and southeastern Asia, and Indian Ocean region is called akabar. Also called black coral, accarbar. → Blue coral.

**king stone;** a term used by Australian miners for a superior opal which stands out in quality from a patch or pocket. Also called queen-stone.

**king stone;** a frequently used name for king topaz.

**king topaz;** a misleading term used in Sri Lanka for deep yellow to orange variety of sapphire. Also called king stone.

**kinradite;** a local term used in California and Oregon, USA for jasper containing orbicular inclusion of colorless or nearly colorless quartz. Sometimes misspelled as kindradite. Also called orbicular, poppy stone.

**kirschsteinite;** same as iron-monticellite.

**Kirti-Nur Diamond;** a pink, pear-shaped diamond of 15.00 cts, from Golconda, India. Purchased by a diamond dealer in 1990.

**Kirve;** → kerf.

**kirwanite;** a variety of anthracite with a metallic luster.

**kismet pearls;** a commercial term for imitation pearls.

**Kissidougou;** a district in Guinea, in which diamonds are mined. → Kerouane.

**Kistna Group;** a term sometimes used to describe the alluvial diamond-bearing mines near the city of Golconda, State of Hyderabad, India.

**Kistna River;** same as Krishna River.

**kite;** same as kite cut.

**kite cut;** a four-sided trap-cut (lozenge cut) stone having an outline of a child's kite, that two touched sides of the

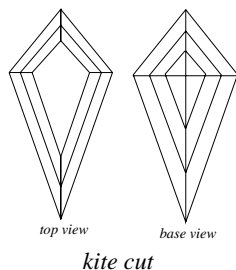


table are longer than the other two sides. Also called kite.

**kite facets;** an alternate name for the eight kite-shaped crown facets on a brilliant cut, which extend and abut the girdle and table. Also called bezel facets, main bezel facets, top main facets. → Bezel, brilliant cut.

**kites;** same as kite facets.

**klaprothine;** another term for lazulite.

**Klein's solution;** a saturated, yellow heavy aqueous solution of cadmium boro-tungstate having a maximum of SG: 3.55, which is lowered by dilution with water. Used in separation of minerals.

**Klein Spitzkopje;** pegmatite rocks at Klein Spitzkopje in South Africa, in which occur blue-green to pale yellowish-green and pink tourmaline crystals of gem quality.

**Kleinzee;** location of an alluvial diamond deposit to the north area in Namaqualand, Southwest Africa. From here diamonds were transferred to Annex Kleinzee.

**Kleinzee, Annex;** → Kleinzee, Annex Kleinzee.

**Kleinzee Farm;** location of diamond-bearing gravels area near Kleinzee town in Namaqualand, Southwest Africa.

**Kleinzee Mine;** location of an alluvial diamond-bearing area in Namaqualand, Southwest Africa.

**Kleinzee town;** → Kleinzee Farm.

**klinkstone;** same as phonolite.

**Klipbankfontein;** location of a small gravel diamond deposit in Transvaal Province, South Africa.

**Klipdam;** location of an early gravel diamond deposit in Vaal River, Cape Province, South Africa.

**Klipdrift (Canteen Kopje);** formerly name for Canteen Kopje. The first diamond digging mine on the bank of the Vaal River near Barkly West in South Africa. Now known as the Barkly West Group.

**Klipfontein;** location of a small gravel diamond deposit in Transvaal Province, South Africa.

**Klipkuil;** location of a small gravel diamond deposit in Transvaal Province, South Africa.

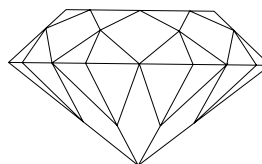
**Klippan;** location of a small gravel diamond deposit in Transvaal Province, South Africa.

**knee-shaped twin;** a twin frequently can be seen in cassiterite twinned plane parallel to one of the pyramid faces in knee-shaped or elbow-shaped with a characteristic notch, which is known as geniculate twins.

**knife edge;** a narrow knife edged rock.

**knife edge;** same as knife edge girdle.

**knife edge girdle;** the thin girdle of a brilliant-cut diamond, which is so thin that it resembles the edge of a sharp knife. Also called knife edge, feather edge. → Lumpy girdle.



knife edge girdle

**kniepinkiniai;** a term used in Lithuania for ornamental objects carving from amber lumps to pass winter months.

**Knischka flux-grown synthetic rubies;** → Knischka synthetic rubies.

**Knischka synthetic rubies;** a method of synthetic ruby, grown by a flux-melt process, experienced by Knischka Company in Austria. Substantially is the same as the natural ruby and free of any trace of iron. Also spelled PK synthetic rubies.

**knits;** minute particles of ore. → Knots.

**knobby;** a term used by Australian miners for precious opal in solid lump form. Also called nobby.

**Knoop indentation hardness test;** a term applied to a micro-indentation tester for determining the hardness of metals, alloys, and stones developed by Knoop. The hardness is measured by pressing a pyramid-shaped diamond into the surface of specimen and computing the area of the indentation in relation to the load on the diamond point. A double-cone indenter was developed by Grodzinski. Also called Knoop indenter. → Indentation test, indenter test for hardness.

**Knoop indentater;** same as knoop indentation hardness test.

**knop;** a German term used for an ornament as a finial or decorative swelling.

**knorringite;** a mineral like a chromiferous pyrope with the chemical formula:  $Mg_3Cr_2Si_3O_{12}$ .

**knot;** a term used for an included single crystal of a diamond, which is oriented differently from the host crystal and often creates problems in cleaving and polishing the stone. Knots stand out as small, raised surfaces after the polishing process, such diamond is known as *hard*. Also called naats.

**knot;** sometimes a minute part of a twinned stone, which caused the same effect as above.

**knot;** an included diamond crystal creates problems well within the saw blade.

**knot;** an imperfection or an inhomogeneity in the form of a vitreous lump.

**knot lines;** a name used sometimes by cutters for the twinning lines within or on a diamond crystal. Same as grain lines. → Graining.

**knobs;** a term applied to a segregation of darker minerals in gneiss and granite, or small concretion of galena in sandstone. Also spelled knits.

**ko;** a Chinese term for carved objects in form of a halberd made of jade.

**kobins;** a Myanmar (Burmese) term for large reinforced pits with sides of 1.5 meter in diameter in Myanmar ruby mines.

**kochenite;** a term applied to a fossil resin, like amber from Kochenthal, Austria.

**kodai pearl;** a Sri Lanka (Ceylonese) commercial term for spherical and various colored pearls with no nacreous luster, which are formed of prismatic shell.

**Kodurite;** an ancient source for grossular in Genjam district, India.

**Koenigskrone Mine;** location of an old topaz mine at Schneckenstein, Saxony, Germany, it was the source of the topazes in the crown jewels of Saxony. Now on display in the Green Vault, Dresden. → Green Vault.

**Koffiefontein Mine;** the third largest diamond pipe mine in Orange Free state, South Africa, since 1987 underground mining has taken place.

**Kofu;** an industry town and lapidary center in the south west of Tokyo, Japan.

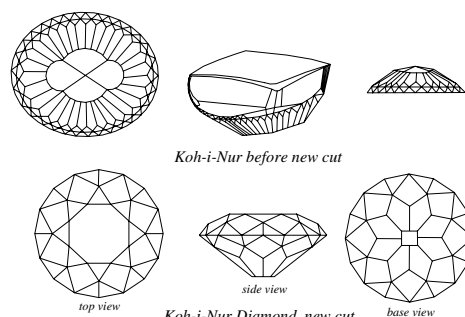
**kohalaite;** a local term for oligoclase andesites from Kohala, Hawaii.

**Kohville Diamond;** same as Theresa Diamond.

**Koh-i-Noor;** → Koh-i-Nûr Diamond.

**Koh-i-Noor Diamond;** → Koh-i-Nûr Diamond.

**Koh-i-Nûr Diamond;** Persian (Farsi) word meaning the *Mountain of Light*. An Historic Indian diamond of rose-type cut of 186 cts. In 1304 it was owned by the Rajahs of Malwa, later, it was in the possession of the Mogul emperors Baber ( Also known as Baber's Diamond) and remained in the hands of subsequent Mogul emperors, including Shah Jahan (Jahan), and Aurangzib (1658-1707). It was shown by Aurangzib to Tavernier in 1655. Nadir Shah of Persia invaded India in 1739, seized the diamond and the original Peacock Throne and went back to Isfahan, Persia. After the death of Nadir Shah it was returned to India and came into the hands of Ranjit Singh Lion (or Tiger) of the Punjab in 1833. The stone was put in the treasure house of Lahore, when that state was annexed to the British Empire. In 1849 the stone was taken by the East India Company in partial indemnity against their losses and



*Koh-i-Nur Diamond before new cut and after new cut*

later presented to Queen Victoria in 1850. The stone was recut in 1852 into a 108.93 cts, oval-shaped diamond, when incorporated in the British Crown Jewels in the Tower of London. In 1937, it was set in the front of the circlet of the Queen Mother's Crown. The weight of the rough stone was believed to be 787.50 cts. Also spelled Koh-i-Noor, Kuh-i-Noor, Koh-i-Nûr, Kuh-I-Nûr.

**Koingnaas;** location of alluvial diamond deposits along the coast on Namaqualand, South Africa. Diamonds are

to found among paleo-marine and fluvial placers.

**Kola peninsula;** a peninsula in North West Russia between White and Barents seas.

**Kollen garnet;** same as kollin garnet.

**Kollin garnet;** an almandine garnet from Kollin, Bohemia, the Czech Republic. Also spelled Kollen garnet.

**Kollur Diamond;** a diamond of 63 cts, that is said have been bought by Tavernier in 1653 at Kollur Mines, Golconda, India.

**Kollur Mines;** location of a group of ancient Indian diamond mines in the south of kingdom of Golconda, where several historical diamonds were found, including Koh-I- Nûr, and Orloff Diamond. → Golconda.

**Kollur workings;** → Kollur Mines.

**koloriscop;** a specially-designed standard light box for determination and judging the whiteness of diamonds. It consists of an ultraviolet radiations source in the top of box for checking fluorescence. Made by Eickhorst, Germany.

**Komsomolsky Diamond;** a large rough diamond of unknown weight, in the Russian Diamond Fund, Moscow.

**Kona dolomite;** dolomite from Kona, Michigan, USA. Rarely used for fashioning large objects but is prized by collectors.

**Kongo emerald;** a misleading term for diopside from Congo. Another spelling for Congo emerald.

**Königsberg;** a German term for the Kaliningrad between Russia and Poland.

**Koninklijke Asscher Diamond Maatschappij;** same as Royal Asscher Diamond Company.

**Kono District;** an alluvial diamond-bearing area in Sierra Leone, Africa.

**konoscope;** a polariscope used for investigation of the behavior of double-refractive properties crystals under strongly convergent polarized light. Interference patterns obtained are important in explaining crystal optical characters. → Interference figures, polariscope.

**konpi;** a Burmese (Myanmar) term for red or brownish jadeite. → Jadeite colors in Burmese.

**knotted;** same as spotted.

**kopi;** a term used by Australian miners for a variety of gypsum, which sometimes carried good-colored opal.

**Kopje;** an African term for areas of yellow ground that were minute flat hills, associated with the top of a kimberlite pipe. An Afrikaans term for small head or hillock. Also known as koppie.

**Kopje walloper;** → Kopje walloping.

**Kopje-walloping;** a slang term used in the early days in South Africa to describe a diamond dealer or buyer of rough diamonds. Also spelled Kopje walloper.

**koppie;** same as kopjes.

**Koppiesfontein;** location of a small diamond mine in Orange Free State, South Africa.

**Koppiesvlei;** location of a small gravel diamond mine in Transvaal Province, South Africa.

**koranna stone;** a dark gray variety of pyrophyllite, used for ornamental objects. Also known as *South African wonderstone* and *Ottosdal G stone*. Found near the village Ottosdal in western Transvaal. Not to be confused with Nevada wonderstone.

**Korea jade;** a misleading term for bowenite serpentine. Also spelled Korean jade.

**Korea jade;** a misleading term for artificially colored steatite or other minerals. Also spelled Korean jade.

**Korea jade;** a mislabeled term for antigorite. Also spelled Korean jade.

**Korea jade;** any glass imitation used as a jade imitation. Also spelled Korean jade.

**Korea jade;** a term used for various impure jades. Also spelled Korean jade.

**Korea jade;** a term used incorrectly to refer to antigorite. Also called new jade or Soochow jade.

**Korean Gemmological Institute;** same as Gemmological Association of Korea.

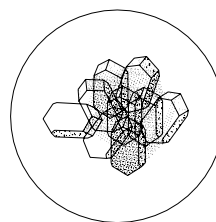
**Korean jade;** same as Korea jade.

**Korgon Mountains;** location of fine quartz crystal bearing mountains in Tomsk province, Siberia, the Russian Federation, CIS.

**korite;** a commercial term for iridescent fossilized ammonite shell. It is a variety of *fire marble* or *lumachella*. It crystallized like aragonite in orthorhombic system with the formula of  $\text{CaCO}_3$ , same as aragonite. It is transparent to translucent. Vitreous to resinous luster. White, shades of green and red with highly iridescent. Streak: colorless. Optics;  $\alpha$ :1.512-1.528,  $\gamma$ :1.662-1.762. Birefringence: 0.150. SG:2.80-2.95. H:4. Found as fossil ammonite shell in Alberta, Canada. Used in jewelry for triplets with quartz topaz and shale or man-made spinel. Also called calcentine. → Aragonite.

**kornelian;** same as carnelian.

**korerupine;** a rare valued gemstone. Occasionally shows chatoyancy or asterism and is strong dichroic, green to yellow to reddish brown. It was cut cabochon or faceted but prized by



*zircon crystals in korerupine from Malagasy*

collectors. Star korerupine are found in Myanmar and cat's-eye korerupine are found in Sri Lanka. Korerupine from Saxony, Germany is unnecessary

named *prismatine*.

System: orthorhombic.

Formula:  $4[(\text{Mg,Fe}^{+2})_3\text{Al}_6(\text{Si,Al,B})_5\text{O}_{21}(\text{OH})]$ .

Luster: vitreous.

Colors: colorless, white, pink, greenish yellow, blue green, dark green, brown, black.

Streak: colorless.

Diaphaneity: transparent to translucent.

Cleavage: {110} perfect.

Fracture: conchoidal to uneven. Brittle.

SG: 3.28-3.35.

H:6½.

Optics;  $\alpha$ :1.662-1.665,  $\beta$ :1.672-1.678,  $\gamma$ :1.674-1.678.

Birefringence 0.013.  $\ominus$ .

Dispersion: 0.018.

Found in Southwest Greenland, Kenya, Tanzania, Sri Lanka, Myanmar, Malagasy, South Africa, and Canada.

**kornerupine absorption spectrum;** in kornerupine the absorption spectrum shows several weak bands at 549, 503, 463 and 446 nm, and a band at 503 nm can be detected.

**kornerupine cut;** faceted as gemstone and rarely cut cabochon of brown gem quality from Myanmar, and Sri Lanka, and greenish from Malagasy material.

**kornerupine luminescence;** stones from Sri Lanka shows no luminescence but those green gemstones from Myanmar exhibit pale yellow under SWUV. Stones from East African in SWUV and LWUV.

**kornerupine pleochroism;** pleochroism is visible to the naked eye. From Greenland; dark green, light blue, reddish blue. From Sri Lanka and Malagasy; brownish green, yellowish brown. From Kenya and Tanzania; bluish green, emerald green, reddish purple, reddish blue, greenish yellow.

**kornerupine rough;** gemstone qualities are from Greenland, Kenya, Tanzania, Sri Lanka, Myanmar, Malagasy, and Canada.

**koropepe jade;** a Maori term used by native of New Zealand for a spiral cut form carved on jade for ornamental purposes or amulet.

**korowell;** a Ceylonese (Sri Lanka) commercial grade of deformed or double pearls. Also spelled kuruval. → Vadvu, chevvu.

**Koslow I & II Diamond;** two diamonds were cut from a rough stone of unknown weight. No further information about Koslow I, but reportedly Koslow II may be the finest quality a pear cut, and weighs 20 cts. It was bought in 1961 by Nat Koslow of New York City, USA.

**kosmochlor;** a mineral of pyroxene group. Frequently occurs with jadeite. Monoclinic system. Formula:  $4[\text{NaCr}(\text{Si}_2\text{O}_6)]$ . Emerald green. Transparent to

translucent. Cleavage: {110} good. Optics;  $\alpha$ :1.766,  $\gamma$ :1.781. Birefringence: 0.015. SG:3.60. Found in Coahuila, Toluca, Mexico. Also called ureyite.

**Koss treatment;** a method developed in Israel to improve the diamond clarity. Using stable, transparent material to fill surface-reaching enclosures. → Filled diamond.

**kotaki;** a local term applied to a variety of jadeite in typical association with albite in a country rock of sheared serpentinite, found in Kotaki district, Niigata, Japan.

**kothway;** a Burmese term used for the finest ruby of pigeon's-blood or pigeon's-eye. → Corundum classification in Myanmar.

**Kott-Dar-El-Kouti;** location of an alluvial diamond deposits area along the Kotto River in the Central African Republic.

**Kotto River;** → Kott-Dar-El-Kouti.

**kou;** a Chinese term for carved buckle made of jade.

**Koyle's Kopje;** location of a minor diamond deposit in the Kimberly area, South Africa.

**Kraal;** a term used by Boer in South Africa for a hut or group of huts for housing native diamond miners.

**Kramleegte;** alluvial diamond deposits along the coast on Namaqualand, South Africa where diamonds are to dug from among paleo-marine and fluvial placers.

**Krandall Diamond;** a golden yellow cushion-cut diamond of 40 cts, belonging to Sidney Krandall. It has an unusual cut of 114 facets, of which 56 are on the girdle.

**krantzite;** a variety of fossil retinite resembling amber, found in small yellowish grains disseminated in brown coal in Saxony, Germany and Baltic area.

**kreittonite;** a black variety of gahnite with the impurities of ferrous iron or ferric iron, or both.

**Kirshna River;** a diamond bearing river of ancient India. The gravel tracts of Krishna and Gunter district have been famous since ancient times. The working deposits can still be seen in alluvial, palaeochannels, coluvium, conglomerates and terraces. Formerly spelled Kistna.

**Kristall;** a Russian diamond manufacturing concern. Also spelled Crystal, or Krystall.

**krokidolite;** → crocidolite.

**Kromellenboog;** location of a small alluvial diamond deposit in the Christiana area, Transvaal Province, South Africa.

**Kruger Diamond;** an alluvial diamond of 200 cts, from South Africa. It was named to honor Paul Kruger statesman and President of Transvaal. It was cut into two pears of 30 cts, and a marquise of 10.50 cts.,

**kruisworker;** → cross worker, cross cutter.

**Krupp Diamond;** an emerald-cut, VS<sub>1</sub> diamond of 33.19 cts, belonged to the ex-wife of a German

industrialist, which was purchased by Richard Burton in 1968 for his wife Elizabeth Taylor.

**kryptomere**; same as aphanite.

**krypton laser**; same as krypton ion laser → Laser.

**Krystall**; same as Kristall.

**Kt**; an abbreviation for karat.

**K.T.N.**; an acronym for colorless niobium doped with potassium tantalate used as a diamond simulant. RI:2.27. SG:6.43. H:6. Also spelled KTN.

**ku**; a Chinese term used for a vase with an open end carved on jade. → Chinese ritual and symbol jades.

**kuan**; a Chinese term applied to head-cover or head-cup made of jade used to cover hair.

**kuan**; a Chinese term applied to a carved tube made of jade.

**kuan chi**; a Chinese term applied to a carved cap pin made of jade used by men.

**kuang**; a Chinese term used for an open ewer or bowls, sometimes carved on jade. → Chinese ritual and symbol jades.

**Kuan Yin**; a Chinese term used for a common popular Buddhist female figure carved on jade is one of the Bodhisattvas which may represent asexual reincarnation of future is calling Buddha Avalokitesvara meaning compassionate Buddha. → Chinese ritual and symbol jades.

**kudatama jade**; a Japanese term used for a peculiar cylindrical-shaped bead carved on jade.

**kueh**; a Chinese term used for a broken ring or broken semicircle made of jade. Also called tie. → Chinese ritual and symbol jades.

**kuei**; a Chinese term for carved tablet in different forms resembling agriculture implements made of jade used by feudal as present to Emperor and used for worship the god of the East. → Chinese ritual and symbol jades.

**kuei ritual jade**; a Chinese term used for a flat blade-shaped, which is normally tapered of green color at one end to symbolize the wood and reverence to the East. → Chinese ritual and symbol jades.

**Kuen-Lun Mountains**; the Capitol city of the Mongolia in East Central Asia. Believed to be a source for nephrite (jade) for the carving industry in China. Formerly known as Urga. Also spelled Kulun.

**kui dragon**; a Chinese term for a small, primitive dragon usually made of bronze. Sometimes carved of jade.

**Kuh-I-Noor**; → Koh-i-Nûr.

**Kulun**; → Kuen-Lun.

**kumst**; an East Prussian (German) dialect for cabbage or sauerkraut.

**kumst amber**; same as egg yolk amber.

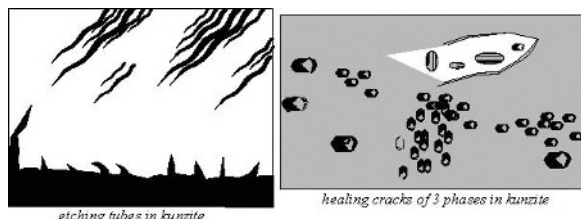
**kumst colored amber**; same as egg yolk amber.

**Kunsthistorisches Museum, Vienna**; one of the famous jewels, gems, art collections, included the Crown Jewels of the Austrian Hapsburgs Royal Family.

**kunzite**; a term applied to pinkish, light-violet to lilac-colored, transparent variety of spodumene. Used as gemstone. Found in Malagasy, California, North Carolina, South Dakota (USA), Minas Gerais (Brazil), Myanmar, and Afghanistan. Also misnomerly called Californian iris.

**kunzite cleavage**; → spodumene.

**kunzite inclusions**; in some kunzites there are seen wavy parallel tube formed etching inclusions and



*inclusions in kunzite*

healing cracks of three phases.

**kunzite cut**; faceting in various shape. → Spodumene.

**kunzite rough**; → kunzite, spodumene.

**kupfernickel**; a German term for niccolite.

**kural**; a Ceylonese (Sri Lanka) term for the grading of pearls, which means very small and misshapen, deformed, or double pearls. → Korowell, kuruval.

**kurand**; an origin Hindu term for corundum. → Corundum, names of.

**Kurf**; → kerf.

**Kuri Bay**; a bay in Western Australia where the Japanese cultured blister pearls techniques with the large oyster *Pinctada maxima* have been used.

**kurnakovite**; a hexaborate mineral Trimorphous with inderite and inyoite. Strong pleochroism. A suitable mineral for collectors. Produced synthetically. Also sometimes spelled kurnakowite.

System: triclinic.

Formula:  $2[\text{MgB}_3\text{O}_3(\text{OH})_5 \cdot 5\text{H}_2\text{O}]$ .

Luster: vitreous, pearly on cleavage.

Colors: colorless, pink, coated white on surface.

Streak: colorless.

Diaphaneity: transparent.

Cleavage: {010}, good, and {001} indistincts.

Fracture: conchoidal to uneven. Brittle.

SG: 1.86.

H:3-3½.

Optics;  $\alpha$ :1.488-1.491,  $\beta$ :1.508-1.511,  $\gamma$ :1.515-1.525.

Birefringence: 0.017-0.022.  $\ominus$ .

Found in Inder lake, Kazakhstan, Russia.

**kurnakowite;** → kurnakovite.

**Kurnool diamond;** diamond location 90 km from the city of Kurnool, State of Andhra Pradesh south of Hyderabad, India. Diamond are found in the Banaganapalle conglomerate which is a basal member of the sedimentary of Jirnool group. The main deposits are located along the western fringe of Guddapah Basin. Tavernier mentioned it for first time about 1665-1669. Kurnool is often mistakenly spelled Karnul.

**kurskite;** same as staffelite, carbonate-flourapatite, carbonate-apatite, satellites.

**kuru jade;** a Maori term used for pencil shaped pendants made of nephrite or greenstone from New Zealand. Also known as jade hammer.

**kurupapu jade;** a Maori term used for flattened gem piece made of nephrite or greenstone from New Zealand.

**Kurupung River;** a river in Guyana, Africa, along which are located a few alluvia diamond deposits.

**kuruvinda;** a Hindu term, some authorities believed that rubicelle spinel may also be called kuruvinda. Also yellow corundum of Kalpur, Sri Lanka is called kuruvinda.

**kutnavorite;** a carbonate mineral isomorphous with dolomite. Formula:  $\text{Ca}(\text{Mn},\text{Mg},\text{Fe})(\text{CO}_3)_2$ . SG:3.12. H:3½-4. Also spelled kutnohorite. → Dolomite.

**Kutnohorite;** → kutnohorite.

**kuruvall;** a Ceylonese (Sri Lanka) term for the grading of deformed, or double pearls. → Korowell, kuruvall, vadivu.

**Kuskamana;** location of a diamond deposit at the Vaal fields, South Africa.

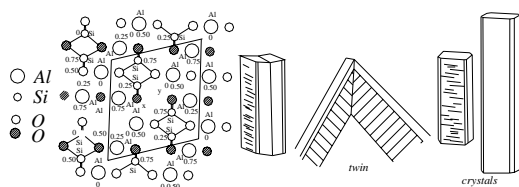
**Kwango;** same as Cuango.

**Kwan Yin;** fine carved Buddha statue from jade in the time of Ming and Ch'ing in China.

**Kwanza River;** same as Cuanza River.

**Kyabra Hills;** location of an opal-bearing area in Queensland, Australia.

**kyanite;** trimorphous with andalusite, and sillimanite. A



kyanite structure, crystals, twin and hardness directions

suitable mineral for collectors. Also called *disthene* because of its differences hardness in different

directions. Sappare or sapper is a blue color kyanite, also spelled cyanite. The white variety is named as *rhaetizite*. It looks like cat's-eye, when cut cabochon.

System: triclinic.

Formula:  $4[\text{Al}_2\text{SiO}_5]$ .

Streak: colorless

Colors: blue, gray, green, yellow, pink, or nearly black.

Pleochroism: white, violet-blue to cobalt blue.

Luster: vitreous to pearly.

Diaphaneity: transparent, translucent to opaque.

Cleavage: {100} perfect, and {010} distincts.

SG: 3.53-3.67.

H:4-7½. (7 across width, and 5 across length).

Optics;  $\alpha$ :1.712-1.718,  $\beta$ :1.722,  $\gamma$ :1.727-1.734.

Birefringence: 0.017-0.022.  $\ominus$ . Chromium-kyanite up to 0.033.

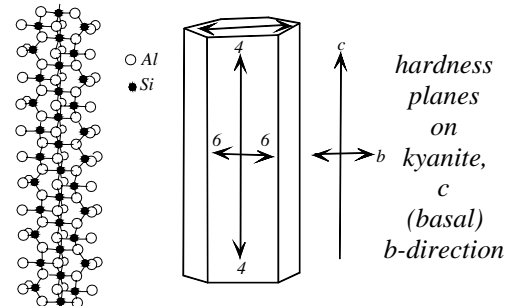
Dispersion: 0.020.

Found in India, Sri Lanka, Myanmar, Brazil, Tanzania, Russia, Zaire, Kenya, Mozambique, North Carolina, Vermont, Virginia, Georgia, Massachusetts (USA), Italy, Switzerland, Korea and Australia.

**kyanite absorption spectrum;** lines in red at 706, 689, 670, 446, 433 nm and 2 lines in deep blue at 600 nm.

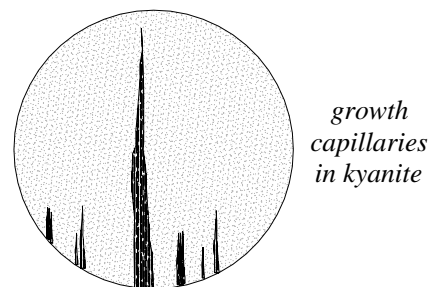
**kyanite cut;** rarely faceted in step-cut.

**kyanite hardness;** hardness in kyanite varies according to crystallographic direction, cyanite has three different



hardness in three different crystallographic directions: 4.5, 6, and 7.

**kyanite inclusions;** there are some growth capillaries in form of cedars to see.



**kyanite pleochroism;** pleochroic in three direction.

Variable fluorescence, often weakly red under SWUV.

Sometimes in shades of yellow-green to green.

**kyanite rough;** suitable minerals for facet-grade are



from Kenya, Brazil, and North Carolina.

**kyanos;** another synonym for turquoise in ancient Greek.

**kyauk ame;** a Burmese (Myanmar) term for green to black jadeite. → Jadeite colors in Burmese.

**kyauk-ame;** in East Indian for black variety of jadeite.

**kyauk atha;** a Burmese (Myanmar) term for translucent white jadeite. → Jadeite colors in Burmese.

**kyauk-atha;** in East Indian for white translucent jadeite.

**kyauk-me;** in East Indian for dark stones at the Myanmar ruby mines.

**ky-outing;** a term used by Australian miners for a cutting in form a hill side. Also known as underlying.

**Kyropoulos synthesis method;** a method of synthetic crystal growth, which is a variation of the Czochralski pulling process.

**Kyushu;** an important island in southern Japan for the cultivation of pearls because its warm waters.

# L I

**l**; a symbol for one of the Miller indexes in crystallography.

**λ**; lambda a symbol for wavelength.

**La**; a chemical symbol for the element Lanthanum.

**laanilite**; a very coarse-grained variety of pegmatite, containing quartz, biotite, garnet, and iron ore minerals.

**labdanum**; a kind of resin of dark color obtained from Old World Plants used as substitute in perfumery industry and fixative. Also spelled ladanum and known as rock rose. → Arctic Ocean amber.

**la beau pearls**; a commercial name for imitation pearls.

**labeling of imitation ambers**; to protect the customer from the fake and imitation amber, German Government proclaimed that because the law any various articles of amber imitation manufactured in Germany must be labeled with the sign synthetic or imitation.

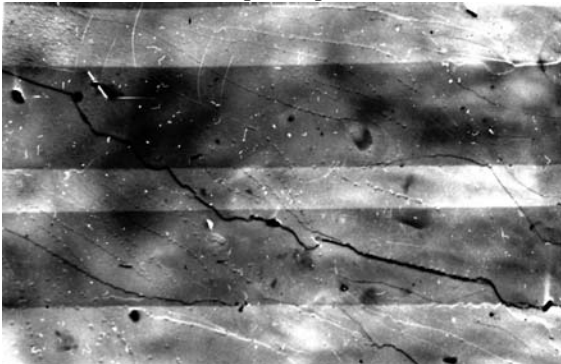
**La Belle Helene Diamond**; a diamond of 160 cts, of exceptional fine-quality found in 1951 in alluvial deposits on the Orange River, South Africa. It was owned by Romi Goldmuntz and named after his wife. Cut into two pear shapes of 30.38 and 29.71 ct and a marquise of 10½ cts.,

**labile**; a condition of a supersaturated solution, which changes state with heat and radiation.

**labite**; a silicate mineral of  $MgSi_3O_6(OH)_2 \cdot H_2O$ . It may be chrysotile.

**labradite**; another synonym for labradorite.

**labradorescence**; an optical phenomenon of brilliant



*labradorite lamellae, an electron-microscope photo*

*2000x from author*

change of multi-vivid-color seen in some labradorite

and spectrolite feldspars. When it is moved about in reflected light (because of changing the angle of incident light), repeated twinning lamellar structures within the stone selectively reflect certain colors, resulting in a series of vivid colors such as blue, green, red, gold, gold-brown, yellow, and peristerite with a delicate blue iridescence on grayish to brown body color when the angle of incident light change. Internally lamellar twinning structures in labradorite caused by exsolution of two feldspars with slightly different compositions. When the thickness of lamellae and periodicity in a stone are within certain limits, reflected light from this stone create an *iridescence* effect. Synonym: change of color. → Schiller.

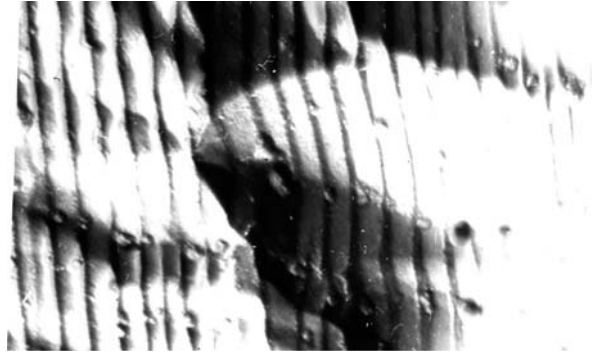
**labrador feldspar**; another term for labradorite.

**labrador feldspar stone**; another term for labradorite.

**labradorfels**; another term for labradorite.

**labrador hornblende**; another term for hypersthene.

**labradorite**; a variety of plagioclase feldspar with beautiful optical phenomenon of change of multi-vivid-colors suggestive of the Northern lights, when moved about in reflected light, which is called *labradorescence*. The usual color is in various shades of blue. A transparent variety is found in Utah, Oregon, New Mexico, USA. *Spectrolite* is a labradorite from Finland. Colorless transparent labradorite feldspar darkened by needlelike inclusions misnomerly called *black moonstone*. Labradorite occurs in basic and intermediate igneous rocks. Often used for ornamental



*labradorite lamellae, an electron-microscope photo*

*16.000x from author*

purposes and in building, and occasionally cut into cabochon and oval forms with a smooth surface and has been carved as cameo. Also called labrador stone, labrador spar, labrador rock, labrador feldspar, labrador feldspar stone, opaline feldspar. A variety is known as lynx eye, and lynx eye labradorite. → Albite, anorthite, schiller, and iridescence.

System: triclinic.

Formula:  $Ab_{50} An_{50} - Ab_{30} An_{70}$ .

Luster: vitreous.

Colors: dark colored blue, gray, brown, green, yellow, red orange, and bronze.

Streak: colorless.

Diaphaneity: transparent to translucent.

Cleavage: {010} perfect, {001} perfect and {110} less perfect.

Fracture: conchoidal to uneven. Brittle.

SG: 2.69-2.77.

H: 6-6½.

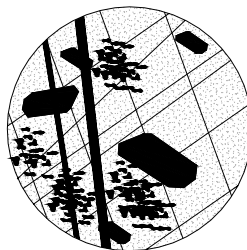
Optics  $\alpha$ : 1.559,  $\beta$ : 1.563,  $\gamma$ : 1.571.

Birefringence: 0.012. ⊕.

Found in Labrador, New York, Texas, Modoc County, California, Utah, Nevada, (USA), Finland, Malagasy, and Australia.

**labradorite cut**; rarely cut as cabochon and oval from fine blue or dark gray ground quality, which is found in Finland. Vivid colors on pale gray groundmass from Malagasy material, and various colors on gray ground from Labrador, and those from Utah, Oregon, New Mexico, USA, are cut as faceted gems for collectors.

**labradorite inclusion**; in some labradorite sample from Labrador found a few needles of zircon.



*zircon  
needles  
in  
labradorite  
from  
Labrador*

**labradorite rough**; → labradorite.

**labradoritite**; an igneous rock from the gabbro clan composed almost entirely of labradorite and clinopyroxene. Also called labradite, and labradorfels.

**labrador moonstone**; a translucent labradorite variety of plagioclase feldspar from Malagasy with fine bluish adularescence.

**labrador rock**; another term for labradorite.

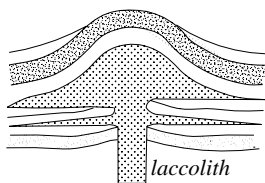
**labrador spar**; another term for labradorite.

**labrador stone**; another term for labradorite.

**labret**; an ornament made of precious metal worn through a piercing in the lower lip.

**laccolite**; same as laccolith.

**laccolith**; an intrusive, dome-like concordant igneous body with a more or less flat floor and postulated dike-like feeder under its thickest point. Also called flooded intrusive body, cistern rock and spelled



laccolite. Obsolete: laccuolite.

**laccuolite**; → laccolith.

**lac dye**; a related dye to kermes obtained from a cactus feeding insect. Used as dyes.

**lace agate**; a blue and white banded chalcedony (agate), in which the bands are zigzag and resemble the scallops of lace edging. Found in Mexico. Also called blue lace agate, and crazy lace agate.

**Lace Mine**; location of a minor diamond deposit in Johannesburg, South Africa. Also called Crown Mine.

**lacquer**; a synthetic colored lacquer, or other substance made of resins, plastics, asphalt, etc., soluble in ethyl alcohol, used for coating of thin-skinned cultured pearls and other objects.

**lacquerback**; pavilion of some transparent or translucent genuine stone or imitation stone been covered with colored lacquer, or other substances to change or to improve its color. When imitation stones have been treated or covered with colored lacquer, or other material this is called imitation lacquerback.

**lacquered mother-of-pearl beads**; to improve appearance of some mother-of-pearl beads, the surface of such bead is lacquered which give a four-spot radiogram similar to nucleus of cultured pearl with luminescence glow.

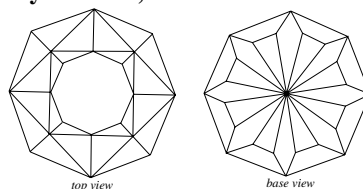
**lacquering cultured pearls**; to improve appearance of some thin-skinned cultured pearls, the surface of such pearl is lacquered.

**lactoid**; a commercial term for casein plastic.

**ladanum**; same as labdanum.

**Ladward-juj**; the name of the stream near lapis lazuli mine in Badakhshan, Afghanistan.

**ladybird cut**; a modified 8-sided brilliant cut with 24 trigonal facets and a large 8-edged table in the crown. Pavilion has 24-faces without culet, 8-facets from the



*ladybird cut. After Hartley*

center having the form of a 8-rayed star.

**laevorotatory**; → levorotatory.

**La Favorite Diamond**; a fine-quality diamond of 50.28 cts, it was owned by a Persian. Present whereabouts unknown.

**laguang yu**; a Chinese term for green waxy nephrite used as jade

**laguna pearls**; a commercial term for imitation pearls.

**Lahore Royal Treasury**; a famous treasury of jewels belonged to Maharajah Duleep Singh (1837-1893), son of Ranjit Singh or Tiger of the Punjab (1780-1839). This treasury was sold in 1850-1851 by an auction under British Government in India. Also called Royal Treasury of Lahore. → Jewels of India.

**Lai-Thai ruby**; a commercial name used by Thailand

gem dealers for a fine yellowish-red ruby with numerous liquid fingerprints and feathers as internally blemishes and poor clarity. Frequently termed as bluff stones. The term Lai is meaning design or motif similar to Thailand silks or other fabrics.

**lake**; a general term for organic pigments produced by the interaction of an oil-soluble organic colorant and an absorptive inorganic compound. Whole compound is insoluble in water, but oil-soluble organic colorant is a precipitant agent. Used as dyes and metal decorative coating substance.

**Lake Biwa**; a lake in Shiga Province, Japan, where the cultured fresh-water pearl-farming industries are located.

**lake dyes**; a general term for pigments such acid-ionic anthraquinone and azo dye (alizarin red), and acid green 12. The oxide layer of metal can dying with inorganic substances such as with ferric ammonium oxalate give gold color and cobalt acetate with potassium permanganate will give bronze color.

**Lake George diamond**; a misleading term for colorless, doubly terminated quartz crystal from Herkimer County, New York, USA.

**Lake Guatavita**; → Caciques of Guatavita.

**Lake Superior agate**; reddish, brown, and greenish banded agate from Lake superior, Canada.

**Lake Superior agate**; a misleading term for banded thomsonite from same region.

**Lake Superior fire agate**; a misleading term for a glass imitation of opal.

**Lake Superior greenstone**; a misleading term for chlorastrolite.

**Lalatema Mine**; a green grossularite garnet mine in Tanzania, Africa.

**laliq**; a fine lead crystal made by Lalique Company in France, it has a satiny or frosted appearance.

**Lal Qila Diamond**; an improved green, round brilliant diamond of 72.76 cts, was repolished to 70.10 cts. Purchased by King Farouk of Egypt in 1951. Present owner unknown.

**lamachella**; same as fire marble.

**lambda**;  $\lambda$  a symbol for wavelength.

**lambreu**; a term used in Brazil for irregular diamond fragments.

**lamella**; a long, narrow plate, blade or thin-sheet.

**lamellar crystal**; the term applied to a crystalline structure or habit composed of straight thin layers, plates, scales, or lamellae, disposed in layers like the leaves of a book. This effect can be seen in labradorite and moonstone and the pheromones are called labradorescence or adularescence. Synonym: lamellate. Also called lamellar structure.

**lamellar ligament**; a bundle of ligament of a bivalve

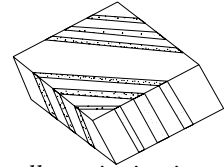
mollusk characterized by lamellar structure of fibrous tissue.

**lamellar pyrite**; same as marcasite.

**lamellar stellate**; having or consisting of lamellae arranged in groups resembling stars.

**lamellar structure**; any plate-like crystal. Same as lamellar crystal.

**lamellar twinning**; a structure with twinning parallel to crystal planes within grains of crystals such as plagioclase feldspars or calcite. Also called lamellar twinning structure, polysynthetic twinning, repeated twinning.

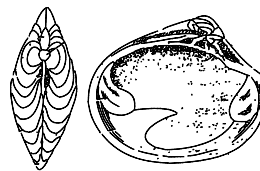


*lamellar twinning in calcite*

**lamellar twinning structure**; → lamellar twinning.

**lamellate**; composed of or arranged in lamellae. Same as lamellar.

**lamellibranchiata**; a general name for class of bivalve mollusks of natural pearl oysters, which includes edible oyster, edible mussel, cockle and all other marine pearl-bearing animals. The name refers to



*lamellibranche*

characteristic plate-like gills.

**laminae**; the thinnest separable plates, sheets or layers in crystals, usually, but not always, of repeated or polysynthetic twinning.

**laminae**; a thin sheet or coating lying over another, as in certain minerals.

**laminare**; a rock or mineral in plate form consisting of several different layers bonded by or cemented together, which is separated or split into thin layers.

**laminated**; consisted, or formed of, or set in thin parallel layers. → Laminare.

**laminated glass**; same as laminated safety glass.

**laminated quartz**; a term applied to the vein quartz characterized by slabs or films of other substance, or generally to a quartz with ribbon or book structure

**la mouche Cantharides**; → Cantharides.

**lamping**; in prospecting use of a portable ultraviolet light to detect fluorescent minerals.

**lamprobolite**; → basaltic hornblende.

**lamproite**; a coarse-grained, ultramafic igneous rock of mica-peridotite occurring in volcanic pipes, dikes, and sills tends to be stem-like, but curve out into a bell shape at the top, which is the host rock of diamonds. Containing leucite, more or less glass. Primary minerals are olivine, sanidine, apatite, phlogopite, spinel, clinopyroxene. Lamproite is the host rock of diamonds.

Lamproite is one of only two rocks known as diamond matrix, the other is kimberlite.

**lamproite pipe;** → lamproite.

**lamprophyre;** any of a heterogeneous group of dark gray to black, basic rocks, in which dark minerals occur both as phenocrysts and in the matrix, but light minerals occur only in the groundmass. Colored minerals such as biotite, hornblende, pyroxene, and olivine occur in two generations, both early as phenocrysts and later in the groundmass, while the light minerals such as potassium feldspar, plagioclase, analcime, melilite are restricted to the matrix or groundmass.

**Lampsilis;** a species of pearl-bearing sand shell. → Sand shell.

**lana philosophica;** same as flowers of zinc

**Landak River;** location of an early diamond-bearing area on the island of Kalimantan, Borneo, Indonesia. → Kalimantan Mine.

**landerite;** an ornamental marble containing pink or rose-pink variety of grossular garnet in a groundmass of a white or creamy limestone. Found in Xalostoc, and Morelos region, Mexico. Also called xalostocite, and rosolite.

**landscape agate;** some white or gray variety of moss agate or chalcedony containing irregular, dendritic colored inclusions, which arranged resembling a landscape. Also called scenic agate, moss agate. → Fortification agate, ruin agate, deccan agate.

**landscape marble;** a popular term for a Jurassic marble or argillaceous limestone comprising a light gray-colored rock, having dark brown or black matter distributed as to be imitate a landscape or forests. Also called Cotham marble, forest marble. → Ruin marble or Florentine marble.

**landscape nephrite;** some varieties of nephrite in various colors which suggesting natural patterns or scenes.

**langbeinite;** an evaporate rare mineral from marine water, a few colorless stones are cut as cabochons. It has greenish luminescence under LWUV.

System: cubic.

Formula:  $4[\text{K}_2\text{Mg}_2(\text{SO}_4)_3]$ .

Luster: vitreous.

Colors: colorless, gray, greenish, yellowish, pink, violet.

Streak: colorless.

Diaphaneity: transparent to translucent.

Cleavage: none.

Fracture: conchoidal . Brittle.

SG: 2.83.

H: 3½-4.

RI: 1.536.

Found in India, Mexico, Canada, North Germany, Austria, Carlsbad and New Mexico, USA.

**Langhoogte;** location of alluvial diamond deposits on the Buffels River in Namaqualand, South Africa. This area is known as Buffels Inland Complex.

**langite;** an emerald-green variety of chalcantite occurs in copper gossan.

**lanthanides;** → rare-earth metals.

**lanthanum;** a silver-white, malleable, ductile metallic element in the third group of the Periodic System, belonging to the rare earth group with the symbol La.

**lanthanum glass;** an optical glass with high refractive index, and low dispersion, used for lenses.

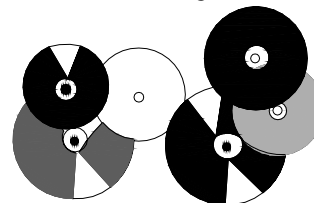
**Lantian-jade;** a term used incorrectly to refer to antigorite from Lantian, China.

**Lan Ts'ai-Ho;** a Chinese term used for a human symbol carved on jade as a dressed woman (uncertain she or he) carrying flower basket and singing songs of immortality. → Chinese ritual and symbol jades.

**Lao Kan C'hing jade;** a Chinese term for bluish jade.

**Lao Kan Huang jade;** a Chinese term for dark yellow jade.

**lap;** a flat horizontal revolving diamond-dust impregnated disk of metal, wood, or other material, usually 31 to 46 centimeters (12 to 18 inches) in diameter used by lapidaries for grinding and polishing diamonds and other gemstones. For diamond polishing



*different material laps for polishing*

the lap is made of cast iron and is known as scaife or mill. For colored gemstones gun metal, lead, pewter, wood,

cloth-covered, leather-covered disks are used, etc. Usually running at 2,000 to 5,000 rev/min. Also called loopkring, mill, scaife, skaaf, skeif, scaive, or skaif.

**lap;** any vertical lap charged with fine powder used in jewelry for polishing of jewels.

**laper;** an impure sandy limestone. Also spelled leaper, or leper.

**lapidarist;** an expert on gems and precious stones and the art of cutting and engraving them.

**lapidary;** a craftsman who cuts, polishes, and engraves colored gemstones, other than diamonds. Also called lapidist.

**lapidary;** a worker who cuts, and polishes diamonds is known as a diamond cutter.

**lapidary;** the art of cutting, polishing, and engraving of precious stones other than diamonds.

**lapidary work;** the method used by the lapidary for cutting and polishing colored gemstones other than diamond is called lapidary work.

**lapidist;** → lapidary.

**lapilli**; minute, lithic or glassy rounded pieces of lava ejected from a volcanic vent during explosive eruption, they are similar to volcanic bombs but smaller range mostly from 1 to 64 millimeters in diameter. An individual fragment is called lapillus. Also called lapillite.

**lapillite**; same as lapilli tuff.

**lapillus**; a stony or glassy lava fragment of 1.27 to 3.81 cm in diameter → lapilli.

**La Paz pearl**; a common commercial term for mostly slate-blue, black, grayish, bronzy and sometimes white pearls of fine-quality from the Gulf of California and Pacific coastal waters of Mexico, Guatemala, Venezuela, and Central America. Also called Panama pearl.

**La Paz pearl**; a term applied to bronze colored pearls from the hammer-head mollusks of genus *Malleus*.

**La Peligrina Pearl**; same as La Pellegrina Pearl.

**La Pellegrina Pearl**; a beautiful, perfect rounded, silvery transparent sheen pearl of 28 cts, or 11 1/2 grain, from India, brought the 18<sup>th</sup> century to Moscow, Russia. Also spelled La Peligrina Pearl. → La Reins de Pearls.

**La Peregrina Pearl**; a pear-shaped pearl of 58.50 ct or 234.00 grains (11.7 grams) found in ca.1554 in the Panama Gulf, it was presented to Philip II of Spain in 1560. It was mounted in a gold ball with diamonds and an inscription by Soy La Peregrina. After it passed down through a few hands in 1969 bought Richard Burton and presented to his wife Elizabeth Taylor. Also called Philip II Pearl, and The Incomparable. Also misnomered as Peregrina Pearl, or Pellegrina Pearl

**lapidary**; a handbook about precious stones and the art of cutting them. Such as encyclopedic work named after Isidore of Seville, which also known as *Etymologiae*. Also called *Etymologiae of Isidore*.

**lapidary**; a person who cuts all other gemstone except diamond.

**lapidary of Marbodus**; a poem book about precious stones lore written by Marbod Bishop of Rennes (≈1035-1123) up to Marbod's time. Rennes a city in northwest of France.

**lapidol**; a trade term for white polishing paste.

**lapis**; a Latin term for stone.

**lapis**; an abbreviation trade term for lapis lazuli.

**lapis ardens**; a Latin term for amber.

**lapis atracius**; same as verde antico. → Brecciated serpentine.

**lapis colored synthetic spinel**; synthetic spinel colored blue by cobalt, used as an imitation for lapis lazuli. RI: 1.725. SG: 3.52.

**lapis crucifer**; a term for an interpenetrated twin variety of staurolite, which shows as an + or X. Used as a curio

stone, without cutting or fashioning, for amulets, charms, and rosaries.

**lapis cured hallucinations**; there believed that frozen variety of lapis lazuli cure hallucinations.

**lapis, false**; → false lapis.

**lapis hematite**; same as red hematite.

**lapis imitation**; → lapis lazuli imitation.

**lapis lazuli**; an attractive, massive, complex aggregate of several blue minerals, it consists chiefly of lazurite, haüyinte, which gives it color, also sodalite, noselite, and flecks of pyrites in a matrix of calcite. It belongs to the sodalite group or feldspathoids. Valued as a gem to cut cabochon, or flat and never faceted due to its poor luster. It is prized by collectors and by some jewelers for inlaid decoration. Under LWUV light, it shows spots or streaks of an orange or copper-red. The stone is frequently heated to improve the appearance. Synthetic and imitations lapis-lazuli are made. Imitations lapis-lazuli are made by blue-dyed jasper, or agate, which is traded as *Swiss lapis*, *German lapis*, *sintered synthetic spinel*, blue glass containing spangles, stained bone, blue plastics with pyrite spangles, and blue ceramic ware are easily to distinguish. *Gilson-synthetic lapis lazuli* is an imitation stone. Some lapis lazuli is dyed to improve the color. In ancient times, it was known as sapphire. Also called lazurite, lazurspar, ultramarine, Armenian stone, lazurstone, lazule, and lazuli.

**lapis lazuli**; an ultramarine-colored serpentine from India.

**lapis lazuli**; an old term for lazurite, but now used specially for the gem variety.

System: cubic.

Formula:  $(\text{Na,Ca})_8(\text{Al,Si})_{12}\text{O}_{24}(\text{S,SO}_4)$ .

Luster: dull to semi-vitreous.

Colors: azure blue, deep blue, greenish-blue, purple-blue, often with spangles of golden pyrites, and white patches of calcite.

Streak: light blue, blue.

Diaphaneity: semitranslucent to opaque.

Cleavage: none.

Fracture: conchoidal to uneven. Brittle.

SG: 2.38-2.45, when pyrite present 2.70-2.90.

H:5-6.

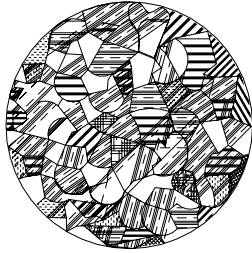
RI: 1.50.

Found in contact metamorphous rock of Badakhshan in Afghanistan, South Russia, Canada, Chile, Italy, and California, Colorado (USA).

**lapis lazuli cut**; finest gems quality are cut cabochon, some for ornamental purposes, inlay material, seal stones, beads, carved objects, or sometimes faceted.

**lapis lazuli imitation**; sintered synthetic spinel with blue color used as lapis lazuli simulant the inclusions in this case are gold grains. RI:1.725. SG:3.52. To distinguish the Chelsea filter is used, under which it

exhibit a vivid red residual color. Absorption spectrum is typical for cobalt at 650, 580, and 480 nm.



*lapis-lazuli imitation from sintered blue-spinel*

**lapis lazuli imitation;** a lapis lazuli imitation made by Gilson without pyrite sprinkles. RI:1.50. SG:2.46. H:4½.

**lapis lazuli imitation;** a term used for German lapis, Swiss lapis, blue ceramics, blue glass, lapis lazuli ware, and plastics.

**lapis lazuli luminescence;** under LWUV light it shows spots or streaks of an orange or copper-red. Pinkish under SWUV. Yellowish glow under X-rays. Sometimes whitish fluorescence under SWUV.

**lapis lazuli, rough;** the finest gem materials are from Afghanistan, uniform in color, lacks calcite. Good and fair quality from Chile.

**lapis lazuli, synthetic;** → synthetic lapis lazuli.

**lapis lazuli ware;** a variety of wedgwood, which is colored blue and marked to resemble lapis lazuli.

**lapis lazzale;** an Italian term for lapis lazuli.

**lapis lyncurius;** a term used for tourmaline or refer to amber or zircon.

**lapis matrix;** lapis lazuli containing veins or patches of white calcite.

**lapis mulieris;** same as lapis virgineus.

**lapis mutabilis;** another term for hydrophane opal.

**lapis porphyrites;** same as Egypt, porfido rosso antico, which was known as Porphyrites Leptosephos. It was later known as *stone of Rome*.

**lapis smaragdinus;** a misleading term, which rarely applied to serpentine.

**lapis virgineus;** it means *stone of women*. Emerald used as protecting amulet.

**lapped;** polished with a lap.

**lapper;** a specialist who cuts the 18 main facets of a brilliant diamond cut stone and operates with a lap. Also called blocker, and cross cutter.

**lapping;** a term applied to abrading a gem surface with an abrasive tool. The gem holding (dopstick), against a horizontal lap (made of metal, steel and cast iron), with an abrasive grit of silicon, aluminum oxide or sometimes diamond powder, which is wet with water as a lubricant. Grinding begin with a coarse grit and proceeds step for step to finer grits until the surface of

gemstone has a frosty finish, which is now ready for polishing. Lapping is used for flat facets or surfaces of gemstone or large ornamental objects because the lap is unyielding for curved surfaces. → Sanding.

**lapping;** same as blocking.

**Laranjeiras-aquamarine;** an aquamarine of fine quality of 12 kg was exhibited in National Museum in Rio, stolen 1915 and sold in 1935. Whereabouts is unknown.

**Laranjeiras-aquamarine;** an aquamarine of fine quality of 7.87 kg from Brazil, sold in 1935. Whereabouts is unknown.

**Laranjeiras-aquamarine;** a cut aquamarine of fine quality of 1.285 cts, was cut by Oscar Machado. Whereabouts is unknown.

**Laranjeiras-aquamarine;** a cut aquamarine of fine quality of 910 cts, was cut by Oscar Machado. Whereabouts is unknown.

**Laranjeiras-aquamarine;** a cut aquamarine of fine quality of 293 cts, was cut by Oscar Machado. Whereabouts is unknown.

**lardite;** a synonym for agalmatolite, figured stone.

**lardite;** a massive talc (steatite, soap stone). Also called lard stone, figured stone.

**lardite;** a white hydrated silica mineral, probably a variety of opal from Russia.

**lard stone;** synonym for massive talc (steatite), figured stone.

**large band-gap semiconductor;** substances with large band-gap such as pure and colorless diamond with 5.4 eV, no visible spectrum of light can be absorbed because this substance is colorless. Also called energy gap.

**La Régente Pearl;** a fine round oriental pearl of 27.50 cts, was stolen in the robbery along with other French Crown Jewels in 1792. Also spelled Regent Pearl.

**La Reine des Belges Diamond;** a cushion-shaped diamond of 50 cts. Belonged to the Queen of Belgium in 19<sup>th</sup> century, it is believed to be a gift from her mother. It was repolished into a 40 cts, emerald cut. The Belgium Royal Family may be the present owner. Also spelled Reine des Belges Diamond, La., and called Queen of Belgium Diamond, or Reine Diamond

**La Reins de Pearls;** a perfect rounded pearl of 28 cts, or 11½ grain, from India, stolen in 1792 from French Crown Jewels. Believed to be renamed as La Pellegrina Pearl.

**La Reine Diamond;** same as Queen of Belgium, La Reine de Belges Diamond.

**larger goods;** sorted diamond over one carat.

**larimar;** a local commercial term for a massive blue variety of pectolite from Dominican Republic, South America. It is an igneous rock. Also commercially

called as Atlantis stone, jewel of the Caribbean.

**lariat;** same as sautoir.

**larimar;** a local commercial term for pectolite from Dominican Republic.

**Larkin's Flat;** location of an early small alluvial diamond deposit in the Vaal River, South Africa.

**La Rose Diamond;** same as La Rose Pink Diamond.

**La Rose Pink Diamond;** a flawless, pink-colored, marquise fashioned diamond of 7.07 cts. Also called La Rose Diamond.

**larvikite;** a nepheline-bearing syenite with abundant phenocrysts of anorthoclase feldspar or crypto-perthite with a fine blue schiller from Larvik, Norway. Very popular as an ornamental stone, when cut and polished, generally used for building materials. Also spelled laurvikite. Synonym: blue granite. Also misnomered as blue pearl.

**Lasarev Diamond;** also spelled Lazarev Diamond. → Orloff Diamond.

**lasca;** a term applied to a type of twinning-free synthetic quartz from Brazil.

**laser;** an acronym for light amplification by stimulated emission of radiation. A device that emits UV to infra red electromagnetic energy, that is a nearly parallel, nearly monochromatic (single wavelength), and coherent beam of light of very restricted diameter formed by causing exiting atoms to radiate their energy in phase. Laser systems have been used in gemology specially to improve the clarity grade of diamonds by laser drilling technique. Small portable laser device are filled with noble gases such as neon (ion), argon (ion), krypton (ion), sometimes carbon oxide. Frequently cadmium is mixed with noble gases. → Laser drilling of diamonds.

**laser beam;** a bright narrow beam of coherent, nearly parallel, powerful, and nearly single wavelength (monochromatic) electromagnetic radiation emitted by a laser.

**laser crystal;** a laser device with a coherent light source, which is a solid crystal of gem-quality ruby.

**laser cutting;** kerfing of rough diamonds with laser. Cleaving of a kerfed is simple and called splitting. The shaping of diamonds with a laser in any direction making the fashioning of fancy cuts easier. Also lasers can be used to create engraving or inscription patterns or letters usually on girdle of diamonds.

**laser drill-hole;** the hole in a gemstone or diamond generated by a laser beam. → Laser, filled diamond, laser drilling.

**laser drilling;** a device used for enhancing the appearance of imperfect diamonds by drilling, in which a concentrated beam of a laser produces intense heat for burning tiny holes less than 0.00025 cm in diameter

into the inclusions of gemstones, metals, and other hard materials.

**laser drilling of diamonds;** a device have been used to improve the clarity grade of diamonds with black inclusions, This is carried out by drilling a fine hole less than 0.00025 cm in diameter, down to the inclusion with a laser beam. A special bleaching agent such as hydrofluoric acid is introduced into the hole of the inclusion to whiten it. This channel often cannot be seen with lens, but by low-power binocular microscope by means of dark-field illuminators. Frequently seen as a V. Also called laser treatment, lasering, lasered diamond. → Filled diamond.

**lasered diamond;** → laser drilling of diamonds.

**laser fingerprinting;** a commercial device with the name Gemprint, which produce a fingerprint identification photo of a cut-diamond. → Gemprint.

**laser gem;** a commercial name for a doublet with a synthetic sapphire crown and strontium titanate pavilion, used as a diamond imitation.

**laser goniometer;** a goniometer used to measure the angle with a bright narrow beam of coherent, nearly parallel, powerful, and nearly single wavelength (monochromatic), electromagnetic radiation emitted by a laser apparatus.

**laser inscription;** for identification of diamonds, lasers can be used to engrave or inscription patterns or letters usually on the girdle of diamonds.

**laser kerfing;** → laser cutting.

**laser photography;** → Gemprint.

**laser ruby;** synthetic ruby for laser. → Laser crystal.

**lasering;** → laser drilling of diamonds laser drilling.

**laser sawing;** dividing of rough diamonds regardless of crystal orientation with laser. It can easily and safely saw naats or intergrown crystals.

**laser treatment;** → laser drilling of diamonds.

**lasionite;** same as wavelite.

**lask;** → lasque.

**laske;** → lasque.

**la spica turginis;** a fabulous assign to bring emerald to the constellation of sagittarius (spica virginis) with symbolic color flammeus or flame-colored. → El can mayor.

**lasque;** a thin flat, tabular diamond crystal with a simple facet at the side used by Indian cutters. Also spelled lask, or laske. Also called lasque diamond.

**lasque;** same as table cut, bevel cut, or portrait stone.

**lasque diamond;** → lasque.

**lasselite;** same as palygorskite.

**lassenite;** a term for unaltered volcanic glass.

**Last Hope;** location of a small alluvial diamond deposits in the Barkly West, Cape Province, South Africa.



**La Tausca pearls;** a commercial term for imitation pearls.

**latent image;** small amounts of impurities emulsion by ionization of molecules such as sulfur in a crystal, which active centers sensitive, realized the non-detectable image when exposure to light.

**lateral axis;** same as lateral crystal axis. → Lateral axes.

**lateral axes;** horizontal axes in a tetragonal, hexagonal, trigonal, and orthorhombic crystal system, which are at right-angles to the principle axis. → Crystal axes.

**lateral plane:** same as lateral crystal plane.

**lateral axis;** same as lateral crystal axis. → Lateral axes.

**laterite;** a white to cream to red residual clay produced in humid tropical, and subtropical conditions of good drainage by the weathering of igneous rocks, usually of basic composition. Contains some silica, particularly of iron oxides and hydroxides and aluminum hydroxides. It is related to bauxite. Obsolete term: latosol.

**laterite bauxite;** a white to cream bauxite.

**latex in imitation opal;** in imitation opal latex is used instead of silica spheres, by which the stone is lighter, just above 1.00.

**lathi;** a Myanmar (Burmese) weight equal  $1.15/100$  cts.

**Lathlike inclusions;** a term applied to lathlike-shaped inclusion which occurs between mica cleavage planes parallel to *c*-axis (001), that may be an explanation for the *splitting* of ends of some tourmaline crystals because of mica and also presence of mica in tourmaline. Another sample of lathlike inclusion is intergrowth of golden-brown or yellow dravite with pyrrhotite and chalcopyrite and rarely with galena, sphalerite or pyrite from Black Hawk, Penobscot Bay area, Mine, USA.

**laton;** same as latten.

**latosol;** an obsolete term for laterite.

**latrobite;** a pink colored anorthite from Amotik, Labrador, Canada.

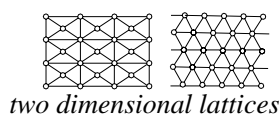
**latten;** an alloy like brass made of varying base metal. Also called laton.

**lattice;** same as growth lattice.

**lattice;** same as space lattice.

**lattice;** same as crystal lattice.

**lattice;** in crystallography a regular pattern, in which atoms, molecules, and ions are arranged three dimensionally in crystal structure responsible for external shape, physical and optical



two dimensional lattices

properties. The smallest complete lattice is called a cell. → Crystal lattice, space lattice, growth lattice.

**lattice, atomic;** same as atomic crystal structure of diamond. Also called lattice parameter, or parameter.

**lattice constant;** in crystallography a parameter defining the unit cell of crystal lattice that is the length of edges or the angle between the axes of the unit cell of a crystal. It is usually the edges length of a cubic unit cell. Also called lattice parameter.

**lattice defect;** → Lattice,-defect in.

**lattice,-defect in;** crystal lattice defect is usually describe as *color center*, where an electron or ion has been trapped. Hole centers in crystals that are formed by a negative ion vacancy with two bound electrons, which subsequent the color of minerals is known as *F center*. → Color center.

**lattice framework;** a term used to tiny bohemite needles confused with rutile silk which are lies in the basal plane of crystal and running in all directions across the stone which appear similar as lattice framework. Also known as mother nature's erector set.

**lattice parameter;** same as lattice constant.

**lattice, space;** → space lattice.

**lattice structure;** one of the three types of lattice structure: (a) *ionic lattice*, with symmetrically arranged ions and is a good conductor; (b) the *molecular lattice* arranged of covalent molecules usually volatile and nonconducting; (c) *layer lattice*, with large ions each associated with two small ones, forming nearly laminae or layers held by nonpolar forces and is therefore, easily split into thin sheets. Also called mesh structure, net structure.

**lattice vibrations;** a periodic vibration of atoms or molecules in a crystal lattice due to absorption energy, which vibrate small and medium sized parts of atomar or molecular framework about their mean equilibrium positions. When a lattice have medium weight atoms the structure held together by medium strength bonds therefore considerable low vibration frequencies such as colorless beryl shows only absorption occur far out in the infrared part of spectrum at low frequencies. Also no absorption of visible light however the beryl will be colorless. Also called lattice vibration of beryl. → Overtone, channels.

**lattice vibration of beryl;** → lattice vibration.

**laticcino;** an opaque, white or semi-white decoration glass first produced in Venice, Italy during the Renaissance, often used threads of glass embedded in its surface. Also spelled laticcino.

**laticcino;** → laticcino.

**lat yay;** a Burmese (Myanmar) term for cloudy jadeite. → Jadeite colors in Burmese.

**lauanite;** a hydrous silicate of aluminum and calcium similar to stilbite.

**Laué;** corrupt spelling of Laue.

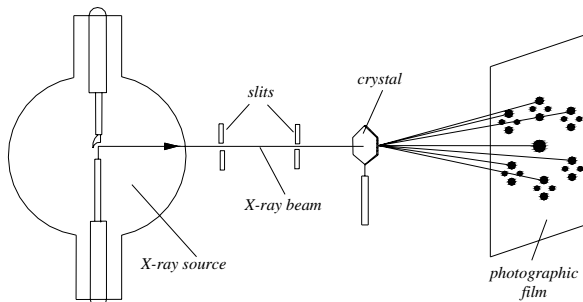
**Laue diagrams;** → Lauegrams.

**Laue diffraction;** an X-ray method used to identification between natural and cultured pearls.

**Lauegrams;** a term applied to the Laue photographs or diagrams. A characteristic X-ray spots pattern used in the analysis of minerals, gemstones, pearls, crystal symmetry and distinguishable between natural and cultured pearls, when the pearl is not drilled. The pattern is produced by the diffraction of X-ray beam. Also called Laue pattern. → Laue method.

**Lauegrams of pearls;** → Lauegrams.

**Laue method;** a method of X-ray diffraction in the analysis of crystal structure, used a single, fixed crystal



*X-ray Laue-method*

irradiated by a beam of a continuous spectrum of X-ray, the spots pattern produce is called X-ray diffraction. It gives information about the crystallographic symmetry of the material structure. Also called Lauégrams.

**Laue pattern;** same as Lauegrams.

**Laue photographs;** → Lauegrams.

**Laue spot;** any spot on a photograph or diagram of Lauegram.

**loughlinite;** → meerschaum.

**laurelite;** greenish-golden idocrase from Laurel, Quebec, Canada. Sometimes cut from apple green cryptocrystalline material from Pulga, California, USA.

**laurelite;** greenish granular, fibrous or radiating material composed from olivine and anthophyllite. Found in corundum deposit in Georgia, USA.

**laurvikite;** same as larvikite.

**lava;** the molten, fluid or semi-fluid rock mass pouring out of volcanoes and fissures, which consolidates on the surface or on the floor of the sea. It may be glassy, vesicular, or porphyritic in texture, and varies between basic and acidic composition. Some specimens are cut into cameos, cabochons, and intaglios. The term lava is correctly used only with reference to volcanics. Also called crateral magma.

**lava;** a term used frequently by Gilson for flux-fusion synthetic emerald mass.

**lava breccia;** same as volcanic breccia.

**lava cameo;** an opaque, fine-grained, gray, or brownish-

yellow colored marble, mounted in brooches or bracelets. Frequently it is made from glass.

**lava dome;** a flattened dome-shaped volcano.

**lava emission;** same as lava eruption.

**lava jewelry;** objects of jewelry cut cabochon or in the form of cameo or intaglio, carved in a variety of colors coming from the fine-grained lava from Mt. Vesuvius in Italy. The colors vary from pale shade, gray to brownish-yellow. → Lava cameo.

**lava millstone;** a coarse and hard millstone found in Rhine River, Central Europe.

**lava stalactite;** an inverted conical body formation of lava descending from the roof or walls of a lava vent funnel or cavity, which is developed by the dripping of lava.

**lavatory;** a work place where gold is obtained by washing.

**lava ware;** objects or utensils made from iron slag, which resembled the lava in appearance.

**lava spine;** same as lava stalagmite lava. → Lava stalactite.

**lava stalagmite;** inverse of lava stalactite.

**lavender oil;** an essential oil used in ceramic industry to apply colors in certain enameling for the surface of utensils.

**lavender jadeite;** artificially coloring of white or gray jadeite to green or lavender, which shows similarity to *imperial jade*, which may reveal dye concentration on surface by reflected light in small pits and fractures.

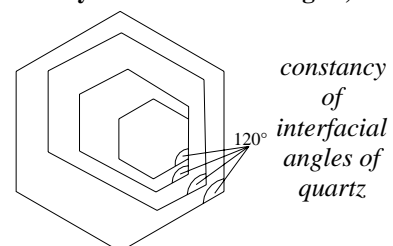
**lavendrine;** same as amethyst quartz.

**lavenite;** a mineral with the chemical formula:  $(\text{Na,Ca})_2(\text{Mn}^{+2},\text{Fe}^{+2})(\text{Si,Zr,Ti})_2\text{O}_7(\text{F,O,OH})_2$ . Monoclinic crystal system. Colorless to light yellow. Translucent. Vitreous luster. Perfect cleavage: {100}. SG:3.51-3.55. H:6. Found in Norway, Brazil, and Sierra Leone.

**lavernite;** a misleading commercial term for a variety of synthetically produced periclase (MgO).

**Lavras Series of rocks;** a rock series of diamond-bearing region in Brazil, which consist of conglomerates, phyllites and sandstones, in which diamonds are found. This series overlaid the Itacolumy Series.

**law of constancy of interfacial angles;** the angles

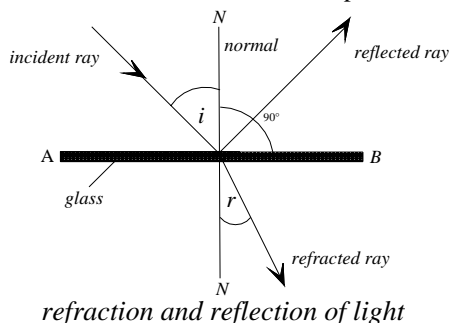


between corresponding faces on different crystals of one chemical composition have a constant value.

**law of reflection;** when a ray of a light incidents a smooth surface of separation of two different media, some is reflected in the plane containing the incident wave and the normal to the surface at the point of incidence. The angle of incidence ray is equal to its angle of reflection.

$$\theta_{\text{refl}} = \theta_{\text{inc}}$$

The reflected ray and the normal of the surface at the point of incidence are all in the same plane. Also called



reflection of light, reflection, and reflection law.

**law of refraction;** a phenomenon of light, which changes the direction of propagation of wavefronts, when a ray of light crosses a boundary between two media, in which its phase velocity differs. The angle of the refraction is equal to the ration of the velocity of the ray in the first medium to the velocity in the second medium. Also called Snell's law, refraction law.

**law of refraction;** the incident ray, the refracted ray, and the normal to the surface at the point of incidence are all in the same plane.

**Lawrencium;** a transuranic element of the Periodic System with the symbol Lw.

**lawsonite;** a rare gemstone. Frequently cut as gems.

System: orthorhombic.

Formula:  $4[\text{CaAl}_2(\text{OH})_2(\text{Si}_2\text{O}_7)\cdot\text{H}_2\text{O}]$ .

Luster: vitreous to greasy.

Colors: colorless, white, gray, purple, pale blue.

Streak: colorless.

Diaphaneity: transparent.

Cleavage: {001} perfect, and {100} perfect.

SG: 3.08-3.12.

H:7-8.

Optics;  $\alpha$ :1.665,  $\beta$ :1.674,  $\gamma$ :1.685.

Birefringence: 0.019.  $\oplus$ .

Dispersion: high.

Found in Cuba, Italy, Scotland, Japan, France, and USA.

**lawsonite pleochroism;** distinct blue, yellow-green and colorless to pale brown-yellow, dark greenish-blue and yellowish.

**lax diamond;** an obsolete term sometimes used for diamonds with little fire and brilliance.

**laxey;** same as laxey diamond.

**laxey diamond;** a commercial term rather flat brilliant-cut diamond. Also called laxey.

**layer;** a bed stratum of rock lying in a position essentially parallel to the surface.

**layer lattice;** nonpolar bonding between successive planes, which gives marked cleavage, such as mica, graphite, clay, etc. Also called layer structure.

**layer-lattice minerals;** same as phyllosilicate.

**layered rock;** another term for nonhomogenous rock.

**layered silicate;** same as phyllosilicate, sheet silicate.

**layer structure;** same as layer lattice.

**Lazare Diamond;** a trade term for round brilliant-cut diamond chosen for color and clarity and manufactured by Lazare Kaplan, Inc. Each brilliant is engraved with laser a six-digital identification number on the girdle. Visible under 10x magnification loupe.

**Lazarev Diamond;** another spelling for Lasarev Diamond.  $\rightarrow$  Orloff Diamond.

**lazule;** same as lapis-lazuli.

**lazuli;** synonym for lapis-lazuli.

**lazulite;** a compact, pleochroitic mineral of scorzalite series. It is dichroic. Used as ornamental article and seldom cut as gemstone. Synonym for blue spar, false lapis, and berkeyite. Not to be confused with lazurite.

System: monoclinic.

Formula:  $2[(\text{Mg,Fe})\text{Al}_2(\text{PO}_4)_2(\text{OH})_2]$ .

Luster: vitreous to dull.

Colors: blue, blue-green, light blue, dark blue, azure-blue, deep violet.

Streak: white.

Diaphaneity: transparent to opaque.

Cleavage: {001} indistinct.

SG: 3.10-3.22.

H:5½-6.

Optics;  $\alpha$ :1.615-1.633,  $\beta$ :1.643-1.662,  $\gamma$ :1.652-1.672.

Birefringence: 0.033-0.039.  $\ominus$ .

Found in Austria, India, Malagasy, Brazil, Sweden, Bolivia, Angola, and USA.

**lazulite absorption spectrum;** weak line at 620, band at 516 and a line at 592 nm.

**lazulite luminescence;** under LWUV light it shows spots or streaks of an orange or copper-red. Pinkish under SWUV. Yellowish glow under X-rays. Sometimes whitish fluorescence under SWUV.

**lazulite, pleochroism;** pleochroism ranges strong from colorless to blue and deep blue.

**lazulitic;** of, pertaining to, or having the same characteristic to lazulite.

**lazurapatite;** a mixture of lapis lazuli and apatite, found in Siberia, Russia.

**lazurfeldspar;** a blue variety of orthoclase feldspar found in Siberia, Russia.

**lazurite;** a feldspathoid mineral of sodalite group, which is isomorphous of sodalite and haiyintse is the principal constituent of lapis-lazuli. Not to be confused with lazulite.

System: cubic.

Formula:  $(\text{Na,Ca})_8(\text{Al,Si})_{12}(\text{O,S})_{24}(\text{SO}_4)(\text{Cl,OH})_2$ .

Luster: vitreous to dull.

Colors: dark blue, azure-blue, violet-blue, greenish-blue.

Streak: light blue.

Diaphaneity: translucent to opaque.

Cleavage: none.

SG: 2.38-2.45.

H: 5½-6.

RI: 1.50.

Found in Italy, Labrador, Myanmar, (Burma), Chile, Russia, and Afghanistan.

**lazurite, inclusions;** brassy yellow pyrite and whitish calcite are seen in massive sample.

**lazurite, luminescence;** orange streaks or spots under LWUV, while under SWUV glows more pink. Under X-rays glows yellowish in streaks.

**lazurquartz;** a term for blue chalcedony (blue quartz). → Sapphire quartz.

**lazurspar;** another term for lapis-lazuli.

**lazurstone;** another term for lapis-lazuli.

**leaching;** a term applied to extraction of soluble metals from an ore body by means of slowly percolating solutions such as separation of gold by using cyanide solution.

**lead;** a soft, heavy, bluish-white metal found in the fourth group of the Periodic System with the symbol Pb. It was used in the Middle Ages for cheap jewelry, and is used in various alloys. As lead oxide is used in lead glass to imitate gemstones.

**lead back;** a term used by Australian miners for a translucent gray-back opal which is highly suspect to be stable, crackling, etc.

**lead chromate;** another term for crocoite.

**lead crown glass;** another term for crown flint glass.

**lead crystal;** any colorless glass, which contains a high percentage of lead oxide (27%-30%) used to increase relative high refractivity and dispersion that give the strong brilliance but decrease the hardness. When lead glass contain 30% or more lead oxide it is called *full lead crystal*. Used as a diamond imitation. → Lead glass.

**leader;** a term used by Australian miners for a stone or opal with a good trace, which may be followed to better quality of opal.

**lead dop;** a mechanical device filled with lead solder, in which the large diamond is held during polishing. →

Dop, solder dop.

**lead dioxide;** a toxic brown crystal of  $\text{PbO}_2$  used in manufacturing pigments. Also called lead peroxide, brown lead oxide, and plattnerite.

**lead feldspar;** a synthetic product:  $\text{PbAl}_2\text{Si}_2\text{O}_8$  with the feldspar structure. No counterpart exist in nature.

**lead germanate;** → germanates.

**lead glance** another term for galenite.

**lead glass;** any colorless glass, which contains a high percentage of lead oxide about 27%-30% to increase relatively high refractivity and optical dispersion that give the strong brilliance but decrease the hardness. It can doped with color agents. To make opaque glasses opacifier may be added. Often used for gem and diamond imitation and cut glass, refractometer sphere, and radiation shielding. Also called flint glass, strass glass, paste, and lead crystal. → Crown glass, strass, beryl glass, thallium glass, borosilicate glass.

**lead leady;** a term used by Australian miners for opal of good color quality but having dully, leaden finish.

**lead molybdate;** a yellow, toxic powder with the formula  $\text{PbMoO}_4$ , insoluble in water and alcohol but in nitric acid. The natural counterpart is wulfenite.

**lead oxide;** a bright, both yellowish red to red lead of  $\text{PbO}$  or  $\text{Pb}_3\text{O}_4$ , used in glass or as glazes in pottery and enamel batches. Also called red lead, lead tetroxide, triplumbic, lead tetroxide and minium.

**lead peroxide;** → lead dioxide

**lead spar;** same as cerussite.

**lead spar;** same as anglesite.

**lead sulfuret;** same as galenite.

**lead tetroxide;** same as lead oxide.

**lead tungstate;** a yellow synthetic stone with the formula  $\text{PbWO}_4$ . The natural counterpart is stolzite a mineral of scheelite group, dimorphous with raspite.

**lead vitriol;** same as anglesite.

**lead white;** a general term for lead carbonate, lead hydroxy-carbonate, lead silicate, and lead sulfate, all four are basic. Used as dyes.

**leading stone;** synonym for lodestone.

**leaf;** a very thin layer of folium of a metal such as gold, usually 0.005 mm thick. It is produced by hammering a metal layer placed between layer of copper or parchment. Used for gilding.

**leaf clay;** same as book clay.

**leaf gold;** very thin layer of gold formed by beaten.

**leaf gold;** gold found in nature as thin flakes or sheets.

**leafless;** a term applied to aphyllous.

**leafy;** same as laminated.

**leakage of light;** light enters a polished gemstone or diamond, leaving the medium after internally refracting, and reflecting. Planned leakage is an

intentional if light exits from the crown. Unplanned leakage is an unintentional if light leaves from the pavilion such as *deep pavilion*. When depth the pavilion of a diamond brilliant-cut exceeds 44 percents of the average girdle diameter, it can lead to expressing the light leakage with deep pavilion may show a dark center, when looked through the table.

**lean ore**; low-grade ore.

**lean pipe**; a kimberlite diamond pipe in South Africa but not profitably.

**leaper**; → laper.

**lea stone**; layered sandstone.

**leatherstone**; same as mountain leather or a variety of asbestos.

**lebin**; a Myanmar (Burmese) term for a square pit, which was put down in ground to obtain rubies and sapphires.

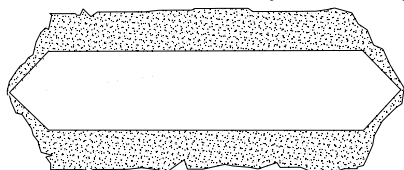
**lechatelierite**; a naturally fused amorphous silica or silica glass of formula  $\text{SiO}_2$  that is produced at high temperatures. Found in fulgurites and formed by the melting of quartz sand as a result of lightning or of the heat generated by the impact of meteorites.

**Lechleitner emerald**; → Lechleitner synthetic emerald.

**Lechleitner emerald simulant**; → Lechleitner synthetic emerald.

**Lechleitner synthetic corundum**; Lechleitner synthetic corundum and blue sapphire are made in fine colors, it is nearly inclusions free and those flux inclusions if present cause haziness produced by using of Verneuil-grown seeds. Physical properties for both corundum and blue sapphire are nearly the same. Optics;  $\omega$ :1.768,  $\epsilon$ :1.760. Birefringence: 0.008.  $\ominus$ . SG:4.00. Reddish fluorescence by SWUV and LWUV light. Pleochroic. Curved striae are present. → Lechleitner synthetic emerald.

**Lechleitner synthetic emerald**; an emerald coated beryl, in which the seed is made of pre-cut colorless beryl and the coating is a hydrothermally deposited layer of synthetic emerald by an Austria manufacture Lechleitner in Innsbruck. Later produced alternating layers of green and colorless synthetic beryl, which is called *sandwich* emerald. Constants are similar to those of natural emerald or beryl. Also called Lechleitner emerald simulant. Commercially called *symerald*,



*cross-section of Linde-Lechleitner synthetic emerald overgrowth on a thin seed of colorless beryl. After Sinkankas 1981*

hydrothermal overgrowth.

**lechosos opal**; a variety of precious opal having deep green and red play of color, especially from Mexico.

**LED**; an acronym for light-emitted diode.

**ledge**; any narrow zone of mineralized rock.

**Ledo Frozen Fire**; a commercial term for colorless man-made corundum. Used as a diamond imitation.

**Lee Diamond**; an octahedron diamond of 4.50 cts, found in 1900 in Alabama, was displayed by the American Museum of Natural History, New York City, USA. It was stolen in 1964.

**Leeuwbosch**; location of a small alluvial diamond deposit in the Bloemhof Area, Transvaal Province, South Africa.

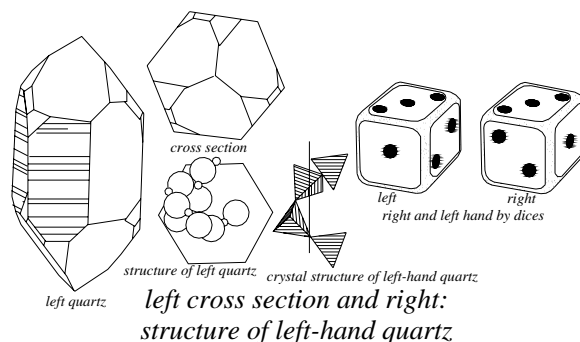
**Leeuwfontein**; location of a small alluvial diamond deposit in the Wolmaransstad Area, Transvaal Province, South Africa.

**Leeuwkraal**; location of a small alluvial diamond deposit in the Ventersdorp Area, Transvaal Province, South Africa.

**left hand (crystal)**; → optical activity, left quartz.

**left hand quartz**; same as left quartz. → Optical activity.

**left quartz**; an optically active quartz crystal, which rotates the plane of polarization of light to the left,



when light passed parallel to the *c*-axis. Also called left hand quartz. → Optical activity.

**Le Grand Condé Diamond**; same as Grand Condé Diamond.

**Le Grand Sancy Diamond**; same as Sancy Diamond.

**legend**; same as geological legend. Also called key, explanation.

**legrandite**; an extremely rare mineral of hydrous arsenate of zinc and rarely cut as gems.

System: monoclinic.

Formula:  $\text{Zn}_2(\text{OH})\text{AsO}_4 \cdot \text{H}_2\text{O}$

Luster: vitreous.

Colors: colorless to yellow.

Streak: white.

Diaphaneity: transparent.

Cleavage: indistinct cleavage.

Fracture: conchoidal to uneven. Brittle.

SG: 3.98-4.04.

H:4½-5.

Optics:  $\alpha$ :1.675-1.702,  $\beta$ :1.690-1.709,  $\gamma$ :1.735-1.740.

Birefringence: 0.060. ⊕.

Found in Lampazoz, Nuevo Leon, Flor de Pena Mine, Ojuela Mine, and Mapimi, Mexico

**legrandite pleochroism**; distinct: colorless to yellow.

**Leguminous tree**; a member of pea family plants which have fruits that are pods containing one or more pea seeds, growing in earths deficient in nitrogen, which produced recent resins in Mexico and Africa known as copal. → Leguminous tree hymenaea.

**Leguminous tree hymenaea**; a kind of plants, which producing recent resins. Found in Mexico and Africa known as copal. Amber of Mexico is from this tree resin. → Leguminous tree.

**Legziel and Sons**; an Israeli company, which generates fully automatic robots bruting machines for diamond industry.

**Leister Mine**; location of a small diamond deposits in the Barkly West Area, Cape Province, South Africa.

**leiwen**; a Chinese term for thundercloud pattern made of jade.

**Lelatema Mountains**; a source of colorless, yellow, brown and green grossular of Tanzania.

**lemanita**; Spanish term for jade.

**Lena Mine**; location of a small diamond deposit in Transvaal Province, South Africa. Also called Schüller Mine.

**lenbouk**; a Myanmar (Burmese) term for a first water grade ruby extremely four cts.,

**length of pearl necklaces**: same as pearl necklaces,-length.

**length-to-width ratio**; the ratio of the length and width of the girdle outline of fancy cuts such as emerald, marquise, pear-shape, and oval cuts, are measured by dividing the length by the width. Oval cut; 1.33-1.55:1, marquise; 1.75-2.25:1, emerald cut and pear shaped; 1.50-1.75:1. The width is always expressed as 1.

**lennilite**; a green variety of feldspar from Lenni Mills, Delaware County, Pennsylvania, USA.

**lennilite**; a variety of vermiculite mineral.

**Lennix synthetic emeralds**; a man-made flux-grown emeralds material developed by M. Lens in the De Beers Diamond Research Laboratory, Johannesburg, South Africa. Also produce four-sided crystal rather than hexagonal crystals. RI:1.556-1.562, and 1.588-1.566. Birefringence: 0.004. SG:2.65-2.65. Orange fluorescence under SWUV and red under SWUV light.

**lens**; in optics a piece of commonly transparent glass, quartz, plastic, etc., which causes the direction taken by a transient beam of light. The optical lens is a well-

polished spherical surface, convex, concave, or plane of glass used for the magnification of objects. Also used for refraction of light. Also called simple microscope. → Loupe.

**lens**; in geology any body of ore or rock thick in the middle and thinning out toward the edges all round, similar a double convex lens. → Lentil, lenticular.

**lens, Bertrand**; → Bertrand lens, conoscope.

**lens cut**; similar the buff top cut, in which the crown is cut with a series of long parallel facets, which give it a cylindrical dome-shaped top to the stone, and the pavilion is step cut. → Lentil.

**lens grinding**; a method of grinding (or pressing blanks) pieces of plane sheet-glass to correct the lens.

**lens system**; a collection of lenses or other devices, so arranged that the desired optical result such as reflect, refract, absorb, disperse, polarize, or otherwise act on light are secured. Also called optical system. → Lens.

**lente acromatic**; Spanish term for achromatic lens.

**lente aplanática**; Spanish term for aplanatic lens.

**lenticular**; of, or pertaining to a double convex lens. Biconvex or lens-shaped. Also called lentiform. → Lens.

**lenticular**; when a mass of ore or rock thick in the middle and thinning out from center to edges all around, similar a double convex lens. Also called lentiform. → Lens, lentil.

**lenticular ore**; lenticular shaped ore.

**lenticular stone**; lenticular shaped stone.

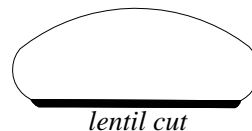
**lenticular vein**; a term applied to a lentiform vein.

**lenticule**; a minute lentil.

**lenticulite**; a petrified shell.

**lentiform**; same as lenticular.

**lentil**; a style of approximately thin cabochon lentil-shaped cut, which is nearly symmetrical about the girdle, but higher than base. This style is used for cabochon cutting of opals or other opaque minerals. Also called lentil cabochon.



**lentil**; any small ore or rock thick in the middle and thinning out from center to all directions.

**lentil cabochon**; same as lentil.

**lentil cut**; → lentil.

**lenticle**; a lens-shaped mass or fragment of any seize.

**lentil ore**; same as lironite.

**leonite**; a trade term for a colorless, white, yellowish Tibet stone (eosite) from twin towns Idar-Oberstein, and Westeregeln and Leopoldshall, Halle, Germany.

**leopard jade**; a descriptive term for a spotted jade, which resembles the characteristic leopard skin appearance.

**Leopold Diamond;** a brilliant-cut diamond of 10 cts, presented by King Leopold III of Belgium to his wife, Queen Astrid. Owned by a private collector.

**leopardite;** same as sylvite.

**leper;** → laper.

**Le Petit Coeur Diamond;** same as Petit Coeur Diamond.

**lepidocrocite;** it is often one of the constituents of limonite, goethite, akaganeite together with its trimorph. Orthorhombic system. Formula:  $\gamma\text{-FeO(OH)}$ . Luster: adamantine-metallic to dull. Colors: ruby, blood-red, reddish, yellow to ochre yellow. Streak: variable shades of orange to yellow. Translucent. SG: 3.85-4.03. H: 5-5½. It is associated with limonite in iron ores and found in meteorites. Also called glockerite, lepidokrokite, pittizite. → Goethite.

**lepidokrokite;** same as lepidocrocite

**lepidolite;** a mineral of mica group. Used as ornamental objects. Often associated with tourmaline. Also called lithia mica, lithium mica, and lithionite. Frequently is fashioned and prized by collectors.

System: monoclinic.

Formula:  $4[\text{K(Li,Al)}_3(\text{Si,Al})_4\text{O}_{10}(\text{F,OH})_2]$ .

Luster: pearly on cleavage.

Colors: light reddish, pink, purplish, yellow, white to grayish.

Streak: colorless.

Diaphaneity: translucent to opaque.

Cleavage: {001} easy.

SG: 2.80-3.30.

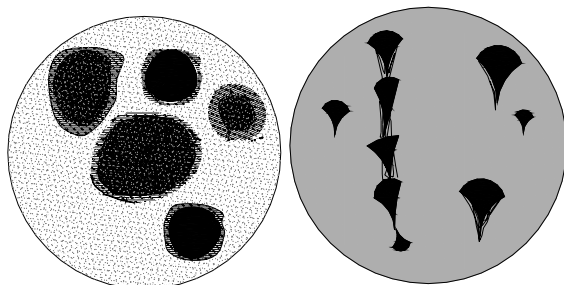
H: 2½-4.

Optics:  $\alpha$ : 1.525-1.548,  $\beta$ : 1.551-1.585,  $\gamma$ : 1.554-1.587.

Birefringence: 0.018-0.038.  $\ominus$ .

Found in California, (San Diego County), Connecticut (Portland), Maine (Auburn), USA, Sweden, Finland, Germany, Russia, Mexico, Malagasy, Zimbabwe, Japan, the Czech Republic, and Brazil.

**lepidolite as inclusions;** lepidolite healing and cracks



*lepidolite & healing cracks in zircon*

*lepidolite in palmayra amethyst*

### *lepidolite as inclusions*

can be seen as inclusions in zircon and as sequenced fungus in amethyst.

**lepidolite pleochroism;** pleochroitic: on the plane is stronger than on the cleavage.

**lepidomelane;** a black to deep-brown, iron-rich (ferric iron) variety of biotite. Also called iron mica, glist.

**lepolite;** synonym for anorthite.

**leptite;** a Fennoscandian term for granulite. A fine-grained to coarse-grained, quartz-feldspathic, metamorphic rock.

**leptomorphic;** same as xenomorphic.

**Leshem;** a biblical term for seventh stone in the breastplate of Jewish high priest, it means ligurius, probably jacinth, amber, or brown agate. Engraved with the name Joseph.

**Lesotho;** a southern eastern territory South Africa, formerly called Basutoland. In the northern part of this territory occur diamonds

**Lesotho Diamond;** a brownish-colored rough diamond of 601.25 cts, found in 1967 in Lesotho, Southern Africa. After several transfers, sold to Harry Winston in 1969 he cut it into 18 stones totaling 242.50 cts. Two emerald-cut diamonds of them weight 71.73 and 60.67 cts, one marquise-cut of 40.42 cts. Present owners unknown. Also called Lesotho Brown Diamond.

**Lesotho B. Diamond;** a diamond of 527 cts, found in 1965 in Lesotho, Southern Africa. Present owner unknown.

**Lesotho Brown Diamond;** same as Lesotho Diamond.

**Lesotho C. Diamond;** a brown rough diamond of 338 cts, found in 1969 in Lesotho, Southern Africa. It was reportedly cut into 10 stones.

**lesserrite;** same as inderite.

**Lesser Botuobiya;** same as Malaya Botuobiya.

**Lesser Namaqualand;** → Namaqualand.

**Lesser Star of Africa Diamond;** → Cullinan II Diamond.

**Lestergem;** a commercial term for man-made spinel, used as a diamond imitation.

**Letlhakane Mine;** a big area in Letlhakane in central Botswana, Southern Africa, there where are a few diamond mines.

**lethi;** a Burmese term used for corundum stones of average 1.75 cts. → Corundum classification in Myanmar.

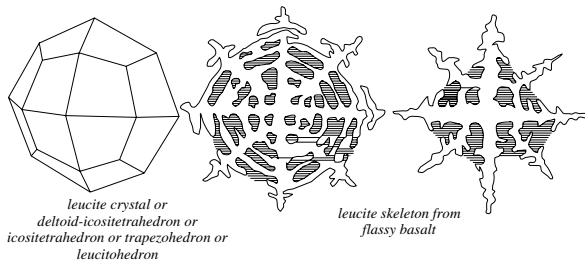
**Letny Diamond;** a rough diamond of 46.36 cts, found 1955 in Mirny, Yakutiya, Siberia, Russia. Now exhibited at the Kremlin, Moscow.

**Letseng-La-Terai diamond mine;** location of diamond-bearing deposits of Kimberly type in Lesotho, Southern Africa. Several famous large diamonds have also been found here such as Lesotho Diamond 601.25 cts, an octahedron, off-white of 155 cts, and a stone of 147 cts. Also called Letseng-La-Terai pipe.

**Letseng-La-Terai pipe;** → Letseng-La-Terai diamond mine.

**Letsho Diamond;** a misspelling of Lesotho Diamond.

**leucite**; a feldspathoid. The crystals are called trapezohedron, icositetrahedron, or leucitohedron, white garnet (which resembles garnet), vesuvian, grenatite,



*leucite crystal and skeleton from glassy basalt*

amphigene or vesuvian garnet. Sometimes cut as a gem and prized by collectors.

System: tetragonal, pseudocubic. Beautiful trapezohedron or leucitohedron crystals or skeletons are found.

Formula:  $16[\text{KAlSi}_2\text{O}_6]$ .

Luster: vitreous, greasy to dull.

Colors: colorless, white, gray, pale yellowish.

Streak: white.

Diaphaneity: transparent.

Cleavage: poor.

Fracture: conchoidal to uneven. Brittle.

SG: 2.45-2.50.

H:  $5\frac{1}{2}$ -6.

RI;  $\omega$ : 1.508,  $\epsilon$ : 1.509.

Birefringence: 0.001.  $\oplus$ .

Dispersion: 0.008.

Found in USA, Brazil, Austria, Italy, and Germany.

**leucite cut**; pale yellow to straw-yellow transparent, gem quality with the distinctive weakly fire has been cut.

**leucite luminescence**; bright-orange glow under LWUV or none. Deep-blue fluorescent under X-rays.

**leucite rock**; → leucitite.

**leucitite**; an igneous extrusive rock composed primarily of pyroxene and leucite. Also called leucite rock.

**leucitohedron**; same as trapezohedron or icositetrahedron. → Leucite.

**leucitophyre**; an igneous, porphyric, extrusive rock composed chiefly of leucite, nepheline and clinopyroxene.

**leuco**; same as vat dye.

**leucochalcite**; a discredited name equal to olivinite.

**leucocratic**; a term applied to a light colored igneous rock rich in felsic minerals such as feldspar, quartz, topaz, or mica. It contain less than 30% dark minerals. → Melanocratic.

**leucocratic mineral**; a term applied to a light colored minerals such as feldspar, quartz, topaz, or mica. Also

called light colored mineral.

**leucoindigo**; same as vat dye.

**leucophane**; same as leucophanite.

**leucophanite**; a monoclinic, glassy green to light yellow mineral of  $4[(\text{Na,Ca})_2\text{BeSi}_2(\text{OH,F,O})_7]$ . SG: 2.96-2.98. H: 4. Also called leucophane.

**leucopyrite**; same as loellingite.

**leucoscope**; a device used for testing color vision.

**leuco-sapphire**; same as colorless or white sapphire.

**leuco-sphene**; → sphene.

**leucoxene**; any decomposition product of sphene, ilmenite, rutile, or perovskite. Occurring as fine-grained, monoclinic crystal. Dull, brown, green, and yellow in color.

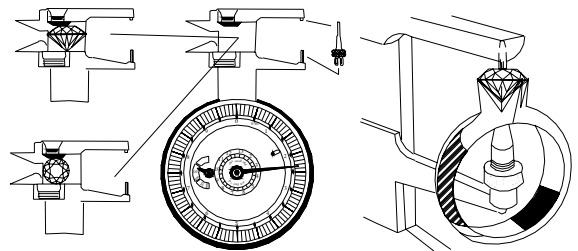
**leukorite**; another term for bakelite.

**level**; a term used by Australian miners for the depth level at which the opal may be found. Depth of levels depends between 15 to 40 meters.

**level**; a term used by Australian miners for sinking a shaft of opal dirt through into the sandstone layer from the surface.

**level**; a term used by Australian miners for horizontal band of precious opal or potch within a larger level.

**Leveridge gauge**; a small stone gauge, designed by A. D. Leveridge for determination of girdle diameter and



*Leveridge gauge measure*

the depth of both mounted and unmounted gemstones, and diamonds with an assurance of 0.1 mm. → Caliper, micrometer, Moe gauge.

**levin opal**; a variety of opal with thin, lightninglike fire features.

**Levinson Prospection**; a minute location of diamond deposit in the south terraces of the Kunene River, which is a natural frontier between Angola and South-West Africa.

**levorotatory**; in microscopy turning the plane of polarization of a polarized ray of light to the left. Also spelled laevorotatory.

**levorotatory crystal**; same as left-hand crystal.

**levorotatory quartz**; same as left-hand quartz.

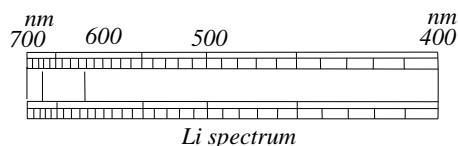
**Lewis and Clark Diamond**; a light-yellow, rough diamond of 14 cts, found in 1990 in Montana, USA. Present owner unknown.



**lewistonite**; a white, potassium-rich mineral of the apatite group. Formula:  $(\text{Na,Ca})_2(\text{Al,Si})_9\text{O}_{18}\cdot 8\text{H}_2\text{O}$ . Hexagonal. Found in Utah, USA.

**ley-kow-seet**; a Burmese term used for fourth class ruby with pale-pink color named as ley-kow-seet which mean bracelet quality. → Corundum classification in Myanmar.

**Li**; a chemical symbol for the element lithium.



**lian**; a Chinese term for a cylindrical vessel on three feet, made of jade or bronze. → Chinese ritual and symbol jades.

**Liaoning**; location of numerous kimberlite diamond mines in northeastern China.

**lias**; a lithographic stone.

**libeccio marble**; a coarse, strong red and brown colored marble in contrast with the gray limestone from Sicily, Italy, which is known as libeccio.

**Libertador Diamond**; a high-quality diamond of 155 cts, found in 1942 in the Gran Sabana diamond district, Venezuela. It is named in honor of Simon Bolivar, Liberator of Venezuela. Purchased by Harry Winston in 1943, who fashioned it into four stones: 3 emerald cuts of 39.80, 18.12, and 8.93 cts, and a marquise cut of 1.44 cts. Also spelled Liberator Diamond.

**Liberator Diamond**; → Libertador Diamond.

**Liberia**; location of a minor diamond-bearing country in North-West Africa along the Joblong River, Moro River, and Loffa River.

**Libyan desert glass**; a windworn, green, yellow, nearly pure silica glass from the Libyan Desert. Amorphous. Vitreous luster. Transparent to translucent. RI:1.46. SG:2.21. H:5½-6. Probably a tektite glass. It has innumerable irregularly shaped pores, which cause the cloudy color. Also called Libyan glass.

**Libyan desert glass, cut**; sometimes has been faceted.

**Libyan desert glass, rough**; found in Libyan desert.

**Libyan glass**; same as Libyan desert glass.

**Lichtenburg working**; a town and location of many alluvial diamond deposits in Transvaal Province, South Africa.

**Liçitaçãõ**; a Brazilian diamond promotion company.

**lick**; an informal term used by Australian miners for hydrophane opal. → Hydrophane.

**licorne**; a French term for horn-shaped object, used as a

prefix such as licorne mineral which mean odontolite, a horn-turquoise.

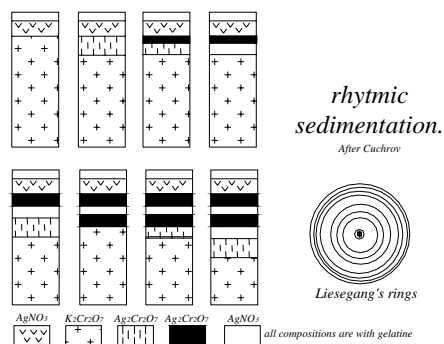
**licorne minerale**; a French term for horn-shaped mineral, which mean odontolite or bone turquoise. → Licorne.

**liddicoatite**; a brown, pink, blue, partially-colored variety of tourmaline (elbaite type). Chemical formula:  $3[\text{Ca}(\text{Li,Al})_3\text{Al}_6(\text{Si}_6\text{O}_{18})(\text{BO}_3)_3(\text{OH,F})_4]$ . Optics;  $\omega$ :1.645-1.648,  $\epsilon$ :1.622-1.623.  $\ominus$ .

**lien**; a Chinese term used for a cylindrical scroll holder carved on jade. → Chinese ritual and symbol jades.

**Liesegang banding**; → Liesegang rings.

**Liesegang rings**; colored rings or bands caused by rhythmic precipitation and diffusion within a fluid-



saturated liquid-rock or ore. Also called Liesegang banding.

**lieu pau shih**; a term used in China probably for emerald.

**lievrite**; → ilvaite.

**life**; returning the maximum of light from the gemstone to the eye from the internal- and external-reflection, is calling *life*. Life effect is dependent upon brilliance, dispersion, and scintillation in a diamond in combination with accurate design, cut, and flawless stone.

**ligament**; a bundle of strong, white, fibrous tissue serving to join bones or hold two or more organs in place.

**ligament pearl**; a fine dark brown colored, conchiolin-rich, elongated, miss-shaped sort of natural pearl, which is found near the ligament at the hinge of the bivalve mussel. Also called conchiolin-rich pearl.

**ligand**; → ligands.

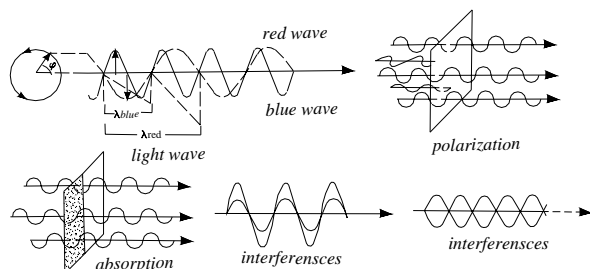
**ligand field**; in crystal field is an electric charge with the effect of the specific bonding of the ligand.

**ligand field theory**; an extension of crystal field theory, which indicates that energy levels of transitional metal ions as rare-earth ions are split by surrounding ligands. This theory explaining some optical, spectroscopic, and magnetic properties of chemical compounds.

**ligands**; in chemistry an atom, radical, ion, or molecular

polyatomic compound (a complex), the ions surrounding the central ion such as  $(SiO_4)^{4-}$  in which the central atom or Si of a tetrahedral (may be polyhedral), is surrounded by four oxygens, etc. → Coordination number, closet packing crystal.

**light;** an octave of electromagnetic radiation, to which



light wave, polarization, absorption and interferences

the organs of sight react ranging approximately from 400 (extreme violet) to 700 (extreme red) manometers and propagated at a speed of 299,972 kilometer per second or 186,282 miles/sec. It differs from wireless, heat, ultraviolet, and X-rays solely in wavelength. Light can absorbed, polarized, interference, etc. Also known as light radiation, visible radiation. Below table shows comparative wavelengths in the electromagnetic spectrum:

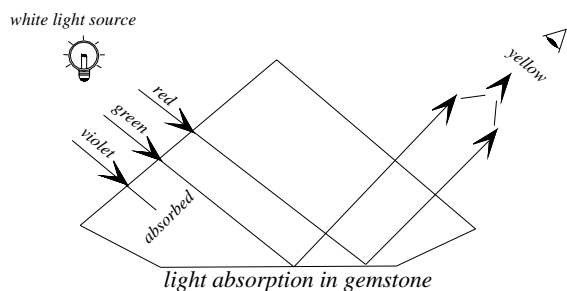
table 12: different rays and wavelengths in nm

name of rays	wavelength in nm
X-rays & gamma rays	0.005-100
ultra-violet	100-390
visible light	390-770
infra-red	$770 - 4 \times 10^5$
radio waves	$1 \times 10^5 - 3 \times 10^{13}$

**light;** same as leucocratic.

**light;** same as light opal.

**light absorption;** in optics, the reduction of the light intensity in transmission through an absorbing substance (medium) or in reflection from a surface, in



crystals, minerals and gems. Absorption may vary with

wavelengths of vibration in the direction of the transmitted light or ray (color). Also called light absorption.

**light alloys;** a general name for alloys of aluminum.

**light, amplitude of;** the maximum displacement of light from its main position in connection with vibration.

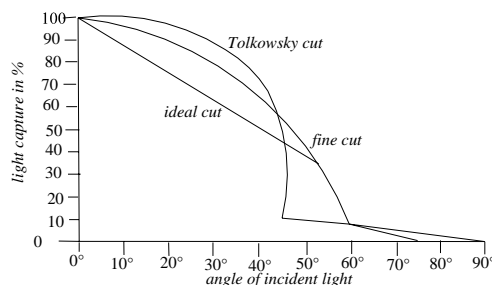
**light amplitude;** the maximum displacement of light from its main position in connection with vibration.

**light brilliance;** → brilliance.

**light brown;** a commercial color grading for polished diamonds. → Brown diamond.

**light cape;** a commercial color grading for polished diamonds with a distinct yellow tint, similar to slightly yellow in Scan. D.N. Roughly equivalent with L on the GIA color grading scale. Frequently called top cape.

**light captured by brilliant cuts;** light gain in different



light captured by brilliant-cut diamond as ideal-cut, fine-cut and Tolowsky-cut due to incidence light. After Eppeler 1973

brilliant-cut diamonds are depending from angle of incidence light.

**light carat;** diamond slightly less than one carat, usually 0.95-0.99 cts. Also called light one-carat.

**light colored;** a term applied to a rock-forming mineral, which is light in color and generally light in weight, such a rock is called leucocratic. Also known as light mineral, light colored mineral.

**light colored mineral;** → light colored.

**light concrete aggregate;** same as light-weight concrete aggregate.

**light, diffraction;** → diffraction.

**light, dispersion of;** → dispersion.

**light display;** the lighting of diamond windows are very important so that diamond is at its best, when it is lit by one point-source of white artificial light.

**light deviation method;** → direct measurement method.

**light deviation method;** same as minimum deviation method and.

**light deviation method;** Brewster's angle method.

**light, double refraction of ;** → double refraction.

**light-emitted diode;** in a materials with large band-gap energy, when energy of a semiconductor such as a diode is a recombination energy may appear as light. Also known as an acronym LED.

**lightened silver;** same as pure silver.

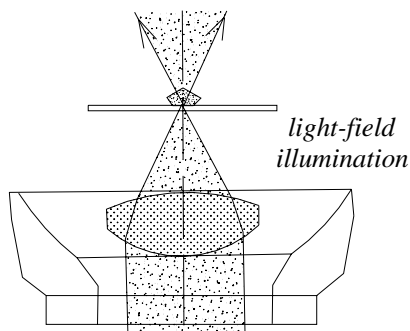
**light energy;** luminous energy.

**lighter fluid;** those light fluids that are used as cleaning agents such as benzene, toluene, lighter petrol, etc.

**lighter petrol;** light fluids with refractive index 1.49.

**light, extinction;** → extinction.

**light-field illumination;** a kind of illumination, in which the light is transmitted through the gemstone and can be



observed. → Dark-field illumination.

**light for color grading;** → koloriscop.

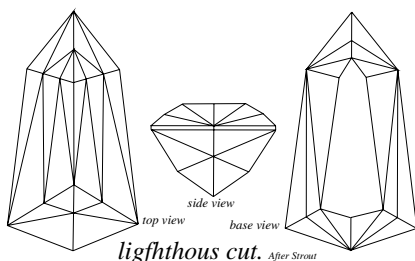
**light, frequency of;** → frequency.

**light green tourmaline;** a misleading term for peridot from Brazil.

**light guide;** same as fiber optics.

**light half;** diamond slightly less than 0.50 carat, usually 0.45-0.49 cts.,

**lighthouse cut;** a modified brilliant-cut similar to lighthouse with 24 triangular facets in the crown and 20



facets in the pavilion with a 6-sided large culet.

**light, intensity;** → color,-definition.

**light, interference of;** → interference of light.

**light, luster;** → luster.

**light meter;** a common device for measuring the intensity of incident white light. Same as exposure meters (photography).

**light microscope;** same as optical microscope.

**light mineral;** any light colored rock-forming mineral. → Light colored.

**light mineral;** any rock-forming mineral of detrital sedimentary origin having lower SG than a standard (2.85) such as feldspar, quartz, calcite, dolomite, mica, feldspathoids.

**light mineral;** any mineral with a specific gravity less than 2.85. Same as leucocratic mineral.

**light, monochromatic of;** → monochromatic light.

**lighting;** same as illumination.

**lighting;** in metallurgy means annealing.

**lightness;** → definition of color.

**Lightning Ridge;** location of black opal-bearing area at White Cliffs, New South Wales, Queensland, Australia. Opals from this locality are known as *red flame opal*. → Opal dirt.

**lightning stone;** an irregular, glassy, often tubular or rod-like structure of fused silica formed in the desert (or crust produced) by intense heat of a lightning strike. Found especially on exposed mountain tops or in dune areas or lake shores, which may measure 40 cm in length and 5-6 cm in diameter. Also called lightning tubes, lightning stone, sand tube, fused sand glass, fulgurite, fulgurite glass.

**lightning stone;** same as fulgurites.

**lightning tube;** same as lightning stone or fulgurite.

**Light of Faith Diamond;** same as Nur-ud-Deen Diamond.

**light off color;** an obsolete sorting term for rough diamonds. An obsolete commercial term for light off colored of sorting diamond.

**light off color;** a miners diamond color grading for a color better than off-color but inferior to second by.

**Light of India Diamond;** reportedly one of two diamonds of 25.50 and 12.38 cts. It is not specified, which one is Light of India, or which is the Rajah Diamond. Belonged to Mrs. Jack Gardner, Boston, USA. Sold by Tiffany's in 1886. Present owner unknown.

**Light of Peace Diamond;** a rough diamond of 434.60 cts, from Sierra Leone, Africa, found in 1960, after pear-shape cutting weighed 130.27 cts. It was one of 13 fashioned stones from a rough diamond. The other 12 weighing from 9.11 cts, to 0.37 cts. Also called Zale Light of Peace Diamond. All are unknown owned.

**Light of the World Opal;** a rough black opal of 16 ounces or 2,268 cts, found in 1928 in Lightning Ridge district, New South Wales, Australia. Fashioned into a convex-topped gem, which weighed 252 cts. The play-of-color of stone is predominately red with less features of gold and green.

**light ore;** sulfur free silver ore.

**light one-carat;** same as light carat.

**light opal;** a term used to distinguish White Cliffs opal and other Australian white opal from black opal. Also called jelly, jelly opal, light.

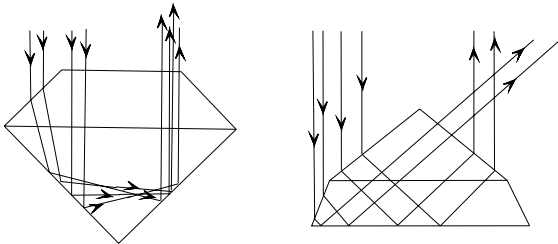
**light opal;** a term used by Australian miners for a clear, translucent variety of opal from White Cliffs, Australia. Also called jelly, jelly opal, light.

**light, opalescence;** → opalescence.

**light passing through a crystal;** when light falling on a partly transparent crystal block suffered four stage as described below:

light falling = light scattered → light reflected → light absorbed →  
light transmitted

**light path through diamonds;** the total amount of light reaching the eye, including reflections from the external surface and reflections from the internal surfaces of facets (called total internal reflection) of a gemstone, plus fire and scintillation added to both. Given equal transparency, polishing, luster, and reflection due to cutting, the gem species with the highest refractive index is the most brilliant. Brilliance depends upon the



*the path of light passing and reflecting back through a correct brilliant-cut and right through a Dutch-cut diamond*

exact cut of a transparent stone, when cut too shallow or too deep, the entering light the stone dose not reflected past the table of the stone. The term brilliance should not be confused with scintillation. The term brilliance is derived from beryl.

**light, polarization of;** → polarization of light.

**light polarized;** electromagnetic radiation that vibrates only in one plane.

**light propagation;** transmission of electromagnetic wave through a vacuum with a velocity of ca. 300.000 kilometer/sec. → Light, theory of light, wave theory of light.

**light red silver ore;** same as proustite.

**light, reflection of;** → reflection of light.

**light, refraction of;** → refraction of light.

**light return;** light reflected from the internal surfaces of a diamond or other gemstone, which return to the eye through crown of cut stone, also includes the dispersion of wavelengths.

**light ruby silver;** same as proustite.

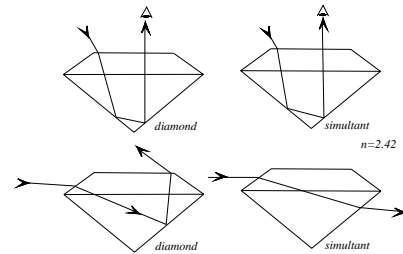
**light source;** a source of visible part of electromagnetic radiation such as sodium light, sun light, laser light, electro-light.

**light, source of;** → light source.

**light, spectrum of;** → spectrum of light.

**light, speed of;** → speed of light.

**light spill test;** a method used to determine a modern brilliant-cut diamond from a simulant. The stone is placed on a dark background, with the table facet at right-angles to the line of vision. This placement allows the pavilion facets to act as reflecting mirrors. When the stone is a diamond the uniformly bright appearance of the pavilion facets can be seen even when the angle



*light spill test of total internal reflection of light in a diamond-cut brilliant (left) and the loss of light through the back of a diamond simulant (right), comparing with the same incidence angle of light*

is less than 5-10°. If the stone is an imitation, it has a lower refractive index than diamond and upon tilting the pavilion facets furthest from the eye will begin to look black as the stone is tilted below 60°. Light spills out of these facets rather than been reflected back. Strontium titanate with refractive index of 2.41 or synthetic rutile with refractive index of 2.751 can be recognizable by their excessive dispersion or fire from diamond. Also called tilt test.

**lightstick;** a plastic tube of ca. 15 cm long and ca. 1.5 cm in diameter contain liquid of peroxyoxalate and fluorescer and in a sealed thin-walled glass tube filled off with hydrogen peroxide and a catalyst. By bending the glass tube will broken, now the mixing reacting and result is a bright light of over 12 hours depends on the temperature. By cooling in a freezer, the chemical reaction stops.

**light, total internal reflection of;** → total internal reflection.

**light, transparency of;** → transparency.

**light, ultraviolet;** → ultraviolet radiation.

**light, wave form of;** → wave form.

**light, wave theory of;** → wave theory.

**light, wavefront;** → wavefront of light.

**light, wavelength of ;** → wave length.

**light wire (fiber glass);** → fiber optics.

**light yellow;** a color classification in the Scan. D.N. color grade used by some dealers for polished diamond. Stones over 0.47 cts, in this classification shows a very pale yellow tint to the unaided eye. Equivalent to O-R on the GIA color-grading scale.

**light yellow;** a color grading for gemstone.

**light yellow heat;** a part of the color scale, appears about 1,351° C.

**ligneous;** same as woody structure.

**ligneous asbestos;** same as rock wood.  
**ligneous earth;** same as soil wood.  
**lignite;** a dull, brownish-black, woody texture, compact fossil coal intermediate between peat and bituminous coal, used as a jet imitation.  
**ligniferous;** of, or pertaining to lignite.  
**ligurite;** an apple green variety of sphene. Occasionally used as gem.  
**ligurius;** → Leshem.  
**lilac stones;** → pink stones.  
**likely;** same as kindly.  
**lilalith;** a synonym for lepidolite.  
**Lilas Amethyst;** an amethyst of 470 cts, from Minas Gerais, Brazil, named after first lady of the town Governador Valadares.  
**lily pad;** a disc form of inclusion occurring in peridot where discoidal films of liquid surround minute grains of chromite at the center. Also called lotus leaf.  
**lily pad;** a kind of stool stalagmite.  
**limaite;** a tin rich variety of gahnite from Ponto de Lima, Portugal. Containing approximately 13 % SnO<sub>2</sub>.  
**limbus;** in zoology: overlapping.  
**lime;** a solid, white to grayish chemical substance of calcium oxide (CaO), obtained by calcining limestone, dolomite, or other forms of calcium carbonate by heating. Used as polishing material. Also called calcium oxide, quick lime, hydraulic lime.  
**lime;** a cubic mineral with chemical formula CaO.  
**lime;** a commonly misleading term for calcium as component in some mineral such as carbonate of lime (calcite), lime feldspar.  
**lime;** a commonly misleading term for calcite.  
**lime biotite;** biotite containing calcium.  
**lime crown glass;** an optical crown glass containing calcium oxide.  
**lime feldspar;** a misleading term for calcium feldspar or anorthite.  
**lime glass;** a tough glass substance usually consisting of silica, soda, and calcium oxide (lime). Used for inexpensive objects, tumbling, and glassware.  
**lime harmotome;** same as phillipsite.  
**lime jade;** a term used by Chinese for lime-green color of jade.  
**lime light;** a very brilliant light obtained by heating a lime (calcium oxide), in an oxyhydrogen flame. This was in use until 1885 as mantle camping lantern (Wellsbach Mantle), introduced.  
**lime malachite;** malachite carrying calcite or gypsum, or both as impurities.  
**lime mica;** same as margarite.  
**lime olivine;** same as calcio-olivine.  
**lime soda feldspar;** a misleading term for sodium-

calcium feldspar.

**lime silicate;** → calc-silicate.

**limestone;** a sedimentary rock consisting mainly of calcium carbonate (calcite), or calcium magnesium carbonate (dolomite), or any combination of these two carbonates, coral and skeletons of marine micro-organisms. Used to produce lime. In Scotland is called cawk, cauk. → Marble.

**Limestone Creek;** location of alluvial diamond deposits in Western Australia.

**limestone pebbles;** pebbles of limestone.

**limestone, algae;** → algae marble.

**limestone, compact;** → compact limestone.

**limestone, coral;** → coral limestone.

**limestone, occurring of corundum in;** → corundum.

**limestone, crystalline;** → crystalline limestone.

**limestone, encrinital;** → encrinital marble.

**limestone, fine-grained;** → lava cameo.

**limestone, fossil;** → fossil limestone.

**limestone, metamorphosed;** → metamorphosed limestone.

**limestone, oölitic;** → oölitic limestone.

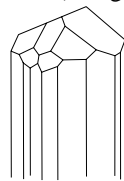
**limestone, shell;** → shell limestone.

**limoniates;** same as limoniatous.

**limoniatis;** a term used by Pliny, which are categories as a possible emerald.

**limoniatus;** a term used for mist green glass or other green synthetic materials. Also spelled limoniatous.

**limonite;** a group of brown to yellowish-brown iron oxide minerals, which is a matrix material, in which turquoise often occurs and consists mostly of goethite. Sometimes used for



*limonite  
crystal*

coating gem minerals. Also known as turquoise matrix and in turquoise. When cut together the piece is called turquoise matrix. Also called brown iron ore, brown ochre, brown ocher and Misnomerly brown hematite.

System: cryptocrystalline or amorphous.

Formula: FeO(OH).nH<sub>2</sub>O.

Luster: silky or dull.

Colors: brown, black, ochre-yellow.

Streak: brown to yellow.

Diaphaneity: translucent to opaque.

Cleavage: none.

Fracture: conchoidal to earthy.

SG: 2.60-4.00.

H: 5-5½.

RI:  $\alpha$ :2.212,  $\beta$ :2.35.  $\ominus$ . When goethite.

Found worldwide.

**limonite as an inclusion;** limonite inclusions occurs in turquoise, spinel, opal, and tourmaline.

**limonite cut;** → limonite.

**Limori stone;** a misleading term for jade imitation or limori stone manufactured in Japan.

**limpid;** clear or transparent, like water.

**limpidity;** adjective of limpid.

**linac;** another term for linear accelerator.

**linarite;** very rare gemstone. It is prized by collectors.

System: monoclinic.

Formula:  $2[\text{PbCu}(\text{SO}_4)(\text{OH})_2]$ .

Luster: vitreous to subadamantine.

Colors: azure blue to dark azure blue. Pleochroism various shades of blue.

Streak: pale blue.

Diaphaneity: translucent.

Cleavage: {100} perfect one direction.

Fracture: conchoidal. Brittle.

SG: 5.33-5.35.

H: 2½.

Optics;  $\alpha$ : 1.809,  $\beta$ : 1.838,  $\gamma$ : 1.859.

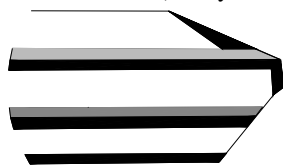
Birefringence: 0.050.  $\ominus$ .

Found in Mammoth mine, Tiger, Arizona, USA, and Montana, Spain,

**Lincoln Sapphire;** a rough, dark blue sapphire of 2,302 cts, from Anakie, Queensland, Australia. Was carved into a bust of former US President Abraham Lincoln, after carving weighs 1,318 cts. This stone together with other four stones Washington, Eisenhower, Jefferson, and Black star of Queensland sapphires were presented as a gift to the American people in 1957 by James and Harry Kazanjian, of Pasadena, California, to The Smithsonian Institution, Washington, D.C., USA. It is presently on display. → Washington Sapphire, Eisenhower Sapphire, Jefferson Sapphire, and Black star of Queensland.

**Linde A;** → aluminum oxide.

**Linde emerald;** a synthetic emerald manufactured by the hydrothermal process in the United States of America by the Linde and Co. New Jersey. RI;  $\omega$ : 1.572 and  $\varepsilon$ : 1.567. Birefringence: 0.005.  $\ominus$ . Some specimens



*a sandwiched linde synthetic emerald*

from USA have RI;  $\omega$ : 1.578 and  $\varepsilon$ : 1.571. Birefringence: 0.007.  $\ominus$ . SG: 2.678. H: 7½. Also called Linde synthetic emerald.

**Linde hydrothermal synthetic emerald;** → Linde emerald, Linde synthetic star corundum.

**Linde simulated diamond;** a trade term for synthetic yttrium aluminum garnet (YAG), used as diamond simulant.

**Linde star sapphire;** → Linde emerald, Linde synthetic star corundum.

**Linde synthetic star corundum;** a synthetic star ruby and synthetic star sapphire manufactured by the Verneuil flame-fusion process, in which asterism is induced by adding 0.1-0.3 % titanium oxide to the aluminum oxide. The process was developed by Linde and Co. New Jersey, USA. After finishing the boule is reheated and titanium oxide been precipitate as rutile needles along the planes of the three lateral crystal axes. Also called Linde star, Linde star sapphire, Linde synthetic emerald.

**Linde synthetic emerald;** → Linde emerald, Linde synthetic star corundum.

**Linde synthetic star sapphire;** → Linde emerald, Linde synthetic star corundum.

**Lindemann glass;** a lithium beryllium borate glass, which is transparent to X-rays. Used as window of the X-ray tube.

**line spectrum;** a spectrum consisting of definite single sharp lines, as distinct from a band spectrum of certain molecules. Each line corresponding to a particular wavelength, which is characteristic of an element in the atomic state.

**linear accelerator;** a large apparatus for accelerating electrons or positive ions or protons up to the velocity of light in a straight line or beam by the action of alternating voltages of the correct phase. Used in research into the structure of crystals or matters, and occasionally to treat diamonds and topaz. Topaz becomes deep blue color. Also known as linac. → Heat treatment and irradiation of topaz.

**linearly polarized;** → polarized light.

**lined gold;** gold sheet backed with other metal.

**liner;** a device incised with a series of parallel lines close together.

**lines of Retzius;** a term applied to wavy parallel lines visible in task ivory. Also called *engine turned*.

**Lingah shell;** same as Lingah pearl or Lingah shell.

**Lingah pearl;** important reddish small oyster genus *Pinctada vulgaris* of salt-water bivalve mollusks known since early times from Persian Gulf. Also called Lingah shell, Mahar shell. → Persian Gulf Pearl.

**lingzhi;** a Chinese term for a kind of mushroom, carved of jade.

**linhuishi;** a Chinese term for green apatite used as jade.

**linnaeite;** a light steel-gray to reddish-silver cubic mineral of  $(\text{Co,Ni})_3\text{O}_4$ . Metallic luster. Opaque. Brown to black streak. H: 4.5-5.5. SG: 4.80-5.80. Cleavage (100). Fracture: uneven. Brittle. Also called cobalt-pyrites, coboldine, linneite.

**Linnaeus, Carl;** a Swedish naturalist (1732-1795), who insert a spherical bead of limestone, marble, etc., in a

drilled hole of mussel and seal the opening to produce cultured pearl.

**linobate**; an old commercial term for synthetic diamond imitation lithium niobate.

**Linschoten**; a 16 century Dutch traveler in the Orient, who formulated a rule for the calculation of gems value.

**lionite**; an abrasive substance similar to alundum.

**lionite**; a synonym for tellurium.

**lintonite**; a translucent olive-green to pale green and frequently pink, banded variety of thomsonite resembling jadeite found in Lake Superior district, Canada and USA. Also called winchellite. → Lake Superior agate.

**Lion of the Punjab**; → Koh-i-Nûr Diamond.

**lion's-eye**; same as cat's-eye.

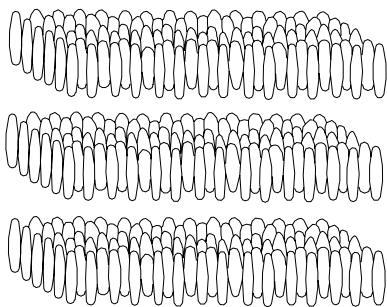
**liparite**; an obsolete synonym for rhyolite.

**liptobioliths**; it means ambers, resins and waxes, which are classified as materials that are resistant to the decay. → Caustobioliths.

**liquation**; in a magma, the separation of one constituent ore by partial melting, so that the fused fraction can be run off.

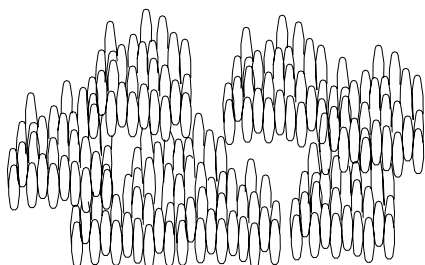
**liquid**; a term used by Australian miners for an opal with mobile feature in which the flash moves always in one direction no matter how the turning of the stone happens. Also called liquid opal.

**liquid crystal**; an organic, viscous, jelly-like chemical



condition of ordered liquid molecules in smectic phase

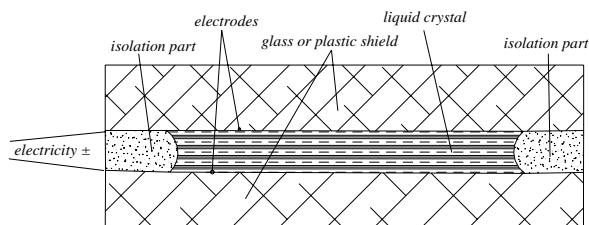
compound in a transition form between liquid and solid states, which has optical properties like a crystal but other properties are similar to liquids, commonly



condition of ordered liquid molecules in nematic phase

anisotropic over a definite range of temperature above their freezing points. Mostly can exhibit left-handed or right-handed twisted structure. Under the influence of an electric field, liquid crystals undergo realignments leading to optical effects. Liquid crystals are divided into threefold category because their *thermotropic* character: (a) *nematic liquid crystal* having long molecules and all nearly parallel, straight in same direction but otherwise randomly arranged. Optically uniaxial, positive and strongly birefringent. Also called threadlike liquid crystal. (b) *Cholesteric liquid crystal* entire the molecules are straight but arranged in distinct layers. Also called *chiral nematic*. (c) And *smectic liquid crystal* whole the molecules are straight but perpendicular layers. Also called *soaplike* liquid crystal. Mesophases are another term for liquid crystals. *Mesophases* are divided as thermotropic because of its used pure or mixture in temperature control and *lyotropic*, when liquid crystal properties observed in solutions in nonliquid crystal solvents.

**liquid crystal display**; a screen made for digital watches, calculator, TV screen, etc., with a clearly digital display consisting of a thin film of liquid crystal which is sandwiched between two transparent



an electro optical liquid-crystal screen

electrodes.

**liquid crystal thermometer**; a thermotropic made of thin layer of Cholesteric liquid crystal with effective optical thickness. Color change caused due to increasing or decreasing temperatures.

**liquid glass**; same as sodium tetrasilicate.

**liquid gold, silver, platinum**; solutions of these metals used for decorating glass, and porcelain products.

**liquid for immersion method**; → immersion liquids.

**liquid inclusion**; inclusion of liquid within a crystal or gemstone.

**liquid inclusion in sapphire**; → sapphire inclusions.

**liquid magmatic deposit**; same as magmatic mineral or ore deposits.

**liquid nitrogen**; → cryogenic cooling.

**liquid opal**; same as liquid.

**liroconite**; occasionally used as an ornamental stone and

as an imitation for turquoise. Also called lentil ore.

System: monoclinic.

Formula:  $4[\text{Cu}_2\text{Al}(\text{AsO}_4)(\text{OH})_4 \cdot 4\text{H}_2\text{O}]$ .

Luster: vitreous.

Colors: sky-blue to greenish-yellow.

Streak: sky-blue to green.

Diaphaneity: translucent to opaque.

Cleavage: indistinct.

Fracture: uneven. Brittle.

SG: 2.93-3.00.

H: 2-2½.

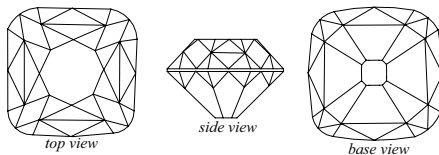
Optics;  $\alpha$ : 1.612,  $\beta$ : 1.652,  $\gamma$ : 1.675.

Birefringence: 0.063.  $\ominus$ .

Found in California (USA), Saxony (Germany), and Cornwall (England).

**Lisa Blue Diamond;** a flawless, fancy sky blue, round brilliant diamond of 37.21 cts, set in a clip, was recut into 37.05 cts, sold in 1967 in New York, USA by Harry Winston.

**Lisbon cut;** a modified brilliant triple or old mine cut



*Lisbon cut*

with 74 facets, in which the main facets in both crown and pavilion are parallel to the girdle.

**litharge;** a yellowish or reddish poisonous mineral of monoxide of  $2[(\text{PbO})]$ . Used in ceramic industry, in pottery, and glazes. Also called lead oxide, plumbous oxide, lead monoxide, lead ocher, and yellow. → Massicot.

**litharge glass;** a lime-soda glass, in which litharge (PbO), replace part of calcium oxide of glass.

**lithia;** lithium monoxide.

**lithia;** same as lithium emerald.

**lithia amethyst;** a misleading term for kunzite variety of spodumene. Also called lithium amethyst.

**lithia emerald;** a misleading term for green hiddenite variety of spodumene.

**lithia feldspar;** same as petalite.

**lithia lazuli;** a misleading term for violet fluorite.

**lithia mica;** another name for lepidolite.

**lithic;** a term used for constituent of a stone.

**lithifaction;** a name used sometimes to the solidification of a molten lava to create an igneous rock.

**lithify, to;** to change to rock or to petrify. Generally to consolidate from a loose sediment mass to a solid rock.

**lithion beryl;** beryl containing lithium but cesium-free.

**lithionite;** same as lepidolite.

**lithium;** a very soft, light, silvery-white alkali metal of the Periodic System with the symbol Li. The lightest metal known.

**lithium amethyst;** same as lithia amethyst.

**lithium beryl;** beryl containing lithium.

**lithium feldspar;** same as petalite.

**lithium iron spinel;** a strongly magnetic black flux-grown lithium-iron spinel. SG:4.58. No counterpart exist in nature.

**lithium emerald;** an erroneously term for hiddenite.

**lithium metasilicate;** a colorless or white composition of  $\text{Li}_2\text{SiO}_3$ . Orthorhombic crystal. SG:2.52. Used as a flux in glazes and enamels for ceramic.

**lithium mica;** another synonym for lepidolite

**lithium minerals;** these minerals are main sources of the element lithium such as lepidolite, spodumene, amblygonite. Used in glass and ceramic industries.

**lithium niobate;** a synthetic crystal grown by Czochralski pulling process and Verneuil method, used as a gemstone simulant. Formula:  $\text{LiNbO}_3$ . No counterpart exist in nature. Trigonal crystal with ilmenite structure. Transparent. Colorless, yellow, green, blue, blue-violet. Colored crystal are mixed with pigment oxides. Pleochroism. Optics;  $\omega$ :2.21,  $\epsilon$ :2.30. Birefringence: 0.090.  $\oplus$ . High dispersion: 0.120 nearly four times than diamond. SG: over 5. H:5½. It was known as linobate. The preferred name is *synthetic lithium niobate*.

**lithium tantalate;** a synthetic crystal grown by Czochralski process, used as a gemstone simulant. Chemical formula:  $\text{LiTaO}_3$ . No counterpart exist in nature. Trigonal system with ilmenite structure. Transparent. Colorless. Optics;  $\omega$ :2.175,  $\epsilon$ :2.180. Birefringence: 0.005.  $\oplus$ . SG:7.454. H:5½-6.

**lithium titanate;** a white synthetic crystal of  $\text{Li}_2\text{TiO}_3$ , used in small percentages in enamels. No counterpart exist in nature.

**lithium zirconate;** a synthetic product, used as a flux in zirconium-opacified enamels, glazes, and porcelains;  $\text{Li}_2\text{ZrO}_3$ . No counterpart exist in nature.

**lithium-zirconium silicate;** a synthetic produce and strong flux used in enamels, glazes, and porcelains;  $2\text{Li}_2\text{ZrO}_3 \cdot \text{SiO}_2$ . No counterpart exist in nature.

**lithochemistry;** the science of the chemistry of rocks.

**lithoclase;** any rock, which occurs with natural fracture.

**lithoclast;** one who breaks stones.

**lithogenesis;** the origin and formation of rocks, used generally for sediment rocks. Same as petrogenesis.

**lithogenesy;** the study of origin of minerals.

**lithoglyph;** artistic carving or engraving on gems or other stones.



- lithoglyphics**; the art of cutting or engraving of precious gemstone or other stones.
- lithographic limestone**; a dense, fine-grained, yellowish to grayish crystalline limestone, which is used in lithography. Also called lithographic stone, lithostone.
- lithographic stone**; same as lithographic limestone.
- lithography**; originally the art of several drawing upon and printing from stone.
- litholazuli**; a misleading term for massive purple fluorite from Sierra se Cordoba, Argentina.
- lithoid**; a term applied to rock-like, or stone-like.
- lithology**; the megascopic description of the character of a rock expressed in terms of its mineral composition, color, grain-size, its structure, and arrangement of its component parts. All these visible features in aggregate impart individuality to the rock.
- lithology**; the physical character of a rock or stratigraphic unit.
- lithomancy**; a method of divination by certain stone, gem and minerals. Stones used as good-luck charms. → Crystallomancy, speculum, margaritomancy, crystal gazing.
- lithomarge**; a smooth, firm, compact variety of kaolin consisting partial or complete alteration and transformation of tourmalines or mixture in part of kaolinite and halloysite. → Tourmaline alteration.
- lithophone**; a term applied to a white pigment formed from zinc sulfide, barium sulfate and zinc oxide. Used as dyes. Lithophone undergo yellow color-change by ultraviolet radiation, therefore has been largely replaced by titanium dioxide. → Photochromism.
- lithophosphor**; a mineral becomes phosphorescent, when heated, such as barite.
- lithospar**; a naturally mixture of spodumene and feldspar.
- lithosphere**; the outer rocky layer of the Earth that surround the crust and upper mantle, suggested a thickness of 45-60 kilometers (30-40 miles). The outermost part of the Earth's crust contains aluminum silicate rock (sial) and is a very important section in the genesis of mineral and gemstones. Also known as Earth's crust and geosphere, crust of the Earth.
- lithosiderite**; same as stony-iron meteorite.
- lithostone**; same as lithographic limestone.
- lithotherapy**; a belief in the effectiveness of gemstones of human because of their auras of energy. → Margaritomancy, crystallomancy, hydromancy, crystal gazing, speculum, lithomancy.
- lithoxyl**; a wood opal, in which the original woody structure is observable. Same as petrified opal. Also spelled lithoxyle, lithoxylite, and lithoxylon.
- lithoxyle**; same as lithoxyl.
- lithoxylite**; same as lithoxyl.
- lithoxylon**; same as lithoxyl.
- lithyalin**; a term for opaque marbled glass.
- Li T'ieh-Kuai**; a Chinese term used for a human sign carved on jade as a crippled beggar carrying a scepter to symbolize immortality for the rest of his earthy life. → Chinese ritual and symbol jades.
- Litkie Diamond**; a diamond of 205.50 cts, found in 1891 in Good Hope on the Vaal River, South Africa.
- little Namaqualand**; → Namaqualand.
- Little Rose Diamond**; → Premier Rose Diamond.
- Little Sancy Diamond**; a pear-shaped diamond cut of 34.50 cts, from the collection of Sancy of French Court 17<sup>th</sup> century. Probably from India. It was sold to Frederick Henry of Orange and inherited by Frederick I of Prussia, which became part of the Prussian Royal treasury. Now it is set in a pendant in Bremen Germany. Also called Beau Sancy. → Sancy Diamond.
- Little Willie Pearl**; same as Abernethy Pearl.
- littoral**; a term applied to shore of sea or lake or other landscape of water between high tide and low tide.
- Littrow spectrometer**; an optical device for obtaining and visually observing improved spectrum, in which collimated light passes through a narrow slit onto two prisms (doublets the effective base length of the prism because light passing through them twice), their spectrum being passing through a silvered quartz half-prism with a rear reflecting surface that reverse the light. Viewed by a lens system or telescope. → Diffraction grating.
- liu lu**; a Chinese term for beryl.
- liu pi**; a Chinese term for a box to keep the skin, made of jade. → Chinese ritual and symbol jades.
- Liu Qing**; a Chinese term for a box to keep the green skin of bamboo, made of jade. → Chinese ritual and symbol jades.
- live**; a description term used by Australian miners for the rarely fire opal. Also called lively, live opal.
- lively**; same as live.
- live ash**; a misleading term for lapilli.
- lively opal**; same as live, fire.
- live opal**; same as live, fire opal.
- live quartz**; quartz crystal associated with a valuable mineral.
- liver opal**; another term for menilite.
- liver ore**; same as cinnabar.
- liver pyrites**; pseudomorphous brown pyrite or marcasite after pyrrhotite.
- liver stone**; a compact, liver-brown variety of cinnabar and idrialite mixture. Also called hepatic cinnabar.
- lizardite**; a greenish-white variety of serpentine from Lizard Peninsula, England. It is a polymorphous of chrysotile. Also called *lizard stone*. Optics;  $\alpha$ :1.538-1.554,  $\beta$ :1.565,  $\gamma$ :1.546-1.560. Birefringence: 0.008. ⊖.

H:2.5. SG:2,55-2.60. Found in Kashmir (India), South Africa, Cornwall (England), Austria, Ireland, and Scotland. Used as ornamental stone.

**lizard skin polish;** a bumpy or wavy polished area, on the surface of a polished diamond.

**lizard stone;** → lizardite.

**llanite;** same as llanoite.

**llanoite;** a sodic granite rock containing minute blue chatoyant quartz, albite, and microcline in brownish-reddish porphyry groundmass. Found in Llano County, Texas, USA. Often used as ornamental objects. Also called llanite.

**llusvisnados opal;** a Mexican name for highly transparent, yellowish or light-bluish water opal with flashes of intense play-of-color within stone.

**load;** an obsolete unit of weight of ore or blue ground used in South Africa mines; equal to 1,600 pounds or 0.8 short tons (727 Kilograms), or about 16 cubic feet of broken ore. Metric ton now used.

**load;** the material that is carried by a natural transporting agent, such as water, wind, waves, glacier, tides and current.

**loading chamber;** → chamber.

**loadstar;** same as lodestone.

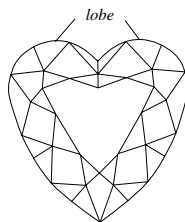
**loadstone;** same as lodestone.

**Lobaye;** location of a small diamond mine in Central African Republic.

**Lobaye river;** location of a small diamond mine in Central African Republic.

**lobe;** one of roundish projection or division ends of a heart-shape cut diamond or other cut stone.

**lobe;** a term used in South Africa for the shape of a



*lobe a left or right part of a heart cut stone*

lamproite or kimberlite pipe.

**lob of gold;** a minute but rich deposit of gold.

**local digger;** an alluvial or primary native digger who comes from the local area.

**local metamorphism;** same as contact metamorphism.

**lochs;** unfilled cavities in a vein of rock.

**locket;** a small ornamental case worn usually suspended as a necklace or chain that hold inside a picture, etc., comprising two lid hinged together, made of precious metals and gemstones leaving space for memento.

**lode;** a large area or a group of mineral veins or systems of metallic ore in a rock. → Vein.

**lode;** a miner's term used for deposit of jade, separated

from the adjoining rock due to especial boundaries.

**lode;** a synonym for lead. → Lodestone.

**lodestone;** a natural variety of magnetite, which exhibits magnetic polarity, behaving, when freely suspended as a magnet. Sometimes used as good-luck charms. Found in Transvaal, South Africa and elsewhere. Also called loadstone, loadstar, leadingstone, Hercules stone or Heracleian stone.

**lodestone;** any strongly magnetized rock or ore deposit.

**lodestone;** stones found in lodes or vines.

**loellingite;** same as leucopyrite. Also spelled löllingite.

**loess;** a widespread, homogeneous, fine-grained, commonly nonstratified, wind-deposited sediment, composed largely of clay silt-sizes, mica, feldspars, and quartz particles. Found in yellowish-brown color in large areas in China, eastern Europe, North and South America. Also spelled löss.

**Loffa River;** location of an alluvial diamond mine in Liberia, Africa.

**L'office Forestière et Minière du Congo;** a principal diamond-mining corporation in Zaire (former Congo). Abbreviation: FORMINIÈRE.

**Logan Sapphire;** a dark blue sapphire of 423 cts, from Sri Lanka. It is set in a finger ring encircled by 20 rose cut diamonds. Was presented by John Logan to the Smithsonian Institution, Washington, D.C., USA.

**logwood;** → indigo.

**lohan;** a Chinese term for an enlightened saint man, carved of jade. → Chinese ritual and symbol jades.

**lohans;** a Chinese term used for a Buddha figure carved on jade as Buddhist saints. → Chinese ritual and symbol jades.

**löllingite;** another spelling for loellingite.

**lombong;** a Malay term for large excavations in tin minerals alluvial placers.

**lon-bauks;** a Burmese term used for individual gemstone by which rubies are graded for size and color. → Corundum classification in Myanmar.

**London;** location of a small alluvial diamond mine in Schweizer Reneke, Transvaal District, South Africa.

**London blue topaz;** a commercial term for dark blue topaz colored by radiation without heat treatment. Heat treatment may be used to remove undesired colors. → Super American blue topaz, super Swiss blue topaz.

**London cutting center;** London has remained the center of supply of rough diamond, while the principal cutting centers are in another countries.

**Londonderry Topaz;** a light-blue Australian topaz of ≈ 3700kg in rough. Found 1902? In India? Present whereabouts unknown.

**London Diamond Bourse;** a Diamond Bourse in London, member of the world Federation of Diamond Bourse.

**London Diamond Club;** a Diamond Bourse in London, member of the world Federation of Diamond Bourse.

**London Diamond Syndicate;** → Diamond Syndicate.

**Londoner;** an informal term used by Australian miners for a shaft when breaks through into a drive of working mine.

**London selling center;** a Diamond Trading Company was founded in 1934 in London to carry out the actual selling of diamonds.

**long;** a Chinese term for a dragon carved of jade used in prayer for rain. → Chinese ritual and symbol jades.

**long-columnar crystal form;** crystal habit of fringe crystal such as tourmaline pencil.

**long hexagonal cut;** a style of hexagonal cut where the outline of the girdle is six-folded but increasing the length of one of the three pairs of sides. → Hexagonal cut, baguette.

**Longlands;** location of a small alluvial diamond mine in Barkly West, Cape Province, South Africa.

**long-lived metastable level;** → inverted population.

**long periods;** a term used for the fourth period of the Periodic System between scandium and zinc (atomic number 21-30) because these 10 elements do not resemble the elements of the short periods (transition metals), but starting with gallium through bromine resembling the elements of the short periods. → Periodic Table of the Elements.

**long toe;** → big toe.

**long toe;** a term used by Australian miners for digging out as far as possible in a drive, taking-out only good-looking opal dirt.

**long tom;** an early Australian mining method, in which rough concentrated alluvial gold was sometimes worked up to a better grade.

**long wave filter;** → ultraviolet lamp, short-wave UV filter.

**long wave fluorescent ultraviolet lamp;** → ultraviolet fluorescence.

**long wave radiation;** same as infrared.

**long wave ultraviolet;** → ultraviolet radiation.

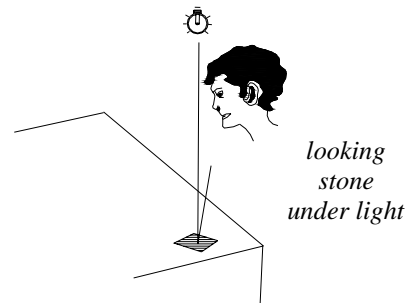
**Longido ruby;** location of rubies in Longido Mine, Tanzania, Africa.

**Lonsdale Kathleen;** British crystallographer and scientist.

**lonsdaleite;** a pale brown to yellow, hexagonal diamond (an allotrope or polymorphous with diamond, graphite, and chaoite) found in meteorites and synthesized from graphite in laboratory by shock conversion, are classified as Type III diamond. → Meteorite, meteoric diamond.

**loodwins (ruby mining);** a local term in Myanmar (Burmese) for mine working in fissures, caverns, and hollows in limestone. Also called loos (ruby mining).

**looking atone;** for exact looking a sample of rock, mineral, fossil or other substances the light bulb should be directly overhead, and the rays should pass as close to the forehead as possible. The sample or stone is then



turned about until the effect appears to on top.

**looks at you;** a term used by Australian miners for an opal of good quality when entire color is seen from any direction.

**loop;** → loupe.

**loopkring;** a Dutch term applies to the inner part of polishing lap, or scaife.

**loos (ruby mining)** → loodwins (ruby mining).

**loose;** unconsolidated, incoherent materials, ores or rocks.

**loose agglomerate;** a chaotic assemblage of coarse, angular, pyroclastic fragments, as the result of explosive volcanic activity, which is not consolidated by action of heat.

**loose diamond;** an unmounted, polished diamond or other gemstone. → Loose goods.

**loose gem;** → loose diamond.

**loose goods;** industrial diamonds, as purchased from a company in bulk.

**loose goods;** fashioned but unmounted diamonds. Also called loose diamond.

**loose gravel;** easily removable of gravel by shoveling only.

**loose ground;** same as broken ground.

**loose industry diamonds;** loose industry diamonds that are used as drill diamonds in a single packet.

**loose pearl;** → loose diamond.

**loose stone;** → loose diamond.

**loranskite;** a variety of euxenite.

**Los Angeles (abrasion) testing machine;** a device for determining abrasion resistance or toughness of materials. Also called Los Angeles testing machine

**Los Angeles Aquamarine;** a step-cut aquamarine of 6021.00 cts, from Brazil. Now on display at Los Angeles County Museum, USA.

**Los Angeles Aquamarine;** a cut aquamarine of 2594.00 cts. Now on display at Los Angeles County Museum, USA.

**Los Angeles testing machine;** same as Los Angeles (abrasion) testing machine

**Los Cerrillos turquoise;** famous fine-quality turquoise from Los Cerrillos, close to Santa Fe, North Mexico. It was worked by Indians for centuries. Also called American turquoise.

**losero;** a Mexican term for a beautiful, colored sandstone from Guanajuato. Quarried for building purposes.

**löss;** → loess.

**loss of color;** the ratio of or difference between the two quantities or intensities of colors. An optical phenomenon consisting of some stone that shows a difference in tone of color from daylight to artificial light; it becomes lighter or darker in tone.

**lost-wax process;** a casting process, in which a piece of wax is carved or formed into a distinct pattern. The method has been used since ancient times, in which the wax pattern is pouring with gypsum, and than formed or run out of a hole, this negative cavity is suitable for molds. → Casting.

**lot;** a lot of rough diamonds, usually similar in size and qualities.

**lot;** sometimes used for composed of polished diamonds, usually similar in size and qualities.

**lot;** loose industry diamonds, such as drill diamonds in a single packet. → Parcel.

**loth;** a disagreement basic measurement of weight of garnets in Bohemian, 16.66 grams and 31.1035 grams.

**lot pearls;** minute grain pearls, under one cts, in weight.

**lot price;** lot of diamonds, per-carat price. Also called parcel price.

**lotrite;** → pumpellyite.

**Lottery Diamond;** another term for Pigot Diamond.

**lotus leaf;** same as lily pad.

**Louis Cartier Diamond;** a flawless, colorless, rough diamond of 400 cts, found in 1974 in South Africa. From this stone one important pear-shaped diamond WAS cut weighing 107.07 cts, and two other stones were cut: Louis Cartier II and Louis Cartier III. They were named in honor of the French founder of the firm. Also called Cartier Diamond.

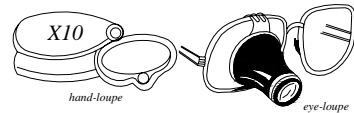
**Louis de Berquen;** → Berquen-Louis de.

**Louis XIV Diamond;** a pear-shaped diamond of 62.05 cts, (prior to 1953), believed to belong to Louis XIV of France. It was purchased by Harry Winston in 1958, and recut it to a flawless 58.60 cts, pear-shaped stone.

**loup;** → loupe.

**loupe;** any small magnifying glass or lens system, which can form an enlarged image of small object, used for inspecting the internal and external features of gemstones, or used in the field or in other preliminary investigations of minerals. Most used hand loupe in

gemology are corrected loupes or so-called aplanatic loupes. These are made of double-convex crown glass joined between two meniscus lenses of clear flint glass together. Usually used hand loupe in mineralogy or gemology is a 10 x magnification lens. The usual



two different loupes

watchmaker's or jeweler's loupe is uncorrected and magnifies 2 to 3 times. Also called hand lens, hand loupe or pocket lens, magnifier, simple microscope, and magnifier glass. Also spelled loop, loup, and lupe. → Eye loupe, corrected loupe, aberration, lens.

**loupe clean;** clarity-grading scales of polished diamonds used in the CIBJO, IDC and by Scan. D.N. for high clarity diamond, adequate to IF on the GIA clarity-grading scales.

**loupe clean;** a misnomer for clarity grading of polished diamonds. The term is used by the members of American Gem Society and implies *perfect* or *flawless* gem diamonds under 10x magnification by using a corrected loupe.

**loupe, corrected;** a lens system, which has been corrected for spherical or chromatic aberration or both. → Aberration, aplanatic loupe.

**louped;** a promotion term for diamond or other gemstones, which has been determined by using a loupe.

**loupe-visible;** the internal and external features of gemstones is visible with aid of a loupe.

**Louise X, King of France;** the earliest reference to diamonds seems was about a diamond necklace been worn by French Queen Clemence wife of King Louise X the Quarreler (1289-1316).

**louping;** a term used by Australian miners for process of picking over the material in digging area.

**love's arrows;** same as flèches d'amour or sagenitic quartz.

**love stone;** sometimes a synonym for aventurine quartz.

**Louvre Museum;** a famous Museum in Paris, France. → Louvre Museum Gem Collection.

**Louvre Museum Gem Collection;** a great collection of some historian gems and jewels on display in Apollon Gallery in Louvre Museum, Paris, France.

**Louvua;** location for alluvial diamond deposit along the Chicapa River in northern Angola, Africa.

**low albite;** low-temperature albite occurs commonly in nature, stable below 450° C. It has a completely ordered structure.

**lower break facets;** same as girdle facets or break facets.

**lower core;** same as inner core.

**lower girdle facets;** same as girdle facets or break facets.

**lower main facets;** same as pavilion facets.

**lower pressure sawing;** use of slower speed for brittle diamonds than normal diamonds to generate less heat.

**low gloss;** → dullness.

**low quartz;** a low-temperature, trigonal polymorphous of quartz, when formed below 573° C. Also called alpha quartz.

**low relief;** when an inclusion in a gemstone has a refractive index near or the same as the host. For example corundum crystal included in corundum. Also known as base-relief.

**low relief;** an ornament, in which the pattern is slightly raised above the surface of the stone or other objects.

**low-type zircon;** same as low zircon.

**low zircon;** a generally green or brown variety of zircon, in which positively charged alpha particles are emitted by certain radioactive materials as impurities such as coffinite and thorium. The crystalline structure of this mineral is more or less completely broken down and shows practically no double refraction and owe their low refractive index and density. RI:1.780-1.840. Birefringence:0.060. SG:3.90-4.68. H:7-7½. Stone of this type, mostly are from Sri Lanka. Heat treatment returns these stone to the normal state. Also called metamict or low-type zircon. → Zircon, high zircon, alpha zircon.

**Loxton Mine;** location of a diamond-bearing pipe in Cape Province, South Africa.

**lozenge;** a decorative and modern four-sided shape used in diamond and other gemstone cutting figure. Lozenge having 4 side two equal and opposite acute angles, the other two equal and opposite obtuse angles. Also having lozenge-shaped outline. Frequently the corners are rounded.

**lozenge cut;** a modern four-sided trap-cut for diamond or other transparent gemstones having a lozenge-shaped

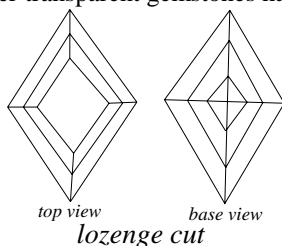


table. In this cut each of the four sides are bordered by a sloping trapezoidal facet. Also known as

*lozenge step cut.*

**lozenge facet;** a term sometimes used as a synonym for four quoin facets. It means 8 lozenge-shaped facets on the crown or 8 facets on the pavilion in brilliant cut. Another term for the bezel, quoin, temple. Now all such 8 lozenge-shaped facets are each called a main

facet or a kite facet. → Pavilion facet, quoin facet.

**lozenge step cut;** → lozenge cut.

**Lu;** a chemical symbol for the element lutetium.

**lu;** a Chinese term for a bronze-burner, carved of jade. → Chinese ritual and symbol jades.

**Lucalox;** a promotion term for transparent, pure alumina made by General Electric Company, USA.

**Luachimo River;** location of a diamond-bearing river in Angola, Africa.

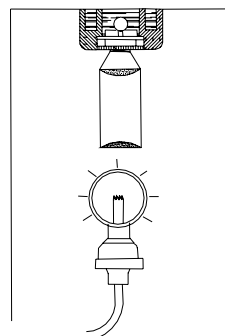
**lube job;** a term used by gem dealers in Thailand for trader who presents his gemstones upon a rack for a quick merchandizing.

**Lubilash;** location of diamond-bearing deposits in the Lubilash River region in Zaire, Africa.

**Lucapa;** location of a diamond-bearing area between Luembe River and Chicapa River in northern Angola, Africa.

**Lucia Aquamarine;** an emerald crystal of 61 kg found in 1955 in Minas Gerais, Brazil. Whereabouts is unknown.

**lucidoscope;** a device used for testing the zonar structure in some thin skinned cultured pearl before



*lucidoscope.*  
After Webster 1994

developing and introduction of the endscope. The pearl is immersed in a liquid of similar refractive index, and illuminated by an intense beam of light and viewed microscopically. The natural pearl shows an uniform density of light, whereas a cultured pearl may shows the layers of the mother-of-pearl, when those are in the same plane as the light beams. Mother-of-pearl of cultured pearl may shows more transparency to light in certain direction than others. *Candling pearl* is a measure method by using lucidoscope, when a beam of long-wave ultraviolet light is passed through a correctly oriented cultured pearl on a piece of bare film the *stripy* pattern will be seen on development.

**lucinite;** a variety of variscite from the near Lucin, Utah, USA.

**lucite;** a commercial term for a transparent thermoplastic acrylic resin or methyl-methacrylate esters. Used in mounting of gem specimens. RI:1.49. SG:1.19.

**lucky pig amber;** same as amber boar.

**lucky stone;** a synonym for twinned staurolite.

**lucullam**; a black marble colored by carbon found in Egypt. Also called lucullite.

**lucullite**; same as lucullam.

**Lüderitz**; a town in Namibia (South-West Africa), it was once the center of South-West African diamond industry. → South-West Africa.

**ludlamite**; a rare mineral. Sometimes cut, prized by collectors.

System: monoclinic.

Formula:  $2[(\text{Fe}, \text{Mg}, \text{Mn})_3(\text{PO}_4)_2 \cdot 4\text{H}_2\text{O}]$ .

Luster: vitreous.

Colors: pale green, dark green, apple green, white, colorless.

Streak: light green to colorless.

Diaphaneity: transparent to translucent.

Cleavage: {001} perfect.

Fracture: conchoidal to uneven. Brittle.

SG: 3.19.

H:3½.

Optics:  $\alpha$ :1.651,  $\beta$ :1.672,  $\gamma$ :1.697.

Birefringence: 0.038-0.044. ⊕.

Found in New Hampshire, Cornwall (England), Germany, Idaho (USA).

**Luebo**; location of a diamond-bearing region between Lulua River and Luebo River in Zaire, Africa.

**Luembe River**; an alluvial diamond-bearing river in Angola, Africa.

**Lu jade**; a Chinese term for bluish-green jade. Chinese spelling: Lu Yü.

**luli**; an imitation pearl made from glass in Egypt in the Roman era.

**lulianshi**; a Chinese term for green epidote used as jade.

**lumachella**; same as fire marble.

**lumachelle**; same as fire marble.

**lumarithe**; a synthetically cellulose acetate thermoplastics similar to bexoid.

**luminescence**; the emission of certain visible wavelengths of light from a substance other than thermal process, which are used as diagnostic determination of gemstones. It is caused by the emission of photons, when an excited atom (*excited state*) within the substance returns to the *ground state*. It is a general term, in which the *phosphorescence*; the phenomenon continues after the energy source is removed and *fluorescence*; the phenomenon ceases as soon as the source of the energy is distinguished. Both are particular cases of cold light *luminescence*. Essential types of luminescence are: *chemiluminescence*, *bioluminescence*, *photoluminescence*, *incandescence*, *electroluminescence*, *triboluminescence*, *resonance radiation*, *thermoluminescence*, *radioluminescence*, *cathodoluminescence*, *lyoluminescence*, *crystalloluminescence*, *sonoluminescence*, *galvanoluminescence*, *cando-*

*luminescence*. The phenomenon luminescence is very useful in gemology for identification, while some gemstones luminance with different characteristic colors, when irradiated with short-wave ultraviolet, long-wave ultraviolet, or X-rays. → Incandescence, Stokes' law.

**luminescence by ultraviolet radiation**; → ultraviolet radiation, ultraviolet fluorescence.

**luminescence by X-ray radiation**; → X-ray fluorescence, luminescence of gemstones, luminescence.

**luminescence, cold**; → cold improves lines and fluorescence.

**luminescence of gemstones**; luminescence of gemstone and other substances depend on a minor impurity in the material. Natural and synthetical gemstones shown under each of the three types of radiation: short-wave ultraviolet, long-wave ultraviolet, or X-ray, different luminescence colors.

**luminescence of mechanical breaking**; a kind of luminescence, which emit light when cleaved in a vacuum.

**luminescence of opal**; opal shows under SWUV and LWUV light luminescence or play-of-color from white to bluish, greenish or brownish. Frequently green phosphorescence. Black opals are inert.

**luminescence of pearls**; → pearl luminescence.

**luminescence of ruby**; chromium-rich rubies are strong crimson or frequently orange under SWUV or other blue light.

**luminescence of synthetic stones**; → luminescence of gemstones, luminescence.

**luminescent**; capable of exhibiting luminescence.

**luminescent, center**; a defect in certain transparent crystal structures will be excited by free electrons in the structure and given rise to luminescence properties or electroluminescence.

**luminiferous calcite**; same as luminescence calcite.

**luminograms**; → fluograms.

**luminosity**; → color,-definition.

**luminous emittance**; same as luminosity. Also called luminous intensity. → Color,- definition.

**luminous intensity**; same as luminosity. Also called luminous emittance. → Color,- definition.

**luminous reflectance**; same as transmittance.

**lumps**; a term applied to large piece of kimberlite or blue-ground, which failed to break up in the time allotted on the floor or weathering floor.

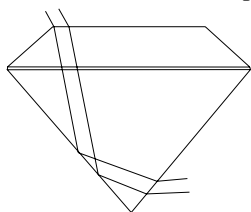
**lumps**; pertaining to a lump.

**lumps**; irregularly lumpy shaped crystals as inclusions in almandine.

**lumpy**; a gemstone, which is cut thick.

**lumpy diamond**; a fashioned diamond or other

transparent gemstone with an over-depth pavilion, and



*lumpy diamond. Because light scapes from the bottom caused by deep pavilion*

often with a high crown, which is too thick for its spread and light escapes from the pavilion. Also called thick stone, or lumpy stone.

**lumpy girdle;** a too-thick girdle on a brilliant-cut diamond or other gemstone.

**lumpy stone;** → lumpy diamond.

**lunar;** resembling the moon, such as lunar landscape.

**luna agate;** purplish-bluish eye agate from Mexico. Also called moon agate.

**lunaris;** same as moonstone.

**lunarite;** a term applied to light-toned, highly reflected surface rocks.

**lunar stone;** a variety of barite with phosphorescence effects.

**lunate;** same as crescent-shape.

**Lunda;** location of a diamond bearing area in northern Angola, Africa.

**lunel marble;** fossil coral variety of marble from Northern France.

**lunette;** a trap-cut diamond or other transparent gemstones with an outline like half moon profile.

**lung;** a Chinese term used for dragon carved on jade. → Chinese ritual and symbol jades.

**lunishi;** a Chinese term for green chlorite used as jade.

**lunula;** a half-moon shaped ornament made of gold or other metals.

**luoshiliushi;** a Chinese term for green uvarovite used as jade.

**luotiekuang;** a Chinese term for green chromite used as jade.

**lupe;** a German term for loupe.

**lupern;** a Scandinavia nomenclature system (Scan. D.N.), which means internally flawless.

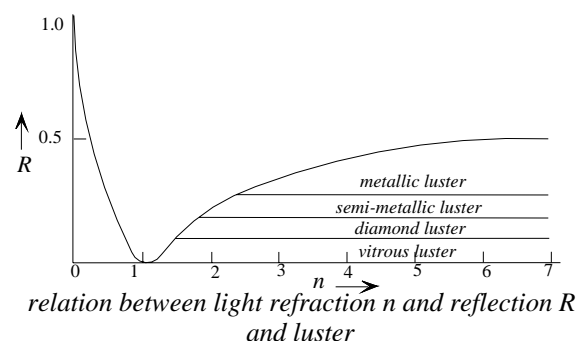
**lus;** a local term in a Myanmar (Burmese) used by ruby miner for deep underground shafts or excavations into the hillsides.

**lusakite;** a variety of staurolite consisting of cobalt.

**lussatite;** a variety of chalcedony, optically positive in character.

**luster;** the certain appearance of a smooth surface dependent upon the quality and amount of reflected and refracted light known as luster. The highest degree of luster in metals and opaque minerals is splendent such

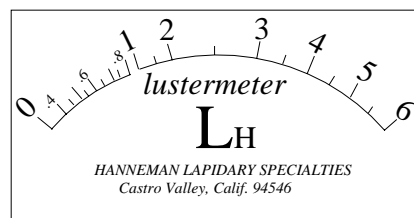
as hematite, and for transparent minerals being adamantine. Also spelled lustre. There are several types of luster, which are listed: *adamantine* (luster); a term used to describe typical diamond luster. Possessed only by mineral of high refractive index. *Subadamantine* (luster); a luster degree between adamantine and resinous luster such as demantoid garnet. *Dull* (luster); a term applied to the degree of luster of minerals, means lacking or total absence of luster. Also known as



dull. *Glimmering* (luster); denotes a still more feeble luster. Also called glistening. *Glistening* (luster); → glimmering (luster). *Metallic* (luster); the most brilliant can be seen by certain opaque minerals, such as gold, and crystalline hematite. *Pearly* (luster); such as pearl, moonstone, mother-of-pearl, etc. *Resinous* (luster); such as amber, certain garnets or sphalerite. *Shining* (luster); minerals are reflected indistinctly. *Silky* (luster); a silk-like luster, which is reflected from fibers in fibrous crystalline aggregates such as satin spar, or as shown by cat's-eye, and tiger eye. *Splendent* (luster); crystal surface reflects light as in a mirror, such as by opaque minerals. *Vitreous* (luster); glass-like objects such as quartz and most gemstones. *Waxy* (luster); such as turquoise, and jadeite. *Sheen* is caused by reflection of light ray and refractive index from within the stone. → Sheen.

**lusterite;** a commercial term for synthetic strontium titanate used as a diamond imitation.

**lustermeter;** a registered device to measure the



*lustermeter from Hanneman, California*

numerical value for luster, made by Hanneman Lapidary, California, USA.

**luster of plastics;** luster is greasy to subvitreous to

waxy. → Plastics properties.

**lusterware;** → iridescence of glass.

**lustigem;** a commercial term for synthetic strontium titanate used as a diamond imitation.

**lustre;** → luster.

**lustron;** a term applied to a synthetic thermoplastics resin.

**lutecine;** same as lutecite.

**lutecite;** a variety of fibrous chalcedony-like quartz, in which the elongated fibers perpendicular to the *c*-axis and showing optical anomalies. Also called lutecine.

**Lutecium;** → Lutetium.

**Lutetium;** a soft, silvery white metallic element of the rare earth group of the Periodic System with the symbol Lu. Also spelled Lutecium.

**luthos lazuli;** an equivalent term for violet fluorite.

**Lu Tung-Pin;** a Chinese term used for a human symbol carved on jade as a older man with a sword and doer stick in hand functioned as protector of magicians. → Chinese ritual and symbol jades.

**lux;** a SI unit of illumination in equivalent to 1 lumen/m<sup>2</sup>. Abbreviation lx.

**lux sapphire;** a misleading term for a blue variety of cordierite (iolite).

**luxullianite;** a term applied frequently to tourmaline rock. Also called tourmalinite.

**Lw;** a chemical symbol for the element lawrencium.

**LWUV;** an acronym for long-wave ultraviolet. → Ultraviolet radiation.

**Lycia;** name of an ancient city and river in Asia Minor (now Turkey), from which the name jet is derived.

**Lydian stone;** a fine-grained, compact, velvet-black variety of chert into jasper, or flint. Used for the test of noble metal. Also called basanite, lydite, touchstone.

**lydite;** an obsolete term for Lydian stone.

**lyncurion;** same as lyncurium.

**lyncurium;** a term used by Theophrastus and Pliny for amber, but supposed to be a hyacinth a variety of zircon, which is used for intaglio. Also spelled lyncurion, lyngurium.

**lyncurium;** a term eventually assigned to the grossular (an amber colored variety of garnet). Also spelled lyncurion, lyngurium.

**lyncurium;** a term eventually assigned to the amber. Also spelled lyncurion, lyngurium.

**lyncurium;** a term eventually assigned to the tourmaline (an amber colored variety of tourmaline). Also spelled lyncurion, lyngurium.

**lyngurium;** another spelling for lyncurium.

**lynx eye;** a variety of labradorite with green iridescence. Also called lynx eye labradorite.

**lynx eye labradorite;** a variety of labradorite with green iridescence.

**lynx sapphire;** a misleading term for pale blue cordierite (iolite).

**lynx stone;** a misleading term for cordierite (iolite).

**lynx tree;** a suggestion that amber is produced by lynx-tree which grew in Liguria, Italy.

**lyoluminescence;** luminescence effect can be seen by dissolving of a substance such as NaCl when contained extra energy in form of color centers.

**lyotropic;** → liquid crystal.



# M m

**m**; abbreviation for meter.

**m.**; abbreviation for meter.

**maacle**; another spelling for macle.

**maadjun-e-chini**; a term applied in Iran for Chinese paste which used to made imitation turquoise. Also called *boreizeh*. → Turquoise imitation in Iran.

**maakbaar**; a Dutch word which means makeable, used by Belgian cutters for a low quality rough diamond, which cannot be cleaved or sawn, but the Indian cutters are specialized in making them. → Makeable.

**mabe**; to artificially insert a hemisphere nucleus in the blister pearl oyster a substance must be chosen, which is not foreign to the oyster. Sometimes hemisphere nucleus beads for mabe cultured pearl are made from steatite (soaponite) a soft mineral because it offers no affinity to nacreous. This covered hemisphere cemented to the inner nacreous wall of mussel, which will cut off from the wall. In Japan steatite hemisphere removed by sawing and hollow nacreous is filled with an especial resinous compound and the base of hollow hemisphere is sealed with a disc of mother-of-pearl, after polishing result a symmetrical large cultured pearl blister. This kind of blister pearl is known as *composite cultured blister pearl* or *mabe pearl*. → Nucleus.

**mabe**; a Japanese term for any style of cultured blister pearl, in which the steatite nucleus has been removed, and a minute half-bead of mother-of-pearl inserted against the mollusk's shell. After a few years the resulting blister pearl is a hemisphere shaped piece. Usually attached to a mother-of-pearl rounded bead of the same diameter. These are grown in Australia but are shipped to Japan for processing and marketing. Also called mabe pearl and spelled mabé pearl. → Blister pearl, half pearl.

**mabe cultured-blister**; → mabe.

**mabe cultured-pearl**; → mabe.

**mabe half-pearl**; → mabe, steatite nucleus for cultured pearls.

**mabe oyster**; certain mussel in cultured blister pearl are known as mabe oyster, which is named as black-winged pearl oyster or *Pteria penguin*. Found in Japan, Chine, Indonesia and Thailand. → Mabe.

**mabe pearl**; same as mabe. → Steatite nucleus for cultured pearls.

**mabé pearl**; same as mabe.

**Mable Bolls Diamond**; an emerald-cut diamond of 44.76 carats, owned by Mable Bolls. It was purchased

in 1950 by Harry Winston, New York City. It was sold in 1966 to an unknown European. It was known as the Queen of Diamonds.

**Macassar shell**; → Queensland shell.

**maccle**; another spelling for macle.

**macedonite**; a bluish-black, fine-grained igneous rock of the gabbro clan. Containing plagioclase, biotite, anorthoclase, and olivine.

**macedonite**; a black, tetragonal mineral with the chemical formula of  $PbTiO_3$ .

**Macente**; → Kerouane.

**maceral**; micropetrological unit such as minerals to rock. Also called macrinite.

**machastone**; another spelling for mocha stone.

**machchakai**; a Ceylonese (Sri Lanka) promotion grade of pearl. → Vadivu.

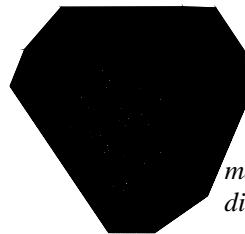
**machiavecchia marble**; a coarse, dark red or brown colored marble in contrast to the gray limestone from the Italian Alps, which is known as machiavecchia marble.

**machine cutting**; → diamond polishing.

**mackle**; same as macle.

**Mackler's glaze**; a variety of aventurine glaze.

**macle**; a grading term in trade for a flat, triangular-shaped, rough diamond crystal, which is twinned



*macle of diamond*

similar to the octahedron of the spinel-twin type. Macle diamonds are difficult to saw due to the different grain

directions that are caused by twinning. Macles are often used for certain industrial applications and occasionally for fancy brilliant cuts. Also spelled mackle, maccle. → Diamond sorting.

**macle**; in crystallography same as twin.

**macle**; in mineralogy same as diamond twin.

**macle**; another term for chiastolite.

**macle**; a dark discolored spot in some minerals.

**macle**; generally a French term for twin of many crystals.

**macled**; spotted, like chiastolite.

**Macquarie River**; location and a river of small diamond deposits in New South Wales, Australia.

**macrinite**; same as maceral.

**macro axis**; → brachy axis, *b*-axis.

**macrocryst**; a term applied to crystals that are large enough to be distinctly visible to the naked eye.

**macrocrystalline**; a term applied to the texture of holocrystalline igneous rocks, in which the crystals are large enough to be distinctly visible to the naked eye.

Also called megacrystalline, eucrystalline.

**macrodome;** a large dome from a crystal in which either two or four faces are parallel to the macro-axis in an orthorhombic system.

**macrometric;** same as phaneritic.

**macromolecule;** a very large molecule of a size visible without need of magnification such as that of hemoglobin, or polymer.

**macro porosity;** porosity visible to the naked eye. Also called macropore.

**macropore;** same as macro porosity.

**macroscopic;** visible to the naked eye or a hand specimen. Also called megascopic.

**maculose;** same as spotted.

**Madagascar alexandrite;** alexandrite from Malagasy (former Madagascar), Africa.

**Madagascar amethyst;** dark amethyst from Malagasy (former Madagascar), Africa.

**Madagascar aquamarine;** a commercial grade for dark-blue variety of beryl from Malagasy (former Madagascar), Africa.

**Madagascar citrine;** brilliant citrine from Malagasy (former Madagascar), Africa. Mostly burned to improve the appearance.

**Madagascarmorganite;** morganite from Malagasy (former Madagascar), Africa.

**Madagascar pearl;** fine pearl from Malagasy (former Madagascar), Africa.

**Madagascar topaz;** a misnomer for citrine from Malagasy (former Madagascar), Africa.

**madanku;** a Ceylonese (Sri Lanka) commercial term for a bend or small folded pearl, but imperfect in form and color. → Vadivu, mondogoe.

**madder;** a dye obtained from ancient from the root of certain Rubiaceae plants. Used as dyes. Also known as alizarin, turkey red, C.I. 75330, and C.I. natural red.

**Madeira citrine;** a misleading term for a wine to reddish-brown colored citrine variety which came from Madeira, Spain. They have been produced by heating amethysts. Also known as Madeira citrine, Grande citrine, Palmyra citrine.

**Madeira citrine cut;** flawless stones are cut faceted, cabochon, and tumbled. Large flawed pieces used for carvings.

**Madeira stone;** same as Madeira topaz.

**Madeira topaz;** a local misleading term for brown quartz crystals of yellow color like Madeira-wine, Spain. Also called Madeira stone.

**Madeira topaz;** a misleading term applied to Brazilian amethyst, which is burned darker.

**madhyama;** a Hindu fabulous for second finger of the hand which is dominated by Saturn, when emerald is worn on may Mercury associated with emerald

because emerald is a friend of Saturn.

**Madhya Pradesh;** a State of Madhya Pradesh State, district of Panna in Central India. There are many locations of alluvial diamond-bearing belts and diamond deposits found along these belts. There are commercially workings in alluvial, conglomerates and two kimberlitic diatems. There are also three kimberlitic pipes the third one is called body of Angor. Also there can found beryls, aquamarines and emeralds.

**Madonna of the Star Sapphire;** a black star sapphire from Queensland, Australia, which roughly weighed 1,100 cts. After engraving a Madonna and Child it weighed 545 cts. It was presented to the American people as a gift by the Kazanjian Bros. Foundation, Pasadena, California to the Smithsonian Institute, Washington, D.C., USA. Occasionally it is on display at the museum.

**Madras pearl;** any pearl from the Madras area, India.

**Madras pearl;** any Persian Gulf and other oriental pearl marketed through Madras.

**Madras pearl;** an American, commercial grade for white pearl with faint bluish of a rosé orient, or lavender tint. → Madras white pearl.

**Madras white pearl;** a commercial name for slightly rosé color pearl from Madras, India. → Ceylon pearl.

**madrepore marble;** a fossiliferous limestone containing madreporoid coral fossils occurring in a variety of colors.

**Mafek;** → emerald, names of.

**Mafeking;** location of small alluvial diamond deposits in Cape Province, South Africa.

**mafic;** silicate minerals based on ferro-magnesian and other nonfelsic minerals actually present in an igneous rock.

**mafic;** any dark-colored rock-forming silicate minerals.

**mafic;** a term for basic.

**mafic;** an abbreviation for magnesium and Fe for iron (**ferric**).

**magalux;** a commercial term for man-made spinel used as a diamond imitation.

**magatama jade;** a Japanese term for a peculiar comma-shaped carved bead made of jade.

**magic;** → magic size.

**magical jewelry;** articles of jewelry worn for their magical belief, medicinal powers, or for superstitions reasons. Often in the form of amulets, pendants, finger rings engraved with charm symbol, religious inscription, or astrological signs. Used as protection from evil, healing, etc. such as abraxas, scarabs, talisman, etc.

**magic carat;** cut diamonds that weighs exactly ¼, ½, ⅓, ¾ or 1 carat, which are easier to sell in the jewelry

trade.

**magic eye;** a commercial term for a reddish-yellow colored imitation of cat's-eye chrysoberyl.

**magic size;** diamond weights of 0.25 cts, 0.33 cts, 0.50 cts, 0.75 cts, and 1.00 cts. Tend to sell more easily than other stones with a point or two less. Also called magic, and magic weight. → magic carat.

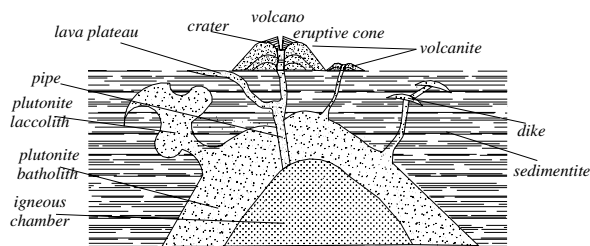
**magic stone;** white, opaque variety of hydrophane (barium feldspar) from Colorado, USA. It is found in rounded lumps with a chalky or glazed coating.

**magic weight;** → magic size.

**Majgawan diamond mine;** location of kimberlite diamond deposit at Majgawan, south-west of Panna, India.

**magma;** a naturally occurring molten or semi-molten material in suspension, with dissolved gases, generated within or beneath the earth's crust and capable of intrusion and extrusion. Magma, which is extruded on the surface of the earth is called *lava*.

**magma chamber;** a large reservoir within or beneath the earth's crust occupied by a body of magma. Also magma



*formation and igneous activity*

reservoir, magmatic reservoir, magmatic chamber, magma pool; same as magma chamber.

**magma pool;** same as magma chamber.

**magma reservoir;** same as magma chamber.

**magmatic assimilation;** → assimilation.

**magmatic chamber;** same as magma chamber.

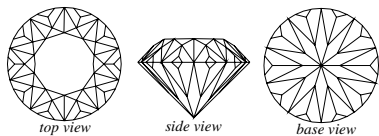
**magmatic digestion;** same as assimilation.

**magmatic reservoir;** same as magma chamber.

**magmatism;** development, movement, and solidification of magma within or beneath the earth's crust.

**magmatite;** a rock which is formed from magma.

**magna cut;** a promotion term for rarely used modification of standard brilliant cut. The magna cut has a 10-sided table, surrounded by 60 crown facets, and



*magna cut*

there are 40 facets and a small culet on the pavilion,

totaling 102 facets.

**magnesia;** same as magnesium oxide (MgO).

**magnesia marble;** dolomitic marble.

**magnesia marble;** marble with dolomite.

**magnesia marble;** also a name for pentacite, predazzite, and opicalcite.

**magnesia mica;** same as phlogopite.

**magnesia tourmaline;** magnesia-rich tourmaline.

**magnesian calcite;** a variety of calcite containing magnesium (Ca,Mg)CO<sub>3</sub>.

**magnesian tourmaline;** magnesia-rich tourmaline.

**magnesioaxinite;** a dichroism variety of axinite. Strong pleochroism: light blue, light gray, light violet, and pyroelectric. Used as cut gemstone the manganese-rich variety is called tinzenite.

System: triclinic.

Formula: 2[Ca<sub>2</sub>(Fe, Mg, Mn)Al<sub>2</sub>B(OH)O(Si<sub>2</sub>O<sub>7</sub>)<sub>2</sub>].

Luster: vitreous.

Colors: brown, clove-brown, gray, green, pale violet to violet.

Streak: colorless.

Diaphaneity: transparent to translucent.

Cleavage: {010} perfect.

Fracture: conchoidal to uneven. Brittle.

SG: 3.33.

H:6½-7.

Optics; α:1.656, β:1.660, γ:1.668.

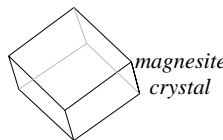
Birefringence: 0.010. ⊖.

Found in Tanzania, Africa.

**magnesiochromite;** an end member of spinel group being similar in appearance and occurrence to chromite (isomorphous with chromite), with the formula 8[(Mg,Fe)(Cr,Al)<sub>2</sub>O<sub>4</sub>]. Cubic system. Black. Opaque. Metallic luster. Cleavage: none. Fracture: uneven. Brittle. SG:4.20. H:5½. Rarely fashioned but it is prized by collectors. Also called picrochromite, magnochromite.

**magnesioschorlite;** a term used for dravite part of dravite-schorl series.

**magnesite;** a member of carbonate group. It is isomorphous with siderite. A rare mineral for cut gems, while the material is relatively difficult to cut. Some faceted stone are seen. Also used as basic refractory material.



System: hexagonalic (trigonalic).

Formula: 2[MgCO<sub>3</sub>].

Luster: vitreous to dull.

Colors: colorless, gray, white, yellowish to brown, sometimes black.

Streak: white to colorless.

Diaphaneity: transparent to translucent.

Cleavage: {1011} perfect.

Fracture: conchoidal to uneven. Brittle.

SG: 3.00-3.12.

H:4-5½. Depends on impurities.

Optics;  $\omega$ :1.700-1.717,  $\epsilon$ :1.509-1.515.

Birefringence: 0.022.  $\ominus$ .

Found in India, Australia, Brazil, Zaire, Korea, Algeria, Russia, and South Africa.

**magnesite luminescence**; may under SWUV glow blue, green or white, often with a green phosphorescence.

**magnesium**; a silvery-white, brilliant metallic element in the alkaline-earth group of the Periodic System, with the symbol Mg. Used in alloys.

**magnesium-aluminum garnet**; another term for pyrope.

**magnesium calcium tourmaline**; magnesium and calcium-rich tourmaline.

**magnesium oxide**; same as magnesia.

**magnesium tourmaline**; magnesia-rich tourmaline.

**magnet**; a body of ferromagnetic or ferrimagnetic, or other material that has a permanent magnetic field and possesses the characteristic of attracting or repelling other mass of iron. Magnets are either temporary or permanent.

**magenta**; an organic red dye, prepared from aniline with compound of:  $C_{20}H_{22}N_3OCl$ . Also called fuchsine.

**magnetic**; pertaining to magnetism or magnet or having magnetic properties.

**magnetic attraction**; → magnetism.

**magnetic influence**; a believing that magnetite or magnetic power promotes the user to straight forward, reality oriented, etc.

**magnetic iron-ore**; same as magnetite.

**magnetic iron- pyrite**; same as pyrrhotite.

**magnetic pyrite**; another term for pyrrhotite, with magnetism effects.

**magnetic response of hematite**; → hematite.

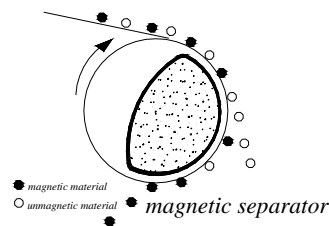
**magnetic response of imitation hematite**; → imitation hematite.

**magnetic response of lithium iron spinel**; → lithium iron spinel.

**magnetic response of magnetite**; → magnetite, magnetic.

**magnetic response of synthetic diamond**; → synthetic diamond.

**magnetic separation**; a technique of use of a magnetic field to separate magnetic particles such as magnetite, hematite, ilmenite, etc. from less magnetic or nonmagnetic materials such as quartz, feldspars, etc. The crushed fragments are

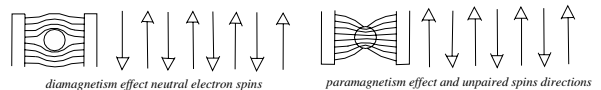


conveyed on a belt past a magnet. Also called isodynamic separation. → Electromagnetic separation.

**magnetic separator**; same as isodynamic separator. → Magnetic separation.

**magnetic twin**; another name for polysynthetic twin.

**magnetism**; a class of physical phenomena involving magnetic fields and their effect upon substances. A property of magnetism is *diamagnetism*, which is a weak effect common to all substances and is repelled by a magnet, caused from the orbital motion of electrons, such as bismuth. In certain materials this

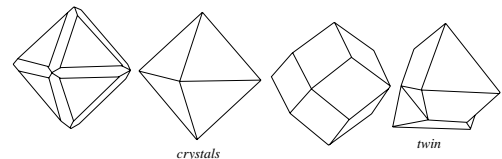


magnetism effect of paramagnetism, diamagnetism and ferromagnetism

effect becomes stronger magnetism by induction, is called *paramagnetism* caused by electron spin, such as cobalt, nickel, iron, steel, etc. and minerals such as olivine, biotite, or pyroxene possessing magnetic ions. Some paramagnetism substances, such as iron, also display *ferromagnetism*, when attracted by a magnet. Force exercised by a magnetized body on one susceptible to magnetization. Proportional  $1/\text{distance}^2$  known as magnetic attraction.

**magnetism effect of pyrrhotite**; → pyrrhotite.

**magnetite**; one of the spinel group with strongly



magnetite crystals and twin

magnetic properties. Sometimes a variety of hematite occurring as an octahedral or dodecahedral crystal, which is pseudomorphous after magnetite with black-iron color and is called *martite*. Frequently cut as a curiosity. Because magnetism effect called *lodestone*. Also called octahedral iron-ore, magnetic iron-ore, black iron oxide.

System: cubic.

Formula:  $8[Fe_3O_4]$ , or  $8[Fe^{+2}Fe^{2+}_3O_4]$ .

Luster: metallic to dull greasy.

Colors: black.

Streak: black.

Diaphaneity: opaque.

Cleavage: {111}.

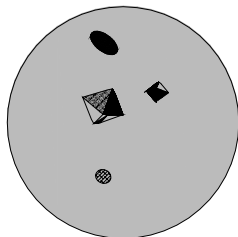
Fracture: conchoidal to uneven. Brittle.

SG: 5.00-5.02.

H: 5½-6½.

Found widespread, but mainly in Italy, Australia, Canada, Mexico, Switzerland, Sweden, Utah (USA), and Russia.

**magnetite as an inclusion;** magnetite as inclusions are



*magnetite crystals in peridot from Hawaii*

found in garnets, feldspars, beryl, diopside, serpentine and quartzite.

**magnetite needle in star diopside;** dark-brown to dark-green variety of diopside with 4-rayed star effect, which is caused by needle inclusions of magnetite that attract magnet.

**magnetite-jade;** a rare, opaque to translucent, variety of jade colored black by magnetite inclusions. SG:3.40-4.40. H: 5½-7. Found in California, USA.

**magnetocrystalline;** those crystals produced magnetic properties.

**magneto-hydrostatic separation;** a method for final sorting of diamond from concentrate of crushed mass and gravels.

**magnetoplumbite;** a natural, opaque, black, hexagonal mineral of  $2[\text{Pb}(\text{Fe},\text{Mn})_{12}\text{O}_{19}]$ . SG:5.42-5.42. H:6. Strong magnetic. Streak is dark brown. Found in Sweden. It was made synthetically.

**magnetoplumbite, synthetic;** it produced synthetically.

**magnification;** an examination of the effectiveness (magnification power) of an optical device in enlarging (or reducing) an objects. The magnification may be lateral, longitudinal, or angular.

**magnification power;** ration of the linear dimension (length or diameter) of the final image to the linear dimension of the object to that seen by the naked eye, or of an optical device or a microscope. Doubling the magnification of the objective will halve the microscope's working distance, assume that the same object would be examined by the naked eye at the least distance of distinct vision, 25 cm.

**magnifier;** any optical instrument, simple microscope, lens or lens system that magnifies an objects.

**magnifying glass;** a device that enlarge an image such as magnifier or a simple microscope. → Lens, hand lens, microscope.

**magnochromite;** same as magnesiochromite.

**magpie;** an informal term used by Australian miners for a small black and white patch occurring together.

**magrebi;** an Arabic term used by Masudi for third grade of emerald, may turnip green in color. → Asamm, bahri, and mor.

**Mahabharata;** a Hindu epic in Sanskrit language containing early information regarding India.

**Maha marakata;** a Sanskrit term for an emerald exposed to the sun, which scattered light around. The term meaning great emerald.

**Mahanadi River;** location and a river of an ancient alluvial diamond deposit in northeast of Golconda, India.

**Mahar (shell);** same as Lingah pearl or shell.

**Maharani Chrysoberyl Cat's-eye;** a green chrysoberyl cat's-eye of 58 cts. Now on display at the Smithsonian Institution, Washington, D.C. USA. It believed to be from Sri Lanka (former Ceylon).

**Maharatnani;** five traditional gemstones of the Hindu religion, Indian, that for centuries have been the diamond, pearl, ruby, emerald, and sapphire.

**Mahjal Diamond;** same as Algeiba Star Diamond.

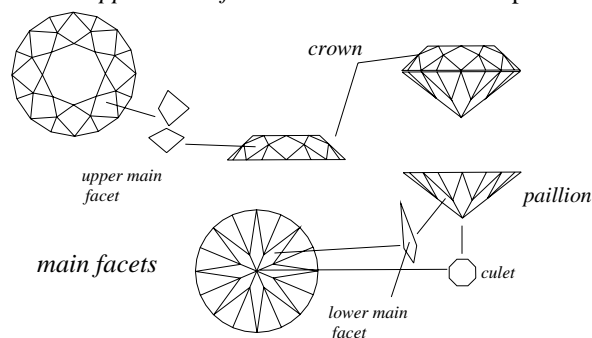
**Mohammed IV Diamond;** same as Mahomet IV Diamond.

**Mahomet IV Diamond;** a diamond of 24.76 cts, found in Constantinople by a poor man, but later purchased by the Grand Vizier of Mahomet IV (1648-1687) and added to the Imperial Treasure, Turkey. Also called Mohammed IV Diamond. Present whereabouts unknown. May be apocryphal.

**maiden pearl;** any virgin or new fished pearl.

**main;** a term used by Australian miners for the next above the bottom.

**main facets;** a general term for 8 facets on the crown called *upper main facet* and 8 facets on the pavilion



called *lower main facet* of a brilliant cut diamond or other transparent gemstones. Also an alternate name for kite facet. → Bezel facet, pavilion facet.

**Maitreya;** a Chinese term used for a Laughing Buddha figure carved on jade as. → Chinese ritual and symbol jades.

**Majhgawan;** location of an alluvial diamond deposit at Ramkharia in northeast of Golconda, India. Operated by National Mineral Development Corporation.

**Major Bowes Diamond;** a yellow diamond of 44.50 cts, owned by Major Bowes. He willed it to Cardinal Francis Joseph Spellman of New York. After this it passed through a few hands until in 1958 was purchased by Jack M. Werst a gem dealer from Miami, Florida, USA. It was stolen and never found.

**Majorca;** a Spain Island in the Mediterranean where imitation pearls are made. → pearl synthetic of Majorca.

**Majorica;** a local commercial term for imitation pearls made in Majorca, Spain. → Pearl synthetic of Majorca.

**Majorcan synthetic Majorca;** a kind of synthetic pearl made in Mancor in Majorca Island of Spain, which is hardly to distinguish from true pearls. The surface of these pearl has not warty appearance as a true pearl. Also called Majorca or Mallorca synthetic pearl.

**majorite;** a variety of red to purple garnet found in meteorite. Cubic crystal. Formula:  $8[\text{Mg}_3\text{Fe}(\text{Si},\text{Al})(\text{SiO}_4)_3]$ . SG 4.00. H:7-7½. An alteration mineral of pyroxene by high pressure.

**make;** a commercial term for the quality or perfection of the cut diamond and other gemstones referring to correctness of the proportion, symmetry, natural, or extra facets and polishing, for example well-made stones or stones of fine make; refers to a stone that is well proportioned, symmetrical, and well polished, a lumpy stone, a swindled stone.

**make;** simply cut of a diamond.

**make;** a term used by Australian miners for to form into first class opal or gem opal.

**make;** a term used by Australian miners for to strike a reasonable mine may make opal.

**makeable;** a commercial term for the rough diamond such as crystal, cleavage, macle, or chip, which must be polished without the need for preliminary sawing, cleaving, or splitting. Also called whole stone. Also spelled maakbaar.

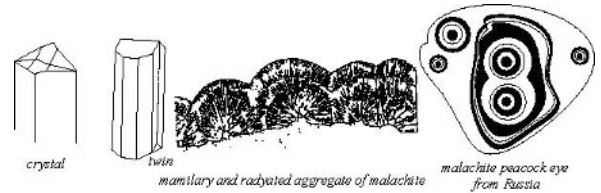
**makers of rosaries;** → paternostermakers.

**making up;** a commercial term for weighing and size sorting of rough diamond in the De Beers Central Selling Organization.

**majkaat;** an ancient Egyptian name for turquoise.

**malachite;** a compact, soft, and sometimes alternate irregular concentric agate-like bands of light and dark green. The surface may also be mammillary aggregated. A dimorphous mineral with georgeite. Used in jewelry to cut cabochon, beads, brooches, pendants, carved

objects. Also used as ornamental vases, table, inlaid work, etc. When the botryoidal mass, shows in cut section a concentric pattern, which is called *malachite peacock eye* or *peacock stone*. Often associated with azurite and called *azurmalachite*. Frequently the related



*malachite crystal, twin, mammillary aggregate and peacock eye*

azurite is misnomered as *blue malachite* to distinguish it from normal- or green-malachite. It display vividly green, yellow, and deep green pleochroism. Also called mountain green and erroneously *silver peak jade*.

System: monoclinic.

Formula:  $4[\text{Cu}_2(\text{OH})_2\text{CO}_3]$ .

Luster: adamantine, vitreous to dull.

Colors: various shade of green to dark green, emerald green, greenish-black.

Streak: light green.

Diaphaneity: translucent to opaque.

Cleavage: {001} perfect.

Fracture: conchoidal to uneven. Brittle.

SG: 3.08-4.03.

H:3½-4.

Optics;  $\alpha$ :1.655,  $\beta$ :1.875,  $\gamma$ :1.909.

Birefringence: 0.254. ⊖.

Found in Zambia, Australia, Namibia, France, Russia, Chile, South Africa, Zimbabwe, Arizona (USA), Mexico, and Congo.

**malachite, black;** an erroneously term used for chalcedony containing small plumes of black manganese mineral (psilomelane), which occurs in bands. It is used for the cabochon cut. Also called psilomelane chalcedony, or crown of silver.

**malachite cut;** usually cut cabochon, beads, brooches, pendants, inlay purpose, carved and flat ornamental objects. Some pieces found together with chrysocolla are polished.

**malachite green;** a toxic, green, organic substance of  $\text{C}_{23}\text{H}_{25}\text{ClN}_2$ , soluble in water and alcohol, used as dye.

**malachite green;** a pigment generated of ground malachite.

**malachite-jade;** a commercial misleading term for a green variety of chrysodor.

**malachite lapis;** a trade term for an ornamental stone

consisting of intergrowths of malachite ca. 60% and quartz 40% in compact or botryoidal form Utah, USA.

**malachite peacock eye;** → malachite.

**malachite, synthetic;** → synthetic malachite.

**malacolite;** a light-green colored translucent variety of diopside.

**malacon;** a brown, vitreous, partially altered, hydrated or metamict variety of zircon containing the element hafnium as impurities. Also spelled malacone.

**malacone;** same as malacon.

**Malakialina Quarry Beryl;** a giant size beryl of 23 meters long and 1.5-2 meters in diameter, found in pegmatite of Malakialina field, Malagasy.

**malaquita;** a Spanish spelling for malachite.

**malaya;** a term used by Swahili, it means prostitute (out of the family), used for orange to reddish-orange rhodolite garnet from Zimbabwe, Africa. Traces of vanadium and chromium caused the color. Also called rejects.

**Malaya Botuoboya;** location of a diamond deposit in Sakha, Yakutia, the Russian Federation, CIS. Said to be the first diamond deposit from the region. Also called the Lesser Botuobiya.

**Malaya garnet;** garnet from Malaya.

**malchite;** a term applied to fine-grained lamprophyre.

**maldonite;** a term applied to black gold or bismuth gold with the approximately formula  $Au_2Bi$ .

**male;** once used as the stones with dark color and more brilliance other than the female counterpart such as dark colored ruby. → Male ruby, female.

**male carbuncle;** a synonym for dark colored carbuncle.

**male ruby;** a synonym for dark colored ruby.

**male sapphire;** a synonym for dark colored sapphire to distinguished it from light colored or female.

**Mali Federation;** location of 20 kimberlittic diamond deposits in western part of Mali, West Africa. Found in palaeoplacer deposits. Also called West Sudan.

**malleability;** property of some metals, minerals and alloys, which permits plastic deformation by hammering or rolling without rupture. Gold is most malleable of all metals it can be beaten into 1 millionth mm thin. Lead is the most easiest metal to roll of all metals but here gold is in third place.

**malleable;** characteristic of metals, minerals and alloys they are able to be shaped or extended by hammering, pressing or rolling, such as gold or silver.

**malleable mineral;** a mineral that may be altered by compressive stress, such as hammering, such as native copper, gold, platinum or silver.

**Malleidae;** a group of salt-water bivalves containing the hammer shells and pearl oysters with pearly interiors. → Pteriidae.

**mallet;** a sledge hammer used for striking mineral or

rock. Also called hammer.

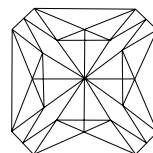
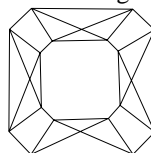
**Malleus;** a genus of salt-water pear mollusks of Malleidae containing the hammer shells found on the Pacific coast of USA. The pearls are brass-colored to black without iridescence. SG: 2.21-2.66.

**Mallin Diamond Mines, Ltd.;** a diamond mining company works at Zwartuggens in Transvaal, South Africa.

**Mallorcan pearl;** a misleading term for a variety of simulated pearl from island Majorca or Mallorca, Spain. → Pearl synthetic of Majorca.

**Mallorca synthetic pearl;** a variety of simulated pearl from island Majorca or Mallorca, Spain. → Pearl synthetic of Majorca.

**Maltese Cut;** a modified 8-sided (square cut with blunted edges) brilliant-cut similar to Maltese Cross. In



*modified Maltese-cross cut*

this cut with 20 facets and a 8-sided table in the crown. In the pavilion are 36 facets without culet with four-rayed lozenge star like a cross.

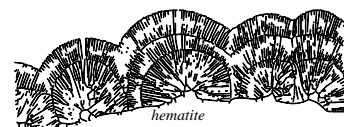
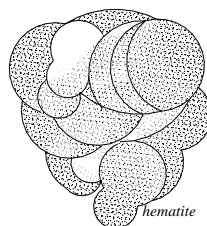
**maltesite;** an obsolete term for variety of andalusite, resembling chialstolite, showing a Maltese cross in its making. The cross having four equal arms. Found in Finland. Used as brooches, pendants, or as ornamental or good luck charms. Frequently called the *Cross of St. John*.

**Maludi Mine;** location of alluvial diamond deposits in Angola, Africa.

**Mambéré River;** location and a river in Central African Republic, along which are found alluvial diamond deposits.

**mammilated;** a mineral aggregate showing large smooth, hummocky rounded surface, not unlike breasts, such as malachite.

**mammillary;** a describing term for external mineral aggregates or crystals with smooth, hummocky rounded surface, not unlike breasts or portion of spheres. For



*mamillary aggregate of hematite and malachite*

example: malachite or limonite. Larger than botryoidal aggregate. → Reniform.

**mammoth ivory**; → fossil ivory, odontolite, belemnite.

**Manana Mine**; location of a small alluvial diamond mine in Transvaal, South Africa.

**manchandi**; a Sri Lanka (Ceylonese) weight unit equal to 1.15 cts.,

**Manchurian jade**; a misleading term for hard brown soapstone or steatite from Manchurian, Asia.

**Manchurian jade**; a term used incorrectly to refer to burned talk or soapstone.

**Mancini Pearls**; a pair, drop-shaped, true pearls of 400 grains, mounted in a pair of ear-rings with a floral ornament mounted with diamonds. It was presented by Charles I, to Queen Henrietta maria of England as a wedding gift. She sold it to her nephew, Louis XIV, and he donated to Maria Mancini, the niece of Cardinal Mazarin. She married Prince Colonna, Italy. The ear-ring remained in Colonna family, later owned by Rospigliosi family. At least it was sold by Christie's of New York in 1979.

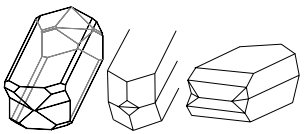
**Mandarin necklaces**; there are two kind of traditional necklaces used in China: (I) beads necklace must be round, uniform in size and 108 pieces, because each bead is a significant for its own religion. (II) Another kind of amber bead is tabular or flat in form.

**mandelstone**; another term for amygdaloid.

**mandorla**; another term for aureole.

**man-eating clam**; same as *Tridacna gigas* linné.

**Manebach twinning in feldspar**; a commonly feldspar



*orthoclase Manebacher twins*

twin law of both monoclinic and triclinic with the twin plane and composition plane of [010]. → Twinning in feldspar.

**manganandalusite**; a translucent, green variety of andalusite containing nearly 7%  $Mn_2O_3$  with strongly pleochroism from Vestana, Sweden. Also called viridine, manganandalusite.

**manganblende**; same as alabandite. → Almandine.

**manganepidote**; a brownish red variety of epidote contain manganese oxide. → Piemontite.

**manganese**; a hard, brittle, silver-grayish metallic element of seventh group of the Periodic System with the symbol Mn. An element mainly responsible for pink to red color in mineral and gemstones such as rhodonite, morganite, spessartite garnet, and rhodochrosite. Used in many alloys and in steel industry. → Manganese epidote, piemontite.

**manganese-aluminum garnet**; synonym for spessartite.

**manganese carbonate**; another term for rhodochrosite.

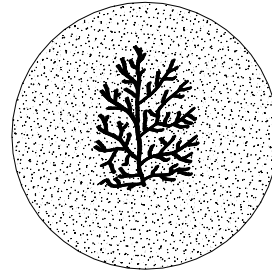
**manganese dioxide**; a black abrasive powder used in polishing gemstones. Formula:  $MnO_2$ .

**manganese epidote**; another term for piemontite. →

Manganepidote.

**manganese garnet**; synonym for spessartite.

**manganese oxide as inclusions in rose quartz**; a



*typical dendritic formation of manganous oxide in rose-quartz*

dendritic pattern of manganese oxide seen in some rose quartz.

**manganese silicate**; same as rhodonite or a mineral of  $5(MnSiO_3)$ .

**manganese spar**; a general term for both minerals; rhodonite and rhodochrosite.

**manganese spectrum**; there are two narrow bands situated at 448.50 and 423 nm in the violet and a band in the green at 550 nm. The spectrum can be seen in rose-pink or pink-red colored stones due to manganese such as rhodonite, rhodochrosite, etc.

**manganandalusite**; a synonym for viridine.

**manganocolumbite**; → manganotantalite.

**manganodravite**; mangan-rich dravite tourmaline.

**manganomelane**; same as psilomelane.

**manganoniobite**; → manganotantalite.

**manganopectolite**; a manganese rich variety of pectolite.

**manganosiderite**; an intermediate between rhodochrosite and siderite.

**manganotantalite**; a variety of columbite. A mineral with pleochroism in shades of brown, red brown, dark red, and light violet. Also called manganocolumbite, manganoniobite, magnesianiobite. Sometimes act as an ornamental mineral and it is prized by collectors.

System: orthorhombic.

Formula:  $4[(Mn,Fe,Mg)(Ta,Nb,Ti)_2O_6]$ .

Luster: vitreous to resinous.

Colors: red, reddish-brown to brownish black.

Streak: deep red.

Diaphaneity: transparent to opaque.

Cleavage: {100} distinct, and {100} indistinct.

Fracture: conchoidal to uneven. Brittle.

SG: 7.73-7.97.

H: 5½-6½.

Optics:  $\alpha$ : 2.14-2.19,  $\beta$ : 2.15-2.25,  $\gamma$ : 2.22-2.34.

Birefringence: 0.008-0.015. ⊕.

Dispersion: high.

Found in Malagasy, Russia, Sweden, Western Australia, Brazil, Mozambique, Portland, Virginia, and California, USA.



**mangelin**; an old Indian weight unit equal to 1.75 cts.

**manik**; a local term in East India for green to greenish diamond.

**Manila copal**; copal or gum or dammer from Manila, Philippine which produced by trees of the genus *Agathis* found in Indonesia and Philippine. R:1.544. SG:1.072. Also called Manila gum.

**Manila garnet**; light to dark pinkish orange, red and yellowish orange garnets from Manila consisting mainly of pyrope and spessartine, which exhibit different daylight to incandescent color. Daylight color is none in predominantly blue. H:7-7.50, SG:3.81 ± 0.03-0.04. RI:1.760 ± 0.19. Also called color-change garnet.

**Manila gum**; same as Manila copal.

**Manila pearl**; pearls from various islands of the Philippine, which are marketed through Manila. → Philippine pearl, Manila shell.

**Manila shell**; pearl shell obtained from Philippine islands. → Manila pearl, Macassar shell.

**Mani-Málá**; a classic gem treatise book from the famous Indian Author Tagore, Sourindro Mohun, who write the book in Sanskrit, Hindu, Bengali and English, 1879 and 1881. Suggested that he translated several unspecified sources and believed to be Purana. Mani-Málá meaning Chain of Gems.

**Man jade**; a Chinese name for a blood-red variety of jade. Also called man Yü.

**man made diamond**; any diamond made synthetically. Also called synthetic diamond.

**man made rock**; rock made synthetically. Also called artificial rock.

**man made stone**; any synthetic gemstones that have a counterpart in nature such as diamond, ruby, sapphire, etc. or have not counterpart in nature such as GGG, YAG, and lithium niobate. Terms such as imitation and simulant applied to any material natural or synthetic, which can be misused for another stone. Also called synthetic stone, manufactured stone.

**Mannheim gold**; → tombac.

**mansfieldite**; a rare gem mineral isotype with scorodite and strengite. Sometimes cut as gem and prized by collectors.

System: orthorhombic.

Formula:  $8[\text{Al}(\text{AsO}_4) \cdot 2\text{H}_2\text{O}]$ .

Luster: vitreous.

Colors: white to pale gray.

Streak: brownish-gray.

Diaphaneity: transparent to translucent.

Cleavage: {201} imperfect, {001} trace, and {100} trace.

Fracture: subconchoidal to uneven. Brittle.

SG: 3.28-3.29.

H:3½-4.

Optics;  $\alpha$ :1.741,  $\beta$ :1.744,  $\gamma$ :1.768.

Birefringence: 0.027. ⊕.

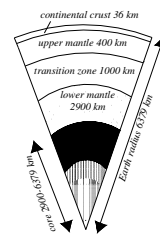
Found in Idaho, Oregon, and Utah (USA), Canada, Japan, Brazil, Namibia (Africa), Mexico, and England.

**mansfieldite, pleochroism**; strong purplish-blue.

**mantle**; the protective soft inner film tissues of the pearl-producing mollusk, having the form of flaps enclosing the trunk and are responsible for secretion of the shell and nacre. → Ectoderm.

**mantle**; in crystallography the outer zone in zoned or an over growth crystal such as *mantle quartz*. Also called jacket.

**mantle of the Earth**; the part of the Earth below the crust and above the core (between Mohorovicic discontinuity and Gutenberg discontinuity) with a depth from 35 km to 3480 km, which separated into



*mantle and internal structure of the earth*

two the upper mantle and the lower mantle, with a transition zone between. The density ranges from 3.3 to 5.7

(from Mohorovicic discontinuity to Gutenberg discontinuity). Probably consists mainly of olivine and garnet hence known as garnet peridotite shell. It represents about 84% of the Earth's volume and 68% of its mass. Also called mantle.

**mantle**; a synonym for mantle rock or regolith.

**mantle**; mantle or pallium of shell is a flap tissue which surrounded and covered the soft body part of the oyster and is thickened at the edges in bivalves which is darker in color than other interior part and consisting of numerous connective tissues and blood spaces with an extensive colorless blood supply.

**mantle of pearl**; synonym for cyst pearl.

**mantle quartz**; quartz crystal, which has the appearance of a clock or mantel found at Safien, Grisons, Switzerland. → Mantle.

**mantle rock**; → mantle, regolith.

**manufactured stone**; in gemology any man made stone, synthetic stone, composite stone or artificial stone.

**manufacturing**; finishing of a rough diamond into a fashioned stone a process, which involves five-stages: design, cleaving, splitting (or sawing), bruting, and polishing.

**manul**; a Sri Lanka (Ceylonese) term for loose or soft sand sea-bottom.

**manual excavating**; ame as hand digging.

**Manx stone**; a variety of china stone free from fluorite. Found in Foxdale, Isle of Man, China.

**man Yü**; same as man jade.

**mao**; a Chinese term for a short table and a sign of authority used by the Emperor, carved from jade. → Chinese ritual and symbol jades.

**Maori jade**; a green variety of nephrite from New Zealand, it was used for ornaments and weapons by Maoris. The native name is *punamunstone*, *punamu* or spelled *pounamu*. Also called Maori stone, axe-stone, New Zealand greenstone. → Mere, hei tiki.

**Maori stone**; another term for Maori jade.

**maoyan toushanshi**; a Chinese term for green cat's-eye tremolite used as jade.

**maoyan yu**; a Chinese term for green cat's-eye nephrite used as jade.

**mar**; same as mor.

**maragda**; an Ethiopian term for emerald. → Emerald,-names of.

**maragde**; a French term for emerald. → Emerald,-names of.

**Maragdos**; a German term for emerald. → Emerald,-names of.

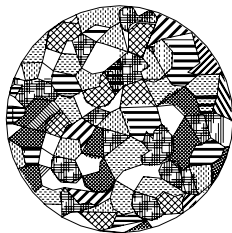
**marakihau jade**; a Maori term for a sea monster cut on jade for ornamental purpose or amulet by native of New Zealand.

**marakata**; a Sanskrit term for emerald. → Emerald,-names of.

**marakatam**; a Sanskrit term for emerald. → Emerald,-names of.

**Maramures diamond**; a misleading term for quartz crystal from Hungary.

**marble**; a massive crystalline aggregate form of limestone apart from metamorphosed calcite. Marble is never perfectly transparent because impurities mark the nature of the original carbonate. The stone often has saccharoidal aggregate and is variously colored in patches or streaks depending on their chemical and mineralogical composition. The best known marble is the Parian, from Paros or Minoa Island in the Cyclades, Athens, Greek, Carrara, Tuscany, Italy. In ancient times the term *marble* included many stones regardless of composition such



crystalline marble aggregate under microscope

as porphyries (which were named *marmor Lacedaemonium viride*) and fine granites such as *marmor claudianum* from Egypt. The varieties of marble are: Egyptian-marble, onyx marble, fire-marble, birds-eye marble, shell-marble, black marble, ruin-marble, travertine (compact limestone). It takes a good polish and is therefore used for ornamental purposes, building, sculptures, figures, decorative stones and

frequently in Thailand as nuclei beads for cultured pearl. Some varieties used in jewelry are known as onyx marble; Mexican onyx, Mexican jade. → Treatment of marble.

**marble bar-jade**; a term used incorrectly to refer to chlorite. Also called Pilbara jade.

**marble fabric**; same as marble texture.

**marble,-commercial**; a term used in trading to true metamorphic marble or those recognize by mineralogist as polishable such as serpentine rock, which is known as real antique and certain crystalline limestone capable of taking a polish or of being used for architectural and ornamental purposes.

**marble cutter**; → stonecutter.

**marble of Carystus**; an alternate band of white and green variety of cipolino marble from Euboea Island, Greek, which is known as marble of Carystus.

**marble quarry**; same as marble surficial mine or open working.

**marble, ruby in**; → ruby in marble.

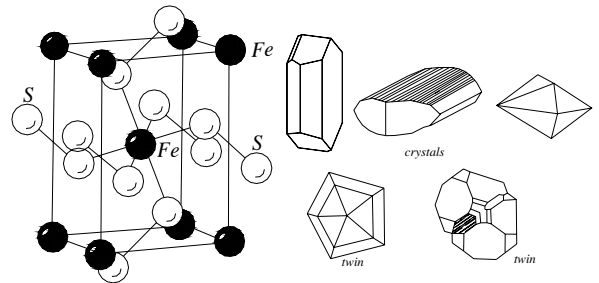
**marble, treatment**; → treatment of marble.

**marble, true**; → true marble.

**marble worker**; → stonecutter.

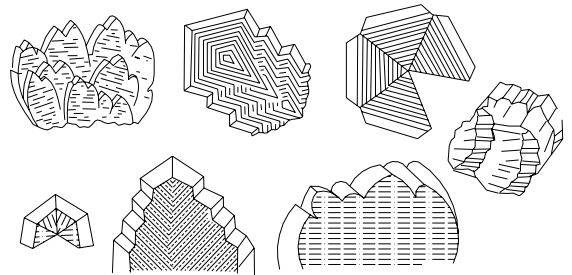
**Marbodus poem**; → Lapidary of Marbodus.

**marcasite**; an unstable dimorphous form of pyrite, which later became a misnomer as *white pyrite*. It was used in jewelry in ancient times. A spear-shaped or



marcasite structure, crystals and twins

flattened crest-like twin of marcasite is named as



repeated twinning of marcasite or so called cockscomb

*cockscomb pyrite*. Frequently has been mounted as a marquise ring, therefore it has sometimes been

misnomerly spelled *marquisite*. It has been set in white-metal setting or a pavé setting, or cut cabochon or as *flattened rose cut* with flat backs. It was probably used by the Incas as mirrors, and known as *Pierre des Incas*. *Thunderbolts* is a local term for small nodules of pyrites found in Sussex, England. Occasionally misused the term *fool's gold*, which is a name for pyrite. A misleading term is *auriferous pyrite*, which contains no gold of commercial value. Imitation are made variously from plastics, glass, and cut steel. Also called binarite, polio-pyrite, radiated pyrite, melnikovite marcasite.

System: orthorhombic.

Formula:  $2[\text{FeS}_2]$ .

Luster: metallic.

Colors: light brassy yellow to yellowish-green.

Streak: greenish black.

Diaphaneity: opaque.

Cleavage:  $\{110\}$  imperfect.

Fracture: conchoidal to uneven. Brittle.

SG: 4.85-4.92.

H: 6-6½.

Found in Oklahoma, Illinois, Missouri, Wisconsin (USA), England, Germany, France, Bolivia, the Czech Republic, and Austria.

**marcasite cut**; in jewelry cut as gems and mounted as a marquise ring, which spelled marquisite or as a flattened rose cut. Set in white-metal setting or a pavé setting, or cut cabochon or as flattened rose cut with flat backs.

**marcasite imitation**; imitations are made from variously plastics, glasses, and cut steel but are easily distinguishable.

**marekanite**; a term applied to small bead-shaped or rounded to subangular, smoky-brown, gray, or black decomposed variety of decomposing perlitic obsidian (natural glass). The particles are in masses of perlitic rhyolitic clear glass, which are of special interest because of their low water content as compared with perlite. Found in Marekanka River, Siberia, Russia and Mexico. Frequently called obsidianite.

**margad**; a Tibetan term for emerald. → Emerald, -names of.

**mar-gad**; → emerald, names of.

**margad**; a Tibetan term for merald.

**margarita**; an ancient Latin term for pearl.

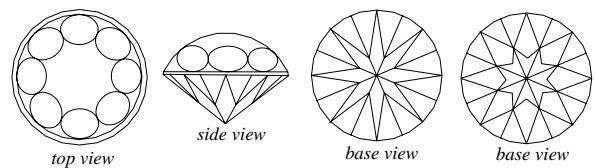
**margaritaceous**; pertaining to or resembling a pearl.

**margarite**; a phyllosilicate mineral with complex sheet-like structures of the mica group. Chemical formula:  $4[\text{Ca}, \text{Al}_2(\text{Si}_4\text{Al}_4)\text{O}_{10}(\text{F}, \text{OH})_2]$ . Monoclinic system. Yellow, Grayish, pink, and green. Pearly luster. Translucent. Brittle. Cleavage:  $\{001\}$  perfect. Optics;  $\alpha$ : 1.630-1.638,  $\beta$ : 1.642-1.648,  $\gamma$ : 1.644-1.650. Birefringence: 0.013.  $\ominus$ . SG: 3.00-3.01. H: 3½-4½.

Found as platy to scaly aggregates. Also called lime mica, pearl mica, calcium mica. Used as ornamental stone.

**margarites**; an aggregate of small fused bead-like strings or globulites and crystallites, found as a texture in glassy igneous rocks or obsidian (natural glass), when examined under microscope. While acicular crystallite having rounded ends are known as *globulite* and those rod-shaped or elongated globulites crystallite as *belonite*.

**margarite cut**; a modified round brilliant cut similar to buff-top cut with some deepening circles or elliptic forms which giving a pattern like margarite flower. The



*margarite cuts with two different bases.*  
After Maloney

Pavilion is in two different cut forms.

**Margaritifera**; an important genus of fresh-water pearl-bearing mollusk known as *Pinctada*. They have different colors and different varieties, found in the northern hemisphere. *Margaritifera martensii* pearls are *Margaritifera margaritifera*, silvery white in color, *Margaritifera carcharium* has yellow pearls, *Margaritifera maxima* pearls are silvery white, *Margaritifera vulgaris* pearls are light creamy. Also spelled Margaritiferidae. → Pinctada.

**Margaritiferidae**; same as Margaritifera.

**margaritiferous**; same as pearl bearing. Pearl containing material.

**margaritomancy**; a method of divination by pearls, used as good-luck charms. → Lithomancy.

**maria glass**; a term applied to an early time for both selenite and mica mineral

**marialite**; a colorless to white, gray, brown, isomorphous end member of scapolite group with chemical formula:  $3[\text{Na}_3(\text{AlSi}_3\text{O}_8)\cdot\text{NaCl}]$ . Isomorphous with meionite. Tetragonal system. Optics;  $\omega$ : 1.546-1.550,  $\varepsilon$ : 1.540-1.641. Birefringence: 0.008.  $\ominus$ . SG: 2.50-2.62. H: 5½-6. frequently used as ornamental stone.

**Mari diamond**; a misleading term for a variety of quartz crystal found in Kalabagh and Mari, India. Used as cheap necklace or other articles.

**Maria Diamond**; a Russian rough diamond of 106 cts, found in 1966 by Maria Komemkima in Sakha,

(Yakutia), the Russian Federation, CIS. Now on display at Russian Diamond Fund in Moscow.

**Marie Antoinette Blue Diamond;** a grayish-blue, pear-shaped diamond of 5.46 cts. It is mounted in a finger ring believed to have belonged by Marie Antoinette. Now privately owned.

**Marie Antoinette Earrings;** a pair of diamond ear-ring each weighing 36 cts, which belonged to Marie Antoinette until 1791. Now the stones are set in platinum. Present by Mrs. Eleanor Close Brazin to the Smithsonian Institution, now on display at the Museum of Natural History, Washington, D.C., USA.

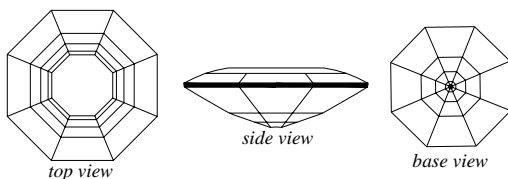
**Marie Antoinette Diamond Necklace;** it has been described as several graduated strings mounted with 647 brilliant-cut and pear-shaped diamonds of 2,840.00 cts. It believed never owned by Marie Antoinette, Consort of Louis XVI of France. It was divided and brought to England and sold in 1785. The largest diamonds were reset in another necklace. Now owned by the Duke of Sutherland. Also called Marie Antoinette Rivière or Collier de la Reine.

**Marie Antoinette Rivière;** same as Marie Antoinette Necklace.

**Marie Louise Necklace;** a necklace including 172 diamonds weighing 275 cts, 28 rose cut diamonds and 19 pear-shaped stones, set in a silver mount. Later it was presented by Napoleon to his second wife, Marie Louise, on the birth of Napoleon II in 1811. It was present by Mrs. Marjorie Merriweather Post to the Smithsonian Institution and it is presently on display at the Museum of Natural History, Washington, D.C., USA.

**Marie Louise Tiara;** a silver tiara, set with 950 diamonds of 700 cts. Originally it was mounted with emeralds, later there were replaced by 79 turquoises cut cabochon of 540 cts. It was a presented from Napoleon to his second wife, Marie Louise, on the birth of Napoleon II in 1811. It was present by Mrs. Marjorie Merriweather Post to the Smithsonian Institution and it is presently on display at the Museum of Natural History, Washington, D.C., USA.

**Marigold Cut;** a registered name for one of 5 Flower



*Tolkowsky Marigold flower cut.*

Courtesy of De Beers

style cuts, an 8-sided full symmetrical step-cut, with a

large table. It can be polished as a hexagon with 73 facets specially for strong colors and higher yield of material. It is said to improve the color and reflection. Designed by CSO consultant Gabi Tolkowsky in 1988. Proportions are: Table 51%, crown height 12.5%, pavilion depth 35% and girdle very thick. → Flower Cuts; Fire Rose Cut, Dahlia Cut, Sunflower Cut, Zinnia Cut.

**marine deposit;** a coastal alluvial placer deposit, which is found along the shore and laid down in the ocean or sea, usually beyond the seaward edge of the littoral belt such as Namibia, Africa. The configuration of marine deposits results in the transportation of valuable minerals usually by rivers to an ocean. → Marine Diamond Corporation, marine terrace.

**Marine Diamond Corporation, Ltd.;** an association founded in 1961 to mine off-shore diamond deposit along the coast of Namibia, Africa.

**marine terrace;** a narrow wave-cut coastal shelf that has been exposed by built a seacoast or by the lowering of the sea level. Diamonds are found north and south of the delta of the Orange River in southern Africa.

**mariposite;** a soft, foliated rock with pale green streaks of fuchsite, a variety of mica in white groundmass. Used for ornamental objects.

**mark;** a name frequently used as a substitute for the more emphasis clarity grading terminology for diamonds; such as very slightly marked instead of very slightly imperfect.

**mark;** marks on jewelry include a Hallmark, trade mark, patent mark, etc.

**markat;** → emerald, names of.

**marking;** the identification of the cleaving and sawing instructions on a rough diamond with Indian ink to shows how it is to be sawed.

**markings;** → growth markings.

**marl;** an old term loosely applied to an argillaceous sediment rock, containing a variable amount of calcareous material such as dolomite and calcite, derived from shell remains.

**marlaceous limestone;** same as marly limestone.

**Marlborough Diamond;** a cushion-shaped diamond of 48.01 cts, without table owned by Gladys Marie Spencer-Churchill, wife of the 9<sup>th</sup> Duke of Marlborough, it was sold at Christie's, London. The diamond was purchased by Laurence Graff, who recut it in the form of a sun-burst weighing 45 cts, it was stolen in 1980. Also called radiant cut.

**marlite;** → marlstone.

**marlstone;** any sandy mixture of clay and calcium carbonate contains 25% to 75% clay, which is similar to marl. Also called marlite.

**marly;** same as marlaceous.

**marmarosch diamond;** a misleading term for a variety of quartz crystal.

**marmatite;** a black Fe-rich variety of sphalerite. Also called christophite.

**marmol;** a Spanish term for marble.

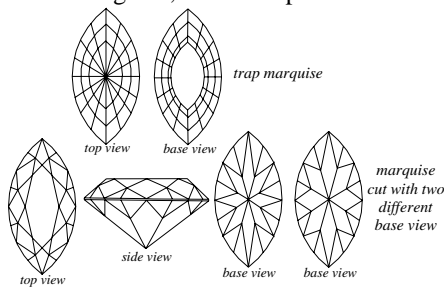
**Marmora diamond;** a misleading term for a variety of quartz crystal.

**marmor claudianum;** an old misleading term for a pale fine granite from Egypt regardless of composition.

**marmor Lacedaemonium viride;** an old misleading term for a green pyroxene porphyry containing light green feldspar regardless of composition. Green color is caused by epidote and chlorite. Found in Laconia, Greece. Erroneously it was later named as *porfido serpentino*. Used as ornamental stone. Also called porfido verde antico.

**marmstone;** an obsolete name for marble.

**marquise;** a term applied to a diamond that is cut in the form of a marquise brilliant-cut, in which the girdle outline is elongated, boat shaped with a hexagonal



two different kind of marquise or navette cut

table. There are 32 facets on the crown and 24 facets on the pavilion and a culet. Also called marquise cut. Frequently is called *navette*. → Marquise rose cut.

**marquise;** → marquise setting.

**marquise cut;** → marquise.

**marquise rose cut;** a rose cut modification of cutting a diamond or other transparent stones with 57 facets, so that the stone has an outline of elongated, boat shaped (elliptical, pointed at both ends). Without the table and a flat base, which is similar to the pendeloque rose cut. → Marquise.

**marquise setting;** a modification of mounting for a finger ring, which is elliptical-shaped and pointed at both ends.

**marquisite;** → marcasite.

**marsh gas;** same as methane.

**Martapura;** a small city in Indonesia known for diamond manufacturing and a commercial center in southeastern Kalimantan,

**Martin Pink Diamond;** a flawless, pink, round brilliant diamond of 12.03 cts, purchased by Harry Winston in 1975. It was named as Martin Pink in July 1976 in

honor of the American landing of a scientific probe on the surface of the planet Mars. Sold to an Unknown client.

**martite;** a black-iron variety of hematite ( $\alpha\text{-Fe}_2\text{O}_3$ ) occurring as an octahedral or dodecahedral crystal that is pseudomorphous after magnetite. SG:4.80. H:6-7. Found in Utah (USA), Brazil, Ural (Russia), and Transvaal (South Africa). Sometimes used as a curiosity. → Magnetite.

**marvelite;** a commercial term for synthetic strontium titanate used as a diamond imitation.

**marvella pearl;** a commercial term for imitation pearl.

**Maryland amber;** an unimportant amber deposit found as small pellets in sands in Anne Arundel County, Maryland, USA.

**Masai anyolite;** → anyolite.

**masaku;** Ceylonese (Sri Lanka) commercial pearl grading includes: usually spherical but badly gray colored pearls with luster. Also spelled masanku.

**masaku;** irregular pearls in shaped and color. Also spelled masanku.

**masanku;** same as masaku.

**Mascarenhas I and II Diamonds;** two Indian cut diamonds of 67.50 cts, and 57 cts, seen by Tavernier in Goa, India in 1648. Believed to have belonged to the Portuguese Viceroy, Dom Philip Mascarenhas. Present owner unknown.

**mascot emerald;** a misleading commercial term for a true soudé emerald or beryl triplet made from natural beryl.

**masculine;** an obsolete term for rubies of an intense red color.

**masculine;** any stone of a rich and dark color.

**masers;** an acronym for **m**icrowave **a**mplification by **s**timulated **e**mission of **r**adiation. A class of amplifiers and oscillators, from which the optical laser was developed. Also known as paramagnetic amplifier.

**Mashakalai;** an Indian term for an emerald or beryl with color like Mashakalai, which bring the wearer fatal destiny. → Emerald colors and superstitious in Indian.

**mass;** a name frequently applied to a rough diamond during the early phases of fashioning.

**mass;** a solid body of native metal such as copper, etc.

**mass;** a large naturally solid ore body of irregular shape standing at any angles.

**mass;** a characteristic of material that can be defined as *inertia mass* of a body, or the resistance offered by a body to change of motion (such as acceleration). While the weight is a gravitational mass is determined on the earth's surface by dividing the weight of a body by the acceleration due to gravity. The standard unit of mass is the kilogram (Kg). The mass of a body always remains

everywhere constant, whereas weight is affected by the distance of a body from the center of the earth which means it varies slightly from place to place on the earth's surface.

**mass aqua;** a misnomer for a hard borosilicate crown glass used as an aquamarine imitation, when cobalt is added. RI:150-1.51. SG:2.35-2.37. H:6.

**massa;** a term used in Brazil for diamond mines laying high on the plateaus and hills where there is no watercourse.

**massicot;** a rare natural lead monoxide, PbO. RI:2.60.

**massive;** a term applied in mineralogy for densely-packed aggregate showing no exterior crystal shape. Also called massive mineral.

**massive;** appearance of a mineral to be physically isotropic without structure.

**massive;** any rocks occurring in very thick beds, free from flow-banding, foliation, schistosity, lamination, etc., such as granite, diorite, rhyolite, and basalt. Also called massive rock.

**massive amber;** a densely packed, pale yellow, deep yellow to orange and colorless variety of Baltic amber.

**massive grossular;** a massive green variety of hydrogrossular garnet, also erroneously called *Transvaal jade* and *African jade*.

**massive gypsum;** same as alabaster. Also called compact gypsum.

**massive mineral;** → massive.

**massive rock;** → massive.

**mass opal;** same as opal matrix.

**master color set;** → master diamonds.

**master diamonds;** carefully selected polished diamonds or other gemstones of known bodycolor grade, which are used as standards for comparison, when grading the color of other stones. Master stones by diamonds usually range from colorless to shades of yellow and brown. Also called master stones, master set, color sample, master color set, or key diamonds. Also frequently called diamond yardstick, standard stones or standard comparison stones.

**master-eye effect;** the appearance of ungraded diamond darker on one side and lighter on the other side, when compared with the master diamond, because the difference in color noticeable between the right and left eyes.

**master lap;** a flat horizontal revolving lap that is a part of faceting machines, which is used in jewelry for faceting and polishing of diamond and jewels. → Faceting heads machine.

**master set;** → master diamonds.

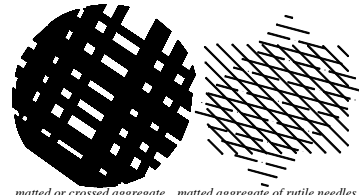
**master stones;** → master diamonds.

**mastodon ivory;** a variety of fossilized ivory obtained from tusks of extinct mastodon elephant of Miocene to

Holocene times around 7000 years ago, they are buried in the icy ground around the Yukon River, Alaska. They differ little from elephant ivory. It was cut into small objects such as brooches and pendants. → Odontolite.

**mat;** a smooth but lusterless or dull surface of a mineral or metal tending to diffuse light.

**mat;** a mineral or crystal aggregate, in which the



*matted or crossed aggregate*    *matted aggregate of rutile needles*  
matted or crossed aggregates

minerals are tangled closely together similar to a woven fiber, such as nephrite. Also spelled matt or matte. →

Felted structure, mesh texture.

**Matam Diamond;** same as Matan Diamond.

**Matan Diamond;** a blue, reported to be pear-shaped, or intended egg-shape of 367 cts. Found on the Island Borneo ca. 19<sup>th</sup> century. It belonged to the Sultan of Matan. Some investigators believe that it was actually quartz crystal. Also spelled Mattan, Matam, Rajah of Matan, and Mattam Diamond.

**Matara diamond;** a misleading term for natural colorless to smoky zircon with strong brilliancy from Matara (Maturai) in southern Sri Lanka. After heat treatment it was altered to colorless. Used as gemstones or for diamond imitation. Also spelled Matura diamond.

**matched pearls;** pearls that are an exact counterpart of another or to be equal or suitable. Those pearls are similar of hue, tone and intensity of color.

**mat glaze;** a term applied to the colorless or colored, partially devitrified ceramic glaze with dull luster.

**matinee length;** a pearl necklace of 50 to 60 cm in length. Also called matinee necklaces, pearl.

**matinee necklaces, pearl;** same as matinee length.

**Mato Grosso;** location of a diamond and gemstone bearing state in Brazil.

**Mato Grosso Diamond;** a brown-rose-purple diamond of 227 cts, found in 1963 in Mato Grosso, Brazil. Present whereabouts unknown.

**matorodite;** a misspelling of mtorodite.

**matorolite;** a misspelling of mtorolite.

**matraite;** → sphalerite.

**matrice;** another spelling for matrix.

**matrix;** the natural material or rock, in which a crystal or gem mineral is cemented. Also called groundmass, mother rock.

**matrix;** a gemstone that occur with surrounding rock material, in which the gemstone is cemented, such as opal matrix or turquoise matrix, these stones are cut cabochon. Also called matrix jewelry.

**matrix**; in a fossiliferous rock or earthy material, the rock material as opposed to the actual fossil itself.

**matrix**; the cement material, which formed a cushion, or binder, in the configuration of pavements.

**matrix**; a metal, in which the diamonds mounted in the crown are cemented.

**matrix**; a special cavity usually made of metal or plaster, for casting or pressing an article. Also called mold.

**matrix**; a term used by Australian miners for a gray, porous or brown low grade rock which carrying a little of opal or potch. Also called mother-of-opal.

**matrix jewelry**; → matrix.

**matrix limestone**; same as micritic limestone, micrite limestone.

**matrix lines**; a term used by Australian miners for lines of matrix that being seen between units of color in the surface of an opal or potch.

**matrix opal**; opal of gem quality, which occur in rock or any contact material. Also called mother-of-opal.

**matriz**; a Spanish spelling for matrix.

**mat-sa**; a Burmese term used for an opaque sapphire stone. → Corundum classification in Myanmar.

**matt**; same as mat.

**Mattam Diamond**; same as Matan Diamond.

**Mattan Diamond**; same as Matan Diamond.

**matte**; same as mat.

**matted**; → mat.

**Matura diamond**; same as Matara diamond

**Maui diamond**; a misleading term for quartz crystal from Hawaii, USA.

**maungdaing**; a Myanmar (Burmese) term for a bamboo crane used pick up the filled basket from the bottom of the shaft.

**mauve diamond**; a fancy colored diamond with the shade of color; pale-violet, pale-purple to light bluish-purple.

**mauvein**; a basic violet dye obtained for first synthetic aniline from mauve petals.

**mauve jade**; a term applied to a lavender blue variety of jadeite.

**mawed jadeite**; a commercial term used in Myanmar for polished flat blocks of jadeites of about 25 by 40 mm, which are used to show the color of stones.

**maw-sit-sit**; a local Myanmar (Burmese), term for a fine-grained, pale yellowish green jadeite-albite rock patterned by dark green to black spots and streaks, which contains ureite, diopside and zeolite. The green color is caused by chromium. Found in Maw-Sit-sit in Upper Myanmar. RI:1.52-1.54. SG:2.46-3.15. Also known as chloromelanite and kingfisher jade.

**max blue**: a commercial term for a blue treated topaz.

**Maximilian Diamond**; a greenish yellow diamond of 50

cts, owned by Archduke Maximilian of Austria in 1850 in Brazil. It was cut into a 33 cts, cushion shape brilliant for his wife, Princess Carlotta of Belgium. The stone disappeared after his execution in Mexico in 1867. Later in 1946 it was purchased by Morris Nelkin in New York, USA. During a robbery in 1961 it was lost and never recovered. Also called Carlotta of Belgium Diamond.

**Maximilian, Archduke**; → Archduke Maximilian of Austria, Maximilian Diamond.

**Maximilian Emerald**; a step-cut emerald of 21.04 cts, was worn by Ferdinand Maximilian Joseph, Emperor of Mexico (1864-1867). Later purchased by Mrs. Merriweather Post who presented it to National Museum of Natural History in Washington, D. C., USA.

**maxixe**; dark blue variety of beryl from Maxixe Mine, Minas Gerais, Brazil. The color is caused by NO<sub>3</sub> impurity. Strong pleochroism. Optics;  $\alpha$ :1.584,  $\gamma$ :1.592. Birefracton: 0.008. SG:2.80. → Maxixe-type beryl, maxixe aquamarine.

**maxixe aquamarine**; boron-rich, dark blue aquamarine from Maxixe Mine, Minas Gerais, Brazil. It is strongly pleochroic in blue and pink. The color can be bleached when the mineral is exposure to strong sunlight. The color can be restored by irradiation. → Maxixe-type beryl, maxixe.

**maxixe beryl**; a blue to deep blue variety of beryl from Maxixe Mine, Minas Gerais, Brazil. The color is caused by nitrogen oxide (NO<sub>3</sub>) impurity or color centers. Strongly dichroism. → Maxixe, maxixe aquamarine.

**maxixe-type beryl**; a blue to deep blue variety of beryl from Maxixe Mine, Minas Gerais, Brazil. The color is caused by NO<sub>3</sub> impurity. Strongly dichroism. → Maxixe.

**Maxwell Stuart Topaz**; a bluish-white to colorless brilliant cut topaz of 368.98 cts. Found in 1870 in Sri Lanka (Ceylon). Present whereabouts unknown.

**mayaite**; a white, gray, green to yellow-green diopside-jadeite from Central America. Used by Maya nation in ancient times.

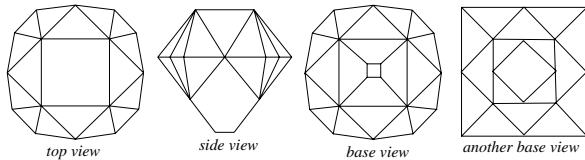
**May Mine**; location of a small diamond pipe in the Kimberly area, South Africa.

**Mazarin, Cardinal**; → Cardinal Mazarin.

**Mazarin cut**; an early style of cutting a diamond similar to the cushion-shaped cut with 16 facets and table on the crown and 16 facets and a large culet on the pavilion, totally 34 facets. It believed to have been developed by Cardinal Mazarin in 17<sup>th</sup> century. It is similar to the double-cut brilliant.

**Mazarin Diamonds**; Cardinal Jules Mazarin (1602-1661); a cardinal and statesman and prime minister under Louis XIII and Louis XIV of France. He amassed

a magnificent collection of 18 diamonds, which he bequeathed to the French Crown. The stones were stolen along with other Royal gems from the French



*Mazarin cuts*

Garde Meuble in 1792. Among these stone were the Boin-Taburet, The Grand Mazarin, Mirror of Portugal and Sancy. Grand Mazarin is now on display at the Louver Museum in Paris. The present owners of the rest are unknown.

**Mazaruni River;** location of diamond deposits in Guyana, South America.

**Mbuji-Mayi;** a town and location of alluvial diamond deposits in southern Zaire, Africa.

**mc;** an abbreviation for metric carat.

**MC;** an abbreviation for metric carat.

**McFarlin Diamond;** a canary yellow, emerald-cut diamond of 49.40 cts. Named after McFarlin Family in New York in 1956. Presented to the White Memorial Museum in San Antonio, Texas, in 1961. In 1968 was stolen and never recovered. Also called Myrtle McFarlin Canary Diamond.

**McLean Diamond;** a white, cushion-shaped diamond of 31.26 cts. Named after Evalyn Walsh McLean. When she died the stone was owned by Harry Winston and sold to the Duchess of Windsor. Now owned by a Japanese buyer.

**Md;** a chemical symbol for the element mendelevium.

**mealy;** same as farinaceous.

**mealy gypsum;** same as farinaceous gypsum.

**mean birefringence;** the difference between the greatest and the least indices of refraction of a biaxial crystal such as calcite, in which two images are to seen. This difference is expressed by numbers such as 0.007 for danburite.

**mean refractive index;** → index of refraction.

**measurement of gemstones;** → weight of gemstones and precious metals.

**mecal;** a manufacturer's name for bad diamonds.

**mecca stone;** a carnelian variety of chalcedony.

**mechanical coloration;** a term used for a black star sapphire in which the color is not derived from color-centers or impurities but from hematite inclusions that

is many times exsolved and give a dark-brown to black color. Also called color by inclusions.

**mechanical dop;** a mechanical device, in which the small diamond is held between steel claws to grip the stone firmly, while enabling the gem to be semi-automatically adjusted without re-setting.

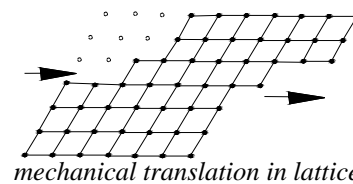
**mechanical erosion;** same as corrasion.

**mechanical faceting head;** → faceting heads.

**mechanical metamorphism;** same as kinetic metamorphism.

**mechanical of rock digging;** same as rock excavation mechanics.

**mechanical translation;** motion of a crystal structure



*mechanical translation in lattice*

lattice in which all the points in the structure follow parallel paths with equal distances due to mechanical forces such as in

calcite, halite, etc.

**mechanical twin;** → deformation twin.

**medallion;** a round or oval usually gold disk but made of glass, stoneware, ivory, opal, porcelain, and sometimes enameled. Decorated with beads or gemstones or objects set in a circular frame as a brooch or pendant. Frequently engraved with figures as cameo or intaglio or various portraits in the form of relief from basalt, or various jasper.

**medfordite;** a local term for massive white moss agate variety of chalcedony. Found in Medford, Oregon, USA.

**median;** the value of middle item.

**medical geology;** the scientific study of application of geology to medical and health problems. Also called medicinal geology, medicinal gemstones.

**medicinal gemstones;** → medical geology.

**medicinal geology;** same as medical geology.

**medicine pearl;** fancy-shaped pearls with not attraction is ground up and mixed with distilled water for medicine purposes such as digestive aid or as tomb pearl. To say it have aphrodisiac properties?.

**Medina emerald;** a misleading commercial term for a green glass used as an emerald imitation.

**medium crystalline;** description of crystalline size of carbonate sedimentary rocks having diameter of 0.062-0.25mm.

**medium dense;** description of a middle dense.

**medium grained;** a crystalline igneous rock, in which the individual minerals have an average size of 1-5 mm in diameter.

**medium hard platinum;** an alloy of 95% platinum and 5% iridium, used in alloys with platinum in jewelry. →



Iridium.

**medium luster;** same as glimmering.

**Medusa Head of Emerald;** a small, especial artistic piece carving Medusa Head of emerald, mounted in an Italian renaissance workmanship. Now on display in British Museum, London, England.

**medwins;** a term used in India for open cutting mines in alluvial hills, over which water is poured.

**meerschaum;** same as sepiolite, agric chalk.

**meerschaum cut;** → sepiolite.

**Megadiamond;** a commercial term for synthetic diamond produced by H. Tracy Hall, USA in 1971.

**megalithic;** a large undressed stone.

**megalithic stone;** a large undressed stone of various materials used in various prehistoric monuments.

**megapore;** same as macropore.

**megascopic;** same as macroscopic.

**mega crystalline;** same as eurocrystalline, macrocrystalline.

**Magen David;** same as Star of David.

**meihua lu;** a Chinese term for a sika deer carved from jade. → Chinese ritual and symbol jades.

**Mei-Ku Lu jade;** same as American green jade.

**meionite;** an isomorphous end member of scapolite with the composition:  $3[\text{Ca}_3(\text{Al}_2\text{Si}_2\text{O}_8).\text{CaCO}_3]$ .

**Meisner pearls, de;** a kind of imitation pearl made from fine matt glass with a mother-of-pearl base which is similar to mabe cultured blister pearl. Also called pearl de Meisner.

**Meister Diamond;** a fancy yellow, cushion-shaped diamond of 118.05 cts, from Kimberly, South Africa. Named after its owner Walter Meister, Zurich, Switzerland.

**Mekong whiskey sapphire;** a compare term used for golden-yellow color (similar to whiskey), sapphire from Bank Kha Cha and Khao Ploi Waen district in Chanthaburi, Thailand.

**melaconite;** same as stephanite.

**melamine formaldehyde resin;** any translucent to opaque type of amino resin made from melamine and formaldehyde. RI:1.54-1.60. SG:1.8. H:2½. Used as an adhesive and for coating surfaces, enamel, to imitate various colored gemstones. It has a very characteristic smell, when heated. Sometimes spelled melamine resin.

**melamine resin;** same as melamine formaldehyde resin.

**melane;** another term for any mafic mineral.

**mélange;** an assortment of polished diamonds of different sizes but larger than *mêlée* (0.25 cts, in weight).

**mélange;** a medley or mixture of rocks of different kinds, sizes, origins, or characters. Also spelled *melange*.

**melange;** → *mélange*.

**melanin;** a dark brown to black pigment that occurs in the retina, skin, and hair of higher animals and plants, but not of albinos, included are feather of animals. Produce synthetically. Used as dyes.

**melanite;** a black variety of andradite garnet consisting titanium. It can be distinguished from black gemstones such as tourmaline and chalcedony, and glasses by its high specific gravity. Sometimes used as mourning gemstone and as jet imitate. Also called melanite garnet, pyreneite. → Schorlemite.

**melanite garnet;** → melanite.

**melano;** a prefix meaning dark or black.

**melanocratic;** dark colored, especially igneous rocks, which are abnormally rich in dark and heavy ferromagnesium minerals (between 60-100% dark minerals). Also called chromomatic, basic. → Leucocratic.

**melanosome;** a term applied to a dark-colored part of a migmatite rock rich in mafic minerals.

**melanterite;** same as iron vitriol.

**melaphyre;** any dark-colored porphyric igneous rock consisting of phenocrysts of feldspars in a dark-colored aphanitic groundmass. Later the term restricted to altered amygdaloidal rock of basalt or andesitic types.

**melatope;** in microscopy a characteristic black cross in the center of the interference figure, which indicates the optical axis of a double-refractive crystal under convergent, polarized light. This effect can not be seen in quartz crystal.

**Meleagrina;** a less used alternate term for *Pinctada Margaritifera*.

**melee;** another spelling for *mêlée*.

**mêlée;** another spelling for *mêlée*.

**mêlée;** an assortment of polished diamonds of different size but less than 0.25 cts, in weight.

**mêlée;** a classification of rough diamonds according to shape of unbroken octahedral crystals weighing between 0.2 to 1.4 cts, which is called *sawable*. Polished diamond weighing between 0.2 and 0.5 cts. Sometimes smaller rough stones are named as *sand*, which may consists 120 of pieces being a carat. → Diamond sorting, sand.

**mêlée;** a setting style of small diamonds mounted close together like a pavé setting.

**mêlée;** the term sometimes applied to transparent colored stones of different size but less than 0.25 cts, in weight. Also spelled *melee* or *mêlée*. → *calibré* cut.

**melengket;** a term used by native in Indonesia or Philippine for a stage of hardness of fossilized copal which is gathered two weeks after tapping the trees. → Pontianak, boea.

**melichrysos;** an old term applied to yellow zircon.

**melilite;** a sorosilicate mineral of melilite group with the composition  $2[(\text{Ca},\text{Na})_2(\text{Al},\text{Mg},\text{Fe})(\text{Si},\text{Al})_2\text{O}_7]$ , the

most common end-member including akermanite and gehlenite. Tetragonal crystal. White, yellow to honey, greenish, reddish or brown color. Transparent to translucent. Vitreous to resinous luster. H:5. SG:2.95-3.04. Fracture: uneven to subconchoidal. Brittle. Cleavage {001}. Aggregate: short and thick asbestos.  $n_{\epsilon}=1.640$ ,  $n_{\omega}=1.632$ . Birefringence: 0.012.  $\oplus$ . Occurs as a component of certain recent basic eruptive rocks. Found in the Colorado, USA, Russia and East Africa. Not to be confused with mellilite. A suitable mineral for collectors.

**melinophane**; same as meliphanite.

**melle**; a term used in Brazil for poor quality diamonds.

**mellite**; an unusual rare organic gemstone, which occurs as nodules in an inorganic process in brown coal and is in part a product of vegetable decomposition. It has been cut cabochon or faceted. Not to be confused with melilite.

System: tetragonal.

Formula:  $16[\text{Al}_2(\text{C}_{12}\text{O}_{12})\cdot 18\text{H}_2\text{O}]$ .

Luster: resinous to vitreous.

Colors: yellow to red, brownish, white.

Streak: yellowish-white.

Diaphaneity: transparent to translucent.

Cleavage: {010} perfect.

Fracture: conchoidal uneven. Brittle.

SG: 1.58-1.64.

H:2-2½.

Optics;  $\omega$ :1.539-1.541,  $\epsilon$ :1.509-1.511.

Birefringence: 0.028-0.032.  $\ominus$ .

Found in Paris (France), Bitterfeld (Germany), Tula (Russia), and the Czech Republic.

**mellite luminescence**; matt-whitish or pale-blue glow under SWUV and medium blue or lemon-yellow under LWUV.

**mellite pleochroism**; weak pleochroitic: yellow to yellow-**meliphanite**; → meliphanite.

**meliphanite**; an extremely rare gemstone. It is prized by collectors and sometimes has been cut cabochon or faceted. Also called meliphane, and melinophanite.

System: tetragonal.

Formula:  $8[(\text{Ca},\text{Na})_2\text{Be}(\text{Si},\text{Al})_2(\text{O},\text{F},\text{OH})_7]$ .

Luster: vitreous.

Colors: yellow to red or colorless.

Streak: colorless.

Diaphaneity: transparent to translucent.

Cleavage: {001} perfect.

Fracture: uneven. Brittle.

SG: 3.00-3.03.

H:5-5½.

Optics;  $\omega$ :1.612,  $\epsilon$ :1.593.

Birefringence: 0.019.  $\ominus$ .

Found in Greenland, Norway, and China.

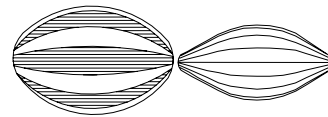
**meliphanite pleochroism**; it has distinctive shades of yellow and red color.

brown.

**mellow amber**; another term for gedanite or friable amber.

**melnikovite**; a variety of pyrite melnikovite, marcasite melnikovite or greigite.

**melon cut**; a modification of polishing that is globular and frequently ribbed or cabochons. A form similar to a cantaloupe with equidistant longitudinal



melon cuts

depression or meridians or

elongated form such as briolette and step-cut beads.

**melt**; liquid fused rock.

**melt, to**; a method of alteration of a solid into a liquid by the application of heat before it hardens. Also called to blow.

**melted flow**; filled fractures of diamond shows a structure similar to a melted flow. → Revealing fracture filled diamond. flattened trapped

**melting snow jade**; a fanciful term for appearance of white grayish variety of jadeite with opaque patches traversed by semitransparent streaks. Cut as cabochon.

**memorial jewelry**; a synonym for ilmenite.

**men**; a Chinese term for blood red nephrite. → Nephrite colors in Chinese, Chinese ritual and symbol jades.

**menaccanite**; a synonym for mourning jewelry.

**mendelevium**; a synthetic radioactive element of the Periodic System with the symbol Md it has a half-life of 1.5 hours.

**Mendelsohn Diamond**; an alluvial diamond of 5 cts, set in a men's ring with the initials S. M.; an abbreviation for its owner Sidney Mendelsohn, who willed the stone to Parliament of South Africa on his death.

**mendozite**; a mineral of alum group with chemical formula:  $\text{KAl}(\text{SO}_4)_2\cdot 11\text{H}_2\text{O}$ .

**menilite**; an opaque, dull, brownish or grayish, concentric banded variety of common opal that occur in Ménilmontant, near Paris, France. Also called liver opal. Used as ornamental stone.

**mercuric**; pertaining to mercury in its state.

**mercuric sulfide**; same as cinnabar, vermilion.

**mercury**; a poisonous, very heavy, silvery-white metallic element, which is liquid at atmospheric temperature with symbol Hg. It has very high surface tension. Used as amalgams, and in quartz vapor lamps as source of ultraviolet light for exciting luminescence in gem minerals. Also called quicksilver, and hydrargyrum.

**mercury gilding**; → amalgam.

**mercury spectrum;** mercury vapor lamp emit following lines in the visible and ultraviolet in nanometer units: in the orange at 623.4 and 615.2, in the yellow at 579 and 570, in the green at 546.1, in the blue at 435.8, and 434.8, in the violet at 407.8 and 404.7.

**mercury vapor lamp;** a strong ultraviolet radiation source obtained by passage of an electric current through mercury vapor in a vacuum lamp, which is generally made of quartz glass. The radiation lines ranging from yellow to the far ultraviolet. The quartz tube filters or absorbs all but the long wave UV (365 nm) or short-wave UV (253.7 nm) transmitted lines.

**mere;** a Maori term for flattened alluvial jade pebbles, used for ornamental purposes or amulet gems by natives of New Zealand, which is called *hei tiki*.

**Merguian shell;** → Merguian pearl.

**Merguian pearl;** pearls obtained from Mergui shell a species of pearl oyster *Pinctada maxima*, from Mergui Archipelago of Bay of Bengal, India. The pearls are similar in quality to Philippine pearls. → Macassar shell.

**meridional emerald;** a term applied for southern emerald or another term for Colombian emerald.

**meri-kivi;** a Finnish term for amber, meaning sea-stone. Also spelled merre-kiwa → Sea stone.

**meriwalk;** an Estonian term for amber, meaning sea-wax. → Sea stone.

**meriphikaa;** an Estonian term for amber, meaning sea-resin. → Sea stone.

**merocrystalline;** synonym for semicrystalline, hemicrystalline, hypocrystalline.

**merohedral;** same as hemisymmetrical, hemihedral.

**merohedrism;** being merohedral.

**merre-kiwa;** a Finnish term for amber, meaning sea-stone. Also spelled meri-kivi → Sea stone.

**Merthyr diamond;** a misleading term for quartz crystal from southern Wales, England.

**meru sapphire;** a misnomer for sapphire blue zoisite.

**mesa;** a prefix for middle.

**Mesa Grand tourmaline;** location of tourmaline from Mesa Grande, San Diego County, California, USA.

**Meshed beryl;** in 80<sup>th</sup> in Meshed, Khorassan, Iran, near to the city Meshed on the road to microwave station after cutting a way to the station are many beryl and smoky quartz released. Suggesting as Meshed beryl, and Meshed smoky quartz.

**Meshed smoky quartz;** → Meshed beryl.

**Meshed turquoise;** turquoise found near Nishapur, ca. 150 km from Meshed, Khorassan, Iran. Also called Persian turquoise.

**mesh;** a term applied to an opening in a sieve or screen.

**mesh net;** a term applied to a net meshes.

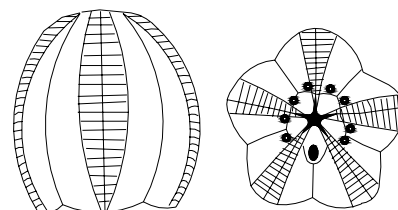
**mesh structure;** same as net structure, lattice structure.

**mesh texture;** a texture like network, caused by alteration of certain minerals, such as serpentinization of olivine. Also called reticulate texture. → Matted, felted structure.

**meso;** a prefix meaning middle. Also spelled mezo.

**Meso-American jade;** a term described jade from middle America that may contain complex mixture of jadeite, acmite and diopside, which ranging from Mexico to Costa Rica.

**mesoblastus;** a micro-organic calcareous, melon-like, button-like plates with five-rayed star on top, warm water leaving, found in chalk.



*mesoblastus*

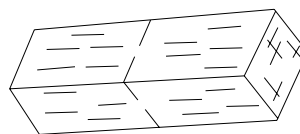
**mesocratic;** a term applied to igneous rocks intermediate in color between light and dark constituents. Between leucocratic and melanocratic.

**mesocrystalline;** a term applied to the texture of a rock consisting of crystals whose diameters are intermediate between microcrystalline and macro-crystalline.

**mesole;** synonym for thomsonite.

**mesolithic;** in archaeology same as middle stone age.

**mesolite;** a fibrous variety of zeolite group of minerals, intermediate in composition between natrolite and scolecite. Sometimes cut into chatoyant cabochon and prized by collector's.



*mesolite crystal*

Variety is antrimolite.

System: monoclinic.

Formula:  $8[\text{Na}_2\text{Ca}_2(\text{Al}_2\text{Si}_3\text{O}_{10})_3 \cdot 8\text{H}_2\text{O}]$ .

Luster: vitreous to silky.

Colors: white, pale gray, pale yellow, colorless

Streak: colorless to white.

Diaphaneity: translucent to opaque.

Cleavage: {110} perfect.

Fracture: conchoidal to uneven. Brittle.

SG: 2.20-2.40.

H:5.

Optics;  $\alpha$ :1.505,  $\beta$ :1.506,  $\gamma$ :1.506

Birefringence: 0.001. ⊕.

Found in Colorado, Oregon, Pennsylvania (USA), Scotland, and Northern Ireland

**mesomerism;** → resonance.

**meson;** a term applied to one of a series of short-lived, unstable particles belonging to the class called hadrons

present in cosmic rays are emitted by nuclei bombardment by high energy particles. They are believed to consist of a quark and its antiquark. The masses of mesons are intermediate between those of electron (about 150 times greater than electron) and nucleons, and with positive, negative, or zero charge. There are three groups: -mesons, -mesons (pions), and -mesons (kaons)

**mesoperthite**; an intermediate in composition between perthite and antiperthite. Also called eutectoperthite.

**mesophases**; same as liquid crystals.

**mesosphere**; same as lower mantle.

**mesotype**; in mineralogy a group of needle zeolite minerals, including mesolite, natrolite and scolecite. Also called needle stone, needle zeolite.

**mesotype**; partly synonym for natrolite, because its form is intermediate between those of stiblite and analcime.

**mesotype**; same as mesocratic.

**Mesozoic**; the third and one of the great divisions or eras of geologic time, which includes the periods during which rocks of Triassic, Jurassic, and Cretaceous age (225 to 65 million years ago) were deposited. Mesozoic preceded by the Paleozoic and followed by the Tertiary. Also called age of gymnosperms, age of reptiles, reptilian age. → Precambrian, Paleozoic, Cenozoic.

**mesozonal pegmatite**; a term described the conditions of very slowly cooling of pegmatitic stage.

**mesozone**; a classification of metamorphic rocks of intermediate depth by temperature of 300° to 500° C.

**Messina Mine**; location of a kimberlite fissure diamond deposits near Barkly West, South Africa.

**meta**; a prefix indicates that the rock type has been metamorphosed such as metaquartzite, metabasalt, etc.

**metachromacy**; an object showing different color than the basic color after dyeing with a single dye usually blue or violet, which produces two or more colors. A contrast to anthochromacy. Also called metachromatic.

**metachromatic**; → metachromacy.

**metacryst**; same as porphyroblast or metacrystal.

**metacrystal**; any large, pseudoporphyritic crystal, such as garnet and staurolite formed by recrystallization in metamorphic rocks. Also called metacryst.

**metahornstone**; a hornstone formed by metamorphose process.

**meta-jade**; a misnomer for a variety of semicrystalline and various colored glass made of Iimori stone in Japan as jade imitation. It is made with chatoyant effect by adding of fibrous inclusions. Also marketed as Victoria stone, kinga-stone and victoria cat's-eye. → Iimori stone, cathay cat's-eye.

**metal**; element metals are characteristic by their solid, grayish color, opacity, brilliancy luster, malleability, heat and electrical conductivity, toughness, ductility,

and ability to form positive ions. When polished a good reflector of light. Some of them are used as alloys or quasi-pure in jewelry. Also called metallic element.

**metal**; a term applied frequently to igneous rock or metamorphic rock to distinguish from sedimentary rock.

**metal**; now an obsolete term for any hard rock.

**metal**; a term applied to a rock which is relatively resistance to erosion.

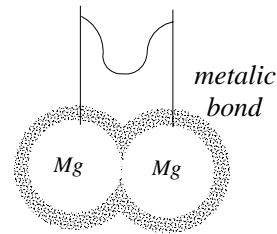
**metal**; a term applied frequently to rock that required drilling and blasting for trading purposes.

**metallic**; pertaining to metallic.

**metallic**; containing a metallic element.

**metallic**; brilliant reflecting light from the surface of a metal such as gold, etc. Also called metallic luster.

**metallic bond**; a type of metallic bond that is present in all metals, in which the outer electrons are shared by the crystals as a gas of valence electrons which are free to



move throughout the metal lattice. Gas forming electrons surround the positively charged metal ions in the crystal structure. These free electrons account for the fact that most metals are good conductors of electricity and heat. In crystallography called metallic crystal.

**metallic crystal**; → metallic bond.

**metallic element**; metallic elements that are generally distinguished from nonmetallic elements by their luster, malleability, heat and electrical conductivity, toughness, and ability to form positive ions. → Metal.

**metallic luster**; in optics the highest form of luster. A degree of luster that can be seen by certain opaque and compact state minerals such as gold. Chromite and cuprite have submetallic luster. → Luster.

**metallic mineral**; those minerals with high specific gravity and metallic luster such as galena, sphalerite, magnetite, chalcopyrite, pyrite and pyrrhotite, etc.

**metallogeny**; same as metal geology, study of the genesis of mineral deposits.

**metalloid**; an element having some properties of metals and other of non-metals.

**metalloidal luster**; minerals having both metallic and nonmetallic luster.

**meta-made**; a commercial term for synthetic glass made in Japan. It resembles jade. → Iimori stone

**metamarble**; a term applied to metamorphic carbonate rock. Also called polished stone.

**metameric colors**; a term applied to crystals or

materials that appear as different colors under different types of illumination, because they have different spectral reflectivity curves such as the natural alexandrite a variety of chrysoberyl, which shows red in artificial light and green in daylight. In the case of alexandrite, the spectral band is on 580 nm. This characteristic is known as metamerism.

**metamerism;** → metameric colors.

**metamict;** a term denoted to the glassy or virtually amorphous mineral, which has suffered breakdown of the original crystal structure by internal bombardment with alpha particles or helium nuclei while the external form remains intact. Alpha particles are emitted by radioactive atoms within the crystal. Heat treatment returns these stone to the normal state.

**metamict;** a term applied to *low-type zircon*. → Ekanite.

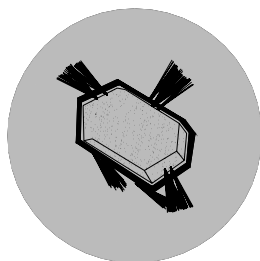
**metamict ekanite;** → ekanite.

**metamict mineral;** metamict minerals originally were formed crystalline, but their crystal structures has been destroyed by radiation of radioactive elements such as metamict zircon. Some natural substances are originate from both inorganic and organic matters (dual origin), with the two type properties, which are considered as minerals such as pearl and mother-of-pearl. → Metamict.

**metamict crystal;** a crystal, which has suffered breakdown and the crystal structure has been disrupted by internal bombardment with alpha particles from uranium and thorium. → Metamicts.

**metamict zircon;** generally a slightly milky green or brown variety of zircon. Some blues are light sensitive. Because the high double refraction they are cut to minimizes the reflection or *fuzziness*. The crystal structure of the stone has suffered breakdown and been disrupted by internal bombardment with alpha particles from uranium and thorium. Also called low zircon or low-type zircon. → Coffinite and thorite.

**metamict zircon in Sapphire;** in some sapphires from



*metamict zircon kernel with halo in Sri Lanka sapphire*

Sri Lanka can be seen breakdown crystal zircon as inclusions.

**metamorphic;** pertaining to, produced by, or changing form during the metamorphism.

**metamorphic carbonate rock;** same as metamarble.

**metamorphic quartzite;** same as metamorphosed quartzite.

**metamorphic rock;** any rock, which has been derived from pre-existing rocks by mineralogical, chemical composition, textural and structural changing, essentially in the solid state due to processes operating in the earth's crust of heat or intense pressure, shearing stress, or other natural agents. The alteration causes generation of a new mineral or rock type. Thus, limestones have been changed into marble, and clay into slates, etc. Also called metamorphite.

**metamorphism;** any alteration process, in which the chemical composition or the texture and structure of a rock or mineral changes in response to heat, pressure or other natural agents. These thermodynamic processes operating in the earth's crust. There are three main types: (a) *Contact* or *thermal metamorphism*, caused mainly by heat, usually associated with igneous intrusions. (b) *Regional metamorphism*, caused mainly by heat and high pressure over a large area and always associated with orogenesis. (c) *Dynamic* or *dislocation metamorphism*, associated by strong but local forces.

**metamorphism agent;** metamorphism agents are heat, pressure and fluid. Also called agent of metamorphism.

**metamorphism volatile;** volatile components constituents of magma during the metamorphism processes.

**metamorphite;** same as metamorphic rock.

**metamorphosed quartzite;** same as firestone.

**metamorphosis;** same as metamorphism.

**metaquartzite;** same as quartzite, a coarse-grained metamorphic rock consisting mainly of quartz, which formed by recrystallization of sandstone or chert during either regional or contact metamorphism.

**metarhyolite;** a variety of igneous rhyolitic rock contain epidote found in Pennsylvania. Sometimes cut cabochon into ornamental objects. When the rock epidote metarhyolite is stained by cuprite mineral known as cuprite. Found in Pennsylvania, USA. → Cuprite.

**metasomatism;** the process associated with metamorphism, in which the external material is introduced into the mineral, perhaps with recrystallization and/or with displacement of a pre-existing mineral or mineral aggregate without melting. Also spelled metasomatosis.

**metasomatosis;** → metasomatism.

**metasome;** a term applied to a process by which a mineral is replaced by another of different chemical arrangement by introduction of material from external sources, which formed in size at the expense of another mineral (host mineral or palosome) by metasomatism.

Also called guest, guest mineral, inclusion.

**metastable state level;** → inverted population level.

**metaxite;** a sandstone containing flakes or layers of mica, usually muscovite. Also called micaceous sandstone.

**meteoric;** a term applied to that material which related to or composed of meteors or meteorites.

**meteoric diamond;** small diamond fragments found in craters formed by the heat and shock of impacts. → Lonsdaleite.

**meteoric glass;** same as moldavite.

**meteoric iron;** a term applied to iron of meteoric origin.

**meteoric iron;** same as iron meteorite.

**meteoric stone;** a term applied to a stone of meteoric origin.

**meteoric stone;** a meteorite having composition and appearance of a stone.

**meteoric stone;** same as stony meteorite.

**meteoroid;** any of the small celestial, solid body of mineral or rock traveling through space. When entered the earth's atmosphere, it become visible as meteor.

**meteoroid;** specially, any of the celestial solid body that has not entered the earth's atmosphere or another planet.

**meteorite;** small, solid, extraterrestrial aggregates of cosmic origin, which reach the earth from interplanetary space without being entirely vaporized in the atmosphere. Meteorites are divided into three main types: siderites, siderolites, and aerolites. They have been worn as talisman. Also called cosmolite, skystone.

**methane;** a flammable, explosive, colorless, odorless, tasteless gas of  $\text{CH}_4$  formed by the decomposition of organic matter. Slightly soluble in water, alcohol and ether. Also called marsh gas, carbureted hydrogen.

**methylbenzene;** same as toluene.

**methylchloroform;** same as trichloroethylene

**methylated spirit;** an alcohol used as rinsing agent.

**methyl alcohol;** a colorless, toxic, flammable, liquid, wood alcohol  $\text{CH}_3\text{OH}$ , used as rinsed agent and manufactured of formaldehyde. Soluble in water, ether and other alcohols. Also called carbinol.

**methylene chloride;** a toxic, colorless, non-flammable, volatile, liquid of composition:  $\text{CH}_2\text{Cl}_2$ . Penetrating ether-like odor. Slightly soluble in water, can be diluted with alcohol and ether. Used as solvent of plastics and grease. Also called dichloromethane.

**methylene iodide;** a straw-colored, volatile, highly refractive, heavy liquid,  $\text{CH}_2\text{I}_2$ . Used for specific gravity examination and as an immersion liquid for the refractometer, and in the mineral separations. RI:1.742. SG:3.324 at 16 C. It may be diluted rapidly with benzol. The color rapidly darkens on exposure to light. The bottle must be blackened or covered to exclude the

light. Also called diiodomethane.

**methylene iodide and dissolved sulfur;** a mixture fluid used as contact immersion liquid for refractometer, RI:1.78. → Immersion liquids.

**methylene iodide, dissolved sulfur and tetraiodoethylene;** a mixture solution used as contact immersion liquid for refractometer, RI:1.81. → Immersion liquids.

**methyl methacrylate resins (plastics);** → acrylic resin (plastics).

**methyl phenol;** same as cresol.

**methyl violet;** a green powder of  $\text{C}_{25}\text{H}_{30}\text{N}_3\text{Cl}$ . Soluble in water and chloroform, partly soluble in alcohol and glycerol. Used as dyes. USA patent term for methyl violet. Also called gentian violet

**metric carat;** a unit of weight for determination of gemstones, since 1 April 1914 standardized world-wide in the *metric carat*, equivalent to 0.200 gram.

**metric grain;** a small unit of weight for diamond and pearl equal 50 milligrams or  $\frac{1}{4}$  metric carat.

**mewdwins;** another spelling of medwins.

**Mexican agate;** any attractively banded, variegated agate nodules from Mexico.

**Mexican agate;** a misleading term for banded calcite or aragonite. When brecciated is called mosaic agate.

**Mexican amber;** a misnomer for fossil resin ambers found in form of lumps near San Cristobal in Chiapas in Simojovel region, Mexico, used for polishing. → Head amber.

**Mexican amethyst;** amethyst crystals of reddish pink color from Mexico.

**Mexican black diamond;** a misleading term for hematite from Mexico.

**Mexican diamond;** a misleading term for quartz crystal from Mexico.

**Mexican emerald;** probably a former emerald mine belonged to Mexico but today owned by Colombia.

**Mexican fire opal;** any Mexican opal with iridescence.

**Mexican jade;** an opaque, green shade variety of jadeite occurring in the form of boulders found in Central America. Sometimes found in gray to white color.

**Mexican jade;** a misleading term for green-dyed massive stalagmite calcite, which is known as *onyx-marble*. Easy to distinguish from true jade, while calcite. Jadeite is harder and not easily scratched like calcite. Jade does not effervesces in hydrochloric acid but calcite.

**Mexican onyx;** a misleading term for white to yellowish green-banded onyx marble or calcite from Pueblo and Oaxaca, Mexico.

**Mexican onyx;** a misleading term for mostly Mexican onyx, which comes from Argentina.

**Mexican opal;** any precious opal variety from Querétaro in the center of Mexico. It has fine fire and almost

colorless transparent body.

**Mexican opal cut;** cut cabochon in deep forms.

**Mexican opal rough;** transparent, bluish body color, orange, yellow red opal varieties from Querétaro in the center of Mexico.

**Mexican pearl;** any pearl from Gulf of Mexico coasts. It is less shaped and duller in color than Oriental pearls, which are known as Occidental pearl.

**Mexican turquoise;** light blue to bluish green and greenish blue turquoise from New Mexico, USA.

**Mexican turquoise;** light bluish to blue turquoise in a brown matrix from Baja, California (USA), and Mexico.

**Mexican water opal;** any transparent, precious variety of opal from Mexico with iridescence. It appears yellowish when under transmitted light. → Water opal.

**mezo;** same as meso.

**Mg;** a chemical symbol for the element magnesium.

**miagite;** an orbicular variety of gray diorite or hornblende gabbro clan. The orbiculars are light colored. Found in Island Corsica, France. Used as an ornamental stone for vases, etc. Also called napoleonite, miagite.

**miarolitic;** minute, irregular shaped cavities in coarse-grained igneous rocks, especially in granite lined with crystals.

**miarolitic;** characteristic of, pertaining to, or formed in such cavities.

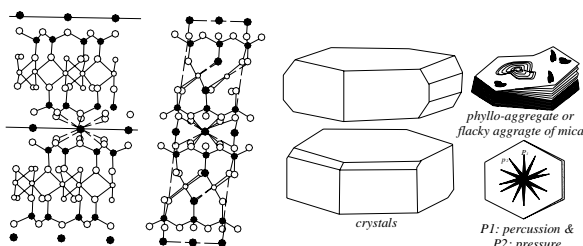
**miarolitic cavities;** minute irregular shaped cavities in certain plutonic rocks lined with small crystals. Synonym for druse, vugh.

**miarolitic rock;** plutonic rocks containing small cavities, into which crystals projects.,

**MIBA;** an acronym for Société Minière de Bakwanga.

**Miba Mine;** location of diamond deposits in Mbuji-Mayi, Kasai Province, Zaire, Africa.

**mica;** a group name for phyllosilicate minerals with complex sheet-like structures. When a mica is none



*mica or muscovite structure, crystals and right phyllo-aggregate and percussions on cleavage*

elastic it means it contains calcium. It found as minute scales in aventurine quartz and granite. It shows asterism due to inclusions when cut cabochon. Also

called isinglass, muscovy glass glimmer. Any mineral of mica such as muscovite, biotite, phlogopite, zinnwaldite, lepidolite, roscoelite, paragonite, and sericite.

System: monoclinic, pseudo-hexagonal.

Formula:  $4[(K,Na,Ca)(Mg,Fe,Li,Al)_3(Si,Al)_4O_{10}(F,OH)_2]$ .

Luster: pearly on cleavage.

Colors: colorless, grayish, silvery-white, greenish, pale brown.

Streak: colorless to white.

Diaphaneity: translucent to opaque.

Cleavage: {001} easy.

SG: 2.77-2.88.

H: 2½-4.

Optics:  $\alpha$ : 1.556,  $\beta$ : 1.587,  $\gamma$ : 1.593.

Birefringence: 0.038.  $\ominus$ .

Found in Connecticut (USA), Australia, Spain, and elsewhere.

**mica as inclusions;** mica found as minute scales in many stones such as aventurine quartz and granite. Sometimes it shows asterism, when cut cabochon. It also occurs in spinel, ruby, sapphire, tourmaline, and emerald.

**mica book;** a large crystal of mica which resembling of its cleavage plates to the leaves of a book. Also called book.

**micaceous;** composed of, resembling, or pertaining to mica. Composed of thin scales or plates, like mica.

**micaceous hematite;** same as iron mica.

**micaceous iron ore;** a variety of hematite having a foliated appearance resembling that of mica. Also called iron mica, micaceous hematite.

**micaceous sandstone;** same as metaxite.

**micanite;** another term for reconstructed mica.

**micarta;** a resin plastic similar to bakelite.

**mica plate;** in polarizing microscope, a plate composed of a layer of muscovite crystal used to examine the optical sign from interference figures.

**mica schist;** schist consisting largely of micas and quartz.

**micatite;** a commercial name for a phenolic resin plastic.

**Michel-Lévy chart;** → appendices.

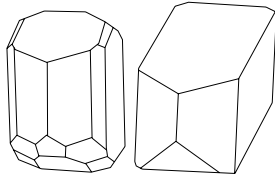
**Michigamme jasper;** an altered ferruginous rock containing fragments of quartz grains from Michigamme Mountain, Michigan, USA.

**Michimanskraal;** location of small alluvial diamond deposits in the Barkly West, Cape Province, South Africa.

**microaphanitic;** → cryptocrystalline.

**micro-chemical test;** a chemical test on a small crystal, mineral or object under a microscope. It is used to determine the form, color, and optical properties of the material. → Etch features of crystals.

**microcline**; an alkali member of the feldspar group. Dimorphous with orthoclase. Green color laminated microcline-feldspar is called amazonite. *Amazonite* is a gem of



microcline crystals

ornamental quality. Some microclines create a moonstones effects. Also called amazon stone. → Perthite feldspar.

System: triclinic.

Formula:  $4[\text{KAlSi}_3\text{O}_8]$ .

Luster: pearly to vitreous.

Colors: colorless, white, grayish, greenish, pale brown, brownish-red.

Streak: white.

Diaphaneity: translucent to opaque.

Fracture: uneven. Brittle.

Cleavage: {110} perfect, and {001} perfect.

SG: 2.56-2.58.

H:6-6.

Optics;  $\alpha$ :1.514-1.529,  $\beta$ :1.518-1.533,  $\gamma$ :1.521-1.539.

Birefringence: 0.010.  $\ominus$ .

Dispersion : 0.012.

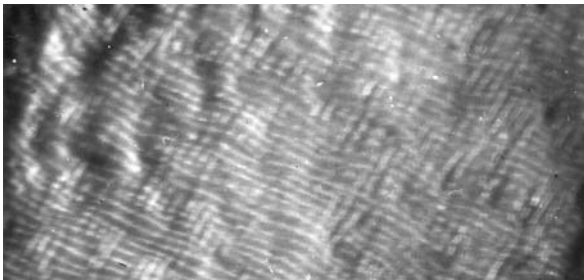
Found in Russia, Virginia, Pike's Peak in Colorado (USA), Norway, Sweden, Italy, South Africa, Japan, Canada (Canada), India, Australia, and other sources.

**microcline cut**; only gem or ornamental quality of microcline is *amazonite*. It is often cut into cabochons, beads, cut gems or carving objects.

**microcline feldspar**; same as microcline.

**microcline perthite**; microcline with perthitic structure.

**microcoquina**; same as chalk.



microcline structure, an electron-microscope

10.000 x from Author

**microcryptocrystalline**; → cryptocrystalline.

**microcrystalline**; rock or any solid groundmass, in which the individual crystals can not be recognized by

the naked eye. Also called microcrystalline texture, micromeritic (obsolete). Same as cryptocrystalline.

**microcrystalline texture**; same as microcrystalline.

**micro-diamond**; rough diamonds of very minute size that are too small to dig commercially. → Grit.

**microfossils**; → chalk.

**microlite**; a very minute crystal.

**microlite**; a rare mineral of pyrochlore group, cut as a cabochon, faceted stones are rare and prized by collector's. Also spelled mikrolith.

System: cubic.

Formula:  $8[(\text{Na},\text{Ca})_2\text{Ta}_2\text{O}_6(\text{O},\text{OH},\text{F})]$ .

Luster: vitreous, resinous to silky.

Colors: pale yellow to brown, green, hyacinth-red.

Streak: pale yellowish-brown.

Diaphaneity: translucent to opaque.

Cleavage: none.

Fracture: conchoidal to uneven. Brittle.

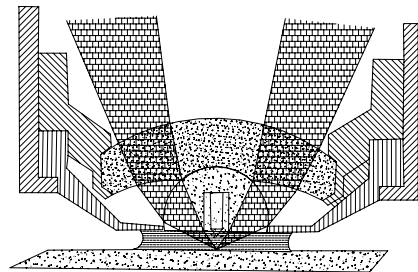
SG: 4.30-5.70.

H:5-5½.

Optics; 1.93-1.94. When metamict: 1.98-2.02, which caused anomalous birefringence.

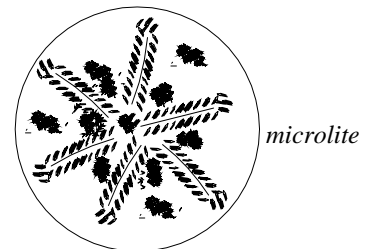
Found in Elba (Italy), Greenland, Western Australia, Virginia, Massachusetts, New Hampshire, Colorado, and South Dakota (USA).

**microhardness tester**; a device for testing minerals,



metals and other substances by intending a pyramid in material surface.

**microlite needles in obsidian**; in some silver obsidian the microlite needles are responsible for a silvery luster.

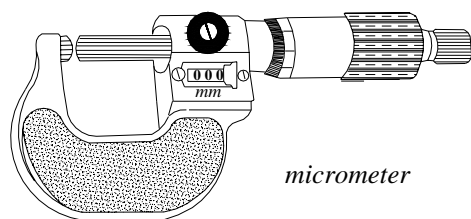


**micromeritic**: an obsolete term for microcrystalline.

**micrometer**; a precise instrument for the linear measurement of small distances or angles in a



microscope. Determines both mounted and unmounted gems, and diamonds with an assurance of 0.1 mm. Often displays digital electronic variant for measuring the proportions of fashioned diamonds by their cut



grading. → Caliper, Leveridge Gauge, millimeter screw micrometer.

**micrometer**; an obsolete unit of length equal to one-millionth of a meter. Used for the measurement of the grain in diamond grit. Abbreviation: m or equal to one thousandth of a mm, or one millionth of a meter. Also called micron with the symbol  $\mu$ . → Millimicron, nanometer.

**micrometer caliper**; a misleading term for a millimeter caliper gauge with a graduated screw attachment used for examining small distances.

**micrometer eyepiece**; an eyepiece provided with cross-wires for examining small objects or small distances such as lines in microscopy, which can be displaced by means of a micrometer screw. Same as Ramsden eyepiece.

**micromineralogy**; use of microscope in mineralogy.

**micron**; a unit of linear determination of small distances equal to one thousandth of a mm ( $10^{-3}$  mm), or one millionth of a meter ( $10^{-6}$  m), with the symbol  $\mu$ . → Micrometer.

**micropertthite**; a variety of microscopic perthite, which is not visible to the naked eye. The lamellae is 5-100 micron wide. → Perthite.

**microphotograph**; an erroneously name for photomicrograph.

**microphylline**; consisting of small scales or leaflets.

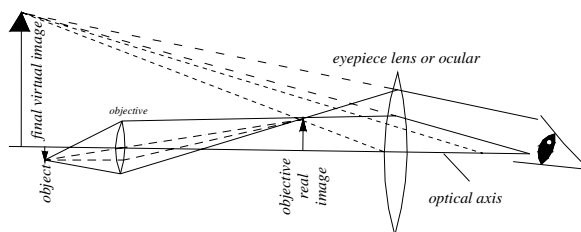
**microphyric**; same as microporphyric.

**microprobe, electron**; → electron microprobe.

**microporosity**; very small pores that can not be recognized by the naked eye.

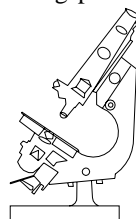
**microscope**; an optical instrument used for obtaining an enlarged virtual image of minute objects by means of lenses. The *simple microscope* is a convex lens of short focal length, used to form an image of an object usually placed just inside its principal focus. A microscope consists of two short-focus convex lenses of the *objective* and of the *eyepiece* or ocular set at opposite ends of a tube, which can be raised or lowered for focusing, and held by an adjustable arm over a stage, on

which the object is placed. For most mineralogical and gemological purposes, the magnifying power is roughly 10x to 50x and consists in addition, two Nicol prisms, to produce polarized light for *polarizing microscope*,



*microscope compound*

which is a combination of microscope and polariscope. There are two types of compound microscopes; the *monocular microscope* mounted on a single eyepiece or ocular, and the *binocular microscope* fitted with two oculars and light from objective is split into two beams by using prisms. The *stereoscopic microscope* version



*an old mineralogical polarization microscope*

is equipped with two objectives and two eyepieces, the object is seen by reflected rather than transmitted

light. *Petrological microscope* or *Petrographic microscope* is a special microscope for determination of rocks. It consists of an ordinary microscope with supplementary elements such as polarizing items, rotating stage for study of thin sections, tube for extra lenses and includes slits for inserting of wedges. *Gemological microscope* is similar to Petrological microscope used in gemology for study of internal features of gemstones with a special holder for gem. Principal types of microscope include optical natural light, transmitted light, reflected light, polarized light, ultraviolet, electron, and X-ray microscopy. → Binocular microscope, monocular microscope.

**microscope eyepieces**; usually two type of eyepieces are used in microscopes, in most microscopes the used eyepiece is the *eyepiece Huygenian* and often *eyepiece Ramsden*. Also called microscope ocular. → Microscope.

**microscope for diamond examination**; a binocular microscope with dark-field illumination for use in the diamond examination.

**microscope for dark-filled illumination**; → dark-filled illumination.

**microscope for using of inclusions**; → microscope, horizontal microscope.

**microscope with photomicrograph;** a microscope fitted with a special photography device to take photos of a magnified image of a microscopic thin section, such as made by petrography. In Gemology photographs are taken of interior or exterior blemishes on a cut gemstone.

**microscope stage;** an adjustable part of a microscope, on which the object is placed. → Microscope.

**microscope, binocular;** → binocular microscope.

**microscope, compound;** → compound microscope.

**microscope, electron;** an electron microscope can be compared to that of an optical microscope, but only electrons are emitted instead of light. → Electron microscope.

**microscope, focusing of;** → focusing of microscope.

**microscope, gemolite;** → microscope.

**microscope, Greenough binocular;** a version of binocular microscope, in which two complete lens systems are fitted to give true stereoscopic vision. → Greenough microscope.

**microscope, horizontal;** → horizontal microscope.

**microscope, magnification of;** in microscope two separate magnifications are given; first by objective primary magnification and then by eyepiece second magnification, both multiplied together give the full magnification of a compound lens system. → Eyepiece Huygenian, eyepiece Ramsden.

**microscope, objective for;** → microscope, objective.

**microscope, oculars for;** → microscope, microscope eyepieces and eyepieces.

**microscope, pearl;** → pearl microscope.

**microscope, petrographic;** → microscope.

**microscope, petrological;** → microscope.

**microscope, polarizing;** a microscope fitted with two Nicol prisms, to produce polarized light.

**microscope, resolving power;** → resolving power of microscope.

**microscope, simple (lens);** same as lens or loupe. The simple microscope is a convex lens of short focal length, used to form a virtual image of an object placed just inside its principal focus.

**microscopic;** too small or fine to be visible to the naked eye.

**microscopic;** pertaining to the microscope.

**microscopical character of plastics;** may be seen flow lines like glass and gas bubbles in various shapes or in some engine-turned features such as in imitation ivory. → Plastics properties.

**microsection;** a thin section of rock or mineral which is highly polished. Thin sections are used for study of opaque and minute minerals in rock by plane or polarized reflected light. Also called polished thin section, thin polished section.

**microsection;** partial synonym for polished thin section.

**microsommitite;** → cancrinite.

**microspar;** material comprising of very tiny, clear calcium carbonate crystals.

**microtine;** plagioclase feldspar that has a similar appeared to sanidine.

**microwave amplification by simulated emission of radiation;** same as MASER.

**microwave phonon attenuation;** an electromagnetic waveguide device used in thermal properties of minerals to reduce the intensity of transmitted microwave in a lossy material. This technique can be used in tourmaline thermal properties temperature of which depend of microwave phonon attenuation.

**Middelbosch;** location of small alluvial diamond deposits in Bloemhop area, Transvaal Province, South Africa.

**Middle Congo;** same as Moyen Congo.

**Middelplaats;** location of alluvial diamond deposits in Kimberly area, Cape Province, South Africa.

**midling;** in ore dressing an intermediate product or removal of medium-sized gravels from other concentrate placers, in which diamonds are most likely to be found.

**Middleville diamond;** a misleading term for quartz crystal from Herkimer County, New York, USA. → Herkimer diamond.

**mid electra blue topaz;** → electra blue topaz.

**midge stone;** a moss agate or mocha stone variety of chalcedony with dendritic inclusions like a swarm of mosquitoes. Also called mosquito stone, gnat stone, mosquito agate.

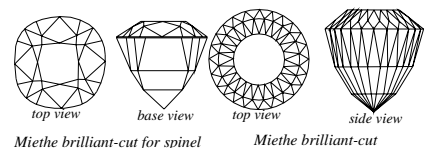
**Midnight Blue tanzanite;** a transparent blue tanzanite of 122.70 cts, now on display at the Smithsonian Institution, Washington, D.C., USA.

**Midnight Star;** → Midnight Star sapphire.

**Midnight Star sapphire;** a black star sapphire of 116 cts, now on display at Morgan Collection, America Museum of Natural History, New York City, USA. Also called Midnight Star.

**miemite;** a synonym for dolomite.

**Mie scattering;** an optical term applied to scattering of light by spherical particles comparable with wavelength of dielectric substance.



*Miethé brilliant-cut and for spinel*

**Miethé brilliant-cut;** two modified brilliant-cuts. Right

one is a round brilliant-cut having 48 triangular facets with a round and large table in the crown. The pavilion is relatively high with 48 facets without culet. Left one is a cushion shaped brilliant-cut with 32 facets with an 8-sided large table in the crown and pavilion is relatively high with 24 facets without culet.

**Mietjiesdoorns;** location of small alluvial diamond deposits in Wolmaransstad area, Transvaal Province, South Africa.

**migma;** an intimate mixture of mobile or potentially mobile magma and highly metamorphosed, but not melted rock.

**migmatite;** a coarse-grained, heterogenous mixed rock consisting of igneous or igneous-looking and/or metamorphic materials, which are usually distinguishable megascopically, such as gneisses, produced by the injection of granite magma schistose formation.

**mikrolith;** → microlite

**Milford Diamond;** a diamond of 6 cts, found in 1879 near Milford, Claremont County, Ohio, USA.

**milarite;** a rare mineral from the osumilite group. It can be faceted into minute gems and it is prized by collector's.

System: hexagonalic.

Formula:  $2[\text{KCa}_2\text{AlBe}_2(\text{Si}_{12}\text{O}_{30})\cdot\frac{1}{2}\text{H}_2\text{O}]$ .

Luster: vitreous.

Colors: colorless, pale yellowish, pale green, yellowish green.

Streak: colorless.

Diaphaneity: translucent to transparent.

Cleavage: none.

Fracture: conchoidal to uneven. Brittle.

SG: 2.46-2.61.

H: 5½-6.

Optics;  $\omega$ : 1.539,  $\epsilon$ : 1.541.

Birefringence: 0.002. ⊖.

Found in St. Gothard (Switzerland), Guanajuato (Mexico) and Namibia (Africa).

**milkama pebbles;** a commercial term for jasper pebbles.

**milkiness;** a descriptive of condition of cloudiness in glass or minerals.

**milk glass;** a translucent to opaque glass of milky-white color.

**milkiness;** a term used by Australian miners for an opal quality of milky luster, which detracts from brilliance, and play of color.

**milk opal;** a translucent to opaque, yellowish or greenish, milky-like variety of common opal, usually contains pin-fire effects and sometimes a play of red color. Also called milky opal.

**milkstone;** any various white minerals or stones such as flint pebbles.

**milkstone;** same as casein or galalith.

**milky diamond;** a descriptive of condition of diamond that has cloudy appearance due to small inclusions. Some fluorescent diamonds have a milky appearance in daylight.

**milky geuda;** a Singhalese term for a semitransparent to sub-translucent stone of milky appearance with slightly diesel effect in transmitted ray. → Geuda.

**milky look;** a misleading term used in Thailand by gem dealers for turbid sapphires from Bo Ploi, which is no real silk effect.

**milky opal;** → milk opal.

**milky quartz;** a milky white translucent to opaque variety of crystalline quartz of somewhat greasy luster. The milky color is caused by small cavities filled with numerous small fluids and CO<sub>2</sub> in liquid condition. Used as a gemstone. Also called greasy quartz. When it contains minute particles of gold, it is named gold quartz. *Quartz en chemise* is a milky quartz but the milkiness is not deep.

**mill;** in diamond cutting trade applied as scribe and sometimes for lap.

**mill;** a term employed to explain the building, in which diamonds are separated from kimberlite rock by crushing, panning, etc.

**mill, diamond;** → lap.

**millefiori;** a decorative glass from Italy, it mean, a thousand flowers.

**Miller indices;** a set of three or four Miller symbols (letters *h*, *k*, and *l* or whole number) determine the orientation of a crystal plane or face in relation to three crystallographic axes. The reciprocal of the intercepts of the plane on the axes are reduced to the smallest whole number or letter in ratio. A crystal face, which is parallel to a crystallographic axis is indicated by the symbol ∞. A crystal face, which intercepts the negative end of an axis, is signed negative and is placed above the appropriate symbol (1 2 3̄). A pyramid will have the general symbol 101 or 111, a pinacoid 001, a prism 100 or 110. Also called crystal indices, Miller indices, plane.

**Miller indices, plane;** same as Miller indices.

**Miller-Bravias indices;** → Miller indices.

**millerite;** very small crystals which have been faceted into small gems. Massive materials are cut cabochon and are prized by collector's. Hair-like variety is known as *capillary pyrite*. Also called trichopyrite, hair pyrite, nickel pyrite. Weak in yellow pleochroism.

System: hexagonalic.

Formula:  $3[\text{NiS}]$ .

Luster: metallic.

Colors: bronze yellow, brass yellow, brown, brassy-brown, greenish-blue, greenish-black.

Streak: greenish black.

Diaphaneity: translucent to opaque.

Cleavage: {1011} perfect, and {0112} indistincts.

Fracture: conchoidal to uneven. Brittle.

SG: 5.30-5.60.

H:3-3½.

Found in various states of the USA including Illinois, Wisconsin, Iowa, Pennsylvania, New York, and Missouri, the Czech Republic, Germany, Wales (England), and Ontario (Canada).

**millimeter**; a unit of length that equals one-thousandth of a meter with the abbreviation mm.

**millimeter screw micrometer**; an accurate caliper gauge, which determines the dimensions of unmounted polished gem to 0.01 millimeter. → Micrometer.

**millimicron**; a unit of length that equals one-thousandth of a micron with symbol m. Now called *nanometer* with the abbreviation nm.

**Millionaire Diamond**; → Regent Diamond.

**millstone**; a coarse-grained, hard, tough sandstone or fine quartz conglomerate used for grinding rocks, minerals, and other materials. Also called buhrstone, millstone grit sandstone.

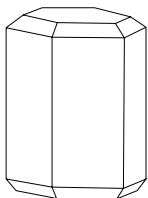
**mimetene**; same as mimetite.

**mimesite**; same as mimetite.

**mimetic crystal**; pertaining to a twinned crystal, which appears to have a higher grade of symmetry than it actually does. Facsimile crystal.

**mimetic crystallization**; another term for facsimile crystallization. Neomineralization or recrystallization in metamorphic process, which reproduces any pre-existing crystal forms or structures.

**mimetite**; a mineral of pyromorphite group. Small



*mimetite  
crystal*

crystals have been rarely faceted into small gems. Some materials are cut as cabochon and are prized by collector's. Also spelled

mimetene, mimesite, mimesite.

System: pseudohexagonal, monoclinic.

Formula:  $2[\text{Pb}_5(\text{AsO}_4)_3\text{Cl}]$ .

Luster: subadamantine to greasy.

Colors: yellow, yellow brown, sulfur yellow, orange yellow, brown, white, colorless.

Streak: white.

Diaphaneity: translucent.

Cleavage: none.

Fracture: subconchoidal to uneven. Brittle.

SG: 7.19-7.25.

H:3½-4.

Optics;  $\omega$ :2.147,  $\epsilon$ :2.128.

Birefringence: 0.019.  $\ominus$ .

Found in France, Scotland, Sweden, the Czech Republic, Austria, Mexico, Pennsylvania (USA).

**mimetite, luminescence**; orange-red under LWUV.

**mimetite, pleochroism**; weakly pleochroitic in yellow shades.

**mimetesite**; same as mimetite.

**mimicry**; imitation or simulation of crystal form lower symmetry to higher symmetry, which result in twinning.

**Mimosa**; location of small alluvial diamond deposits in the Schweizer Reneke area, Transvaal Province, South Africa.

**Minas Gerais**; a major gemstone and diamond producing state northeast of Rio de Janeiro, Brazil.

**Minas Gerais Diamond**; a rough diamond of 172.50 cts, found in 1937 on the Sant Antonio River, near Coromandel, Minas Gerais, Brazil. It was cut in a brilliant of about 80.00 cts, Present owner unknown.

**Minas Gerais emerald**; emerald from Minas Gerais state, Brazil.

**Minas Gerais topaz**; a light green ? Brazilian topaz of 271kg in rough, found 1943. Now on display at American Museum of Natural History, New York, USA.

**Minas Novas**; a gemstones bearing district of Minas Gerais, Brazil, such as beryl, chrysoberyl, garnet, topaz, amethyst, tourmaline, euclase, etc.

**Minas Novas chrysoberyl**; yellowish chrysoberyl from Minas Novas of Minas Gerais, Brazil, where it is usually found in the form of pebbles.

**Minas series of rocks**; a pre-Cambrian metamorphosed rock in Minas Gerais, Brazil, which contain no diamonds. It is overlaid by Itacolumy series.

**minable**; rock, mineral, material that can be mined profitably.

**minal**; same as end-member.

**mine**; an excavation or boring in the earth for digging out, minerals, precious stones, ores, coals of economic interest. The names pit, quarry, and opencast, open cut, strip are reserved for working during daylight.

**mine cut**; same as old mine cut.

**mined amber**; a term used as contrast to sea amber.

**miner**; one who is engaged in the economical business of getting valuable materials out of the earth.

**mineral**; a loose and inexact term that may be to define: usually homogeneous inorganic substance of definite physical properties and more or less chemical composition, which occur naturally in the earth, and usually possess a crystalline structure, which frequently finds outward expression in the crystalline form or other properties. Those materials, which are amorphous and some organic compounds are classified as

mineraloid. Rocks are composed of minerals.

**mineral**; any substance obtained by mining or digging.

**mineral aggregate**; an assemblage of one mineral species grains or more than one mineral species. When those mass of units or parts occurs in sediment in somewhat loosely associated one with the other by a natural binding agent. → Crystal aggregate, crystalline aggregate.

**mineral amber**; a term used as contrast to sea amber.

**mineral assemblage**; mass of minerals that compose a rock. Also called mineral association.

**mineral association**; same as mineral assemblage.

**mineral blossom**; same as drusy quartz.

**mineral cleavage**: the property of crystal of certain minerals, which can be broken or split along smooth planes parallel to certain actual crystallographic direction or directions or possible faces, when subjected to tension. → Cleavage.

**mineral cotton**; same as mineral wool.

**mineral deposit**; any mass of naturally occurring mineral matter in or on the earth's surface, which may be utilized for its industrial mineral or metal content.

**mineral economics**; same as geology of mineral deposits.

**mineral diagenesis**; rearrangement or recombination of a mineral resulting a new mineral due to diagenesis process.

**mineral fracture**; same as mineral rupture. → Fracture.

**mineral h**; a local and designation term for titanium-rich tourmaline from Crestmore, California, USA.

**mineral hardness**; same as mineral hardness. → Hardness.

**mineral identification**; minerals are identified by their characteristic properties; crystallographic, hardness, cleavage, specific gravity, diaphaneity, luster, color, streak, taste, smell, and touch. Identification of minerals.

**mineral kingdom**; mineral collective of the nature embracing all species.

**Mineralight**; a short-wave ultraviolet lamp for testing the luminescent effect of minerals.

**mineralization**; replacing the organic body by inorganic fossilization such as agatized wood.

**mineralization**; natural conversion or being converted into a mineral, as a metal into an oxide, sulfide, etc.

**mineralization**; action whereby a mineral or minerals are introduced into a rock.

**mineralogy**; the scientific study of minerals; their formation, occurrence, chemical composition, physical properties, and their classification. Oryctognosy and oryctology are obsolete terms.

**mineraloid**; naturally occurring usually inorganic substances, which are not definite enough in chemical

composition or physical properties to be considered as a mineral such as volcanic glasses, opals, or organic materials (hydrocarbons), and palagonite.

**mineral paint**; pigment minerals, such as barite, ochers, barite, gypsum, etc. → Mineral pigment.

**mineral particle**; same as mineral grain.

**mineral pigment**; natural or synthetic inorganic pigments used to give color, opacity, or body to a paint, plaster, or similar material. → Mineral paint.

**mineral rupture**; same as mineral fracture. → Fracture.

**mineral resin**; a group of natural resinous usually fossilized minerals. → Resin.

**mineral separation process**; same as froth flotation.

**mineral species**; a homogenous inorganic mineral, distinguished from other by its chemical composition and physical properties (refractive index, specific gravity, transparency, color, and hardness), may have a number of varieties. → Mineral variety.

**mineral synthesis**; mineral formed synthetically (artificially) in the laboratory and industry.

**mineral turquoise**; a term frequently used to distinguish natural turquoise from animal teeth or odontolite.

**mineral variety**; in mineralogy one of a number of related minerals, such as hornblende a variety of amphibole or emerald and aquamarine are varieties of beryl. In gemology these are used to distinguish color, other optical phenomena or characteristic. → Mineral species.

**mineral white**; gypsum powder used as a pigment. → Mineral pigment

**mineral wool**; an obsolete term for fine fibers of rock or glass made by blowing air or steam through slag. Also called slag wool, cinder hair.

**mineral yellow**; same as yellow ocher.

**Miner Diamond**; a rough diamond crystal of 44.62 cts, found in 1960 in Mir Pipe, Sakha, Russia. Believed to be part of the Russian Diamond Fund in Moscow.

**minerogenesis**; the origin and growth of minerals in or on the earth.

**mine run**; unscreened output of a mine.

**mine run**; the entire production of the mine before being sized and cleaned.

**mine run lots**; the production of the mine before being sized and cleaned, containing all grades from bad to good, and sell the lot in total.

**mine salting**; fraudulent enrichment of ore, or other mineral or gemstone samples. For example sprinkling upon the surface or introducing into the ground, gems or fragments of gold, etc. to increase apparent value of a mine. Also called salting. → Upgrade.

**miner's pan**; same as gold pan.

**miner's wallet**; a long bag, formerly used by miners for transporting gravels to water for screening.

**miniature;** very small or reduced painting, usually a portrait, made on metal or other material. Used for brooches, bracelets, or necklaces.

**minimum deviation;** in optics the position of two facets forming a prism or facets of unmounted gemstone, in which the smallest possible angle between the incident and refracted ray or emergent ray is seen, this angle is realized, when refraction is symmetrical. The measurement can be applied to transparent, unmounted faceted stones by using a table spectrometer. Also called angle of minimum deviation method. → spectrometer.

**minimum deviation method;** → minimum deviation.

**mining;** the method of obtaining useful minerals, gemstones or other ores from the earth crust, includes both opencast work or underground excavations.

**Mining Triangle;** a diamond location in southwestern, Minas Gerais, Brazil. Portuguese spelling is Triângulo Mineiro.

**minium;** a bright-red, scarlet, orange-red mineral  $4[\text{Pb}_2^{2+}\text{Pb}^{4+}\text{O}_4]$ . Tetragonal system. Luster greasy to dull. Orange-red streak. Opaque. SG:8.90-9.20. H:2-3. Soluble in water, when in powdered form. Found worldwide. It is prized by collectors and used as a protective paint. Also called red lead, red lead oxide.

**Minjusri;** a Chinese term used for another Bodhisattvas figure sitting on the back of a lion. → Chinese ritual and symbol jades.

**minnesotaite;** → talc.

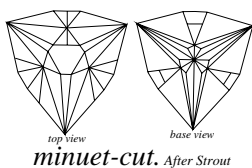
**minor elements;** those elements, which occurs in microscopic quantities in gemstones or rocks, much less than 1%, they are not part of the chemical formula of the stone, rock or mineral. Trace elements may alter some physical properties of gems for example its color. Also called accessory elements, guest elements, trace element.

**minor elements;** those elements, which occurs in minor amount in the earth's crust.

**mintage metal;** same as coinage metal.

**Miocene;** the fourth epoch of the Tertiary Period.

**minuet cut;** a modified brilliant-cut 7-sided outline with 24 triangular facets and a 6-sided table and a 3-rayed star in the crown. Pavilion having 30 facets without culet with a 3-rayed star.



**Mirabeau diamond;** a misleading term for quartz crystal from Ramuzat, France.

**miracle crown;** → illusion setting.

**miracle head;** → illusion setting.

**miracle top;** → illusion setting.

**miridis;** a commercial term for synthetic rutile used as a

diamond imitation.

**Mirny;** → Mirnyi.

**Mirnyi;** (Russian term for peaceful) the center of the diamond-mining area of Sakha, the Russian Federation, CIS. Also spelled Mirny.

**Mir diamond pipe;** (Mir is a Russian term for peace) a diamond-bearing Kimberlite pipe in the Vilyui River in Sakha (Yakutia), eastern Siberia, of the Russian Federation, CIS. It was discovered in 1955, open pit mining began in 1960.

**mirror foiling;** a method of foiling, by which a colorless, transparent, faceted gemstone is painted with a reflecting mirror surface, the pavilion is treated with a mercury alloy. → Chaton.

**mirror index;** same index glass.

**mirror foiling, gold or silver;** a method of foiling, by which highly polished gold or silver foil used by setting gems beneath the stone to reflect such light as passed through the gem. → Chaton, mirror foiling.

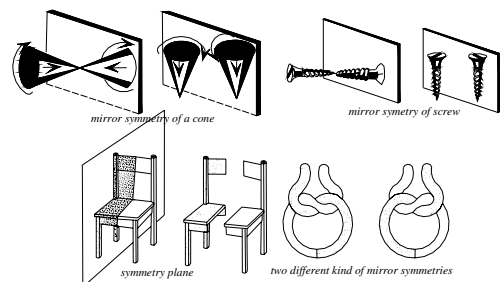
**Mirror of Portugal Diamond;** a fine-quality, rectangular table-cut diamond of 20.30 cts. Once belonged to Portuguese Crown Jewels, later owned by James I of England (1566-16250), and Charles I (1600-1649). Was sold and owned by Cardinal Mazarin of France. Bequeathed by Mazarin, together with other diamonds to the French Crown, which was stolen in the robbery from Grand Meuble in 1792. Present owner unknown. → Mazarin Diamonds.

**mirror plane;** same as plane of symmetry.

**mirror reflection;** same as specular reflection.

**mirror stone;** same as muscovite.

**mirror symmetry;** in crystallography, an imaginary plane through a crystal, which divides it into halves so that one is a mirror image of the other. This is very

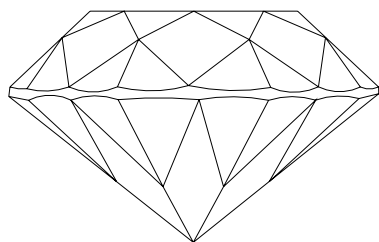


four kind of mirror symmetries. After Tassarow 1982

important for classification of crystals into their system and class. Also called plane of mirror symmetry or mirror plane.

**misalignment of facets;** when the facets in the crown, girdle and pavilion of a brilliant-cut diamond or other stone is cut too quickly finished the facets having no symmetry or the facets are placed as being out of line

or improperly adjusted.



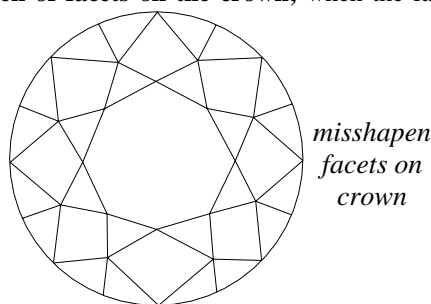
*misalignment of crown and pavilion facets*

**miscal**; an Iranian or Farsi weight unit for gems and precious metals, equal to 36.40 carats. Also spelled miskal, misqal.

**mischio marble**; a violet-red breccia from Serravezza, north-eastern Italy.

**misgrading**; a commercial term for diamond or other gemstones that are incorrectly graded for color, clarity, or proportion.

**misshapen of facets on the crown**; when the facets in



*misshapen facets on crown*

the crown of a brilliant-cut diamond or other stone is cut too quickly finished the facets having no symmetry or the facets are placed as being out of line or improperly adjusted.

**miskal**; same as miscal.

**miskeyite**; a massive, green variety of serpentine-chlorite similar to pseudophite from Tyrol, Austria. Used as an ornamental objects.

**misleading**; → misnomer.

**misnomer**; an error or incorrect term for gemstone, often but not always misleading to the true nature of the stone named.

**mispickel**; same as arsenopyrite.

**misrepresentation**; in selling gemstones or diamonds giving customers incorrect or incomplete information.

**misqal**; same as miscal.

**Mississippi dog-tooth pearl**; → dog-tooth pearl.

**Mississippi pearl**; an irregular variety of fresh-water pearl from Mississippi River, USA. Such pearls are of comparatively little value.

**Mitchemanskraal**; location of an alluvial diamond mine in Berkley, Cape Province, South Africa.

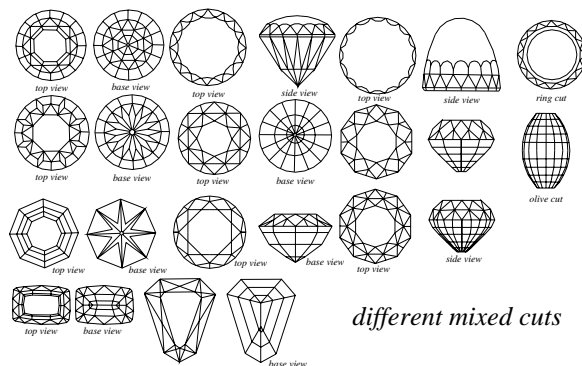
**Mittag**; location of an alluvial diamond mine along

Namibia Coast, Africa.

**Mittagong**; location of an alluvial diamond deposit southwest of Sydney, Australia.

**mixed crystal**; a crystal, in which certain isomorphous compounds or atoms of one or more elements are replaced. Also called mix crystal, solid solution.

**mixed cut**; a combination style of brilliant cut diamond or other transparent gemstone with two different cuts, the crown being brilliant cut (usually 32 facets) and the pavilion being step cut (usually same number of facets



*different mixed cuts*

as crown). The depth of the two parts is not fixed, therefore they can be cut shallower or deeper to improve the color and retain brilliancy. Variation of a mixed cut with an emerald cut crown is frequently used for zircon.

**mixed light**; same as white light.

**mixed reflection**; → spread reflection.

**mixte**; a French term for an assembled stone, half natural and half man-made.

**miya**; a Burmese (Myanmar) term for emerald.

**mizzonite**; a yellow variety of clear scapolite with the components marialite and meionite with the ratio 5:1 to 1:1. Found in Italy, Brazil and Malagasy. Synonym for dipyrte, dipyre.

**MMTC**; an acronym for the government owned Minerals and Metals Trading Corporation of India.

**Mn**; a chemical symbol for the element manganese.

**Mo**; chemical symbol for molybdenum.

**mocha pebble**; → mocha stone.

**mocha stone**; a white, gray, pale yellow to yellow variety of cryptocrystalline moss agate containing brown to red iron-bearing, or blackish manganese-bearing, dendritic inclusions, found in Arabian. Also spelled mochastone. Another term for mocha pebble, moss agate, Indian agate.

**mochastone**; same as mocha stone.

**mock ore**; a synonym for sphalerite.

**mock pearl**; another term frequently applied to an imitation pearl.

**Modder River**; location of an alluvial diamond deposit

river between Kimberly and Bloemfontein in South Africa.

**modern cut;** to retain the weight of a stone serious interference with the optical effect, designed several modified form of brilliant such as star-cut, Jubilee-cut, marquise-cut, pendeloque-cut, American-cut, etc. Also spelled moderne cut. → Fancy diamond.

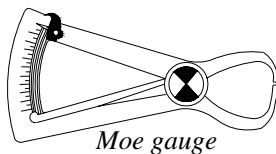
**moderne cut;** same as modern cut.

**mode rose cut;** a flat-based hexagonal rose cut with 6 facets on the crown.

**modified brilliant-cut;** a modern brilliant cut, based on the round brilliant. The standard arrangement of facets are 57 or 58.

**Moe diamond gauge;** same as Moe gauge.

**Moe gauge;** a caliper gauge used for estimating the weight of a brilliant-cut diamond by referring to the



*Moe gauge*

girdle diameter and depth of the stone from table to culet in millimeters supplied by gauge. Also called Moe diamond gauge. The approximated

weight is nearly 5% error carat for using of the estimation formulae or table. Also spelled Moe's gauge.

→ Stencil gauge, Leveridge gauge, caliper.

**Moe's gauge;** same as Moe gauge.

**Mogok diamond;** a local misleading term for colorless topaz from Mogok, Upper Myanmar (former Burma) used as a diamond imitation.

**Mogok Stone Tract;** a gem-bearing district in Upper Myanmar (former Burma), tourmalines, rubies, topaz, sapphire, zircons, etc., are found there.

**Mogul Archer's Bow?;** a Mogul engraved emerald ring, cut from a huge single piece of emerald. May it is from 17<sup>th</sup> centuries.

**Mogul cut;** an old lumpy form with a broad, often symmetrical base and the crown usually has four shallow facets or a table, and usually two or more rows of facets angling to the base. For example Taj-e-Mah is a Mogul cut.

**Mogul Dynasty;** → Great Mogul.

**Mogul Diamond;** → Great Mogul Diamond.

**Mohammedan blue;** same as Chinese blue.

**Mohave moonstone;** same as Mojave moonstone.

**Mohawkite;** → algonite, domeyite.

**Mohr balance;** → Westphal balance.

**Mohs' hardness scale;** the most commonly used ten standard scale of relative hardness of minerals. The scale is expressed in numbers ranging from 1 through 10: (1) talc, (2) gypsum, (3) calcite, (4) fluorite, (5) apatite, (6) orthoclase, (7) quartz, (8) topaz, (9) corundum, (10) diamond. Also called Mohs' scale, Mohs' scale of hardness. → Hardness.

**Mohs' scale of hardness;** → Mohs' hardness scale.

**Mohs' scale;** → Mohs' hardness scale.

**moissanite;** a hexagonal mineral with chemical formula: SiC found in meteorites. Synthetic moissanite known as carborundum and used as a diamond simulant, which has thermal conductivity similar to diamond. To identifies the moissanite from diamond and other synthetic stones used the electric conductivity. Optics;  $\omega$ :2.65,  $\epsilon$ :2.69. Birefringence: 0.043.  $\oplus$ . Dispersion: 0.80 twice that of diamond. SG:3.17. H:9-9½. Also known as silicon carbide.

**moissketeer;** a device used to identify the moissanite from diamond and synthetic stones.

**Mojave moonstone;** a misleading term for lilac-tinted translucent chalcedony found in Mojave Desert, California, USA. Also spelled Mohave moonstone.

**molar ivory;** → elephant teeth.

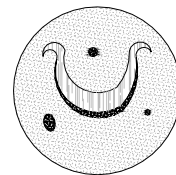
**mold;** a hollow form made in the earth or rock material by the exterior or interior of a fossil shell or other organic structure.

**mold;** a metal or wood form, in which molten glassware, plastics or ceramic are poured to form a certain shape.

**mold;** an impression made in the earth, sand or other heat resistant material, which gives form to precious or normal metal in a molten state.

**mold;** a variety of rubber with hollow shape, into which casting wax is poured to produce a formed pattern.

**moldavite;** an amorphous, corroded mass, translucent to transparent, olive-green, pale-green, deep-green, yellow-green, brown-green variety of tektite of meteoritic origin, that has been found near Vlatava



*glass streaky bizarre form in  
Zzech Republic moldavite*

River (German: Moldau) in Bohemia and Moravia, the Czech Republic. It is found in various forms; spherical, oval

and flattened. RI:1.488-1.503. SG:2.34-2.46. H:5-5½. Frequently used as a faceted gemstone. Found in Australia (australite), USA (georgiaite, bediasite), Indonesia (billitonite), Libyan (Libyan Desert). Also called moldavite, vltavite, pseudochrysolite. Sometimes called *bottle-stone* or *Water chrysolite*.

**molded cameo;** various models of cameo made by casting substances such as ceramic, glass, metal, plastic, or sealing wax in a mold.

**molded glass;** glass-ware, which is formed in a mold.

**molecular bond;** the force of linkage pair or more of different electrons, which holds a molecule at the same site on the surface of a crystal.

**molecular orbital theory;** an explanation for formation



of an electron orbital or transitional metal coordination in an inorganic molecule enclose the molecule as a whole atom.

**molecular weight**; the weight of a molecule of a substance referred to that of an atom of  $^{12}\text{C}$  taken as 12.00.

**molecular weight**; the sum of the atomic weights of all the atoms in a molecule therefore the molecular weight of  $\text{CaCO}_3$  (calcite) composed of one atom of calcium, one of carbon, and three of oxygen, is  $40 + 12 + (3 \times 16) = 100$ .

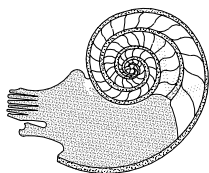
**molecule**; smallest chemical unit composed of one or more atoms. The atoms of a molecule are held together by chemical forces. The atoms in the molecule may be identical as single atom  $\text{O}_2$ ,  $\text{H}_2$ ,  $\text{S}_2$ , and  $\text{S}_8$ , or different atoms as in  $\text{CO}_2$  and  $\text{H}_2\text{O}$ . A molecule is the smallest quantity of an element or compound, which can exist by itself and retain all its chemical properties.

**Molina rosá marble**; a Spanish local term for reddish marble from Garfagnana of Tuscany, Italy.

**mollusc**; same as mollusk.

**mollusca**; same as mollusk.

**mollusks**; any member of soft-bodied, solitary invertebrate marine animals (usually with calcareous shells) belonging to the *Phylum Mollusca*, include mussels, clam, conch, octopuses, abalone, nautilus, jingle, shells, limpets, scallops, snails, squids, cockle, cuttlefish, oysters and boring forms. They are significant as a nonsegmented body, which is bilaterally symmetrical and has a radial or biradial symmetrical mantle



*mollusc marine cephalopod*

and shell. Mollusca containing major of subdivisions or phylla of the animal kingdom. Pearls are produced by some mollusks and all of these have shells, which are used to make beads, buttons, and other articles in jewelry. Some shells are used to make *shell cameo*, which is also called *mollusk cameo*. mollusks containing major of subdivisions or phylla of the animal kingdom. Also spelled mollusc or mollusca. → Gastropods, cephalopods, pelecypods.

**mollusk cameo**; → shell cameo.

**molochite**; a green variety of jasper.

**molo-k'ie-to**; a Chinese term for emerald.

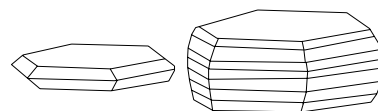
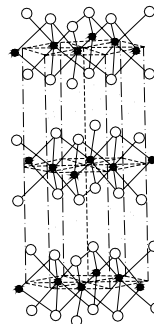
**Molopo Reserve**; location of a small alluvial diamond deposit in the Mafeking area, Cape Province, South Africa.

**molybdenite**; a silvery-white to lead gray mineral, trimorphous with jordisite and molybdenite-3R. Found as inclusions in some emeralds.

System: hexagonalic (trigonalic).

Formula:  $2[\text{MoS}_2]$ .

Luster: metallic.



*molybdenite structure and crystals*

Color: lead gray, silver-white.

Streak: greenish.

Diaphaneity: opaque.

Cleavage: {0001} perfect.

Fracture: uneven. Sectile.

SG: 4.62-4.65.

H: 1-1½.

Found in Norway, Sweden, England, Portugal, Russia, the Czech Republic, and USA.

**molybdenum**; a heavy, silvery-white, very hard metallic element of the Periodic System with the symbol Mo.

**momme**; a Japanese commercial weight measure of cultured pearls equivalent 18.75 carats or 3.75 gr.

**mona marble**; a local term for a serpentine marble from Holy Island, Wales, England.

**Monastery Mine**; location of a small diamond pipe mine in Winburg area, Orange Free, South Africa.

**monazite**; rarely fashioned but cut cabochon, prized by collectors. It may be partially metamict because the stone contains thorium and uranium traces. Pleochroism: reddish-orange and yellowish shades. Also called eremite, phosphocerite, urdite, cryptolite. Extremely complex spectra due to rare earth elements. Measurable radioactivity.

System: monoclinic.

Formula:  $4[(\text{Ce}, \text{La}, \text{Y}, \text{Th})(\text{PO}_4)]$ .

Luster: waxy or resinous to subadamantine.

Colors: pale yellow, yellowish brown, reddish-brown, yellowish-green, grayish, white.

Streak: grayish-white.

Diaphaneity: transparent to translucent.

Cleavage: {001} perfect, and {100} distincts.

Fracture: conchoidal to uneven. Brittle.

SG: 4.60-5.40.

H: 5-5½.

Optics:  $\alpha: 1.796$ ,  $\beta: 1.707$ ,  $\gamma: 1.841$ .

Birefringence: 0.049-0.055. ⊕.

Found in Norway, Malagasy, Sri Lanka, Switzerland, Bolivia, Brazil, India, Australia, Nigeria, Wyoming,

Colorado, New Mexico, and Virginia (USA).

**monazite absorption spectrum;** complex spectrum mostly from rare earth elements.

**monazite as an inclusions;** frequently found as inclusions in tourmalines.

**monazite luminescence;** greenish fluorescence under UV light.

**monazite placer;** another term for cryptolite placer.

**monazite pleochroism;** weak yellowish-shades or none. Sri Lankan monazite is reddish-orange and golden-yellow.

**monel;** same as monel metal.

**monel metal;** a trademark term for a white copper-nickel alloy of high tensile strength with great resistance to corrosion agents. It contains about 27% copper, 2-3% iron, and 68% nickel. Sometimes used for imitations of hematite cameos. Also called monel.

**money ore;** a local term in Sweden for iron ore similar to coin flake.

**money stone;** a local term in Pennsylvania, USA for rutile or red shorl.

**monitor jet;** a method of rinsing the earth used in Myanmar, (Burma), by which the earth containing rubies and sapphires using huge jets of water to washing down the stones.

**monoazo;** a compound contains an azo group, two samples of them are toluidine red and alizarin yellow. Used as colorants.

**monobromonaphthalene;** a volatile oily liquid, smelling like naphthalene with the formula  $C_{10}H_7Br$ . Used as an immersion fluid for examining gemstone in certain refractive index. RI:1.66. SG:1.49. Used as dilution for heavy liquids bromoform and methylene iodide.

**monochlorobenzene;** a liquid with refractive index 1.53.

**monochloronaphthalene;** a liquid with refractive index 1.63.

**monochromatic;** in optics having or pertaining to, one color or one hue only.

**monochromatic;** an electromagnetic radiation consisting of a single wavelength or frequently. Also called monochromatic light.

**monochromatic filter;** a filter to transmit light of single wavelength also used in refractometers. → Monochromator.

**monochromatic light;** electromagnetic light of a single wavelength or frequently. Used in crystal optics to measure indices of refraction.

**monochromatic illuminator;** → monochromator.

**monochromator;** a source system used to produce a narrow portion of a spectrum by absorption or

refraction of unwanted components. Also called monochromatic illuminator. → Monochromatic filter.

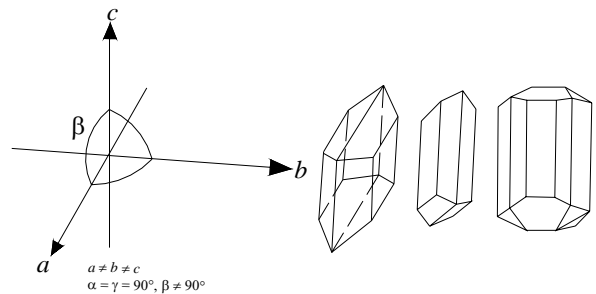
**monoclinic;** → monoclinic system.

**monoclinical structure;** a crystal with monoclinic lattice. → Monoclinic system.

**monoclinic crystal system;** → monoclinic system.

**monoclinic mineral;** → monoclinic system.

**monoclinic system;** a crystal is referred to a system of



monoclinic system

three unequal axes, two are obliquely inclined to each other, while the third is perpendicular to the plane formed by them. There is one diagonal axis of symmetry and one plane of symmetry. Also called monoclinic mineral, monoclinic stone, monoclinic, monoclinic crystal system.

**monoclinic stone;** → monoclinic system.

**monocrystal;** consisting of one crystal. → Monomineralic rock.

**monocular microscope;** a microscope with a single ocular piece for one eye. → Microscope.

**monogene;** a term applied to an igneous rock composed essentially of a single mineral such as dunite.

**monogram;** a combination of letters or initials carved on gems or jewels.

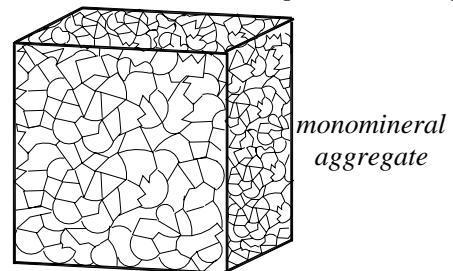
**monolith;** a large single upstanding in form of an obelisk or column or block of stone.

**monolith;** a huge upstanding rock mass, such as a volcanic spine.

**monolithic;** formed or carved from a huge single rock mass.

**monomineral;** → monomineralic rock.

**monomineralic rock;** a rock composed essentially of a



single mineral, such as anorthosite. Also called

monomineral, monomineralic, monogene, monogenic.

**monovalent**; chemical element having a valence of one, such as sodium. Also called univalent.

**monster pearl**; a rounded pearl, which is known as paragon pearl.

**Montana agate**; a translucent, pale gray to bluish-gray chalcedony with brownish-red bands and/or black (manganese-oxide or iron-oxide) dendritic inclusions. It occurs in nodules and fragments in gravels of Yellowstone River Valley, Montana, USA. Favorite ring stone for cut cabochon. Also called Montana moss agate, mocha agate, Yellowstone agate.

**Montana agate cut**; cut cabochon and favorite ring stone.

**Montana diamond**; a misleading term for rock crystal from Montana, USA. Used as diamond imitation.

**Montana jet**; a misleading term for black obsidian from Yellowstone River valley, Montana, USA.

**Montana moss agate**; translucent, light yellow or white agate with black dendritic inclusions pattern. → Montana agate.

**Montana ruby**; a misleading term for pyrope garnet or almandine garnet from Yellowstone River valley, Montana, USA.

**Montana ruby**; same as Montana sapphire, which sometimes has a suitable red color to be a ruby.

**Montana sapphire**; a commercial term for fine-quality, pale-blue, purple, grayish-green, violet colored water-worn pebble sapphires with a curious metallic luster found at Missouri River, Montana, USA. For a time the mine was called New Mine sapphire.

**montebrasite**; a triclinic mineral of amblygonite group. Formula:  $4[(\text{Li},\text{Na})\text{Al}(\text{OH},\text{F})\text{PO}_4]$ . Vitreous to greasy, pearly luster on cleavage. White to grayish, colorless, yellowish, greenish and bluish. Transparent to translucent. SG: 2.98-3.03. H: 5-6.

**monticellite**; a colorless to gray, greenish mineral variety of olivine group. Orthorhombic crystal. Formula:  $4[\text{CaMg}(\text{SiO}_4)]$ . Transparent to translucent. Vitreous luster. Streak: white. H:5.5. SG:3.08-3.27. Cleavage: {010} indistinct. Brittle.  $\alpha$ :1.639-1.654,  $\beta$ :1.646-1.664,  $\gamma$ :1.653-1.674. Birefringence: 0.018.  $\ominus$ . Found in Canada, USA, Israel, Scotland, Russia, Zaire and Australia. An iron-rich variety of monticellite is known as iron monticellite or kirschsteinite.

**Mont Blanc ruby**; a misleading term for reddish quartz, colored by numerous small flakes of hematite. → Rubasse.

**Mont Blanc ruby**; a misleading term for reddish garnet.

**monument cutter**; → stonecutter.

**monzonite**; a group of intermediate intrusive rocks with the composition between syenite and diorite. Also

called syenodiorite.

**moon agate**; same as luna agate.

**Moon Diamond**; a light yellow unmounted round brilliant-cut diamond of 183.00 cts, from India with 45 facets on the crown was sold in London in 1942. It is believed to have once been a part of the Russian Crown Jewels. Also known as Moon of the Mountain Diamond ?

**moon milk**; a plastic calcareous deposit of white color, which occurs in limestone caves. It may contain calcite, hydromagnesite, aragonite, magnesite or dolomite and huntite. Used as dyes. Also called mountain milk, rock milk, rock meal and agaric mineral or crumbly calcite.

**Moon of Baroda Diamond**; a pear-shaped, canary yellow diamond of 24.00 cts, from India. It was once worn by actress Marilyn Monroe in a film. It was auctioned by Christie's in 1991 in New York.

**Moon of the Mountain Diamond**; a legendary cut diamond of 121 cts, from India.

**moonstone**; a transparent to translucent, bluish sheen is a variety of orthoclase feldspar (adularia) and rarely of albite feldspar. When cut cabochon, it has a *sheen* known as *adularescence*, which is caused by internal alternate layer of albite and orthoclase of stone, which spread the light falling on the surface of cabochon. The reflected rays from the surface of stone are bluish to whitish silvery schiller, which is called *Rayleigh scattering*, more common on stones having thicker structure layers. Sometimes shows chatoyancy or cat's-eye, when cut cabochon. Fine-quality moonstones found in India, Sri Lanka, and Myanmar. Substitute material that can nearly imitate this effect are opalescent glass, white chalcedony that exhibits a light blue schiller, when cut cabochon also milky quartz, synthetic spinel that has been reheated or some amethyst showing moonstone effect through heat-treatment. *Black moonstone* is a misnomer for darkened variety of labradorite from Myanmar, or *pink moonstone* is a misnomer for scapolite, or *spectrolite* from Finland is a labradorite. Also misnamed as *water opal*. Oregon moonstone is a misleading term for chalcedony. It is one of the *birthstones* for June. Also called girasol, belomorite, hecatolite, water stone, Ceylon opal. → Blue moonstone, albite, labradorite, adularescence, orthoclase, chalcedony moonstone.

**moonstone cut**; moonstones are almost cut cabochon.

**moonstone glass**; an opal glass, which resembles moonstone.

**moonstone imitation**; → moonstone.

**moonstone, albite**; → albite moonstone.

**moonstone, black**; → moonstone.

**moonstone, orthoclase;** → moonstone.

**moor's head;** green or colorless tourmaline with a black-capped end from Elba, Italy. → Niggerhead.

**mor;** an Arabic term used by Masudi for first grade of emerald, first water with dazzling green color, usually inclusions free. Also spelled mar. → Asamm, bahri, and magrebi.

**Mora diamond;** a misleading term for rock crystal from Montana, USA. Used as a diamond imitation.

**Morales pearl;** same as Oviedo Pearl.

**moralla;** same as morallons.

**morallas;** same as morallons.

**morallion;** same as morallons.

**morallons;** a term used by Colombian miners for inferior translucent to opaque quality emerald from Colombian, which is an indication that a *pocket* or *canutillos* of emerald crystals will be found. Canutillos means good quality. Also spelled moralla, morallion, morrela, morallas.

**morella emerald;** same as morallons.

**mordant dye;** a compound capable of binding a dye to a stone or other material, which creates an insoluble *lake* in material. The resulting color depending on the metal of mordant such as alkali aluminum hydroxide with a soluble aluminum salt and alizarin red.

**mordenite;** a white, yellowish to pale pink silicate mineral member of zeolite group. Chemical formula:  $4[(Ca,Na_2,K_2)(Al_2Si_{10}O_{24}) \cdot 7H_2O]$ . Orthorhombic. Transparent to translucent. Vitreous to silky luster. Cleavage: {001} perfect, and {010} distinct. Conchoidal fracture. Brittle. Optics;  $\alpha$ :1.472-1.483,  $\beta$ :1.475-1.485,  $\gamma$ :1.477-1.487. Birefringence: 0.005.  $\oplus$  or  $\ominus$ . SG:2.12-2.15. H:4½-5. Found in Morden, King's County, Nova Scotia, Canada. Sometimes cut cabochons and displays weak chatoyancy. Also called ptilolite.

**Morgan Hill jasper;** orbicular, various colored jasper variety of chalcedony from Morgan Hill, California, USA. Cut cabochons.

**morganita;** a Spanish term for morganite.

**morganite;** a pale red-purple, rose, salmon to purplish red, cesium-bearing variety of beryl. Optics;  $\omega$ :1.578-1.600,  $\epsilon$ :1.572-1.592. Birefringence: 0.008-0.009.  $\ominus$ . Dispersion: 0.014. SG:2.80-2.90. Distinct dichroism. Cut as faceted gemstones. Found in Brazil, Malagasy, California (USA). Heat-treatment turn its color to yellow.

**morganite;** same as vorobyevite.

**Morganite, Brazil;** a step-cut morganite of 235.00 cts, from Brazil. Now on display at American Museum of Natural History in New York, USA.

**morganite cut;** usually in step cut, ovals, hearts and

brilliants.

**Morganite, Malagasy;** a step-cut morganite of 123.58 cts from Malagasy. Now on display at American Museum of Natural History in New York, USA.

**Morgenthau Topaz;** a blue, drop-shaped topaz of 1463 cts, It belonged to M. L. Morgenthau, was presented in 1920 to American Museum of Natural History, New York City, USA.

**Morgenzon;** location of a small alluvial diamond deposit in the Kimberly area, Cape Province, South Africa.

**Moriah stone;** a granular spotted serpentine variety of verde antique.

**morin test of beryl;** producing of blowpipe bead from crushed beryl and sodium carbonate, powdered the bead and dissolved in dilute hydrochloric acid followed by adding morin ( $C_{15}H_{10}O_7 \cdot 2H_2O$  that is dilute in methyl alcohol with some sodium), which fluoresces yellow-green under UV light. → Quinalizarin, P-nitrobenzene-azo-orcinol, alkalinity test.

**morion;** dark-brown to deep-black or almost black variety of smoky quartz.

**morning dew jade;** a descriptive Chinese term used to a sprinkled variety of jade with glistening specks or flecks.

**moro;** a Japanese term for oxblood coral. → Moro coral.

**moro coral;** dark-red to oxblood-red variety of Japanese coral from Ryukyu island, south of Japan.

**moroxite;** a blue to greenish-blue variety of apatite from Arendal, Norway.

**moroxite;** a misleading term for blue apatite from Canada sold as moroxite.

**morphology;** in crystallography, the study of the external shapes of crystals. Also called morphological crystallography.

**morphology;** in geomorphology the study of the shape of the Earth's surface.

**morphology;** in Science the study of form, structure and development, which influence the form of matter.

**morphological crystallography;** same as morphology.

**Morrisonite jasper;** location of various color jasper a varieties of chalcedony from Morrison, Oregon, USA.

**Morrissey Diamond;** same as Dewey Diamond.

**Morro de Chapéu;** location of a small alluvial diamond deposit in Bahia Province, Brazil.

**morse ivory;** the tusks of the amphibious marine mammal walrus that are sometimes called morse, which is used as dentine ivory. → Walrus ivory.

**mortar;** a bowl-shaped vessel, made of agate, porcelain, glass, or steel, in which minerals or other solids are ground up with pestle. Diamonds are reducing to powder in a steel mortar fitted with a pestle.

**mortar**; a plastic mixture of cementitious substances, fine granular fragments, and certain liquid or water.

**mortar**; to fix or to plaster with mortar.

**mortar**; an organic cement like substance consisting of conchiolin, which holds the second layer or prismatic layer of a nacre of pearl together.

**mosaic**; a structure of crystalline solids caused by dislocation, consisting of an irregular matrix or mosaic of otherwise perfect crystalline.

**mosaic**; a decorative art of picture or pattern formed by very small adjacent pieces *tesserae*, opaque, geometrical shaped, varicolored fragments ornamental hardstones such as lapis, turquoise, malachite, azurite, marble, coral, which is named as *florentine mosaic*. Also known as *inlay work*, *intarsia* or *pietre dure*



*mosaic agate*

(*pietra dura*). The patterns are usually of flowers, or scenes and cemented on a background of white or black marble slab. When the pieces consist of cut geometrical shapes set in a metal mount this is known as *parquetry*. When varicolored fragments are made from non-natural materials such as glass rods cemented together as a glass frame is called *Byzantine mosaic* or *Roman mosaic*. Usually the decorative motifs are pictorial views, such as flowers, pets, buildings, and Egyptian motifs. Some samples are enameled fragments.

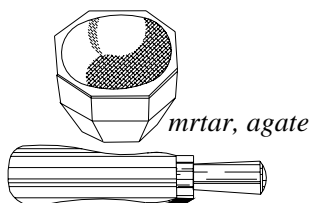
**mosaic**; a decorative rock texture consisting of grains or fragments, which form a relative irregular, slightly curved or straight contact pattern.

**mosaic texture**; a term applied in petrology to a granoblastic texture, so that the dividing planes between grains are flat or nearly flat.

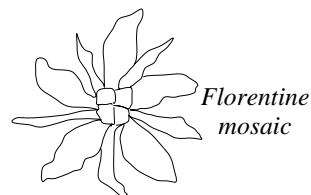
**mosaic agate**; a term applied to brecciated Mexican agate.

**mosaic doublet**; really a triplet, assembled of two transparent pieces of colorless stone usually synthetic white spinel for crown and pavilion. Between the two layers a mosaic of three colors of triangles, squares or rectangular patterns is inserted.

**mosaic, florentine**; a picture or pattern design formed by small, opaque, geometrically shaped, varicolored



fragments of ornamental hardstones such as lapis, turquoise, malachite, azurite, marble, and coral, which is named as *florentine mosaic*. The patterns are usually of flowers, or natural scenes and are cemented on a background of white or black marble. Used for making boxes, and plaques, or sometimes as ornaments. Materials used for florentine



mosaic are pieces of colored stones such as marble, malachite, opal, turquoise, lapis lazuli, coral, etc. Also known as *inlay work*, *intarsia* or *pietre dure* or spelled *pietra dura*. → Fictile mosaic.

**mosaic gold**; a decorative art work of various-colored gold fragments composed like a mosaic.

**moss-in snow**; a term used for translucent mottled white jadeite which contain green strikes or spots.

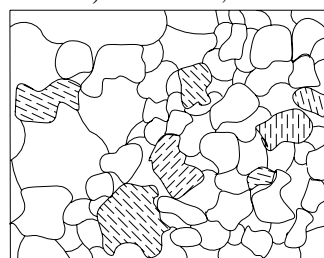
**moss opal**; a term used by Australian miners for common opal, resembling moss. Also called moss.

**moss opal**; a term used by Australian miners for an opal feature of gray-blue-green color, resembling moss. Also called moss.

**mosaic structure**; (a) in mineralogy, a substructure, in which grains have only slightly irregular orientation of small crystal fragments appearing in polarized light (b) or can be seen with naked eye.

**mosaic style**; same as mosaic.

**mosaic texture**; a texture, in which small crystal



*mosaic stones*

fragments appear angular under polarized microscope, like a pieces of a mosaic.

**mosaic triplet**; → mosaic doublet.

**moscovite**; another spelling for muscovite.

**Moslem prayer rosary beads**; → prayer beads.

**mosquito agate**; a variety of chalcedony with dendritic inclusions like a swarm of mosquitoes. Also called midge stone or mocha stone.

**mosquito amethyst**; amethyst with the platy or scaly inclusions of goethite like a swarm of mosquitoes.

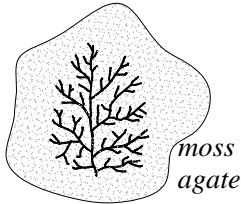
**mosquito stone**; a variety of mocha stone.

**moss**; in gemology a term for fracture, fissure, or flaw in a gemstone, which produce the appearance of moss,

such as a fracture in an emerald.

**moss;** same as moss opal.

**moss agate;** a general name for any variegated variety of white nearly translucent cryptocrystalline quartz containing visible brown or black mosslike, fern, leaf, tree-like or certain vegetation and dendritic form, due to the oxide of manganese or iron oxide distributed through the stone. The dendrites are frequently secondary chemical precipitates. Found in India, New Mexico, Colorado, Oregon, Texas (USA). Cut cabochon as oval, round, or drop-shaped. Imitation of moss agate made like *moss agate*



*doublet*. Also called moss stone, mocha stone.

**moss agate;** a moss agate with green inclusions of actinolite or of other green materials. Also called moss stone.

**moss agate doublet;** a moss agate imitation that is a chemical product of manganese oxide. When gelatin is placed on a glass plate and heated a tree like pattern occurs, then this is cemented to another glass plate.

**moss gold;** gold inclusions in dendritic form in agate or chalcedony.

**moss jasper;** petrified wood from Arizona, USA, in which opaque and colored jasper together with streaks of chalcedony can be seen. Cut cabochon.

**moss opal;** a variety of cloudy opal with brown to black dendritic inclusions similar to moss, tree-like, or fern. Also called moss.

**moss silver;** a descriptive term for silver inclusions in dendritic form in agate or chalcedony.

**moss stone;** → moss agate.

**mossy;** certain minerals have inclusions similar in appearance to moss. Also called mossy stone.

**mossy stone;** stone included cloudy fissures, such as emeralds.

**mossy stone;** same as mossy.

**mother crystal;** a mass of raw quartz, that can be faced or rough, as found in nature.

**mother liquid;** same as mother liquor.

**mother liquor;** the magmatic rest solution after crystallization of the important component, from which a mineral deposit has become crystallized or precipitated. Also called mother liquid.

**mother liquor;** any liquid, from which crystals are formed.

**mother nature's erector set;** same as lattice framework.

**mother-of-emerald;** a misleading term for a variety of prase or green jasper. Prase is often embedded in jasper. Also called root of emerald.

**mother-of-emerald;** a misleading term for a green variety of fluorite.

**mother nature's erector;** another term for lattice framework.

**mother-of-emerald;** a misleading term for a green variety of fluorite, jasper, prase, etc, because of an ancient believing that these green stones are easy to ripen, which means the stone can be turn into emerald.

**mother-of-opal;** rocky matrix containing small flecks or steaks of opals. Also called matrix opal, matrix.

**mother-of-pearl;** the third layer or an iridescent nacreous layer of a pearl-bearing mollusks or shells, made of the mineral aragonite or calcite (CaCO<sub>3</sub>) and an organic compound conchiolin (C<sub>32</sub>H<sub>48</sub>N<sub>9</sub>O<sub>11</sub>) and scleroprotein, a type of Keratin. The third innermost the nacreous layer of shell consist of microscopically very thin platelets while overlapping each other parallel to outer surface with zigzag edges. The combination of edges and film-like layers together make *orient of pearl* due to interference and diffraction effect of light. Mother-of-pearl is extensively used for making ornamental objects and small beads for inserting in mussels for production of cultured pearl industry. → Nacre, prismatic layer.

**mother-of-pearl cut;** pearly shells of the genus Pinctada can be cut as small cabochon, tumbled, spherical, and drilled pieces. Prized for buttons, knife handles, veneers, small spoons, inlays, and carved articles such cameos and intaglios, because of its fine iridescence, large quantities and thickness.

**mother-of-pearl of freshwater;** → treatment of mother-of-pearls.

**mother-of-pearl for cultured pearls;** → mother-of-pearl.

**mother-of-pearl rough;** mother-of-pearl obtained in Australia, Japan, Tahiti, Mexico, Philippines, Mississippi, California, Florida (USA), Indian Ocean, etc.

**mother-of-pearl agate;** same as cachalong.

**mother-of-pearl opal;** same as cachalong.

**mother-of-ruby;** a misleading term for red garnet.

**mother-of-ruby;** same as ruby matrix.

**mother of the god's amber;** a symbol of worshipper used by Baltic Germanic tribes.

**mother oyster;** a term used for the inserting of bead nucleus in tissue from the mantle of another mussel into position in the oyster for cultured pearl.

**mother rock;** any rock, from which other rock included sediments rock are drived or, in which minerals or

gems are found. Same as matrix.

**motichul**; a Hindu term for diamonds that are clear and brilliant.

**mottled**; a term used by Australian miners for a variety of sandstone or clayey nodule material above ironstone usually with poor quality of opal. Also called mottled sandstone, cuckoo.

**mottled**; same as cuckoo.

**mottled matrix**; a kind of turquoise with various patches and not uniform in colors found in Nevada, USA.

**mottled sandstone**; same as mottled, cuckoo sandstone, speckled hen.

**mottled stones**; a form of decorative stone with patches of various but not uniform colors.

**mottling**; a form of decoration of vitreous enamelware, or glazed tiles.

**Mouawad Lilac Pink Diamond**; a pink diamond of 24.44 cts, with uncertain origin was purchased by Robert Mouawad in 1976.

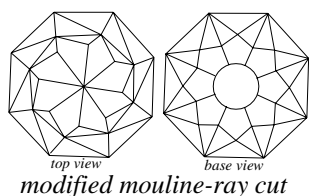
**Mouawad Splendour Diamond**; a white pear-mixed cut diamond of 101.84 cts, of uncertain origin, was owned by Robert Mouawad in 1990

**Mouawad White Diamond**; a white, marquise-cut diamond of 48.28 cts, of uncertain origin, was owned by Robert Mouawad in 1990

**moukaite**; a pink and white striped jasper from Australia.

**mould**; another spelling for mold.

**mouline cut**; a modified octagonal brilliant-cut with 32



facets in the crown, from center of crown an eight-rayed star similar to propel of windmill spread outward. In the pavilion, there are 32

facets with a large culet and seen an 8-rayed star.

**Mounce Diamond**; a light-brown, rough diamond of 18.20 cts, found in 1969 in a yard at Princeton, Louisiana, USA. In length it is the largest diamond in the United States. It was purchased by Mounce who cut it into three stones of 3.47 cts, oval, 2.75 cts, heart, and 2.27 cts, marquise.

**mount**; a metal framework made of gold, silver, etc., into which a gemstone, glass, or pottery is set in various forms and techniques to improve the beauty of the stone. Also called mounting.

**mountain**; same as mountain opal.

**mountain azure**; same as mountain blue.

**mountain blue**; same as azurite.

**mountain blue**; an obsolete term for chrysocolla.

**mountain cork**; a whitish or gray variety of asbestos, which consists of thick interlaced fibers resembling cork, such as tremolite cork, which floats on water. Also called mountain paper, mountain leather, pilolite, rock leather, rock cork.

**mountain crystal**; another term for quartz or rock crystal. Also spelled *crystallus montanus* in Latin.

**mountain flax**; same as fine silky variety of asbestos.

**mountain green**; same as chrysocolla.

**mountain green**; another term for malachite.

**mountain green**; same as green earth.

**mountain jet**; a misleading term for black obsidian.

**mountain leather**; same as mountain cork.

**mountain leather**; synonym for fibrous palygorskite or sepiolite. Also called leatherstone.

**mountain leather**; a term used for a asbestiform of tourmaline mineral with this peculiar appearance such as those from near Portland, Connecticut, USA and Minas Gerais, Brazil.

**Mountain Lily topaz**; location for fine blue topaz in San Diego, California, USA.

**mountain mahogany**; a striped red and black variety of obsidian used for carving and ornamental objects.

**mountain milk**; same as moon milk.

**Mountain of Light Diamond**; same as Koh-i-Nûr Diamond.

**Mountain of Splendor Diamond**; a diamond of 135 cts, Believed belonged to the National Jewel Treasury of Iran, although it was not recorded by Meen. Present Owner unknown.

**mountain opal**; a distinguish term used by Australian miners for a variety of opal formed from silica of volcanic origin. Not to be confused with sandstone. Also called mountain.

**mountain opal**; same as volcanic opal.

**mountain paper**; same as mountain cork.

**mountain ruby**; a misleading term for red garnet.

**mountain soap**; same as saponite.

**mountain stone**; a Chinese term for jade.

**mountain wood**; a gray to brown, compact fibrous variety of asbestos similar to dry wood in appearance. Also called rock wood.

**mountain wood**; sepiolite a fibrous clay mineral.

**mountain wood**; synonym for palygorskite or sepiolite.

**mounted goods**; → mounted stone.

**mounted stone**; gemstone set or fixed into the metal framework for ear-rings, finger rings, brooches, pendants, etc. Also called mounted goods.

**mounted stone**; diamonds fixed in rings.

**mounted stone**; backing the stones with foil or thin metal leaf to impart or improve their color, brilliancy or both.

**mounting;** fastening or fixing of a stone in a provided place.

**mounting;** → mount, mounted stone.

**Mount Ross;** numerous locations for pipe and alluvial diamond deposit in New South Wales, Australia.

**mousseline;** same as mousseline glass.

**mousseline glass;** very thin glass, blown so as to imitate pattern in lace. Also called mousseline or muslin glass.

**mouth jade;** a term sometimes used as a synonym for tomb jade. Usually a reddish or brown jade piece, which has been buried together with quicksilver in the mouth of dead. → Tomb jade.

**mozarkite;** a red, rose, or brown flint or chert, which is partially layered with chalcedony or agate strips. It is easy to polishing. Found in Ozark Mountain, between South Missouri, North Arkansas, and North-East Oklahoma, USA.

**Moyen Congo;** location of a small diamond deposit in Middle Congo former French Equatorial Africa. Also called Middle Congo.

**moyu xiashui sha;** a Chinese term for special sand used to polishing jade.

**Mr. Diamond;** a commercial term for colorless man-made corundum.

**Mridgarva;** a Sanskrit term used in past in India for defect grading of sapphire. → Sapphire, defects of in Hindu.

**mtorodite;** a translucent, deep spinach green variety of chalcedony or chrysoprase colored by chrome from Mtoroshanga in north Zimbabwe, Africa. It exhibits red under color filter and has a band spectrum in the red. Also spelled mtorolite and misspelled matorolite or matorodite.

**mtorolite;** same as mtorodite.

**muchydd;** an old term used in Welsh for jet.

**muck;** rubbish, waste or useless rock or material.

**muckite;** a yellow variety of retinite resin found in coalbeds at Neudorf near the valley Oder in the Czech Republic

**mucket pearl;** a sweet-water pearl from the *Lampsilis ligamentinus* mussel fished from the Mississippi Valley, USA.

**mud;** a slimy, sticky, or slippery, aqueous suspension consisting of silicon carbide grit and water, used in lapidary as an abrasive in sawing of colored stones. Sometimes a minute amount of flour or clay is added because greater viscosity.

**mud;** a term used by Australian miners for a deep level resembles soil or dried mud or typical opal dirt, containing no sandstone, little or not ironstone.

**mud boulder;** a term used by Australian miners for clay boulder found in the opal dirt lies under the

sandstone. Also called clay-boulder.

**mud bug;** same as mud pipe.

**mud center pearl;** natural pearls with a central core rich in conchiolin, which can be seen in *blue pearls*. → Ligament pearl.

**mud lapping;** → lapping.

**mud pearl;** dark natural pearl with a central core rich in coarse calcite instead of thin conchiolin layers. → Blue pearl, mud center pearl.

**mud pipe;** a term used by Australian miners for long, soft, pencil-like pieces of substances which occurs in the opal dirt and sandstone mass, rarely contains precious opal. Also called mud bug.

**mud saw;** a flat revolving disk of steel or copper usually 12 to 18 inches in diameter used by lapidaries for grinding and polishing colored gemstones, which passes through a metal container partly filled with mud.

**mud stone;** a semitransparent or dull sediment stone due to impurities occurs by compacting and hardening of mud materials. Also called muddy stone and spelled mudstone.

**mudstone;** another spelling of mud stone.

**muddy diamond;** a commercial term for a semitranslucent diamond of inferior brilliancy, caused by numerous small inclusions or extensive fractures and cleavages.

**muddy stone;** same as mud stone.

**Muiane Quarry Beryl;** a giant size beryl of 2.4 meters in diameter, found at Alto Ligonha, Mozambique.

**Muiskraal;** location of a small alluvial diamond mine in the Potchefstroom, Transvaal Province, South Africa.

**muja;** a Burmese, (Myanmar) term for emerald.

**Mujgawan;** location of a kimberlite diamond pipe near the town Vindhya Pradesh, India.

**mukhinite;** a brown-black variety of epidote or clinozoisite contain  $Al_2V^{+3}$  instead of  $Al_3$ . Optics;  $\alpha$ :1.723,  $\beta$ :1.733,  $\gamma$ :1.755. Birefringence: 0.032.  $\oplus$ . H:8. SG  $\approx$  3.3-3.5. Found in Gornaya Shoriya, West-Siberia, the Russian Federation, CIS.

**Muller's glass;** another spelling for Müller's glass.

**Müller's glass;** a term applied to a glass clear hyalite variety of little-value opal similar to melted glass. Also spelled Muller's glass and called glass opal, glassy.

**mullock;** a misspelling of bullock used by opal miners in Australia.

**mullock;** a synonym for waste rock.

**multicolored tourmaline;** → tourmaline,-multicolored.

**multi-facet diamond;** a commercial term for a brilliant-cut diamond with a polished or faceted girdle. Such a brilliant cut has a total of 98 facets. Also called multiple-facet cut.

**multiple;** → base price of pearl.



**multiple facet cut;** same as multiple-facet diamond.

**multiple-layer diamond dressing;** tool used in lapidary to straighten and smooth grinding wheels.

**multiple pearl;** pearl, which is grown of more than three distinct pearls united under a nacreous coating of shells. → Double pearl, triple pearl.

**multiple twin;** same as repeated twinning or polysynthetic twinning.

**multi twin;** same as repeated twinning or polysynthetic twinning.

**mundic;** a synonym for pyrite.

**Munsell Color System;** a color terminology used for to describing the colors in term of hue, tone and intensity structured similar to international color system of Munsell, by which can determine the color with unaided eye.

**muntenite;** a variety of amber from Rumania.

**murchisonite;** a flesh-red variety of orthoclase, similar to perthite.

**murchisonite;** a moonstone and iridescent variety of feldspar from Frederiksvaern Norway.

**Murex brandaris;** → *Murex purpura haemestoma*, tyrian purple.

**Murex purpura haemestoma;** a univalve gastropod of huge family of mollusk. Grounded shellfish was mixed with salt and boiled to obtain a dye substance of reddish purple color with the name royal purple. Also called *Murex brandaris*.

**Murfreesboro;** a popular town in Arkansas, USA, near the diamond-bearing pipe.

**muritic acid;** a popular term for hydrochloric acid a liquid of HCl.

**murguika;** an old Indian term for emerald.

**Mursinka aquamarine;** location of pale-blue to greenish aquamarine found in Mursinka, Ural, the Russian Federation, CIS.

**Mursinka topaz;** pale-blue topaz found in Mursinka, Ural, Russia.

**muscles of pearl;** there are nearly seven muscles in pearl oysters such as adductor muscle, retractors, levators, two posteriors and two anteriors.

**muscle pearl;** small baroque-shaped, fine colored pearls found in the neighborhood of the abductor muscle, near its attachment to the shell.

**muscovite;** a mineral of mica group. Monoclinic system. Formula:  $4[\text{KAl}_2(\text{AlSi}_3\text{O}_{10})(\text{F,OH})_2]$ . Pearly luster on cleavage. Colorless, grayish, silvery-white, greenish, pale brown. Colorless to white streak. Transparent to translucent. Cleavage: {001} easy. Optics;  $\alpha$ :1.556,  $\beta$ :1.587,  $\gamma$ :1.593. Birefringence: 0.038.  $\ominus$ . SG:2.77-3.10. H:2-2½. Found worldwide. Massive variety of muscovite is known as damourite. Also called

muscovite glass, common mica, white mica, muscovy glass, mica stone, mirror stone, adamsite (obsolete). Also spelled moscovite. → Mica.

**muscovite as an inclusion;** muscovite occurs as inclusions in garnets, tourmalines, emeralds, topazes, and in verdite.

**muscovite glass;** same as muscovite.

**muscovy glass;** same as muscovite.

**museum gem collections;** same as museum of minerals.

**museum of gems;** same as museum of minerals.

**museum of minerals;** a place or building where minerals or gemstones of scientific and popular interest are exhibited or studied. Also called museum of gems, museum gem collections, cabinet of minerals, etc.

**mushroom;** an informal term used by Australian miners for flat nobby, which is concave below and convex on the upper surface similar to mushroom body.

**muslin glass;** same as mousseline glass.

**mussel;** any saltwater bivalve mollusk of the genus *Mytilidae*.

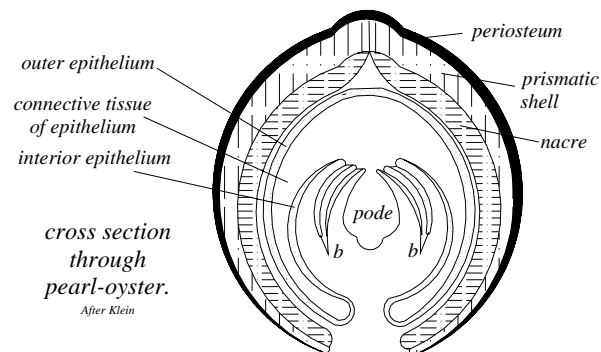
**mussel;** any fresh-water clam of the genus *Unionidae*, of which certain varieties of both produce pearls.

**mussel-egg;** a local term for fresh-water pearls by Tennessee, USA.

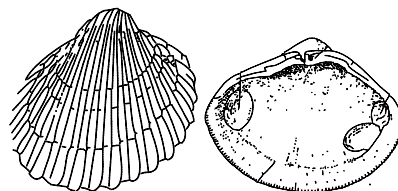
**mussel foot;** same as oyster foot.

**mussel gold;** decoration of pottery with prepared gold, which traditionally stored in mussel shells.

**mussel pearl;** a kind of fresh-water pearl bearing mussel of species *Unio margaritifera* or *clam pearl* a number



of these mussel produced nacreous pearls. The pearls are



exterior and interior of mussel

usually dark with little luster and inferior quality in relation to oyster pearl which have various colors and

greater beauty. Found in the rivers of America and Europe. → Fresh-water pearl, mytilus pearl.

**mussel shell;** same as mussel.

**mussite;** same as diopside.

**mustard gold;** very fine gold with earthy color from New South Wales, Australia.

**mutton fat jade;** a yellowish-green or greenish-gray to creamy buff, translucent variety of nephrite-jade with greasy luster resembling mutton fat. It is used for ornamental objects. Chinese spelling is *yang-chih-Yü*. Also called mutton fat nephrite.

**mutton fat nephrite;** same as mutton fat jade.

**mutton jade;** → mutton fat jade.

**mutu;** → fineness.

**mutzschen diamond;** a misleading term for rock crystal from Mutzschen, Saxony, Germany.

**Muzo emerald;** a commercial term for finest emerald from Muzo Mine, North-West Bogota, Colombian. → Chibcha stone, Somondoco emerald, Chivor emerald.

**Mwadui Mine;** location of a diamond mine in Tanzania, Africa. This is the Williamson Mine, now mined by De Beers Consolidation Mines, Ltd., and the State of Tanzania. → Williamson Mine.

**mya yay;** a term applied in Myanmar, (Burma) to the best quality, translucent variety of jadeite with uniform grass-green color. → Jadeite colors in Burmese.

**yay kyauk;** a Burmese (Myanmar) term for translucent

grass green jadeite. → Jadeite colors in Burmese.

**mylonite;** a compact, chert-like metamorphic rock without cleavage which has streaky or banded structure, formed by extremely granulation and shearing of rock during of action of dynamic metamorphism. Sometimes described as a microbreccia with fluxion structure.

**myrickite;** a translucent whitish or grayish common chalcedony, opal or massive quartz with streaks and clouds, which is colored bright red or pink by inclusions of cinnabar.

**myrickite;** a term applied to opal variety, which is called opalite.

**Myrle McFarlin Canary Diamond;** same as McFarlin Diamond.

**myrmekite;** a term applied to an intergrowth of plagioclase and vermiculite quartz, generally replacing potassium feldspar, formed during plutonic activity.

**Mytilidae;** a family of conchiferous bivalve sea mussels characterized by an oval and equivalve shell, it is an important shell in gemologically for making seed pearls.

**Mytilus cygnus;** a kind of pearl-bearing mussel of Mytilidae genus were utilized by Chinese.

**Mytilus gallo-provincialis;** a family of conchiferous genus mussel from the coast of France.

**Mytilus pearls;** pearl from Mytilidae genus mussel.

# N n

**n**; in optics a symbol for refractive index (RI).

**N**; a chemical symbol for the element nitrogen.

**Na**; a chemical symbol for the element sodium.

**NAA**; an acronym for neutron activation analysis.

**naat**; a Dutch word for a thin, flat twinned true diamond of any size.

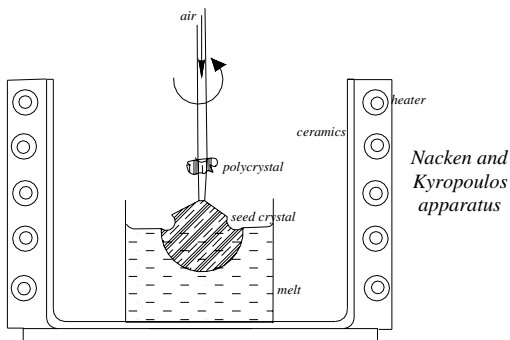
**naat**; knot, which often creates problems in cleaving and polishing the stone. A knot stands out as a small, raised surface after the polishing process, such diamond is known as *hard*. Also called knot. → Macle.

**Nabresina marble**; a fine-grained, encrinital marble of pale color from Istria, Croatia.

**nácar**; Spanish spelling for nacre.

**nachangshi**; a Chinese term for green albite used as jade.

**Nacken flux-grown synthetic emerald**; a method of synthetic emerald which was developed and produced by E. Nacken, Germany, in about 1928, which contain



no water. Natural emeralds from hydrothermal contain water. The fine color of synthetic emerald was achieved by adding vanadium oxide.

**nacker**; another spelling of nacre.

**nacre**; the horny, hard, iridescent outer layers that are a component of pearls and mother-of-pearls, which is a secretion produced by the mantle of certain mollusks and consists of small 6-sided crystalline calcium carbonate ( $\text{CaCO}_3$ ) principally calcite or aragonite and web-like deposit of organic conchiolin cells ( $\text{C}_{32}\text{H}_{48}\text{N}_9\text{O}_{11}$ ). A scleroprotein keratin type, which causes the luster and iridescence. Depends on the transparency and placement of crystals. The small prism crystals of calcium carbonate arranged at right angles of their prismatic axes perpendicular to the surface of the layer (known as *prismatic layer*) and are

held together by a cement of conchiolin or *mortar*. Nacre is prized for buttons, knife handles, small spoons, inlays, and carving articles such as cameos and intaglios, because of its fine iridescence, large quantities, and thickness. Also spelled nacker. Another term for mother-of-pearl. → Nacreous.

**nacreless pearls**; purplish-brown colored spherical and button-shaped pearls without nacre produced by some bivalve mollusks such as cherrystone clam. These have little or no value.

**nacreous**; composed of layers or a coating of nacre, or to have the appearance resembling nacre. Also called pearly.

**nacreous**; the iridescence luster of pearl or certain minerals and most cleavage surface of minerals resembling that of pearl or nacre. Also called pearly.

**nacreous alabaster**; alabaster with pearly luster.

**nacreous layer**; the third layer or an iridescent nacreous layer of a pearl-bearing mollusks or shells, made of the mineral aragonite or calcite ( $\text{CaCO}_3$ ) and an organic compound conchiolin ( $\text{C}_{32}\text{H}_{48}\text{N}_9\text{O}_{11}$ ) and scleroprotein, a type of Keratin. The nacreous layer consist of microscopically very thin platelets while overlapping each other parallel to outer surface with zigzag edges. The combination of edges and film-like layers together make *orient of pearl* due to interference and diffraction effect of light. Also called mother-of-pearl, which extensively is used for making ornamental objects and small beads for inserting in mussels for production of cultured pearl industry. → Nacre, prismatic layer, nacreous, mother-of-pearl.

**nacreous luster**; same as pearly luster.

**nacroscope**; an instrument for pearl illumination, which differs from pearloscope in that the method of transmitting the light through the whole pearl is observed.

**Nadir Shah**; the Shah of Persians (reign 1736-1747, lived 1688-1747) who took from the Mogul's treasures the Peacock Throne, together with several diamonds, when Dehli was sacked in 1739 by Persian invaders. → Peacock Throne, Nadir Throne.

**Nadir Throne**; one of the most ornate, bejeweled and valuable thrones in the world. Basically it is a chair made of wood which is covered the most part with gold plate, that is removable. The gold whole has been enameled and encrusted with gems. The throne was probably made for Fath-Ali Shah of Qajar dynasty. In the center of the major pattern an emerald of 225 cts, is mounted. A set of four other large emeralds as centers of florets in a large ring with total weight of 525 cts, The throne is covered with gemstones such as rubies, emeralds, diamonds, blue sapphires and spinels in abundance. The throne was used for the coronation of

Muhammad Reza Pahlavi in 1967. Now on display at the National Jewel Treasury of Iran in the Bank Markazi (Central Bank) of Iran, Tehran, open to the public.

**NAG**; an acronym for National Association of Goldsmiths of Great Britain and Ireland.

**nagelsteen**; a Dutch term for nail-stone.

**naif**; a Dutch term for a diamond, which has a natural, unpolished surface or *skin* of a rough stone. A small part of the naif diamond is sometimes left on the girdle of a cut stone, which is called a *natural*. This is an indication that the maximum diameter of the rough stone yield has been achieved.

**naif**; a variety of diamond, which has the same lustrous appearance in its natural and unpolished condition.

**naif**; a well formed, undistorted diamond with bright faces, as distinguished from distorted ones.

**naif**; diamond crystal, which is thick or pointed, as distinguished from a flat one.

**naif**; any uncut gemstone having a natural luster. Also spelled naife, nyf, and naïve.

**naife**; same as naif.

**nailhead spar**; a composite variety of calcite having a combination of hexagonal prisms with flat rhombohedrons.

**naïve**; same as naif.

**Namakwaland**; another spelling of Namaqualand.

**Namaqualand**; location of an alluvial diamond-bearing area in south of the Orange River on the Atlantic Coast of South Africa. Also spelled Namakwaland.

**name of gems**; a descriptive using category of gems (natural, or synthetic, inorganic or organic).

**name of quartz**; believed that the name of quartz is derived from *querklufferz*, a German-Slave term meaning cross-vein or dip-joint, which often is rich in quartz or milky dense quartz and occur in metallic mining areas or ores, suggested to be a contraction name for quartz.

**name of sapphire**; → sapphire,-name of.

**Namibia**; an usual alluvial diamond-bearing country in South-West Africa. The deposits are located along the coastline of the Atlantic Ocean.

**nambulite**; a rare mineral with weak pleochroism. It is rarely fashioned but is prized by collectors.

System: triclinic.

Formula:  $\text{LiNaMn}_3(\text{Si}_2\text{O}_4\text{OH})_2$ .

Luster: vitreous.

Colors: reddish-brown, orange-brown, orange.

Streak: light yellow.

Diaphaneity: usually transparent to translucent.

Cleavage: {001} perfect, {100} distinct, and {010} distincts.

SG: 3.51.

H:6½.

Optics:  $\alpha$ :1.707,  $\beta$ :1.710,  $\gamma$ :1.730.

Birefringence: 0.023. ⊕.

Dispersion: weak.

Found in Kitakami (Japan), Tsumeb, and Namibia, Africa.

**namu**; a Tahitian term for green (stone), which is used by Maoris for New Zealand greenstone as pounamu or punamu, the term pu or pou meaning stone.

**Nandyal working**; location of an historical alluvial diamond mining area in south-east India.

**nankin porcelain**; another term for blue china.

**Nanyang-jade**; same as Dushan-jade.

**naoratna**; a ceremonial nine-jewel offering to a Hindu temple. Also spelled nararatna. → Panchratna, navratna.

**nao-ratan**; → emerald in Indian, emerald talisman in Indian.

**nanon**; same as nanometer.

**nanometer**; a unit of length is equal to one millionth of a millimeter. (1 nm=10<sup>-6</sup> mm or 10 Å, or 10<sup>-9</sup> meter). Used to quantify the wavelength of light. Also known as nanon and spelled nanometre.

**napal**; a term used in Malaya for steatite.

**Naples yellow**; a term used originally for lead antimonate pigment, now called to a mixture of zinc oxide and tinters. Used as dyes.

**Napoleon marble**; a fossil coral variety of marble from northern France.

**Napoleon Diamond**; reportedly a brilliant-cut diamond of 34 cts, possessed by Napoleon I Emperor of France, which was mounted in the hilt of his sword. Possibly apocryphal.

**Napoleon Diamond Necklace**; a diamond necklace made of 47 pieces weighing 275 cts, Was presented by the Emperor of France, Napoleon I to his wife, Marie Louise, on the occasion of the birth of their son. After her death It passed through generations of the Austria Royal House. The necklace was sold in 1948 to a French collector, and later to Harry Winston, purchased by Mrs. Merriweather Post who presented it to the Smithsonian Institution in Washington, D. C., USA.

**napoleonite**; same as corsite.

**nararatna**; same as naoratna.

**nariyas**; a term used in northwest India for gold washers.

**narrow filter**; → color filter, Chelsea color filter, filtered light.

**Narukot Mine**; location of spessartite garnet near Bombay, India.

**narwhal ivory**; a rather coarse, marbled gray and white variety of ivory from the long tusk (horn) really an incisor tooth of the arctic male narwhal whale or *unicorn* or *Monodon monoceros*. RI:1.55-1.57. SG:1.90-2.00. H:2½. It is used in Japan often to make

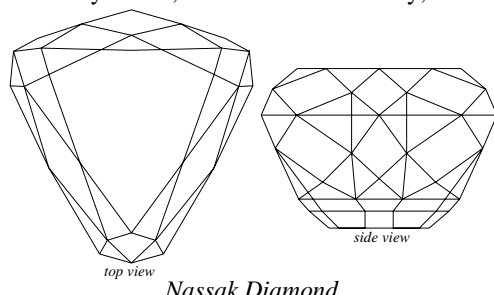
netsukes. Also called unicorn horn or the horn of the unicorn.

**Nasamones;** → Garamantic carbuncles

**Nasik Diamond;** same as Nassak Diamond.

**Nassack Diamond;** same as Nassak Diamond.

**Nassak Diamond;** a triangle or pear-shaped Indian diamond of 89.95 cts, It belonged to the conquerors of India in the 17<sup>th</sup> -18<sup>th</sup> centuries and was set as an eye in the statue of an idol of god Shiva in a Hindu temple near the city Nasik, north-west of Bombay, India. After



Nassak Diamond

the War of 1818 it was part of the Deccan Booty that fell into the hands of the East India Company. It was sold to Marquise of Westminster in London in 1837, repolished into a triangle-shaped brilliant of 80.50 cts, Purchased by Harry Winston who refashioned it into a flawless, colorless, emerald shape stone of 43.38 cts, Present owner is the King of Saudi Arabia since 1977. Frequently called The Eye of Shiva Diamond. Also spelled Nasik, Nassack, and Nassuck Diamond.

**Nassau pearl;** a term for pink conch pearls from West Indies water.

**Nasser-al-Din Shah;** a shah of Iran, reign in 13<sup>th</sup> century. → Great Globe, the.

**Nassuck Diamond;** same as Nassak Diamond.

**nasturan;** same as pitchblende.

**nasturtium leaves;** a crack-like pattern similar to nasturtium leaves of plant of the genus *Tropaeolum* that can be seen in cloudy amber, which has been clarified in heated colza oil. Also known as *sun spangled*. → Sun-spangled imitation amber

**natal stone;** another term for birthstone.

**National Association of Goldsmiths of Great Britain and Ireland;** an association of jewelers founded in 1894, which founded the Gemmological Association and Gem Testing Laboratory of Great Britain. Now they are no longer associated. Acronym: NAG.

**National Diamond Mining Company Ltd.;** a government controlled agency of Sierra Leone with the acronym DIMINCO.

**National Jewel Treasury of Iran;** a collection of jewelry and gemstones from the Royal Collection of Iran, accumulated by Shah Abbass (1587-1628), and partly by Nadir Shah in (1740) and Qajar Dynasty.

Former it was renamed as the Crown Jewels of Iran and exhibited in the Bank Markazi (Central Bank) of Iran, Tehran, open to the public. Also called Iranian Treasury. → Iranian Diamonds, Iran Crown Jewels.

**National Mineral Development Corporation of India;** a state controlled agency for exploration and development of mineral resources in India with the acronym NMDC.

**native;** same as endemic or indigenous.

**native;** occurring in nature free, such as native gold, etc.

**native calomel;** same as free calomel.

**native copper;** same as free copper. Also called pure copper.

**native silver;** same as free silver.

**native sulfur;** same as free sulfur. Also called virginsulfur.

**native cut;** gemstones that has been fashioned by native in-experienced cutter, which often results it an unsymmetrical shape and not uniform facets, the principal reason is to recover as much weight as possible and to improve color rather than brilliance. Also called native cut gems.

**native cut;** a term used for any in-experienced style cut gemstone, that mean it has no really style. Also known as poorly cut.

**native cut gems;** same as native cut.

**native element;** naturally uncombined occurring metal such as nugget native gold, native copper, etc.

**native gold;** a heavy, soft, yellow, ductile, precious metallic element, which occurs naturally as a nugget. Rarely pure, usually alloyed with silver and frequently containing little amounts of copper, bismuth or palladium. → Gold.

**native magnesia;** same as periclase.

**native Prussian blue;** same as vivianite.

**native silver;** white to tarnish gray-black, malleable, ductile, precious metallic element, which occurs naturally as massive or arborescent or filiform shapes. → Silver.

**natrium;** synonym for sodium.

**natroborocalcite;** same as ulexite.

**natrolite;** a mineral of the zeolite group. Cut cabochon or faceted gems. Two minerals *mesolite*  $8[\text{Ca}_2\text{Al}_2(\text{Al}_2\text{Si}_3\text{O}_{10})_3 \cdot 3\text{H}_2\text{O}]$ , and *scolecite*  $8[\text{Ca}(\text{Al}_2\text{Si}_3\text{O}_{10}) \cdot 3\text{H}_2\text{O}]$  having nearly same properties. Also called natural zeolite.

System: orthorhombic. Rarely occurs as tetragonalic.

Formula:  $8[\text{Na}_2(\text{Al}_2\text{Si}_3\text{O}_{10}) \cdot 2\text{H}_2\text{O}]$ .

Luster: silky to pearly to vitreous.

Colors: colorless, whitish-gray, pale yellowish to reddish, brownish-yellow.

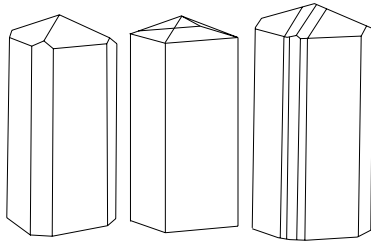
Streak: white.

Diaphaneity: transparent to translucent.

Cleavage: {110} perfect.

Fracture: conchoidal to uneven. Brittle.

SG: 2.20-2.26.



natrolite crystals

H:5-5½.

Optics:  $\alpha$ :1.480,  $\beta$ :1.482,  $\gamma$ :1.493.

Birefringence: 0.013. ⊕.

Dispersion: 0.013.

Found in India, Canada, Columbia, Greenland, Brazil, Scotland, Norway, Germany, Russia, France, Austria, Colorado, California, and New Jersey (USA).

**natrolite cut;** frequently cut cabochon and transparent specimen as emerald cut, step cut, and elongated gems.

**natrolite luminescence;** yellow-orange luminescence under LWUV.

**natromontebrazite;** a mineral of amblygonite group, when Na exceeds Li. → Amblygonite.

**nattled jet;** a term used by Whitby jet workers for a kind of soft jet with cracks while the cracks are called nattles.

**nattles;** a term used by Whitby jet worker for cracks. Also called nattles jet.

**natural;** a mineral or substance, which occurs in nature; opposite of synthetic or man-made. → Indented natural. → Natural on diamond.

**natural;** a term applied to lightening color center seen in sapphire from Sri Lanka. → Sapphire color centers.

**natural alumina;** two general varieties, corundum and emery used as abrasive material.

**natural diamond;** a term for a diamond formed by nature which distinguishes from synthetic.

**natural diamond;** abrasive varieties of crushed natural diamond that are called natural grit, or bort.

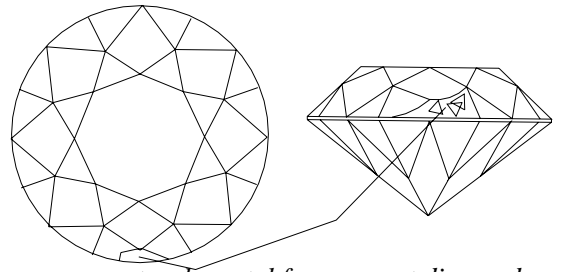
**natural glass;** a consolidated, vitreous, noncrystalline inorganic silica composition occurring in nature, which has solidified from magma to quickly such as obsidian, moldavite, Libyan glass, pit glass, fused glass, basalt glass, crater glass, silica glass and tektite. Obsidian contain nearly 77% silica and 10-12% alumina. Used for ornamental objects and frequently cut as faceted gems.

**natural grit;** crushed poor quality natural diamond to abrasive powder, as distinguished from synthetic grit. → Natural diamond.

**natural iron-creat in sapphire;** natural iron-creat stabilize sapphire color from Thailand, Tanzania and Australia. → Sapphire color centers.

**natural jointed;** a term used by Australian miners for nobbies occurring in section of naturally broken pieces.

**natural on diamond;** an extra small unworked facet or a portion of the natural surface or skin of a rough diamond left often beneath the girdle or frequently



natural crystal faces on cut diamond, mostly occur beneath the girdle

other places of a fashioned diamond by the cutter to indicate that maximum has been retained or to save weight. Another term for naif. Sometimes called a bewijs by cutters. Also called natural on diamond.

**natural pearl;** a pearl, which is formed naturally within a mollusk, as distinguished from a cultured pearl or imitation pearl. Also called *true pearl* or *wild pearl*.

**natural point;** elongated diamond crystal. → Point naif.

**natural red,-C.I.;** → madder.

**natural resin;** a resin from natural sources, as distinguished from synthetic resin.

**natural stable color center;** natural color center seen in sapphire from Sri Lanka. → Sapphire color centers.

**natural stone;** any gemstone, which is found in nature, as distinguished from a man-made substitute, that means an imitation or a synthetic stone.

**natural strain;** same as strain.

**natural violet spinel;** a misleading term for almandine spinel.

**natural zeolite;** same as natrolite.

**nature of polished surface;** → Beilby layer.

**nature's neon signs;** → Aurora Borealis.

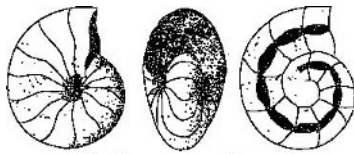
**naujaite;** a reddish to gray, coarse-grained, plutonic igneous rock of the syenite group rich in sodalite, and eudialyte, and also containing microcline, albite, aegirine, and amphiboles. Sometimes cut and polished. Found in Naujakasik, Greenland.

**nautilus pearl;** → nautilus shell.

**Nautilus pompilius;** a kind of pearl-bearing oyster fished of Philippines and Malaysian Archipelago waters, the pearls are frequently yellow.

**Nautilus shell;** a cephalopod mollusk having a multi-chambered shell (*Nautilus pompilius*), which resembles a

snail shell, when it is grown by additional secretions forming a number of chambers. The outer pearly,



*nautilod-apertural-section*

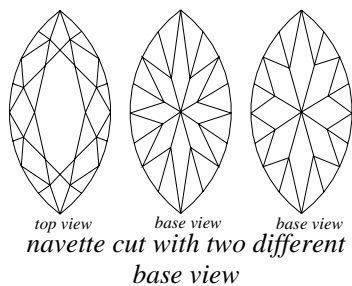
frequently yellow shell is used for ornaments, carving oval or convex of great delicacy and small objects, and for industry of blister-like *coque de perles*. The inner part of nautilus shell is divided up into chambers which are known as *inner septa* and used for inlay work. Found in Indian Ocean, and South Pacific Ocean. Also called pearly nautilus, chambered nautilus.

**nava-ratna;** → emerald in Indian, emerald talisman in Indian, urim and thummim.

**Navsari;** an important Indian diamond center north of Bombay.

**navet;** → navette.

**navette;** a term used for marquise-cut diamond or other



*top view base view base view  
navette cut with two different  
base view*

gemstones with boat-shaped outline. Also spelled navet or navette cut. Also called boat shape.

**navette cut;** same as navette.

**navratna;** an Indian term for a decoration jewel with nine different varieties of precious stones. Used as necklace, bracelet, pendant, and armllet. → Naoratna.

**Nawab of Dacca;** an Indian diamond of 150 cts, belonging to the Nawab of Dacca (till 1955), reported to be of square cut. Also called Darya-i-Nûr, but has no connection with the true Darya-i-Nûr (Iran). → Dacca, Nawab of.

**Nawab Emerald;** a cushion-shaped clasp (buckle), emerald of fine quality and color used as state sword, set with diamonds. Once belonged to the Nawab of Dacca.

**Nawanagar Diamond;** a brilliant-cut diamond of 148 cts, probably from Russia. Purchased by Maharani Gulabkumberba of Nawanagar, India.

**naxium;** probably emery from Naxos, Greek, which in ancient times was used as a polishing material.

**naya;** an Indian term for emerald.

**Nb;** a chemical symbol for the element niobium.

**NBC;** an acronym for National Bureau of Standard in

USA.

**Nd;** a chemical symbol for the element neodymium.

**Nd-YAG;** YAG contain neodymium used in laser. Also spelled neodymium-YAG laser. → YAG laser.

**Nd-YAG laser;** a neodymium doped YAG used in LASER. Also spelled neodymium-YAG laser. → yttrium aluminum garnet.

**Ne;** a chemical symbol for the element neon.

**near colorless;** a commercial term for diamond stone, which appears colorless in face-up position, but actually the stone is very light yellow.

**near gem;** a Dutch term used for quality of rough diamond, which describes color and clarity of gem and industry diamond, according to market condition, which then determines the best price. Also called near gem crystal.

**near gem crystal;** same as near gem.

**neck chain;** a flexible, long jewelry light chain made of precious metal consisting of several loops worn around the neck extending down upon the breast, frequently with a pendant. To differ from necklace.

**necking down;** a term used for a process of locally reducing the cross-section of inclusions in a crystal due to healing of the cracks.

**necklace;** a piece of jewelry consisting of a string of gemstones, jewels, beads, or oblates, or other materials, or a band or chain mounted with stones or pearls, or other multi-colored materials, for wearing around the neck. Usually a pendant of single gemstone, cluster, pearl, or cross is suspended. → Necklet, choker, collier de chien, neck chain.

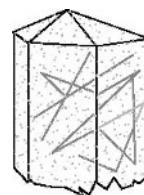
**necklet;** a short string, chain, or band of ca. 45 cm worn around the neck for ornamentation.

**necklet;** same as necklace.

**necrolite;** same as necronite.

**necronite;** a blue variety of orthoclase feldspar with pearly luster which emits a fetid smell upon hammering. Also called necrolite. Prized by collectors.

**needle;** a thin needle-shaped or acicular crystal, which is an inclusions in certain minerals, such as rutiled



*needles  
of rutile  
in quartz*

quartz, sapphire, or corundum. Sometimes actinolite, goethite, etc. appear in certain crystals. For example ruby from Sri Lanka, Myanmar with silky

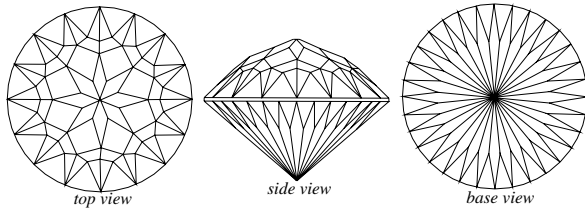
appearance. Also called rutile needle, acicular, aciculate, needle-like.

**needle;** a slender ornament made of gold or silver worn as peasant jewelry.

**needle;** a slender needle-shaped snow crystal.

**needle brilliant-cut;** a modified round brilliant-cut with

64 facets in the crown and three different stars from



needle brilliant-cut with 128 facets

center outwards. The pavilion having 64 facets in form of very thin needles spreading from center to the girdle of the stone without culet.

**needle diorite;** a term applied to a diorite with needle-shaped hornblende.

**needle iron ore;** same as needle ironstone.

**needle ironstone;** an acicular variety of goethite occurring also as an inclusion in certain gemstones. Also called needle iron ore, needle ore.

**needlelike (silk);** acicular or needle form of inclusions in gemstones.

**needle ore;** same as needle ironstone.

**needle ore;** a synonym for aikinite.

**needle ore;** a slender iron ore with very high metallic luster.

**needles;** same as needle test.

needle-shaped; same as acicular.

**needle spar;** an ancient and obsolete term for aragonite.

**needle stalagmite;** needle-like variety of stalagmite.

**needle stone;** quartz crystal with needle-like inclusion of rutile, actinolite, etc. Also known as sagenitic quartz, rutilated quartz, venus hair, thetis hair stone, hairstone.

**needle stone;** needle-like variety of zeolite. Also spelled needlestone.

**needlestone;** another spelling for needle stone.

**needle zeolite;** a group of needle-like zeolite such as natrolite, mesolite and scolecite. Also called needle stone, mesotype.

**needle zeolite;** partial a synonym for natrolite.

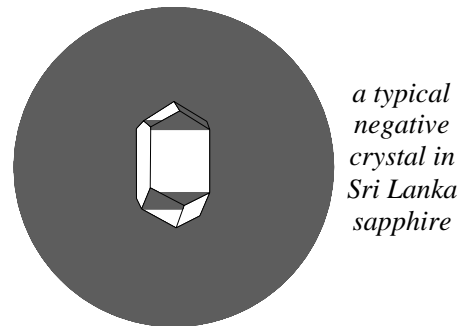
**needle test;** testing of the purity of gold with a test stone, acid and gold pointed metal of various karats, which are known as *needles*

**nefretita;** Spanish spelling for nephrite.

**negative crystal;** an angular cavity within a crystal, mineral or fashioned gemstone having the crystal form of the mineral, in which it occurs. Also called negative mineral or negative stone, primary type inclusions.

**negative crystal;** in crystal optics a birefringent mineral of uniaxial crystal is negative, when the refractive index of the extraordinary ray  $\epsilon$  is less than the

refractive index of ordinary ray  $\omega$ . In biaxial, when



intermediate refractive index  $\beta$  is near to  $\chi$  than  $\alpha$ . Abbreviation:  $\ominus$ . Also called negative mineral or negative stone.

**negative eyepiece;** same as eyepiece Huygenian.

**negative glow;** appearance of negative glow in a gas-discharge tube between Faraday dark space and the cathode. An illustration under gas-discharge tube. → Positive column, Faraday dark space.

**negative magnetic;** same as diamagnetic.

**negative mineral;** birefringent mineral, in which the refractive index of ordinary ray is greater than the refractive index of extraordinary ray. Also known as negative stone or negative crystal. → Optical negative, negative crystal.

**negative, optic;** → optical negative, negative crystal.

**negative reading;** testing a gemstone on a refractometer prism, when the stone has a greater refractive index than the measuring prism of the device, or higher than the refractive index of immersion liquid used for optical contact, the scale of refractometer remains dark and the only shadow edge that can be seen is that of immersion liquid, such stones or diamonds give a *negative* reading. Also called negative refractometer reading. → Shadow-edge in refractometer.

**negative refractometer reading;** same as negative reading.

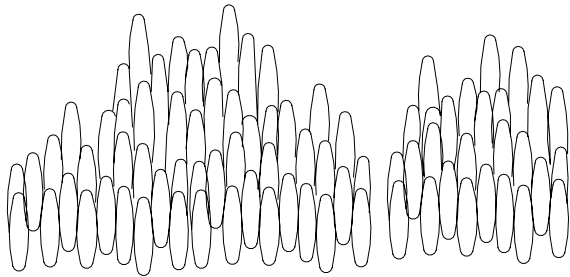
**negative temperature;** a nonequilibrium condition wherein the resistance, volumen, length or some other characteristic of material decrease when temperature increases, used for an inverted population in a laser or maser. In this state, there are more particles with higher energies than those having lower energies.

**nekronite;** same as orthoclase.

**nemaline;** same as nemalite.

**nematic liquid crystal;** having high degree of worm-like, long molecules and all nearly parallel, straight in same direction but otherwise randomly arranged, but no long-range transitional order. Generally optically uniaxial, positive and strongly birefringent. It belonged to the thermotropic liquid crystalline compounds. Also called threadlike liquid crystal. → Liquid crystal.





condition of ordered liquid molecules in  
nematic phase. After Bohm

**nemalite**; in mineralogy, thread-like or fibrous structure.

**nemalite**; a fibrous variety of brucite, which contain iron oxide. Also spelled nemaline.

**Neocene**; same as Neogene.

**neodigenite**; same as digenite.

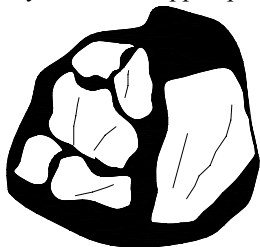
**neodymium**; a soft, malleable, silvery-white to yellowish metallic element of rare earth group of the Periodic System, which tarnish quickly in air. The symbol is Nd. It occurs in nature with praseodymium and shares the collective name didymium. Used as color agents to produce lilac and amber-colored varieties of glasses, lens, laser, and cubic zirconium oxide.

**neodymium-YAG laser**; same as Nd-YAG laser.

**Neogene**; a name given to an interval of time of the Miocene and Pliocene of the Tertiary Period. Also called Neocene.

**neogenic**; a newly formed mineral.

**neolite**; a commercial term for turquoise imitation made of mixture of bayerite and copper phosphate with an



neolite or Rese turquoise

amorphous iron compound to give the product matrix appearance.

**neolite**; a silky fibrous serpentine from Arendal, Norway.

**neolith**; a German commercial term for turquoise imitation neolite.

**Neolithic**; last part of Stone Age, characterized by the use of polished stone implements, the art of grinding bone, horn, ivory tools, and stones, and manufacture of pottery. Also called Neolithic Age.

**Neolithic Age**; same as Neolithic.

**neon laser**; same as neon ion laser. → Laser.

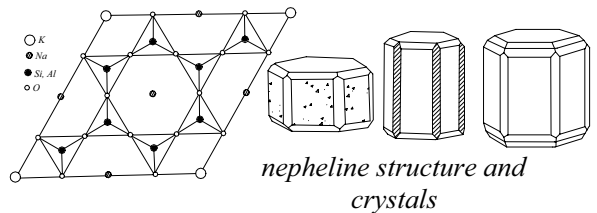
**neo-turquoise**; a commercial term for turquoise

imitation.

**Nepal Diamond**; a white pear-shaped Indian diamond of 79.50 cts, it was owned by Badahur Rana of Nepal ruler until the 1950. Purchased by Winston in 1957, who repolished the stone to 79.41 cts, Since 1961 it has been owned by an unknown European.

**Nepal Pink Diamond**; reportedly a light rose-pink color diamond of 72 cts, from India. Present owner unknown.

**nepheline**; a rock forming mineral of tectosilicates or feldspathoids clan. Sometimes it contain inclusions, when cut cabochon in various sizes shows cat's-eye or girasol effects. Faceted stones are rare, frequently cut



nepheline structure and  
crystals

cabochon and used in art and prized by collectors. Elaeolite is a variety. Also spelled nephelite. Sometimes called pseudosommitte.

System: hexagonalic.

Formula:  $8[(\text{Na},\text{K})\text{AlSiO}_4]$ . Theoretically  $2[\text{K},\text{Na}_3(\text{AlSiO}_4)_4]$ .

Luster: vitreous to greasy.

Colors: colorless, white, pale yellowish to yellow, green, greenish to green, red, reddish-brown

Streak: white.

Diaphaneity: transparent to translucent.

Cleavage:  $\{0001\}$  indistinct, and  $\{1010\}$  indistinct

Fracture: subconchoidal to uneven. Brittle.

SG: 2.56-2.66.

H:  $5\frac{1}{2}$ -6.

Optics;  $\omega$ : 1.529-1.546,  $\epsilon$ : 1.526-1.542.

Birefringence: 0.005.  $\ominus$ .

Dispersion: low.

Found in Ontario (Canada), Norway, Greenland, Myanmar, Russia, Korea, Finland, Italy, and Arkansas (USA).

**nepheline cut**; → nepheline.

**nepheline, luminescence**; light blue luminescence to dull orange under LWUV.

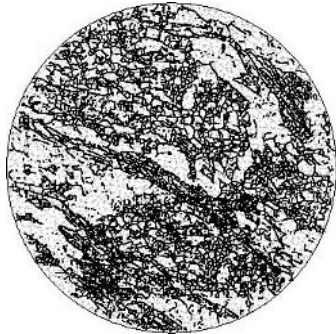
**nepheline syenite**; same as eleolite syenite. Also called midalkalite. → Kakortokite.

**nephelite**; same as nepheline.

**nephelinite**; a fine-grained or porphyric extrusive igneous rock primary composed of nepheline and pyroxene and lacking feldspar.

**nephrita**; Spanish spelling for nephrite.

**nephrite**; a tough, massive, fibrous variety of actinolite or tremolite of amphibole group, which is the least less valuable and more abundant of the two kinds of jade. Long slender or blade-like aggregate, can be columnar,



thin section  
of nephrite

radiating, or fibrous. Nephrite from Taiwan displays cat's-eye effects. Strong dichroism. A yellowish-green to creamy buff, translucent variety of nephrite-jade with greasy luster resembling mutton fat therefore is called *mutton fat jade*. *Buried jade* is a misnomer for yellowish or grayish-brown variety of nephrite, which is of archaeological interest, because it was buried through the ages and found in yellow losses in China. Buried jade is produced artificially by heat treatment of usual nephrite. Varieties are *greenstone* and *Spanish jade*. Carved for jewelry and art. Also called *kidney stone*, *punamunstone* or *punamu*. In Spanish is called *pedra de hijada* or *pedra de los riñones*. → Mutton fat jade, bowenite, New Zealand greenstone.

System: monoclinic.

Formula:  $2[\text{Ca}_2(\text{Mg}, \text{Fe})_3(\text{Si}_4\text{O}_{11})_2(\text{O}, \text{OH})]$ .

Luster: vitreous to greasy, dull.

Colors: whitish-cream, when containing magnesium is on intense green (Spanish jade), dark-green (greenstone), yellowish, red-brown, brown (rich in iron), grayish-green, gray, and black.

Streak: colorless to gray.

Diaphaneity: translucent.

Cleavage: {110} perfect.

Fracture: splintery. Tough.

SG: 2.90-3.02.

H: 5½-6. Less hard than jadeite.

Optics:  $\alpha$ : 1.600-1.627,  $\beta$ : 1.630,  $\gamma$ : 1.614-1.641.

Birefringence: 0.027. ⊖.

Found in New Zealand, Russia, Canada, Colombia, China, Taiwan, Poland, Zimbabwe, Australia, Wyoming, and California, USA.

**nephrite absorption spectrum**; a double line at 689 nm, a sharp line at 509 nm, two weak bands at 498, and 460 nm.

**nephrite colors name in Chinese**; *cha* for opaque white, *pi* for indigo blue, *sen* for clear transparent white, *pih* for moss green, *chiung* for cinnabar red, *kau*

for yellow, *haieh* for black, and *men* for blood red. → Chinese ritual and symbol jades.

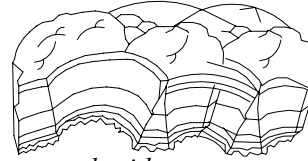
**nephrite cut**; used for carving of art objects such as snuff bottle, cameo, intaglio and made into beads or cut cabochon. Those with brown skin are carved for their two-color effects.

**nephrite, pleochroism**; strong dichroitic.

**nephrite**; a mineral, in which radiation aggregates terminate in a rounded mass with smooth, hummocky rounded surface. Also called kidney-like, kidney shaped. → Mammillary.

**nephritoid**; a rarely used term for jade.

**nephroid**; a mineral, in which radiation aggregates



nephroid aggregate.

After Sinkankas 1964

terminate in a rounded mass with smooth, hummocky rounded surface. Also called kidney-like, kidney shaped. → Mammillary.

**Neptune**; → Poseidon.

**neptunite**; some stones have been faceted it is prized by collectors.

System: monoclinic.

Formula:  $4[\text{KNa}_2\text{Li}(\text{Fe}^{+2}, \text{Mn}^{+2})\text{Ti}_2\text{O}(\text{Si}_4\text{O}_{11})_2]$ .

Luster: vitreous.

Colors: deep red to black.

Streak: brown.

Diaphaneity: transparent to opaque.

Cleavage: {110} perfect.

Fracture: conchoidal to uneven. Brittle.

SG: 3.19-3.23.

H: 5½-6.

Optics;  $\alpha$ : 1.690-1.691,  $\beta$ : 1.693-1.700,  $\gamma$ : 1.719-1.736.

Birefringence: 0.029-0.045. ⊕.

Found in Greenland, Canada, Russia, Ireland, and California (USA).

**neptunite, pleochroism**; it shows dark-red to yellow pleochroism.

**Nerchinsk aquamarine**; a misleading term for aquamarine-colored topaz from Nerchinsk, Siberia, the Russian Federation, CIS.

**Nerchinsk beryl**; beryl from Nerchinsk, Siberia, the Russian Federation, CIS.

**Nerchinsk rubellite**; a pink variety of tourmaline or rubellite from Nerchinsk, Siberia, Russia.

**Neronian**; a term means resembling Nero Roman Emperor in appearance, used for particular cruel green color emerald or beryl, allegedly due to immersed in an oil to darkened the color.

**Neronian emerald**; allegedly an ancient method to improve the color of emerald by dyeing.

**Nero's aquamarine eyeglass;** → aquamarine eyeglass, Nero's.

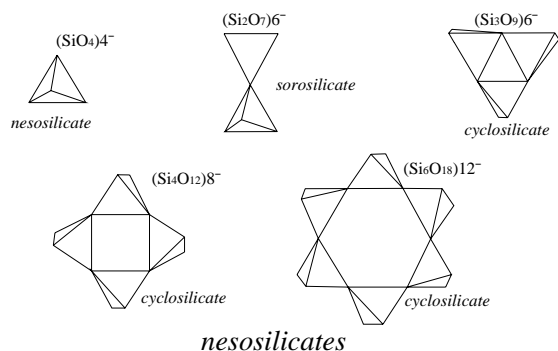
**Nero's beryl eyeglass;** → aquamarine eyeglass, Nero's.

**Nero's emerald eyeglass;** → aquamarine eyeglass, Nero's.

**nerve-cell aggregations;** → nervous system of oyster.

**nervous system of oyster;** the nervous system of oyster is very simple, consisting of three ganglia or a mass of nerve fibers containing nerve cells which is called *nerve-cell aggregations*.

**nesosilicates;** any silicate structure, in which the individual  $\text{SiO}_4$ -tetrahedral groups are not linked together but by means of metal cations only, rather than

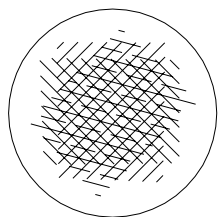


by sharing of oxygens. For example olivine  $(\text{Mg,Fe})_2\text{SiO}_4$ . Synonym for orthosilicate. Also called isolated silicates. → Sorosilicate, cyclosilicate, inosilicate, phyllosilicate, tectosilicate.

**nest;** a term used by Australian miners for a collection of stones in one kind as a pocket. Also called kernel boulders.

**nests;** same as pocket.

**net;** a term used for system of network inclusion of rutile or hematite needle in star ruby or star sapphire, which caused by innumerable exsolved submicroscopic



*net formation of rutile needles at 60°  
in ruby or sapphire*

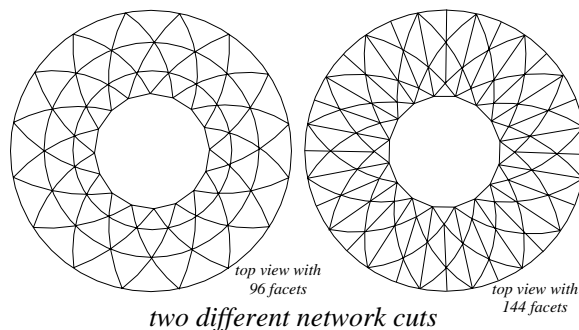
parallel oriented rutile needle or hematite plates, which are known as *silk*.

**netsuke;** a Japanese term for small carved button-like ornament or toggle, which is worn by Japanese at the end of a cord hanging from a girdle, while the kimono had no pocket. The objects are pipe, snuff bottle, purse, tobacco pouch, and inro. It is made of a wide variety of

materials, such as ivory, jade, emerald, amber, bone, coral, wood, enameled metal, shell, horn, tortoise shell, glass, and porcelain. Carved figures are human, birds, animals, and religious subjects. → Inro.

**netsuke emerald;** a small carved emerald or aquamarine as button-like ornament or toggle, which is worn by Japanese at the end of a cord hanging from a girdle, while the kimono had no pocket.

**network cut;** a modified round brilliant-cut with 96 or 144 facets in the crown with 16-rayed star and a large



16-sided table.

**network structures;** in mineralogy same as tectosilicates.

**neutron;** an uncharged subatomic particle with a mass of 1.00894 atomic mass unit that is nearly equal to that of the proton, that is a constituent of the atomic nucleus except that of normal hydrogen. The isolated neutron is caused by a fusion reaction, is unstable and decays with a half-life of about 12 minutes into an electron, a proton, and a neutrino. Wavelength of a neutron depend on its velocity, for sample a neutron with a velocity of about  $4 \times 10^3 \text{ m s}^{-1}$  having a wavelength of about  $10^{-10} \text{ m}$ .

**neutron activation analysis;** a process used to test tourmaline, corundum, etc., because of its chemical composition that is similar to most mineralogical pieces, which have a large number of elements such as Al, Mn, Mg, Li, Na, Fe and B when this element are greater than 0.1 weight percent. It separate neutron from synthetic corundum and also discriminate between gem from different deposits. Acronym: NAA, or INAA for Instrumental neutron activation analysis.

**neutron bending;** same as neutron diffraction.

**neutron bombardment;** same as neutron treated diamonds.

**neutron diffraction;** registration of scattering of beam of neutron of very short-wavelength sent through a thin layer of crystal lattice, so that the waves shows up on an interference pattern as a light and dark bands. Neutron diffraction and electron diffraction can used instead of X-rays diffraction. Also called neutron bending.

**neutron diffraction analysis;** a process used for refined structural parameter of crystals similar to X-rays in mineralogy but in three-dimensional single-crystal.

**neutroneo diamonds;** same as neutron treated diamonds.

**neutron treated diamonds;** diamonds can also have their color altered by pile-treated, in which the neutrons are uncharged particles in a cyclotron. → Diamond neutroneo, treated diamond, pile-treated diamond, cyclotroneo diamonds.

**Nevada black diamond;** a misleading term for obsidian from Nevada, USA.

**Nevada diamond;** a misleading term for obsidian from Nevada, USA. Also called Nevada black diamond and Nevada topaz.

**Nevada topaz;** a misleading term for obsidian from Nevada, USA.

**Nevada turquoise;** turquoise from Nevada.

**Nevada turquoise;** a misleading term for variscite from Nevada, USA.

**Nevada wonderstone;** a volcanic rock alternate of red and beige bands frequented with gray patches from Nevada, USA. SG:2.53. Used for ornamental objects and tumbling process. Not to be confused with South African wonderstone.

**New Almasi, Ltd.;** a diamond mining corporation in Tanzania, Africa.

**new diamond;** a virgin diamond. Also called new stone, virgin stone.

**New Eland Mine;** location of a minute diamond-bearing pipe near Bishop, Orange Free State, South Africa.

**new emerald;** a term used for emerald green gemstones, which known as occidental emeralds, because they are originated in Colombia and called esmeraldas nuevas. Also called occidental emerald. Esmeraldas nuevas is an old term for new emerald. → Esmeraldas viejas.

**Newfoundland;** labradorite feldspar from Newfoundland, Canada.

**new Granada emerald;** a Colombian local term for emerald.

**New Guinea cat's-eye;** a misleading term for shell cat's-eye.

**New Guinea jade;** a dark-green veined with pale green colored chrome-rich jadeite (one of the two kinds of jade) from New Guinea, which is intergrown with quartz, picotite, limonite, and opal. SG:3.35. Also known as *astridite*.

**New Guinea shell;** pearl-oyster of *Pinctada maxima* is mainly used commercially as mother-of-pearl. Also called New Guinea shell. → Macassar shell.

**New Hampshire;** a gemstones bearing state in USA,

such as brazilianite, topaz, quartz, etc.

**New Israel Club for Commerce in Diamonds, Ltd.;** an Israeli diamond bourse, member of the World Federation of Diamond Bourses. There are another two diamond bourses in Israel.

**new jade;** a misleading commercial term for pale yellowish-green variety of bowenite serpentine.

**new jade;** a term used inaccurately for antigorite. Also called Korean jade.

**new jade;** a mislabeled term for antigorite.

**New Mine sapphire;** a commercial term for sapphire from Bo Ploi, Thailand.

**New Mine sapphire;** it was also for a short time called Montana sapphire. → Montana sapphire.

**new rock;** same as new rock turquoise.

**new rock;** a term used in Iran for turquoise stones by which the color and luster change soon. → Turquoise classification in Nishabur, Iran.

**new rock turquoise;** a term for odontolite used in Europe.

**new rock turquoise;** an old Persian name for turquoise matrix, which includes inferior turquoise.

**New Rush;** → Kimberley Mine.

**New South Wales;** principal alluvial diamond-bearing state in Eastern Australia.

**New Star of the South Diamond;** same as Nova Estrêla do Sul Diamond.

**new stone;** same as new diamond.

**New Thor Mine;** location of diamond pipe in the Winburg area, Orange Free State, South Africa.

**Newton's interference of colors and retardation;** Newton's colors are grouped into five grades beginning with a retardation of 560 nm and ending with a reddish color up to 2800 nm, which can be seen in table below:

**Newton's rings;** a term used in optics for circular concentric interference of colors that may seen surrounded the point of contact of a slightly convex lens and a flat reflecting glass surface.

**Newtonian spectrum;** same as continuous spectrum. → Dispersion, color dispersion.

**New York;** location of the American diamond industry.

**New Zealand copal;** a light-colored, whitish yellow to brown copal found as a fossil resin from the kauri pine *Dammara australis* or *Agathis australis* from New Zealand, Australia and other sources. Smells like turpentine. Used as inferior imitations of amber and varnishes. It can be distinguished by its fusibility. Also called kauri copal, kauri resin, kauri (Maori), agathocopalite, copal, copal resin. Large and clear pieces are prized by *gum diggers*, they polished such pieces or carved into ornaments by using the natural surfaces. Transparent and clear pieces used as pipes, cigar and cigarette holders.

table 13: Newton's interference of colors and retardation in nm

retardation	Color	retardation	color
0	black		
50	iron gray	1150	blue
100	gray	1250	blue green
160	gray blue	1350	green
260	white	1400	yellow green
330	yellow	1450	yellow
440	yellow brown	1500	rose red
500	orange red	1550	carmine
540	red	1650	violet gray
560	<b>I grade</b>	1680	<b>III grade</b>
580	violet	1700	blue gray
690	blue	1750	blue green
720	blue green	1800	green brown
750	green	1900	pale green
840	yellow green	2000	pale gray
920	yellow	2200	pale red violet
1000	orange red	2240	<b>IV grade</b>
1050	violet red	2500	green
1100	violet	2700	pink
1120	<b>II grade</b>	2800	<b>V grade</b>

**New Zealand greenstone;** an alternative name for creamy mutton-fat nephritic-jade variety from New Zealand. Also called Maori jade, Maori stone, axestone and by Maoris native *punamunstone*, *punamu* or *pounamu*.

**New Zealand greenstone;** a misleading term for serpentine from New Zealand.

**New Zealand jade;** a nephritic jade variety from New Zealand.

**N'Gounie;** location of an alluvial diamond mine in Gabon, West Africa.

**Ni;** a chemical symbol for the element nickel.

**Niagara spar;** a local term in Niagara for fibrous gypsum imported through Canada from British Isles.

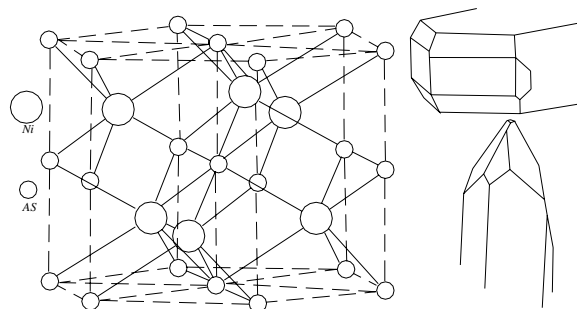
**Niagara spar;** a local term for fibrous calcite found near Niagara Falls, USA.

**Niarchos Diamond;** a white, flawless rough diamond of 426.50 cts, found in 1945 in the Premier Mine, Transvaal Province, South Africa. Purchased by Harry Winston in 1956, who cut it into three stones: a 128.25 cts, pear-shaped brilliant, an emerald cut of 40.00 ct, and the third a marquise cut of 27.62 cts. All three was bought in 1957 by Stavros S. Niarchos, the Greek ship owner, after whom it was named. Also called the Ice Queen Diamond, and Pretoria Diamond.

**nibbling;** in diamond industry to bite in minute bits. Also spelled nicolite.

**Niccolo;** same as nicolo

**niccolite;** it is rarely cut cabochon but is prized by



*niccolite structure and crystals*

collectors. Also called nickeline and spelled nicolite.

System: hexagonalic.

Formula:  $2[\text{NiAs}]$ .

Luster: strong metallic.

Colors: pale copper-red, often tarnished gray to black.

Streak: brownish-black.

Diaphaneity: opaque.

Cleavage:  $\{0001\}$ , and  $\{1011\}$  indistinct.

Fracture: conchoidal to uneven. Brittle.

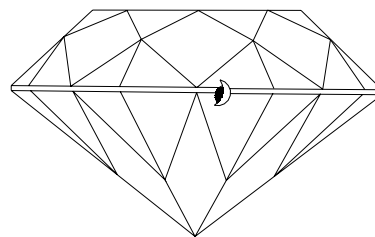
SG: 7.50-7.80.

H: 5-5½.

Found in Japan, Mexico, France, Austria, the Czech Republic, Russia, and Canada.

**Nicholas synthetic alexandrite;** synthetic alexandrite made by Czochralski grown method by J. O. Crystals, which contain chromium oxide to enhance the color, it has uncountable negative crystals. Cut cabochon from the core of synthetic stone.

**nick;** a small chip on a facet or along the facet junctions of a



*wedge-shaped nicks on diamond*

fashioned diamond. Not to be confused with kerf.

**nick;** a term applied to a sharp angle cut by waves.

**nickel;** a silver-white, hard, malleable, ductile metallic element of the Periodic System with the symbol Ni, responsible for apple green color in minerals. Extremely resistive to corrosion.

**nickel coloration;** nickel is responsible for color in some gemstones such as green in chrysoprase, green opal from Silesia, Poland, and Kenya, Africa synthetic green or yellow in sapphire, or green dyed chalcedony to present chrysoprase.

**nickel emerald**; a misleading term for zaratite.

**nickel in synthetic diamond**; nickel in diamond causes a cloud-like appearance, which is in the form of round or plate-like inclusions.

**nicke-iron mass**; same as barysphere.

**nickel pyrite**; same as millerite.

**nickel silver**; same as German silver.

**nickeline**; same as niccolite.

**nicolite**; another spelling for niccolite.

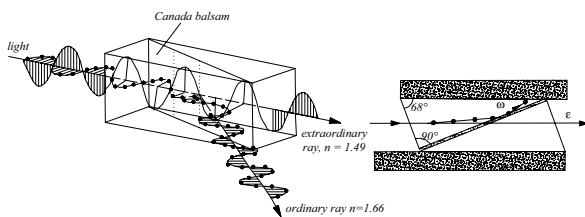
**nicolite**; same as nibbling.

**nicol**; same as Nicol prism.

**nicol**; any device that is used to produce polarized light, such as Nicol prism or polaroid.

**Nicol crossed**; same as crossed Nicol.

**Nicol prism**; in a polarizing microscope a device for obtaining plane polarized light. It consists of two sections of optically pure Iceland spar calcite



left: Nicol prism and vibration of ordinary and extraordinary rays. Right absorption of ordinary ray from black walls

rhombohedron, which are recemented together with Canada balsam in such a way that the ordinary ray is totally internally reflected out the side of the crystal, because the refractive index of the balsam sheet is 1.53., while the extraordinary plane-polarized ray passes through the prism (refractive index 1.49). In a petrological microscope two Nicol prisms are provided, the first, the polarizer, mounted below the stage, and the second, the analyzer, set in the tube above the objective. Polaroid is an inexpensive substitute for Nicol prism, which operate on the same principal. Also called Nicols.

**Nicols**; same as Nicol prism.

**nicolo**; a variety of black or dark brown onyx (agate) with a thin bluish-white sheet of faint-bluish top layer.

**nicolo**; a term applied to a cameo or intaglio pieces that has been carved in such a stone. Also spelled niccolo or onicolo.

**nicopyrite**; same as pentlandite.

**Nier-gem**; a commercial term for synthetic yttrium aluminum garnet or YAG.

**nifty gem**; an assembled stone consisting of strontium titanate as a pavilion covered by a layer of synthetic sapphire crown made in Naftule of Geneva,

Switzerland.

**nigerite**; a light- to dark brown complex mineral of zinc, iron, magnesium, tin, and aluminum oxide. Hexagonal system. Vitreous luster. Optics;  $\omega$ :1.80,  $\epsilon$ :1.81.  $\oplus$ . SG:4.51. H:8½. Occurs as an associated mineral with taaffeite. Found in China and Nigeria.

**niggerhead**; a local term for a pink, yellow, green, or parti-colored variety of tourmaline, which is black at the top of the crystal. Found in Elba, Italy. → Moor's head.

**nigger head**; a term used by Australian miners for spherical masses of fine-grained silica formed round a center of opalized wood often containing some opal of good color in cracks.

**niggerhead clam**; → niggerhead mussel.

**niggerhead mussel**; an important species of fresh-water bivalve pearl mussel *Quadrula ebena* found in the Mississippi Valley, and other rivers of USA. Are fished for pearl and their shell, which is used for the manufacture of mother-of-pearl, and buttons. Popularly called *niggerhead clam*. → Blue-point mussel.

**niggerhead pearl**; → niggerhead mussel.

**night emerald**; a misleading term for olivine peridot. → Evening emerald.

**night stones**; fine-quality of alexandrite with strong changing colors.

**nigrine**; a black iron-bearing variety of rutile.

**nihil album**; same as flowers of zinc

**nila**; a Burmese term used for large sapphire stones. → Corundum classification in Myanmar.

**nilangandhi**; a Sanskrit term used by Hindus for indigo-blue to violet ruby.

**nila-sa**; a Burmese term used for inferior mixed inferior corundum or sapphire. → Corundum classification in Myanmar.

**nilion**; a local term for grayish to brown jasper from the banks of the Nile, Egypt. The term was also used by Greeks.

**nilt**; a local term in Myanmar, (Burma) for large specimens of sapphire.

**nin**; a local miner's term used in Thailand for black spinels found in corundum mines. Also black spinels are found in Monte Somma, Vesuvius, Italy. → Ceylonite.

**niobite**; same as columbite.

**niobium**; a rare gray or silvery, malleable, ductile metallic element of the Periodic System with the symbol Nb, which is also called columbium.

**nippers**; a term used by miners for an instrument by which miners cut round the edge of a sample to ascertain its value.

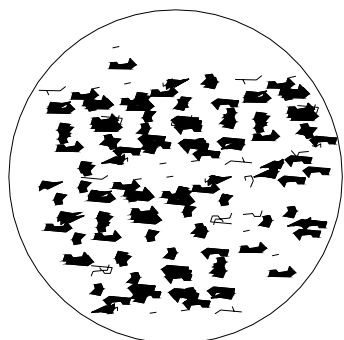
**Nishapur**; famous turquoise deposit from Province Khorassan, north-east Iran. Also spelled Nishapur.

**Nishapur;** same as Nishabur.

**nitric acid;** a white toxic, corrosive, fuming liquid of  $\text{HNO}_3$ . Soluble in water, used as diluted liquid 1:20 for the test of dyed black pearls. A constituent of aqua regia. Concentric nitric acid is called aqua fortis.

**nitrobenzene;** a greenish-yellow, oily liquid of  $\text{C}_6\text{H}_5\text{N O}_2$  used for refractive index test RI:1.55. Soluble in alcohol, benzene, ether, and slightly in water. Also called oil of mirbane.

**nitrogen;** a colorless, odorless, tasteless gaseous element of atomic number 7 of the Periodic System with the symbol N, which has 5 outer electrons. Occurs as trace inclusions in diamond with large band-gap



*scales of  
nitrogen in  
diamond  
type-A*

semiconductor and act as *donors*, while the light is absorbed in the violet region and it believed to be the cause of the yellow tints in cape stones, such diamond are classified as Type Ib or *canary diamonds*. When the content of nitrogen is in greater quantity than described the diamonds are classified as Type Ia and has no more the donors function. Completely nitrogen free diamonds are classified as Type IIa, and Type IIb. Diamonds of the Type IIb contain boron, are semi-conductive and usually blue in color. Such a impurities are sometimes named as activators. → Diamond Types I and II, type classification.

**nitrogen donor;** → nitrogen.

**nitrogen impurity;** → nitrogen.

**nitrogen in diamond;** → Nitrogen, diamond Types I and II, type classification.

**nitrogen oxide;**  $\text{NO}_3$  impurity in emerald lost one electron probably by irradiation to form color centers as seen in Maxixe-type beryl.

**nixonoid;** a commercial misleading term for a type of cellulose plastic.

**nitrophenylenediamines;** a group of organic compounds with different structure but same chemical formula exist in many colors, used as dye especially for hair dyes.

**Nizam Diamond;** a partially fashioned diamond approximately 277 cts, Believed to be found in Golconda in 1835, rough weight nearly 340 cts, It is said to have been once owned by the Nizams of

Hyderabad (formerly Golconda). Present owner unknown. Also spelled Nizzam Diamond.

**Nizhne-Tagilsk;** location of malachite deposit in Nizhne-Tagilsk, Siberia, the Russian Federation, CIS.

**Nizzam Diamond;** same as Nizam Diamond.

**nm;** an abbreviation for nanometer.

**NMDC;** an acronym for National Mineral Development Corporation of India.

**No;** a chemical symbol for the element nobelium.

**nobbies;** a local misleading term used in Australia for a small gem variety of black opal prior to cutting, it occur in round or almond-shaped pieces in a near-worthless matrix. It is believed that this opal is a replacement after coral or sponge. → Opal dirt.

**nobby;** → nobbies, opal dirt, flat, flat nobby.

**nobby;** same as knobby.

**noble;** a term used in mineralogy to express superiority or purity of a mineral such as noble opal, etc., now known as precious opal.

**noble coral;** same as precious coral. → Coral.

**noble garnet;** → almandine

**noble gases;** the inert gas elements are helium, neon, argon, krypton, xenon, and radon-222. Also called rare gases, inert gases.

**noble gas with cadmium laser;** → laser.

**noble metal;** metals such as gold, silver, platinum, which are resistance to corrosive attacks by acid or other agents and resist atmospheric oxidation. → Precious metal.

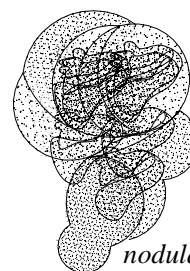
**noble opal;** opal with characteristic showing good play-of-color or delicate tints, which distinguish them from common opal. Also called precious opal.

**noble pen shell;** → Pinna pearl.

**noble serpentine;** a hard, translucent variety of serpentine with honey-yellow, oily-green to light green color. Also called precious serpentine.

**noble stone;** nearly same as precious stone.

**nodular;** pertaining to or having the character of a



*nodular gold*

minute rounded lump.

**nodular chert;** a dense, irregular chert having the shape of a nodule.

**nodulated;** same as nodular.

**nodule;** a small spherical, oval, concentric lumps of mineral or rock sometimes enclosing a foreign body in

the center, such as flint or marcasite.

**nodules**; a term used for flaw-free zones in tourmaline crystals.

**nodule**; a term used by Australian miners for a small spherical, concentric lump of opal matrix, which is found under sandstone in gutters of yellowish opal dirt.

**noir belge**; a misleading term for black marble from Belgium. Also called noir belge marble.

**noir belge marble**; same as noir belge.

**noir français**; black marble from Pas de Calais, France. Marbles from the North of Pas de Calais are known as *grand antique*. Also called noir français marble.

**noir français marble**; same as noir français.

**noiwarimbu wehe**; a Manchurian term for greenish stone, may emerald.

**Nomarski interference contrast**; → phase-difference microscopy.

**nomenclature**; a system of specialized terms belonging to a science, art, trade, or industry.

**nonbenzenoid**; → polyene, porphyrin.

**noncrystalline**; another term for amorphous. An amorphous solid material or substance, which has no crystalline structure, or whose internal arrangement is so irregular that there is no characteristic external form. Also called structureless.

**nonliquid crystal**; → liquid crystal.

**non-mineral gems**; coral, amber, pearl, jet, ivory, bone, and glass is accepted as gemstones but they are mineraloid.

**none nacreous pearl**; pearls without nacre obtained from giant conch and giant clam. SG:2.80.

**non-nucleated cultured pearls**; a variety of fresh-water non-nucleated cultured pearls grown by inserting a piece of foreign mantle of a slow-growing fresh-water bivalve mussel with greenish-black periostracum into the pearl-bearing Japanese freshwater mollusk *Hyriopsis Schlegeli*, which has internal fine nacre and locally known as *ike-chogai*. The cut graft tissue piece is inserted into the gonads or sex organ of the animal. Non-nucleated cultured pearls are produced in Australia waters from large oyster *Pinctada maxima*. The Chinese non-nucleated cultured pearls in appearance are similar to Biwa-Ko in various colors, some inferior quality pearls from China are known as *rice crispy* pearls. Also produced in lake in Hanoi, Vietnam. Such pearls are light whitish or dark orange and may be in the form of oval, baroque, or button pearl. They are known as *Biwa*, or sometimes as *Biwa-Ko* pearls; the termination -Ko: means lake in Japanese. Also called non-nucleated pearls, non-nucleus cultured pearl, tissue-graft cultured pearl. → Biwa pearls.

**non-nucleus cultured pearl**; same as non-nucleated cultured pearls.

**nontransparent white stones**; usually these stone are nontransparent white: chalcedony, coral, alabaster, glass, corundum, jadeite, grossularite, gypsum, coral, albite, etc.

**nonthermal luminescence**; a term used to described distribution of colors as viewed in a variety on nonincandescence light source, which known as luminescence such as bioluminescence, photoluminescence, etc.

**noodle**; a term used by Australian miners for sending carefully the dirt up in the bucket to the sunlight.

**noodle**; a term used by Australian miners for dumps or mullock close to the site for overlooking to find opal, which has missed.

**noodler**; a term used by Australian miners for some who dumps close to the site hopping to find opal which has missed.

**noodling**; a term used by Australian miners to search the opal mine tailing for further minerals. → Gully raking.

**Nooitgedacht**; location of an alluvial diamond mine near Barkly West, Cape Province, South Africa.

**Nooitgedacht Diamond**; a yellow diamond of 325 cts, found in 1953 by a native African at Nooitgedacht, Cape Province, South Africa. Present whereabouts unknown.

**Noolinga Nera Opal**; an oval cut opal 205 cts, from Andamooka, Australia.

**Noor-ol-Ayn Diamond**; → Nûr-ul-Deen Diamond.

**Noor-un-Deen Diamond**; → Nûr-ul-Deen Diamond.

**Nophak**; same as nophek.

**Nophech**; same as nophek.

**Nophek**; Hebrew word meaning a shining stone. A biblical term for the fourth gemstone in the Aaron's Breastplate. Translated as ruby (carbuncle) or probably an almandine garnet or emerald. The stone is engraved with the word *Judah*. Also spelled nophech, nophak.

**norbergite**; a member of humites nesosilicate group. Yellowish pleochroism. Fashioned as gem.

System: orthorhombic.

Formula:  $2[\text{Mg}_2(\text{SiO}_4)(\text{OH},\text{F})_2]$ .

Luster: vitreous, resinous to dull.

Colors: white, pinkish-white, yellow.

Streak: white.

Diaphaneity: transparent to translucent.

Cleavage: {110} distincts.

Fracture: subconchoidal to uneven. Brittle.

SG: 3.15-3.18.

H:6-6½.

Optics;  $\alpha$ :1.563-1.567,  $\beta$ :1.567-1.579,  $\gamma$ :1.590-1.593.

Birefringence: 0.027. ⊕.

Found in Sweden, Norway, and New Jersey (USA).

**norbide**; a commercial term for an abrasive material that made artificially of boron carbide (B<sub>4</sub>C).



**Nordica Pearl;** a fine-quality, greenish abalone pearl of 175 grams. It is part of a necklace, which is owned by Mrs. Nordica.

**norite;** a mafic, phenocrystalline, coarse grained plutonic rock of gabbro clan. Containing labradorite feldspar, ortho-pyroxene (hypersthene). Used as cladding building facades.

**normal;** in geometry a line perpendicular to a surface or to a line.

**normal;** in optics, the normal is an imaginary line drawn perpendicular to the interface between the two media at the point of incidence of a light, in such a case the incident ray strikes the surface perpendicular.

**normal crystal habit;** same as isometric crystal.

**normal zircon;** not metamict zircon.

**normative mineral;** same as standard mineral.

**north daylight;** same as north light.

**north light;** the natural daylight phenomenon from the northern hemisphere traditionally thought to be the ideal source for color grading diamonds. (It consisting of luminous arcs, ray, streamers, etc. of green, red or yellow color, caused by high-speed stream of electrical particles from the sun. On entering the upper atmosphere the charged particles excite the air molecules due to an emission of special light. They are best seen in the neighborhood of the North Magnetic Pole, which is known as *Aurora Borealis*. Same phenomenon in southern hemisphere is called *Aurora Australis*). It is believed that the northern light contain the least amount of ultraviolet and least variation of intensity and color, and is relatively shadow free between 10 a.m. and 2 p.m. In laboratories the grading of diamonds happens under controlled artificial light, which simulates approximately north daylight quality. The slightly bluish-white light of the northern light or skylight in the opposite hemisphere has a color temperature of about 273.15° C. Also called north daylight. → *Aurora Borealis*, grading lamp.

**North Star Diamond;** a fancy blue, pear-shaped diamond of 32.41 cts, it was cut from a rough stone of 97 cts, Found in Jagersfontein Mine, South Africa. Sold to Baumgold Bros. in 1969.

**Norwegian amber;** ambers found on shores of the Baltic Sea of Norway. Same as Baltic amber.

**Norwegian Gemmological Association;** the headquarters of this association is located in Dronningsgatan 27, Oslo, Norway.

**Norwegian quartz;** a white translucent variety of quartz found in Norway, used for cladding building facades.

**nosean;** one of the constituent mineral of lapis lazuli. Also spelled nosean. Cubic. Chemical formula:  $\text{Na}_8(\text{SO}_4)(\text{AlSiO}_4)_6 \cdot \text{H}_2\text{O}$ . Luster: subvitreous to greasy. Light to dark gray, brown, black, rarely white. Streak is

white. Transparent to translucent. Cleavage: {110} nearly perfect. Fracture: conchoidal to uneven. Brittle. Optics;  $\beta$  1.495. SG:2.30-2.40. H:5-6. Found in Italy, and Canary Isle, Spain. Also called noselite.

**noselite;** same as nosean.

**notch;** a term applied to small groove cuts in a rough diamond with another sharp edged piece to prepare it if there is cleavage. Also called kurf, and kirve, jag, kerf (diamond working).

**notch;** a term used as a verb.

**notching;** in diamond industry an angular cut.

**n-type silicon;** silicon as semiconductor, were doped partly with phosphor impurities, this regions are negatively charged electrons in the conduction band because of the donor phosphor atoms. Also called n-region.

**noumeite;** another term for garnierite from Noumea, New Caledonia, USA.

**Nova Estrêla do Sul Diamond;** a greenish diamond of 140 cts, found in 1937 in the Abaeté River, Minas Gerais, Brazil. Present owner unknown.

**novaculite;** a translucent, light-colored to reddish-brown, fine-grained, cryptocrystalline, siliceous sedimentary rock variety of jasper, similar to chert found near Hot Springs in Arkansas, USA. Used as a curio stone or cut cabochon and as whetstone. Also called razor stone, Turkey stone, Turkey slate, ouachita stone, hornstone and galactite (obsolete).

**Novosibirsk synthetic alexandrite;** synthetic alexandrite made in three methods in Russia, (a) growing synthetic stones of solution-growth process or flux process specially for alexandrite. (b) Growing stone of floating-zone process. (c) Melt-grown process or so-called pulling method.

**Novosibirsk synthetic emerald;** synthetic emerald grown in Russia by accelerated crucible-rotation flux method.

**Novosibirsk synthetic ruby;** synthetic rubies or sapphires are made in 5 methods in Russia: (a) growing synthetic stones by melt-growth process or Verneuil or flame-fusion process. (b) Growing stone by floating-zone process. (c) Melt-grown process by so-called pulling method or Czochralski process. (d) Growing stone by flux process. (e) Hydrothermal process.

**Novosibirsk synthetic spinel;** synthetic spinel is made in Russia by flux-grown process.

**Np;** a chemical symbol for the element neptunium.

**n-region;** same as n-type silicon.

**nuclear charge;** the positive electric charge arising in the atomic nucleus due to protons, equal in number of the atomic number of the element.

**nuclear reactor;** a complex atomic apparatus used to obtain energy from nuclear fission chain reaction. Used

to produce nuclear energy, radioactive isotopes, and artificial elements. In this fission usually two or three neutrons are released, the free neutrons and the fission particles are carried away and most of the free energy are kinetic energy and part of them is gamma radiation. Gamma radiation is used to treat gemstone to improve color and appearance. Also known as atomic pile, fission reactor, atomic reactor, pile, reactor, and nuclear pile. → Irradiation.

**nuclei;** a name for several nucleus.

**nucleon;** a collective name for both proton and neutron, which are consistent of a nuclei.

**nucleus;** positively charged center portion of an atom, consisting of one or more protons and neutrons.

**nucleus;** usually a reference to the central part of a pearl. → Nucleus operation on cultured pearls.

**nucleus;** spherical bead of mother-of-pearl inserted in the shell of a mussel to obtain cultured pearl, which is coated with nacre.

**nucleus inserting;** formerly inserting of nucleus in oyster body for producing cultured pearl caused a high percent of deaths and weak colored pearls. Now inserted pieces of epithelium (mantle tissue), from a donor mussel into the sex-organ (gonads) of oyster.

**nucleus preparation of cultured pearls;** to artificially insert a nucleus in the blister pearl oyster a substance must be chosen, which is not foreign to the oyster. A spherical nucleus, usually of mother-of-pearl is suitable. The beads of mother-of-pearl are sorted to size for different oysters, which range from 0.2 mm to more than 13 mm in diameter for *Pinctada martensi*, *Pinctada maxima*, and *Pinctada margaritifera*. Sometimes nucleus beads for mabe cultured pearl are made from steatite (soaponite) a soft mineral because it offers no affinity to nacreous. → Nucleus, steatite nucleus for cultured pearls.

**nucleus pusher;** a term applied to who pushed nucleus in oyster for producing cultured pearl.

**nugget;** a large, rounded, irregular lump of mineral, placer gold, silver or other metal found free in nature. Usually water worn. Used to make finger rings, brooch, pendants, pins, necklaces, etc. in natural form.

**nuggety gold;** a large, rounded, irregular lump of native gold.

**nuits St. George marble;** an oolitic marble of pale red wine color of Jurassic age found in the Loire valley of

France.

**nummulitic marble from Meshed;** a marvelous, shiny, fossilized marble from Meshed, Iran in which tiny fossils are dispersed in creamy marble. The stones are exported to Pakistan and there will be fashioned in different forms and as ornamental stones. Also called Iranian nummulitic marbles.

**nunderite;** a brownish spotted green ornamental stone composed of plagioclase feldspar and jadeite found in Nubdel, New South Wales, Australia.

**Nunkirchen jasper;** a light gray-brown to brownish-red, fine-grained variety of jasper from Nunkirchen, near the twin towns Idar-Oberstein, Germany.

**Nuristan beryl;** various colored gem beryls found in pegmatites in Nuristan region, Afghanistan.

**Nur-ud-Deen Diamond;** same as Nûr-ul-Deen Diamond.

**Nûr-ul-Ain Diamond;** a pink, drop-shaped brilliant-cut diamond of 60 cts, Set in a diadem with 323 smaller diamonds. Now on display in National Jewel Treasury of Iran, Tehran. It is believe that the Darya-i-Nûr Diamond and Nûr-ul-Ain Diamond of the diamond tiara are surviving pieces of the Great Table (Meen). The name means light of the eye in Iran. Sometimes spelled Nur-ul-Ayn Diamond, Noor-ol-Ayn Diamond.

**Nur-ul-Ayn Diamond;** same as Nûr-ul-Ain Diamond.

**Nûr-ul-Deen Diamond;** a large pink diamond (weight unknown), which was mounted in the center of a cross decorated with other 85 brilliant and 160 rose cut diamond, owned by Alexander Tsary of Russia in 19<sup>th</sup> century. It was sold in London in 1898. Present owner unknown.

**nuummite;** an iridescent ortho-amphibole mineral of anthophyllite gedrite series found in Nuuk, Greenland. Chemical formula: for anthophyllite (Fe<sup>+2</sup>,Mg)<sub>7</sub>(Si<sub>8</sub>O<sub>22</sub>)(OH,F)<sub>2</sub> and for gedrite (Fe<sup>+2</sup>,Mg)<sub>5</sub>Al<sub>2</sub>(Si,Al)<sub>8</sub>O<sub>22</sub>(OH,F)<sub>2</sub>. Optics; α:1.640, γ:1.660. Birefringence: 0.020. SG:3.24. H: 5.5-6. Cut as gems with a sparkling iridescence of green to violet color on polished surfaces. It is a volcanic origin and later metamorphic influence.

**nyf;** the outer *gum-like skin* or surface on a rough diamond. → Crinkles.

**nylon;** a generic term for any fiber-forming thermoplastic elastic polyamide materials. Used for imitation of gem materials such as bakelite.

# O o

**o**; a symbol for ordinary ray.

**O**; a chemical symbol for the element oxygen.

**Oacamer diamond**; same as Oaxacan diamond.

**Oaxacan diamond**; a misleading term for quartz crystal from Mexico. Also known as Oacamer diamond or Oaxacan quartz diamond.

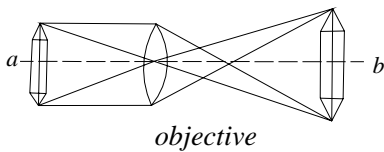
**Oaxacan quartz diamond**; same as Oaxacan diamond.

**Oamaru stone**; a white, granular limestone from Oamaru, New Zealand, used for building stone.

**object**; a figure or an object (real or virtual) formed by an optical system.

**object glass**; same as objective.

**objective**; the magnifying lens or lens system of various focal lengths or powers nearest the specimen in a microscope. The objective creates inverted image of an objects. The



power of objectives ranged from 75 mm to 1.5 mm. Also called object glass, objective lens.

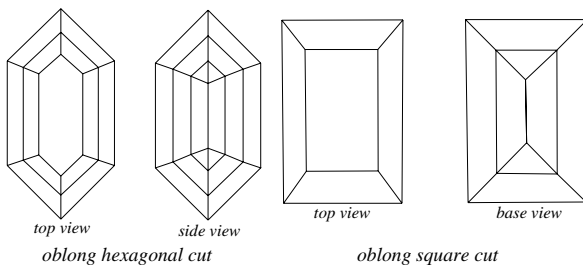
**objective lens**; another term for objective.

**oblique illumination**; oblique or diagonal lighting.

**oblique system**; synonym for monoclinic.

**oblong cut**; another term for emerald cut.

**oblong hexagonal-cut**; same as hexagon cut but varying the length and angles of two parallel sides.

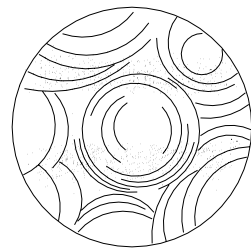


*oblong hexagonal cut and oblong square cut*

**oblong square-cut**; same as square cut but varying the length and angles of two parallel sides. → Oblong hexagonal-cut.

**obsidian**; a solid volcanic natural form of glass (a rock) of rhyolitic, dacitic, pitchstone or sometimes basaltic

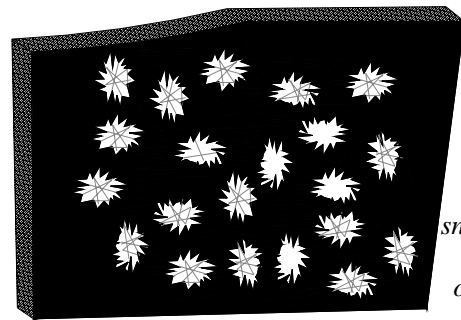
composition. Formed by rapid cooling of volcanic viscous lava.



*perlite of obsidian*

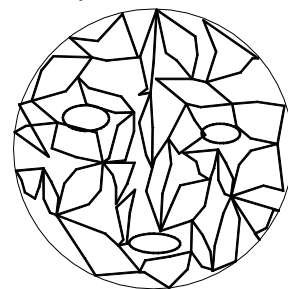
The color ranges from opaque-black to gray. Sometimes it can be red, yellow, green or brown.

Frequently shows an iridescent effect due to small inclusions. It was used by Egyptians and other people of pre-dynastic times. Obsidian is widely used for tumbled gems, ornamental objects, beads and cut into cabochon, some pieces have been faceted. There are several shaped inclusions in obsidian such as snowflake obsidian or bubbles. Some specimens possess the schiller effect, but not chatoyancy. Varieties of obsidian are *snowflake obsidian* with grayish flower-like patches in a black matrix. *Marekanite* is a smoky-brown, gray, or black decomposed variety of perlitic obsidian. *Peanut obsidian* is a spherulitic material with radiating feldspar. *Flowering obsidian* is a variety of white to



*snowflakes on obsidian*

grayish-black matrix of obsidian, in which white spherulitic mineral are included. *Silver obsidian* or *golden obsidian* are varieties of obsidian with iridescent effects. Some transparent, gray to pale green obsidians shows cat's-eye effect, when cut cabochon. *Tokay lux*



*mosaic or spiderweb of obsidian*

*sapphire* is a misleading term for brownish-black obsidian from Hungary. *Rainbow obsidian* is an effect caused by minute bubbles. *Banded obsidian* has agate-like bands. *Onyx obsidian* has parallel bands. The black to dark brown variety is called *apache tear* with

minute, spherical, irregular shaped pieces. Reddish-brown to brown and streaked material is known as *flow obsidian*. The *sheen obsidian* or *gold sheen obsidian* variety contains numerous minute spangly inclusions. *Spiderweb obsidian* is similar to brecciated rock and *perlite* has numerous curved sub-spherical and a shelly structure found along the cracks are beads or ball-shaped pieces. *Mountain mahogany* is a striped red and black variety of obsidian. Termed *Iceland agate*, or *Icelandic agate* is a local misnomer for obsidian. Misleadingly called rhyolite glass. Also called hyalopsite.

**obsidian**; sometimes moldavite is misnomered as obsidian. Also called hyalopsite, Iceland agate, Nevada topaz, Nevada diamond, Montana jet, mountain mahogany, mountain jet. → Tektite.

System: amorphous.

Formula: a variable composition of 60-75% SiO<sub>2</sub>, contain oxides of Ca, Na, K.

Luster: vitreous.

Colors: dark gray, black, gray banded with brown streaks, green, greenish-blue, blue, red. Basaltic glass occurs in black, gray, blue and blue-green color.

Streak: colorless.

Diaphaneity: translucent to opaque.

Fracture: conchoidal to uneven. Brittle.

SG: 2.33-2.60, for basalt glass: 2.70-298.

H:5, for basalt glass: 6.

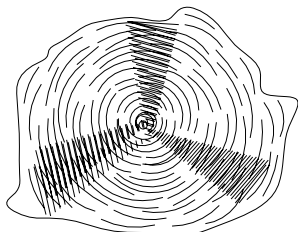
RI:1.48-1.51.

Found in Oregon, Nevada, Hawaii, Arizona, Wyoming, New Mexico, California, USA, Iceland, Japan, and Mexico.

**obsidian cut**; used for tumbled gems, ornamental objects and beads. Can be cut into cabochon, used in small carvings and jewelry, some pieces have been faceted.

**obsidian cat's-eye**; frequently transparent, gray to pale green obsidians show cat's-eye effect, when cut cabochon due to fine silky striations.

**obsidian conchoidal fracture**; obsidian has a typical fracture similar to the outer shell of a conch.



*conchoidal fracture of obsidian*

**obsidian inclusions**; inclusions in obsidian are elongated, torpedo, tear-shaped, round-shaped bubbles, which may be parallel arranged. Sometimes can be seen

needlelike inclusions with silvery sheen. Protogenic silica in grayish-white, flower-like patches in a black matrix are known as *snowflake obsidian*.

**obsidian iridescence**; iridescence in obsidian is caused by inclusions of minute bubbles which reflected the light in silver, gold, green, violet, blue or combinations of these colors.

**obsidian nodule**; obsidian having the shape of a nodule.

**obsidianite**; an obsolete term for obsidian-like tektite.

**obsolete**; no longer in general use because of improvements or revised requirements.

**obtuse bisectrix**; → optic axis.

**obus**; an elongated modification of 5-sided step-cut where its two long sides are drawn to one point. The term means howitzer shell. Same as bullet cut.

**occidental**; a prefix to describe gemstones found in the western hemisphere. → Colombian emerald.

**occidental**; a misnomer used to distinguish inferior qualities from the better qualities from east, for example *occidental chalcidony*.

**occidental**; sometimes the term is misused to present a substitute as being a genuine gem for example *occidental turquoise*.

**occidental**; a term used to describe the western hemisphere.

**occidental agate**; an inferior quality of quartz.

**occidental amethyst**; an obsolete term for natural amethyst variety of quartz.

**occidental aquamarine**; a misleading term for an aquamarine gemstone found in the western hemisphere to distinguish from oriental aquamarine.

**occidental carnelian**; an inferior quality of carnelian.

**occidental cat's-eye**; a misleading term for cat's-eye variety of quartz containing hornblende needles.

**occidental chalcidony**; a term for inferior quality of chalcidony.

**occidental diamond**; a misleading term for limpid and colorless variety of quartz used as a diamond imitation.

**occidental emerald**; a misleading term for green sapphire to distinguish from natural emerald.

**occidental emerald**; a misleading term for green sapphire to distinguish from oriental emerald.

**occidental emerald**; same as new emerald, Colombian emerald.

**occidental pearl**; any pearls from Pacific and Atlantic coast.

**occidental topaz**; a misleading term for citrine or yellow quartz.

**occidental turquoise**; a misleading term for odontolite.

**occlusion**; absorption in chemistry.

**occurrence**; the presence of mineral or gem-mineral in a rock or an outcrop.

**ocean green topaz**; a commercial term for irradiated

topaz in nuclear reactor, which turned its color to green.

**ocean mining;** same as off-shore mining.

**Ocean of Light Diamond;** same as Darya-i-Nûr Diamond.

**ocher;** an earthy pigment consisting of hydrated iron oxide, silicates and clay. When yellow brown ocher contains limonite the red ocher contains hematite. Used as soldering material and as pigment. Also spelled ochre, ocker, Japan earth.

**ochre;** same as ocher.

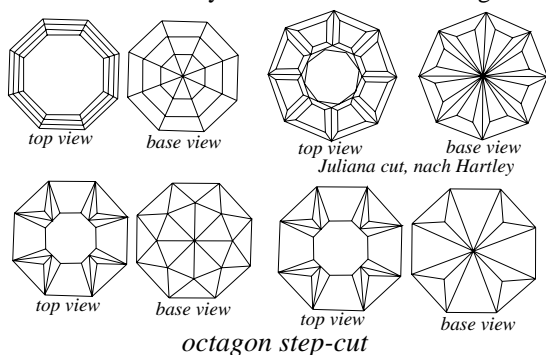
**ocherous;** pertaining to, containing, or resembling the ocher. Occurring in earthy pigment, powder form. Also spelled ochreous.

**ochreous;** same as ocherous.

**ockamatutt;** an especial glue used by jet worker in England when the piece is small to hold with hand. Tut is quasi an acronym.

**ocker;** same as ocher.

**octagon step cut;** an 8-sided step cut, form which is based on brilliant style or mixed cut. The length of the



sides and their angles may vary.

**octagon work;** the operation of putting the 8 main facets on the crown and 8 main facets on the bottom of a stone. Placing the 8 main facets on the crown gives the table its octagonal form.

**octahedral;** pertaining to an octahedron form or structure.

**octahedral cleavage;** in cubic system, crystal cleavage that occurs parallel to the face of the octahedron, for example diamond.

**octahedral cobalt;** → isoelectronic.

**octahedral copper ore;** same as cuprite.

**octahedral iron-ore;** same as magnetite.

**octahedral face;** in the cubic system one of the 8 triangular surfaces of an octahedral crystal. → Cubic system, crystal face.

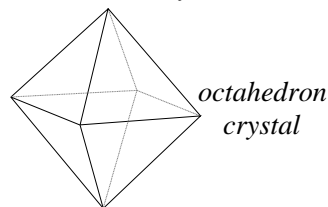
**octahedral plane;** in the cubic system a plane with equal intercepts on all three axes (three equivalent Miller indices {111}).

**octahedrite;** a misleading term for anatase because anatase crystallizes in tetragonal system not in cubic,

and the crystal form is tetragonal dipyramidal.

**octahedrite;** a common iron meteorite.

**octahedron;** a crystal form of the cubic system that is closed by eight similar faces, which are equilateral triangles. Its indices are {111}. It is one of the most common forms of diamond

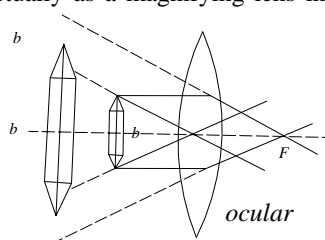


crystals.

**octave;** a term used in optics for interval between two frequencies of any type of oscillation having ratio 2:1. → Light.

**octavo;** a Mexican/Brazilian gem weight approximately to 17.50 cts, Also spelled oitava.

**ocular;** any lens or combination of lenses acting virtually as a magnifying lens in a microscope nearest the eye of the observer. Also called ocular, or ocular lens. Same as eyepiece. Also spelled eye piece.



**ocular lens;** same as eyepiece.

**Oculinacea vaseuclosa;** → white coral.

**oculus;** → eye.

**oculus mundi;** → hydrophane.

**Oda;** locations of alluvial diamond deposits in Eastern Province of Ghana, Africa.

**Odem;** a biblical term for the first gemstone in the Breastplate of the High Jewish Priest. Probably red jasper (sardius) or carnelian. Stone is engraved with the name Reuben.

**odontolite;** a translucent to opaque fossil bone or ivory obtained from mastodon, mammoth, dinothereum or other extinct animals, which are naturally deep blue colored by impregnation of vivianite, an iron phosphate. Vivianite colored the organic component of the bone. Chemical composition is near to apatite. It resembles turquoise and is used as imitation for turquoise. Sometimes, but rarely is colored green by copper. RI:1.57-1.63. SG:3.00-3.20. H:5. Some grayish-blue to rich blue material are subjected to heat-treatment. Found at Simmore in southern France, Siberia (Russia). It is cut and polished for jewelry and loses its color in the course of time. Also called *fossil turquoise*, *bone turquoise*, *tooth turquoise*, *tusk turquoise* or *Occidental turquoise*. An imitation odontolite is made. → Vivianite.

**odontolite imitation;** imitations are made from

calcining fresh ivory and dying in a liquid of copper sulfate. SG 1.8 of fresh ivory.

**odor test;** a sensate property of some minerals with a characteristic odor, which can be tested by rubbing, striking, and breathing upon or heating.

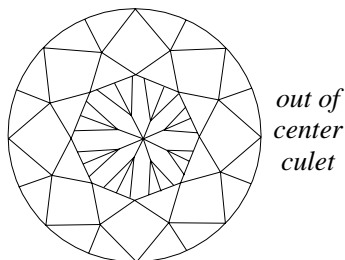
**odor varieties;** varieties are: alliaceous that of garlic like arsenic minerals; horse-radish that of selenium minerals; sulfurous that of sulfur; fetid that of rotten eggs; argillaceous clayey that of clay, when breathed upon.

**Oedemagena tarandi;** name of a small amulet sculpture made in Germany from jet, which represented the larva of a dassel fly. These insect larvas are still eaten as delicacy by Eskimos.

**oeil de boeuf;** a French term for ox-eye, or bull-eye labradorite feldspar.

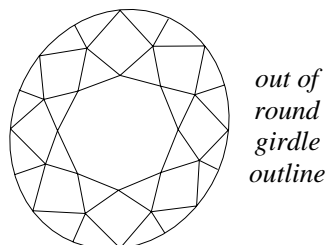
**Oersonskraal;** location of small alluvial diamond deposit in Transvaal Province, South Africa.

**off-center culet;** when the culet of a fashioned stone in not



concentric with reference to the girdle outline. Also known as eccentric culet. → Off-center table.

**off-center table;** when the table of a fashioned stone in not concentric with reference to the girdle outline. Also



known as eccentric table. It is due to the opposite crown facets, which are cut at different angles or bezel facets

having different dimensions. Also known as eccentric table.

**off-color;** not having the right color also not colorless, or an unattractive color or light colored.

**off-color diamond;** a color grading of polished diamonds with an unattractive slight tinge of yellow, brown or green color, that is apparent to the unaided eye, when viewed through table.

**off-color gems;** those stones with an unattractive color and not of first water due to their faint trace of color.

**off-hand-glass;** any glass ware that formed completely by hand.

**off-shore mining;** alluvial diamond mining from flat

zone of variable width of sea-bed, which is situated at a distance from the shore. Also called ocean mining.

**oiled emerald;** → emerald,-oiled.

**oiled stone;** sometimes flaw rich stones such as ruby, emerald and sapphire are impregnated with cedar oil, kerosene or other oils to make flawless invisible and to improve their color and appearance. Cedar oil is used to enhance emerald, while it has a refractive index near to emerald. When the stone is cleaned with benzene, detergents or hydrochloric acid in a vacuum chamber, the oil and color disappear and the flaws are visible under lens examination. Also called oiling.

**oiled stone;** a term applied to heated amber to clarify an opaque or cloudy amber. The amber immersed in warmed oil, which penetrates the air spaces that caused the cloudy appearance. Also called colza oil, rape oil, rape seed oil.

**oilie;** an American commercial term used for a light yellow diamond that shows blue fluorescence in daylight such as Premier diamonds from South Africa. Also spelled oily.

**oiling;** → oiled stone.

**oiling of stones;** → oiled stone.

**oil of amber;** a reddish-brown oil obtained from amber, when heated 250°-300° C. Also called amber oil.

**oil of mirbane;** same as nitrobenzene.

**oil pearl;** same as Antilles pearl.

**oils spots;** a characteristic appearance of greenish spot on some oriental pearls, due to conchiolin knots under the surface layers.

**oil stone;** a smooth, fine-grained block stone used for sharpening edged tools, it is first moistened with oil, made from alundum. It is known as *Arkansas* stone; the fine-grained variety marketed under *hard Arkansas* and coarse-grained as *washita stone*. Also known as novaculite, whetstone.

**oil stone;** a local term in Transvaal, South Africa for water-worn agates pebbles found with diamonds in alluvial deposits. Also spelled oilstone.

**oilstone;** same as oil stone.

**oil-tempering-stone;** → oiled stone.

**oily;** same as oilie.

**oisanite;** a synonym for epidote and anatase.

**oitava;** same as octavo.

**ojo de gato;** Spanish term for cat's-eye.

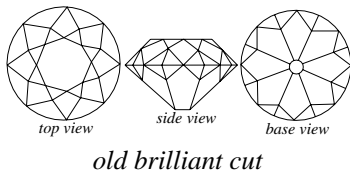
**okkolite;** a vary color variety of epidote used as an ornamental stone cut cabochon and tumbled. It is similar to unakite. Found in Cape Province, South Africa.

**okkolite;** the cut stones of unakite from South Africa are sold under the name okkolite.

**old-American cut;** a 16-sided two-step brilliant cut diamond having no table, with 48 facets in the crown

and a deep crown and pavilion. Base having 24 facets and a culet. This cut was used in USA until the modern cut was published by Marcel Tolowsky. Frequently erroneously referred to as old-mine cut. → American cut.

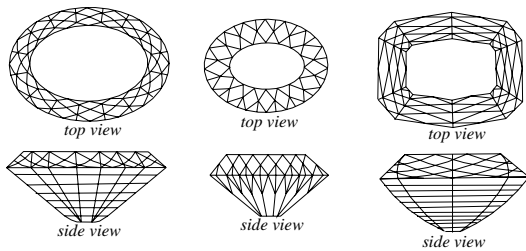
**old brilliant-cut;** an earlier brilliant cut used in Europe before the modern brilliant cut. It was round-cut with 32 facets and a table in the crown and 14 facets and a culet in pavilion.



old brilliant cut

**old carat;** a weighing unit for gemstones and precious metals that for centuries varied from country to country, which ranged from 188.50 mg in Bologna, Italy to 213.50 mg in Persia. On 1st April 1914 the unit carat was standardized world-wide into the *metric carat*; equivalent with 200 mg. → Carat, metric carat, Karat.

**old cuts;** two oval cushion-shaped brilliant cuts with



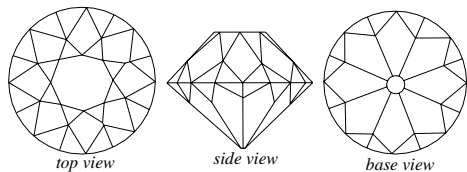
three different old-cuts

oval or oblong 16-sided table. Pavilions are stepped form as seen in figures.

**old emerald;** same as *esmeralda viejas*, which is an old term used in past for highly valued emerald, such as old emerald which were actually green sapphire and called oriental emerald. → *Esmeralda nuevas*, Colombian emerald.

**old English cut;** → eight cut, single cut.

**old-European cut;** a circular-girdled brilliant cut diamond having a very small table, and a deep crown and



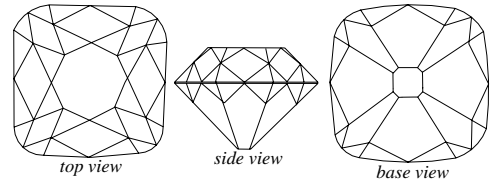
old European brilliant-cut

pavilion. Frequently erroneously referred to as old-mine cut.

**old-mine cut;** an early version of brilliant-cut diamond

*old brilliant cut – Old World*

having a cushion-shaped girdle has a very small octagonal table and a high crown with 32 facets and high pavilion with 24 facets on it, plus a very large culet. The cut stones coming from Brazil were called *old mine* to distinguish them from stones found in and



Old mine cut

South Africa with a round girdle by means of modern bruting. Originally known as the *triple cut* but later applied to *lumpy* stones. Brazilian cut is an old-mine cut with 8 additional facets surrounded the culet. Also called mine cut, old miner, Peruzzi cut, or triplet cut brilliant. → old-European cut.

**old-miner;** same as old-mine cut.

**Old Mine emerald;** a dark velvety bluish-green variety of emerald mined in early Muzo Mine, Colombian. Found as rounded pebbles, which are known as *Chibcha stones*. (Chivor emerald are yellowish-green). Cut cabochon usually for necklace. → Somondoco emerald, Muzo Mine, Chibcha stone, Chivor emerald.

**Old Mines Museum;** → Kimberley Museum.

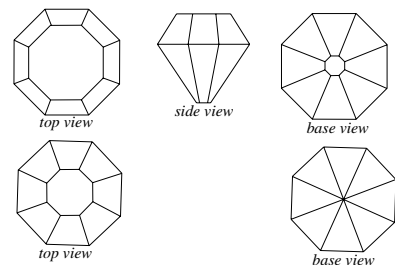
**old rock;** same as old rock turquoise.

**old rock;** a term used in Iran for turquoise stones by which the color and luster not change. → Turquoise classification in Nishapur, Iran.

**old rock turquoise;** an old Persian name for the fine-quality turquoise, in which the color is permanent.

**old rock turquoise;** in Europe a term for genuine turquoise, which distinguishes it from bone ivory.

**old single cut;** the simple pre-brilliant cut with octagonal outline shapes based on the octahedral



two different old single cut

crystal. There is a table, 8 bezel facets on crown and 8 facets on pavilion and usually a culet. Used for minute diamonds pieces.

**Old World Plants;** an amber producing plant from

Arctic Ocean of genus *Cistus*. Amber of this plant is dark in color and brittle used as substitute for ladanum or labdanum in perfumery industry and fixative. Also known as rock rose. → Arctic Ocean amber.

**oleagenus**; a term used for oily beryl.

**oligist**; same as hematite.

**oligist iron**; same as hematite.

**Oligocene**; a geologic epoch of the lower Tertiary period of the Cenozoic era of geological time, which followed the Eocene period and precedes the Miocene, 38-26 million years ago. Rocks of Oligocene system are restricted world wide.

**oligoclase feldspar**; a mineral of the plagioclase feldspar group consisting of the albite and anorthite molecules. Gem varieties are oligoclase sunstone, or oligoclase moonstone and aventurine feldspar due to microscopic inclusions of red, orange, or green very thin platy crystals of hematite or goethite or both, which caused the specular reflection of golden or brownish-red color known as aventurine or sunstone feldspar. Adularia an orthoclase feldspar can frequently be seen with inclusions similar to aventurine with the same effects. → Perthite feldspar, antiperthite.

System: triclinic.

Formula: ranging from  $Ab_{90}An_{10}$  to  $Ab_{70}An_{30}$ .

Luster: vitreous.

Colors: white, green, bluish, yellow, or red, spangled brown to red caused by flakes of hematite or goethite inclusions.

Streak: colorless.

Diaphaneity: translucent to opaque.

Cleavage: {001} perfect.

Fracture: conchoidal to uneven. Brittle.

SG: 2.63-2.66.

H: 6-6½.

Optics;  $\alpha$ : 1.542,  $\beta$ : 1.546,  $\gamma$ : 1.549.

Birefringence: 0.007.  $\ominus$ .

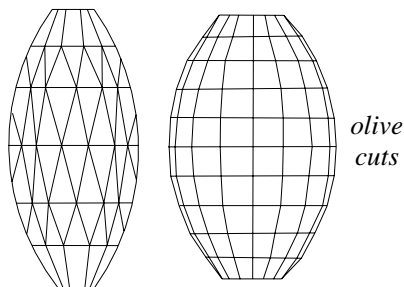
Dispersion: 0.008.

Found in North Carolina (USA), Baffin Island (Canada), India, and Norway.

**oligoclase cut**; are almost cut cabochon, frequently cut as faceted gems from Bakerville, North Carolina, USA.

**olive**; same as olive cut.

**olive cut**; a commercial term for olive-shaped cut, may

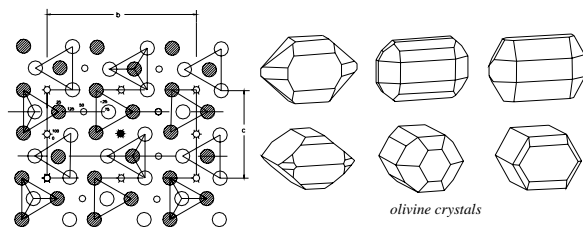


be faceted or unfaceted.

**olivene**; a misleading trade term for demantoid a variety of andradite garnet. Sometimes misspelled as olivine.

**olive oil**; a greenish to pale yellow oil used in certain refractive index test. RI: 1.47.

**olivine**; an isomorphous nesosilicate between two end-members fayalite ( $Fe_2SiO_4$ ) and forsterite ( $Mg_2SiO_4$ ). Refractive indices and specific gravity increase from forsterite to fayalite, while the melting point decreases



crystal structure and crystals of olivine

from forsterite to fayalite. The term has been erroneously applied to *Uralian olivine*, *Siberian olivine*, and *olivine garnet* to demantoid a variety of andradite garnet from Russia. Olivine are cut as gem and sometimes have been seen as cat's-eye and star olivine. Gem varieties are peridot and chrysolite. Also called bottle rock (old term). → Olivene.

System: orthorhombic.

Formula:  $4[(Mg,Fe)_2SiO_4]$ . Frequently contain Mn, and Ni.

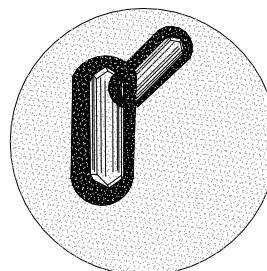
Luster: oily to vitreous.

Colors: olive-green to yellowish green, green-black

Streak: white.

Diaphaneity: transparent to translucent.

Cleavage: {010} perfect, and {010} distincts.



olivine crystals in blue diamond. ca. 2000x

Fracture: conchoidal to uneven. Brittle.

SG: vary with the composition 3.22-4.40.

H: 6½-7.

Optics;  $\alpha$ : 1.651,  $\beta$ : 1.669,  $\gamma$ : 1.684.

Birefringence: 0.033.  $\ominus$ .

Dispersion: 0.020.

Found in Isle of Zebirget or St. John (Egypt), Hawaii, California, Massachusetts, New Mexico (USA), Kenya, Norway, Italy, Myanmar, Mexico, Finland, Greenland, Brazil, etc.



**olivine as inclusions;** as common inclusions are seen in spinels and diamonds.

**olivine cut;** olivine or peridot from Zabargad (Zebirget) or Isle of St. John, Egyptian are faceted as gems and have been cut cabochon as cat's-eye and star olivine.

**olivine garnet;** a misleading term for green demantoid garnet from Ural, Russia.

**olivine, inclusions;** bubbles-like glass balls. Spinel, biotite grains, lotus leaves, petal-like liquid inclusions are seen.

**olivine, pleochroism;** in peridot weak: green to yellow-green. In fayalite: greenish-yellow, orange-yellow and greenish-yellow. In forsterite none.

**olivine rock;** same as dunite. Also called peridotite.

**Olympic Opal;** an uncut opal of 127 ounces or 18,002.25 cts, from Coober-Pedy, Australia.

**Ombelle M'Poko;** location of a diamond deposit province in the Central African Republic.

**omphax;** a term seldom used for aquamarine or for oleagenus a variety of oily beryl. → Beryl,-names of. Also called omphax beryllium.

**omphax beryllium;** same as omphax.

**on a steak;** a term used by Australian miners for showing of good color in a working mine.

**once as weight;** the square of weight of pearls in grains. → Base price of pearl.

**onegite;** a pale purple variety of amethyst, which contain needle-like inclusion of goethite found in form of druses on the island in Lake Onega, Russia.

**one-crystal X-ray diffraction;** same as single-crystal X-ray diffraction.

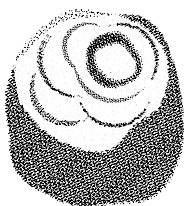
**one-grainer;** → grainer.

**one-man stone;** a piece of stone that one man can handle it.

**one-year pearl;** a misleading term for cultured pearls with unusually thin nacreous layers on the mother-of-shell nuclei.

**onicolo;** another term for nicolo.

**onion-skin weathering;** spheroids of weathered rocks in which the successive shells of decayed rock resemble the layers of an onion. Also called onion weathering,



*onion  
shell  
boulder*

concentric weathering.

**onion weathering;** same as onion-skin weathering.

**on opal;** a term used by Australian miners for having struck a fair opal stone. Also called on stone.

**on stone;** same as on opal.

**Ontario moonstone;** peristerite variety of plagioclase feldspar from Ontario, Canada.

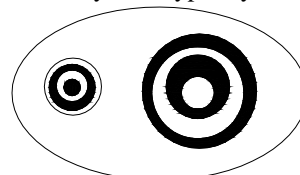
**on the screw;** a term used by Australian miners for a rectangular or square area in old shaft of opal looking as spiral after digging downwards. → Corkscrew.

**onychinus;** same as onychion.

**onychion;** a term mean onyx and equivalent to yashpneh a biblical term for the twelfth stone in the breastplate of the High Priest. It was translated and generally believed to be green jasper, onyx, beryllus, etc. It was engraved with the name Assher. Also spelled onychinus. → Yashpneh.

**onychite;** a yellow or brown banded variety of alabaster or calcite. Used as ornamental stones and carving objects. Found in Egypt.

**onyx;** a translucent to semitransparent variety of chalcedony or cryptocrystalline quartz that is porous



*onyx with concentric rings*

and consists of straight or parallel banded agate of alternating shades of white and black, gray and black, black and red, white

and red, white and brown. Used in making cameos. Almost all onyx in trade is dyed to emphasize the concentric structures. The term onyx has been erroneously applied as a suffix to *Brazilian onyx*, *Mexican onyx*, *Oriental onyx*, *cave onyx*, etc., which are calcium carbonate minerals.

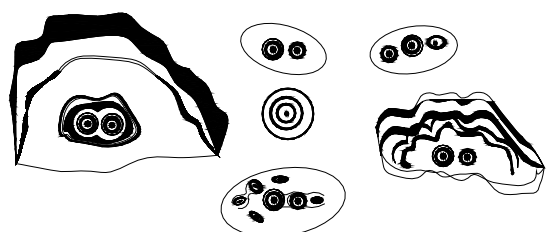
**onyx;** any banded and multi-colored variety of agate used as gemstone.

**onyx;** a misleading term for artificially blue, red, black, or green dyed unbanded chalcedony, which is commonly called *onyx*. The blue colored is known as *Swiss lapis* or *German lapis*.

**onyx;** adjective meaning parallel banded minerals such as onyx marble, onyx obsidian, black onyx. → Niccolo.

**onyx;** adjective for jet-black, which occurs in black or can be black dyed glass. Used as a jet imitation.

**onyx agate;** agate with straight parallel bands of multi-



*onyx-agate cut directions*

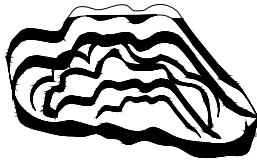
colored layers from white to shades of gray.

**onyx alabaster;** a misleading term for parallel banded calcite.

**onyx calcite**; same as calcite onyx. → Onyx marble.

**onyx dyed chalcedony**; → onyx.

**onyx marble**; a translucent, hard, compact, dense variety of banded calcite or sometimes aragonite, which consists of parallel bands of calcite or aragonite similar to onyx. The color is usually white, green, grayish, red or



*onyx marble wit concentric layers*

brown resembling true onyx in appearance. The term onyx in connection with calcium carbonate or onyx marble is only the structural similarity with chalcedony onyx but not the composition. Used for carving, decorative, small ornamental objects and cladding building façades. Dyes very easily. Also called alabaster onyx, Algerian onyx, Mexican onyx, Mexican jade, Gibraltar stone, Egyptian alabaster, Oriental alabaster. → Cave onyx.

**onyx marble**; an erroneous term for banded stalagmite or travertine calcite. → Stalactitic marble.

**onyx obsidian**; a variety of parallel banded obsidian.

**onyx opal**; a common variety of parallel banded opal.

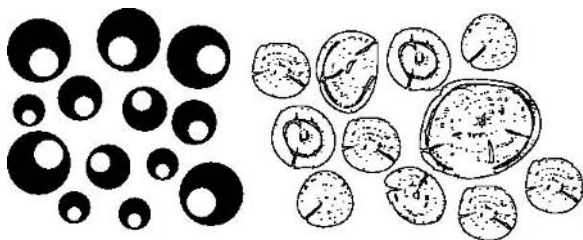
**onyx opal**; a misleading term for parallel banded opal.

**onzuiver**; a Dutch term for impure equivalent to imperfect.

**oölith**; a small grain of oölite. A sedimentary rock of spherical to ellipsoidal concretion of calcium carbonate, of 0.25 to 2 millimeter in diameter.

**oolite**; same as oölite.

**oölite**; an egg-like or spherical to ellipsoidal concretion of calcium carbonate, silica, chamosite, hematite, or limonite, of 0.25 to 2 millimeter in diameter around a nucleus of quartz or shell fragment. Usually showing a concentric-layered and/or a radiating fibrous structure



*left: oolitic aggregate and right: cross section through it*

with or without nucleus. Also called roe-stone. Also spelled oolite, ovulite, ooide, oölich.

**oölitic**; characteristic of oölite or pertaining to an oölite, or composed of oölite.

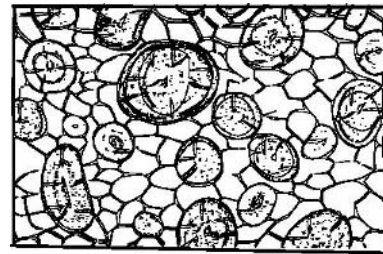
**oölitic iron ore**; another spelling of oolitic iron ore.

**oölitic limestone**; a spherical variety of limestone that consists of a concentric crust of calcium carbonate usually around a nuclei of a sand or a small organism. Also spelled oolitic limestone.

**oölitic opal**; a variety of opal where the iridescence or play-of-color is in circular areas, which may mean the opal has replaced coral or other organic substances.

**oolitic limestone**; same as oölitic limestone.

**oolitic structure**; a term applied to a sedimentary rock usually showing a concentric-layered and/or a radiating



*oolitic structure*

fibrous structure with or without nucleus.

**oolitic texture**; a term applied to a sedimentary rock consisting largely of oolites.

**oolitic texture**; a sedimentary rock consisting largely of oolites, which showing tangential contacts with each other.

**oolongolite**; a colorless, blue, deep blue bluish-green, and lilac synthetic stone of garnet structure with unknown chemical composition, singly refractive of RI:1.93-2.00. Dispersiom:0.030. SG:6.70-7.00. H:7½-8. Made in Switzerland.

**opacifier**; to become opaque in state by adding opacity material to a batch or paste.

**opacite**; a mass of microscopic opaque grains in the groundmass of a volcanic igneous rock.

**opacity**; property of being opaque, In pigment technique used as hiding power.

**opaco**; a Spanish spelling for opaque.

**opal**; a gemstone where the body may exhibit an iridescent play-of-color consisting of vivid prismatic colors, caused by light diffraction from minute spheres, of which the opal is composed, when light falls upon the stone. Usually occurs massive but often pseudomorphous after other minerals or fossils. Rough opals can be divided into principally of 4 varieties: (a) *black opal* includes those stone such as black, deep blue, green or gray body with bright flashes. (b) *White opal* includes opals with white or pale white body color and fine iridescence. (c) *Water opal* includes those colorless stones with brilliant flashes of color. (d) *Fire opal* included transparent to translucent, red to orange-red body color, which may or may not exhibit play of

color, fire opal in North America is known as *cherry opal*. Other varieties are: *precious opal* with about 6-10% water. Hydrophane is a pearly lustered, semitranslucent to opaque, white yellowish variety of opal. *Hyalite*, which resembles drops of melted glass or is like Müller's glass, when it exhibits a play-of-color is



*crystal and  
fissure  
inclusions in  
fire opal*

named *water opal*. *Müller's glass* is a glass clear hyalite variety of opal similar to melted glass. *Cachalong* is a reddish, opaque, poor variety of opal with porcelaneous or mother-of-pearl luster. *Menilite opal* is an opaque, dull, brownish or grayish, concentric banded variety of common opal. *Tabasheer opal* or opaline silica is an amorphous, translucent to opaque, white to bluish-white opal-like silica of organic origin found in certain species of bamboo. *Opalized wood* or *wood opal* is a variety of fossil, in which the opal replaces wood or replaces some prehistoric animals such as belemnites or pseudomorphous after calcite, gypsum and glauberite, which are known as *pineapple opal*. *Milk opal* is milk white, yellow, green color variety. *Jasper opal* is an opaque, red, yellow, reddish-yellow, or yellow-brown variety of common opal. *Potch opal* is opal variety of inferior quality, which may be colorful, but with little or no play-of-color found associated with the precious opal. A variety of black opal or black glass used as back of opal doublet, which is termed as *opalite*. *True opal*, when a thin fine true opal is grown on potch opal, which is cut and looks like a doublet but there is no distinctive join layer. When opal is mixed with ironstone and impregnates the roots of the gidgee tree (an acacia) called *gidgee opal*. Other varieties are liver opal, moss opal, rose opal, prase opal, cherry opal, resin opal, yellow opal, girasol, opal matrix, gidgee opal, pink opal, semiblack opal, crystal opal, contra-luz opal, Mexican water opal, Hungarian opal, vermillite opal, oölitic opal, chrysocolla opal, diatomaceous earth opal, tripoli, boulder opal, nobbies, and dendritic opal. The play-of-color in white opal can be improved by cooking opal in a sugar solution (or a black carbonaceous compound) and later treating it with sulfuric acid, which produce a black background due to carbonization of the sugar. Many white opals from Mexico are impregnated as

with a black plastic to enhance the effects. White and green fluorescence can be seen in SW or LW. Opal is cut cabochon, rarely is carved or faceted or engraved. Cut opals can be divided into principal varieties: (I) *Precious opal* or *noble opal* with brilliant iridescent color. (II) *Common opal*, which has a white, milky appearance and it without iridescence. Opal is hydrous and sometimes loses water and tends to crack. It is one of the *birthstones* for October. Iridescence or precious varieties of opal are fire opal, flash opal, pinfire opal, peacock opal, rolling flash opal, gold fire opal, blue opal, harlequin opal, lechosos opal, iron opal. Synthetic opals are produced in Japan and France. Imitations are made from various materials such as plastics, glass, etc. In medieval times it was known as: ophthalmius. Also called element stone, opaline. → Opal treated, precious opal, opal preservation.

System: amorphous (colloidal).

Formula:  $\text{SiO}_2 \cdot n\text{H}_2\text{O}$ . (up to 20%).

Luster: vitreous, pearly, waxy.

Colors: colorless, pale yellowish to yellowish orange, yellowish-brown, deep red to pale red, blue, gray, black, violet.

Streak: colorless.

Diaphaneity: transparent, translucent to opaque.

Cleavage: none.

Fracture: conchoidal to uneven. Brittle.

SG: 1.90-2.23.

H: 5½-6½.

RI: 1.44-1.47.

Dispersion: very low.

Found in Australia, Mexico, Indonesia, Honduras, Hungary, Tanzania, Poland, the Czech Republic, Brazil, Tanzania, and USA.

**opala**; a Portugesian spelling for opal.

**opal-agate**; a variety of banded agate consisting of alternate layers of opal and chalcedony with different shades of color. Also called agate opal.

**opal-allophane**; the term is used for a mixed stone of halloysite and variscite. Schrötterite is an obsolete term.

**opal as birthstone**; tourmaline and opal are widely accepted as birthstone for October.

**opal, black**; → black opal.

**opal cat's-eye**; any yellow, brown to green variety of opal containing white-golden to brown fibrous inclusions found in Yarra-Yarra Creek, Western Australia, exhibits chatoyancy, when cut cabochon. → Harlequin opal.

**opal cut**; usually opal is cut cabochon, rarely is carved or faceted or engraved.

**opal dendritic**; dendritic inclusion in opal is similar to some varieties of agate.

**opal dirt**; a miner term for opal-bearing grayish hard-

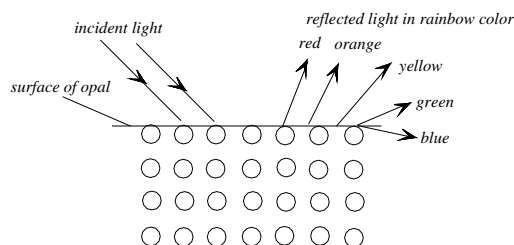
packed claystone or sandy clay, so-called *nobbies opals* are found in this stratum at Lightning Ridge, Australia.

**opal doublet**; an assembled stone, which imitate noble opal consisting of a thin piece of fine play-of-color opal backed with a slice of common opal, potch opal (little or no play of color), black glass (opalite), chalcedony, or black onyx, using a black adhesive. By examination with lens or microscope can be detected flattened bubbles. Sometimes a thin fine opal grown on potch opal is cut and misleadingly named as *opal doublet*, such a stone termed as *true opal*. Also known as *two piece opal*. The other doublet is joined opal to the brown matrix of ironstone with brown cement, which is termed as *ironstone opal*. A so-called *opal triplet* may have a cover of quartz cut cabochon. Opal triplet made from Australian opal is called *triplex opal*. Imitation of opal doublet are made of cemented pieces of rock crystal or glass over a thin slice of mother-of-pearl. Other imitations of composite stone are produced under the name *Schnapperskin triplet* with a red or blue coming from fish skin. → Opal triplet or triplex opal, potch opal.

**opal, dyeing**; a type of Australian opal, which has been stained black, to enhance the play-of-color. In this process, the stone is impregnated with a sugar solution or glucose, and then, it is treated with sulfuric acid, which produces a black background, due to the carbonization of sugar; this is known as *carbonizing*. Similar process used for Mexican opal. Stones can be discriminated by very fine pinpoints of play-of-color against a dark background, which appears peppery or speckled. → Black-dyed opal, black opal.

**opal essence**; an opal imitation made by Slocum Company, Michigan. It is made in various colored pieces from sodium-rich silicon glass containing some magnesium and calcium. It is fused together in the form of cabochon to imitate opals. RI:1.49-1.51, G:2.40-2.50, H:6. Also called *slocum stone*, while it was made by John S. Slocum of Michigan, USA.

**opalescence**; in optics a milky or pearly luster effect, which can only be seen in some common opals and a



*interference effect of white light from the opal surface in rain-bow color due to quasi ordered silica spheres in submicroscopical sizes*

milky shimmering phenomenon in some precious opals,

frequently with a bluish tinge caused by diffraction and interference of light from microscopic spheres of cristobalite within the stone. Same effect can be seen in moonstone and in the so-called opal glass. Using the term opalescence to the colors seen in various opals is not corrects. Not to be confusing with the play of color.

**opalescent**; related to or resembling opal in appearance or luster. Also called opaline.

**opalescent cat's-eye**; an unnecessary term for chrysoberyl cat's-eye.

**opalescent chrysolite**; a misleading term for green chrysoberyl.

**opalescent chrysolite**; a misleading term for corundum with opalescence effects.

**opalescent chrysolite**; a misleading term for chrysoberyl cat's-eye.

**opalescent glass**; glass with iridescent effects.

**opalescent glass**; a translucent common variety of glass with additional fluorite in its compound, having appearance of opal, used as an opal imitation.

**opalescent glass**; etched glass with hydrofluoric acid, which resembles the appearance of opal, used as an opal imitation.

**opalescent glaze**; milky glaze.

**opalescent sapphire**; a misleading term for sapphire cat's-eye.

**opal, gem**; opal exhibit an iridescent play-of-color consisting of vivid prismatic colors, caused by light diffraction from minute tiny uniform, innumerable submicroscopic spheres of cristobalites of 150-300 nm in diameter of amorphous silicium oxide (silica), arranged in closely packed, three-dimensional with tiny space between the spheres, which are occupied by air, water or silica with a slightly refractive index (IR). This effect in opal is known as play-of-color, not to be confused with fire or dispersion. Also called precious opal. → Play-of-color in opal, play-of-color.

**opal glass**; a misleading term for a translucent, milky-white or yellow glass, containing fluorine to the crown-glass melt. RI:1.44. SG:2.07. Used for imitation translucent gems and etched glass to imitate pearls but not for opal.

**opal gypsum**; same as opaline.

**opal horizon**; same as horizon.

**opal imitation**; imitations are made from various materials such as plastics, glass, etc. → Imitation opal, opal.

**opaline feldspar**; same as labradorite feldspar.

**opaline**; any mineral related to or resembling opal such as light-blue to bluish-white corundum with opalescent or girasol effects.

**opaline**; a variety of chalcedony shows an opalescent in yellow.

**opaline**; a brecciated impure opal pseudomorphous after serpentine.

**opaline**; a term applied to opal matrix.

**opaline**; a translucent, milky glass.

**opaline**; an obsolete term for an earthy form of gypsum. Also called opal gypsum.

**opaline**; same as opaline silica or tabasheer.

**opaline**; same as opalescent.

**opaline**; a magnesium rich variety of limestone.

**opaline silica**; same as tabasheer or tabasheer opal.

**opaline**; an obsolete term for an earthy form of gypsum. Also called opal gypsum.

**opalite**; any rocks with a matrix or groundmass consisting of opal.

**opalite**; a variety of red-banded opal colored by inclusions of cinnabar.

**opalite**; a variety of black glass or black opal, which are used as back of opal doublet. Also called myrickite.

**opalite**; an imitation opal is made of polystyrene plastic with RI:1.50-1.51, and SG:1.20. It look like lizard skin shrinkage cracks when viewed through microscope.

**opalite**; a term used for volcanic opal or mountain opal as distinct from sandstone silicas.

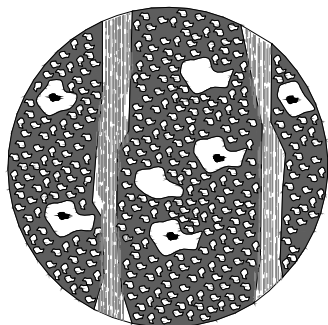
**opalized**; the remain of an organism preserved in an opal.

**opalized agate**; a variety of banded agate consisting of alternate layers of opal and chalcedony with different shades of color. Also called agate opal, opaline-agate.

**opalized bone**; opal replacing bone. → Fossil.

**opalized shell**; opal replacing shells or marine vertebrates. → Fossil.

**opalized wood**; a variety of fossil, in which the opal



*petrified opal  
from Lesbos,  
Greece*

replaces wood. → Fossil, petrified wood.

**opal jasper**; a translucent common opal of yellowish, greenish red, brown, or black color due to iron oxide. Also called jasper opal, jaspopal.

**opal, luminescence**; → luminescence of opal

**opal matrix**; opal piece with a portion of sandstone white matrix used to provide sufficient thickness of stone. Frequently found varieties of opal, these are mixed with siliceous ironstone, which is dark brown in

color, cut cabochon, or if impregnated by roots of the gidgee tree, known as *gidgee opal*. It is a kind of boulder opal. Found in Queensland, Australia. Cut cabochon and as beads. Also called Queensland opal matrix.

**opal, Mexican water**; → Mexican water opal.

**opal,-milky**; opal of milky color. Also called opal of milky color.

**opal mother**; same as opal matrix but darker in color from Hungary.

**opal neck**; an informal term used by Australian miners for the crack in the neck of a digging opal field.

**opal of milky color**; same as opal,-milky.

**opal onyx**; a misleading term for onyx opal.

**opal onyx**; precious opal from Honduras, which formed as thin bands in common opal.

**opal pipe**; a local term used in Australia for narrow pipe-like cavity filled by opal mineral.

**opal preservation**; opal sometimes loses water and may crack but when placed in mineral oil, glycerine, or water. These liquids have the tendency to prevent, but not cured its spider-web condition.

**opal structure**; by high magnification with X-ray photography and an electron-microscope the fine-structure of opal can be resolved, which shows a wide range of crystallinity of very small particles of cristobalite. → Bragg diffraction of light.

**opal, synthetic**; → synthetic opal, opal.

**opal thunder eggs**; a popular local term for a small opal geodes found in rhyolite lavas and tuffs in central Oregon, USA. Some shows a 5-pointed star, when cut into cabochon.

**opal, treated**; (a) improving poor quality opal by impregnation with a black carbonaceous compound *carbonizing* to give a black color to the stone, (b) or white opals from Mexico are impregnated with a black plastic to enhance the effect, (c) or soaking of poor quality stone in sugar solution or glucose and treating with sulfuric acid, later they are subjected to heat and carbonized, which produces the black background. (d) Some pieces of opal are placed in cinders, used motor oil, which is poured over and set fire. Such stones have color like a peculiar mosaic of patches, which resemble the structure of oolitic opal. → Treated opal.

**opal triplet**; → opal doublet

**opal white**; an iridescent opal, which has milky white or grayish background. Also called white opal.

**opal of milky color**; another term opal of milky color.

**opal without color play**; another term for common opal.

**opalo de fuego**; Spanish term for fire opal.

**opaque**; impenetrable to light. A stone is opaque, when light cannot pass through a thin-section of 0.04 mm. For example pyrite, cuprite, etc. → Transparent,

opacity, translucent.

**opdalite**; a hypersthene-biotite granodiorite from Opdal, Norway, used as cladding stone.

**open**; a term used by Australian miners to open a piece of rough opal at the field to check the quality of color.

**open bench mining**; a medley mining of open cast and underground. Also called bench mining or slot mining. → Open cast mining.

**open cast mine**; same as open cast mining.

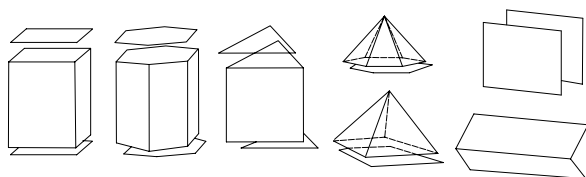
**open cast mining**; the extrusion of mineral or ore deposit in open daylight and mining from the surface. Also called open cut mining, open-pit mining, daylight mine, open working, open cut. → Open bench mining.

**open culet**; a culet of cut stone that is large enough to be visible to the naked eye.

**open cut**; same open cast mining.

**open cut mining**; same open cast mining.

**open form**; a crystal form that is open-ended such as



open form of crystals

hexagonal prism. → Prism, closed form, form.

**opening a diamond**; → opening a stone.

**opening a stone**; a trade term for polishing a small facet or window on rough gemstone or diamond to enable the interior study.

**opening the color**; a process of lightening dark blue and green Brazilian tourmaline by heat treatment. Also called *abrir a cor*. → Tourmaline, -heat treatment.

**open joint**; same as fissure.

**open out**; a term used by Australian miners for yielding more as the seam widens.

**one-piece-jade**; → Emerald Buddha.

**open pit mining**; same as open cast mining.

**open setting**; a style of gemstone mounting that the facets of the pavilion or lower part are exposed to light from the sides.

**open star**; during cutting an oval cabochon, when one ray is parallel to the width of the oval cut form, it produce an attractive star effect. Star rubies and star sapphires are cut as low cabochon because of greater effect of star. → Closed star.

**open table**; a brilliant-cut diamond or other gemstone with table facet larger than normal more than 65% the diameter of the girdle. Also called spread or swindled.

**opera length**; generally length of a pearl necklace is about 70-75 cm, double that of a choker. The length may vary. Also called opera necklace.

**opera necklace**; → opera length.

**operculum**; the calcareous horny or shell-like closure flap or lid of the univalve shellfish, of a gastropod, *Turbo petholatus*, found in South Sea north of Australia or Indo-China. *Turbo petholatus* is a genus of *aspidobranchia*, which is similar to a snail in appearance. SG:2.70-2.76. H:3½. Used in the Far East as jewelry, as necklaces, eyes, bracelets, ear-ring, brooches, etc. and marketed under the name *shell cat's-eye*, *Chinese cat's-eye*, *Guadalcanal cat's-eye*, or *Pacific cat's-eye*. Some samples is called eyestone.

**ophicalcite**; a clouded green to white recrystallized (metamorphism) limestone containing serpentine and calcite. RI:1.56. SG:2.48-2.77. H:3. Also called ophicite, ophite, Irish green marble or Connemara marble.

**ophicite**; a serpentine marble. Same as ophicalcite.

**ophiolite**; a honey yellow to green, massive variety of serpentine with resinous luster. → Serpentine.

**ophiolite**; a group of dark colored, mafic or ultramafic igneous rocks and pelagic sediments.

**ophite**; a serpentine marble. Same as ophicalcite.

**ophthalmius**; an old medieval term for opal. → Opal.

**Oppenheimer Diamond**; an uncut, light yellow, octahedral diamond crystal of 253.70 cts, found in 1964 in Dutoitspan Mine, South Africa. It was owned by Harry Winston and presented to Smithsonian Institution, Washington, D.C., USA, in memorial of Ernest Oppenheimer. Also called Dutoitspan diamond.

**opsianus**; an ancient term for an amulet stone made of jet.

**optic**; the study of or relating to the nature of light. → Optical.

**optical aberration**; → aberration.

**optical activity**; the property or ability of certain crystals to rotate the plane of polarization of light, as it passes through them, for example quartz crystal. When the rotation is clockwise the optical activity is known as right-handed (quartz), when anticlockwise, is known as left-handed (quartz). Also called optical rotation, circular polarization. optically active, rotation polarization.

**optical anomaly**; an unusual phenomenon, in which a single refractive crystal or a diamond has an irregular optical properties such as anomalous double refraction. This effect can be seen in most synthetic spinel.

**optical axis**; a term used in crystallography to the direction of an anisotropic crystal along which there are no double reflection.

**optical axis**; the path of light passing through the nodal

points of a spherical lens.

**optical calcite;** a pure, transparent, colorless calcite crystal that has value for optical uses such as Nicol prism.

**optical character;** same as optic character.

**optical character of plastics;** show snake-like bands or strain. → Plastics properties.

**optical contact;** a drop of special immersion liquid placed between the crystal surface and refractometer glass to make optical contacts. The distance between the two surfaces is less than a wavelength of light.

**optical crown glass;** glass of low dispersion, and colorless suitable for use as optical equipment, such as crown or flint glass. Also called optical glass.

**optical crystal;** any large crystal, either natural or synthetic, used in short-wave radiation, piezoelectric effect, infrared, and ultraviolet optic detection.

**optical crystallography;** the study of the properties of light in a crystal.

**optical density;** in optics, when a medium has a larger refractive index than other medium for light of a given wavelength, then it has the larger optical density for that wavelength. Also called transmission density.

**optical density;** a degree of opacity of translucent material defined as logarithm of the opacity. It affects luster, scintillation, brilliance, and refractive index.

**optical enlargement;** magnification of image by optical devices. Also called magnification, magnification image, image enlargement.

**optical flint glass;** same as flint optical glass.

**optical flat;** → interference test in a thin film.

**optical glass;** same as optical crown glass.

**optical indicatrix;** → indicatrix.

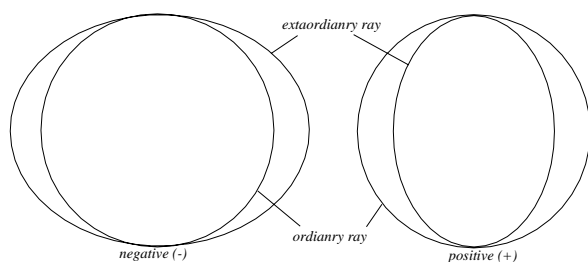
**optical interference;** → interference of light.

**optical micrometer;** → micrometer.

**optical microscope;** a device used to obtain an enlarged image of a minute object that utilizes visible light for illumination. → Microscope.

**optical mineralogy;** study or description of mineral properties by optical instruments.

**optical negative;** an anisotropic mineral of uniaxial crystal, in which the refractive index of the



*uniaxial crystal in positive and negative*

extraordinary ray ( $\epsilon$ ) is less than the refractive index of ordinary ray ( $\omega$ ). And in biaxial crystal the intermediate refractive index  $\beta$  is near to  $\chi$  than  $\alpha$ . For example tourmaline is uniaxial negative. Also called optically negative. → Negative crystal, optical sign.

**optical phenomenon;** same as phenomenon.

**optical positive;** an anisotropic mineral of uniaxial crystal, in which the refractive index of the extraordinary ray ( $\epsilon$ ) is greater than the refractive index of ordinary ray ( $\omega$ ). And in biaxial crystal the intermediate refractive index  $\beta$  is near to  $\alpha$  than  $\chi$ . For example topaz is biaxial positive. Also called optically positive. → Optical negative, positive crystal, optical sign.

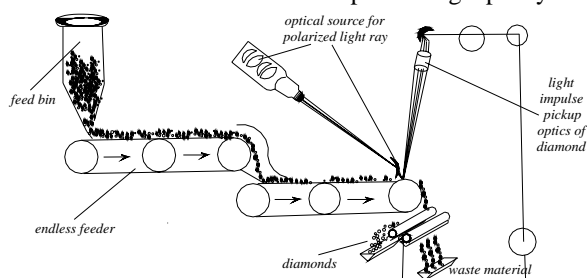
**optical prism;** → prism, optical.

**optical properties;** the effect of a transparent crystal or medium upon light or other electromagnetic radiation passing through it. They are; refractive index, absorption, double refraction included birefringence, polarization, interference figure, optic orientation, dispersion, pleochroism, and color.

**optical pyrometer;** an optical instrument to determine the high temperature by measuring the luminous radiation or color.

**optical rotation;** → optical activity.

**optical separator;** an apparatus designed to separate diamond from crushed rock by record the difference between the light reflecting properties of worthless material and diamonds. Rocks possessing opacity but



*optical separating and recovery device for diamond*

diamonds are characterized by reflection and transmission. Such a separation machine works using photoelectric cells.

**optical sign;** optically double refractive crystals are classified into uniaxial or biaxial and negative or positive. Also called optic sign. → Optical negative, optical positive.

**optical spectrometer;** an accessory tube containing a scale on nanometer or Ångström unite, used to measure the particular wavelength of light or refractive index of a prism, which is installed in spectroscope.

**optical spectroscopy;** → spectroscopy.

**optical spectrum;** → spectrum.

**optical system;** same as lens system.

**optical system;** an assembly of lenses, mirrors or other devices, so arranged that the desired optical result such as reflect, refract, absorb, disperse, polarize, or otherwise act on light are secured. Also called lens system.

**optically active;** same as optical activity.

**optically negative;** in crystal optics a birefringent mineral, in which the refractive index of the extraordinary ray is less than the refractive index of ordinary ray. Also called optical negative.

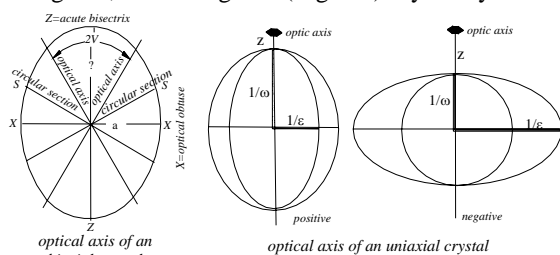
**optically positive;** in crystal optics a birefringent mineral, in which the refractive index of the extraordinary ray is larger than the refractive index of ordinary ray. Also called optical positive.

**optic angle;** the angle between the two optic axis in biaxial crystal with the symbol  $2V$ , when determined in immersed crystal, or the symbol  $2E$ , when measured in air (not immersed). Also called optic axial angle.

**optic axes;** plural of optic axis.

**optic axial angle;** same as optic angle.

**optic axis;** that direction in an anisotropic or doubly refractive crystal, in which both the ordinary and the extraordinary rays are propagated with same velocity, along this direction there is no double refraction. In tetragonal, and hexagonal (trigonal) crystal system it is



optical axis of cubic, uniaxial and biaxial crystal. Acute bisectrix and obtuse bisectrix

parallel to threefold, fourfold, six fold symmetry axis and are described as *uniaxial*. In orthorhombic, monoclinic, and triclinic crystals system there are two optic axes, which are known as *biaxial*. The angle between two axis is known as  $2V$ , when determined in immersed crystal, or the symbol  $2E$ , when measured in air (not immersed). → Optic angle.

**optic character;** the specific optical properties of gemstones, the optic sign of uniaxial or biaxial crystals.

**optic normal;** an imaginary line drawn perpendicular to the interface between the two media at the point of incidence of a light, in such a case the incident ray strikes the surface perpendicular.

**optic plane;** an imaginary XZ plane drawn perpendicular to the interface between the two optic axes lie. → Optic axis.

**optic disc;** the small circular area in the retina of eye, which converged the fibrous from the ganglion cell to form the optic nerve. → Eye.

contractile opening in the iris of the eye to determine the amount of entering light. → Eye.

**optic sign;** same as optical sign.

**opticon;** a colorless polymer epoxy plastic used as an impregnation to improve stones such as emerald.

**optics;** the study of the nature of light.

**orange;** a term used for orange color of opal.

**orange diamond;** a fancy red-orange to orange-brown color diamond.

**orange flash;** filled fractures of diamond shows interference by testing under dark-field illumination. → Revealing fracture filled diamond.

**Orange Free State;** location of an important diamond deposit in South Africa.

**Orange Pearls, The;** three strings of pearls together with two pearl ear-rings made up in 1703, inherited by King Frederick I of Prussia from his mother, Louisa Henrietta of Orange. Present owner unknown.

**orange peel;** a term applied to an overheating amber which caused upper layers to melt and formed as a pitted or rippled feature at uneven surface similar to orange peel.

**orange peel;** a term applied to glasses used to imitate gems such glass is slightly pitted or rippled at uneven surface similar to orange peel.

**Orange River;** a border river between Namibia and South Africa. There are sources of numerous alluvial diamond deposits located along the river.

**orange shellac;** → shellac.

**Orange Tiffany Diamond;** same as Tiffany Diamond.

**orange topaz;** a misleading term for orange to orange-red citrine crystal. Also called Spanish topaz.

**orangite;** a light orange-yellow variety of thorite  $\text{ThSiO}_4$ , which resembles zircon.

**Oranjemund;** location of a diamond mining and a town near the mouth of the Orange River, Namibia, Africa. Operated by CDM.

**Oran marble;** a town in Algeria where fine onyx marble from Roman times is quarried.

**Orapa Diamond Mine;** location of large kimberlite diamond pipe in the area of Orapa on the eastern edge of Kalahari Desert, Botswana, Southern Africa. Also called Orapa Mine, Orapa Pipe.

**Orapa Mine;** same as Orapa Diamond Mine.

**Orapa Pipe;** same as Orapa Diamond Mine.

**Oratorium of Charlemagne;** a reliquary made of pearls, precious stones and an aquamarine intaglio of Julia set at the apex of it. Once belonged to Charlemagne, who presented it to Abby of St. Denis. Now on display at the Cabinet des Médailles, Paris,



France. → Julia Portrait.

**o-ray**; an abbreviation for ordinary ray.

**orb**; spheres or globe.

**orbicular**; same as spheroid.

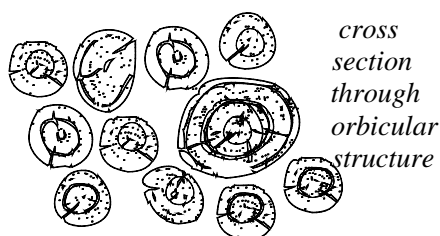
**orbicular**; same as orbicular structure.

**orbicular diorite**; a granular igneous rock containing an abundance of megascopic spheroidal minerals, mostly dark silicates such as hornblende found in Corsica Island, France. Also called hornblende gabbro. → Diorite.

**orbicular granite**; a granite containing abundance of megascopic spheroidal minerals, mostly dark silicates. → Granite.

**orbicular jasper**; a variety of translucent jasper containing white, gray, brown, red, or black spherical inclusions in a black, white, yellow or red matrix. It is a material consisting of petrified wood. Mainly contrasting colors of orbicular inclusions are caused by iron oxide. Found in California, USA. Sometimes called poppy stone. Used as ornamental stone.

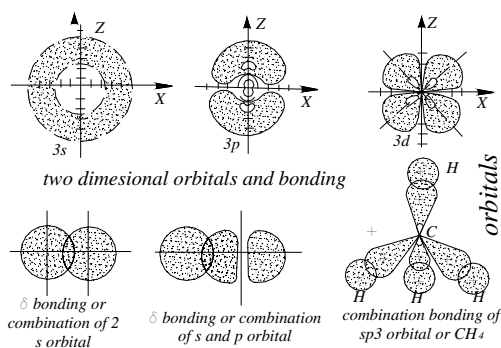
**orbicular structure**; a rock containing an abundance of



phenocrystalline spheroidal inclusions, generally in concentric shells for example orbicular diorite or granite.

**orbicular structure**; having the spheroidal shape. Also called orbicular.

**orbital**; a space in which an electron may be found in an



atom or molecule in an approximation such that each electron has a definite wave function, independent of the other electrons.

**Orchid Diamond**; reportedly a pink-lavender color diamond crystal of 30.45 cts, it was fashioned into an

emerald cut of 9.93 cts, by Lazare Kaplan, New York City, USA. It was sold in 1940 to a private buyer. Present owner unknown.

**Orchomenos**; an ancient location for carbuncle garnet, which is named by Theophrastus from Orchomenos in Greek.

**Order of St. George**; a garniture of Bavarian Imperial Family composed together with Imperial sword and other objects in Munich, Germany. In which also set some emeralds.

**ordinary and rejected cleavage**; miners shapes grading classification for poor quality of minute misshapen rough diamond crystal or a broken piece followed only by flats, macles, rubbish, and bort.

**ordinary index**; same as ordinary refractive index.

**ordinary light**; the vibrations of ordinary light take place in any directions perpendicular to the direction of propagation of the light such light known as *unpolarized* light. → Ordinary ray, plane polarized light.

**ordinary ray**; that ray, in a uniaxial crystal belonging to the hexagonal and tetragonal systems, the refractive index or velocity behaves like any ray in an isotropic material, it travels with the same velocity in any direction in the stone. Also called ordinary wave. Abbr.: o-ray or  $\omega$ . → Double refraction, extraordinary ray, optic sign, Nicol prism. Also called ordinary light.

**ordinary refractive index**; same as the refractive index of ordinary ray in a cubic crystal.

**Ordovician**; the middle period in the lower Paleozoic era. It overlies the Cambrian period and is succeeded by the Silurian. It covered the span of the time of 500-430 million years ago with the corresponding system of rocks.

**ore**; usually a mineral or rock that be potentially valuable.

**ore bearing**; same as ore containing.

**ore capping**; same as capping.

**oregonite**; same as kindradite. Not to be confused with oregonite a hexagonal mineral of nickel-iron arsenide.

**Oregon diamond**; a misleading term for quartz crystal from Oregon, USA.

**Oregon jade**; a misleading term for green quartz, jasper or chalcedony, found in Oregon, the USA.

**Oregon jade**; a misleading term for massive grossular garnet from Oregon, USA.

**Oregon jade**; a misleading term for massive vesuvianite from Oregon, which is known as californite.

**Oregon moonstone**; a misleading term for chalcedony moonstone.

**Oregon opal**; common opal from Oregon.

**ore pass**; a vertical or inclined passage for the downward retrieval of ore by gravity.

**ore separator;** any device such as cradle, frame, jiggling machine used in separating the metal from broken ore.

**O'Reilly Diamond;** same as Eureka Diamond.

**organ pipe fluorescence;** the emission spectrum of synthetic red spinel shows rather close lines by using of LWUV light.

**organ pipe spectrum in spinel;** a group of several shallow absorption lines (more than 10) seen in the red, which occur like a set of organ pipes they can be seen in natural spinel observed under UV light.

**organic;** substances derived from living or once-living organisms, plant or animal, which contain carbon compounds.

**organic gem materials;** naturally occurring organic gems such as pearl, coral, shells, amber, jet, ivory, fossil ivory, vegetable ivory, etc.

**organic pigments;** any organic chemical base seen in organic gems, which caused the color such as in coral or amber.

**orient;** the minute characteristic iridescent luster of the surface of a gem-quality pearl caused by diffraction and interference of light reflected from the thin surface of plates of nacre. The orient is the nuance of color seen as reflected by a diffuse light source. Pearls with a fine orient are frequently known as *ripe*, those of inferior quality are known as *unripe*. Not to be confused with luster. Also called orient of pearl.

**Orient;** a piece of pearl with excellent iridescence luster. → Pearly luster.

**oriental;** a misleading term used as a loose prefix for the name of some gemstones that have similar color to other stones for example *oriental amethyst* is a violet sapphire.

**oriental;** an unnecessary term used to express the genuineness of a gemstone from the East.

**oriental;** an unnecessary term used for gemstones from the East. See below under oriental terms.

**Oriental;** a term used in past to express the superior hardness and genuineness of corundum gemstone from the East such as *oriental ruby* a general ruby, *oriental sapphire* a general sapphire, *oriental emerald* a green sapphire, *oriental topaz* a yellow sapphire.

**oriental agate;** transparent to translucent variety of agate.

**oriental alabaster;** a misleading term for a parallel banded calcite in the form of stalagmitic or onyx marble occurring in Algeria, and Egypt. Also called Egyptian alabaster. → Onyx marble. Not to be confused with the fashioned alabaster, which is a sulphate stone.

**oriental almandine;** a misleading promotion term for purple-red variety of corundum.

**oriental almandine;** a misleading commercial term for

any precious amethyst from the East.

**oriental amethyst;** a misleading term for violet to purple corundum or sapphire.

**oriental amethyst;** any amethyst of fine-quality from East.

**oriental aquamarine;** a misleading term for light blue to green varieties of corundum or sapphire.

**oriental baroque;** a commercial term used for salt-water pearl from orient.

**oriental beryl;** a misleading term for emerald-colored sapphire.

**oriental carnelian;** a term applied to deep colored carnelian.

**oriental cat's-eye;** a synonym for a variety of cymophane a variety of chrysoberyl.

**oriental cat's-eye;** a misleading term for girasol corundum or sapphire.

**oriental chalcedony;** a translucent, fine-quality of chalcedony cut cabochon.

**oriental chrysoberyl;** a misleading term for yellowish-green variety of sapphire.

**oriental chrysoberyl;** an unnecessary term for yellowish-green variety of chrysoberyl.

**oriental chrysolite;** a misleading term for yellowish-green variety of corundum or sapphire.

**oriental chrysolite;** a misleading term for yellowish-green variety of chrysoberyl.

**oriental diamond;** a historical name that was used to distinguish Indian diamonds from Brazilian diamonds.

**oriental emerald;** a misleading term for dark-green variety of corundum or sapphire that resembles an emerald.

**oriental garnet;** a gem variety of almandine garnet.

**oriental girasol;** same as girasol sapphire or same as sapphire cat's-eye.

**oriental hyacinth;** a misleading term for orange-red to reddish-brown variety of corundum or sapphire.

**oriental jasper;** same as bloodstone.

**oriental jasper;** an early term for heliotrope that resembles jasper.

**oriental moonstone;** a term applied to genuine moonstone as distinguished from another misnamed moonstones.

**oriental moonstone;** a misleading term for girasol corundum or sapphire.

**oriental onyx;** a misleading term for translucent, banded, spotted travertine.

**oriental opal;** any precious opal from the East.

**oriental opal;** an obsolete term for Hungarian opal, which was merchandised through orient markets.

**oriental pearl;** the highest quality of natural pearl from pearl oyster genus *Pinctadine* of salt-water bivalve mollusks found in Persian Gulf, and sometimes

extended to Red Sea and the Gulf of Mannar between Sri Lanka and India.

**oriental pearl;** the term is used to distinguish oriental natural pearls from pearls fished elsewhere and sold in India.

**oriental peridot;** a misleading term for olive-green variety of corundum or sapphire.

**oriental ruby;** same as Myanmar, (Burma) or Thailand rubies.

**oriental ruby;** an unnecessary term used to distinguish genuine ruby from various types of substitute ruby.

**oriental sapphire;** a promotion term for blue sapphire from Myanmar, (Burma).

**oriental sunstone;** an obsolete term for oriental girasol.

**oriental sunstone;** a misleading term for reddish yellow variety of corundum or sapphire.

**oriental synthetic alexandrite;** a misleading term for synthetic alexandrite, which is not a true synthetic alexandrite.

**oriental topaz;** a misleading term for yellow variety of corundum or sapphire.

**oriental topaz;** a misleading term for yellow variety of corundum or sapphire from India. Also called Indian topaz.

**oriental turquoise;** a term used for true turquoise to it distinguished from various types of substitutes.

**oriental vermeille;** an unnecessary term for red-brown corundum.

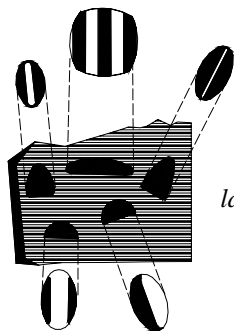
**orientated cat's-eye;** same as oriented cat's-eye.

**orientated overgrowth;** same as epitaxy.

**orientation;** → orientation crystal.

**orientation crystal;** the placing of atoms or radicals in a crystal so that they point in a definite direction, or its crystallographic axes are in the conventional position.

**orientation of cut stone;** the placing of exact cut



*orientation of cut-stone with layers of tiger-eye.*

*After Fischer 1989*

direction of tiger-eye with layer position of stone.

**oriented cat's-eye;** a synonym for a variety of cymophane a variety of chrysoberyl. Also spelled orientated cat's-eye.

**orientated specimen;** a term used in petrology for a hand specimen with an exact arrangement in space is

known.

**orient of pearl;** same as orient.

**origin;** same as source.

**origin of pearl;** → pear, origin of.

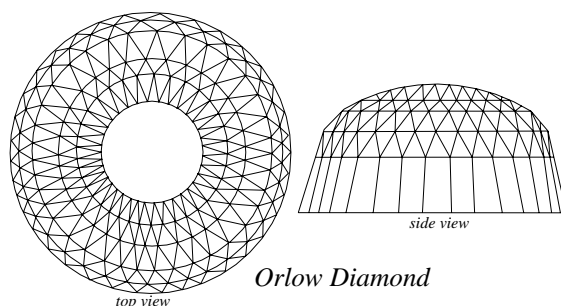
**Orissa Mine;** an ancient source of cinnamon-brown to light-brown grossular near Kodurite, Genjam district, India.

**Orleans paste;** a glass of fine-quality Made by Homberg and Orleans in Palais Royal, Paris, France. Used as a gem imitation.

**Or-I-Noor Diamond;** same as Dewey Diamond.

**orletz;** a Russian term for rhodolite.

**Orloff Diamond;** a white, slightly bluish-green, irregularly shaped half small egg, rose cut on top and flat faceted on base of 189.62 cts, from India. Believed that it is a part of Great Mogul Diamond, or according to another report, it was originally in the eye of the



Hindu god Sri-Ranga in a temple at Srirangam, Madras. It was stolen by a French soldier, and then owned by Gregory Gergorievich Orloff in Amsterdam in 1775 (whose name is engraved on it) and presented to Empress Catherine II of Russia. It was mounted in the top of the golden eagle in the Imperial Scepter (British English Scepter). It is now in Russian Diamond Fund in the Kremlin, Moscow, open to the public. Also spelled Orlov Diamond, Orlow Diamond.

**Orlov Diamond;** same as Orloff Diamond.

**Orlow Diamond;** same as Orloff Diamond.

**ormer;** same as ormer shell.

**ormer shell;** a pearl bearing salt-water shell of genus *Haliotis tuberculata* from Channel Island, also used as an ornamental objects. Also called abalone.

**ornament;** any adornment.

**ornamental stone;** minerals or rocks, which are attractive for the beauty of their surface colors but not useful in jewelry but valued for carving and fashioning into decorative or ornamental objects, such as ash trays, figures, etc. Examples are malachite, jade, serpentine, marble, lapis lazuli, agate, etc. Finer varieties of these minerals employed in jewelry as cabochon, beads, cameos, etc.

**ornate plaster;** same as ornament polish.

**ornoite**; a variety of hornblende diorite, used as cladding stone.

**orpiment**; a lemon yellow to orange monoclinic crystal of  $As_2S_3$ , which occurs as inclusion in forcherite or colloidal opal.

**Orpin-Palmer Diamond**; reportedly a dull-white alluvial diamond of 117.50 cts, found in 1902 on the Vaal River Estate, Cape Province, South Africa. Present owner unknown.

**orthite**; another term for allanite.

**ortho**; a prefix which means straight or at right angles.

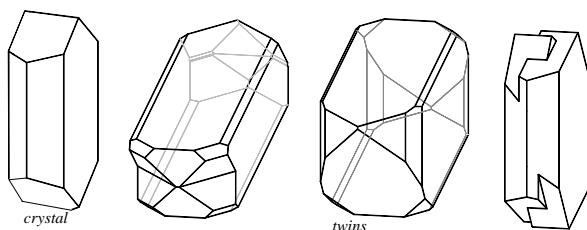
**ortho**; an abbreviation for orthochromatic.

**orthoamphibole**; an inosilicate mineral of the amphibole group crystallized in orthorhombic crystal class with double chain in structure such as nummrite.

**ortho axis**; in the monoclinic system the lateral axis, which is perpendicular to the other two axes. Same as *b*-axis.

**orthochromatic**; photographic sensitive emulsions, which register visual luminosities correctly, such emulsions are sensitive to all colors except red color. Frequently spelled only ortho.

**orthoclase feldspar**; a tectosilicate mineral of the feldspar group dimorphous with microcline. Used as a gemstone. *Adularia* is a colorless and transparent variety of orthoclase, their sheen is known as *adularescence* and is caused by alternate layer of albite



*orthoclase crystal and twins*

and orthoclase within the stone. These layers spread the light falling on the surface of cabochon. The fine reflected ray from the surface of stone is bluish to whitish silvery schiller, which is called *Rayleigh scattering*. A blue schiller variety is known as *moonstone*. Cat's-eye varieties are found in Myanmar. *Sanidine* is a polymorphous, glassy variety of orthoclase identical in chemical composition with it. Erythrite, sanidine, and murchisonite are varieties. Spectrum strong at 420 nm line and bands at 445 nm, and 420 nm. Weak blue in LW ray or orange-red in SW ray. Also called pegmatolite, common feldspar, orthose, nekronite, cottaite, and felsite. → Perthite feldspar, antiperthite.

System: monoclinic.

Formula:  $8[KAlSi_3O_8]$ .

Luster: vitreous to pearly.

Colors: colorless, pale yellowish to yellow, white, pink, rose, brown-red, pale green.

Streak: colorless.

Diaphaneity: transparent to translucent.

Cleavage: {001} perfect, {010} less perfect, and {110} distincts.

Fracture: conchoidal to uneven. Brittle.

SG: 2.55-2.63.

H:6.

Optics;  $\alpha$ :1.518-1.529,  $\beta$ :1.522-1.533,  $\gamma$ :1.522-1.539.

Birefringence: 0.005-0.009.  $\ominus$ .

Dispersion: 0.012.

Gem varieties are found in Myanmar, Sri Lanka, Greenland, Switzerland, Malagasy, Norway, Canada, and USA.

**orthoclase cut**; transparent and yellow varieties are cut as brilliant or emerald cut, which resemble yellow beryl and are prized by collectors.

**orthoclase imitation**; substitute material that can imitate orthoclase or nearly moonstone with the same effect are: opalescent glass, white chalcedony that exhibits a light blue schiller, when cut cabochon also milky quartz, synthetic spinel that has been reheated or some amethyst showing moonstone effect by heat-treatment.

**orthoclase moonstone**; → moonstone.

**orthoferrosilite**; a variety of enstatite.

**orthopyroxene**; any several pyroxene minerals that crystallize in orthorhombic system.

**orthoquartzite**; a term used for quartzite sandstone.

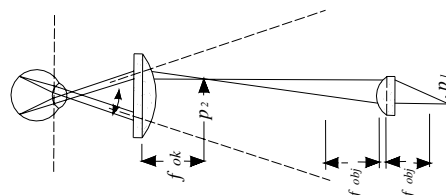
**orthorhombic**; same as orthorhombic system.

**orthorhombic mineral**; mineral of the orthorhombic system.

**orthorhombic stone**; stone of the orthorhombic system.

**orthorhombic system**; one of the six crystal systems, which is characterized by three crystal axes that are mutually perpendicular and all of unequal lengths. Old synonyms are: prismatic system, trimetric system, rhombic system.

**orthoscope**; a polarizing microscope used in mineralogy or metallurgy in which light is transmitted by a crystal that is parallel to the microscope axis.



*orthoscope passing light*

**orthose**; a popular term for transparent, yellow

orthoclase from Malagasy. Same as orthoclase.

**orthose**; same as orthoclase.

**orthose ferrique**; same as ferri-orthoclase.

**orthosilicate**; now an obsolete classification of a group of silicate structures of  $H_4SiO_4$ .

**ortho-toluidine**; a fluid used for immersion refractive index tests. RI:1.57.

**Ortlepp Diamond**; a small uncut triangular-shaped diamond believed to be one of the first diamonds found in Kimberly. It was found in 1869 by Mrs. Sarah Ortlepp. Now it is on display at the African Museum in Johannesburg, South Africa.

**Os**; a chemical symbol for the element osmium.

**oscillation**; a variation that moved periodically backward and forward between two values. Also called parametric amplification.

**oscillator crystal**; a piezoelectric crystal is suitable for used in manufacture of oscillator to control the frequency of oscillation.

**oscillator, quartz**; natural or synthetic quartz crystal of sufficient high quality and size used in manufacture of oscillator plates to control the frequency of oscillation.

**oscillatory extinction**; → undulatory extinction.

**oscillatory twinning**; parallel, polysynthetic twinning.

**osmenda pearl**; same as coque de perle.

**osmiridium**; a white native alloy of iridium and osmium. Cubic mineral. Also called iridosmine.

**osmium**; an extremely hard, white-grayish blue metallic element of the platinum group with the symbol Os. Used as a hardener in alloys.

**ossannite**; same as riebeckite

**osseous amber**; a variety of whitish-yellow to brown cloudy amber containing numerous of small bubbles having appearance of dried bone and does not polish as well. It is divided into two varieties: osseous-clear amber and osseous-bastard amber Also called bone amber, bony amber.

**osseous-bastard amber**; → osseous amber.

**osseous breccia**; same as bone breccia.

**osseous-clear amber**; → osseous amber.

**osteodentine**; a bony variety of ivory dentine structurally resembling bone.

**Ostrea**; same as *Ostrea edulis*.

**Ostrea edulis**; a common variety of non-nacreous edible oyster. Also called *Ostrea*.

**Ostreidae**; a family of bivalve mollusks that contain oyster.

**osumilite group**; a group of minerals of cyclosilicates, to which belonged milarite, sogdianite, and sugilite.

**Otariidae**; the sea lions, a family of carnivorous marine mammals in the carnivore suborder Caniforma.

**other-colored**; same as allochromatic.

**o-toluidine**; same as ortho-toluidine.

**Otto Borgstrom Diamond**; an octahedral, yellowish diamond of 121.50 cts, found in 1907 in Gong Gong on the Vaal River Estate, Cape Province, South Africa. Present owner unknown.

**Ottoman Diamond**; same as Turkey I Diamond.

**Otto's Kopje**; location of a small circular shape diamond pipe in the Kimberly area, Cape Province, South Africa.

**Ottosdal G stone**; in South Africa a term for a dark gray stinky looking rock consisting mostly of pyrophyllite. Found near the village Ottosdal in western Transvaal. Used as ornamental stone, cut cabochon, carving objects and in synthetic diamond industry as a container. RI:1.58. SG:2.72. Variety from Transvaal, is known as *South African wonderstone*, *Koranna stone* and those From China agalmatolite.

**ottu sapphire**; a commercial term used in Sri Lanka for a waterworn blue sapphire with a parti-colored appearance, after cutting these stones show a fine blue color, when viewed from the top this is caused by internal total reflection, but if viewed from sideways are found to be colorless, some cutters fashioned the stone with the blue color at base. Similar stones are found in India.

**ouachita stone**; same as novaculite from Ouachita, Arkansas, USA.

**oukiou**; a Mongolian term for emerald.

**ounce, Avoir**; a unit of weight used for merchandise equivalent to 28.349 grams or 141.747 cts. Also called Avoirdupois weight.

**ounce, troy**; once a unit of weight for weighing noble metals  $1/12$  troy pound. → Troy weight.

**Ouro Preto**; location of a gem-bearing deposits in Minas Gerais, Brazil.

**outburst**; same as eruption, rupture, blast, blowout.

**outer transition elements**; eight metallic elements of Periodic System with the name transition elements beginning from atomic number 22 titanium to 29 copper are involved with 3d electrons. Those transition elements involving with 4d electrons starting with Zr and ending with silver, and those involving with 5d electrons starting with Hf and ending with Au. These three rows of Periodic System named as *outer transition elements*. Because of color in these elements involving with transitions between d-orbitals to create light absorptions are called d-d colors, d-d absorptions and d-d transitions.

**outline**; outer limits of a figure, body or cut-gemstone. Also called contour, form-line.

**out-of-round diamond**; described any round brilliant-cut diamond or other gemstones that does not have a truly regular girdle diameter visible to the eye.

**out-of-round girdle**; → out-of-round diamond.

**Outokumpu;** location of a green emerald deposit in South Africa.

**outrider;** almandine garnet is an example of spectrum lines or bands that are different from complete garnet main group. Almandine garnet has a weak band in the orange at 617 nm and another band in the blue at 462 nm.

**outside goods;** diamonds that are sold outside the Central Selling Organization.

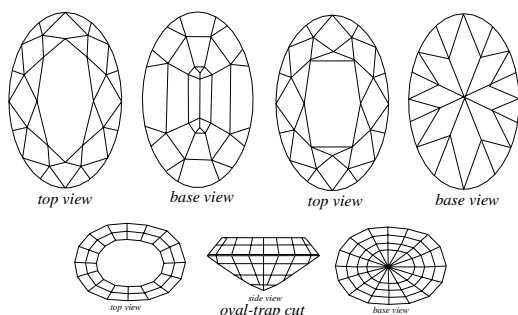
**ottu-type;** blue sapphire from Sri Lanka with a blue skin surrounded a colorless core seen in some uncut stones.

**ouyou;** a Manchurian term for emerald.

**ouvarovite;** another spelling for uvarovite.

**oval brilliant cut;** same as oval cut.

**oval cuts;** a modern variant of brilliant cut of the 57-



three oval cuts

facets (may more or less), with an elliptical girdle outline. Also called oval brilliant cut.

**oval cut;** an obsolete term for a barrel-shaped modification of brilliant cut.

**Oval Elegance;** a commercial term for a 58-facet oval cut.

**Oval Faceted Aquamarine;** an oval carved aquamarine bowl of 492 cts. Now on display at Kunsthistorisches Museum, Vienna, Austria.

**oval marquise;** a term applied to a modification of marquise cut where the boat-shape out-line has blunted rather than pointed ends.

**oval setting;** modification of setting of transparent solitaire gemstone or diamond in a finger ring in oval shape similar to Tiffany setting.

**oval trap cut;** → oval cut.

**ovate;** same as egg-shaped, ovoid.

**over-bleached pearl;** pearl, which has been over bleached by lightning or treating.

**Ovalum Pally Mine;** location of an old diamond mine in the Madras district, India. Also called Woblapally Mine.

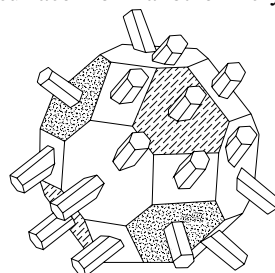
**overblue;** a polished or rough diamond that has strong blue fluorescence, which therefore has a blue body color appearance in daylight.

**overburden;** uneconomic material such as soil, sand,

gravel, rocks, etc., which lies above gem-bearing or valuable bedrock. It must be removed before mining can begin.

**overgrowth;** the deposition of a thin secondary layer of calcium carbonate on some rough diamonds, which sometimes stocks them from adhering to grease table by separation process.

**overgrowth, oriented;** growing of a certain crystal over the surface of another crystal of not similar



oriented overgrowth of ZnO on ZnS. After Niggli 1941

composition. Overgrowth can be seen in sedimentary, diagenetic and metamorphic rocks. → Distaxy, epitaxy, authigenic overgrowth, Lechleitner synthetic emerald.

**overlay work;** basically nearly the same as true inlay work. Generally is made of geometrical shapes such as rectangles or squares of attractive materials cemented together, which is known as *cut and try* method, for example chess boards. → Appliqués.

**overspread stone;** a commercial term for brilliant-cut diamond with a thin crown and a large table to preserve maximum weight of the rough stone.

**overtone;** additional fancy rose color (green, blue, pink, or orange) appears in some natural pearls, when nacreous layers are nearly transparent and thin, which is caused by diffraction and interference of light to create a fine luster or may due lattice vibration.

**Oviedo Pearl;** a pearl of 26 cts, from Panama it is believed to be the same as the Morales or Pizarro pearl and was among the Austrian Crown Jewels before Austria was sacked by Hitler.

**oviform;** a term applied to egg-shaped pieces or cut form.

**ovo doema;** a term used in Brazilian for water-worn quartz crystals.

**ovoid;** same as ovate.

**ovulite;** same as oolith.

**owl-eye;** a variety of agate with two similar concentric black circle eyes-like dot. Also called owl-eye agate. → Cyclops agate.

**owl-eye agate;** same as owl-eye.

**oxalite;** a commercial term for an imitation of jade or ivory made from calcined beef or animal bone. Also called oxolite, humboldtine.

**oxazine 9;** any of several basic of C<sub>4</sub>H<sub>5</sub>NO or derivative of them consisting of a ring composed of four carbon

atoms, one nitrogen atom and one oxygen atom which used as dissolved in ethanol as laser dye with the wavelength 644-709 nm. There are five compound used as laser dyes such as rhodamine B, rhodamine 6G, coumarin and sodium silicate. Also known as cresyl violet.

**ox-blood citrine;** a descriptive term for a natural dark citrine with reddish-brown hue. Also called sang de boeuf.

**ox-blood coral;** a descriptive term for a deep red variety of coral. Same as moro coral by Japanese.

**ox-blood glass;** → copper-ruby glass.

**ox-blood opal;** an informal term used by Australian miners for a deep red variety of opal.

**oxeye;** labradorite feldspar with dark chatoyant effects.

**oxeye agate;** agate like owl-eye. Oeil de boeuf, bull's-eye labradorite. → Cyclops agate.

**oxidation;** a combination with oxygen.

**oxide;** a binary composition of oxygen with metals or other elements.

**oxidized crystal;** same as oxidized diamond.

**oxidized diamond;** rough diamonds sometimes are naturally completely or partially coated or contain yellow to brown iron oxide film, removable, when the color is on the surface or in an open fissure. Also called oxidized crystal.

**oxide minerals;** those minerals formed by binary composition of oxygen with one or more metallic elements such as spinel, magnetite, etc.

**oxide of copper as dye;** dissolved oxide of copper, used as dye to produce colored beryl or quartz. → Acetate of copper.

**oxide of iron;** an abrasive and polishing material known as rouge.

**oxitol;** a commercial term for ethylene glycol monoethyl ether used as an immersion liquid. RI:1.408. Also known as cellosolve.

**oxolite;** same as oxalite.

**oxygen;** a colorless, odorless, tasteless, nonflammable, active, nonmetallic, chiefly bivalent element of the Periodic System with the symbol O.

**oxysphere;** a term used frequently for lithosphere.

**oxytourmaline;** a suggested term for tourmaline with noteworthy replacement of OH, F by O.

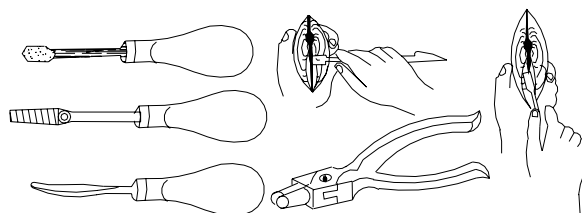
**oyster;** any variety of marine bivalve mollusk of the

genus *Ostreidae* and *Crassostrea* with usually irregular shell. Also called common oyster. → Mussel cross section, mussel valves, mussel extorior.

**oyster foot;** extremely muscular foot of mussel shell is found in the viscera mass below the mouth which expanding and contracting due to communication with the blood system which gives moving to the oyster. The foot becomes several times bigger than contrast size when dilated with blood.

**oyster line;** an unusual association of diamond with a fossil oyster shell found in North of Alexander Bay, South Africa.

**oyster opening tools;** there several method and tolls for



*oyster or molluscs opening tools*

opening oyster to search for pearl.

**oyster pearl;** any concentric pieces occur in common edible oyster in various color. They are not a true pearl.

**oyster shell;** shells of genus *Ostrea* from Gulf of Mexico.

**oyster varieties, pearl;** there are many kind of pearl-bearing oysters some of them referred in the books are listed here: *Pinctada maxima*, *Margaritifera sensu stricto*, *Pinctada margaritifera*, *Pinctada martensi*, *Pinctada radiata*, *Pinctada fucata*, *Trochus niloticus*, *Pinctada carchariarum*, *Pinctada albina*, *Pinctada mazatlanica*, *Pinctada erythraensispinna seminuda*, *Pinna nobilis*, *Pteria penguin*, *Placuna placenta*, *Haliotis tuberculata*, *Cristaria plicata*, *Anodonta cygnea*, *Nautilus pompilius*, *Margaritifera margaritifera*.

**ozarkite;** a local term for snow white massive variety of thomsonite from Arkansas, USA.

**ozone;** an allotropic, triatomic variety of oxygen produced by action of ultraviolet ray or electrical corona discharge of oxygen on air.

# P p

**P**; a chemical symbol for the element phosphorous.

**P**; an acronym for piqué.

**1P**; an abbreviation for 1st piqué.

**2P**; an abbreviation for 2nd piqué.

**3P**; an abbreviation for 3rd piqué.

**Pa**; a chemical symbol for the element protactinium.

**paar (oyster beds)**; a term employed in Sri Lanka (Ceylon), for shallow, hard bedrock on which the oysters live. The Sri Lankan shoreline, from which the pearl oyster is fished by divers. The paars may be formed from cemented polyzoa and millipores. Also called banks.

**paars**; → paar (oyster beds).

**pacha**; a Persian-Indian term for emerald. Same term used by Peruvian Indian. Also spelled pachae, pachel, or pachee.

**pachae**; same as pacha.

**pachee**; same as pacha.

**pachel**; same as pacha.

**Pacific cat's-eye**; → operculum.

**Pacific wing oyster**; same as wing shell.

**packets**; → theory of light.

**packing**; three dimensional arrangement of particles in a space lattice.

**pacos**; a Peruvian term for an earthy looking of a brown silver ore containing iron oxide.

**Paddy Green**; in 1878 Paddy Green found the Aladdin opal mine in Thacharinga Hills, Queensland, Australia.

**padmaradschah**; a corrupt term derived from the Singhalese word padmaragaya.

**padmaragaya**; a Singhalese or Sri Lanka word meaning lotus flower. A yellowish, pinkish-orange to reddish-orange variety of corundum (sapphire) from Sri Lanka, or a synthetic corundum of yellow to orange color. The orange color caused by nickel plus chromium impurity. Synonym; padmaradschah, padparadschah.

**padamya**; a Burmese term used for ruby with the meaning plenty of mercury. → Corundum, names of.

**Padparadschah**; various spelling. A corrupt term is derived from the Singhalese or Sri Lanka word padmaragaya. Also spelled Padparaja, pusparaga.

**Padparadschah sapphire**; → padmaragaya

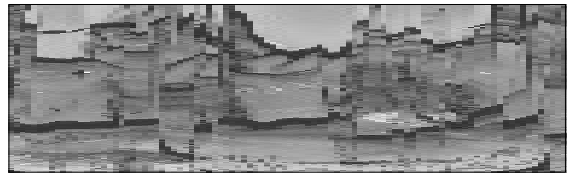
**Padparaja**; same as padparadschah.

**paesina marble**; → ruin marble.

**paesina stone**; a term used for beautiful Italy

landscapes (pictures or similar landscapes), which is a marble variety from Apennines, Toscana and called pietra paesina. Landscapes are originated from the variable depth of coloring, which is resulted from the impregnation and transformation, by wet way of the iron impurities in the limestone. Sometimes the characteristic bush pattern are due to infiltration of manganese oxide impurities. The age is about 50 million years.

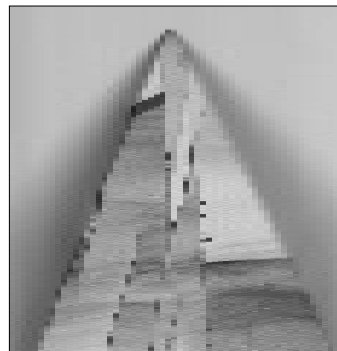
**paesinite**; a term used for beautiful Iranian landscape, sandstone which is similar to pietra paesina, a marble



*paesinite, Italy*

variety from Florence, Italy. The stones are exported to Pakistan and there will be fashioned in different forms and as ornamental stones. Found in Meshed, Iran. Also called Iranian paesinite.

**paesinite, Iranian**; a term used for beautiful Iranian landscape sandstone which is similar to pietra paesina,



*paesinite, Iran*

a marble variety from Florence, Italy. These stones are exported to Pakistan and there will be fashioned in different forms and as ornamental stones. Found in Meshed, Iran. Also called Iranian paesinite.

**paesinite sandstone from Meshed**; a marvelous, shiny, brecciated, vary-colored sandstone from Meshed, Iran with markings resembling the outlines of ruins of buildings on a polished surface. In which tiny fractured creamy brown sandstone is similar to pietra paesina, a marble variety from Florence, Italy. These stones are exported to Pakistan and there will be fashioned in different forms and as ornamental and decoration stones. Also called Iranian paesinite sandstone. May termed as pictorial sandstone or landscape sandstone.



**pagoda**; any gold and silver coins used in southern India, usually used for stamping with a figure or a temple.

**pagoda stone**; same as pagodite.

**pagoda stone**; a translucent agate, its opaque white stripes, which resemble pagodas it occurs in Myanmar.

**pagoda stone**; a limestone from China, which in section shows pagoda likened figures caused by the arrangement of fossil orthoceratites.

**pagodite**; a massive, silica-rich variety of pinite or agalmatolite. The Chinese carved this soft material into miniature pagodas, images, etc. Also called figured stone, agalmatolite, pagoda stone.

**Pahlavi Crown**; a crown made in 1926 for the coronation of Reza Shah Pahlavi (1877-1944). Designed by Sarâjeddin after Sasanian dynasty style. The crown is mounted with 3,380 diamonds the largest is a light yellow brilliant cut of 60 cts, which is set in the front panel in a sunburst design. There are 369 matched natural pearls, and 5 emeralds that weigh 199 cts. It was worn by Mohammed Reza Pahlavi at his coronation on October 26, 1967. Now on display at the National Jewel Treasury of Iran in the Bank Markazi (Central Bank) of Iran, Tehran, open to the public.

**painite**; very rare gem mineral is prized by collectors. Its color is similar to garnet or ruby. Pleochroic.

System: hexagonalic.

Formula:  $2[\text{CaZrAl}_9(\text{O}_{15})(\text{BO}_3)]$ .

Luster: vitreous.

Colors: deep red, garnet-red, ruby-red, brownish-orange.

Streak: colorless.

Diaphaneity: transparent.

Cleavage: not diagnostic.

SG: 4.01.

H:8.

Optics;  $\omega$ :1.816,  $\epsilon$ :1.787.

Birefringence; 0.029. ⊕.

Found in Mogok, Upper Myanmar, (Burma).

**painite absorption spectrum**; weakly chromium spectrum are seen at 709, 700, 693, 668, 660 nm.

**painite inclusions**; several minute cavities in thin layers are seen. Hexagonal crystal of phlogopite in tabular shape are present.

**painite luminescence**; strongly-red under SWUV and weak-red under LWUV.

**painite pleochroism**; distinct dichroic: dark ruby-red and light yellowish-brown to brown-orange.

**painted boulders**; natural coated or impregnated sandstones or quartzite stone with opal either in cracks or in the thin coats. Also called painted lady, painted quartzite, painted sandstone rock.

**painted diamond**; a fraudulent process used to enhance the phenomenal effect or color of yellowish or

brownish diamonds by coating or foiling the pavilion facets or girdle with a special tinge of violet dye to make them appear whiter. This film neutralizes, slightly off-color. → Coated diamond, coated stone.

**painted lady**; same as painted boulder.

**painted opal**; a fraudulent process used to enhance the phenomenal effect or color of opal, on which the back of the stone is painted black.

**painted sandstone rock**; same as painted boulder.

**painted stone**; → coated stone, coated diamond, painted diamond, coated crystal.

**paint gold**; a term applied to a thin coating of gold on crystal, minerals, rocks and other minerals.

**paint vehicle**; → vehicle.

**Pai Yü**; a term used in China for either white nephrite or white jadeite. Also spelled Pao Yü.

**pakh-dar**; a Farsi term meaning faceted, stone with facets. → Turquoise cut in Iran.

**pa kua**; a Chinese term used for a circular pattern with eight sets in such an order that each symbol is an inverse of the opposite emblem to symbolize to produce everything, which comes into existence, or principle of opposites with the five elements. → Chinese ritual and symbol jades.

**Pala**; a gem-bearing area in San Diego County, California, USA.

**Pala beryl**; beryl from Pala area, San Diego County, California, USA.

**palaeo**; same as paleo.

**palaeontology**; the study of life of past geological periods, which is based on the study of fossil remains. It is an important guide to geological age and rock identification. Also spelled paleontology.

**Palaeozoic**; same as Paleozoic.

**palaite**; same as huréaulite.

**Pala kunzite**; kunzite from Pala area, San Diego County, California, USA.

**Pala spessartite**; location of spessartite garnet in Pala area, San Diego County, California, USA.

**Pala tourmaline**; tourmaline from Pala area, San Diego County, California, USA.

**palasome**; same as host, host mineral. Also spelled palosome.

**palatium**; a term was used by Magnus as synonym for Belagius or house of carbuncle.

**palau**; an alloy of gold and palladium.

**Palau pearl (cultured)**; cultured pearls from *Pinctada margaritifera* mollusks that were fished from the coast of Palau Island, Caroline, South Pacific, USA.

**pale**; means very light color.

**pale green tourmaline**; a misleading term for light green tourmaline or emeraldite from Mesa Grande, California, USA.

**paleo**; a prefix indicating generally altered character. Old, ancient or prehistoric. Also spelled palaeo.

**Paleocene**; lowermost division of the Tertiary period and rock forming during the time, 65-55 million years ago, after Cretaceous and before Eocene.

**paleontology**; another spelling for palaeontology.

**paleosome**; an element of rock forming minerals or mineral deposit is older than an associated younger rock element (neosome).

**Paleozoic**; an era of geological time ranging between 600 to 230 million years ago, from the end of the Precambrian to the beginning of the Mesozoic era. British English spelling; Palaeozoic. Also called Palaeozoic Age.

**Palaeozoic Age**; same as Palaeozoic.

**palette**; same as palette.

**palladium**; a soft, malleable, ductile, silvery-white metallic element of the platinum group of the Periodic System with the symbol Pd. Used as alloy, owing to lower cost, for jewelry as a substitute for platinum. SG;12.02. → Gold.

**palladium gold**; a native alloy of gold and palladium which contain 5-10% palladium. Also called porpezite.

**pallial cavity of pearl oyster**; between the internal faces of mantle flaps of an opened oyster is a simple place which is termed as pallial cavity in which the sea water enters here and flows over the gills.

**pallium**; same as mantle of an oyster or shell.

**pallium of shell**; same as mantle of an oyster or shell.

**Palmeira topaz**; a misleading trade term for brownish man-made sapphire.

**Palmyra citrine**; a misleading trade term for heat-treated amethyst mostly turned to orange-yellow color.

**Palmyra citrine cut**; cut cabochon, faceted, or tumbled gems.

**Palmyra topaz**; a misleading trade term for heat-treated citrine or amethyst, which mostly turns to pale-yellow or orange-yellow color.

**palosome**; same as host, host mineral or palasome.

**palps of oyster**; a pair leaf-like fleshy flaps on each side of the mouth of a lamellibranches mollusk in which flows water after passing the gills.

**paludina limestone (marble)**; a blue-gray to reddish-brown variety of marble belong to shelly marble or Purbeck marble containing the fossilized shells of fresh-water snails the genus *Viviparus* of *Paludina carinifera*. Also known as shelly marble, or Purbeck marble. Found in Dorset, England.

**palygorskite**; an inosilicate clay mineral with a needle-like aggregate resembling parchment or leather. An ornamental stone and rarely cut cabochon. Erroneously in trade known as angle-skin opal. Also called rock-wood, mountain-wood, lasselite, attapulgit.

System: monoclinic or orthorhombic.

Formula:  $4[(\text{Mg},\text{Al})_2\text{Si}_4\text{O}_{10}(\text{OH})_2 \cdot 2\text{H}_2\text{O} + 2\text{H}_2\text{O}]$ .

Luster: silky, vitreous to dull.

Colors: pale pink, yellowish, brownish, gray, rose pink.

Streak: white.

Diaphaneity: transparent to translucent.

Cleavage: none.

Fracture: conchoidal to uneven. Brittle.

SG: 2.10-2.30.

H: 1½-2. Naturally impregnated with silica up to 4½.

Optics;  $\alpha$ : 1.530,  $\gamma$ : 1.559.

Birefringence: 0.029.  $\ominus$ .

Found in Russia, Attapulgas and Georgia, Washington (USA), Morocco, Mexico, France, Peru, England, Scotland, Mount St. Hillarie (Canada), and the Czech Republic.

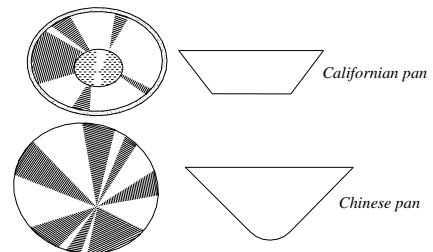
**Pam Brilliant Diamond**; same as Pam Diamond.

**Pam Diamond**; reportedly a diamond of 112 or 115 cts, found before 1891 in Jagersfontein Mine, South Africa. It was cut to a brilliant of 56.60 cts. Also called Pam Brilliant Diamond, and Jagersfontein Brilliant Diamond.

**pampel**; same as pampille cut.

**pampille cut**; a fancy drop-shaped cut similar to briolette but more elongated with circular cross section that may be polygonal. → Briolette cut.

**pan**; a broad, shallow, circular metal container, in which



Chinese and Californian pan for separation of gems and gold

heavy valuable minerals or gold are separated from other materials by a shaking motion. Also called dish, vanning shovel. → Panning.

**pan**; a shallow, natural depression in the earth surface, holding permanent or temporary lake or pond.

**pan**; a geological land basin.

**pan**; a term used by Australian miners for hard bedrock under the opal dirt.

**Pan, the**; formerly diggers name of Dutoitspan Mine.

**pan facet**; a term frequently used for star facet.

**Panama pearl**; pearls fished from Panama coast, Gulf of California, USA. Same as La Paz pearl.

**Panama shell**; a variety of green-edged nacre of *Margaritifera shell*, which produces black pearls. Found in the Gulf of California, USA.

**panchratna**; in India by Hindus a religious ceremonial five-jewels offering to a Hindu temple, which is composed of diamond, ruby, sapphire, pear, and gold. → Naoratna.

**panchromatic**; photographic emulsions, which are responsible for sensitive photographic to cross all visible colors.

**Pandora opal**; a term used by Australian miners for famous quality of opal found at Lightning Ridge, New South Wales, Australia.

**Pandora Opal**; same as Pandora Star Opal.

**Pandora Star Opal**; a white rough opal of 711 cts, found in 1929 at Lightning Ridge, New South Wales, Australia. After cutting weighed 590 cts. It is a fossilized (opalized) bone of a plesiosaurs. It was sold in the USA. Also called Pandora Opal.

**pane**; a term applied to a panel.

**pane**; a term applied to a star facet.

**panel**; to ornament with panel(s).

**panella**; a Portuguese term used by miner's in Brazil for druse.

**Panfontein Mine**; location of small diamond deposits in Orange Free State, South Africa.

**Panna or Panna working**; a location of an alluvial diamond-bearing belt area in the State of Madhya Pradesh State, district of Panna in Central India. Many diamond deposits are found along this belt. There are commercially workings in alluvial, conglomerates and two kimberlitic diatems. There are also three kimberlitic pipes, the third one is called body of Angor.

**panning**; a hand technique used by prospector or worker washing alluvial gravel, crushed rock or earth in a shallow pan to concentration the heavy minerals. When the pan containing water shaken backwards and forwards the lighter material is washed away, leaving the heavy minerals such as diamond or gold behind. Also called washing. In Malayan termed as dulang.

**pantaure**; an old French term for emerald because its resemblance to panther. Also called Pierre Solaire and spelled pantaure.

**pantaure**; same as pantaure.

**pan tha**; a Burmese (Myanmar) term for translucent white jadeite. → Jadeite colors in Burmese.

**Paolo de Frontin Diamond**; reportedly a pale greenish-yellow diamond of 49.50 cts, from Brazil. It was merchandised in 1930 in London. Present owner unknown.

**Pao Yü**; same as Pai Yü.

**papagoite**; a phyllosilicate mineral, which normally is mixed with quartz. Cut cabochon and prize by collectors.

System: monoclinic.

Formula:  $4[\text{Ca}_2\text{Cu}_2\text{Al}_2(\text{OH})_6(\text{Si}_4\text{O}_{12})]$ .

Luster: vitreous.

Colors: sky blue.

Streak: colorless.

Diaphaneity: Translucent to opaque.

Cleavage: {100} distincts.

Fracture: Brittle.

SG: 3.25.

H: 5-5½.

Optics;  $\alpha$ : 1.607,  $\beta$ : 1.641,  $\gamma$ : 1.672.  $\ominus$ .

Birefringence: 0.065.

Found in Ajo, Pima County, Arizona, USA.

**papagoite absorption spectrum**; bands are seen at 448, 515 and 555 nm.

**paper folding**; → appendices.

**paper marks**; same as paper wear.

**paper spar**; a variety of calcite which occurring in thin layers similar to paper-like plates.

**paper wear**; an effect of mutual rubbing of paper and single expensive gem or diamond in a so-called paper storage. It is better to place a fold of cotton wool or lint in the package to prevent the rubbing. Also called paper marks. → Paperworn diamond.

**paperworn diamond**; scratches or abraded facets caused by mutual rubbing of polished gems or diamonds in a so-called paper storage. → Paper wear.

**Paphian diamond**; same as Paphos diamond.

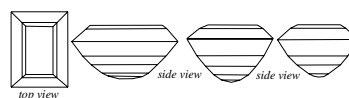
**Paphos diamond**; a misleading term for quartz crystal from Cyprus. Also called Paphian diamond or Paphros diamond.

**Paphros diamond**; same as Paphos diamond.

**Papua Gulf pearl**; a promotion term for silvery white pearls from Gulf of Papua, New Guinea. Not quite as white as Australian pearls.

**Pará**; location of a small diamond deposits in Pará State in Brazil.

**parabolic cut**; a variety of step cutting in which the pavilion facets of the stone are nearly curvature of a parabola in fact the outline of pavilion appeared in shape like a cabochon.



parabolic cuts

**paradise jasper**; a commercial local term for a variety of red jasper from Morgan Hill, California, USA.

**paraffin**; any saturated aliphatic hydrocarbons of the alkanes series with the general formula  $\text{C}_n\text{H}_{2n+2}$ . They are white, tasteless, odorless, chemically inert, stable, and inflammable.

**paraffin treated**; any gemstone that is prepared with paraffin to enhance the color and appearance such as turquoise, lapis lazuli with addition of blue dye to cover the white areas, and by jade or jadeite to fill fissures or

fracture.

**paragenesis**; the relationship and sequential order of mineral formation at the same time.

**paragenesis**; a particular association or appearance of minerals.

**paragneiss**; resulting from the metamorphism of detrital sediments rock.

**paragon**; it means model of excellence.

**paragon**; today a flawless diamond weights of 100 cts, or more.

**paragon**; same as paragon pearl.

**Paragon Diamond**; an exceptional white, flawless, modified shield-cut diamond of 137.82 cts, from Brazil. It was cut from a rough stone of 320 cts, Sold in Antwerp and mounted in a necklace by Graff Diamonds of London.

**paragonite**; a yellowish or greenish, monoclinic mica with the chemical formula  $4[\text{NaAl}_2(\text{Si}_3\text{Al})\text{O}_{10}(\text{OH})_2]$ . SG:2.78-2.90. H:2½. Also called soda mica.

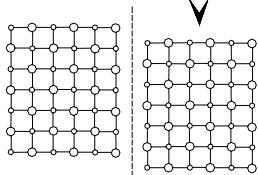
**paragon pearl**; spherical pearl of exceptional size from the very large oyster that are found in the South Pacific and off the shore of Australia. Also called monster pearl.

**paragon pearl**; a commercial term for imitation pearl.

**paraíba apatite**; a misleading commercial term for light green to bluish-green apatite from Malagasy (Madagascar), Africa, which resemble tourmaline from Paraíba, Brazil.

**parallel banded**; same as onyx marble, onyx, onyx obsidian.

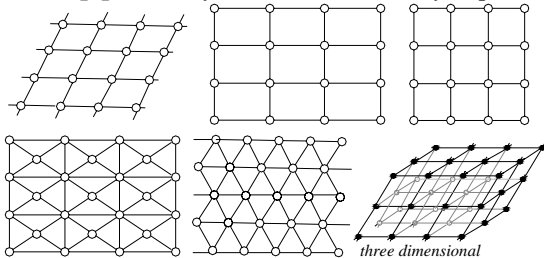
**parallel displacement**; a term used in crystallography for linear parallel displacement in which the feature were parallel before displacement and are still parallel afterwards. →



parallel displacement of rock-salt

Parallel transformation.

**parallelepiped**; a crystal form bounded by 6 parallelo-



unit cells or parallelepipeds a homogenous, two and three dimensional discontinuum

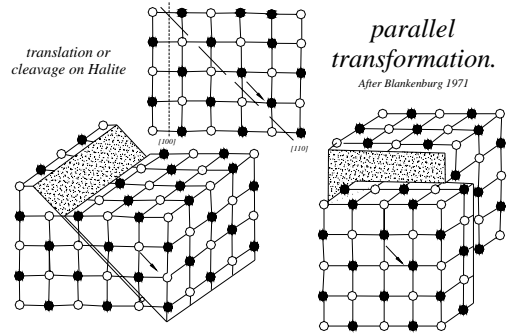
grams (faces). Opposite pairs being identical and parallel.

**parallel extinction**; → straight extinction.

**parallelogram**; a plane quadrilateral, or four-folded polygon, which has opposite sides parallel and angles are equal.

**parallel grouping of crystals**; same as parallel growth.

**parallel growth**; two or more crystals growth with edges and faces parallel to each other, in which one or more axes are almost parallel. Not to be confused with



twinned growth. Also called parallel intergrowth, parallel grouping of crystals.

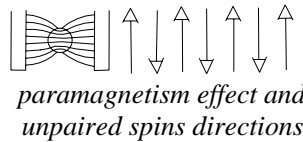
**parallel intergrowth**; same as parallel growth.

**parallel pearl**; another term for cultured pearl.

**parallel transformation**; a term used in crystallography for linear parallel transformation in which the features were parallel before transformation and are still parallel afterwards. Parallel transformation caused due to pressure, which formed cleavage or twinning in crystals such as polysynthetic twinning in albite or calcite.

This Also called parallel transformation.

**paramagnetic**; substances with a positive magnetic susceptibility, which is caused by the spin of electrons. Its permeability is less than that of ferromagnetic.



paramagnetism effect and unpaired spins directions

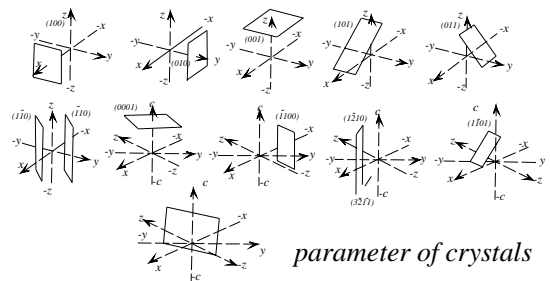
Minerals such as olivine, biotite, or pyroxene possessing magnetic ions. → Magnetism, paramagnetic.

Minerals such as olivine, biotite, or pyroxene possessing magnetic ions. → Magnetism, paramagnetic.

**paramagnetic material**; positive material or mineral.

**paramagnetism**; → magnetism.

**parameter**; in crystallography the length of a plane of a



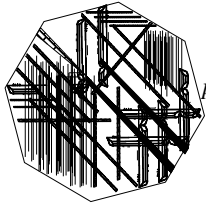
parameter of crystals

unit cell or the angle between the axes of the unit cell of a crystal.

**parametral plane;** a crystal plane, which cuts the crystallographic axes in the ratio of the unit intercepts  $a, b, c$ .

**parametric amplification;** a device of amplifier of microwave that depend on the periodically variation and consisting of an optically nonlinear crystal. Also called oscillation.

**paramorph;** a mineral changes (pseudomorph) its molecular constitution but not chemical composition such as calcite after aragonite. Same as polymorphism.



paramorphose  
of low lucite

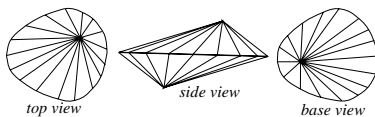
**paramorphism;** minerals having the same crystal form but different chemical compositions.

**paramorphous;** → paramorph.

**param puchche;** a Sinhalese used term for emerald.

**parasitic worms of pearl;** there are several kind of larval in mussels such as cestodes, trematodes, *Distomum duplicatum*, *Distomum margaritarum*, *Distomum somateriae*, cestodes *tetrarhynchus* nematodes and etc.

**parasol cut;** a modified brilliant-cut similar to umbrella used by women as a sunshade.



parasol cut. After Mollin

This cut consists of tow parts (crown and pavilion) similar to each other but the top of the

crown is 180° turned to pavilion top or vice verse. Each part having 17 facets without table and culet.

**parcel;** a collection of different qualities of rough diamond in a specific form inside two paper for a client at a sight or shipment. → Lot.

**parcel;** an indistinctive term used by Australian miners for a collection of rough fine opal.

**parcel paper;** same as diamond paper.

**parcel price;** same as lot price.

**pargasite;** a mineral of amphibole group. Closely related to hornblende. Has been faceted

System: monoclinic.

Formula:  $\text{NaCa}_2\text{Mg}_4\text{Al}(\text{Al}_2\text{Si}_6\text{O}_{22})(\text{OH})_2$ .

Luster: vitreous.

Colors: brown to pale brown, gray, blue, bluish-green, green, black.

Streak: colorless.

Diaphaneity: translucent to opaque, rarely transparent.

Cleavage: not diagnostic.

SG: 3.07-3.19.

H:5-6.

Optics;  $\alpha$ :1.613,  $\beta$ :1.618,  $\gamma$ :1.635.

Birefringence: 0.022. ⊕.

Found in California, Pennsylvania (USA), Sweden, Pargas (Finland), Russia, Austria, Canada, and Venezuela.

**pargasite pleochroism;** pleochroic in several colors: colorless, pale-brown and light-brown or greenish-yellow, bluish-green and green or colorless, bluish-green and bluish-green.

**Parazoanthus;** a species of coral. → Gold coral.

**parian;** a fine, white, unglazed hard paste porcelain resembling Parian marble.

**Parian marble;** a white, statuary marble from the Island Paros (Minoa), Cyclades, Greece.

**parisite;** it is related to mineral synchysite. A rare mineral cut as small faceted gems prized by collectors. Occurs as a typical inclusions in emerald. Also a 6-rayed star parisite has been found in Colombia.

System: hexagonalic.

Formula:  $18[(\text{Ce},\text{La})_2\text{Ca}(\text{CO}_3)_3\text{F}_2]$ .

Luster: vitreous to resinous, pearly on cleavage.

Colors: brown, brownish-yellow, gray, yellow, lilac.

Streak: colorless.

Diaphaneity: transparent to translucent.

Cleavage: {0001} distincts.

Fracture: conchoidal to uneven. Brittle.

SG: 4.20-4.36.

H:4½.

Optics;  $\omega$ :1.676,  $\epsilon$ :1.757.

Birefringence: 0.081. ⊕.

Dispersion: weak.

Found in Muzo (Colombia), Italy, Malagasy, Norway, Manchuria, Massachusetts and Montana (USA).

**Parisian diamond;** a misleading term for a diamond imitation.

**Paris jet;** a variety of black glass used as a jet imitation.

**Paris, Main;** location of tourmaline mine in Main by Paris, France.

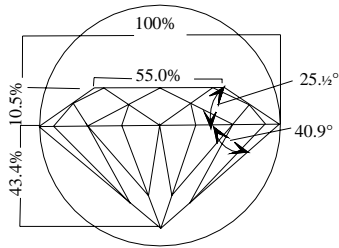
**Paris pearl;** a misleading term for pearl imitation made from essence d'orient.

**Paris plate;** cheaper stones are not sold as other stones by carat but by gram, ounce, pennyweight, or by size; the millimeter, or centimeter. Or some are marked by a stencil gauge with arbitrary numbers, which is called a Paris plate.

**parivadra;** a Sanskrit term for aquamarine.

**Parker brilliant cut;** one of several modifications of ideal brilliant-cut diamond near to Tolkowsky brilliant cut or Eppler brilliant cut.

**paronigars;** a term used in India for people string Bombay pearls.



proportion of facets and their angles on a Parker brilliant cut. The angles are related to girdle diameter

**parquetry**; a style of mosaic, which consists of geometrical shapes of attractive materials cemented together and set in a metal mount. A contrast to intarsia. → Mosaic.

**parrhotite**; same as pyrrhotine.

**parrot wing**; a misleading term for cryptocrystalline red and yellow jasper or agate occur together with green-blue chrysocolla and brown limonite. Found in USA.

**Parteal working**; a group location of alluvial diamond deposits near Krishna River, Golconda, India. Also spelled Partial and Parteel.

**Parteel working**; same as Parteal working.

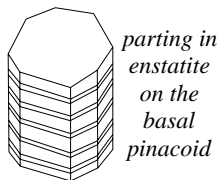
**partially dissolved**; a term used for heat-treated sapphire in which the rutile silk may not dissolve entirely and is an indication for treated stone.

**Partial working**; same as Parteal working.

**particle**; a general term used for shape, composition, or structure of a distinct unit in a rock such as a sedimentary particle.

**parti-colored gemstones**; transparent, cut or uncut stones, which have zonar of different colors, such as tourmaline crystals, which often shows two or three portions of color from green through colorless to pink. Parti-colored gemstones are cut from zonar-colored part. Frequently this effect can be seen by corundum, sapphire of green color and tourmaline.

**parting**; splitting or separation of any gemstones or rock along certain definite weak plane such as lamellar twinning planes, which are not true cleavage planes but resembling cleavage such as sphene,



parting in enstatite on the basal pinacoid

pyroxene, or corundum. Also called pseudo cleavage. Same as false cleavage.

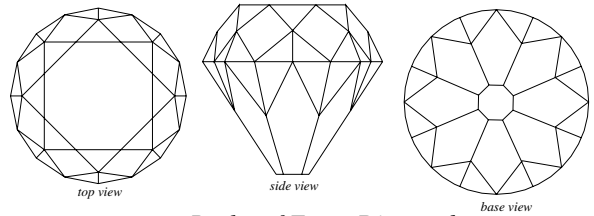
**parting of false Cleavage**: same as false cleavage (parting).

**parure**; a French term means ornament. A set of jewels decorated *en suit* made of the same gemstone, composed of necklaces, bracelets, earring, aigrettes, buckles, and brooch, which are designed to be worn at

the same time. Also called *suit*.

**paryll**; another spelling for beryl.

**Pasha of Egypt Diamond**; an octagonal-shaped diamond of superior quality of 40 cts, from India. Purchased by Ibrahim Pasha victory of Egypt (1789-



Pasha of Egypt Diamond

1848) in 1848. It was recut twice at least one into stone of 36.22 cts. It is believed to be in Italy.

**Passau pearl**; fresh-water pearls fished in Central Europe, marketed through Passau a city in Bavaria, Germany.

**paste**; a trade term for many varieties of glass used as imitation of gemstones, made from certain type of lead glass or flint glass.

**paste**; a term used to any imitation gemstone. Paste jewels are readily distinguished from genuine stone by several means; (a) paste feel warmer than gemstone and easily scratched. (b) Looking for black spot. (c) Paste jewels are generally closed and foiled setting. Good paste are made in Austria, France, and the Czech Republic. → Glass, strass.

**paste gold**; a composition of gold and flux.

**pastoral ring**; another term for Bishop's ring.

**patch**; a term used by Australian miners for a rich opal seam, or a series of seams.

**pâté**; a French term for paste.

**pâté dure**; same as porcelain.

**pâté de riz**; a French term for a Chinese glass used for imitation jade.

**pâté de verre**; a French term for glass paste.

**pate gongg**; an Indian term for *Pinctada vulgaris*, which yields a type of Persian Gulf pearl.

**paternostermakers**; a term was used in 14<sup>th</sup> centuries in North Germany and in Poland for workers, who made amber into rosaries. It means makers of rosaries.

**pathakkamala**; a ceremonial historical Hindu jewel in Indian decorated with several gemstones consisting of an emerald of 1 to 1½ inches in diameter, which weighs 60 rati (approximately 26.22 cts.), is mounted in the center of the jewel.

**patina**; a thin multicolored film produced on the surface of minerals, rocks, or other materials by atmospheric corrosion after long exposure. Also called desert

varnish.

**patina**; a green film or discoloration of basic copper carbonate formed naturally on copper and bronze to protect the metal from further oxidation. Also called verde antico.

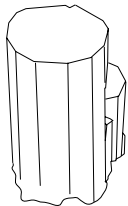
**patina**; gray blue surface on silver and reddish patina on ancient gold caused by scratches. Patina can be produced with acids.

**patinated chert**; chert nodules coated with a patina.

**patona pearl**; a commercial term for imitation pearl.

**Patos Diamond**; a brown diamond of 324 cts, found in 1937 in the Patos Mine, Minas Gerais, Brazil. Present owner unknown.

**Patricia Emerald**; an uncut, fine color emerald crystal of 632 cts, found in 1920 in the Chivor Mine, Colombia. Now on display by the American Museum of Natural History, New York



*Patrizius  
Aquamarine  
crystal*

City, USA.

**patricia pearl**; a commercial term for imitation pearl.

**Patricia, Patrizius Emerald**; → Patrizius Emerald Crystal.

**patricianite**; a trade term for a pink and green mixture of prehnite and chlorite, frequently with copper inclusions found in the Lake Superior districts.,

**patrinite**; same as aikinite.

**patriotic wear of beryl family**; emerald, aquamarine, beryl, and golden beryl as spirit of patriotism was worn as birthstone for the month of August and October in the USA.

**Patrizius Emerald Crystal**; a green emerald crystal of 630.00 cts, found 1921 in Chivor, Colombian. Now on display at American Museum of Natural History in New York, USA. Also called Patrizius Patrice Emerald, St. Patrick's Emerald. Also called Patricia, Patrizius Emerald.

**Patrocínio Diamond**; reportedly a diamond of 120.36 cts, found in 1851 near Rio Patrocínio, Minas Gerais, Brazil. Present owner unknown.

**pattern**; formed metal or other material used to produce a mold for casting metals. It is an imitation from an object for reproduction.

**pattern**; an arrangement of diffraction pattern by means of X-ray methods to detect the structure of crystalline materials.

**pattern**; any wax model used to made a casting for reproduction.

**pattern**; a term used by Australian miners for a conformation of opal variation in size and disposition of color units, nature of silica spheres in opal, block

faults and any other included materials.

**patu pounamu**; a Maori term for striking alluvial green jade pebbles, used for ornamental purposes or amulet gems and as weapon by natives of New Zealand. → Pounamu.

**Paau shell**; a big variety of abalone shell, *haliotis iris*, which resemble opal in due to bright colors and iridescence. Found in New Zealand, and California coast (USA). Furnishes mother-of-pearl slice for imitation opal and other jewelry fashioned objects. Also called abalone in American waters, sometimes produce baroque pearls. In Japan is called awabi shell.

**Paul I Diamond**; a cushion-shaped, pink-red diamond of 13.35 cts, from India, set in a diadem, named for Paul I (1754-1801) the son of Catherine the Great of Russia. Now on display in the Russian Diamond Fund in Moscow.

**pauline trigere**; a commercial term for synthetic strontium titanate used as diamond imitation.

**paulite**; blackish hypersthene contains copper colored inclusions from St. Paul Island, Canada.

**Paulo de Frontin Diamond**; a Brazilian diamond of 49.50 cts. Present owner unknown.

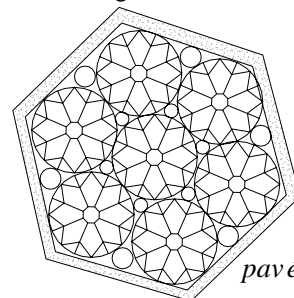
**pavé**; setting a surface with pavement. → Pavé setting.

**paved**; same as pavé setting.

**pavement**; any surface, which suggests a paved road with no symmetry. → Mosaic, fictile mosaic, florentine mosaic, pavement mosaic.

**pavement mosaic**; a surface, which has been paved like a mosaic, no symmetry. → Mosaic, fictile mosaic, florentine mosaic.

**pavé setting**; a style of setting, in which many small pieces of minute gemstones are set close together as



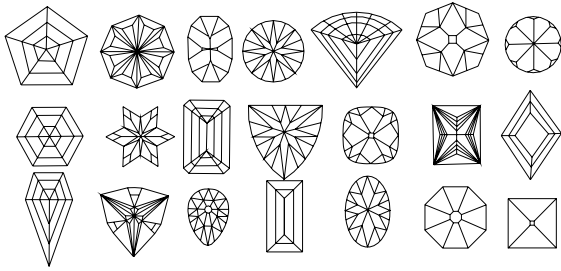
*pavé setting*

possible to cover the entire mount. It used to make brooches, pendants, etc. Also called paved and pavé. → Channel setting.

**pavilion**; the part of a faceted diamond or other gemstone below the girdle that extends from the girdle to the culet. Also called base. → Brilliant cut.

**pavilion angles**; in a brilliant cut the angle between the girdle and the main facets on the pavilion. → Brilliant cut.

**pavilion depth**; in a standard brilliant cut the depth of



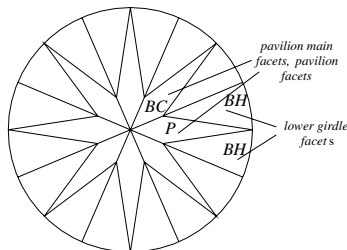
*different kind of pavilions*

the pavilion is the perpendicular distance between the girdle outline and culet. It is determined as a percentage of the girdle diameter on round brilliants or of the width on fancy cuts. → Brilliant cut.

**pavilion depth percentage;** → pavilion depth.

**pavilion facets;** any facets on the pavilion of a fashioned stone.

**pavilion facets;** in brilliant cut diamond all 8 elongated



*base view of a round brilliant-cut diamond*

lozenge-shaped facets extended from girdle to culet. Also called lower main facets. → Pavilion main facets.

**pavilion flash;** a microscopically, dark-filed illumination dispersion test to separate diamond from its singly refractive imitation materials. By this typical test, the stone is held table down and tilt back and forth when the pavilion facets are examined. Diamond usually exhibits unique orange and blue flashes, while yttrium aluminum garnet with the acronym YAG exhibits essentially blue and lilac, cubic zirconia exhibits mostly orange flashes, Gadolinium gallium garnet with the acronym GGG exhibits orange and blue, synthetic rutile exhibits several spectral colors, and strontium titanate or fabulite exhibits several spectral colors.

**pavilion main facets;** the 8 elongated lozenge-shaped main facets on the pavilion that extended from the girdle to the culet of a brilliant cut gemstone. On round brilliant cut frequently is named as quoin facets, or bottom-corner facets. → Pavilion facets, brilliant cut.

**paving stone;** thin flat stones suitable for paving. → Mosaic.

**paving stone;** same as building stone.

**pavonazzetto marble;** same as pavonazzo marble.

**pavonazzo marble;** a siliceous marble of various shade of pale yellow, green, blue, white or gray traversed with bands of white or purple and the plumage of a peacock (pavone). Also called Phrygian marble. Also spelled pavonazzetto marble.

**pay gravel;** gravels containing valuable or sufficient heavy mineral to work profitable, such as diamond placer mining in South Africa. Also called paying gravel.

**paying gravel;** same as pay gravel.

**paying mine;** a term used for active mine.

**Pb;** a chemical symbol for the element lead or plumbum.

**p.c.;** an acronym for per carat used in trade.

**Pd;** a chemical symbol for the element palladium.

**Peace Diamond;** a colorless, cushion-shape cut diamond of 12.25 cts, probably from India. Sold by Sotheby's in 1938. Present owners unknown.

**Peace Diamond Uncut;** an uncut diamond of 56.20 cts, found in 1962 in the Mir Pipe in Sakha (Yakutia). Present owners unknown.

**Peace Ruby;** a fine ruby of 43 cts, in rough found in 1919 in Myanmar, (Burma). It was found on Armistice Day, therefore the name. Also called Chhatrapati Manick Ruby. Present owner unknown.

**peach-blossom ore;** same as erythrite.

**peach-blossom-colored tourmaline;** another term for apyrite.

**peach color amethyst-citrine;** cut stone of distinct zones of bicolored amethyst and citrine, which is oriented, and the two colors blend and produce a delicate peach color.

**peach-colored tourmaline;** another term for apyrite.

**Peach-Blossom Diamond;** a pale pink (Peach-Blossom hue), pear-shaped diamond of 24.78 cts, purchased by Louis XIV of France. It is believed that the Peach-Blossom Diamond and Hortensia Diamond may be one and the same. Now on display at Louver Museum in Paris.

**peacock opal;** opal with play-of-color that resembles peacock feathers. → Opal.

**peacock ore;** bornite mineral and rarely chalcocopyrite, becomes iridescent from tarnish, when exposed to air.

**peacock stone;** botryoidal mass of malachite shows in cut section a concentric pattern, which is called malachite peacock eye or peacock stone. Worn to protect from the spell of the evil eye. → Malachite.

**Peacock Throne;** a world famous large, canopied throne, encrusted with gems such as diamonds, emeralds, rubies, and pearls. Made in Dehli, India, in 1628-1635 for the Mogul Emperor Shah Jahan (1592-1666), who built the Taj Mahal. It was taken back in Persia by the conqueror, Nadir Shah in 1739. It said the three historical diamonds; Akbar Shah (116 cts.),



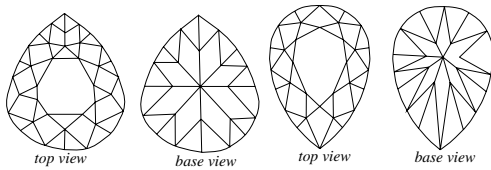
Darya-i-Nûr (175 and 195 cts.), and Koh-i-Nûr (108.93 cts.) have been mounted in the eyes of the peacocks. It is believed that numerous gems of the throne were stolen during the 1979 revolution. Now it is on display at the Central bank of Iran, Tehran. Open to the public.

**pea grit;** → pisolite.

**peanut obsidian;** a spherulitic obsidian with radiating feldspar fibers found in Sonora, Mexico. It is similar to marekanite.

**pea opal;** a term used by Australian miners for small pisolite size of opal.

**pear cut;** a style of cutting gemstones resembling a pear or pendeloque.

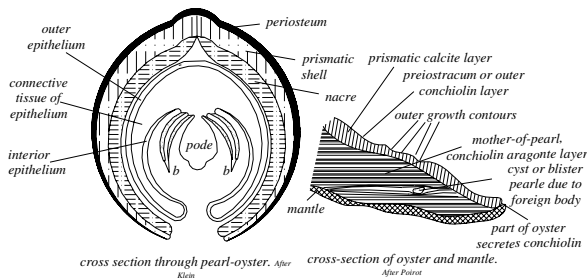


pear or drop-cut

**pear drop;** a term applied to pear shape drop pearl suitable to make ear-rings, and pendants. Also called drop-shaped pearl, drop pearl, and elenchi.

**pear eye;** a term applied to pear shape drop pearl.

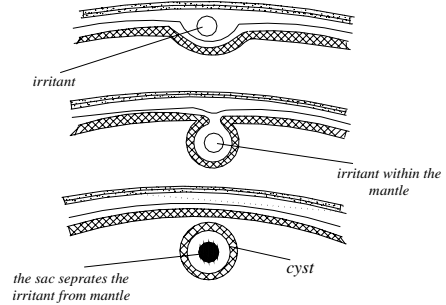
**pearl;** a dense, lustrous concretion, biological organic gem formed within the shell of certain pearl-bearing mollusks consists of a small particle surrounded by concentric sheets of nacre composed of *conchiolin* 10-14% (a horny organic material of  $C_{32}H_{48}N_9O_{11}$ ), calcium carbonate (calcite or aragonite;  $CaCO_3$ ) 82-86% and water 2%. Calcium carbonates are in the form of minute prisms and secreted with conchiolin together by the mantle of the oyster, which are deposited as



cross section of pearl-oyster

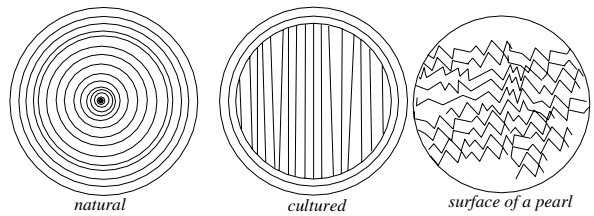
many very thin concentric layers covering the small foreign nucleus of sand or small parasite such as *cestode worm* or a *trematode worm* or that entered the shell naturally, It is believed the oyster can also produce cellular tissue that causes a resistance. In both

cases the pearl is known as *true pearl* or *wild pearl*. Or can be also made by inducing an artificial beads, a piece of mantle tissue, a grain of sand, or other irritant,



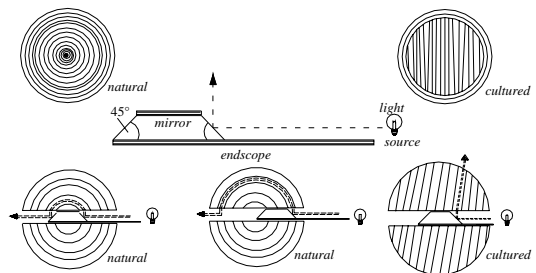
formation of a cyst pearl

usually by the introduction of a mother-of-pearl, which produces *cultured pearl*. Nacreous shellfish are known with the general name *lamellibranche* for class of bivalve mollusks. The highest quality of natural pearl is from pearl oyster *Filibranchia*. The generic term for *Pinctada* of salt-water bivalve mollusks included *Margaritifera* and *Pteria*, also known as *Oriental pearl* and was known as *Meleagrina*. Other pearl-bearing



cross section of a natural, cultured pearl and their surface

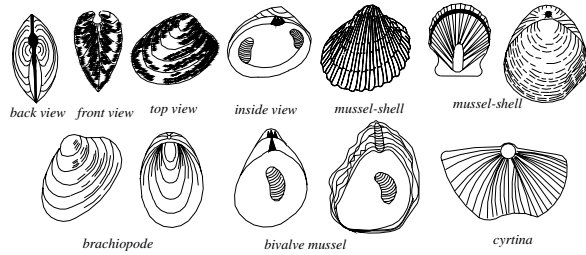
shellfish are *abalone* of genus *Haliotidae*, *giant conch*, the *ormer shell* of *Haliotis tuberculata* and *giant clam*. Other less important mollusks are *Venus*, *Cassis*, *Pinna*, *Placenta*, *turbo marmoratus*, *Trochus*, *Mytilus*, *Xancus*,



using of endoscope in drilled natural and cultured pearl

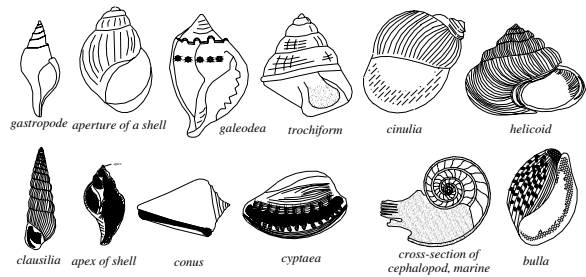
and *Malleus*. Fresh-water shellfish obtained from the mussel *Unio margaritifera* living in rivers of America and Europe, see fresh-water pearl. The sizes and shapes of pearls vary: the size vary from *seed pearl* to *paragon*

pearl, in the form of the finest spherical, oval, egg-shape to irregular in shape such as *baroque pearl*, *drop pearl*, *hinge pearl*, *button pearl*, *hammer pearl*, etc. The color of pearls usually depends on the water where produced, it is a result of *body color* and an overtone



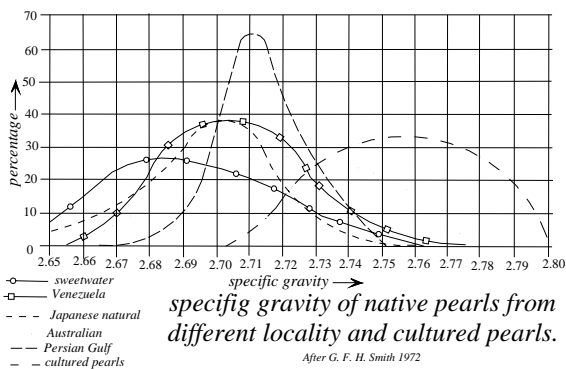
bivalve mussels, brachiopods and oysters

color, known as *orient*, which causes surface effect and results lustrous sheen. The surface color or orient caused by diffraction and reflection due to the diffuse light source at the edge of overlapping plates of calcium carbonates. The rest of the color is caused by body color. At least two overtone colors can be seen, on the surface in full view and at the edge. Fancy color



gastropods and cephalopods

such as red in the *Haliotis rufescens*, pink, violet, blue, green, or yellow in fresh-water pearls are frequently seen. Dark colors in natural and cultured pearls are caused by dark conchiolin in nucleus. *Blue pearl* is a



specific gravity of native pearls from different locality and cultured pearls.

dark-blue colored to silver-gray pearl, which is caused by a layer of conchiolin near the surface or by a center

of mud or silt, which is called *mud center*. Some pearls are artificially dyed. Normally the pearl is free within the mantle of shell, if attached to one of the shells is named as *blister pearl*. Those pearls, which are produced by *encystation* within the body of oyster known as *mantle pearl*, *free pearl*, or *cyst pearl*. It is one of the *birthstones* for June. Pearls are used as necklaces, brooches, Pendants, ear-rings, finger rings, suspended form, pins, beads, etc. → Conchiolin, aragonite, -pearl, origin of, - body colors of pearl, pearl size, prismatic layer, play of color, hem pearl, ligament pearl, muscle pearl, grading of pearl.

System: orthorhombic, when calcite trigonal.  
Formula: CaCO<sub>3</sub> 82-86%, conchiolin (C<sub>3</sub>H<sub>48</sub>N<sub>9</sub>O<sub>11</sub>) 10-14%, and water 2-4%. It vary.

Luster: pearly, satin, dull.  
Colors: white to creamy white, vary from pink (rosée pearl) to fancy-colored pearls from yellow to green, and black, gray, deep-blue, and bluish-green.  
Streak: colorless to white.  
Diaphaneity: translucent.  
Cleavage: none.  
Fracture: uneven. Brittle.

SG: 2.60-2.78 to 2.85. Cultured pearl: 2.72-2.78. None nacreous pearl: 2.80.  
H: 2½-4½.  
Optics; a:1.520, b:1.650, g:1.660 when it is consisting of aragonite and conchiolin. For black pearl 1.53-1.69.  
Birefringence: 0.140. ⊖.

Found: salt-water pearls found in Persian Gulf, Gulf of Manaar, Red Sea, Australia, South Sea, Japan, Mexico, Panama, Venezuela, Florida, Gulf of California. Fresh-water pearls are found in the rivers worldwide such as Scotland, China, Mississippi River, and Europe. → True pearl.

- pearl, abalone;** → abalone pearl.
- pearl, Alasmodon;** → Alasmodon pearl.
- pearl, Antilles;** → Antilles pearl.
- pearl are tears;** an ancient believing and trite remarks for the form of pearl.
- pearl, Australian;** → Australian pearl.
- pearl, baroque;** natural or cultured pearl of irregular shape. → Baroque pearl.
- pearl, barrook;** → baroque pearl.
- pearl, Biwa;** → Biwa pearl.
- pearl, black;** → black pearl.
- pearl, beaching of;** → bleached pearl.
- pearl, blister;** → blister pearl, mabe, pearl.
- pearl, blue;** → blue pearl.
- pearl body colors;** same as body colors of pearl. Color of pearls usually depends on the water where produced, it is a result of body color and an overtone color, known as orient, which causes surface effect and

results lustrous sheen. The surface color or orient caused by diffraction and reflection due to the diffuse light source at the edge of overlapping plates of calcium carbonates. Body colors are: white (no overtone), cream (no overtone), pale cream to pale yellow, cream rosé, pale rose, fancy pearls (with overtone), and black pearls which includes other colors like bronze, deep blue, gray, blue-green and green sometimes with metallic overtone. → Pearl.

**pearl, Bombay bunch of;** → Bombay bunch of pearl.

**pearl, bouton;** → button pearl.

**pearl, button;** → button pearl.

**pearl, calculation of;** → base price of pearl.

**pearl candling;** → candling pearl, lucidoscope.

**pearl cardiometer;** → cardiometer (pearl).

**pearl, care and preservation of;** natural and cultured pearls lose their orient and tend to crack this is caused by drying out of the conchiolin an organic component, or dissolving of carbonate, generally aragonite by weak acids, such as mostly cosmetics, resulting in the pearl becoming barrel-shaped or by grease, which entered the drill hole by capillary attraction that attacks the pearl. Grease is in certain cosmetics and of/in the skin. To protect the pearls from damage they should be cleaned periodically, frequently wearing and occasionally restringing with nylon string and knot between pearls.

**pearl, cave;** → cave pearl.

**pearl cement;** a white sealing material used as to cement pearls, which is made of thermoplastic shellac-based substance wax used to cement mount peg in the hole of pearl by softening. Sold in paper-wrapped sticks similar to a white sealing wax.

**pearl, cementation of;** a white sealing wax used to cement mount peg in the hole of pearl by softening of wax. → Dog-leg.

**pearl, chicot;** → blister pearl.

**pearl, Chinese drilled;** → Chinese drilling (pearls).

**pearl, clam;** → clam pearl.

**pearl color;** → pearl, colored pearl.

**pearl colored;** → pearl, colored pearl.

**pearl colored amber;** a term referred to white to grayish-white colored amber.

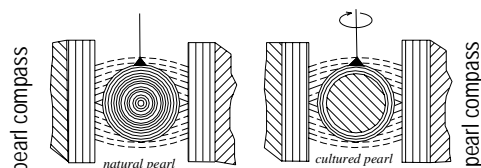
**pearl compass;** a device for detection of a true pearl from a cultured pearl. A pearl (or any crystal) is placed on the end of a glass rod and hung between the two poles of powerful electromagnetic field. A true pearl remain, while the cultured pearl tend to turn till the mother-of-pearl core orient itself parallel to the lines of the magnetic field, while there is only one position that a cultured pearl does not turn.

**pearl composition;** → pearl.

**pearl, conch;** → conch.

**pearl corundum;** ruby corundum with pearly bronze

iridescent luster.



*susceptibility action of natural and cultured pearl in a magnetic pearl compass. Natural pearl has no turning. Cultured pearl layers tend to orient themselves in line with the magnetic field therefore pearl moves*

**pearl, cultured;** → cultured pearl.

**pearl cultivation;** same as cultured pearl.

**pearl, cyst;** → cyst pearl, encystation (of pearl), blister pearl.

**pearl de Meisner;** same as Meisner pearls, de.

**pearl, density;** → pearl.

**pearl diver;** one, who dives for collecting the pearl mollusks. Also called pearl fishers.

**pearl Dobo;** a peeling center for pearls located south of Indonesia, sometimes named Dobo pearl.

**pearl doctor;** one, who skillful removed the bad surface or blemishes layer of pearls to enhance its appearance by using of scrapers, abrasives and sensitive touch. Obtained pearl is smaller. Some pearls with cracks on the surface are soaked in warm olive oil to *cure* or improved their appearance, this technique is called *decraqueler*. Such a pearl tend to turn to brown color in temperature about 150° C. Cosmetic surgeon of the pearl is called pearl doctor. → Pearl skinning, bleaching of cultured pearls.

**pearl doctor;** sometimes used for peeler.

**pearl doctoring;** → pearl doctor.

**pearl doublet;** → cultured blister pearl.

**pearl, drilling;** → drilling pearls.

**pearl drop;** a commercial term for an irregular pear shaped true or cultured pearl or imitation pearl set with an attached ring for making ear-ring or other pendants. → Drop-form pearl.

**pearl, drop-shaped;** → drop-shaped pearl.

**pearl, dyed;** → dyed pearl.

**pearl endscope;** same as endoscope.

**pearl essence;** same as essence d'orient.

**pearl essence, synthetic;** → synthetic fish-scale essence, essence d'orient.

**pearl eye;** an exact rounded natural pearl without doctoring.

**pearl, famous;** → famous pearls.

**pearl fancies;** → breeding, pearl-like structure, germination.

**pearl fish;** a term applied to a small eel-like fish but it is not eel. It is a member of Carapidae living as

parasites inside of Holothuroidea similar to sea cucumber or béche de mer, which as parasite enters the pearl-bearing oyster and become trapped and coated, with nacreous secretion to create a pearl. → Rotifer.

**pearl fisheries;** many famous and important pearl fisheries or farms are on the Arabian coast of Persian Gulf, Gulf of Mannar, Sri Lanka, north-west coast of Australia, south coast of Myanmar, Tahiti, Pacific islands, New Guinea, Gulf of Mexico, Venezuela, Japan, Californian coasts, Borneo, etc. → Pearl.

**pearl fishers;** same as pearl diver.

**pearl fishing;** same as pearl fisheries.

**pearl fishing-ship in Red Sea;** there are small vessels, which is known as sadbuku? or sambuku?

**pearl, flames;** → flames.

**pearl, fluorescence of;** → fluorescence of pearls.

**pearl formation;** → pearl.

**pearl, free;** same as free pearls.

**pearl, fresh-water;** → fresh-water pearl.

**pearl, fresh-water (mussel);** → fresh-water pearl.

**pearl from three ridge mussel;** → blue-point mussel.

**pearl from Unio mussel;** → Unio mussel.

**pearl garnet;** a term applied to andradite garnet of dark brown color.

**pearl gauge;** a scale instrument used in the trade to help measure the weight, dimension, distance (thickness, height), capacity, properties or a device of estimation the weight of spherical pearls by increasing series of piece.

**pearl grading;** pearls are graded into shape, size and color. The sizes and shapes are vary. Usually the pearls are classified in 3 main grades: A good, B medium, C poor, and these are divided into 3 subdivisions according to their color, luster, and condition of surface. → Pearl.

**pearl grain;** a small unit of weight for pearl equal ¼ or 0.25 metric carat. Inferior pearls are sold by the carat.

**pearl haliotis;** a highly iridescent genus of Haliotidae mollusk, a species of ear shell, also called ormer, which furnishes mother-of-pearl. Produces colored baroque pearls with the same iridescent as surface of shell. Found in the waters of California, Mexico, New York, Japan, also found in the Atlantic Ocean. → Abalone.

**pearl, hem;** → hem pearl.

**pearl identification;** → cultured pearl identification, cultured pearls,-discrimination.

**pearl illuminator;** an instrument for illumination of pearls. For exterior illumination a nacescope is used, for illumination of the drill hole, pearlscope or endoscope, which is provided with a hollow needle with two mirrors.

**pearl, imitation;** → imitation pearls.

**pearl in medicine;** very small seed pearls, which are

badly cracked or broken, are used for medical purpose in some country, in Far East because the people believed they are useful as aphrodisiacs.

**pearl, internal structure of cultured;** a thin section of cultured pearl shows that it has parallel-banded layers in the core with a few concentric outer layers.

**pearl, internal structure of natural;** a thin section of natural pearl shows that it has a concentric structure of layers in the core through the outer layers.

**pearl iridescence;** same as iridescence of pearls.

**Pearl King, the;** a name applied to Kokichi Mikimoto, Japanese cultured pearl producer who successfully marketed cultured pearl until today.

**pearl Lauegrams;** → Lauegrams.

**pearl, ligament;** → ligament pearl.

**pearl-like structure;** some people asserting that sometimes pearl-like structure occur in plants such as coconut resemble in appearance and color the true pearls. Other unusual asserting is ranging from boars, heads, coconuts, clouds, bamboos and elephants.

**pearling;** another term for pearl fishing.

**pearlite;** a combination of ferrite and cementite formed in steels, when slowly cooled.

**pearlite;** a misleading spelling of perlite.

**pearl lucidoscope;** → lucidoscope.

**pearl luminescence;** the true pearl glows yellowish, greenish, pale blue, purplish under LWUV and SWUV rays. Genuine fresh-water pearls always shows yellowish-green to white under X-rays. Cultured pearls are inert.

**pearl luster;** generally a high luster from the translucent surface of true and cultured pearls, which varies to dull depending on the nature of the pearl. Not to be confused with orient.

**pearl, mabé;** same as cultured blister pearl or mabé pearl.

**pearl mantle;** same as cyst pearl.

**pearl measurement;** unit of weight for pearls are grain equal ¼ or 0.25 metric carat. The inferior and cultured pearls are sold by the carat.

**pearl mica;** another term for margarite.

**pearl microscope;** a binocular microscope provided with special attachment as illuminator and rotating stage for pearl testing or *pearl cardiometer*. Also called pearlometer, perlometer and pearlscope.

**pearl, mollusk;** pearls obtained from mollusks.

**pearl, momme;** same as momme.

**pearl, muscle;** same as muscle pearl.

**pearl, mussel;** same as fresh-water or mussel pearl of the genus *Unionidae*. → Fresh-water pearl, mussel pearl.

**pearl, natural;** same as natural pearl. → Pearl.

**pearl necklaces;** a pearl necklace composed principally

of round or nearly round pearls, nearly same color, orient and size called *uniform* and various length are named as choker, opera, and rope. Or in some necklaces the size of beads increased from each end to a large central pearl or spherical bead, known as *graduated*. → Collier de chien, graduated necklace strings (pearl).

**pearl necklaces, length of;** the size of uniform necklace varies from 3 mm to 12 mm in diameter, and the standard length are 36 cm (14 inches) is termed *choker*, 54 cm (21 inches) is known as *matinee*, 70 cm (28 inches) is called *opera*, and 108 cm (42 inches) is named as *rope*. Graduated necklaces are an average 44 cm (17 inches) long.

**pearl, non nucleated cultured;** → non-nucleated cultured pearls.

**Pearl of Asia;** a very important baroque-shaped pearl of 605 cts, because of historic as well as biological interest, which belonged to the Emperor of China in the 16<sup>th</sup> century. It has the shape somewhat like an elk's tooth but more cylindrical. In 1918, it was bought by the Foreign Missions of Paris. Also called the Pearl of Asia.

**pearl oil;** same as Antilles pearl.

**pearlometer;** same as pearl microscope.

**pearl opal;** synonym for cacholong.

**pearl, oriental;** → Oriental pearl.

**pearl, orient of;** → orient.

**pearl, origin of;** there are many theories on the origin of pearl formation: such as flashes of lightning, parasites, concretions, eggs of the mollusk, sand grains, solidification of shell-forming liquids, modification of eggs, worm parasite, Distomum, Entozoa, shell substance, etc. An ancient believing said when a pearl-bearing oyster coming to the water surface a drop rain caught in the mouth of the pearl oyster, which by the time turns in a pearl.

**pearlscope;** same as pearl microscope.

**pearl oyster;** a general term for any salt-water pearl-bearing mollusks of genus *Margaritifera* those pearls are in various sizes and colors. → Oyster pearl.

**pearl oyster enemies;** there are a few enemies that the oyster has to battle with such as skated, starfish, filefishes, sponges, boring mollusks and parasites.

**pearl peeler;** same as peeler or peeling.

**pearl, pear-shaped;** → drop-shaped pearl.

**pearl, Persian Gulf;** → Persian Gulf pearl.

**pearl, pink;** → pink pearl.

**pearl, plugging of;** → plugging of pearl.

**pearl, piqué marks on;** → piqué marks on pearls.

**pearl, poor quality of;** mostly poor-quality and very small pearls are used as a medicine because to say it have aphrodisiac properties? → Pearls in medicine.

**pearl, preservation** → pearl,-care and preservation of.

**pearl, price calculation of;** pearl of any size computed by squaring its weight in *grains* or carats and multiplying the result by the base price, which is known as the base system of pearl valuation. Pearl grain is a quarter of metric carat or 0.25 cts. Also called square method. The grain known in the trade as *once the weight*. The smaller size pearls are not sold in base system but in per carat. → Square.

**pearl producer;** a local term used by Japanese pearl fishers in Lake Biwa that the male shell of *Hyriopsis schlegeli* when fed with the female tissue (such as *Anodonta cygnea* tissue insert in male shell), produces pearl of non-nucleated cultured pearl of a particular color.

**pearl radiogram;** same as X-ray photography of pearls. → Lauegrams.

**pearl, river;** variety of fresh-water pearls found in various mussels. → River pearl.

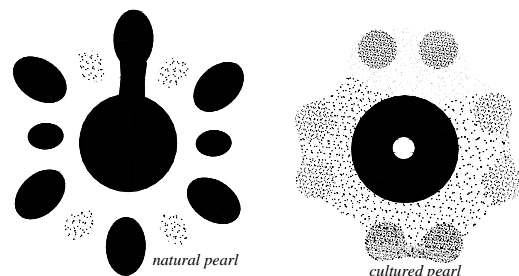
**pearl, Roman;** → Roman pearl.

**pearl, rosé;** → rosé pearl.

**pearl sac;** a pouch of epithelial cells, which formed surround the irritant agent or a small parasite such *cestode worm* or a *trematode worm*, usually the small foreign nucleus that entered the shell by naturally in the mantle of the oyster, which is named as sac or cyst. This sac forms the cyst of true or cultured pearls. By production of non-nucleated cultured pearl a piece of graft tissue is placed into the mollusk.

**pearl, Scotch;** those fresh-water pearls that are found in the rivers of Scotland. → Fresh-water pearl.

**pearls diffraction pattern by X-rays;** an experimental X-ray method by Lauegrams involving testing of



X-ray Laue-gram of natural and cultured pearl

natural pearls and cultured pearls, according to known experiments, which should give a different pattern in one direction with cultured pearls.

**pearl, seed;** → seed pearl.

**pearl shape and qualities;** pearls of good quality must have perfect spheres, when pear-shaped but symmetrical, smooth surface, lacking raised spots, pits, ridges, chalky or discolored appearance, drill holes must be just large enough. → pearl, shape of pearls.

**pearl, shape of;** → shape of pearls.

**pearl shell;** pearl oysters of the genus *Pinctada maxima* or *Pinctada margaritifera* has been cut as small cabochon, tumbled, spherical, and drilled pieces. Prized for buttons, knife handles, veneers, small spoons, inlays, and carving articles such as cameos and intaglios, because of its fine iridescence and luster, large quantities, and thickness. Large quantities are found in tropical waters of Tahiti and northern Australia. When the shells have been brought up from the sea water a broad flat-bladed knife is used to open the oyster for searching of pearls. Later the shells from tropical waters are sorted into qualities and named as Myanmar (Burmese) shell, Philippines shell, Manila shell that from Mergui archipelago, etc. → Shell, pearl.

**pearl shell cut;** large quantities are cut cabochon, tumbled, spherical, and drilled pieces.

**pearl-ship minder;** one how standing in pearl-fishing ship to hauling the diver up as fast as possible when the diver make a sharp tug on the rope attaching to his body.

**pearl-shooting;** artificial color treating or dying of pearls.

**pearl sinter;** a variety of fluorite.

**pearl size;** as with other gemstones the individual rarity of large specimens is important for price. The size of pearls ranges from *very large* over 8 mm, *large* 7-8 mm, *medium* 5-6 mm, *small* from 3-4½ mm, *very small* less than 3 mm. → Dust pearl, pearl necklaces, -length, pearl.

**pearl skinning;** a skillful technique for removing the bad-colored surface or blemished external layers of pearls to enhance its appearance. After that the pearl is smaller but more attractive than before. → Pearl doctoring.

**pearl spar;** a white, gray, pale yellow variety of dolomite with a pearly luster. Sometimes associated with galena.

**pearl spar;** synonym for ankerite. Also spelled pearlspar.

**pearlspar;** same as pearl spar.

**pearl, specific gravity of;** because of variable composition of pearls, the specific gravity ranges from 2.65 to 2.78. For example; Persian Gulf pearls 2.68 to 2.74 in average 2.715, from Venezuela 2.65-2.75 in average 2.70, from Australia 2.68-2.78 in average 2.74, fresh-water from North America 2.66-2.78 and over. → Pearl.

**pearl staining;** artificial process of changing the color of light colored pearls is not very successful, but the process is often applied to colored pearls to make black pearl. The pearls are soaked in a weak liquid of silver nitrate and placed under ultraviolet light or sunlight due to reducing of silver by action of organic constituent.

The dried silver give to the pearl the hue of black that is known as *buffed up*, which means improving the color of pearls by staining. X-ray irradiation on pearl can cause darkening of not desirable effect. → Dyed pearl.

**pearlstone;** another term for perlite.

**pearl stringing;** → Bombay bunch of pearl.

**pearl, surface structure of;** the irregular edges of the overlapping crystal plates of aragonite cause the optical effect, luster or orient, which are best seen by microscopically study the surface of pearls. This surface structure of overlapping platelets of pearls gives a peculiar rough feeling to the teeth, while the imitation pearls are smooth to the teeth. → Pearl.

**pearl, synthetic of Majorca;** a kind of synthetic pearl made in Mancor in Majorca Island of Spain, which is hardly to distinguish from true pearls. The surface of these pearl has not warty appearance as a true pearl. Also called Majorca or Mallorca synthetic pearl.

**pearl testing;** many method exist to test the natural and cultured pearl and its imitations with experimental devices such as pearl microscope, lucidoscope, specific gravity, pearl compass, X-ray, UV light, endscope, Lauegram, etc.

**pearl-testing microscope;** same as pearl microscope.

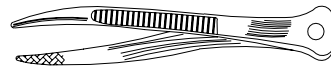
**pearl-testing stage;** same as stage used in microscope or pearloscope.

**pearl tongs;** special tongs with small concave hemispheres ends for holding the pearls.

**pearl, treatment of;** → pearl, -care of, pearl staining, pearl doctoring.

**pearl, Tridacna;** a kind of conch pearl obtained from giant clam *Tridacna gigas*.

**pearl tweezers;** tongs are for the handling of pearls, made of stainless steel, with rather blunt, rounded tips, scored inside to prevent the stone slipping, and with a mild spring. Also



pearl tweezers

called pearl tongs.

**pearl used in medicine;** fancy-shaped pearls with not attraction is ground up and mixed with distilled water for medicine purposes such as digestive aid or as tomb pearl. To say it has aphrodisiac properties.

**pearl varieties;** pearls are produce by pearl oyster, or mollusks such as conch pearl, mussel pearl, abalone pearl, clam pearl, in addition to those are mollusc shell, fresh-water pearl, and coque de perle.

**pearl valuation;** → base price of pearl.

**pearl, Venezuela;** salt-water or fresh-water pearls from Venezuela.

**pearl, worn barrel-shaped;** an old term for well-worn,

barrel-shaped pearls in necklace.

**pearl, X-ray tests;** → pearls diffraction pattern by X-rays.

**pearly;** having a iridescent luster of a pearl or pearly luster such as cleavage surface of some minerals.

**pearly;** pertaining or resembling to/of the pearl, or nacreous.

**pearly alabaster;** alabaster with pearly luster. Also called nacreous alabaster.

**pearly nautilus;** same as nautilus shell.

**pearly luster;** a luster like pearl that is caused by combination of luster and body appearance, such as pearl, moonstone, mother-of-pearl, etc.

**pearly luster;** pearly luster can be seen with some easily cleavable minerals such as gypsum. Also called pearly.

**pear pearl;** same as drop-form pearl or drop pearl but more specially.

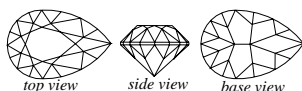
**pears;** same as pear-shaped pearl. → Elenchi.

**pear-shape brilliant cut;** a modified brilliant cut resembling a pear, usually 56 to 58 facets, having a pear-shaped girdle outline. Also called pear-shaped cut. → Pendeloque.

**pear-shape;** same as pear-shaped cut.

**pear-shape;** sometimes used to describe the shape of earth.

**pear-shaped cut;** a modified brilliant cut usually having 56-58 facets with a pear-shaped girdle outline. Also called briolette, pendeloque, pear-shaped brilliant cut.



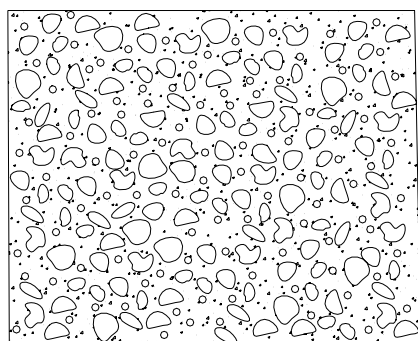
*pendeloque brilliant-cut with 57 facets*

**pear-shaped pearl;** another term for elenchi.

**pear-shaped rose cut;** a combination of rose cut which has a pear-shaped girdle outline, with usually 24 triangular facets, a flat uncut base and no table. → Pendeloque rose cut.

**peastone;** same as pisolite, pea grit.

**pebble;** a minute, smooth, roundish, windworn or



*rounded sand pebbles*

waterworn stone, having a diameter ranging from 4 to 65 mm. Also called pebblestone.

**pebble;** any roundish rough gem material occurring in the form of a pebble.

**pebble;** any transparent and colorless quartz crystal from Brazil, which is used in optics. Also called *Brazilian pebble* and rock crystal.

**pebble crystal;** a roundish waterworn or windworn quartz crystal.

**pebblestone;** same as pebble.

**pebble ware;** a variety of wedgwood, which has different colored clays in the paste.

**Pechopal;** a German spelling for pitch opal.

**Pecos diamond;** a misleading term for a variety of quartz crystal from the Pecos River, Texas, and New Mexico, USA. Also called Pecos River diamond or Pecos Valley diamond.

**Pecos River diamond;** same as pecos diamonds.

**Pecos Valley diamond;** same as pecos diamonds.

**pectolite;** a massive inosilicate mineral sometimes cut cabochon and prized by collectors, having a weak chatoyancy. Used as a jade imitation. Varieties are schizolite, serandite, and manganopectolite containing manganese. *Larimar* is a local commercial term for Pectolite from Dominican Republic. Massive green variety is misleadingly named as pectolite-jade.

System: triclinic.

Formula:  $2[\text{Ca}_2\text{NaH}(\text{Si}_3\text{O}_9)]$ .

Luster: vitreous to silky.

Colors: colorless, pale yellowish to yellowish green.

Streak: colorless, silky to pearly.

Diaphaneity: translucent.

Cleavage: {100} perfect, and {001} perfect.

Fracture: not diagnostic. Brittle.

SG: 2.68-2.88.

H: 4½-5.

Optics;  $\alpha$ : 1.595-1.610,  $\beta$ : 1.605-1.615,  $\gamma$ : 1.632-1.645.

Birefringence: 0.036. ⊕.

Found in Greenland, Canada, Sweden, Scotland, Italy, Russia, Dominican Republic, Japan, South Africa, New Jersey, Alaska, and California (USA).

**pectolite cut;** a soft mineral suitable for carving ornamental objects and tools, cut into cabochon and prized by collectors, having a weak chatoyancy.

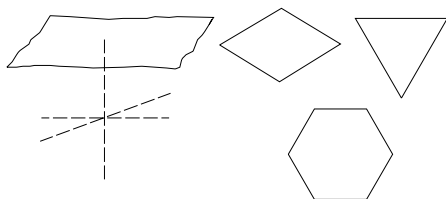
**pectolite jade;** a commercial misleading term for massive, green pectolite resembling jade.

**pectolite luminescence;** orange, pink, yellow, and cream-white under LWUV. Stones from different localities show other luminescent: from Scotland greenish-yellow, from California yellowish-orange and orange with greenish parts.

**pectoral;** an ornament worn on the breast.

**Pectoral;** Breastplate worn by a Jewish High Priest.

**pedion;** in crystallography an open crystal, form which only has a single face. Also called monohedron.



*different pattern of pedion or monohedron*

**Pedrara onyx;** a misleading term for a fine white green, stalagmite marble from Pedrara Mine, Mexico, south of San Diego. The rock is veined and multi-colored.

**pedra de estrelada;** Portugesian term for asteria.

**pedra fina;** Portugesian term for gemstone.

**pedra preciosa;** Portugesian term for precious stone.

**pedra verde;** Portugesian term for nephrite.

**Pedro, Dom, Emerald;** same as Devonshire Emerald.

**peel-back;** same as peeling.

**peeled;** the process of skinning of some tourmaline with the fingers occur like an onion such as Brazil tourmaline.

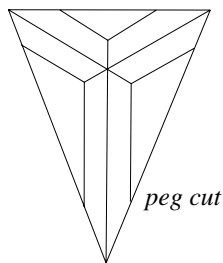
**peeler;** → pearl skinning.

**peeling;** the process of pearl skinning. Also called peel-back.

**peesal;** another spelling of pisal.

**peganite;** a variety of variscite from Saxony, Germany.

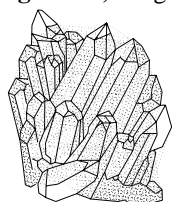
**peg cut;** a modified triangular cut similar to a peg with 9



*peg cut*

facets. Having an outline of a half a kite.

**pegmatite;** a light-colored, coarse-grained igneous rock from granite clan containing orthoclase, quartz, microcline, mica, gemstones, and many ferromagnesian minerals resulting from slow



*pegmatitic somky quartz crystals*

solidification. Pegmatite is occurring place of many uncommon gem minerals such as beryl, topaz, tourmaline, etc. Also called giant granite.

**pegmatitic;** pertaining to or having the character of a pegmatite.

**pegmatolite;** same as orthoclase.

**peg setting;** a style of setting of a flat-based hemisphere stone such as half pearl or rose-cut diamond set in a

finger ring or ear-stud, which is fastened into the hole drilled into bottom of stone and the stone is cemented with a special glue to the metal base.

**peg setting;** sometimes a group of gemstones are arranged and wired closely to the metal base.

**pei;** a Chinese term for a dangling pendant carved from jade. → Chinese ritual and symbol jades.

**Peiping jade;** any true jade from Peiping, one of China's markets, most are nephrite one of the two kinds of jade. Also called Peking jade.

**pei-tung;** brush holders similar to vase made from ivory tusks in China, for this purpose the hollow part of the ivory was suitable.

**pekapeka jade;** a Maori term for a bat cut on jade for ornamented purposes or amulet by native of New Zealand.

**Peking jade;** same as Peiping jade.

**pelecypods;** → mollusk, bivalves.

**pelhamite;** a light green variety of serpentine of precious quality from Pelham, Massachusetts, USA.

**peliom;** an obsolete term for cordierite.

**pelle d'angelo;** an Italian term for a kind of rose-red coral.

**Pellegrina Pearl;** a misspelled term for La Pellegrina Pearl.

**Pelikaanstraat;** a historic street of diamond industry centered in Antwerp, Belgium.

**pelolithic;** same as argillaceous.

**PEMA;** an acronym for Companhia de Pesquisas Mineras de Angola, Africa.

**pen;** a Chinese term for a sword guard carved from jade. → Chinese ritual and symbol jades.

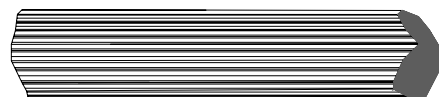
**pencil-band opal;** a term used by Australian miners for narrow opal seam up to 2-3cm in thickness.

**pencil cleavage;** fracture with long slender pieces of rock.

**pencil diamond;** same as writing diamond.

**pencil ore;** a hard variety of kidney ore or sometimes hematite, which breaks up into pointed fibrous fragments, found in Cumberland, England.

**pencil stone;** a compact variety of agalmatolite used for



*pencil tourmaline*

making slate pencils.

**pencil tourmaline;** slender, acicular or pencil-like crystal of tourmaline.



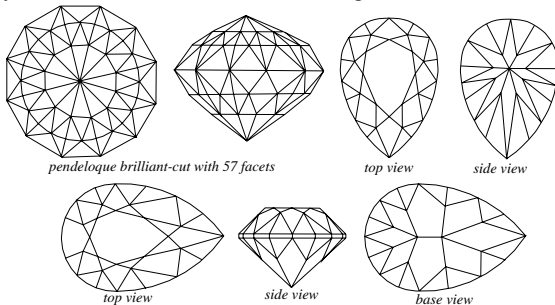
**pendant;** an ornamental object such as amulet, pectoral cross, miniature, etc. hung from a necklace or neck chain, worn for its own sake.

**pendant cut;** same as pendeloque cut. → Pendeloque.

**pendant-cut brilliant;** same as pendeloque cut. → Pendeloque.

**pendeloque;** a pear-shaped brilliant cut that is frequently drilled near the apex for use as a pendant from a necklace or a brooch. The term pendeloque was anglicized as pendant cut or pendant-cut brilliant. → Pendeloque cut.

**pendeloque cut;** a modification of the pear-shaped or pyriform brilliant cut, so that the girdle has an outline



*different pendeloque cuts*

similar to pear shape with a narrow end longer and pointed. It has a total of 56 facets and an irregular 8-sided table.

**pendeloque rose cut;** a modification of rose cut brilliant diamond or other gemstones, so that the girdle has an outline of the pear shape. It has 24 triangular facets, a flat un-faceted base and no table. → Pear-shaped rose cut.

**penetration hardness;** → indenter test for hardness.

**penetration twin;** → interpenetration twin.

**penetration twin in corundum;** → inclusion in corundum.

**Penfield balance;** → hydrostatic weighing.

**Peninsula of Sambia;** same as Samland.

**penlight torch;** → Hanneman penlight torch.

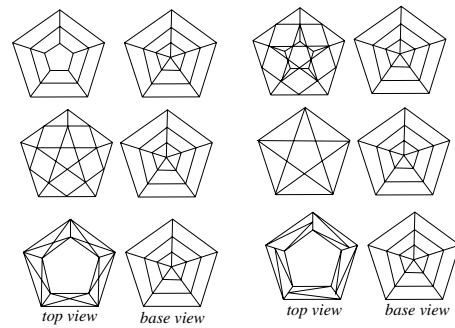
**Penner River;** location of an ancient alluvial diamond-bearing river in the State Hyderabad, India. → Golconda.

**Pennsylvania diamond;** a misleading term for pyrite.

**pennyweight;** a unit for the valuation of gold and jewels equivalent to 24 grains,  $\frac{1}{20}$  or 0.5 ounce troy, 7.776 carats, 1.5552 grams.

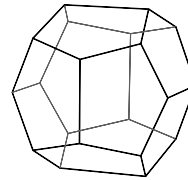
**pentaamine chlorodichloride;** → irreversible thermo-chromic.

**pentagon cuts;** a fancy polygon cut of diamond which consists of 5-sided step-cut and large to small 5-sided table, with the sides of equal length. In some cuts can be seen 5-rayed star. Pavilion consists of 5-sided step-cut without culet.



*six different kind of pentagon-cuts*

**pentagonal dodecahedron;** a crystal of isometric system comprised of 12 identical five-sided faces with the indices {210}. Also called regular dodecahedron, pyritoid or pyritohedron, while



*pentagonal dodecahedron or pyritohedron*

pyrite crystallizes in this form.

**pentagon facets;** a British name for quoin and pavilion facets used in diamond work at Brighton.

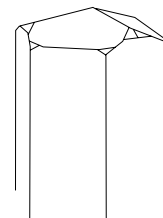
**pentelicum marble;** a white granular marble from the Mount Pentelicus near Athena, Greece.

**Penthièvre Diamond;** an oval, yellow brilliant-cut diamond of 12 cts, belonged to Duc de Penthièvre (1725-1793). After it was passed down through a few hands, it was bequeathed by the Duc d'Aumale together with the Grande Condé diamond, in 1886 to L'Institute de France. Now it is mounted in a head band and is on display at the Musée de Condé in Chantilly, France.

**pentimenti;** an Italian term for a painting that has been over-painted later. Also spelled pentimento.

**pentimento;** same as pentimenti.

**pentlandite;** rarely cut into cabochon or as faceted gem, it is prized by collectors. Commonly intergrown with



*pentlandite crystal*

pyrrhotite. Also called nicopyrite, folgerite.

System: cubic.

Formula:  $4[(\text{Fe}, \text{Ni})_9\text{S}_8]$ .

Luster: brilliant metallic.

Colors: pale bronze yellow to brown.

Streak: greenish-black to black.

Diaphaneity: opaque.

Cleavage: none.

Fracture: conchoidal. Brittle.

SG: 4.60-5.00.

H:3½-4.

Found in Finland, Transvaal (South Africa), Alaska, California, and Nevada (USA), Ontario (Canada).

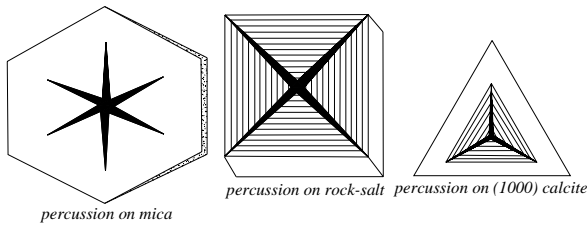
**peppered inclusions in beryl**; same as peppery inclusions in beryl.

**peppery inclusions in beryl**; a term used for minute platelets of phlogopite and drop-shaped cavities in beryl or emerald giving peppery or speckled appearance. Also called peppered inclusions in beryl.

**perasidite**; another term for silexite.

**perception of color**; → color perception.

**percussion figure on minerals**; usually a minute pattern



*percussion on minerals*

or radiating or depressing occurring on a section of a mineral by a blow such as mica, halite and calcite.

**percussion mark**; usually a minute white mark often outlined by tiny curved cleavage or fractures on the surface of the hard pebbles such as quartzite or chert due to sharp blow. Also called bruise.

**perdine**; amethyst from the Montezuma Mine, Brazil, which change its color to milky green by 650° C, due to reduction of ferric iron to ferrous iron.

**peredell topaz**; pale green to yellowish green variety of topaz.

**Peregrina Pearl**; a misleading term for La Peregrina Pearl.

**perfect**; an undesirable term for grading of diamonds. It is a term prohibited by USA government for flawless diamond under 10x magnification, which discloses other flaws or blemishes.

**perfect**; generally it means exact, flawless, and complete.

**perfect cleavage**; eminently displayed cleavage with a smooth surfaces such as in mica and calcite. Also called eminent cleavage.

**perfect color**; → perfection color.

**perfect crystal**; a single crystal without lattice defect throughout.

**perfect cut**; a term prohibited by the American Gem Society, while ideal perfect cut are very rare.

**perfect mineral cleavage**; same as eminent mineral cleavage.

**perfect stone**; a commercial term for a flawless gemstone.

**perfect stone**; a color of gemstone or diamond that has internally minute inclusions or other flaws which makes less undesirable and frequently desirable.

**perfection color**; it means colorless diamonds.

**perfection color**; a synonym for fine color and quality of a gemstone.

**perforated beads**; to pierce an irregular design through a bead.

**perforated rock**; pierced rock.

**periclase**; rarely cut but prized by collectors. Has been synthesized and marketed as *lavernite*, used as a spinel imitation. Also called native magnesia and spelled periclasite.

System: cubic.

Formula: 4[MgO].

Luster: brilliant vitreous.

Colors: colorless, pale yellowish to brownish yellow, gray, white, green.

Streak: white.

Diaphaneity: translucent, rarely transparent.

Cleavage: {100} perfect.

Fracture: irregular. Brittle.

SG: 3.70-3.90.

H:5½-6.

RI: 1.736.

Found in Texas, New Mexico, and California (USA), Sardinia, Monte Somma (Italy), and Sweden.

**periclase, absorption spectrum**; weak absorption bands have seen at 540, 485, 467, and 416 nm.

**periclase, luminescence**; pale yellow Luminescence under LWUV ray.

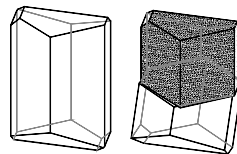
**periclase, synthetic**; → synthetic periclase.

**periclasite**; same as periclase.

**pericline**; a milky-white, translucent variety of albite feldspar formed as elongated crystal in the b-axis. Found in alpine veins.

**pericline**; a type of twinning in feldspars with the twin axis [010].

**pericline twinning law**; a type of parallel twin in triclinic feldspars with the twin axis [010] and the composition surface is a rhombic section. It may occur alone or with albite twin law.

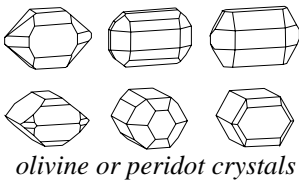


*pericline crystal and twin twin law.*

**peridine**; a fancy name combine of peridot and citrine.

**peridine**; a commercial term for amethyst quartz which change color into green by heat-treatment.

**peridot;** a transparent to translucent gem variety of olivine (Mg,Fe)<sub>2</sub>SiO<sub>4</sub>, which ranges from pale yellow-green to pale olive-green, dark green. Cut as gem polished by tumbling, sometimes seen as cat's-eye and star olivine. Also called chrysolite and incorrectly spelled peridote. A brown color variety of sinhalite was erroneously called brown peridot. Oriental chrysolite is a misleading term for yellowish-green variety of sapphire or a for yellowish-green variety of chrysoberyl. Aquamarine chrysolite is an incorrect name for greenish-yellow beryl. Saxony chrysolite is a pale greenish-yellow topaz. Misleadingly called evening emerald. → Olivine. Also erroneously called Brazilian peridot, bastard emerald, Ceylon (Sri Lanka) peridot or *Brazilian chrysolite* is a misnomer for green variety of tourmaline.



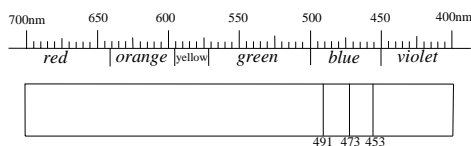
star olivine. Also called chrysolite and incorrectly spelled peridote. A brown color variety of sinhalite was erroneously called brown peridot. Oriental chrysolite is a misleading term for yellowish-green variety of sapphire or a for yellowish-green variety of chrysoberyl. Aquamarine chrysolite is an incorrect name for greenish-yellow beryl. Saxony chrysolite is a pale greenish-yellow topaz. Misleadingly called evening emerald. → Olivine. Also erroneously called Brazilian peridot, bastard emerald, Ceylon (Sri Lanka) peridot or *Brazilian chrysolite* is a misnomer for green variety of tourmaline.

System: orthorhombic.  
 Formula: (Mg,Fe)<sub>2</sub>SiO<sub>4</sub>. It contain traces of Cr, Mn, and Ni.  
 Luster: oily to vitreous.  
 Colors: olive-green to yellowish green, green-black  
 Streak: white.  
 Diaphaneity: transparent to translucent.  
 Cleavage: {010} perfect, and {010} distincts.  
 Fracture: conchoidal to uneven. Brittle.  
 SG: vary with the composition 3.22-4.40.  
 H:6½-7.  
 Optics; α:1.654, β:1.671, γ:1.689.  
 Birefringence: 0.035. ⊕.  
 Dispersion: 0.020.

Found: gem variety peridot are found in Isle of Zebirget or St. John (Egypt), Hawaii, California, Massachusetts, New Mexico (USA), China, Kenya, Norway, Italy, Myanmar, Mexico, Finland, Greenland, Brazil, etc.

**peridot;** a misnomer for yellowish-green gem variety of tourmaline.

**peridot, absorption spectrum;** characteristic spectrum of peridot bands are at 493, 473, and 453 nm.



peridot absorption spectrum

Frequently seen in the orange at 653 nm and in the green at 529 nm due to iron content.

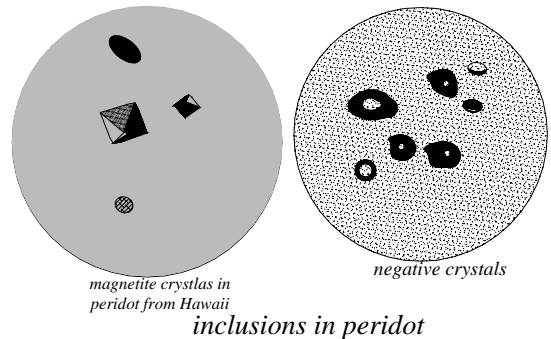
**peridot, brown;** a brown sinhalite that was erroneously called as brown peridot.

**peridot cut;** cut as gemstones setting into pendants, brooches, finger ring, ear-ring, bracelets and are polished by tumbling, sometimes seen as cat's-eye and star olivine. → Peridot.

**peridot from Hawaii;** peridot from this island contains most curious inclusions resembling the bubbles seen in glass.

**peridot in basalt;** → basalt, corundum in.

**peridot, inclusions in;** inclusions in peridot are biotite crystallites, chromite grains, glass, small liquids and so-called *lily pads* in the form of discs, which are holes



inclusions in peridot

that sometimes contain a small chromite crystal at the center.

**peridot luminescence;** none luminescence under UV light or X-rays.

**peridot pleochroism;** weak: colorless to pale green, green and light green.

**peridot of Sri Lanka (Ceylon);** a misleading term for a yellowish-green gem variety of tourmaline.

**peridotite;** a dark colored, coarse-grained, phanocrystalline, ultramafic, plutonic igneous rock consisting of olivine, amphibole, biotite, and pyroxene, and containing little or no feldspars. Such rocks fill the

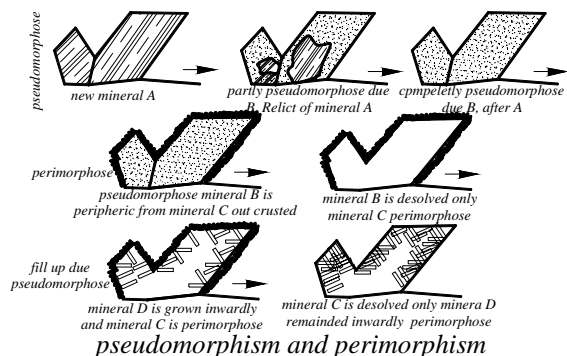


peridotite

diamantiferous pipes. Commonly altered to serpentinite rock. Lamproite and kimberlite are only two rocks known as diamond matrix both are peridotite.

**perigem;** a commercial term for pale yellow-green spinel used as gem imitation.

**Peri Lithon**; a book of stones written by Theophrastus.  
**perimorph**; a mineral enclosing another mineral, for example rutile in quartz. Quartz is perimorph and rutile



is endomorph.

**Periodic System of the elements**; the chemical chart of the elements in order of increasing atomic numbers, which are based on seven horizontally by atomic number and eight vertically by chemical group. The elements in each group show close chemical analogies. Each element, represented by its symbol and atomic number and occupies a separate square. → Appendices.

**periostracum**; a dark horny conchiolin outer or the first layer of a bivalve mollusk shells and brachiopods. Sometimes continued in form of several lamellae into inner part and named as prismatic layer, which is thicker outer layer. → Ike-chogai, prismatic layer.

**perisarc**; a gelatinous mass that is named as coenosarc surrounding by the chitinous layer or skin-like membrane covering the polyps or connecting parts of the colony.

**peristerism**; peristerism effects in albite peristerite.

**peristerite**; same as peristerite feldspar.

**peristerite feldspar**; a gem variety of moonstone-like sodium-rich plagioclase feldspar or albite with a white, cream, pink-brownish body color, which shows bluish-white or bluish opalescence. Internally displays a blue, green, and yellow flashy iridescence, caused by inhomogenous structure of stone. Sometimes called *pigeon stone*. Optics;  $\alpha$ :1.535,  $\gamma$ :1.544. Birefringence: 0.010.  $\oplus$ . Dispersion: 0.012. SG:2.53-2.62. Weak brownish glow under SWUV and LWUV light. Misnomerly called moonstone. Found in Ontario, Quebec (Canada), and Malagasy, Africa. Gem quality cut into cabochon, and beads.

**Perkin's mauve**; → mauvein.

**perla**; Spanish spelling of pearl.

**perlato**; pale colored marble containing scattered rounded algae or shell fragments.

**perle coq**; a French term for a hollow pearl.

**perle finé**; a French term for fine pearl.

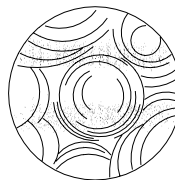
**perles au nacre**; a French commercial term for perls de

Indies.

**perles des Indies**; a misleading commercial term for imitation pearls provided from grounded nacre of mother-of-pearl.

**perlite**; a hydrated, acidic, volcanic glass having numerous curved sub-spherical and shell-like structure of rhyolitic composition, in which beads or ball-shaped pieces are found along the cracks. Generally have a high water content 2-5%, 10-12%  $Al_2O_3$ , and 65-75%  $SiO_2$ . Found in California and New Mexico, USA. Cut attractively cabochon of small sizes and beads. The correct term is pearlite. Also called pearlstone. → Perlitic texture

**perlite**; a term used for a variety of obsidian, which has



perlite of obsidian

numerous curved sub-spherical, and a shelly structure found along the cracks, which are beads or ball-shaped pieces.

**perlitic**; pertaining or consisting to/of perlite. → Perlitic texture, perlitic.

**perlitic texture**; texture of a glassy volcanic rock having numerous curved sub-spherical to spherical cracks due to contraction during cooling.

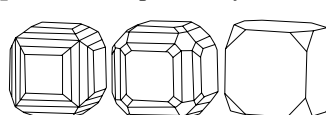
**perlometer**; a commercial term for pearl microscope.

**permanganate spectrum**; having five absorption bands, at 570, 545, 524, 504, and 487 nm.

**Permian**; final period of the Paleozoic era. The rock are intervenes between the Carboniferous and the Jurassic. The period of time from 280-225 million years ago (a duration of 55 million years), with corresponding system of rocks.

**perola**; Portuguese spelling of pearl.

**perovskite**; prized by collectors. Synthetic strontium



perovskite crystals

titanate or fabulite found in a similar manner to perovskite. Natural counterpart of fabulite with the same composition, is called *tausonite*

System: orthorhombic crystal structure but the crystals are pseudocubic.

Formula:  $8[CaTiO_3]$ .

Luster: submetallic to adamantine.

Colors: black-brown, yellow brown, grayish-black, rarely red

Streak: grayish-white.

Diaphaneity: Transparent to opaque.

Cleavage: {001} imperfect.

Fracture: subconchoidal to uneven. Brittle.

SG: 4.00-4.01.

H: 5½.

Optics: 2.340.

Found in Italy, Finland, Ural (Russia), Canada, and USA.

**Persian;** a commercial term for top-grade, compact, translucent edged turquoise material of blue color without flaws or inclusions.

**Persian Gulf;** an arm of the Indian Ocean, intervenes between South-western Iran and Saudi Arabia, which is separated from Indian Ocean by Strait of Hormoz. Famous for its high quality orient pearl fished on the Bahrain Island.

**Persian Gulf pearl;** the highest quality, delicate creamy colored natural pearl from pearl oyster genus *Pinctada vulgaris* of salt-water bivalve mollusks, which is now classified as *Pinctada radiata* known since early times (300 BC) on the Arabian and Bahrain Island coast of Persian Gulf. These pearl oysters sometimes extended to the Red Sea and the Gulf of Mannar between Sri Lanka and India. Persian Gulf and other oriental pearl marketed through Madras, India. → Lingah pearl.

**Persian Gulf pearls;** a gulf at south Iran encircled by Iran, Saudi Arabia, Qatar, Kuwait, and United Arab Emirates, ca. 900 km long by 165 km wide from the Strait of Hormoz is connected to the Gulf of Oman which open out into Indian Ocean and Arabic Sea. According to history pearls was fishing several centuries BC. Gulf of Persian is a valuable source for finest pearls over centuries. There are several islands such as Bahrain (ancient name Tylos, Tylion?, Dylion?, Tyrus?), Khark, Ghashm etc. Each diver at Persian Gulf has two ropes, one is attached to a heavy stone of ca. 25 kg weight for diving and the second rope is attached to a basket or bag for holding any oyster which the diver carried in his hand or hanging around neck, and for hauling the diver back from the deep sea to the surface. Each diver is weaponed with leather finger stalls to protect his fingers during plucking the mussels and a fix leather clips to his noses.

**Persian inscription;** a kind of calligraphy engraved on old precious stones worked in Iran. Mostly inscriptions are of several Islamic religious prayers, which can be seen in several museums in the world.

**Persian lapis;** now a misleading term for Afghanistan lapis, once Persian territory.

**Persian matrix;** lesser grade than Persian spiderweb, which has coarser lines or less patchwork. → Persian turquoise.

**Persian pearl;** some ancient records of pearls are writing on clay artifacts found in Persia that pearls was fishing several centuries BC.

**Persian red;** same as Indian red.

**Persian spiderweb;** an intense blue or light blue

turquoise with network of fine black-brown veins, which look like a mosaic at the surface of stone. Same as spiderweb turquoise. → Persian matrix.

**Persian turquoise;** a commercial term for finest quality turquoise from Kuh'e-Raies in Ma'adan, Nishapur, Khorassan. This mine is about 2,500 years old. Famous for its intense blue, light blue color.

**Persian turquoise;** a term for any turquoise mined from various deposits in Iran such as Baghu.

**Persian turquoise;** a misleading term for turquoise from Tibet, Egyptian, Turkestan, etc. marketed as Persian turquoise.

**Persian turquoise cut;** cut cabochon, briolette, pendant, and tumbled, frequently seen faceted stone, and some pieces are engraved in Eastern countries.

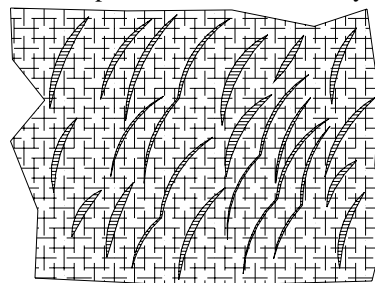
**Persia, Shah of ;** same as Shah of Persia Diamond.

**persistence;** same as afterglow.

**persistent lines of emission spectra;** → ultimate line.

**perspex;** a commercial term for a glass-like, polymerized transparent methyl acrylic resin a thermoplastic, of  $C_4H_5O.OCH_3$ , which can be suitably colored. Used as molded faceted cheap imitation stones for costume jewelry and for imitation pearls and other beads. RI:1.50-1.52. SG:1.18. H:2½. Same as diakon. Equivalent English term is lucite.

**perthite feldspar;** a megascopic, streak or sub-parallel intergrowth of albite or oligoclase in orthoclase or microcline feldspar, in which usually albite or



typical perthite of albite in orthoclase

oligoclase inclusions are exsolved, visible to the naked eye. The host and inclusions have been miscible to form homogeneous composition at high temperatures, but the one having been thrown out of mixed solution at lower temperatures. In green to blue-green color *amazonite* the main part is green microcline but the albite sub-parallel intergrowth are white. Usually the perthite is translucent, white, red, reddish-brown with golden yellow or white schiller. Has been dyed in various hues. Used as ornamental stone. Found in Quebec, and Ontario (Canada), and Scotland. → Microcline, microperthite, antiperthite.

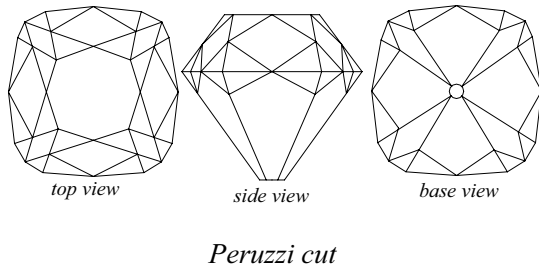
**perthite cut;** an ornamental stone, cut cabochon or tumbled gems.

**perthitic feldspar**; pertaining to or characteristic of perthite feldspar.

**Peruvian emerald**; a misleading term for true emerald mined during the conquest of Peru by Spain, which then belonged present-day to Colombia.

**peruza**; another Persian spelling for piruzeh (turquoise).

**Peruzzi cut**; an old style of cutting diamond with 57-58 facets and rounded corner. It is a cushion cut, which has 32 facets on the crown and an octagonal table, and 24 facets on the pavilion plus a culet. It is believed to be



the origin of modern brilliant cut and was improved by Vincenzo Peruzzi in 17<sup>th</sup> century over the earlier Mazarin cut.

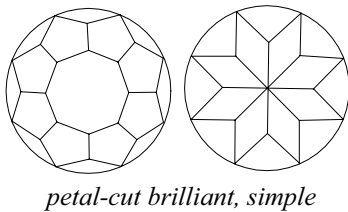
**Peruzzi, Vincenzo**; a Venetian lapidary who allegedly developed Peruzzi cut in the 17<sup>th</sup> century.

**pesal**; another spelling of pisal.

**peso especificio**; Spanish term for specific gravity.

**pestle and mortar**; → mortar.

**petal cut**; a modified brilliant cut, which resembles an 8-petalled flower, though the number of petals may vary. Pavilion facets are same as brilliant-cut but the girdle facets low triangles. Main



facets on the crown are pentagons abutting at table.

**petalite**; a framework silicate mineral. Cut as faceted gems and prized by collectors. Some stone shows chatoyancy such as petalite-analcime cat's-eye. Varieties are castor or castorite. Also called lithia-feldspar, lithium-feldspar.

System: monoclinic.

Formula:  $2[\text{LiAl}(\text{Si}_4\text{O}_{10})]$ .

Luster: vitreous to pearly.

Colors: colorless, pale yellowish to yellow, gray, white, pink, reddish.

Streak: white.

Diaphaneity: transparent to translucent.

Cleavage: {001} perfect, and {201} good.

Fracture: conchoidal to uneven. Brittle.

SG: 2.39-2.46.

H:6-6½.

Optics;  $\alpha$ :1.504-1.507,  $\beta$ :1.51-1.512,  $\gamma$ :1.516-1.523.

Birefringence: 0.011-0.017. ⊕.

Found in Wyoming, Maine, and California (USA), Russia, Italy, Brazil, Australia, Zimbabwe, and Namibia (Africa).

**petalite absorption spectrum**; very weak absorption line at 454 nm in some species.

**petalite-analcime**; → petalite.

**petalite cut**; → petalite.

**petalite luminescence**; weak orange glow under UV light and X-rays.

**petal pearls**; distorted pearls that have a leaf-like or flattened shape.

**petite granite marble**; a variety of bird's-eye marble found in Belgium, which has granular aggregates and resembles granite. Also called Hopton marble, Derbyshire fossil marble, Belgium marble. → Bird's-eye marble.

**Petoskey agate**; a synonym for Petoskey stone.

**Petoskey stone**; a fossil coral limestone in the form of waterworn limestone pebbles. A patterned, Devonian colonial fossil coral known as Hexagonaria, variety of Prismaticophylum, replaced by limestone from Petoskey, Lake of Michigan, USA. Also called Petoskey agate.

**petra dura**; a hard fine stone used for inlay to distinguished from the softer stones used as building cladding.

**petri dishes**; a transparent, small, round, shallow glass, plastic cell or dish used to immerse the stone. This dish is filled with a liquid of refractive index fairly near to that stone to examine the internal inspection by reducing surface reflections and refraction. Also called culture dish. → Glass-bottomed cell, immersion cell, immersion contact photography.

**petrification**; another spelling of petrification.

**petrification by silica**; introduction of, or replacement of pre-existing mineral by silica.

**petrification**; a process of converting into stone. Fossilization of organic material by infiltration of water containing dissolved inorganic matter. The original structures are sometimes retained. Also spelled petrification.

**petrified asbestos**; same as cat's-eye, tiger eye, or hawk's-eye, etc.

**petrified dinosaur bone**; brownish fossilized dinosaur bone found in Wyoming, Utah, and Colorado, USA used for carving ornamental objects. Also called dinosaur bone or dinny bone.

**petrified roses**; same as barite rosette.

**petrified rosette**; same as barite rosette.

**petrified wood**; a colloquial term used in the

southwestern USA for fossil wood or silicified wood. Also called agatized wood, woodstone, opalized wood, wood opal, shinarump, chinarump, lapified wood. → Fossil wood.

**petrified wood cut;** cut and polished for ornamental stones and tumbled. → Fossil wood.

**petrographic microscope;** → microscope.

**petrography;** study and description of systematic classification of rocks, specially of igneous and metamorphic rocks by means of mineralogical and microscopic examination of thin sections. Also called descriptive petrology.

**petrolatum;** same as vaseline.

**petroleum;** a naturally occurring complex of flammable, oily, hydrocarbons from the earth, used as an immersion liquid optics; 1.45.

**petroleum as inclusions;** petroleum occurs as a film-like inclusions in fluorite from Castleton in Derbyshire, England. Or as black inclusions in doubly terminated crystal of quartz from Herkimer County, New York, USA.

**petroleum jelly;** same as vaseline that is used for separation of diamonds from rock and gravel, which covers the grease table. → Grease table.

**petrological microscope;** → microscope.

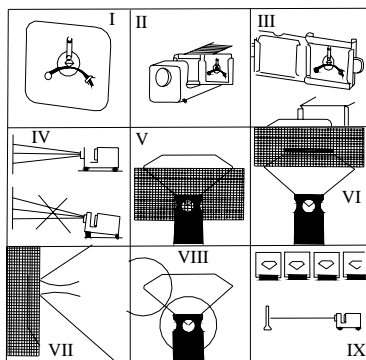
**petrologist;** one who is engaged with the science of petrology.

**petrology;** the science of origin, present condition, mineral composition, alteration and decay of rocks.

**petrosilex;** an old term for an extremely fine crystalline porphyry or quartz porphyries, and for those finely crystalline aggregates now know to be devitrified glass. Flint.

**petrosilex;** a French term applied to hornstone, or flinty slate without cleavage. → Microfelsite, felsite.

**Petterson proportion Slide;** a commercial term for an optical device for checking of the proportion of a brilliant-cut diamond. It works similar to usual slide



*Petterson  
proportion  
slide for  
brilliant  
measurement.*

*After Eppler 1973*

projector by which projected shadow would measure. Brilliant-cut stone weighing up to a carat is suitable. By

projecting a magnified silhouette of the stone onto a calibrated screen provided with millimeter paper. The stone is held in a jig that is easily moved by means of hand. The projection of the stone cut on the screen corresponds to the ideal proportions cut stone.

**petuntse;** a component similar to china stone.

**Petworth marble;** a variety of marble belonging to shelly marble containing the fossilized shells of freshwater snails larger than *Paludina* limestone.

**pewter;** any of several of metallic alloy containing 80-90% of tin and 10-20% lead, but now consisting of tin, copper, and antimony, resembling silver.

**pewter;** a polishing material for marble made by calcining tin.

**peyaleka;** an Indian term for a variety of emerald.

**Phacochoerus;** → wart-hog.

**Phailin mines;** location of sapphire, and ruby mine in Cambodia, some zircon also occurs there.

**phainite;** an old term for synthetic cubic zirconia. Used as a diamond imitation. Also called djevalite.

**phallic hand;** another term for higa.

**phallus made of amber;** same as amber, phallus made of.

**phanerite;** an igneous rock with phaneritic texture. Also called phaneromere.

**phaneritic;** same as phanocrystalline. Also called macrometric, visibly crystalline.

**phanocrystalline;** igneous rock, in which the crystal grains are relatively large enough to be distinguished with unaided eye. Also called, inset, phenocrystalline, phaneritic, coarse-grained phanocrystalline.

**phantasy pearl;** an earlier term for blister pearl.

**phantom crystals;** a transparent crystal such as quartz, calcite, fluorite, tourmaline, etc., in which an earlier



*quartz  
phantom  
crystal*

stage of growth or crystallization is outlined in the interior as ghost-like or blemishes such as tiny inclusions, bubbles, or dust. It is caused

during the growth of a crystal, particles of some different composition deposited in one or more atomic planes, which are visible due to slightly different tone or hue. The different colored zones in transparent tourmaline, sapphire, rubies, etc., which are also classified as phantoms. Also called ghost crystal. → Sapphire.

**phantoms;** same as phantom crystals.

**phantom strain;** → cross-shaped inclusion

**pharmaceutical products;** was thought the precious stones possess curative power therefore powdered

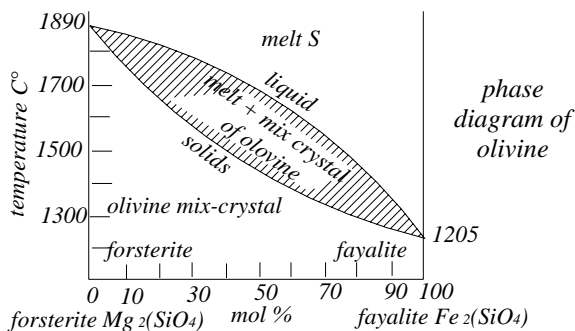
stones was mixed with some other ingredients such as honey, different oils and oil of rose for curing some problems or dimming it. For sample amber powder or amber oil was used in medicine in Ancient Times for curing the stomach diseases, oil resembling turpentine used against asthma and whooping cough. Now is clear that the people of the Near East developed pharmacology from this time. A many stones were used as bezoar or bezoar mixed white other ingredient or other materials, such as syrup of amber is mixture of succinic acid and opium was used in China as sedative, anodyne, etc. By the Middle Ages the medical curative power of minerals or gemstones become more pronounced and had developed into a mass of superstitions about planetary, medical and alchemical influences (mystical power). Also was used gems, minerals, rocks or other materials as curative and anti-poison such as beryl, emerald, talk, turquoise, etc. → Gemstones as medicine, amber in medicine.

**pharmaceutical products from amber;** → amber in medicine.

**pharmacolite;** a silky fiber, white to gray (sometimes rose) mineral.  $\text{CaH}(\text{AsO}_4) \cdot 2\text{H}_2\text{O}$ . Monoclinic crystal. Translucent. Silky luster. Streak white. H:2. SG:2.6. Fracture uneven. Prized by collectors. Also called arsenical bloom, arsenicite.

**pharmacosiderite;** same as cube ore. Prized by collectors.

**phase;** the sum of a homogeneous, physically distinct portion of matter in a heterogenous system, as the three phases; solid, liquid, or gas. Each phase may exist in



different temperatures and pressures.

**phase contrast microscopy;** → phase-difference microscopy.

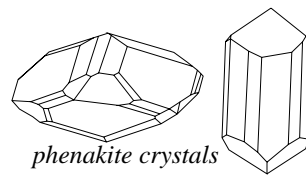
**phase-difference microscopy;** a technique in optical system, in which the phase difference between an incident and diffracted light wave is increased the surface contrast of a sample from about 90° to about 180°, when viewed through a microscope, by using the polarizing filters. A modified version of this method has been used to make a photograph of a diamond,

which is called *fingerprint*. Also called phase contrast microscopy.

**Phassachate;** a German term employs for agate colored by lead-salt.

**phenacite;** same as phenakite.

**phenakite;** an attractive hard mineral, resembles quartz.



Suitable as gemstone but has almost little fire. Cut as faceted stones of moderate brilliance and prized by collectors. Also spelled phenacite.

System: trigonal-rhombohedral.

Formula:  $6[\text{Be}_2\text{SiO}_4]$ .

Luster: vitreous.

Colors: colorless, yellow, green-blue, wine-yellow, pink, brown, reddish.

Streak: white.

Diaphaneity: transparent.

Cleavage: {1120} less perfect.

Fracture: conchoidal to uneven. Brittle.

SG: 2.95-2.97.

H: 7½-8.

Optics;  $\omega$ : 1.651-1.654,  $\epsilon$ : 1.663-1.670.

Birefringence: 0.016. ⊕.

Dispersion: 0.015.

Found in Russia, Mexico, Brazil, Sri Lanka, Tanzania, Namibia, Switzerland, Norway, France, the Czech Republic, Colorado, California, New Hampshire, and Maine (USA).

**phenakite as inclusions;** occurs as inclusions in emeralds.

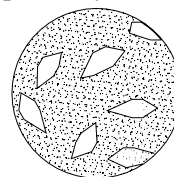
**phenakite pleochroism;** strong pleochroitic in greenish-blue, intense blue and pink-red.

**phenakite cut;** → phenakite.

**phenakite luminescence;** pale greenish luminescence under LWUV. Sometimes orange under X-rays.

**phenakite, synthetic;** → synthetic phenakite.

**phenocryst;** megascopic crystals, large crystals, usually



of perfect crystalline shape embedded in a fine-grained porphyritic rock. Also called porphyritic crystal, phenocrystalline, coarse-

grained, phanero-crystalline, phanero-cryst, inset, phaneritic.

**phenocryst;** same as phanero-crystalline.

**phenocrystalline;** same as phanero-crystalline.

**phenol-formaldehyde plastics;** a large group of gray to black, fusible hard, thermosetting plastics, made from phenol and aqueous formaldehyde and basic catalyst. By addition of suitable dyes obtainable in other colors



or colorless and variegated effects. RI:1.54-1.70. SG:1.35-1.60. H:2-2½. Used as a gem imitation, varnishes, and lacquers, may be molded, laminated, or cast. Originally known as Bakelite. Also called phenol-formaldehyde resin.

**phenol-formaldehyde resin;** same as phenol-formaldehyde plastics.

**phenolic-resin;** same as phenol-formaldehyde plastics.

**phenolphthalein;** a compound of  $[(C_6H_6OH)_2C_2O_2C_6H_4]$ , pale yellow powder which is soluble in neutral or acidic solution almost colorless, pink to dark red in alkalic medium, but colorless in presence of large alkali. Used as indicator and dyes. By adding of one oxygen, bridge to phenolphthalein gives an orange-red colored *fluorescein* structure, which fluoresces by reflected light. It is a member of triphenylmethane.

**phenolphthalein;** → blocking off.

**phenomenal diamond;** diamond, which exhibits an unusual optical effects. → Phenomenal gem.

**phenomenal gem;** gemstones, which exhibit an optical phenomenon such as chatoyancy, asterism, or play of color, etc. → Phenomenon.

**phenomenon;** a special optical occurrence, or circumstance observed or are visible in certain gemstones such as chatoyancy, asterism, or play of color, adularescence, girasol, labradorescence, opalescence, schiller, etc.

**phenyldi-iodoarsine;** a liquid with high refractive 1.85, becomes a microcrystalline mass at  $-20^\circ C$  of chemical formula  $C_6H_5AsI_2$ . Used as optical contact liquid. Soluble in water, alcohol, ether, and benzene. It is highly toxic by ingestion and inhalation.

**phenylmethane;** same as toluene.

**phianite;** a commercial term for synthetic cubic zirconium oxide used as diamond imitation, made in Russia. Also called synthetic cubic zirconia.

**Philip II Diamond;** reportedly a diamond of ca. 48 cts, owned by Philip II of Spain in 1559. Present owner unknown.

**Philip II Pearl;** same as La Peregrina pearl.

**Philippine, Islands;** there are several sources for jade and pearls.

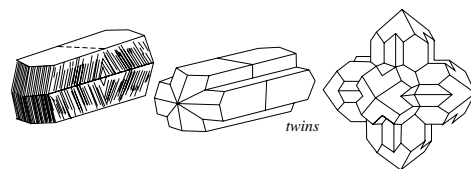
**Philippine pearl;** pearls are fished from various islands of the Philippine Archipelago, and other islands.

**Philippinites;** varieties of tektite from Philippine islands.

**Phillipsite;** a zeolite mineral of  $2[(K,Na,Ca) Al_2Si_6O_{16} \cdot 6H_2O]$ . Monoclinic crystal (pseudorhombic). Vitreous luster. Transparent to translucent. Colorless, white, gray, yellow, red, and brown. White streak. Cleavage: {010} distinct, and {001} indistinct. Fracture: subconchoidal to uneven. Brittle. Optics;  $\alpha$ :1.503,  $\beta$ :1.505,  $\gamma$ :1.512. Birefringence: 0.009.  $\oplus$ . SG:2.20.

## phenol formaldehyde - phosgenite

H:4½. Found in Czech Republic, Italy, Germany and Ireland. A suitable mineral for collectors. Also called



*harmotom or phillipsite twins*

calci-harmotome, lime-harmotome.

**philosopher's wool;** an obsolete term for flocculant zinc oxide. Same as flowers of zinc.

**phlogopite;** a yellow brownish magnesium rich variety of mica group, near biotite in composition, but contain little iron with the formula:  $2[KMg_3AlSi_3O_{10}(OH,F)_2]$ .  $\alpha$ :1.530-1.590,  $\beta$ :1.557-1.637,  $\gamma$ :1.558-1.1.637. Birefringence: 0.028.  $\ominus$ . SG:2.76-2.90. H:2-2½. It occurs in few stones as inclusions. Also called amber mica, brown mica, magnesia mica, rhombic mica.

**Phoenician in amber trade;** an ancient Asian race immigrated from Orient to Mediterranean in Phoenicia on the coast of Syria. A sea-faring sailors and trade tribe, may be the first trade-amber sailors bringing amber to the Mediterranean countries from Baltic Sea. It believed they bring and widespread the sun worship in Ancient Times in Europe.

**phoenicocroite;** a yellow lead chromate crystal  $Pb_2O(CrO_4)$ .

**Phoenix Mine;** location of a small diamond deposits in the Winburg area, Orange Free State, South Africa.

**phonolite;** a group of fine-grained extrusive rocks primarily composed of alkali feldspar and nepheline, emits a characteristic sound when struck with a hammer. Also known as clinkstone, klinkstone, echodolite.

**phonons;** quantum of atomic vibration of a crystal lattice.

**phonon scattering;** quantum of atomic vibration of a crystal lattice due to generation of phonons, which scattered electrons within crystal lattice. In an inharmonic crystal lattice forces due to the interaction in crystal structure with other phonons or X-rays or other high-energy bombardment.

**phosgenite;** very rare as a faceted gem but prized by collectors. Also called horn lead, chlorocarbonate of lead, chromfordite, corneous lead.

System: tetragonalic.

Formula:  $4[Pb_2CO_3Cl_2]$ .

Luster: greasy adamantine.

Colors: colorless, pale yellowish to yellowish green, pink, gray, pinkish, shades of brown.

Streak: white.

Diaphaneity: transparent to translucent.

Cleavage: {110}, and {001} perfect.

Fracture: conchoidal. Semi-brittle.

SG: 6.10-6.30.

H:2½-3.

Optics;  $\omega$ :2.117,  $\epsilon$ :2.145.

Birefringence: 0.028. ⊕.

Found in Poland, England, Russia, Australia, Italy, Namibia, Tunisia, and USA.

**phosgenite luminescence;** strong yellowish fluorescence under UV and X-rays.

**phosgenite pleochroism;** weak reddish, greenish and Yellowish pleochroism.

**phosphate;** any mineral or compound containing a phosphorous group or radical ( $\text{PO}_4^{3-}$ ).

**phosphophyllite;** very rare mineral, cuttable material from Bolivian. It is prized by collectors. There is an emerald-cut of bluish-green color of 5.04 cts, on display in the Smithsonian Institution of America in Washington, D.C.

System; monoclinic.

Formula;  $2[\text{Zn}_2(\text{Fe}^{+2}, \text{Mn}^{+2})(\text{PO}_4)_2 \cdot 4\text{H}_2\text{O}]$ .

Luster; vitreous.

Color; colorless to blue-green.

Streak; whitish.

Diaphaneity: transparent to translucent.

Cleavage: {100} perfect, {010}, and {102} distincts.

Fracture; conchoidal to uneven. Brittle.

SG; 3.08-3.13.

H;3-3½.

Optics;  $\alpha$ :1.595-1.599,  $\beta$ :1.614-1.616,  $\gamma$ :1.616-1.621.

Birefringence; 0.021-0.033. ⊕.

Found in Bolivia, and Germany.

**phosphophyllite luminescence;** violet under SWUV.

**phosphor;** same as phosphorous.

**phosphor in tungstates;** → phosphor in zinc sulfide.

**phosphor in wolframate;** → phosphor in zinc sulfide.

**phosphor in zinc orthosilicate;** → phosphor in zinc sulfide.

**phosphor in zinc selenide;** → phosphor in zinc sulfide.

**Phosphor in zinc sulfide;** to produce phosphorescent panel to cast into a thin layer used phosphor in both modifications cubic and hexagonal. Preparation happen with 99.999% ZnS, may add 0.01% copper chloride, and 2% sodium chloride. After grinding heated in hydrogen sulfide to 880°C, held 10 minutes in this condition and cooled slowly down. The product is a cubic ZnS:Cu-phosphor, which emits green light at 530 nm. By adding of other metals can obtained phosphorescent in other regions through the visible light. Sodium chloride acts here as co-activator, which assists into the phosphor as amplifier activator. Other

chemical foundations are ZnS:Ag, zinc selenide ZnSe, zinc orthosilicate  $\text{Zn}_2\text{SiO}_4$ , tungstates, and wolframate  $\text{CaWO}_4$ . The presence of nickel or iron or both as impurities is very undesirable, which can delete the properties of phosphor, called as killers, poisons, or quenchers.

**phosphor in zinc sulfide-silver;** → phosphor in zinc sulfide.

**phosphorescence;** a phenomenon where a luminous glow persists and continues even though the source of the energy is removed. Such as some diamonds glow in darkness after exiting with X-rays, UV light, etc. This absorption of energy phenomenon was known as *Bologna stone*. → Luminescence, fluorescence.

**phosphorescence of diamond;** luminous glow by Type IIb diamonds under SWUV ray is very variable, but frequently determinative and useful.

**phosphorescence of synthetic ruby;** synthetic rubies usually show a distinctly brighter red, chromium-rich are less fluorescence when placed under a Mineralight. Synthetic rubies emitting by using of short-wave ultraviolet radiations bluish-white to greenish glow, very rarely seen in natural sapphires.

**phosphorite;** an old term for apatite but now is used to describe sedimentary rocks with more than 19.5 % of  $\text{P}_2\text{O}_5$ . → Apatite.

**phosphoroscope;** a chamber for determination of the duration of phosphorescence of gemstones.

**phosphorous;** a nonmetallic element, waxy white, very flammable and poisonous with the symbol P.

**photochemical oxidation-reduction;** redox is an acronym for this process. The effect of absorption of light induced or modified chemical changes as in sapphire in which iron and titanium replacing some aluminum atoms in  $\text{Al}_2\text{O}_3$  structure. Iron has two different valences  $\text{Fe}^{3+}$  and  $\text{Fe}^{2+}$ , while titanium has four  $\text{Ti}^{4+}$ . If both  $\text{Fe}^{2+}$  and  $\text{Ti}^{4+}$  are together present, an interaction between both is possible when they are located on adjacent Al sites,  $\text{Ti}^{4+}$ .  $\text{Fe}^{2+}$  by losing one electron converted to  $\text{Fe}^{3+}$  now this electron will gaining by  $\text{Ti}^{4+}$ , which converted to  $\text{Ti}^{3+}$  as describe:



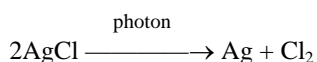
The energy of right hand of equation is greater than left hand, the falling light on blue sapphire is absorbed during the charge transfer of equation. This change in two octahedrons of lattice can be seen in structure of sapphire in which it suffered a configuration therefore of the octahedrons is smaller than other.

**photoconductivity;** characteristic effect possessed by certain gemstones, increases with the intensity of the UV light, to which the mineral is exposed, such as

semiconductor Type IIa diamonds containing traces of boron elements, which are photoconductive or sensitive to gamma radiation.

**photochromism;** the ability of a transparent mineral or material to darken reversibly exposed to light by absorption of photon of light or ultraviolet radiation such as 2-benzyl-3-benzylchromone, which turns to orange on exposure to ultraviolet radiation and vice versa when darkened. According to color, change in photochromism due to absorption of ultraviolet radiation one hydrogen atom to convert a ketone group into enol group. The next sample is spiropyran, which shows color change by heat and photon. → Thermochromism, spiropyran .

**photochromism glass;** a technique applied to silver halides contained glass exposed to light



as can be seen the equation turn back by absorbing light. The chlorine part of compound cannot escape while it is sealed in glass. Its re-reaction with silver result bleaching of glass as soon as the light source is removed. Combination of silver and copper salts results that glass will darken when exposed to solar light and brighten automatically when light lowered. Desert amethyst glass or coloration of hackmanite is product of photochromism, where there are color centers with trapped electrons. Photochromism seen in both reversible and irreversible. Photosensitive. Also called photochromic glass.

**photochromic glass;** same as photochromism glass.

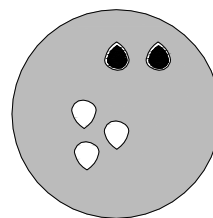
**photoconductivity of diamond;** diamonds are photoconductive, retaining their high resistance only in the dark and in light with no ultraviolet content.

**photodissociation;** decomposition of a chemical compound due to absorption of radiant energy.

**photoforming opal glass;** opal glasses can be photosensitive because of silver salts, which made an image on striking. When a region of lithium contained opal glass exposed to hydrofluoric acid, lithium will dissolve rapidly than unexposed regions, now can be seen a complex shape formed out from the glass with the name fotoform.

**photograph, immersion contact;** a method to reveal the difference between refractive index of gems and its relationships. The polished or faceted gemstones are immersed in a dish, which is filled with water. SWUV light from an overhead source is passed through the stones. cut stones or shaped beads of natural and synthetic rubies with the same refractive index immersion in water. Natural ruby in the water showing

more transparency by using SWUV light.



*immersion contact photograph of three natural and two synthetic rubies in water by using SWUV light. Natural rubies showing more transparency than synthetic*

**photography of fluorescence;** → photoluminescence.

**photography of infrared;** → infrared photography.

**photoluminescence;** the fluorescent property of those gemstones with fluorescence effect, which may be photographed, when it is simulated by visible, ultraviolet, X-rays or infrared radiation such as diamond. Photoluminescence is a general term, in which the *phosphorescence* or *afterglow* (the phenomenon which persists as soon as the source of the energy is removed) and *fluorescence* (the phenomenon ceases as soon as the source of the energy is distinguished) are particular cases. Photoluminescence can be seen in diamond or materials, which have a host crystal structure, through which the emitted light always has a lower frequency than the radiation absorbed. The camera for taking such a picture must be provided with a special filter in the front. Another method of photography of fluorescence is to place the samples on a photographic film in a dark room in the UV light-chamber for a suitable time, this is called *fluograms* or *luminograms*. After developing the film the outline of the stone as it, fluorescence's can be seen.

**photometer;** a device for color grading of fashioned diamonds. Originally used for comparing the luminous intensities of two sources of light. → Diamond photometer, diamond colorimeter.

**photometry;** in optics a method of determining of the intensity, distribution, absorption factor, color, and spectral of visible light. Also sometimes used for light close to ultraviolet and infrared rays.

**photomicrograph;** a photograph of a magnified image obtained of a microscopic in thin sections, such as made by petrography. In Gemology photographs are taken of interior or exterior blemishes on a cut gemstone. Also called microphotograph.

**photomicrography;** the recording of microscope images onto photographic media by using an extra *trinocular* port for mounting the camera in the place of an ocular. Not to be confused with microphotography. Also called photomicroscopy.

**photomicroscopy;** same as photomicrography.

**photon;** a quantum of light or electromagnetic radiation, it can behave as a wave or as a particle. Traveling at the velocity of light. Photon have momentum but not mass or electrical charge. Also known as light quantum. Caused by excitation of atoms and molecules and more energetic ones can cause ionization.

**Photoscope;** a device made by Gemological Institute of America to obtain magnified photographs of gemstones inclusions.

**photosensitive glass;** by adding of gold, silver, copper and cerium salts to the glass, when this glass is exposed through a photographic negative will be seen an image within the glass. When such a glass contains cerium by exposing to ultraviolet the metal will sensitize the other metal nucleus. Also called self-darkening glass or sunglass.

**photospectrometer, infrared;** → infrared photospectrometer.

**Photostand;** a commercial term for a device made by Gemological Institute of America to obtain photographs of gemstones or jewelry.

**photosynthesis;** synthesis of an chemical compound by using energy of light, specially organic substances from carbon dioxide and hydrogen source such as water



and simultaneous liberation of oxygen such as chlorophyll. Photosynthesis occurs in cell of green plants with the name autotrophs.

**Phrygian marble;** same as pavonazzo marble.

**Phrygian stone;** a stone used in ancient for red dyeing, believed to have been a sort of pumice.

**phthalic anhydride;** a white resin of formula  $\text{C}_6\text{H}_4(\text{CO})_2\text{O}$ , used for turquoise imitation. Melting at  $131^\circ\text{C}$ , sublimates, when heated. Very slightly soluble in alcohol, slightly soluble in ether, and hot water. Also used as dyes.

**phthalocyanine group;** → porphyrin, polyene.

**pyrrole ring;** → polyene.

**phyllite;** a fine-grained, silky lustrous, schistose rock with clay mineral, chlorite and mica minerals.

**phyllites;** minerals with a layered crystal structure such as phyllosilicate, which exhibit corrugated cleavage surfaces.

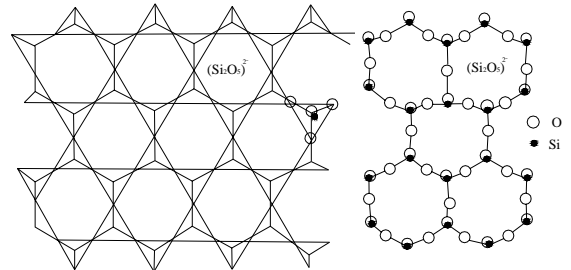
**phyllites;** scaly minerals such as micas, chlorite, and clays.

**phyllitic cleavage:** rock or mineral imparted with flakes visible to the naked eye.

**phyllo-aggregate;** very thin scales of flaky mineral such as mica or sericite. → Flaky aggregate.

**phyllo-mineral;** same as phyllo-aggregate.

**phyllosilicates;** a group of structural type of silicate minerals characterized by silicate  $[\text{SiO}_4]$  tetrahedron, which share three of the four oxygen with neighboring tetrahedra and are arranged in the form of a flat sheet,



*phyllosilicate structure, hexagonals are tetrahedron of  $(\text{Si}_4\text{O}_{10})^{2-}$*

the Si:O ratio is to 2:5 thus giving the basic unit  $\text{Si}_4\text{O}_{10}(\text{OH})_2$ . The group includes the mica and clay mineral classes. Phyllosilicates are generally flaky, soft, and low density. Also called layer-lattice minerals, sheet silicates, layered silicate, sheet minerals.

**phylum;** one of the major groups in the taxonomy of animals or plants. A tribe.

**physalite;** same as pyropysalite.

**physical mineralogy;** the study of physical properties of minerals.

**physical optics coloration;** physical coloration caused by diffraction, dispersion, scattering and interference. Dispersion such as dispersion color in diamonds. Scattering such as schiller, chatoyancy, and asterism. Diffraction and interference can be seen in labradorite and opal.

**physical properties;** physical properties of gemstones are extremely important in understanding geological phenomena in synthesizing new materials, and identification of minerals. Physical properties and chemical composition of minerals change with temperature and pressure. Physical properties are; color, luster, hardness, tenacity, specific gravity, optical, cleavage, fracture, etc.

**physical testing;** determination of physical properties of minerals.

**Physeter catodon;** → sperm-whale ivory.

**phytolite;** same as plant fossil. Also called phytolith.

**phytolith;** same as phytolite.

**pi;** a Chinese term for indigo blue nephrite. → Nephrite colors in Chinese, Chinese ritual and symbol jades.

**pi;** a Chinese term for a circular disc carved from jade used in worship celebrating of the God of the heavens. → Chinese ritual and symbol jades.

**Piaui;** location of small diamond deposits in the Piaui State, Brazil.

**pick**; → geologist.

**pick hammer**; a variety of hammer used in the field geology with one end sharp and the other blunt.

**picking hammer**; → mallet, pick hammer.

**picking prices**; in color categories of diamonds there are always stone with higher or lower grades, when a customer pick out stones from a category the price ranges between the price of the particular category and the next higher category.

**picking table**; a flat table, on which diamond-bearing placer or ore is spread to remove waste materials

**pickle**; an acid bath of 9 part water and one part sulfuric acid used to remove oxides or any flux remaining from the surface of jewels by chemical action.

**picotite**; a dark-green to dark-brown variety of chrome-rich spinel or hercynite  $8[(Mg,Fe^{2+})(Al,Cr)_2O_4]$  with a silvery shine, cut into cabochon. It is a primary mineral in the kimberlite of South Africa. It is included in some diamonds. Also called chrome spinel.

**picrolite**; a platy or lamellar, dark-green to green-brown variety of serpentine-antigorite. Also called balrimorite, antigorite.

**pictorial marble**; → ruin marble.

**pictorial sandstone**; a suggested term for paesinite sandstone from Meshed.

**Picts**; an old English term for indigo painted people, a member of pre-Celtic tribe of North England.

**picture jasper**; a variety of agate or jasperized rhyolite containing light to dark-brown dendritic or banding inclusions that look like pictures of scenery, when suitably cut. Those with black colored inclusions due to arrangement are known as *trees*. Found in Namibia desert (Africa), and at Biggs Junction in Oregon, USA. Also called scenic jasper. → Dendritic agate.

**piece pearl**; an earlier termination of a minute pearl somewhat larger than seed pearl.

**pigeon's blood opal**; same as pigeon's blood opal.

**piemontite**; a member of epidote group, red color containing about 5%  $Mn_2O_3$ . Cut into cabochon and rarely as faceted gems. Translucent to opaque. Adamantine, vitreous somewhat pearly to resinous luster. Optics;  $\alpha$ :1.732-1.794,  $\beta$ :1.75-1.807,  $\gamma$ :1.762-1.829. Birefringence: 0.032-0.035.  $\oplus$ . SG:3.45-3.52. H:6. Found in San Marcello, Val d'Aosta, Italy. Also spelled piemontite.

**pedra arbol**; Spanish term for Mocha stone.

**pedra de aguja**; Spanish term for rutile quartz.

**pedra de calmuco**; Spanish term for cloudy opal or cachalong.

**pedra de camela**; Spanish term for cinnamon stone.

**pedra de grosella**; Spanish term for grossularite garnet.

**pedra de hijada**; Spanish term for jade or nephrite (colic stone).

**pedra de los riñones**; Spanish term for nephrite.

**pedra de Madera**; Spanish term for jasper (agate).

**pedra de mes**; Spanish term for birthstone.

**pedra de sangra**; Spanish term for hematite.

**pedra de savon Maroc**; sepiolite or meerschaum from Morocco. Used as a place of soap. Also spelled pierre de savon Maroc.

**pedra de serra**; Spanish term for Brazilian agate.

**pedra del sol**; Spanish term for sunstone.

**pedra des Inca**; pyrites or marcasites often polished has been found in the tomb of Incas. Probably used as mirror. Also spelled in French pierre des Incas.

**pedra dorado**; Spanish term for chrysolite (olivine).

**pedra estrellada**; Spanish term for asteria.

**pedra fina**; Spanish term for gemstone.

**pedra miel**; Spanish term for melanite garnet.

**pedra moca**; Spanish term for Mocha stone.

**pedra preciosa**; Spanish term for precious stone.

**pedra sangra**; Spanish term for hematite.

**pedra simava**; Spanish term for fire opal.

**pedra sintético**; Spanish spelling for synthetic stone.

**pedra verde**; Spanish term for nephrite.

**piemontite**; same as piedmontite.

**piercing**; perforation of decorative gemstones or jewelry articles such as earrings.

**piermatic machines**; an automatic diamond-polishing machine, which polishes 48-facets and 56-facets on the brilliant-cut stone.

**pierre argentine**; French spelling for moonstone.

**pierre d'Aleçon**; a French term for cut rock crystal.

**pierre de lune**; French term for moonstone.

**pierre de savon Maroc**; same as piedra de savon Maroc.

**pierre des Incas**; French spelling for piedra des Inca

**pierre étoilée**; French term for asteria.

**pierre fausse**; French term for imitation stone.

**pierre fine**; French term for precious stone.

**pierre pontite**; a suggested local term for black iron-rich tourmaline which also called uvite.

**pierre precieuse**; French term for precious stone.

**pierres marbrier**; a French term for compact limestones that are suitable for taking polish.

**pierre solaire**; → pantaura.

**pietersite**; a commercial term for disoriented pseudocrocidolite mass with limonite from Namibia, Africa. Cut cabochon.

**pietra**; an Italian term for stone.

**pietra albero**; an Italian term for Mocha stone.

**pietra della raja**; an Italian term for a fine-grained sandstone used for sawing and finishing.

**pietra dura**; same as pietre dura.

**pietra paesina**; another term for landscape marble from

Florence, Italy. → Ruin marble.

**pietre dura;** an Italian term for inlay work from India popular in Mogul time often composed of a brown stone with yellow and green pebbles.

**pietre dura;** in Italian term for hard, fine, colored stones used as suitably shaped pieces for ornamental inlay in mosaic pattern. The colored stones are marbles, coral, ivory, malachite, lapis lazuli, turquoise, and opal. Also known as *intarsia*. Also spelled *pietra dura*. → Fictile mosaic, florentine mosaic.

**pietre dura mosaic;** → *pietre dura*.

**pietre prezioso;** an Italian term for precious stone.

**pietre serena;** an Italian term for gray sandstone from Fiesole, Italy. Used as cladding building proposes.

**piezochemistry;** the science of high pressure of chemical phenomena that occur under high pressure, which can be seen under the earth's crust.

**piezochromatism;** the science of high pressure of one subject to change its color, because by increasing of pressure shortens the bond length, increase the ligand field, such as a green subject with 60%  $\text{Cr}_2\text{O}_3$  and 40%  $\text{Al}_2\text{O}_3$  by increasing the pressure to over 100 kilobars the color change through gray to red. In contrast to thermochroism. → Color-change by pressure.

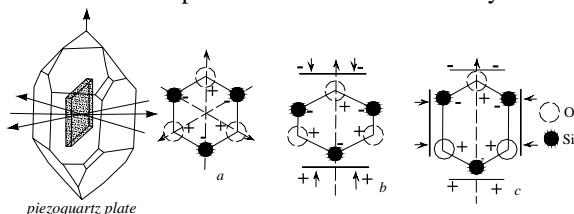
**piezochromism;** color-change by pressure.

**piezo-crystallization;** crystallization of magma under orogenic pressure.

**piezoelectric,- adiabatic;** → adiabatic pressure.

**piezoelectric crystal;** a crystal such as quartz or tourmaline which exhibits the piezoelectric effect of alternate contraction and expansion obtained by an electric current. It is asymmetrical meaning lacks a center of symmetry and nonconducting crystals. Piezoelectric effect exists also in boracite and Rochelle salt a sodium potassium tartrate. Rochelle salt exhibits a greater effect than any other crystal. Used in radio equipment and to keep instruments, crystal loudspeakers, microphones and phono pickups. → Piezoelectricity, oscillator crystal, piezoelectric effects.

**piezoelectric effect;** to obtain an electromechanical effect due to polarization. In certain asymmetric



diagrammatic piezoelectric effect of quartz with heteropolar Si-O. a: normal position. b: pressure parallel to the polar axis. c: pressure in polar axis direction.

hemihedral and dielectric crystals such as quartz or

tourmaline, boracite and Rochelle salt result in using mechanical stress, positive and negative electric charges are produced on opposing ends. The *reverse effect* or *converse effect* produced by application of a voltage between certain faces of a suitable cut plate of a piezoelectric crystal, which generates mechanical stresses and alters the length and thickness of the material. The increasing and decreasing of thickness of crystal is depend upon an electric field in one direction or another direction. When the thickness increases the length will decrease. No reverse effect can be seen along the direction of the optical axis in doubly refracting crystal. → Piezoelectric crystal, piezoelectric effects.

**piezoelectric,- isothermal;** → isothermal piezoelectric.

**piezoelectricity;** the property possessing piezoelectric effects. → Piezoelectric crystal, piezoelectric effects.

**piezoelectricity in boracite;** → piezoelectric crystal, piezoelectric effects.

**piezoelectricity in quartz;** → piezoelectric crystal, piezoelectric effects.

**piezoelectricity in Rochelle salt;** → piezoelectric crystal, piezoelectric effects.

**piezoelectricity in tourmaline;** → piezoelectric crystal, piezoelectric effects.

**pigeon blood;** same as pigeon blood ruby.

**pigeon blood agate;** a local misleading term for bright red carnelian variety of chalcedony from Cisco, Utah, USA.

**Pigeon Blood Ruby;** a rough ruby of 20 cts, found in 1933 in Myanmar, after cutting weighed 7.50 cts.

**pigeon blood ruby;** a gem variety of ruby, of which the color is purplish deep-red from Mogok in Upper Myanmar, (Burma). Also called Burma ruby. A synthetic pigeon blood ruby, which has been created. Also called pigeon blood or pigeon's blood, and spelled pigeon's-blood ruby.

**pigeon's blood;** same as pigeon blood ruby.

**pigeon's blood opal;** an informal term used by Australian miners for red opal. Also misspelled as pidgeon's blood opal. → Ox-blood opal.

**pigeon's-blood ruby;** another spelling for pigeon blood ruby.

**pigeon's egg;** a formerly size expression for pigeon egg large.

**pigeon's-eye ruby;** a compare term with the color center of a pigeon's eye used in Myanmar (Burma), for pigeon's-blood red variety of ruby which is called kothway in Burmese.

**pigeonite;** → pyroxene.

**pigeon stone;** same as peristerite feldspar.

**piggy-back diamond;** an assembled (fake) stone consisting of a flat diamond with large culet set on top

of another smaller diamond so that the culet of the top stone rests on the table facet of the lower one. The arrangement is concealed by special mounting, which give the appearance of much larger stone

**pigment minerals;** minerals are used as color agents.

**pigments;** any natural or synthetic particles of materials, which impart various colors to gemstones, and minerals, generally oxides. All pigments are insoluble in the medium therefore it require a binder to hold them to the matter. Pigments are used in enamels, ceramics, plastics, resins, etc. → Color,-definition.

**Pigot Diamond;** an oval-cut diamond of 48.63 cts, from India, which was named after George Pigot British Colonial Governor of Madras, India. It was presented to Pigot by an Indian prince in 1763. Later it was sold by lottery in 1801. In 1818 it was bought by Ali Pasha the Sultan of the Ottoman Empire (Turkey), Victory of Egypt. Present owner unknown. There are rumors that the stone was destroyed. Also called Lottery Diamond. Also spelled Pigott Diamond.

**Pigott Diamond;** same as Pigot Diamond.

**pig-toe clam;** same as pig-toe shell.

**pig-toe shell;** the nuclei for most Japanese cultured pearls are made from thick-shelled fresh-water mussel from Mississippi valley, USA. Before China's embargo the nucleus was made from the Gamanose shell from Yangtze River. Now both type of mussels are used for the beads of cultured pearls. Also called pig-toe clam. Beads are frequently made from sea water trochus shell.

**pih;** a Chinese term for moss nephrite. → Nephrite colors in Chinese, Chinese ritual and symbol jades.

**Pike's Peak amazonite;** fine-quality amazonite from Pike's Peak, Colorado, USA.

**Pilbara jade;** same as marble bar-jade.

**pile, atomic;** → atomic pile.

**pile-irradiated diamonds;** → irradiation of diamond.

**pile-treated diamonds;** → irradiation of diamond.

**pillar snatcher;** a term used in Australian for some who to enters an old opal mine to cut out the naturally occurring pillars.

**pilolite;** same as rock cork.

**pilotaxitic;** same as felty structure.

**pimples;** raised eruption or potch covering the surface of some operculums.

**pin;** same as brooch.

**pinacoid;** an open crystal form consisting of exactly two parallel faces. Also spelled pinakoid.

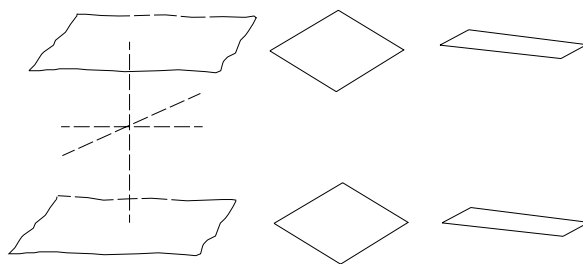
**pinacoidal;** adjective of pinacoid.

**pinacoidal class;** a crystal class of triclinic system that has only are center of symmetry.

**pinacoidal cleavage:** same as {010} cleavage of gypsum.

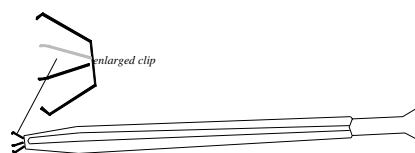
**pinakoid;** another spelling of pinacoid.

## pigment minerals – *Pinctada radiata*



different pattern of pinacoid or parallelohedron

**pincers;** a term used in Australian for a kind of



pincers or tweezers

tweezers used to clip off stone. Also spelled pincher. → Tweezers.

**pinnette;** a French term for small pincers. → Tweezers.

**pinchbeck;** a reddish-yellow alloy of copper and zinc (80% Cu and 20% Zn) used as a gold simulant.

**pincher;** same as pincers.

**Pinctada carcharium;** a small yellow pearl mollusk of 75-100 mm in diameter with an attractive golden hue, the pearls are pale yellow to yellowish or straw from Shark's Bay, Western Australia. Also called Shark's Bay pearl.

**Pinctada margaritifera;** a black lipped oyster from Northern Australia and the Red Sea with silver-white pearls. SG:2.68-2.78. This term used to the mantle of oyster due to protein in the environment of the food. → Pinctada.

**Pinctada martensii;** mostly oyster fisheries in Japan consist of the small shell *Pinctada martensii* with white to white greenish color. SG:2.66-2.76. → Pinctada.

**Pinctada maxima;** a big pearl mollusks up to 300 mm in diameter of gold or silver-lipped oyster with silver-white pearls fished from coasts of Australia, Polynesia and Micronesia. SG:2.67-2.78. → Pinctada.

**Pinctada mazatlanica;** a kind of pearl-bearing oyster fished from Panama, the pearls are good quality.

**Pinctada oyster;** a genus of salt-water pearl-bearing oyster. The major species are *Pinctada Vulgaris*, *Pinctada margaritifera*, *Pinctada carcharium*, *Pinctada maxima*, and *Pinctada martensii* and *Pinctada radiata*. Also known as *Margaritifera* or *Pteria* or less often used name *Meleagrina*. Found in Persian Gulf, Gulf of California, Burma, Japan, and South Sea.

**Pinctada radiata;** a variety of shelled oyster from

Persian Gulf, Gulf of Mannar, Red Sea and Venezuela. The pearls are creamy-white, or pale cream-white. SG:2.68-2.74. Also called *Pinctada vulgaris*. → *Pinctada*.

***Pinctada squamulosa***, a thin-shelled oyster from Gulf of Panama with pale yellowish gray, and silvery gray pearls.

***Pinctada vulgaris***, same as *Pinctada radiata*. → *Pinctada*.

**pineapple opal**; glauberite, calcite or gypsum mineral aggregates, which are entirely replaced by opal, usually of a hazy bluish color. They resemble a small pineapple. Found in White Cliffs, Australia.

**piney odor**; a term used for burning amber, which gives off a piney odor, imitations does not give off this especial odor.

**pinfire opal**; a variety of precious opal with the main body usually white, in which the patches or minute pinpoint of play-of-color are very close together and shows a myriad of small pin-like colors entirely through the surface and the body of the gemstone. Also known as pinpoint opal. → Harlequin opal.

**ping**; a Chinese term for a carved vase made of jade. → Chinese ritual and symbol jades.

**pinga**; a Portuguese term used in Brazil for emerald.

**pingo d'agoa**; a French/Brazilian term (meaning drop of water) for colorless water-worn pebbles of topaz. Also called Goutte d' eau.

**pingoo**; a Burmese term for pingoo-sa a name used for silky rubies with or without star effects. → Corundum classification in Myanmar.

**pingoo-choo**; a Burmese term used for first-quality star rubies like spider's thread. → Corundum classification in Myanmar.

**pingoo-sa**; same as pingoo.

**pinguite**; same as chloropal.

**pinite**; any massive variety of muscovite, which is an alteration product of cordierite, spodumene, nepheline, scapolite, and feldspar.

**pinite**; a variety of muscovite, which is used as compound of ceramics.

**Pinites stroboides**; an extinct pine species from Baltic Sea, thought the gedanite resin may be from this tree.

**pikani**; a Farsi term meaning pointed, or high cabochon. → Turquoise cut in Iran.

**pink beryl**; synonym for vorobyevite.

**pink color**; a color varying from deep purplish to pale reddish purple.

**pink corundum**; → pink sapphire.

**pink diamond**; a fancy color diamond of natural pink bodycolor.

**pink dyed chalcedony**; a commercial term for carnel.

**pink erythrine**; same as erythrite.

**pink sodalite**; same as rose sodalite.

**pink spinel**; a commercial term for a variety of spinel from Badakhshan (Balascia), Afghanistan. Also misnomerly called balas ruby.

**pink topaz**; same as rose topaz.

**pinked topaz**; a decolorizing method of topaz in which red-orange, rose-red, yellow to brown variety of topaz, altered to pink by heating of 500° C. Also called pinking, or pinking of topaz. → Dumelle's heat-treatment of topaz.

**pinking**; → pinked topaz.

**pinking of topaz**; → pinked topaz.

**pink jade**; → red jade.

**pink moonstone**; a misleading term for opalescent pink variety of scapolite sometimes with cat's-eye effect from Mogok, Myanmar.

**Pink Pearls**; a term with the capital initial letters (after CIBJO) used for pink pearls of nacreous origin which obtained from Indian great conch (*Strombus gigas*). Fished off the coast of West Indies, Florida, Mexico and Gulf of California, USA.

**pink pearl**; a misleading term for pink coral.

**pink quartz**; a natural cobalt bearing quartz. It differs from blue quartz or pink quartz without cobalt.

**pink sapphire**; pale to red chromium corundum or pink corundum from Sri Lanka is known as pink sapphire, which distinguishes from ruby. → Ceylon ruby.

**pink scapolite**; pale pink to violet scapolite from Myanmar, (Burma) frequently seen with perfect cat's-eye effects. RI:1.54-1.55. SG 2.61.

**pink shell**; pink shell of great conch or *Strombus gigas* used as ornamental curio and carved as cameo. Sometimes with white color give a good contrast.

**pink stones**; pink stones include pink tourmaline, pink sapphire, pink topaz, kunzite, morganite, spinel, amethyst, synthetic pink corundum, synthetic pink spinel, pink pastes, doublets, etc.

**Pink Topaz**; a dark-pink to red topaz from Russia, CIS, of 200 cts, cut stone with 32 facets. Present whereabouts unknown.

**Pink Topaz**; a crimson topaz from Russia, CIS, of 79 cts. in rough. Belonged to a private collection.

**Pink Topaz**; a pink topaz from Brazil of 71 cts. Now on display at Smithsonian Museum, USA.

**Pink Topaz**; a pink topaz from Brazil of 46 cts. Now on display at Smithsonian Museum, USA.

**Pink Topaz**; a pink topaz from Brazil of 43 cts. Now on display at Smithsonian Museum, USA.

**Pink Topaz**; a dark pink topaz from Brazil of 34 cts. Now on display at Smithsonian Museum, USA.

**Pink Topaz**; a pink topaz from Brazil of 33.46 cts. now on display at Geological Museum, London, England.

**pink topaz**; artificially colored by heat-treatment of



certain red-orange, yellow to brown varieties of topaz.  
→ Pinked topaz.

**pink topaz;** very rare naturally pink topaz.

**pink tourmaline;** naturally pink tourmaline.

**pink Welsh alabaster;** a thin banded, fine granular, pink variety of alabaster from Welsh, South Wales, England.

**Pinna;** same as Pinna pearl.

**Pinna pearls;** pearl from the salt-water bivalve mollusk of the genus *Pinna nobilis linné* (noble pen shell or *Pinnidae*). The color is reddish, golden, orangey, grayish, or rose tinted, lacks orient and a rather fragile radiating structure of prismatic crystals.

**Pinna seminuda;** a salt-water bivalve mollusk of the genus *Pinna nobilis linné* (noble pen shell or *Pinnidae*) from Mediterranean Sea, which live buried in soft sand, anchored by a silky byssus. The broad outline of the shell varies from fan-shaped to jambonneau. The pearl color is reddish, golden, orangey, grayish, or rose tinted, lacks orient and a rather fragile radiating structure of prismatic crystals. Also known as Pinna, wing-shell, sea wing, silkworms of the sea, or noble pen shell.

**pinnae;** a sharp pyramid or needle-shaped peaks.

**pin-point in diamond;** any minute, white or dark circular inclusion seen at 10x magnification but not large enough to be distinguished as an inclusion.

**pin-point opal;** a variety of precious opal, which resembles the pinfire opal.

**pintas;** a term used in Mexico for an opal-working areas on the surface.

**piotine;** same as soapstone.

**pipe;** same as volcanic pipe.

**pipe;** a nearly vertical, cylindrical elongated ore body or opening.

**pipe-boulder opal;** a term used in Australian for a variety of opal of several thickness up to 3-30cm.

**pipeline;** same as diamond pipeline.

**pipe mines;** diamond deposits on kimberlite or lamproite pipe for eventual recovery of diamonds.

**pipe opal;** a local term used in Queensland, Australian for opal that found in tubular channels in rocks.

**pipe opal;** elongated opalized belemnites, a cigar-shaped fossil of fine-quality with horny internal structure of cuttlefish. Found in White Cliffs and Queensland, Australia.

**pipe organ;** an optical phenomenon can be seen in some green zircon stones under spectrometer. This exhibits 40 or more lines uniformly disturbed through spectrum similar to an organ.

**pipe stone;** same as pipestone.

**pipestone;** a soft, brownish to reddish-pink catalinite stone containing pyrophyllite, carved by Minnesota,

Dakota Indians, USA into tobacco pipes. Also locally called catalinite, Indian pipestone and spelled pipe stone.

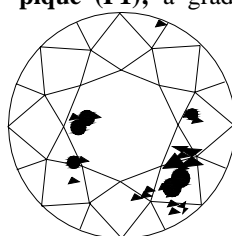
**pipe, volcanic;** same volcanic pipe. → Pipe.

**pipi pearl;** a local term for minute pearls of 4-12 grain of milky white color fished from shallower water of Tahiti.

**piping, light;** a modern technique used to illuminate the microscopic sample through a fiber-optic system.

**piqué (clarity grade of diamond);** a diamond of lower grade of clarity or purity, which has small inclusions visible to the naked eye or not. There are 3 grades of piqué diamonds according to increasingly poor stones abbreviated P1, P2, P3 for stones weighing 0.50 cts, or more. Abbreviation: PK.

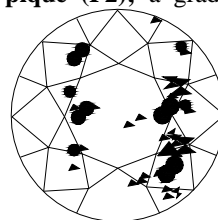
**piqué (P1);** a grade of clarity or purity of diamond, which has small inclusions that are only visible with a 10X loupe, which does not reduced the brilliancy of the stone.



diamond  
clarity grade:  
imperfect  
piqué-1 (P1  
or I1)

Abbreviation: P1. → Piqué.

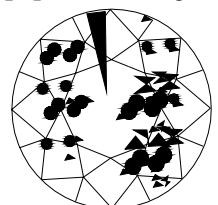
**piqué (P2);** a grade of clarity or purity of diamond, which has large and numerous inclusions that are visible to the naked eye, which reduces brilliancy of the stone. Abbreviation:



diamond  
clarity  
grade:  
imperfect  
piqué-2  
(P2 or I2)

P2. → Piqué.

**piqué (P3);** a grade of clarity or purity of diamond, which has large inclusions that are easily visible to the naked eye, which result in reduced brilliancy of the stone. Abbreviation: P3. →



diamond  
clarity  
grade:  
imperfect  
piqué-3  
(P3 or I3)

Piqué.

**piqué marks on pearls;** small dimples on natural pearls called *piqué marks*, which are not the same as *pits* that are seen frequently on cultured pearls. Pit is slightly smaller than dimple.

**piqué point;** same as piqué work.

**piqué rosé;** same as piqué work.

**piqué strips;** same as piqué work.

**piqué work;** a style of decoration of small pieces of tortoise-shell, ivory, and mother-of-pearl, which have been inlaid with minute pin-head dots of silver known

as piqué point or strips known as piqué rosé.

**pi ritual jade;** a Chinese term used for a flat disc with a hole in the center made of a blue-green stone to symbolize the heaven, which was placed under the body in tomb. → Chinese ritual and symbol jades.

**piro-esmeralda;** a Spanish-Portuguese misleading term for fluorite.

**piro-smeralda;** an Italian misleading term for fluorite.

**piruzeh;** Persian or Farsi term for turquoise.

**pisiform concretion;** same as pisolite.

**pisolite;** a variety of a coarse-grained calcite or aragonite with rounded grains like beans or peas. Also called pea grit, peastone, pisiform concretion.

**pisolite;** a variety of sedimentary rock usually limestone or aragonite with rounded grains like beans or peas may cemented together as a coarse-grained oolite. Also called pea grit, peastone.

**pisolite;** small rounded or ellipsoidal accretionary grains in a sedimentary rock, which resembles a pea in shape and size. Also called pisiform concretion, pisolith.

**pisolitic;** consisting of or containing rounded grains like beans or peas such as pisolitic beauxite, pisolitic limestone.

**pissophane;** wax-impregnated hydrophane with play of color.

**pistacite;** a synonym for pistachio-green variety of epidote. Also spelled pistazite.

**pistazite;** same as pistacite.

**pit;** a commercial term for very minute fracture on the surface of a facet or along the junction of two facets of a fashioned gemstone or diamond.

**pit;** small etch marks or trigon on a rough gemstone, which indicate a threefold symmetry.

**pit;** same as open pit mining.

**pit;** a minute cell on metals formed by local corrosion. → Pits in crystals.

**pit amber;** a term used for mined amber to distinguished it from sea amber. Pit amber is covered with a dark gray to brown crust, which must be removed.

**pit mining;** same as open cast mining.

**pitchblende;** massive amorphous to microcrystalline variety of uraninite. Also called pitch ore, nasturan, black blende, pitch ore.

**pitch garnet;** dark yellow variety of andradite.

**pitch lap;** lap surface has been covered with pitch.

**pitch opal;** a yellowish to brown inferior quality of common opal with a shiny resinous luster. Also called resin opal.

**pitch ore;** same as pitchblende.

**pitch stone;** same as pitchstone.

**pitchstone;** a type of glassy igneous volcanic rock rather like obsidian but with a waxy, dull, resinous pitchy

luster owing to the absorption of water. Its composition and color vary widely. Synonym for fluolite. Also spelled pitch stone and called fluolite.

**pitchy;** resinous. Dull but definitely shiny.

**pitchy luster;** having the luster of a fresh surface of pitch.

**Pitdah;** a biblical term for the second gemstone in the Breastplate of the High Jewish Priest. By different authorities to be a topazios, probably greenish chrysolite or peridot. The term Pitdah means yellow and may prefer to topaz. The stone is engraved with the name Simeon.

**Pit Diamond;** → Regent Diamond.

**pit mining;** same as open pit mining.

**pits in crystals;** a minute indentation or depression or striation left on the face of a mineral which may give an indication of the symmetry. → Pit.

**Pitt Diamond;** formerly name for Regent Diamond.

**pitted;** stones that contains pits.

**pitting;** the act of digging a pit.

**pittizite;** same as lepidolite.

**Pi Yü;** a Chinese term for vegetable-green jadeite or nephrite.

**PK;** an abbreviation for piqué.

**PK synthetic rubies;** → Knischka synthetic rubies

**Pizarro pearl;** → Oviedo pearl.

**Placenta, pearls from the;** pearl of inferior quality from salt-water mollusk *Placenta placenta*. → *Placuna* pearl.

**Placenta placenta;** a kind of salt-water pearl-bearing oyster fished in Tablegram Bay, Sri Lankan, Borneo and Kakinada Bay on the Madras, India. The pearls are dull, bright lustrous, irregular or spindle-shaped, and free pearl in the mantle. Used as medical purposes and lime when it is burned. Also called window pan, vitre chinoisé, *Placenta* shell. Found in Japan and names as *taira gai*.

**placer;** concentration of valuable alluvial minerals such as gold, diamond, and ruby on the surface, chiefly of fluvial origin. Recovered by hydraulic washing, dredging, and sometimes panning → Alluvial deposits.

**placer deposit;** deposit of heavy and valuable minerals concentrated on the surface deposited by moving water or air.

**placer gold;** gold in more or less coarse grained flakes, which occur in placer.

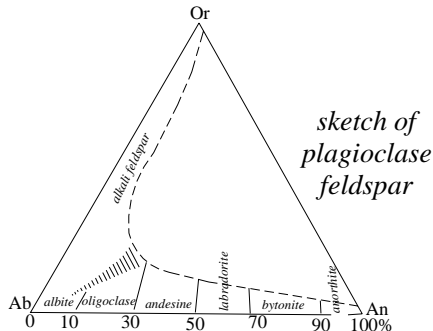
**Placuna oyster;** a kind of pearl-bearing oyster from Sri Lankan coasts.

**Placuna pearl;** pearl of inferior quality from salt-water mollusk *Placuna* or window glass shell. Used for medical purposes.

**Placenta shell;** same as *Placenta placenta*.

**plagioclase feldspar;** an important member of isomorphous group of triclinic feldspar minerals of

general formula:  $4[(\text{Na,Ca})\text{Al}(\text{Al,Si})\text{Si}_2\text{O}_8]$  ranging from albite Ab:  $4[\text{NaAlSi}_3\text{O}_8]$  to anorthite An:  $4[\text{CaAl}_2\text{Si}_2\text{O}_8]$ , the Plagioclase minerals are subdivided and named according to mole increasing of anorthite component in albite composition, Albite Ab<sub>100</sub>-An<sub>00</sub>, oligoclase Ab<sub>90-70</sub>-An<sub>10-30</sub>, andesine Ab<sub>70-50</sub>-An<sub>30-50</sub>,

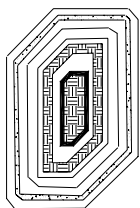


labradorite Ab<sub>50-30</sub>-An<sub>50-70</sub>, bytownite Ab<sub>30-10</sub>-An<sub>70-90</sub>, anorthite Ab<sub>10-00</sub>-An<sub>90-100</sub>. The refractive indices and specific gravity increases from albite to anorthite due to the increasing of calcium in chemical composition. Albite optics;  $\alpha$ :1.527,  $\beta$ :1.531,  $\gamma$ :1.538. 2.60-2.63. Anorthite optics;  $\alpha$ :1.577,  $\beta$ :1.585,  $\gamma$ :1.59. SG:2.74-2.77. Some gem varieties such as peristerite, labradorite, aventurine, etc. are faceted or cut cabochon. → Moonstone, adularescence, chalcidony moonstone.

**plagioclase feldspar as inclusions;** as inclusions can be seen in some garnet crystals.

**plagioclase rock;** same as anorthosite.

**plagioclase zoning;** the straight, parallel growth-lines in the internal structure of plagioclase with definite angles, which occur by slightly variation in the chemical composition within the crystal due to separation or interruptions of the



*cross  
section of  
zoning  
feldspar*

crystal phases during growth.

crystal phases during growth.

**plagioclasite;** same as anorthosite.

**plagiogranite;** a term used for igneous rock having low potassium content.

**plain cut;** any cut stone without facets such as cabochon.

**planar flow structure;** parallel arrangement of platy mineral which is formed by slablike inclusions, by schlieren, by bands of different texture of minerals. Also called platy flow structure.

**planchête;** a new name for shattuckite. A massive granular of fibrous minerals. Often is pseudomorphous after malachite. It resemble turquoise and azurite. Cut into cabochon and tumbled. Also spelled plancheite.

System: orthorhombic.

Formula:  $4[\text{Ca}_x(\text{Si}_4\text{O}_{11})_2\text{H}_2\text{O}]$ .

Luster: satiny.

Colors: shades of blue.

Streak: bluish.

Diaphaneity: translucent.

Cleavage: not determined.

SG: 3.65-3.80.

H:5½.

Optics;  $\alpha$ :1.697,  $\beta$ :1.718,  $\gamma$ :1.741. ⊕.

Birefringence: 0.044.

Found in Zaire (Africa), Utah, and Arizona, USA.

**plancheite;** same as planchête.

**plane of mirror symmetry;** same as plane of symmetry.

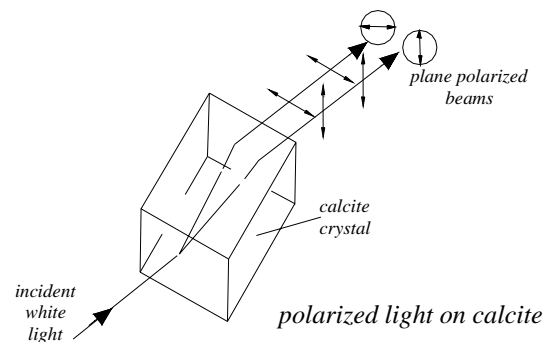
**plane of polarization;** same as plane polarization.

**plane of reflection;** same as symmetry mirror plane.

**plane of vibration;** same as vibration plane.

**plane of symmetry;** in crystallography, an imaginary plane through a crystal, which divides it into halves so that one is a mirror image of the other. This is very important for classification of crystals into their system and class. Also called plane of mirror symmetry or mirror plane. → Mirror symmetry.

**plane polarization;** in optics, a plane of polarized light, containing the incident and reflected light rays and



normal. Also called plane of vibration, plane of polarization.

**plane polarized light;** in optics, light traveling through a Nicol prism or a polarizing plate, which suffered so that all its vibration are in parallel planes like reflected light from a surface of polished gemstone. Useful in gemology for the study of pleochroism and in dichroscope. → Polarized light.

**plank jet;** a synonym for hard jet.

**planned leakage;** → leakage.

**plain shaft;** a term used by Australian miners for a shaft that was never timbered.

**plant;** a term used by Australian miners for some who hide his opals in a place.

**plants;** a Chinese term used for carved plants that are as religion symbols and ever-present. Small carving of animals was used as tomb pieces as guardians

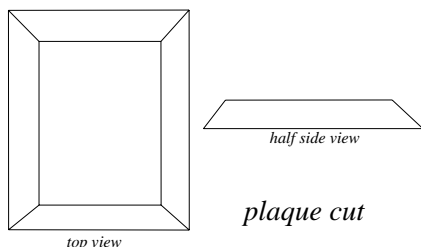
symbols. → Chinese ritual and symbol jades.

**plaque;** a type of brooch used as an ornament usually rectangular or plate-like.

**plaque;** a term applied to a round disc tablet, made of jade used as independent or as a fixed ornament insert in another vessel.

**plaqué;** a thin layer of noble metal on base metal such as 18 karat gold plate on brass, etc.

**plaque cut;** a modified oblong rectangular faceted flat stone with four trapeze facets and a large 4-sided table,



actually without pavilion.

**plasma;** a translucent to opaque, dark-green to bright-green, nearly emerald-green variety of cryptocrystalline chalcedony containing microfibrils of actinolite, frequently flecked with white or yellowish spots. Those with red spots are known as bloodstone. Green color caused by chlorite. Often used in signet rings and amulets.

**plasma di smeraldo;** an Italian misleading term for prase.

**plasma enhanced chemical vapor deposition;** → chemical vapor deposition.

**plasma furnace;** a type of Verneuil furnace used to produce synthetic gemstones with an intense gas burner for the fusion of gem substances.

**plaster of Paris;** a white, powdered hemihydrated calcium sulfate or hemihydrated gypsum,  $\text{CaSO}_4 \cdot \frac{1}{2}\text{H}_2\text{O}$ . Soluble in water and acid. Used to produce the so-called *ficile ivory*. Also called dried gypsum, calcined gypsum. → Gypsum.

**plaster stone;** same as gypsum.

**plastic;** any variety of natural or synthetic, transparent to translucent material resins, which can be molded by heat or pressure, or both, such as celluloid, perspex, bakelite, or lucite. Plastics are light, soft, and sectile. Used as imitation gems to resemble amber, ivory, coral, shell, jet, turquoise, etc., articles of costume jewelry and modern purposes. → Plastics.

**plastic, covered star sapphire with;** an imitation, frequently seen that white star sapphires are coated with a red plastic.

**plasticine;** carbonyl or carbon tetrachloride used to anchor pearls during X-ray photography.

**plasticity;** a property of certain minerals, by which the

deformation caused by stress is largely retained after the stress has been removed.

**plastics;** a general term for all high molecular synthetic resin like materials that can be molded by heat or pressure, or both. Plastics are classified into thermoplastic and thermosetting materials, such as bakelite, or lucite. → Lapis imitation, plastic.

**plastics, alkyd;** a synthetic thermosetting resin or plastic made of phthalic anhydride with polyhydric alcohol, sometimes used for imitation of gem materials. Also called glyptals plastic.

**plastics amber imitation;** reportedly Chinese made imitation amber by boiling chicken with the fat of a fish of dark color. Union of organic resin escaped several molecules generate a new compound with different properties and a higher molecular weight and hardness which metamorphosed from tacky resin-like to a solid substance. Acrylic, styrene, Bakelite, polyester resin, and generally plastics are new plastics product. → Plastics, imitation amber, plastic.

**plastics, amino;** → aminoplastics resin.

**plastics, acrylic;** → acrylic resin (plastics), imitation opal.

**plastics, bakelite;** → bakelite.

**plastics, beetle;** a synthetic resin or plastic made of urea formaldehyde or melamine formaldehyde, sometimes used for imitation of gem materials.

**plastics, casein;** → casein.

**plastics, celluloid;** → celluloid.

**plastics, distrene;** → distrene.

**plastics, epoxy ester;** → epoxy esters (plastics).

**plastics, glyptals;** → plastics,-alkyds.

**plastics, melamine;** → melamine formaldehyde resin.

**plastics, nylon;** → nylon.

**plastics, perspex;** → perspex.

**plastics, polyethylene;** a thermoplastic polymer made of converted polyethylene formed into a flexible waxy material.

**plastics, polystyrene;** a hard, colorless, clear thermoplastic synthetic resin used as a gem imitation.

**plastics, polythene;** polythene is a generic term for polyethylene.

**plastics properties;** properties of acrylic resin or plastics used as gem imitations are: *heat conductivity* is similar to glass feel warm, *SG* less range of 1.05-1.55, *hardness* is less 1.50-3.00, *refractive index* range of 1.46-1.70, *luster* is greasy to subvitreous to waxy, *fracture* is generally conchoidal *Visual feature* may be orange peel. *Optical character* show snake-like bands or strain. *Hot-point reaction* is peculiar because it will melt or char when touched with the heated usually point with acrid odor or vinegar, formaldehyde, sweet fruit, sour milk, fish, camphor, and carbolic acid. In

*microscopical character* may be seen flow lines like glass and gas bubbles in various shapes or in some engine-turned features such as in imitation ivory.

**plastics, protein;** casein part of milk and formaldehyde produce a hard plastic material used as imitation gem.

**plastics, urea-formaldehyde;** a synthetic thermosetting resin or plastic made by heating together urea and formaldehyde. RI:1.55-1.60. SG:1.50. Used for imitation gems and amber.

**plastics, victron;** → victron plastic.

**plastron;** an ornamental piece used by women as bodice.

**plastron;** a horny or bony plate ventral portion (underside) of the shell of a tortoise or turtle or blonde shell composed of four plates .

**Platberg Diamond;** reportedly a diamond of 5 cts, was recorded in 1859 in the day book of Pniel Mission near Platberg, South Africa. It was discovered 7 years before the Eureka Diamond. Present owner unknown.

**plate cut;** a large flat cut, in which top and base are parallel to girdle, may be stepped or beveled. Used for opaque materials. → Portrait stone.

**plate;** → plates.

**plates;** any thin, flat, smooth surface stone or a rock that split readily into slabs, such as flagstone. A platy habit.

**platinum;** a hard, heavy, ductile, silvery-white or grayish-white metallic element of the group VIII B of the Periodic System with the symbol Pt. Very important metal, more costly than gold. Used in jewelry and as alloy.

**platinum group;** same as platinum metals.

**platinum metals;** platinum, ruthenium, rhodium, palladium, osmium, and iridium are member of group VIII B of the Periodic System. Platinum and iridium are used as principal precious metals for setting gems. Also called platinum group.

**platinum mounting;** particularly platinum is the best metal for diamond mounting as it is not only white but much harder than gold.

**Plato effect;** same as Plato test.

**Plato-Mitchell technique;** an immersion method near to Becke line test, which depend on different behaviors of light on immersed stones in the liquid by observing through a microscope.

**Plato-Sandberg effect;** same as Plato test.

**Plato test;** a method for recognizing synthetic corundum containing no flaws and detectable striae. By using the polariscope the optical axis direction of the stone can be located. The immersed stone in methylene iodide is examined between crossed polariscope at 20-30x magnification. When the stone is examined parallel to an optic axis direction two sets of lines intersecting at 60° are visible, the stone is a synthetic corundum.

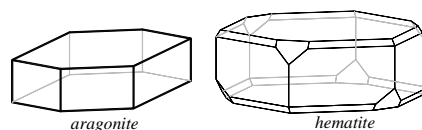
Natural corundum except stones from Tanzania, exhibit similar effects. Also called Plato effect, Plato-Sandberg effects.

**plattnerite;** same as lead dioxide.

**platy;** a platy habit. → Plates.

**platy flow;** same as platy flow structure.

**platy crystal habit;** the characteristic crystal form or



*platy crystals*

forms, in which a crystal usually appeared as thin and flat, such as tabular or platy hematite.

**platy habit;** a platy habit such as some crystals of hematite. → Plates.

**play-of-color in opal;** an optical phenomenon exhibition of prismatic colors with the play of the soft rainbow colors seen in some opals, when cut cabochon caused by interference of light by extremely minute uniform spheres of cristobalites of 150-300 nm in diameter of amorphous silicium oxide. When light passes through and strikes planes of spaces between the cristobalites spheres, certain wavelengths suffered diffraction and may flashed out from the gemstone, is known as play-of-color, which has been produced in synthetic opal. Not to be confused with fire or dispersion.

**play-of-colors;** an optical phenomenon exhibition of prismatic colors with the play of the soft rainbow colors seen in some gemstones, when cut cabochon caused by interference of light of extremely minute regular structures from beneath the surface or layers of different refractive index of the stone. In precious opal, the so-called iridescence is due to innumerable submicroscopic spheres of cristobalites. Not to be confused with fire or dispersion. Also called schiller. → interference and diffraction colors.

**Pleistocene;** the first of two epoch of the Quaternary period, approximately 2.0 million to 10.000 years ago. Worldwide series of rocks. Also called Ice Age, Oiluvium, Pleistocene Age.

**Pleistocene Age;** same as Pleistocene.

**pleochroic;** a gemstone that displays pleochroism. → Pleochroism.

**pleochroic color;** a gemstone that displays pleochroism.

**pleochroic gem;** a gemstone that displays pleochroism.

**pleochroic halo;** dark-colored circular zones around small spheres caused by radioactive inclusions specially

by alpha particle irradiation in certain crystals such as zircon. → Dispersion halo.

**pleochroic stone;** a gemstone that displays pleochroism.

**pleochroism;** a transparent gemstone that displays pleochroism, when light is passed through it from different directions. Also called polychroism. → Dichroism.

**pleocrystalline;** same as holocrystalline.

**pleomorphism;** same as polymorphism.

**pleonaste;** a dark variety of iron-rich spinel the same as ceylonite. RI:1.77-1.78. SG:3.63-3.90. Also candite, called ceylonite, ceylanite, zeylanite.

**plexiglas;** a commercial term for clear acrylic thermoplastic resin made of methyl methacrylate. May be formed in rods or sheets and is resistant to weathering. Used as imitation bead gems.

**Pliocene;** a geologic epoch of the tertiary period of the Cenozoic era, after the Miocene and before Pleistocene, 7-2 million years ago. Worldwide series of rocks.

**plombières saponite;** a misleading local term for clay montmorillonite from Plombières, France.

**plot;** → facet diagram.

**plotting;** → facet diagram.

**plotting symbols;** → facet diagram.

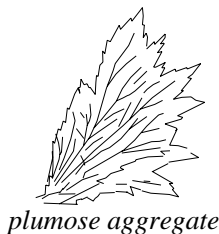
**ploy daeng;** a Siamese term applied for type-A, a classification of ruby used in Thailand for red stone, which has slightly purplish or brown color. → Ruby colors terminology in Thai, some.

**plugging of pearl;** for plugging of pearl chicken-feather quills, very fine rawlplug made of wood, plaster-of-Paris and pearl cement are used.

**plume;** same as plume agate.

**plume agate;** a translucent to opaque, creamy to pinkish, yellowish variety of moss agate, in which the red, black, brownish-black, or orange markings are feather-like. Cut cabochon and prized by collectors.

**plumose;** same as feather-like.



plumose aggregate

**plumose structure;** feather-like structure.

**plum-pudding stone;** same as puddingstone.

**pluton;** a term applied to igneous intrusion.

**pluton;** same as plutonic rock.

**plutonic;** rocks that have crystallized by the action of heat deep within the earth's crust.

**plutonic rocks;** a medium-grained to coarse-grained

igneous rock formed by high temperature and pressure within the earth's crust by crystallization of magma or by chemical alteration. Also called plutonite, or pluton, intrusive rock, intrusive igneous rock.

**plutonium;** an element, which is a product of radioactive decay of neptunium of the Periodic System, with symbol Pu.

**plutonite;** same as plutonic rock.

**Pm;** a chemical symbol for the element promethium.

**pneumatolysis;** changing of rocks and the crystallization of minerals during the action of hot gaseous substances associated with igneous activity in the later stage of cooling and solidification.

**pneumatolitic rocks;** rock formed by pneumatolysis.

**Pniel;** location of a small alluvial diamond deposit in the Vaal River, Kimberley, South Africa.

**P-nitrobenzene-azo-orcinol;** crushed beryl fused with sodium hydroxide and digested in water, a few drops of liquid are placed on the filter paper by adding one drop of 25% potassium cyanide, if a pink color appears signified the presence of beryllium. → Quinalizarin, morin test of beryl, alkalinity test.

**Po;** a chemical symbol for the element polonium.

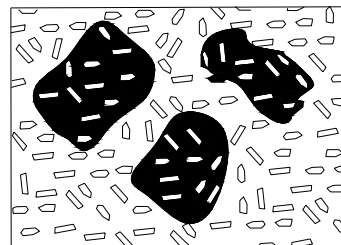
**pocket;** a cavity in rock enrichment with minerals or inclusions such as in tourmaline. Also called nests.

**pocket;** a term used by Australian miners for a minute cluster of opal prompt see in one place.

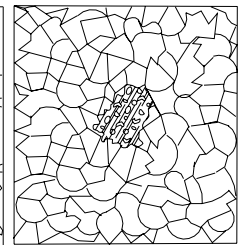
**pocket lens;** same as hand lens, pocket glass, head lens.

**Pohl Diamond;** an alluvial diamond of 287 cts, in rough found by J. D. Pohl in 1934 in Elandsfontein, South Africa. It was cut into 15 polished diamonds. The largest of them an emerald cut weight 38.19 cts, purchased in 1943 by Bernice Chrysler Garbish. Present owners unknown.

**poikilitic;** an intergrowth texture of small crystals scattered irregularly or sometimes subparallel such as



poikilitic structure



poikiblast structure  
of a xenolithic  
inclusion

plagioclases in a larger crystal such as pyroxene. Also called poikilitic texture. → Poikilitic aligned laths.

**poikilitic aligned laths;** an intergrowth (inclusions), of plagioclase subparallel to the *c*-axis of dravite tourmaline which can be seen in Yinnieharr district, West Australia.

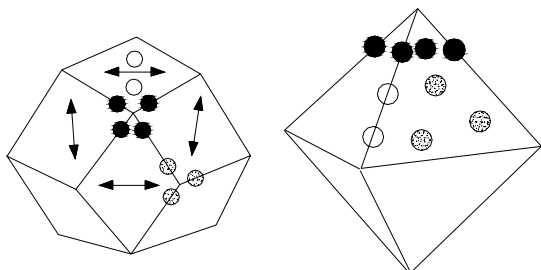
**poikilitic texture;** same as poikilitic.

**point;** a unit of weight used in jewelry for gemstones and diamonds, being one hundredth of a carat.

**point agate;** another term for point chalcedony.

**point chalcedony;** a white or gray variety of chalcedony flecked with red spots of iron oxides.

**point-cut diamond;** an old cut style where the faces of



*situation of 2,3 and 4 point on a dodecahedron and octahedron diamond*

octahedral crystal were sawn and polished it is called four-point, when the table of a cut stone is parallel to the face of the cube with a fourfold symmetry, therefore the brilliant-cut diamond has been developed from point-cut diamond. Also called glassies. → Three-point.

**point defects;** mechanism of color alteration caused by involves the operation of a color center which occur from a defect in the crystal structure. In the defect crystal an atom may be missing from its expected position, the space of this defect, which may have filled from the other atom. Known as vacancy. → Color center, ions center.

**pointed hexagonal cut;** same as hexagonal cut.

**pointer;** a diamond weight less than one carat, being one hundredth of a carat.

**point in diamond;** → point-cut diamond.

**pointing;** facets of a well-shaped gemstone meeting point-to-point.

**pointing;** dressing the surface of a gemstone with a pointed tool.

**pointing;** a term used to the operation of reducing the size or shape of an end portion of a tube or pipe.

**point naif;** a term used in the 17<sup>th</sup> century for distinguishable natural faces by a diamond octahedron or other gemstone.

**pointolite lamp;** the powerful light source used in an endscope, in which the light emanates from a single point form, which then passes through a system of condensing lenses. Also called point source.

**points (tips of ivory tusks);** small articles made from ivory.

**point source;** same as pointolite lamp.

**point stones;** same as table cut. An older cut style where the faces of octahedral crystal were polished and

therefore the brilliant-cut diamond was developed from a point-cut diamond.

**pointille pattern;** some pieces of gemstones such as jet or amber are dotted with point pattern. → Spacer plates.

**pointillism;** a technique of adding dots or tiny spots of saturated color elements to a surface to avoid subtractive colors. Now green and violet dots would give white and not black, therefore much brighter color can be achieved.

**poire;** a French term for pear or pear-shape.

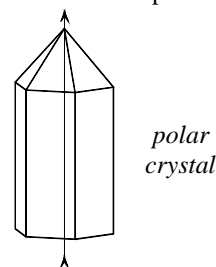
**poison;** presence of iron oxide traces in emerald dimmed, which suppresses its fluorescence and therefore may not exhibit red, when observed through filter and remain green.

**poison antidote;** → antidote to poison.

**poison;** any material, which is dimmed or suppressed by the luminescence of an irradiated stone.

**poisons;** → phosphor in zinc sulfide.

**polar crystal;** same as hemimorphic crystal.

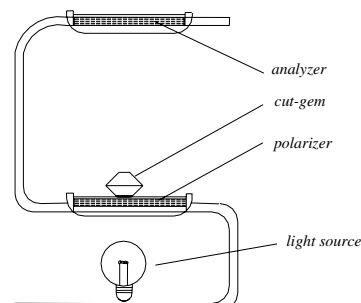


*polar crystal*

**Polar-jade;** a term referring to nephrite from British Columbia.

**polarimeter;** → polariscope.

**polariscope;** an optical device made of two polarizers with a rotating stage between them. The lower unit through, which light enters is named the polarizer, and other unit above is called analyzer. It is used to determined whether a mineral or substance is single refractive or double refractive or possesses an anomalous double refraction such as diamond and or



*sketch of polariscope*

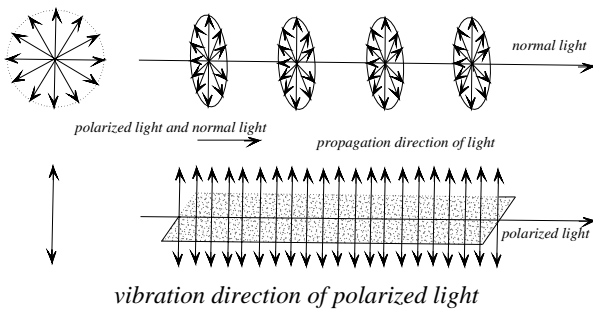
synthetic spinel, or strain in some glasses. A double stone such as corundum under polariscope between polarizer and analyzer appears light and dark on

rotation at 360°. Glasses and singly refractive stones such as spinel or garnet remain inert or dark. It is used in convergent or parallel light the same as all petrological microscopes. Also called polarimeter.

**polarity;** the condition of a system having opposing physical properties at different points of a prismatic crystal. For example pyroelectricity or piezoelectricity effect or an electric dipole.

**polarization color;** same as interference color.

**polarization of light;** a condition, in which the ordinary light consists of electric and magnetic vibration, the

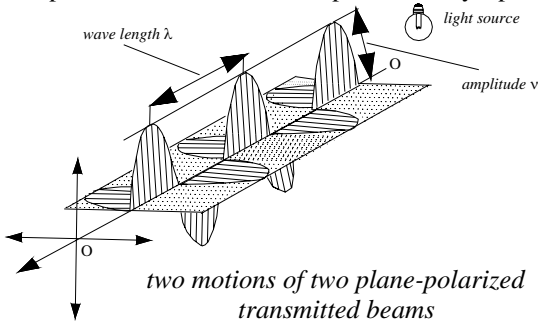


vibration being at right angle to the direction of the light pass, such light is a transverse vibration. The plane at right angles to the plane of transverse vibration is known as plane of polarization. Polarized light is used by the polarizing microscope for the study of thin section of rock and minerals. → Double refraction.

**polarization, circular;** → circular polarization.

**polarized;** → polarized light.

**polarized light;** electromagnetic radiation, which waves vibrate transversely in only one plane. Polarized light can be obtained by using a prism or other polarizer by absorption of one of the two polarized rays passing



through the Nicol prism or Polaroid disc. When light enters a double refractive stone such as calcite, the light is divided into two rays by emerging, which are plane polarized at right angles to each other as seen in figure below, the *e*-ray lies in the plane including the crystal *c*-axis, but in the *o*-ray it is perpendicular to that of the *e*-ray. *O*-ray or ordinary ray is undivided, while the *e*-ray

or extraordinary ray is displaced from the original beam. When rotated the calcite crystal the *o*-ray or ordinary ray remains fixed, but *e*-ray or extraordinary moves in a circle around *o*-ray. Determination of *o*-ray and *e*-ray shows only a single vector is present in each. By emerging of two rays no light is absorbed and exactly half is seen in each beam but both *o*-ray and *e*-ray are perpendicular to each other in the vibration directions. The emerging rays are *polarized* or *linearly polarized*. Such light is used in microscopical study. The nicol prism is applied, when a double refractive crystal plane has polarized rays, which are at right angles to one another. → Polarization of light, plane polarized light, double refraction.

**polarizer;** a device, such as Nicol prism, polaroid sheet, tourmaline plate, and glass reflecting plate, used to produce plane polarized light for polarizing microscope. → Polarizing filters.

**polarizing angle;** same as Brewster's angle.

**polarizing filters;** a device used to cut out unwanted reflections that are made from a plastic layer or film containing innumerable microscopic crystals of *herapatite* known as quinine iodosulfate, or oriented stretched long molecules, which have properties able to transmit light if it is vibrating in one plane, it is opaque to rays that are polarized at right angles to this plane. Used in photography to control reflections of distinguish crystals. Also commercially called polaroid. Other polarizing filters are Nicol prism, tourmaline plate, and glass reflecting plate.

**polarizing microscope;** → microscope.

**polarizing prism;** any prism used to produce polarized light. → Nicol prism.

**polaroid;** a commercial term for polarizing filters made of quinine iodosulfate with the name *herapatite*.

**Polar Star Diamond;** a cushion-shaped diamond of 41.29 cts, believed to be from India. It is said to be owned by Joseph Bonaparte, brother of Napoleon I of France. Sold in 1820 in Switzerland to Tatiana Youssouppoff, and was sold in 1920 to Cartier, in Paris. It was sold in 1980 at Christie's Geneva to a dealer from Sri Lanka. Now on displayed in Bombay, India. Also called Youssouppoff Diamond.

**polar symmetry;** a type of crystal having polar symmetry or different forms at two ends of an axis of symmetry. Also called hemimorphic. Hemimorphite is the characteristic sample.

**Pol;** location of a small kimberlite diamond deposits in Shandong Province, China.

**polish;** an attribute of a smooth and lustrous surface, which is usually obtained by a sanding process of abrasive grains between grinding and polishing. A well polished gemstone is characterized by the regularity of



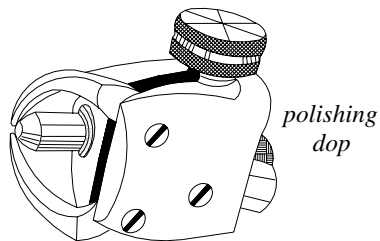
reflection and high luster, or highlight.

**polish;** a polishing substance used to smooth the surface.

**polished section;** a section of an opaque mineral which has been highly polished to study the mineral by plane or polarized reflected light. Also called microsection.

**polished thin section;** a thin section of a mineral or rock that has been polished but not covered with a cover glass. It is used to study the object by both transmitted and reflected light and by the electron microscopy. Also called microsection, thin polished section.

**polishing dop;** same as solder dop.



*polishing dop*

**polished girdle;** girdle of some fashioned diamonds are polished to give them a smooth curved surface. Not to be confused with faceted girdle.

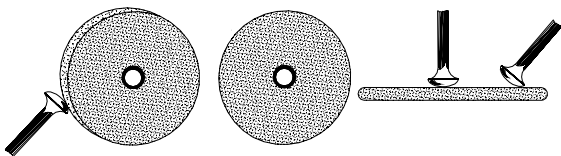
**polished goods;** polished or finished stones, as opposed to rough.

**polished stone;** same as metamarble.

**polished surface;** a term used for shiny surface.

**polisher;** the craftsman who places the facets on the diamonds or other gemstones and polishes them.

**polishing;** the final process after placing the facets on the gemstone, which has been rubbed with various abrasives to smooth and brighten the surface. The final



*simply polishing of a gem mounted on a wooden stick*

polishing by machine is used to achieve a lustrous surface. Cutting and polishing carried out in one operation. → Cross cutter, brillianteerer.

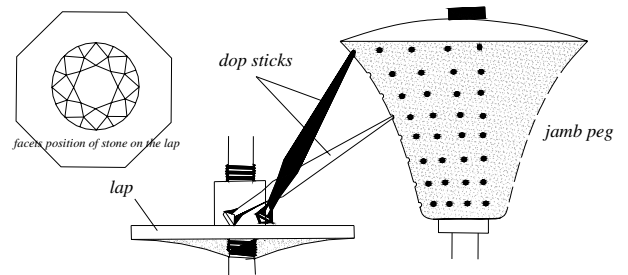
**polishing and grinding;** same as grinding.

**polishing compounds of colored gemstone;** for final polishing of colored stones of greater hardness than 8 used fine grit of levigated alumina, tin oxide, chrome oxide cerium oxide, and Linde A.

**polishing compounds of diamonds;** fine diamond grit

is used for polishing diamonds.

**polishing diamond;** faceting and polishing of diamonds usually happen into two stages; cross cutter and



*diamond polishing device or jamb peg*

brillianteerer. → Diamond polish.

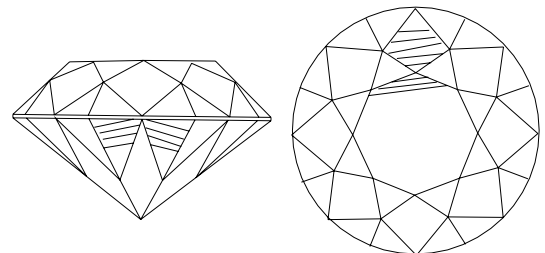
**polishing directions;** polishing of diamond depends the direction, in which stone can be polished. Facets parallel to the surface of a dodecahedron are much easier and faster to polish than those parallel to an octahedron. → Diamond polish.

**polishing grain;** → grain.

**polishing marks;** → burn marks.

**polishing lapidary;** → lapidary.

**polishing line;** very small parallel lines left on diamond facets during polishing and grinding by using a rotating



*left fine polishing lines on pavilion facets. Right polishing lines on crown seen through the pavilion*

wheel (scaife).

**polishing powders;** polishing powders are oxides of iron (rouge), tin (putty powder), aluminum (aloxite, alundum), manganese, chromium, cerium, rare earth's, or silica known as tripoli or rotten-stone.

**polishing wheel;** → scaife.

**polish of topaz;** topaz take a very high polish.

**polka dot agate;** a local term for translucent, colorless variety of agate with brown, red, yellow circular dots from Madras, India and Oregon, USA.

**pollopas;** a glass-like synthetic amine thermosetting plastic in the USA named as aldur.

**pollucite;** a rare cesium mineral of zeolite group. Cut as gems and prized by collectors.

System: cubic.

Formula:  $16[(Cs,Na)AlSi_2O_6 \cdot \frac{1}{2}H_2O]$ .

Luster: vitreous to greasy.

Colors: colorless to white, gray, blue, pink, violet.

Streak: white.

Diaphaneity: transparent to translucent.

Cleavage: poor.

Fracture: conchoidal to uneven. Brittle.

SG: 2.86-2.98.

H: 6½-7.

Optics: 1.518-1.525.

Dispersion: 0.012.

Found in Elba (Italy), Quebec (Canada), Sweden, Namibia, Brazil, Zimbabwe, Dakota, and Massachusetts (USA).

**pollucite inclusions;** very tiny, whitish spikes or balls and small snowflakes which are bulging at the center.

**pollucite luminescence;** orange or pink luminescence under UV light and X-rays.

**pollux;** an obsolete term for pollucite.

**polonium;** a radioactive metallic element of the Periodic System with the symbol Po.

**Polyarnyi;** same as Udachnaya mine.

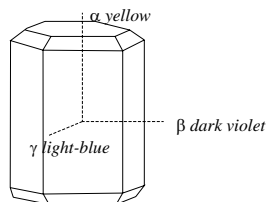
**polybern;** a commercial term for amber imitation composed of minute fragments of natural amber in a colored polyester plastic. Made in Germany, Poland and Lithuania used for making sculptures, souvenirs and jewels. The name is derived from polyester and Bernstein (German term for amber). → Bernat.

**polychroite;** another term for iolite.

**polycrase;** → euxenite.

**Polycrates Ring;** → Ring of Polycrates.

**polychroism;** a transparent gemstone that displays



*polychroismus or threechroismus in cordierite*

pleochroism, when light is passed through it from different directions. Also called polychroism. → Dichroism.

**polychromatic;** showing change of colors.

**polycrystalline;** composed of many small variously oriented crystals.

**polycrystalline diamond;** a diamond, which is composed of many minute crystals, used as an industrial powder.

**polycrystalline quartz;** same as composite quartz.

**polydiacetylines;** an organic compound made due to polymerization of diacetylenes because of long distance electron movement metallic, copper or gold colors are

observed. Used as dyes.

**polyene;** any organic unsaturated aliphatic or alicyclic colorant consisting more than four carbon atoms in a chain system of conjugated double bonds, which absorb light in visible region and is colored. There three groups noncyclic polyene, nonbenzenoid ring system, and benzenoid system. → Carotenoid, Vitamin A<sub>1</sub>, and crocetin as noncyclic polyene. See porphyrins as cyclic polyene.

**polyethylene;** same as polythene.

**polygonal pebbles;** same as wind-faceted pebbles.

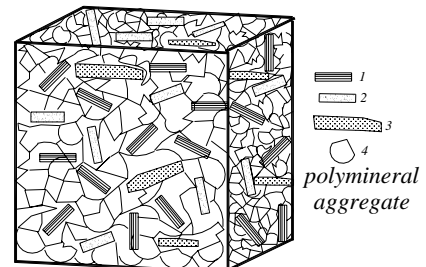
**polyhedroid quartz;** agate nodules with a peculiar angular form in which quartz-hematite filled the fracture zones with an interlocking pattern attached to the quartz-hematite wall-rock and they were separated from each other by thin tabular cavities, which running along whole the geode and formed trigonal growth pattern on the faces of polyhedroid. Suggested that triangular cavities was filled with calcite which may formed by crystallization of thin dendritic film on water surface.

**polymerization;** union of several molecules to generate a new compound having the same empirical formula as the simple one but with different properties and a higher molecular weight. Polymerization is built up from monomer units.

**polymerization of resin to amber;** the extreme pressure by covering material such as glacial, climatic change caused oxidation of resin volatile part of the fresh resin escaped an several molecules generate a new compound with different properties and a higher molecular weight and hardness which metamorphosed from tacky resin to a solid substance during over millions of years.

polymineral; same as polymineralic.

**polymineralic;** a rock composed essentially of two or more minerals, such as granite. A term usually used for

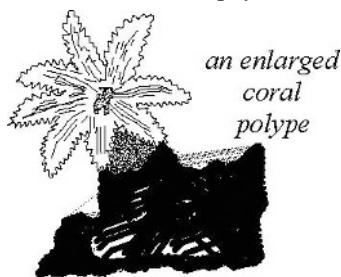


igneous rocks because consisting of more than one essential mineral. Also called polymineral.

**polymorphism;** the property of elements or chemical substances, which crystallize in two or more crystal forms, but with different physical properties caused by difference in the arrangement of atoms such as kyanite, andalusite, and sillimanite. Crystallizing of a substance

in different structures depend on the conditions, under which it forms. → Dimorphism.

**polyp, coral;** a hollow or cylindrical primitive branch-like or plant-like animal or zoophyte. It may be colonial



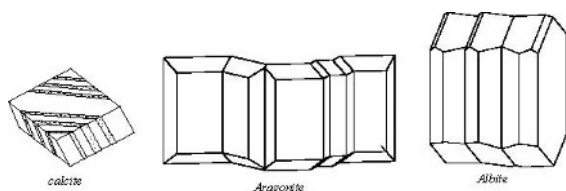
such as corals.

**polyphant stone;** an impure variety of steatite or so-called soapstone from Polyphant, Cornwall, England.

**polystyrene;** a commercial term for a synthetic, transparent, hard, thermoplastic styrene (polyvinyl benzene) resin with the formula  $(-C_6H_5CHCH_2-)_n$ . RI:1.59. SG:1.05. H:2½. Used for molding gem imitations.

**polysynthetic twin;** same as polysynthetic twinning.

**polysynthetic twinning;** successive twinning of more than two individual crystals according to the same twin law and parallel composition planes such as plagioclase



*polysynthetic twinning of calcite, aragonite  
and albite*

feldspars. Also called lamellar twinning. → Repeated twinning

**polythene;** a synthetic, thermoplastic polymer resin of ethylene. Used for molding gem imitations. Also called polyethylene.

**polyvinyl benzene;** → polystyrene.

**pomegranate;** a base term applied to garnet minerals because the color of pomegranate seeds is similar to the color of one of stones. Also known as pomegranate seeds.

**pomegranate seeds;** → pomegranate.

**pomegranate ruby;** a misleading term applied in India to red spinel.

**Pomona;** location of alluvial diamond deposits in South-West Africa.

**pompadour pearls;** a commercial term for imitation pearls.

**pompom agate;** a sagenitic chalcedony from Brewster County, Texas, USA, in which yellow or orange-red inclusions are so arranged that they resemble chrysanthemums or pompom.

**Pong Khan quartz;** a variety of rock crystal from Pong Khan of North Thailand.

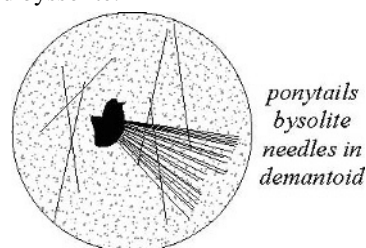
**ponite;** → rhodochrosite.

**Pontesinha Diamond;** same as Carbonado Pontesinha Diamond.

**pontianak;** a city on west coast of Borneo. A term used by native in Borneo for a stage of hardness form of semi-fossilized copal a variety of dammar resin. → Melengkhet, boea.

**Pontianak;** location of a small diamond deposits in Borneo.

**ponytails;** demantoid crystal contain asbestos fibers or so-called byssolite.



**Poolvash marble;** → Derbyshire black marble.

**Poona;** location for bluish-green beryl, emerald found in chlorite-schist and pegmatite dikes at Poona, West Australia.

**poor make;** it means a fashioned gemstone or diamond with deficiencies in symmetry or proportion.

**poor-quality of pearl;** mostly poor-quality and very small pearls are used as a medicine because to said it have aphrodisiac properties?

**popcorn cluster of amber;** a term used for a very small piece of amber, which is strung on slender silver wire, hung similar to popcorn.

**Pope Leo Topaz;** a topaz of ≈ 1.8kg. Found 1902. It was a present to Pope Leo.

**popo;** a term used in Guina, West Africa for green jasper.

**poppy jasper;** a kind of orbicular chert found in Santa Clara county, California, USA, referring to the yellow, green, brown and bright red spherules pattern. From the center of spherules grown small quartz crystals, which impregnated with colored orbicular inclusions of quartz, the color is caused by iron oxide. Frequently called orbicular jasper. Used as ornamental stone.

**poppy stone;** same as orbicular jasper found in Paradise Valley and Liagas Creek, California, USA.

**porcelain;** a translucent, hard, white, nonporous fine earthenware made by firing pure white kaolin (China clay) with feldspar and quartz, or with other substance

containing silica. Used as opaque imitation gems, such as turquoise. Normally it is molded and glazed as gem imitation. SG:2.10-2.30. Faience and frit are a type of porcelain. Also called china, hard paste or pâte dure.

**porcelainite**; a white hard metamorphose baked green and red clay. Also called thermuticle.

**porcelainite**; a variety of porcellanite.

**porcelain jasper**; a misleading term for a naturally baked impure clay of red or green color. Not to be confused with jasper (chalcedony).

**porcelain jewelry**; articles of jewelry made of decorated porcelain, which then has the surface enameled.

**porcelain opal**; a translucent to opaque milky white opal. → Porcelain.

**porcelaneous**; description of a rock that has the appearance of or resembles porcelain.

**porcelaneous chert**; a white, hard, translucent to opaque, smooth fracture surface chert, resembling chinaware or glazed porcelain.

**porcelanite**; same as porcellanite.

**porcellanite**; a light-colored, hard, compact, conchoidal fracture, high graded siliceous porcelain-like rock with a dull luster. It is less hard and vitreous than chert but resembled chinaware or glazed porcelain. Also spelled porcelanite, porcelainite.

**porfido ramello**; a north east Italian brownish-red limestone consisting of irregular conglomerates fragments embedded in marly matrix. Rosso Verona is similar to porfido ramello.

**porfido rosso antico**; a dark red groundmass colored hornblende porphyry contain light violet feldspar and piedmontite, the red color is caused by piedmontite inclusions. It was named in classical times as *porphyrites leptosephos*. In Roman times it was known as *lapis porphyrites* and later named as *stone of Rome*. Found in Jebel Dhokan, eastward from the Nile in Egypt.

**porfido serpentino**; a misleading term for a green pyroxene porphyry, which contains light green feldspar regardless of composition. Green color is caused by epidote and chlorite. Formerly it was erroneously named as *marmor Lacedaemonium viride*. Found in Greece.

**porfido verde antico**; same as marmor Lacedaemonium viride.

**porfirico limestone**; a reddish-brown white spotted limestone from northern Italy similar to purple imperial porphyry of Egypt.

**Porgés Diamond**; a champagne color, emerald-cut diamond of 78.53 cts, purchased by Harry Winston in 1962. Set in a clip-pendant with emeralds, rubies, and 32 old mine-cut diamonds. It was sold in 1968. Present owner unknown.

**pork knocker (diamond miners)**; a local term used in British Guyana for diamond or gold mining worker who carried out by pick and shovel.

**pork knocker (diamond miners)**; frequently used to describe illicit diamond diggers.

**porosity**; the condition possess by cavities between the mineral grains through, which liquid may transmit or, in which they may be contained. Pore volume.

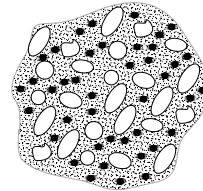
**porosity in amber**; the presence of bubbles in amber depend on size and density of the pores caused structural differences and therefore three categories of amber: (I) compact which is slightly porous and heavy. (II) Nodular, which is medium porous. (III) Foamy, which is very porous and light.

**porous**; in polishing diamond same as rough girdle.

**porous**; material having pores through, which liquid may transmit.

**porous limestone**; same as permeable limestone.

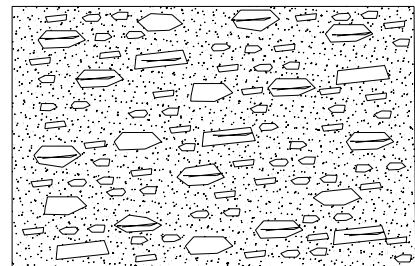
**porous stones**; a stone having crystalline or crypto-crystalline aggregates and numerous voids, cells, pores, interstices, or other openings, which permit transmission of liquids such as dyes.



vesiculars  
or porous  
in a rock

**porpezite**; a native alloy of gold and palladium which contain 5-10% palladium. Also called palladium gold.

**porphyries (igneous rock)**; any fine-grained igneous rock of hypabyssal, plutonic, or volcanic origin containing large crystals (phenocrysts) of any minerals set in fine-grained groundmass, such as porphyritic granite from Egypt. Porphyries solidified in two crystallization formations. The magma intrudes into

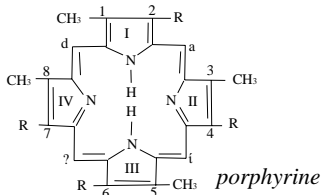


porphyritic rock texture consists of  
phenocrysts in a fine-grained groundmass

pre-existing rock or extrude on to the earth's surface enclosed in its fine-grained groundmass pre-formed crystals. In ancient times a green pyroxene porphyry containing light green feldspar was named *marmor Lacedaemonium viride* the green color caused by included epidote and chlorite, which was later named as *perfidio serpentino* regardless of composition. A dark-

red porphyry quarried in Egypt known as *porfido rosso antico*, which in antique times was named as *porphyrites leptosephos*, which in Roman times was known as *lapis porphyrites* and later named as *stone of Rome*. Other porphyries are red colored *llanoite* and gray diorite or hornblende gabbro clan with the name *corsite* or *napoleonite*. Used as an ornamental stone.

**porphyrins**; any physiological nitrogenous compound with cyclic structure of pyrrole rings (nonbenzenoid),



with a central metal ion such as hemin an iron-containing porphyrin essential to mammalian blood. They are subdivided compound of

polyene. *Hemin* (heme or haemin a red blood pigment), used as cellular metabolism and as phthalocyanine group for dye. Other important porphyrin is *chlorophyll* (with basic  $C_{55}H_{72}MgN_4O_5$ ), a natural green-blue wax pigment essential to photosynthesis, has a pyrrole rings (nonbenzenoid), with a central metal ion nearly similar structure to hemin. Soluble in ether, ethanol, acetone, chloroform, benzene, and methanol. Chlorophyll used in several industries as dyes. Next porphyrin is phthalocyanine group of blue to green colors, strong powder colorants with basic molecule  $(C_6H_4)_2N$  and nearly similar structure to hemin. Used as dye in enameling.

**porphyrite**; an obsolete term for hypabyssal igneous rock containing phenocryst plagioclase set in a fine-grained groundmass. → Porphyritic texture.

**porphyrites Leptosephos**; → lapis porphyrites, porfido rosso antico.

**porphyritic**; same as porphyritic texture.

**porphyritic crystal**; same as phenocryst.

**porphyritic granite**; → porphyritic.

**porphyritic obsidian**; obsidian like porphyry in appearance.

**porphyritic structure**; → porphyritic texture.

**porphyritic texture**; the texture of igneous rock that consists of large and well formed crystal set in a fine-grained groundmass. Also called porphyritic.

**porphy ware**; a variety of wedgwood (a ceramic, fine hard-ware like porcelain) tinted to resembled porphyry.

**portability of gemstones**; another property for gemstone may combined high value with small volume, weight and remain its value in times.

**Port Darwin shell**; a local term applied in Australia for *Pinctada maxima* shell used mainly for mother-of-pearl from north and Western Australia, and Malaya. → Macassar shell.

**Porter-Rhodes Diamond**; a colorless, octahedron rough

diamond of 153.50 cts, found in the Kimberly, South Africa in 1880, and named after Mr. Porter-Rhodes. It was cut into a 73 cts, old mine cut. Sold to the second Duke of Westminster in 1962. Later it was recut into an emerald-cut of 56.50 cts. Purchased by Maharaja of Indore in 1937. Harry Winston bought it in 1946 and repolished into a stone of 54.99 cts. In 1987 was sold to Graff Diamonds of London.

**Port Nolloth**; location of coastal alluvial diamond on the shore of Namaqualand south of the Orange River, South Africa.

**Portland stone**; a yellowish-white, ovoid or spherical limestone from isle Portland, England, used as ornamental stone like marble.

**Portland stone**; a violetish-brown sandstone found in Portland, Connecticut, USA. Used as ornamental stone.

**port of the North, amber**; a valley located on the northern in Kaliningrad, Russia.

**Porto marble**; a black marble containing siliceous, which is traversed by gold-colored veins, from Porto Venere and Isle Palmeria, Italy. Also called Black marble, gold marble.

**portrait cameo**; a profile bust or other object carved on gemstone set in pendants and finger rings.

**portrait diamond**; same as portrait stone (diamond).

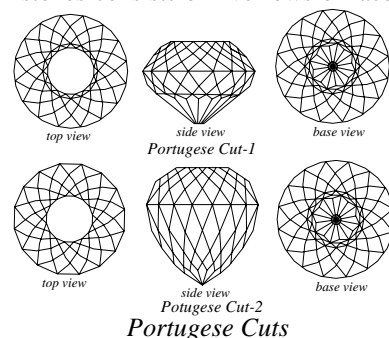
**portrait jewelry**; various articles such as finger rings, brooches, pendants, etc. decorated with a portrait.

**portrait ring**; a portrait cameo set in a finger ring.

**portrait stone (diamond)**; a thin flat diamond cut having a very large table and a pavilion sometimes with several row step facets around its girdle. Used for covering very small portrait in brooch or finger ring. It belong to the table cut style. Frequently such a flat diamond is found in nature. Same as bevel cut and lasque diamond. Also called portrait diamond. → Bevel-cut, plate cut.

**Portsoy**; location of serpentine mine in England.

**Portuguese Cut**; a modified brilliant-cut diamond or other gemstones consists of five rows of facets on both



crown and pavilion. Rarely used for large stones, which can have more than 177 facets.

**Portuguese Diamond**; a white, emerald-cut, fluorescent

diamond of 127.02 cts, probably from South Africa. Bought in 1951 by Harry Winston and presented to the Smithsonian Institution, Washington, D.C., in 1963.

**port-wine red opal;** an informal term used by Australian miners for medium red color opal.

**Poseidon;** a Greek mythological god of the sea and the earthquakes with a trident in his right hand and dolphin under his right foot sometimes showing in a chariot. He is brother of Zeus, Hades and Hera. In Greek lapidary, this figure was engraved of beryl as a protective talisman for seamen or fishermen. Roman counterpart is Neptune.

**Posidona bronni;** a kind of highly bituminous Poseidon shale frequently contains fossil of mollusk Posidona bronni and iron pyrite.

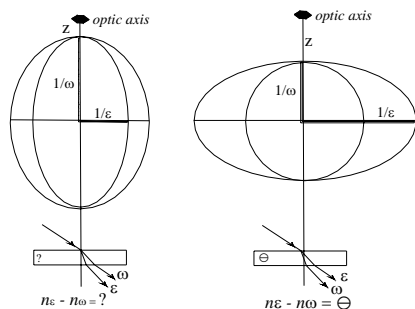
**posepnyte;** a light-green to reddish-brown fossil resin from Lake County California, USA. SG:0.85-0.985. Sometimes used as an amber imitation. Also spelled pošepnyte.

**pošepnyte;** same as posepnyte.

**position of inclusions;** to cut a gemstone it must be located the position of inclusions because these determine the value of the stone and the decision of cut form depends on inclusions.

**positive column;** a luminous plasma glow region in gas discharge, near to positive electrode, which appears between the Faraday dark space and the anode (cold-cathode tube). An illustration under gas-discharge tube. → Negative glow, Faraday dark space.

**positive double refraction;** in crystal optics a birefringent mineral, in which the refractive index of the extraordinary ray is greater than the refractive index



left: section of the ray-surface of a positive and right a negative uniaxial crystal

of ordinary ray. Also called positive mineral or positive stone. A crystal is optically positive, when  $\omega$  is greater than  $\epsilon$  in uniaxial crystal. In biaxial, when intermediate refractive index  $\beta$  is near to  $\alpha$  than  $\gamma$ . Abbreviation:  $\oplus$ . → Optical positive, optical sign.

**positive lens;** same as eyepiece Ramsden.

**positive material;** same as paramagnetic material.

**positive mineral;** → positive double refraction.

**positive stone;** → positive double refraction.

**positron;** the positive electron and of the same mass as negative electron, produced during several decay processes of radio-isotopes, and in pair production by X-rays of energy greater than 1 MeV. Also called positive electron.

**post-contemporary inclusions;** → inclusion.

**postcrystalline;** any reactions or events occurring after crystallization of the bulk of the magma, usually including the hydrothermal stage.

**post-formed;** → inclusions.

**post-formed inclusions;** → inclusions.

**post stone;** a term used in England for fine-grained sandstone.

**post stone;** a term used in England for fine-grained limestone.

**post-temporary;** → inclusions.

**pot;** a term used in Australian for rich find of opal.

**Potaro River;** one of the locations of alluvial diamond deposits found in rivers or streams, in British Guyana.

**potash;** a term used for potassium carbonate  $K_2CO_3$ . Also called potassium carbonate, pearl ash, salt of tartar.

**potash;** a term used frequently for potassium oxide  $K_2O$ , potassium hydroxide KOH and loosely for potassium such potassium spar.

**potash;** a nonrecommended synonym for potassium.

**potash;** a nonrecommended synonym for potassium oxide  $K_2O$ .

**potash;** a nonrecommended synonym for potassium hydroxide KOH. Also called caustic potash.

**potash alum;** a term used for a mineral of the alum group with chemical formel  $KAl(SO_4)_2 \cdot 11H_2O$ .

**potash feldspar;** same as potassium feldspar.

**potash glass;** a type of common glass composed of silica, limestone and potash, used as inexpensive imitation gems.

**potash mica;** a misleading term for muscovite.

**potassium;** a soft, silvery white, very reactive metallic element of the alkali group of the Periodic System with the symbol K. Also called potash.

Br-	K+	Br-	K+	Br-	Br-	K+	□	⊙	K+	
K+	Br-	K+	Br-	K+	K+	Br-	K+	Br-	K+	
Br-	K+	Br-	K+	Br-	Br-	K+	Br-	K+		
K+	Br-	K+	Br-	K+	K+	□	⊙	K+	Br-	K+

#### potassium in color center

**potassium; in color centers;** potassium color centers due to absorption of light produce a colored appearance

in transparent crystals and salts. Such color centers in natural purple rock salt shows color due to impurities. Defects in crystal are responsible for color centers. When the trapped electron in a crystal lattice is released the crystal become bleaching again. Colorless niobium doped with potassium tantalate used as a diamond simulant.

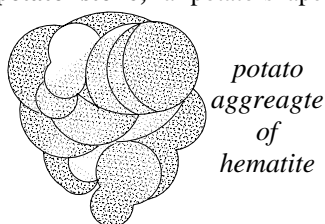
**potassium feldspar**; an alkali feldspar composition of  $KAlSi_3O_8$  (Or), occurring in two crystalline forms; monoclinic such as orthoclase and triclinic such as microcline, includes sanidine and adularia. Also called potash feldspar.

**potassium oxide**; a synonym for potash  $K_2O$ .

**potassium sodium tartrate**; same as Rochelle salt.

**potassium tantalate, niobium doped**; → K.T.N.

**potato stone**; a potato-shaped or rounded geode or hollow cavity, usually of quartz or limestone, lined with crystals, which resemble a potato in shape. They are formed by circulating waters.



Found in Mexico.

**potch-box trade**; buying of potch-and-color opal with low grade for sale overseas.

**Potchefstroom**; location of small alluvial diamond mine in Transvaal Province, South Africa.

**potch**; → schneide.

**potch-and-color**; → potch with color.

**potch lines**; a term used by Australian miners for lines or curtains between units of color in the surface of an opal or potch. → Matrix opal.

**potch color**; potch opal with flat color such as white, blue, amber, etc., unlike color of precious opal.

**potch opal**; → potch (poor opal).

**potch (poor opal)**; a miners term used in Australian for opaliferous material of inferior quality, may be colorful, but lacks the fine play-of-color associated with the precious opal. Usually mined along with gem quality at all fields.

**potch-with-color**; potch with a slight color of opal. Also called potch-and-color.

**Potemkin Diamond**; same as Eugénie Diamond.

**potentially flawless**; diamond that be repolished or recut to remove small surface flaws or minute inclusions to achieve an internally flawless (IF) or a flawless (F) grade. → Recutting, repolishing.

**pothole**; a quasi circular bowl-shaped or hollow worn into the bed of a stream by the churning action of water together with stone or coarse materials that whirled around and abrade the rock. Heavy placers such as

diamonds and gold tend to remain and concentrate in potholes. Very valuable gold, opal and diamond-bearing deposits.

**pothole**; a term used by Australian miners for a quasi circular bowl-shaped or shallow holes sunk into the bed of a stream of opal dirt to establish the existence of opal shaft, before pegging out.

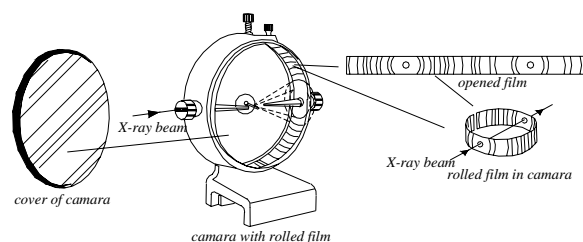
**potholer**; a term used by Australian for some who digs potholes.

**potstone**; a dark-green or dark-brown impure talcose rock or soapstone.

**pounamu**; Maoris term for nephrite or axe stone from New Zealand, which is also named as New Zealand greenstone, Maori stone, Maori jade, Maori greenstone, axestone. Varieties are: kahurangi, kawakawa, and inanga. Also spelled punamu. → Kaho Raukaraka.

**powder, diamond**; → diamond powder

**powder diffraction by X-ray analysis**; very fine powder used in X-ray technique to transmit the X-ray beam through powder sample for producing a



powder X-ray

photograph or pattern other than Lauegram, while Lauegram gives information of crystal symmetry. → X-ray powder diffraction. Also called powder X-ray diffraction, powder photograph.

**powder gold**; same as float gold.

**powdered gold**; same as float gold.

**powdered emery**; powdered dark colored alumina  $Al_2O_3$ , used as grinding and polishing material.

**powder X-ray diffraction**; a synonym for powder diffraction by X-ray analysis.

**powellite**; isostructural with scheelite and stolzite. Cut as a gemstone and prized by collectors.

System: tetragonal.

Formula:  $4[Ca(Mo,W)O_4]$ .

Luster: adamantine, vitreous to slightly greasy.

Colors: colorless, straw-yellow, brown, gray, blue, blackish, brownish-gray.

Streak: pale yellowish, greenish.

Diaphaneity: transparent to translucent.

Cleavage: poor.

Fracture: uneven. Brittle.

SG: 4.23-4.39.

H:3½-4.

Optics;  $\omega$ :1.967-1.974,  $\epsilon$ :1.978-1.985.

Birefringence: 0.011.

Dispersion: 0.058. ⊕.

Found in Utah, Arizona, California, Michigan, and New Mexico (USA), Morocco, Turkey, and Russia.

**powellite luminescence;** under LWUV and SWUV rays yellowish-white-golden fluorescence.

**powellite pleochroism;** blue, green or yellow, pale yellow pleochroism.

**powellite, synthetic;** → synthetic powellite.

**ppm;** an acronym for parts per million, it means one million parts are equal to 100%. A unit for mineral content of a volume. Also spelled p.p.m., P.P.M.

**Pr;** a chemical symbol for the element praseodymium.

**practical fine cut;** same as Eppler brilliant cut.

**practos;** → exposure meters (photography).

**prase;** a massive, translucent, dull leek-green to yellow-green variety of chalcedony color caused by fibrous hornblende or spread chlorite, the stone is more translucent than plasma. Frequently called green agate.

**prase;** crystalline quartz containing swarm of green hair-like fibers amphibole actinolite, which is responsible for green color. Also called mother-of-emerald. Sometimes spelled prasius.

**prase malachite;** a grayish chalcedony filled with malachite sprinklings from Arizona, USA.

**praseodymium;** a pale yellowish metallic element of the rare earth group of the Periodic System with the symbol Pr.

**praseolite;** a green variety of alteration product of iolite.

**prase opal;** synonym of prasopal.

**prasine domiciane;** a misleading term were used for emerald or improved emerald due to dyeing. Also called prasine neomane.

**prasine neomane;** same as prasine domiciane.

**prasinite;** a variety of green schist containing hornblende, chlorite and epidote in nearly equal proportions.

**prasio;** Spanish spelling for prase.

**prasiolite;** a commercial term for Brazilian amethyst converted to pale medium green color by heat-treatment. Also called green amethyst.

**prasiolite;** a trade term for quartz, which changes to green by irradiation due to divalent ferrous iron impurity. Faceted as gems. → Amethyst.

**prasius;** same as prase.

**prasius;** another misleading term for a variety of prase or green jasper, which is known as mother-of-emerald, because they think prasius is the house of emerald. Prase is often embedded in jasper.

**prasoid;** resembling prase.

**praseolite;** a trade term used for transparent, green variety of alteration product of some Brazil amethyst due to heat treating because of containing ferrous and ferric iron. Also called greened amethyst.

**prasopal;** a translucent, leek-green, non-iridescent variety of common opal, green color caused by nickel and chromium. Found in Poland. Also spelled prase opal and called chrysopal.

**pratima culler;** same as image stone.

**praxini;** an old Italian term were used for emerald.

**prayer beads;** imported orange to orange-brown, semi-translucent thermosetting or thermoplastic beads from Afghanistan or Middle East which is named as Afghanistan amber or Egyptian amber. Used as rosary beads by Buddhists, Moslems and etc.

**prayer beads;** same as Afghanistan amber.

**Precambrian;** the era of geological time, and its corresponding rocks, which preceded Cambrian age, being the oldest from the origin of the Earth 4.5-5 billion years to about 750 million years ago. Also called Precambrian Age.

**Precambrian Age;** same as Precambrian.

**precious;** finest variety of mineral or gem such as precious ruby, precious jade, precious garnet, etc. → Precious stone.

**precious garnet;** → almandine

**precious cat's-eye;** same as chrysoberyl cat's-eye.

**precious coral;** a reddish, rose-red color variety of coral. Also called noble coral, corallium nobile, corallium rubrum.

**precious garnet;** a term applied to almandine garnet with purplish color and brilliant.

**precious garnet;** pyrope with reddish color and brilliant.

**precious jade;** a true jadeite or nephrite that is wholly deep green.

**precious metals;** relatively rare and highly valuable jewelry metals such as gold, silver, and the platinum group. → Noble metal.

**precious moonstone;** gem quality adularia or moonstone.

**precious olivine;** gem quality peridot.

**precious opal;** opals can be divided into two principal varieties one of them is precious opal with brilliant iridescent of color caused by play of spectral colors, when reflected light observed on the surface of stone, or when it is turned. The second iridescence varieties of opal are fire opal, flash opal, pinfire opal, peacock opal, rolling flash opal, gold fire opal, blue opal, harlequin opal, lechosos opal, white opal, black opal, water opal, pinpoint opal, hyalite, iron opal. → Noble opal, opal, common opal, opal gem.

**precious opal;** a term applied in Australian. Precious opals can be divided into two principal varieties: white



opal, which is translucent, and milky and black opal in which the stone is almost opaque, gray or black. → Noble opal, opal, common opal.

**precious scapolite;** scapolite of gem quality.

**precious schorl;** gem quality tourmaline.

**precious serpentine;** a translucent, massive, honey-yellow, pale or dark oil-green variety of serpentine.

**precious stones;** a term with little effect, meaning that in the past, it was confined to a gemstone of a small group, owing to its hardness, beauty, durability and rarity such as diamond, emerald, ruby, sapphire, chrysoberyl, perhaps black opal and pearl (pearl is not a mineral). All other gemstones such as peridot, topaz, zircon, tourmaline, etc. were arbitrarily classed as semiprecious stones. The term semiprecious is now discouraged. Also called noble stone.

**precious stones;** sometimes strictly used as prefix to indicate a variety of stone such as precious jade. → Precious.

**precious stones;** occasionally used as a prefix but as a misleading term to indicate it from another variety of stone, which look like it, for example *precious topaz* is a citrine.

**precious topaz;** a genuine topaz of gem quality.

**precious topaz;** a misleading term for topaz colored citrine.

**precious topaz;** an erroneously term for yellow brown color of sapphire.

**precious tourmaline;** a term applied to transparent in nearly all distinguish color hues and lustrous.

**precipitate;** to separate a solid formed substance from a solution or gas using a chemical reaction.

**precipitation;** the formation of a precipitate. From magma to the formation of igneous rocks.

**predominating crystal form;** occurring of one form of a crystal is more important than other forms.

**pre-existing inclusions;** → inclusion.

**preferential absorption;** selective absorption of white light, when it passes through stone, some colors are strongly absorbed.

**preferential growth;** selective oriented growth of mineral of planar or linear fabric elements due to temperature and pressure during the growing of natural or synthetic mineral may cause electric field differences, which are responsible for preferential growth.

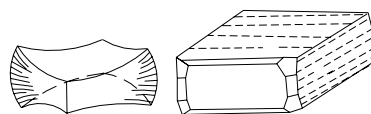
**preforming;** preliminary shaping of a gem substance for lapidary faceting.

**p-region;** same as p-type silicon.

**prehnite;** a phyllosilicate mineral, the crystals are pyroelectric. Shades of green color cut into cabochon or as carving objects, prized by collectors. Its color resembling jade. Having a botryoidal or mammillary or

## precious scapolite – Premier diamond

radiating aggregate. Some species are chatoyant, when cut cabochon.



*prehnite crystals*

Prehnite from South Africa has been erroneously called *cape emerald*.

*Patricianite* is a

trade term for a pink and green mixer of prehnite and chlorite frequently included with copper, occurs in Lake Superior districts. Synonym: chiltonite, jacksonite.

System: orthorhombic.

Formula:  $2[\text{Ca}_2\text{Al}(\text{OH})_2(\text{AlSi}_3\text{O}_{10})+\text{Fe}]$ .

Luster: vitreous to pearly.

Colors: colorless, pale yellowish to yellowish green, gray, shades of brown, green and pinkish.

Streak: white.

Diaphaneity: transparent to translucent.

Cleavage: {001} distinct.

Fracture: conchoidal to uneven. Brittle.

SG: 2.90-2.95.

H: 6-6½.

Optics;  $\alpha$ : 1.611-1.632,  $\beta$ : 1.615-1.642,  $\gamma$ : 1.632-1.665.

Birefringence: 0.021-0.033. ⊕.

Found in Australia, Italy, Russia, the Czech Republic, France, South Africa, Quebec (Canada), Austria, China, California, Colorado, and Massachusetts, USA.

**prehnite cut;** usually cut cabochon exhibit a cat's-eye effect, yellowish to greenish color from Australia has been frequently faceted.

**prehnite-jade;** a mislabeled term for compact prehnite.

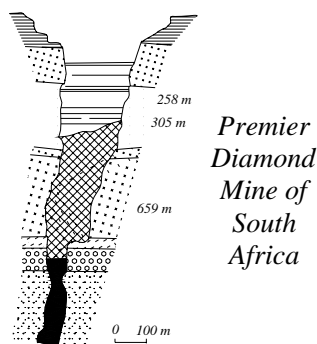
**prehnite luminescence;** faint brownish-yellow under SWUV and under X-rays.

**premier;** same as premier diamond.

**Premier Diamond;** an emerald-cut diamond of 86.40 cts, sold to Harry Winston in 1957. He mounted it in a pendant-clip with several other diamonds. Sold in Geneva in 1958.

**premier diamond;** a color grading of diamond that has more or less cloudy or oily appearance with a bluish tone, in artificial light its color is altered to a yellow. Found at Premier Mine in Kimberly, South Africa. Also called premier.

**Premier diamond Mine, Kimberly;** location of large diamond mine 40 kilometers east of Pretoria, South Africa. It was discovered in 1903, closed in 1932 and reopened in 1947. The mine is the source of the largest diamond of the world, the Cullinan Diamond of 3.106 cts, and rare Type IIa diamonds. Other famous diamonds from this mine are Centenary Diamond,



Premier Rose Diamond.

**Premier Mine, Transvaal;** a subsidiary mine of Premier Mine, Kimberly, South Africa.

**Premier Rose Diamond;** a blue-white, flawless, pear-shaped diamond with 189 facets; 56 main facets and 133 facets on the girdle of 137.02 cts, one of three cut diamonds from a 353.90 ct rough stone. It was found at the Premier Mine, Kimberly, South Africa in 1977. Named after Rose Mouw who planned the cutting and marked it for sawing. Also known as Big Rose Diamond. The other two are named as Little Rose Pear-Shaped Diamond of 31.48 cts, and a circular brilliant known as Baby Rose of 2.11 cts. Sold in 1979.

**premium;** a term used in trade for polished diamonds or other gemstones when paid over and above an accepted list price.

**premixed flame;** a term used for a clean long luminous blue flame, where air or oxygen is mixed with the oil or petroleum so that soot is not occurred.

**preparation of dopstick;** for gem holding or dopstick, the holder will inserting in a heated wax and pressed against a glass plate after that the stone placed on the top of warm wax of dopstick. → Doping stick of stones.

**preparation of graft tissue for cultured pearl;** → graft tissue (cultured pearls)

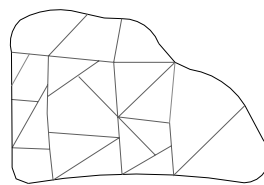
**preparation of nuclei for cultured pearl;** → nucleus preparation of cultured pearls.

**preservation of opals;** → opal preservation.

**preservation of pearls;** → pearl-care and preservation of.

**Presidente Dutra Diamond;** a diamond of 409 cts, found in 1949 in Douradinho Rive, Coromandel district, Minas Gerais, Brazil. 36 fashioned diamonds were cut totaling 136 cts. Also called Dutra Diamond.

**Presidente Vargas Diamond;** a rough diamond of 726.60 cts, found in 1938 on the Sant Antonio River, Coromandel district, Minas Gerais, Brazil. Named after Brazilian President Getúlio Dornelles Vargas. It was pure water except for yellowish tinges on 2 edges. After changing several hands it was sold to Harry Winston



*Presidente Vargas Diamond in rough. Marked for cleaving and sawing*

and cut into 29 stones, the largest 48.26 cts, emerald-cut, which was named as Presidente Vargas Diamond or

Vargas Diamond. It was recut into 44.17 cts, and was sold in 1961. Present owners are unknown.

**pressed amber;** → ambroid.

**pressed cameo;** cameo produced by pressure. Similar molded cameo.

**pressed copal;** made by heating and compressing small fragments of genuine copal and other resins together at a high temperature

**pressed glass;** cheapest sort of glass articles produced by pressure between a mold and a plunger. Used for imitation of gemstone.

**pressed turquoise;** a misleading term for imitation turquoise or Vienna turquoise, which is made by pressing aluminum phosphate powder dyed with copper oleate.

**pressure cooker;** a device similar to autoclave used to clarified the porous amber by which drive oil in the pockets of stone to exude the air, after that the stone is placed in an electric oven with gradual increasing temperature to soften it, during the treatment the air bubbles within the amber left by producing discoidal fractures and oxidation of amber which become generally darker color.

**pretesting;** → prescreening method, irradiation.

**Pretoria Diamond;** same as Niarchos Diamond.

**pretreating;** → prescreening method, irradiation.

**prian;** soft and white clay.

**price-calculation of gemstones and natural pearls;** → base price of pearl.

**prickly helmet;** → galeodea.

**Priday plume agate;** fine-quality plume agate from Priday Ranch, Oregon, USA.

**Priday Ranch nodules;** nodules or thunder-eggs from Priday Ranch, Oregon, USA.

**Pride of Australia Opal;** a precious black opal of 225.75 cts, with green play-of-color and lesser amounts of orange found in 1915 in the Lightning Ridge, New South Wales, Australia. Present owner unknown. Also called Red Emperor.

**primary;** an obsolete term for rocks of the Precambrian, Palaeozoic era.

**primary;** old rock minerals developed at the time of its formation, not introduced or formed by alteration or metamorphism.

**primary colors;** the three elementary pigments or colors such as red, yellow, blue, which can be combined in various proportions to obtain any other colors and shades.

**primary colors of rocks;** → primary color.

**primary colors of stones;** → primary color.

**primary deposit;** a deposit of minerals or gemstones formed directly from a cooling magma, as distinguished from secondary deposits, such as diamond when found in a pipe it is a primary and if obtained from gravels it is a secondary deposit.

**primary gamma ray;** natural gamma ray.

**primary gold;** gold obtained from primary deposit.

**primary mineral;** a mineral formed directly at the same time as the rock, in which it is found, as distinguished from secondary minerals.

**primary ore;** ore obtained from primary mine.

**prime d'émeraude;** French term for prime of emerald.

**prime of emerald;** a misleading term for fluorite, prase or other green stone like emerald. Also spelled prisme d'émeraude or prime d'émeraude. → Mother-of-emerald, prasius.

**Primer Instituto Gemologico Latin Americano;** Headquarters for this society are located at: Sourdeaux 1312, Bell Vista, F.C.S.M., Buenos Aires, Argentina.

**primitive limestone;** same as granular limestone.

**primitive unit cell;** same as unit cell.

**Prince Edward of York Diamond;** a pear-shaped, fine diamond of 60.25 cts, from Africa, probably found in the end of 1800. Sold in New York, USA in 1901. Its exact ultimate disposition unknown.

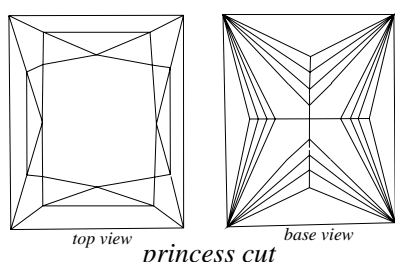
**Prince Harlequin Opal;** → Harlequin,-Prince Opal.

**princess blue;** same as blue stone or sodalite.

**princess cut;** an earlier and original name for profile cut.

**princess cut;** a 144-faceted square or truncated carrée brilliant cut. → Royal 144 cut.

**princess cut;** a 57-faceted square or truncated carrée



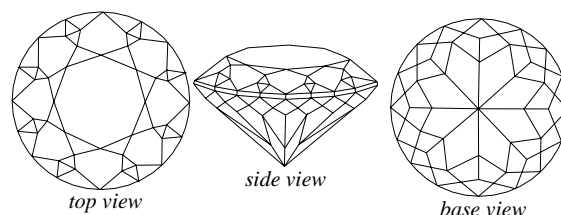
brilliant cut, which has 21 facets on the crown, 32 facets on the pavilion and 4 facets on the girdle.

**princess length;** a pearl necklace about 45 centimeters (18 inches) in length.

**Princess Mathilde Diamond;** a hexagonal-cut diamond of 16.25 cts. Belonged to Princess Mathilde, cousin of

Napoleon III. It was sold to Sultan Abdul-Hamid II of Turkey. Last sold in Paris in 1933.

**Princess Scintilla Cut;** a modern style of cutting diamond with usually 48 facets and an eight-side table



in the crown, 56 facets on pavilion without culet and 16 facets on the girdle, totally 121 facets. → Royal cut.

**Prince's metal;** → tombac.

**Princie Diamond;** a pink, cushion-cut diamond of 34.64 cts, sold in 1960 by Sotheby's to Van Cleef & Arpels in London. Named after Princie son of Baroda, India.

**principal axis;** in tetragonal and hexagonal systems the vertical axis or *c* axis, the remaining axes known as laterals. In Orthorhombic, and triclinic systems it is usually the *c* axis. In monoclinic system it may be the *b* axis.

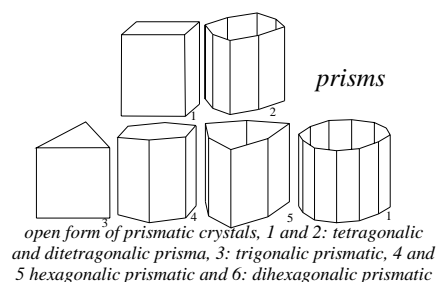
**principal axis;** in optics a line, which passes through a lens surface of maximum sensitivity.

**principle of Archimedes;** same as Archimedes principle.

**prinz cut;** a style of cutting stone of small, fashioned 5-faceted octahedron.

**prism;** in optics a triangular prism made of material transparent to light used to bend or disperse light rays. In a microscope right-angled prisms are used to bend and invert the inverted image produced by the objective. Equilateral prism type of spectroscope will split the light into its spectral colors so that those parts of the spectral colors will be absorbed by a gem sample which produces obvious bands or lines of dark color.

**prism;** in crystallography an open form of three, four,

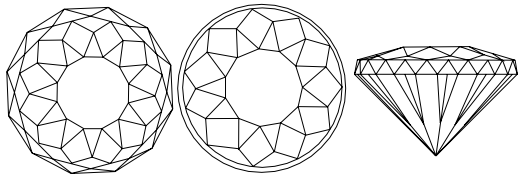


six, eight, or twelve faces parallel to a single axis open at the two ends of the axis, which is parallel to the

faces. The sides form parallelograms.

**prism;** in geology an alluvial fan.

**prismante cut;** a modified brilliant cut, which resembles the whirligig toys of children with prismatic pavilion



*prismatic cut (prismant) or whirligig cut*

without culet. It has 33-36 facets and a tablet in the crown, 22-24 facets on the girdle and 33-36 triangular facets on pavilion.

**prismatic;** a crystal habit consisting of side forming parallelogram. Pertaining to or composed of a crystallographic prism such as hexagonal prism.

**prismatic;** a sedimentary prism or an alluvial fan.

**prismatic;** resembling the spectrum colors formed by refraction in a prism.

**prismatic blue malachite;** a misleading term for azurite.

**prismatic cleavage:** crystal cleavage that is parallel to the faces of a prism or principal axis.

**prismatic emerald;** a misleading term for green euclase.

**prismatic emerald malachite;** a misleading term for green euchroite.

**prismatic glass;** glass that has been pressed to produce a prism.

**prismatic habit;** → prismatic.

**prismatic layer;** the *second layer* or *middle layer* lying between the periostracum and the nacreous layer of a pearl or mother-of-pearl of a bivalve mollusk, composed of polygonal small prism crystals of aragonite or calcite (calcium carbonate) arranged at right angles to their prismatic axes perpendicular to the surface of the layer and are held together by a cement of conchiolin or *mortar*. → Periostracum, pearl.

**prismatic layer of pearl shell;** → prismatic layer.

**prismatic moonstone;** a misleading term for clouded chalcedony.

**prismatic quartz;** a misleading term for iolite variety of cordierite.

**prismatic spectroscopy;** → spectroscopy.

**prismatic spectrum;** → prism.

**prismatic system;** an old term for orthorhombic system.

**prismatine;** an unnecessary term for kornerupine from Waldheim, Saxony, Germany.

**prisme d'émeraude;** French term for prime of emerald.

**prism faces of crystals;** → prismatic, prism.

**prism form;** → prismatic, prism.

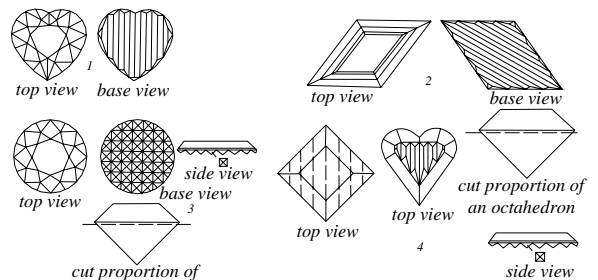
**prism, polarizing;** → microscope.

**pristine color;** pure color, uncorrupted color.

**profilated bubbles;** a form of typical inclusion in synthetic spinel of Verneuil process, which occurs as twisted or turned shapes of gas bubbles.

**profile;** the outline of a stone viewed from one side or lateral.

**profile cut;** a style of cutting diamond or other gemstones, planned for the economical use of flat stones to provide a large table area and good total internal reflection. After flat slices of diamond are sawn



*four kind profil cuts, formerly princess cuts*

into any of desired shapes, than the top is polished and a series of narrow, parallel V-shaped grooves are placed on the bottom. The girdle outline take various shapes depended upon the shape of the desired slice. It is described as lively, but it lacks fire. Previously was known as the princess cut. The cut style was invented by Arpad Nagy a London cutter in 1961.

**profilometer;** an optical determinative device used to measure the proportion of polished diamond such as depth and the angles by the use of a spotlight, which allow reflection from the diamond facets onto a screen to show the symmetry of cutting purposes. Made by GIA, USA

**Progress Diamond;** a diamond of 80.66 cts, in rough from Mir Pipe, Sakha, Russia. Now on display in the Russian Diamond Fund in Moscow.

**promethium;** a chemical element of the lanthanide rare earth group of the Periodic System with the symbol Pm.

**prong;** one of several curved, sharp pointed, finger-like narrow metal

support of 4 or 6 claws used to fasten and hold a gemstone in place.



Also called claw.

*prongs*

→ Head.

**prong setting;** a group of claws or prongs which hold a gemstone usually with 4 or 6 prongs.

**propagation of light;** → wave motion, wave theory of

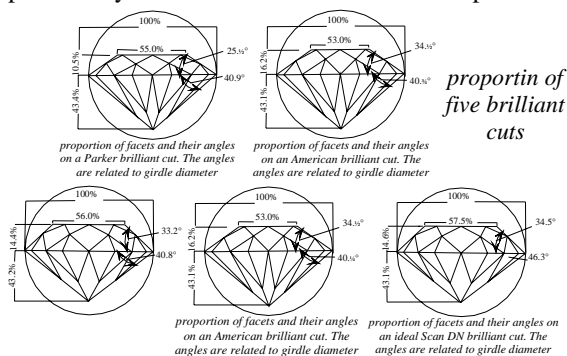
light.

**proper proportion;** → proportion.

**properties;** characteristic optical properties included crystallography, and physical properties of gemstones are: color, luster, hardness, tenacity, specific gravity, optical condition, cleavage, fracture, and conductivity. Physical properties and chemical composition of minerals change with temperature and pressure. → Optical properties.

**properties of diamond;** → properties

**proportion;** a grading term used for polished diamonds and transparent gemstones, the proportions are based on the relative dimensions and angles of a fashioned stone, particularly diamond and the relationship between



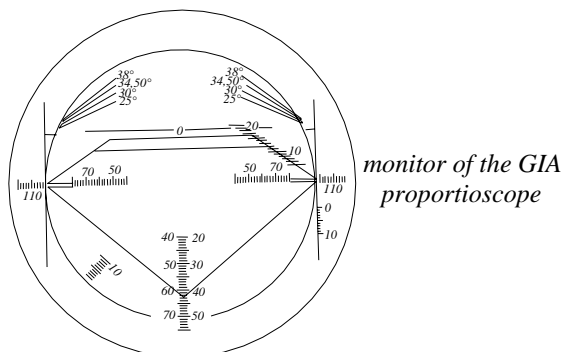
them. To determine proportion the following values are measured: table diameter, crown and pavilion heights, crown and pavilion facet angles, total height, girdle diameter, girdle outline, girdle thickness, percentage of the girdle, and culet size. → Finish.

**proportion grading;** same as cut grading.

**proportion grading;** same as diamond proportion grading.

**proportion of brilliant cut;** → diamond.

**Proportionscope;** a commercial term for an optical comparator for rapid checking of the proportion of a



brilliant-cut diamond. Designed by Gemological Institute of America for brilliant-cut stone weighing 0.18 to 8 cts, by projecting a magnified silhouette of the stone onto a calibrated screen. The stone is held in a jig

that is easily moved by means of a zoom. The projection of the stone cut on the screen corresponds to the ideal proportions of the earlier Tolkowsky figures. It is provided with vertical, horizontal, and diagonal scales, so that proportions of the values can be read.

**prosopite;** a mineral similar to turquoise used as an imitation. Prized by collectors.

System: monoclinic.

Formula:  $4[\text{CaAl}_2(\text{F},\text{OH})_8]$ .

Luster: vitreous.

Colors: colorless, grayish-white, blue.

Streak: colorless.

Diaphaneity: translucent to opaque.

Cleavage: perfect.

Fracture: conchoidal.

SG: 2.88-2.89.

H: 4½.

Optics:  $\alpha$ : 1.501,  $\beta$ : 1.503,  $\gamma$ : 1.510.

Birefringence: 0.009. ⊕.

Found in Mexico, Tasmania (Australia), Utah, and Colorado (USA).

**prospecting;** the process of searching for by some investigative technique for minerals or ore deposits of economic importance. Techniques for searching include aerial survey, geophysical and geochemical tests, pitting, magnetometry, electroresistivity measurement, trenching and drilling.

**prospecting opal;** the process of searching for opal.

**prospector;** a person who engaged in prospecting for important mineral deposits.

**prostitute;** → pyralspite, rhodolite.

**protactinium;** a hard, white, radioactive chemical metallic element of the Periodic System with the symbol Pa.

**protection of pearls;** → pearl,-care of.

**protein plastic;** an artificial amorphous substance made from the albumen of milk by treating milk with acid and the addition of formaldehyde, which converts it into a hard plastic. Used for thermoplastic materials occasionally as small beads and ornamental stones. RI: 1.55. SG: 1.32-1.39.

**Proterozoic;** the later part of two Precambrian system or eras, characterized by unmetamorphosed sedimentary rocks. Synonym for Algonkian.

**protogenetic;** → inclusion,-protogenetic.

**protogenetic inclusion;** → inclusion,-protogenetic.

**protons;** a stable elementary particle with a single positive electrical charge that forms the nucleus of the hydrogen atom and constituent of all nuclei. It have a mass of  $1.67239 \times 10^{-24}$  grams, approximately 1836.12 times than of the electron, and a positive charge of approximately  $1.602 \times 10^{-19}$  Coulombs. In cyclotron used to change the color of diamonds. → Irradiated

diamond, treated diamond.

**proustite**; an isomorphous mineral with pyrargyrite. Cut as gems and prized by collectors. Darkens on exposure to light. Also called light ruby silver, light red silver ore, ruby silver.

System: trigonal (hexagonal).

Formula:  $2[\text{Ag}_3\text{AsS}_3]$ .

Luster: adamantine to semimetallic.

Colors: scarlet-vermilion, light red, dark red.

Streak: bright-red, vermilion.

Diaphaneity: translucent, some specimens transparent.

Cleavage: {1011} distincts.

Fracture: conchoidal to uneven. Brittle.

SG: 5.57-5.62.

H: 2-2½.

Optics:  $\omega$ : 3.088,  $\epsilon$ : 2.792.

Birefringence: 0.296.  $\ominus$ .

Found in Nevada, Idaho, California, and Colorado (USA), Ontario (Canada), Mexico, Sardinia, Germany, and Chile.

**proustite pleochroism**; intense in shades of red color.

**proustite, synthetic**; → synthetic proustite.

**Providence jewelry**; same as Gablonz jewelry.

**Province of the Cape of Good Hope**; same as Cape Province.

**Provincial Diamond Museum (Belgium)**; a famous Diamond Museum in Antwerp, Belgium.

**proxying**; same as diadochy or substitution, ionic substitution.

**Prussian amber**; succinite variety of amber from Prussia along Baltic coast. In Roman times Prussian tribe was named as Aisti.

**Prussian blue**; a dark blue pigment of ferric ferrocyanide  $\text{Fe}^{\text{III}}_4\text{Fe}^{\text{II}}(\text{CN}_6)_3$ . Used as color agent of some minerals. Also called iron blue, blue iron ferrocyanide, Berlin blue.

**pseudo**; a prefix implies as false in form but not in substance.

**pseudo albite**; an obsolete term, which was synonym for andesine.

**pseudo-amber**; most natural occurring resin or gum remains preserved in a geologic deposits (beside amber), such as flagstaffite, copalin, glassite, and posepynte are used as pseudo-amber. → Amber.

**pseudochrysolite**; a misleading commercial term for cut green moldavite meteorite glass.

**pseudo-cleavage**: same as parting.

**pseudo-copal**: another term for synthetic material used as a copal imitation.

**pseudocrocidolite**; quartz pseudomorphous after crocidolite, known as tiger's eye and hawk's-eye.

**pseudocrystal**; a substance that is solidly compact, appears to be crystalline but it does not give an X-ray

diffraction pattern. → Pseudocrystalline.

**pseudocrystalline**; a substance that is solidly compacted by siliceous or other minerals is strongly resembles a true crystalline rock but it does not give an X-ray diffraction pattern.

**pseudogalena**; another term for sphalerite.

**pseudodiamond**; quartz simulating diamond.

**pseudoemerald**; a term applied to a variety of malachite mineral or green fluorite, and jasper resembling emerald. Also in German is calling pseudosmaragd. Also known as pseudosmaragdus.

**pseudohexagonal**; a crystal form, which simulates the crystal form of hexagonal for example some orthorhombic forms.

**pseudo-interference in synthetic spinel**; → strain knot.

**pseudojade**; any minerals falsely resembling jade for example bowenite, serpentine, californite, etc.

**pseudojadeite**; any minerals falsely resembling jadeite for example jade-albite from Myanmar, (Burma).

**pseudomalachite**; a mineral resembling malachite in color, trimorphous with reichenbachite and ludjibaite. Associated with malachite. Cut as gems and prized by collectors. Also called phosphochalcite, phosphorochalcite.

System: monoclinic.

Formula:  $2[\text{Cu}_5(\text{PO}_4)_2(\text{OH})_4]$ .

Luster: greasy vitreous.

Colors: bright-green, emerald-green to black-green.

Streak: leek-green, dark-green.

Diaphaneity: translucent to opaque.

Cleavage: {010} less distincts.

Fracture: conchoidal to uneven. Brittle.

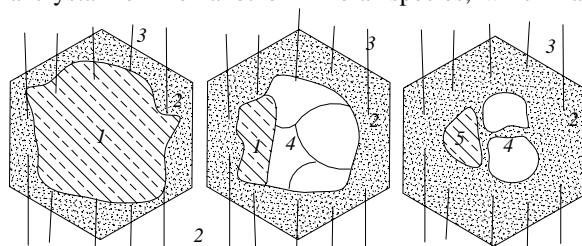
SG: 4.30-4.40.

H: 4½-5.

Optics;  $\beta$ : 1.763.

Found in Russia, Zambia, Germany, Australia, and Pennsylvania (USA).

**pseudomorph**; a mineral that has the external outlook of a crystal form of another mineral species, which has



1=garnet, 2=amphibol after garnet, 3=primary amphibol, 4=plagioclase and 5=zoisite

*pseudomorphism of garnet to amphibol,  
plagioclase and zoisite. After Grigor*

been replaced by chemical substitution, incrustation or alteration process, for example malachite has sometimes crystal has shape of azurite or chalcedony. It

is pseudomorph after wood, which is known as *agatized wood* and cut as or carved as ornamental objects. Also called false form, allomorph. → Perimorph.

**pseudomorphic**; a mineral, which has replaced another crystal and retained the crystal form and size of them, such as agatized wood, or silicified wood. → Perimorph.

**pseudomorphism**; the condition of being a pseudomorph. → Perimorph.

**pseudomorphous**; adjective of pseudomorph.

**pseudomorphous,-encasement**; → encasement pseudomorph.

**pseudophite**; a green, massive serpentine variety of clinochlorite and pennine, which resembles jade. RI:1.57-1.58. Birefringence: 0.003. SG:2.69-2.80. H:2½. Used as ornamental objects and costume jewelry. Found in Switzerland, Italy, and Austria. Misnomerly called Styrian jade. → Miskeyite.

**pseudosmaragd**; a German term for pseudoemerald.

**pseudosmaragdus**; same as pseudoemerald.

**pseudosuccinite**; a variety of amber from Equilleres, Basses-Alpes, France, differing from the Baltic succinite-amber or so-called *true amber* in its reaction to solvents.

**pseudotetragonal**; a crystal form, which simulates the crystal form of tetragonal for example some orthorhombic forms.

**pseudotopaz**; quartz crystal simulating topaz

**psilomelane**; a general name employed to a hard, massive, botryoidal, colloform mixture of several manganese oxide minerals whose mineral composition is not identified. Used as a hematite simulant, which resembles it. Cut as gems. Strong electroconductivity. Found in botryoidal or stalagmitic aggregates. Also called manganomelane, psilomelanite, hard manganese. → Psilomelane chalcedony.

**psilomelane**; romanechite a manganese-oxide mineral, which is a major constituent of psilomelane. → Romanechite.

**psilomelane chalcedony**; chalcedony containing black-banded or minute plumes of psilomelane mineral. It is cut cabochon with brilliant metallic luster. Found in Mexico. Also called crown of silver, and misleadingly black malachite. Used as a hematite simulant.

**psilomelane chalcedony cut**; cut cabochon in various shapes.

**psilomelane chalcedony intaglio**; carving or engraving below the surface of psilomelane chalcedony like hematite mineral.

**psilomelanite**; same as psilomelane.

**Pteria pinquin**; a family of pearl-bearing salt-water bivalve mollusks of Hong Kong, China and Okinawa, Japan.

*pseudomorphic – Pulfrich totalrefractometer*

**Pteriidae**; a family of pearl-bearing of salt-water bivalves mollusks with pearly interiors, found in warm water. → Aviculidae, Malleidae.

**Ptilolite**; same as mordenite.

**ptygma**; a term applied to pegmatitic substance within migmatite or gneiss with disharmonic appearance of folds such as banded tourmaline-oligoclase. Also called ptygmatic fold.

**ptygmatic fold**; → ptygma.

**p-type silicon**; silicon as semiconductor containing partly boron impurities, this regions are positively charged electrons because of the donor boron atoms holes in the valence band because boron atom is an acceptor. Also called p-region.

**Pu**; a chemical symbol for the element plutonium.

**puchche**; a Sinhalese used term for emerald or emerald like stones. Also called param puchche, pudu puchche, puchche marakatam.

**puchche marakatam**; a Sinhalese-Sanskrit term for puchche.

**pudding stone**; another spelling for puddingstone.

**puddingstone**; an old popular term applied mostly in England for conglomerates, consisting of well-rounded, different colored pebbles imbedded in an abundant siliceous sandy matrix, cemented together by secondary mineralization. Also called plum-pudding stone. Also spelled pudding stone.

**pudding stone jade**; pale colored, well-rounded pebble variety of nephrite jade cemented together by a darker green matrix.

**pudding stone jasper**; a misleading term for well-rounded pebbles of quartz cemented together by a siliceous chalcedony. Cut and polished as curio stone. Found in Lake Superior district, and Michigan, USA.

**puddle**; a mechanical washing and stirring pan fill of concentrated diamond mud and water, which helps to float off some of the lighter fraction and the heavier particle is retained for periodic retrieval.

**puddle**; washing and stirring device for separate opal stone from debris.

**puddler**; a machine of washing and stirring pan for separate opal-bearing pieces from gravel. Puddler can be dry.

**puddler**; some who operate the puddle device.

**puddling tank**; large dam at which the miners used for wet puddling.

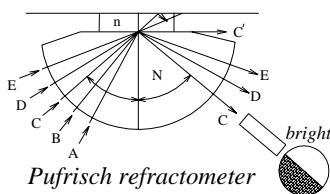
**pudu puchche**; same as puchche.

**Puerto Rico**; location of a diamond-industry in island at the northeastern end of the Caribbean Sea.

**puka shell jewelry**; necklace consists of fragments of sea shells drilled and strung in Hawaii. The puka is a Hawaiian word for hole.

**Pulfrich-totalrefractometer**; an optical device used for

the measurement of the refractive indices of gems and minerals. Made by Abbé and Pulfrich (1840-1905). → Abbé refractometer.



**pull**; an informal term used by Australian miners for reopening of an old abandoned mine, which has been full of debris.

**pull dirt**; an informal term used by Australian miners for pulling the dirt to the surface by facility.

**pulled stone**; → Czochralski technique.

**pulling mate**; an informal term used by Australian miners for one how pulls up the dirt to the surface.

**pulling method of crystal growth**; → Czochralski technique.

**pulling from the melt**; → Czochralski technique.

**pulsator**; → jig.

**pulsator jig**; → jig.

**pulsator (diamond recovery)**; a mechanical shaking machine or pulsator sieve, which separate diamond and other heavy minerals by a quick up-and-down motion of the sieve usually in water. Generally concentrating of minerals or ores according to relative gravity. Also called pulsator jig, or pulsator. → Jig.

**pulverize**; to reduce to or separate particles from each other to very small particles that they resemble powder or dust, this is done by grinding, crushing, or beating.

**pulverized silica**; finely ground quartz.

**pumice**; a light colored, acidic, highly vesicular, glassy volcanic rock or lava similar to rhyolite. Formed during the eruption, when gas-filled lava erupted into the air, it is sharp edged because of the disrupted gas after cooling. The rock is often light enough to float on water. Also called pumicite, pumice stone.

**pumice dust**; a natural volcanic dust or very fine grained ash with a grain size of less than 0.25 mm. suspended in the atmosphere by volcanic explosions. The material is similar to pumice powder and used as a polishing abrasive material. Also called volcanic dust, volcanic ash.

**pumice powder**; pulverizing of pumice rock to produce a polishing and abrasive material, while the rock is sharp edged because of the disrupted gas.

**pumicite**; same as pumice.

**pumice stone**; same as pumice.

**pumpellyite**; major component of chlorastrolite. Cut as cabochon, it exhibits chatoyancy. Also called chlorastrolite (fine-quality), ferropumpellyite (contain ferro iron), julgoldite (contain ferro iron), zonochlorite (dark green), and lotrite. None Spectrum and luminescence.

System: monoclinic.

Formula:  $4[\text{Ca}_2(\text{Mg}, \text{Fe}^{+3}, \text{Fe}^{+2}, \text{Al})_2](\text{OH})_2(\text{Si}_2\text{O}_7)(\text{SiO}_4)$ .

Luster: vitreous to silky.

Colors: greenish-blue, green, brown.

Streak: colorless.

Diaphaneity: translucent.

Cleavage: {100} perfect, and {001} less perfect.

Fracture: uneven. Brittle.

SG: 3.18-3.34.

H: 5½-6.

Optics:  $\alpha$ : 1.674-1.702,  $\beta$ : 1.675-1.715,  $\gamma$ : 1.688-1.722.

Birefringence: 0.027.  $\ominus$  and  $\oplus$ .

Dispersion: moderate.

Found in New Zealand, Russia, Austria, Scotland, Finland, California, Michigan, and Lake Superior, USA.

**pumpellyite cut**; only chlorastrolite cut cabochon, which exhibits chatoyancy effects.

**pumpellyite pleochroism**; pleochroism is distinct: light yellowish-green, pale greenish-yellow and colorless.

**pupil**; the contractile opening in the iris of the eye to determine the amount of entering light. → Eye.

**pumping**; same as exciting.

**punamu**; same as pounamu.

**Punch Jones Diamond**; a greenish-gray diamond of 34.46 cts, found in 1928 on Rich Creek, West Virginia. Found by Grover C. Jones and named after his son P. Punch Jones. Now on display at the Smithsonian Institution, Washington, D.C., USA.

**punch mica**; a term applied to a mica from which different shapes in one inch in diameter can be punched or stamped.

**Punjab**; location for kyanite and sapphire of gem quality from Punjab, India.

**pu pi**; a Chinese term for a disc with a rush motive carved of jade. → Chinese ritual and symbol jades.

**Purana**; a Sanskrit term for an ancient text include tale of India. Purana is concerned with five subjects such as creation of universe, creation after annihilation, descent of god and saints, imposing epochs, and story of Royal's dynasties. An ancient Indian legendary tale sources, the third class of Shasta's (one of the fifth classes). Believed that Tagore translated several unspecified sources from this Hindu literature. Also spelled Puranas.

**purani**; an Indian term for a variety of emerald.

**Puranas**; same as Purana.

**Purbeck marble**; same as paludina limestone (marble).

**pure**; a rarely used alternative term for clean.

**pure**; → bastard cut.

**pure copper**; same as native copper.

**pure gold**; same as fine gold.

**pure melt method of crystal growth**; → Bridgeman-



Stockbarger technique.

**pure silver;** same as native copper. Also called lightened silver, brightened silver.

**purest water;** an old term for transparent diamonds of top-color.

**purity;** same as clarity, clarity grading.

**purity;** color purity is the saturation of a color, or how pure the color is. Intensity of color. → Color,-definition.

**purity grade;** same as clarity, clarity grading.

**purity of diamond;** → clarity, clarity grading.

**purple;** variety of rich dark crimsons or scarlet.

**purple;** any various colors about midway between red and blue.

**purple blende;** same as Kermesite.

**purple copper ore;** same as bornite.

**purple flash;** filled fractures of diamond shows purple interference by testing under dark-field illumination. → Revealing fracture filled diamond.

**purple muscovite;** muscovite with crimson or scarlet color.

**purple diamond;** a fancy color diamond, purple natural bodycolor.

**purple gold;** gold of purple color, is an alloy made with aluminum, it is very brittle and mainly used for jewelry.

**purple of Cassius;** vivid, deep red or purple glass, which containing gold.

**purple-of-the-veins jade;** a Chinese description for fancy colored jade.

**purple ore;** sintered pyritic ore.

**purple sapphire;** a term applied to violet corundum, which is misleadingly named as oriental amethyst or Bangal amethyst.

**purplish red;** a color nomenclature.

**purpurine;** same as haematinon glass.

**purpurine glass;** same as haematinon glass.

**purpurite;** a mineral of heterosite group, which is isomorphous with them. Used as ornamental objects.

System: orthorhombic.

Formula:  $[\text{Mn}^{+3}, \text{Fe}^{+3}](\text{PO}_4)_2$ .

Luster: satiny.

Colors: reddish-purple, deep rose, brown, black.

Streak: reddish-purple.

Diaphaneity: translucent.

Cleavage: {100} good, and {010} imperfect.

Fracture: uneven. Brittle.

SG: 3.40-3.70.

H:4-4½.

Optics:  $\alpha$ :1.850,  $\beta$ :1.860,  $\gamma$ :1.920.

Birefringence: 0.070. ⊕.

Dispersion: very strong.

Found in California, Dakota, and Carolina (USA), Namibia, Western Australia, France.

**purpurite pleochroism;** gray, rose-red, purplish pleochroism.

**Puruni River;** location of diamond-bearing deposits in Guyana, South America.

**pusparaga;** an Indian term of not identified meaning, may be the orange color of sapphire which is known as padparadschah.

**Putfontein;** location of small alluvial diamond deposit in the Lichtenburg Area, Transvaal Province, South Africa.

**putong yu;** a Chinese term for green common nephrite used as jade.

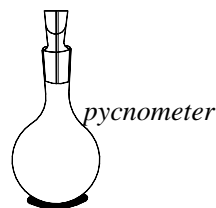
**putti;** a gold-washing pan used in Madras, India. Also spelled putty.

**putty;** same as putti.

**putty powder;** a soft, creamy-white compound of tin oxide of 85-90% mixed with lead oxide (15-10%), used as an abrasive and polishing powder for producing fine luster of all faceted colored stones and ivory, but not diamond. Also known as stannic dioxide and tin dioxide.

**pycnite;** a massive columnar, light pink variety of topaz containing traces of cobalt, occurring in massive columnar aggregation, found in Greenland and Saxony, Germany. Frequently used as gems.

**pycnometer;** a small glass bottle of accurately defined volume used for determining the relative specific gravity of small mineral or gem specimens and liquid. Also called



specific gravity bottle, density bottle and spelled pycnometer.

**pycnometer;** same as pycnometer.

**Pykclip;** location of alluvial diamond deposit in the Lichtenburg Area, Transvaal Province, South Africa.

**pyralin;** a commercial term for celluloid.

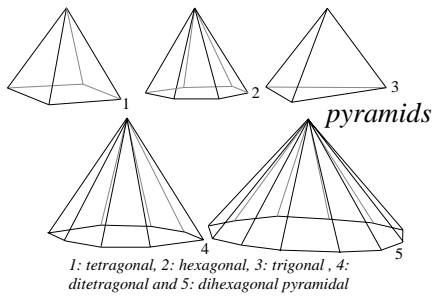
**pyralmandite;** a variety of isomorphous intermediate group of pyrope and almandine garnet. Also called pyrope-almandine.

**pyralspite;** a contraction of isomorphous intermediate group of pyrope, almandine, and spessartine garnet in blood-red to pink-red color. Refractive index ranges from 1.55 to 1.78. SG:3.80-3.95. Rhodolite is an intermediate pyralspite with violet-red color found in Zimbabwe, South Africa and USA. Another intermediate pyralspite is *malaya* or *reject*, which means *prostitute* (out of the family). → Ugrandite garnet.

**pyralspite garnet series;** → pyralspite.

**pyramid;** an open crystal form consisting of three, four,

six, eight, or twelve nonparallel triangular faces that



meet at a point, which result in the plane commonly intersecting three crystallographic axes.

**pyramid cut;** an old style of cutting diamond, cut from natural cleavage of octahedron-shaped diamond with a square pyramid.

**pyramid faces of crystals;** → pyramid.

**pyramid pebble;** same as dreikanter.

**pyramidal;** having the form of or pertaining to the pyramid.

**pyramidal cleavage:** a crystal cleavage, which is parallel to the faces of a pyramid such as anatase bipyramid {101}.

**pyramidal garnet;** a misleading term for idocrase.

**pyramidal system;** same as tetragonal system.

**pyrandine;** a variety of isomorphous intermediate group of pyrope and almandine garnet. Violet color. RI:1.76. SG:3.84. H:7¼. Found in Tanzania, Brazil, Zambia, and Sri Lanka.

**pyrandine garnet;** → pyrandine.

**pyrargyrite;** isomorphous with proustite and polymorphous with pyrostilpnite. Also called ruby silver, dark red silver ore or dark ruby silver. Rarely cut as gem and prized by collectors.

System: hexagonalic.

Formula:  $2[Ag_3SbS_3]$ .

Luster: metallic adamantine.

Colors: dark red to gray-red.

Streak: purplish-red to brown-red.

Diaphaneity: translucent.

Cleavage: {1011} distinct, and {0112} not perfect.

Fracture: conchoidal to uneven. Brittle.

SG: 5.82-5.85.

H:2½-3.

Optics;  $\omega$ :3.08,  $\epsilon$ :2.88.

Birefringence: 0.200. ⊖.

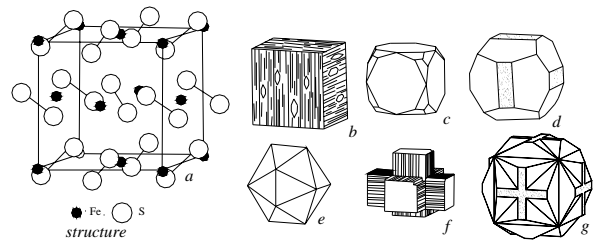
Found in Mexico, Germany, Canada, Bolivia, and California, Colorado, Nevada, and Idaho (USA).

**pyrargyrite cut;** → pyrargyrite.

**pyreneite;** a black or grayish-black variety of andradite garnet. Also called melanite.

**pyrite;** a dimorphous mineral with marcasite. In jewelry misnomerly known as *marcasite*. Probably used by

Incas as mirrors, which were known as  *Pierre des Incas*. They have been found polished in the tombs of the Incas. *Thunderbolts* is a local term for a small



pyrite crystal structure, b-e: crystals, f and g: pyrite twins, and right so called iron cross

nodules of pyrites found in Sussex, England. Occasionally misused is the term *fool's gold*, which is a name for pyrite. A misleading term is *auriferous pyrite*, which is given to some pyrites if they contains no gold of commercial value. Cut into cabochon of any size and prized by collectors. Insoluble in HCl. Nonmagnetic. Also called mundic, iron pyrites, common pyrites, Inca stone. Variety: melnikovite. → Marcasite, marquisite.

System: cubic.

Formula:  $4[FeS_2]$ .

Luster: brilliant metallic.

Colors: pale brassy yellow.

Streak: greenish-black.

Diaphaneity: opaque.

Cleavage: {100} indistincts.

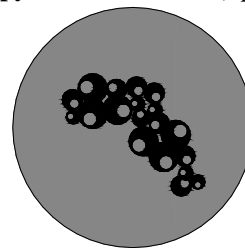
Fracture: conchoidal to uneven. Brittle.

SG: 5.00-5.20.

H:6-6½.

Found: widespread.

**pyrite as inclusions;** pyrite as inclusions are found in



cluster of pyrite spheres in Chivor emerald

quartz, beryl or emerald, sodalite, lapis lazuli, amber and found in some man made ceramics, which are used

as lapis lazuli imitation.

**pyrite cut;** cut cabochon of any size, faceted in rose-cut, in jewelry known as marcasite and made, with pavé setting. → Marcasite.

**pyrite, fool's gold;** same as pyrite.

**pyrite imitation;** imitation are made from various plastics, glass, and cut steel. Also called binarite, polio-pyrite, radiated pyrite.

**pyrite in emerald;** pyrite inclusions in emerald from Chivor mine, Colombian are distinctive. → Pyrite as inclusions.

**pyrite in lapis lazuli;** sprinkling of brassy yellow pyrites in lapis lazuli such from Afghanistan.

**pyritohedron;** same as pentagonal dodecahedron.

**pyritohedron;** same as rhombic dodecahedron.

**pyritoid;** same as pentagonal dodecahedron.

**pyrites;** any number of metallic sulfides, such as pyrite, marcasite, chalcopyrite, stannite, arsenopyrite, linnaeite a cobalt pyrite, and millerite.

**pyrites;** an obsolete term for a mineral that strikes fire.

**pyrochlore;** a rare mineral of pyrochlore group. Cut cabochon, rarely faceted and prized by collectors. Also spelled mikrolith.

System: cubic.

Formula:  $8[(\text{Na,Ca,Ce})_2(\text{Ta,Ti,Nb})_2\text{O}_6(\text{O,OH,F})]$ .

Luster: vitreous to resinous.

Colors: pale yellow to brown to black.

Streak: pale yellowish-brown.

Diaphaneity: translucent to opaque.

Cleavage: {111} indistinct.

Fracture: conchoidal to uneven. Brittle.

SG: 4.45-4.48.

H:5-5½.

Optics: 1.93-1.94. When metamict: 1.98-2.02.

Found in France, Norway, Germany, and Main, California (USA).

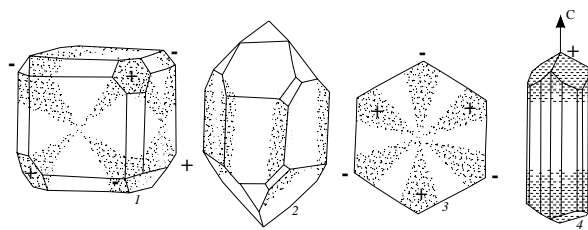
**pyroclastic rock;** an accumulation of solid fragments of volcanic material, which were produced by explosive actions including volcanic conglomerates, agglomerates, tuffs, and ashes. It is characteristic by a lack of sorting of fragments.

**pyrocrystalline;** any mineral crystallized from a molten magma.

**pyroelectric-adiabatic;** → adiabatic pressure.

**pyroelectric effect;** the electrical charging of crystals by heating, which characterized enables the crystal to attract small pieces of paper, ashes, or woods to itself, such as tourmaline, ferroelectric barium titanate, and cane sugar. → Pyroelectricity.

**pyroelectricity;** a property of certain crystals, when positively and negatively charged develop at opposite ends of the hemihedral (polar axis) crystal, when heated



*pyroelectricity of different crystals,*

*1:boeacite, 2 and 3:quartz and 4:tourmaline*

to about 200° C. Examples are quartz or tourmaline

(but this effect is not found in black variety or schorl). Pyroelectricity enables the crystal to attract small pieces of paper, ashes, or wood to itself. → Aschentrekker, piezoelectricity.

**pyroelectricity in tourmaline;** pyroelectricity is strongly observed in tourmaline by means of change of temperature. → Aschentrekker.

**pyro-emerald;** a misleading term used for chlorophane a variety of fluorite.

**pyro-émeraude;** French spelling for pyro-emerald.

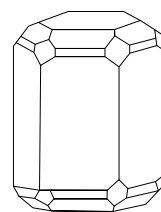
**pyro-smaragdus;** another spelling for pyro-emerald.

**pyrogenous;** an obsolete term for igneous.

**pyrogenous breccia;** an obsolete term for igneous breccia.

**pyrolucite;** a natural, soft, iron-black or dark steely-gray manganese mineral of  $\beta\text{MnO}_2$ . Tetragonal crystal. Opaque. Metallic to semimetallic luster. Black streak. Brittle. H:2-6.5. SG:4.70-5.00. Occurs as inclusions in some gemstones.

**pyrolytic graphite;** a term applied to highly polished graphite, which has strong black metallic reflection because of delocalization of electrons.



*pyromorphite crystal*

**pyromelane;** same as brookite.

**pyroemerald;** a misleading term for green fluorite or chlorophane.

**pyrometer;** a device used particularly for measuring high temperatures for example molten lava, by optical or electrical means. It is also used to heat gemstones to change their color.

**pyromorphite;** an isomorphous mineral with vanadinite and mimetite of apatite group with the Formula:  $2[\text{Pb}_5(\text{PO}_4)_3\text{Cl}]$ . Hexagonal system. Brilliant green, gray, yellow, brown in color. SG:7.04. H:3½. Also called green lead ore. Also called phosphate of lead.

**pyrope cut;** cut and polished as rose cut and used in pavé setting in jewelry, sometimes tumbled. Frequently backed with foil.

**pyrope garnet;** a fiery ruby-red member of garnet group. It is an indicator of the presence of diamond in kimberlite, and also an inclusion mineral in diamond. Also misnomered as Cape ruby, Bohemian ruby, Arizona ruby. Also called precious garnet.

System: cubic.

Formula:  $8[\text{Mg}_3\text{Al}_2(\text{SiO}_4)_3]$ . Contains Fe.

Luster: vitreous to resinous.

Streak: colorless.

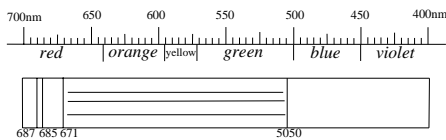
Colors: pure pyrope is colorless, blood-red, fiery-red, deep red, brownish-red.

Diaphaneity: transparent.  
 Fracture: conchoidal to even. Brittle.  
 Cleavage: none.  
 SG: 3.50-3.80.  
 H:7-7 .  
 RI: 1.714-1.742.  
 Birefringence : none.  
 Dispersion : 0.022.

Found in Zimbabwe, South Africa, Myanmar, the Czech Republic, and Arizona, USA.

**pyrope garnet;** an obsolete term for any gems of bright red color. Those pyrope garnet with circular arrangement of quartz crystal inclusions similar to snowballs called *snowball garnet*.

**pyrope absorption spectrum;** 3 characteristic bands at 575, 527, and 505 nm, which contain chromium a



pyrope-garnet absorption spectrum

double line in the deep red at 687, and 685 nm.

**pyrope-almandine;** same as pyralmandite.

**pyrope garnet;** same as pyrope.

**pyrope-spessartite;** a garnet intermediate in chemical composition of between pyrope and spessartine.

**pyrophane;** a synonym for fire opal.

**pyrophane;** an opal variety such as hydrophane impregnated with melted wax.

**pyrophoric material;** any solid or liquid substance that will ignite spontaneously in air below 54.4°C such as gas or cigarette lighters, which has a flint consisting of an alloy of cerium. This lighter becomes incandescent because of spontaneous oxidation in air, which provided heat for burning an inflammable material, which emitted light.

**pyrophyllite;** a mineral similar to massive talc or soapstone. Cut into cabochon and carving objects. A dark gray variety from Transvaal is known as *South African wonderstone*, *Ottosdal G stone* or *koranna* and those from China *agalmatolite*. Also called pencil stone.

System: monoclinic and triclinic.  
 Formula:  $4[Al_2Si_4O_{10}(OH)_2]$ .  
 Luster: greasy, pearly to dull.  
 Colors: yellowish, white, apple-green, pale blue, grayish-green.  
 Streak: white.  
 Diaphaneity: translucent.  
 Cleavage: {001} perfect.

Fracture: uneven. Sectile.  
 SG: 2.65-2.90.  
 H:1½-2.  
 Optics;  $\alpha$ :1.534-1.556,  $\beta$ :1.586-1.589,  $\gamma$ :1.596-1.601.  
 Birefringence: 0.050.  $\ominus$ .

Found in Minas Gerais (Brazil), Mexico, Belgium, Russia, China, Japan, Australia, Sweden, Switzerland, California, Arizona and Pennsylvania, USA.

**pyrophyllite;** in South Africa is known as *Ottosdal G stone* or *wonderstone*. → *Koranna*.

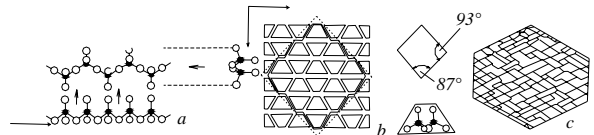
**pyrophyllite in catlinite;** → *catlinite*.

**pyrophyllite luminescence;** weakly cream-white under LWUV.

**pyrophyllite tetrahedral;** a tetrahedron made of pyrophyllite, in which a tube of graphite is placed (and in the graphite tube samples placed) across the pyrophyllite tetrahedron, which endure high pressure by producing synthetic diamonds.

**pyropysalite;** a coarse opaque yellowish white variety of topaz. Also called *physalite*.

**pyroxene;** a group of dark-colored inosilicates of general composition  $ABSi_2O_6$  and physically related



a: pyroxene chain, b: formation of cleavage and c: a section through crystal with its cleavage

minerals, which are closely analogous chemically to the amphibole  $[A_2B_5(Si,Al)_8O_{22}(OH)_2]$  clan. Where  $A=Ca, Fe^{2+}, Li, Mn, Na, Mg$  and  $B=Al, Cr, Fe^{+3}, Mn, Mg, Zn$ . Possess orthorhombic or monoclinic symmetry. The pyroxene group includes enstatite, hypersthene, diopside, hedenbergite, augite, acmite, aegirine, pigeonite, jadeite, spodumene, aegirine-augite. A few of them are gem members.

**pyroxmangite;** a rare mineral. Cut cabochon and faceted gems are small. Prized by collectors. Also called iron rhodonite.

System: triclinic.  
 Formula:  $2[(Mn, Fe)_7Si_7O_{21}]$ .  
 Luster: vitreous to pearly.  
 Colors: rose to red-brown, pale rose to pink, dark brown.  
 Streak: colorless.  
 Diaphaneity: translucent.  
 Cleavage: {110}, {110} distinct, and {010} and {001} less perfect.  
 Fracture: uneven. Brittle.  
 SG: 3.61-3.80.

H:5½-6.

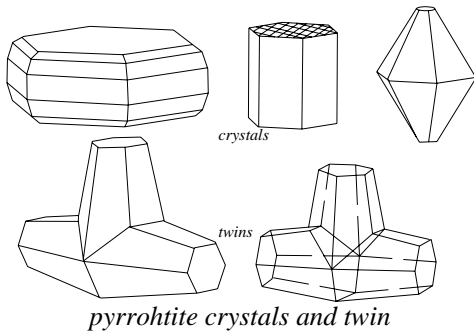
Optics;  $\alpha$ :1.726-1.748,  $\beta$ :1.728-1.750,  $\gamma$ :1.744-1.764.

Birefringence: 0.016-0.020.  $\ominus$ .

Found in California, Idaho, and Carolina (USA), Japan, and Australia.

**pyroxmangite pleochroism;** pale shades of red and violet or pink.

**pyrrhotine;** same as pyrrhotite.



**pyrrhotite;** associated with pyrite. Cut cabochon and

*pyroxmangite pleochroism - pyrostitilbite*

prized by collectors. Variety: troilite. Also called pyrrhotine, while magnetism effect is called *magnetite pyrite*. Magnetic which varying in intensity but lost its effect on heating. Decomposed in HCl. Also called Magnetic pyrites, dipyrrite.

System: hexagonal and monoclinic.

Formula:  $2[\text{FeS}]$ .

Luster: metallic.

Colors: bronze-yellow, brown, to brown-red. Readily become iridescent.

Streak: dark grayish-black.

Diaphaneity: opaque.

Cleavage:  $\{0001\}$ , and  $\{1120\}$  sometimes distincts.

Fracture: conchoidal to uneven. Brittle.

SG: 4.53-4.77.

H:3½-4½.

Found in Canada, Brazil, Italy, Norway, Sweden, Mexico, Pennsylvania, and Tennessee (USA).

**pyrostitilbite;** → kermesite.

# Q q

**QAR;** an acronym for Quality Analysis Report.

**Qift;** → Coptos emerald.

**quadratic;** an old term for tetragonal system.

**quadratic system;** an old term for tetragonal system.

**quadrillion cut;** a commercial term for a rectangular brilliant cut with 21 facets on the crown, 24 facets on the pavilion and 4 facets on the girdle, totally 49 facets.

**Quadrula ebena;** → niggerhead mussel.

**Quadrula plicata;** a variety of fresh-water mussel known as blue-point mussel of genus *Quadrula undulata* or *Quadrula plicata*, which is known as *three ridge mussel*. They are fished for pearls and their shells, which are used in the manufacture of pearl buttons.

**Quadrula undulata;** → *Quadrula plicata*.

**quahog clam;** same as quahog shell.

**quahog pearl;** pearl from the salt-water hard clam *Venus mercenaria* of the Atlantic coast of United States.

**quahog pearl;** a salt-water, hard shelled and sand-dwelling clam of genus *Mercenaria mercenaria* Linné. Used as beads and like objects. Found along Atlantic coast.

**quality;** a term in Europe for clarity, used in the sorting and grading of rough diamonds.

**quality;** the relative factors in the grading of polished diamonds depends on the color, clarity, cut (make or finish) in relation to a set standard.

**Quality Analysis Report;** same as Diamond Grading Report with an abbreviation of QAR.

**quality, factors that determine;** → evaluation.

**quality improvement;** same as upgrading.

**quanta;** → photon.

**quantum;** quantum of light or electromagnetic radiation, it can behave as a wave or as a particle. Traveling at the velocity of light. Photon have momentum but not mass or electrical charge. Also known as light quantum. Caused by excitation of atoms and molecules and more energetic ones can cause ionization. A sample for a quantum: when one gram sand corn swinging as a pendulum, one swing per second and rising one cm during each swing which has an energy of about 0.0001 Joule, this swinging corn contains about  $150 \times 10^{27}$  quanta of energy. → Photon, phonon scattering, light.

**quarrel;** same as quarry material.

**quarry;** an open or surface working place, where slate

or other stone like slate is obtained for building stone.

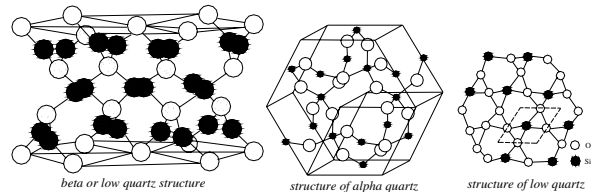
**quarry;** knock off or separate the rock.

**quarry;** a square stone.

**quarry block;** → dimension stone.

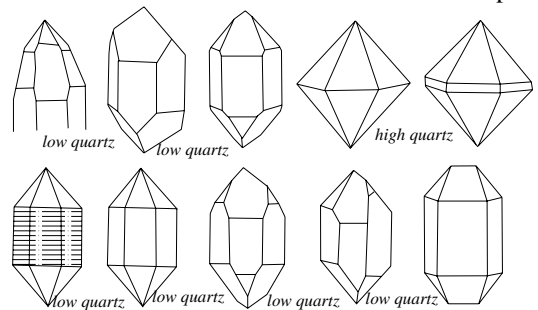
**quarter;** ¼ of carat or 0.25 cts.

**quartz;** quartz is the most abundant and widespread mineral. It is an important rock-forming mineral that occurs in igneous, metamorphic, and sedimentary rocks. Quartz includes many varieties of gem-quality



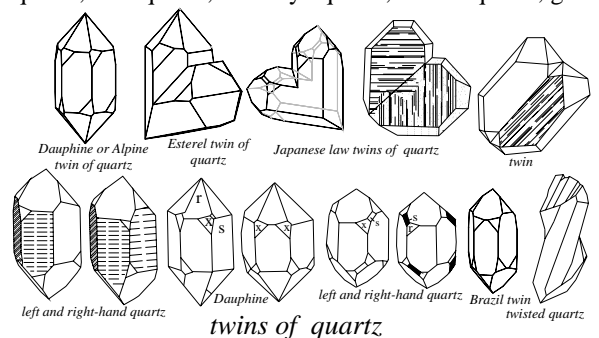
quartz crystal structures

and ornamental stones and colors. Quartz is piezoelectric and is used for accurate timepieces,



quartz crystals

broadcast emission and to produce high-intensity halogen lamps in gem testing devices. Quartz and varieties are: (a) crystalline forms: amethyst, milky quartz, rose quartz, cat's-eye quartz, needle quartz, gold



twins of quartz

quartz, rock crystal, brown or smoky quartz, citrine, royleite, morion, and cairngorm. (b) Cryptocrystalline: chalcedony in several varieties, carnelian, sard, prase, onyx, chrysoprase, bloodstone, sardonyx, flint, chert

and plasma. (c) Massive varieties: quartzite, jasper, aventurine quartz. Some varieties exhibit chatoyancy effect, when cut as a cabochon. *Rock crystal* is a colorless quartz, which is known as rock crystal. Twinning of quartz are: Brazilian twin, Dauphiné twin, and Japan twin. Optically active quartz is divided into left hand and right hand quartz; the plane of polarization of light rotates to the left, when lights passed parallel to the *c*-axis is called *left hand quartz*. If the rotation is to the right it is known as *right hand quartz*. → Cristobalite, obsidian, quartz inclusions, piezoelectricity.

System: hexagonal (trigonal). Three dimensional network of silicon-oxygen tetrahedra like feldspars.

Formula:  $3[\text{SiO}_2]$ .

Luster: vitreous, greasy, some specimen waxy.

Colors: colorless, white, shades of yellowish, brown, purple, pink, violet, green, blue, smoky, black.

Streak: colorless.

Diaphaneity: transparent to translucent.

Cleavage: {1011} not distinguishable with the naked eye.

Fracture: conchoidal to uneven with greasy luster. Brittle.

SG: 2.65, chalcedony: 2.91.

H:7.

Optics:  $\omega$ :1.544,  $\epsilon$ :1.553.

Birefringence: 0.009. ⊕.

Dispersion: 0.013.

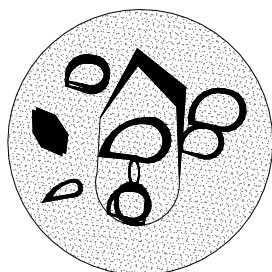
Found: worldwide.

**quartz**; the name used as a prefix such quartz diorite, etc. Occurred in rocks of all kinds such as igneous, metamorphic, and sedimentary.

**quartz**; a term applied to any hard gold ore and frequently silver ore, which is either broke or in situ as distinguish from earth or gravel gold.

**quartz, alpha**; same as low quartz, alpha quartz.

**quartz as inclusions**; quartz as inclusions can be seen in



quartz  
inclusions in  
aquamarine

topaz, beryl, tourmaline, chrysoberyl, spinel, garnet, and opal.

**quartz, aventurine**; → aventurine quartz.

**quartz-banded ore**; a term frequently applied in Scandinavia to a metamorphosed iron formation.

**quartz bearing**; same as quartziferous.

**quartz, beta**; same as high quartz, beta quartz.

**quartz, cat's-eye**; a variety of translucent, grayish-green to greenish yellow chatoyant quartz or chalcedony containing fine parallel fibers of asbestos or parallel channels, arranged through the stone at right angles to the eye and parallel to the base of the crystal, that exhibit an opalescent play of light, when cut cabochon. Found in Sri Lanka, Bavaria (Germany). Also known as schiller quartz, and erroneously as changeable feldspar. → Quartz inclusions.

**quartz crystal**; a clear colorless, quartz crystal used as gemstone, diamond imitation, optics and electronics. Also called rock crystal.

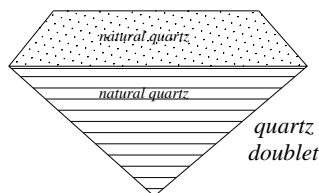
**quartz, crystalline**; → crystalline quartz, quartz.

**quartz, crystalline cut**; → quartz cut.

**quartz, crystallization**; growth of quartz.

**quartz, cryptocrystalline**; → cryptocrystalline quartz, quartz.

**quartz cut**; cut into cabochon, and faceted gems such as emerald cut, brilliant cut, engraved, beads and balls in any sizes and flat forms, roundels, other decorative objects and sometimes as replicas



of famous brilliants. Used as doublets and composite stone with the name *soudé emerald*.

**quartz diamond**; a misleading term for rock crystal from Yugoslavia.

**quartz, dyed**; → stained quartz.

**quartz doublets**; an assembled stone made of two pieces of quartz for the crown and the base is joined by a transparent emerald-green gelatin or plastic cement. It was made to be used as an emerald imitation or émeraude soudé. When blue cement is used the stone will be used as a sapphire blue or as an alexandrite imitation, which resembles synthetic sapphire used as an alexandrite imitation. The stones shows 3 band spectrum of cobalt.

**quartz effect of heat on color**; → burnt amethyst, heat-treated quartz.

**quartz en chemise**; a skin deep milky white quartz.

**quartz fels**; same as silexite.

**quartz felsite**; a rhyolite or quartz porphyry.

**quartz, gem varieties**; quartz gem varieties are citrine, amethyst, rock crystal, rose quartz, smoky quartz, greened amethyst, aventurine, chalcedony, chrysoprase, bloodstone, chrysocolla, tiger's-eye, varieties of agate, and varieties of chalcedony.

**quartz glass**; → fused quartz.

**quartz glass**; a misleading term for any glass made from sand quartz.

**quartz gold**; → gold quartz.

**quartz grain;** quartz particle, which is smaller than a fragment.

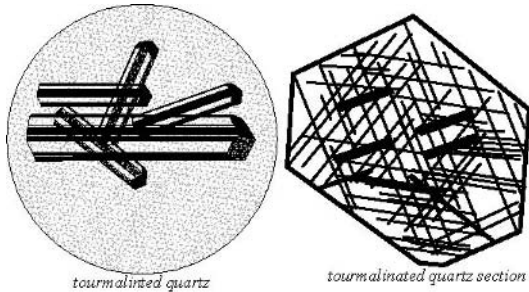
**quartz gravel;** an unconsolidated natural accumulation of rounded quartz fragments.

**quartz growth;** same as quartz crystallization.

**quartz halogen lamps;** → quartz.

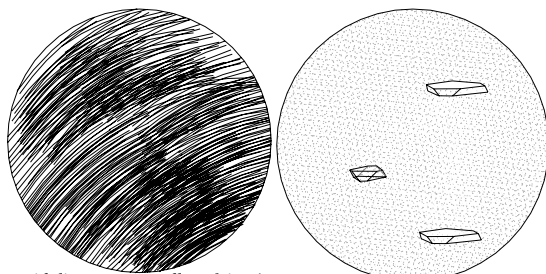
**quartzic;** same as quartziferous.

**quartz inclusions;** several inclusions have been found in crystalline quartz, also negative crystals, bubbles, cavities, and cracks: *actinolated quartz* containing



quartz, inclusions in

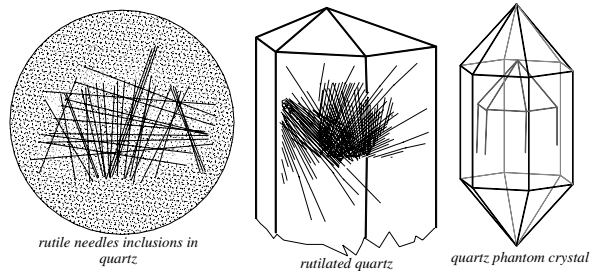
green needle-like variety of actinolite known as byssolite. *Chlorite quartz* contain chlorite and gives green mossy-like color to quartz. *Chrysocolla quartz* is a blue-green very fine disseminated chrysocolla in quartz. *Crocidolite quartz* is a tiger-eye or tiger's-eye. *Dumortierite quartz* is a blue-green very fine



quartz inclusions

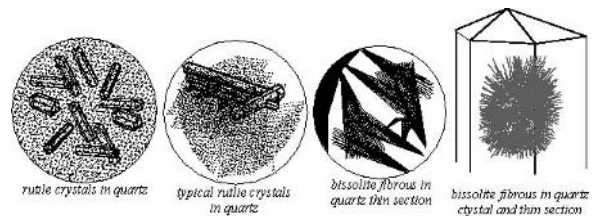
disseminated dumortierite in quartz. *Goethite quartz* contains goethite fibers and crystals, which give yellow, orange color to quartz. *Gold quartz* is a milk quartz containing very small grains or fibers of native gold. → Milky quartz. *Hematite quartz* has blood-red plates as inclusion in some sunstone and aventurine quartz. *Rutilated quartz* has rutile needle inclusions of red, gold color, called *Venus's-hair stone*, *flèches d'amour* and *cupid's darts*. When quartz contains needlelike crystals of tourmaline, actinolite, goethite or other minerals it is known as *thetis hair stone*. *Sagenitic quartz;* contains any type of needlelike inclusions such as rutile, tourmaline, actinolite, goethite or other minerals, which sometimes gives a net-like appearance

or *reticulated needles*. *Tourmalinated quartz;* contains black, or other colored tourmaline. Also spelled *tourmalated quartz*. Some inclusions such as cracks



quartz inclusions

create an iridescent effect in quartz known as *rainbow quartz* or *iris quartz*. *Cat's-eye* effect is caused by reflection of light from numerous included minute fibers or long parallel cavities, canals, or tubes. *Hawk's-eye quartz* is a variety of cat's-eye quartz after parallel fibrous of crocidolite, which resembles the eye



quartz inclusions

of a hawk, when cut cabochon, also called *falcon's-eye*. Fine golden-brown crocidolite, is known as *tiger's-eye* or *tiger-eye*. Parti-colored golden-brown and blue crocidolite known as *zebra crocidolite* or *zebra tiger-eye*. Other inclusions are epidote, hornblende, scapolite, and blue anatase. In Herkimer County quartz can be seen black inclusions of petroleum. → Quartz, cat's-eye.

**quartziferous;** a rock that contain a minor proportion of quartz such as limestone or syenite to distinguish it from a quartz variety. Also called quartz bearing, quartzic.

**quartziferous;** a rock consisting chiefly of quartz.

**quartzine;** a fibrous chalcedony.

**quartzite;** a metamorphic rock consisting of a granular, interlocking mass of irregular quartz crystals with irregular boundaries, which are formed from pre-existing quartz sandstone or chert. Some samples contains flakes of reddish iron mineral or minute crystals of mica with iridescent effect, which is called *aventurine quartz*, and frequently contains green



chrome-rich mica particles known as fuchsite. If quartzite has a dark-green color due to fuchsite it is called *quartz schist*. Fine-grained, bluish-white quartzite, which is brownish-red veined reportedly comes from Idar, Germany and contains crystals of pyrite. Quartzite has RI:1.55 and SG:2.64-2.69. Found in Russia, Spain, Tanzania, Chile, and India. Also called metaquartzite.

**quartzite;** a sedimentary rock consisting of grains of silica sands cemented together by silica. Also called orthoquartzite.

**quartzite;** a term frequently applied by Australian miners for an opal variety occurs in quartzite rock scattered as layers.

**quartzite;** a term frequently applied to granular quartz.

**quartzite, dyed;** same as dyed quartzite.

**quartz latté;** an obsolete term for rhyodacite.

**quartz, left;** same as left quartz.

**quartz, left hand;** same as left quartz.

**quartz luminescence;** green, brown, white, orange fluorescence color under LWUV, and SWUV rays due to impurities in some cryptocrystalline varieties. Dull blue effect under X-rays in rose quartz. Some pieces shows phosphorescence.

**quartz, microcrystalline;** same as quartz-, cryptocrystalline.

**quartz mine;** a mine, in which the quartz is the chief mineral associated with gold.

**quartz monzonite;** a granitic rock containing 10-15% quartz and 35-65% feldspars with minor biotite, hornblende. Equivalent to rhyodacite. Also called adamellite.

**quartz, name of;** a term may be derived from the Slave (Bohemian) or Saxon (Germany) which has been considered to have come from the term *querklufferz*, meaning cross-vein or dip-joint, which often is rich in quartz or milky dense quartz and occur in metallic mining areas or ores.

**quartz diamond;** a misleading term for quartz crystal from Isère, France.

**quartzoid;** a crystal shape with two six-sided pyramids base to base, which is usually a crystal form of high temperature quartz and is unlike common quartz.

**quartz oscillators;** → piezoelectricity.

**quartzose;** a term used for a rock that containing of quartz is a principal constituent. Also called quartzous or quartzy.

**quartzous;** same as quartzose.

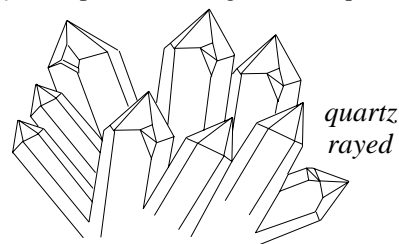
**quartz pebbles;** a term applied to small rounded waterworn quartz fragments.

**quartz plate;** same as quartz wedge

**quartz pleochroism;** weakly Bluish-pink to reddish-violet in amethyst or rose quartz.

**quartz porphyry;** a medium-grained igneous rock of the granite group, containing phenocrysts of quartz, orthoclase, and mica set in a cryptocrystalline groundmass.

**quartz rayed;** a peculiar arrangement of quartz crystals



having radiating divisions of the crystals from one point similar to sunburst. Also called rayed quartz.

**quartz, right;** same as right quartz.

**quartz, right hand;** same as right quartz.

**quartz rock;** same as quartzite.

**quartz, rose;** → rose quartz.

**quartz scepter;** → scepter quartz.

**quartz schist;** an opaque, green, sometimes banded (light and dark green) quartzite rock containing heavy concentrates of fuchsite mica, which is often mistaken for malachite.

**quartz schist;** a variety of schist containing streaks and lenticles of nongranular quartz.

**quartz, stained;** → stained quartz.

**quartz, star;** → rose quartz.

**quartz, synthetic;** → synthetic quartz.

**quartz, synthetic inclusions;** → synthetic quartz.

**quartz topaz;** a misleading term for citrine quartz.

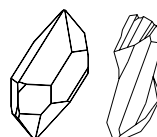
**quartz topaz;** a misleading term for heated amethyst of golden brown color.

**quartz tourmaline intergrowth;** → graphic intergrowth.

**quartz, trace elements in;** amount of aluminum, alkali elements such as sodium and lithium are present in quartz. Ferric iron and titanium are present in amethyst and rose quartz.

**quartz twin;** twinning of quartz are: Brazilian twin, Dauphiné twin, and Japan twin. → Quartz.

**quartz twisted;** the act of deformation of quartz crystal, when its shape is twisted out, so that the angles between its crystal faces may differ widely from those on the regular form. Also called



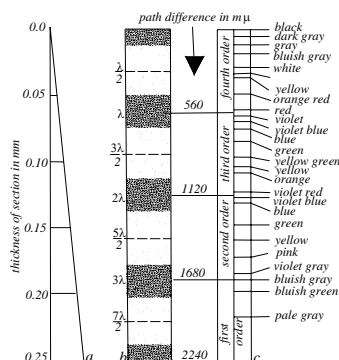
*twisted quartz, quartz distorted*

strained crystal.

**quartz varieties;** in mineralogy or gemology quartz varieties showing differences in appearance, color or other optical properties. A minor variation in chemical

constitution causes the color difference in a species, which is based on variety, for example rose quartz, smoky quartz, amethyst, citrine, blue quartz, etc. are varieties of quartz. For more information see appendices.

**quartz wedge;** a very thin wedge-shaped piece of quartz cut parallel to an optical axis of a prism of quartz crystal. Used in optical mineralogy and petrography to



*a: cross section of quartz wedge, b: monochromatic light  $\lambda = 560 \text{ nm}$  and c: colors in four orders of white light*

determine the sign of the birefringence of biaxial minerals. Also used for involving polarized light and its interference figure in convergent light. Also called quartz plate.

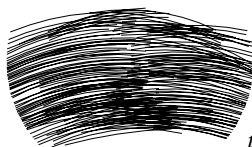
**quartz, white;** → yellow quartz.

**quartz, yellow;** → yellow quartz.

**quartz;** same as quartzose.

**quasicrystal;** a kind of solid substance whose atoms or molecules are arranged like those of a crystal but assume a structure that does not exactly repeat itself.

**quasi-parallel;** a kind of fibers of having some resemblance to parallel arrangement such as quartz fibers in tiger-eyes that caused the tiger-eyes effect which can be seen in some other



*quasi-parallel fibers of quartz in tiger-eye's*

minerals.

**Quasima diamond;** same as Arabic diamond.

**Quaternary;** a period of geological time, second period of the Cenozoic era, which followed the tertiary. Representing the last 2 million years of the Cenozoic era. → Holocene or recent. Also called age of man, Quaternary Age.

**Quaternary Age;** same as Quaternary.

**Quebec;** a province in east Canada where there are several important gem mineral deposits.

**Quebec diamond;** a misleading term for quartz crystal variety from Quebec, Canada.

**quencher;** → phosphor in zinc sulfide.

**Queen conch;** same as giant conch.

**Queen Elizabeth Pearls;** four drop-shaped pearls belonged to Queen Elizabeth of England. No further information available.

**Queen Elizabeth Pink Diamond;** same as Williamson Pink Diamond.

**Queen Frederica Diamond;** a colorless, table-cut diamond of 2 cts, which is engraved with a portrait of Queen Wilhelmina of Holland.

**Queen Jeanne d'Evreux Emerald;** queen of France, who leaved after her death 1372 a crown and a coronel decorated with emeralds.

**Queen of Albania Diamond;** reportedly a pear-shaped diamond of 49.03 cts, probably from South Africa. Owned by Queen Geraldine of Albania. It was sold in London in 1960. It believed that the Queen of Albania is the same as Pigott Diamond. Present owner unknown.

**Queen of Belgium Diamond;** same as La Reine des Belges Diamond.

**Queen of Diamonds;** → Mable Bolls Diamond.

**Queen of France;** → Anne of Austria.

**Queen of Holland Diamond;** a white, with blue tint, cushion-shaped brilliant-cut diamond of 136.25 cts, probably from India, named after Queen Wilhelmina (1880-1962). It was sold to the Maharajah of Nangar, India, in 1930. Purchased by William Goldberg Diamond Corporation of New York, in 1978 and was repolished into a 135.92 cts, stone. Present owner unknown.

**Queen of Pearls;** same as La Reine des perles.

**Queen Pearl;** a pinkish pearl of 23.25 cts, (93 grains) from fresh-water pearl found in Notch Brook, New Jersey, in 1857. Sold to Tiffany & Co. and was purchased by Empress Eugénie. Now on display at the University of Pennsylvania, USA. Also called Tiffany Queen Pearl.

**Queensland;** a state in north-eastern Australia where there are several important sapphire, opal and other gem or mineral deposits.

**Queensland-jade;** same as Australian jade.

**Queensland opal;** light yellowish opals found over a large area in Queensland, Australia.

**Queensland opal matrix;** a term used by Australian miners for a kind of boulder opal in which the seams of precious opal and potch running freely in a hard, close grained largely ironstone or sandstone.

**Queensland sapphire;** usually deep blue, and often green, pink, purplish sapphire from Anakie, Queensland, Australia. Sometimes blue star sapphires are found.

**Queensland shell;** Pinctada maxima is a silvery white large genus of salt-water pearl-bearing oyster, which lives in the north of and in western Australia. Those

from the Malay coast have a wide yellow border. The shells contain some of the largest pearls but the main interest is in the mother-of-pearl. Also called Port Darwin shell, New Guinea shell, Manila shell, Sydney shell, Mergui shell, and Macassar shell (a seaport and a trading center of gems and pearls on South West Celebes, Indonesia.).

**queen stone;** an informal term used by Australian miners for king stone.

**queenstonite;** same as Darwin glass.

**queen's ware;** a variety of cream colored wedgwood ware.

**queluzita;** a Spanish/Brazilian term for spessartite.

**quench cracking;** same as quench crackled synthetic corundum, quench crackled synthetic quartz.

**quench crackled synthetic corundum;** an unusual feature occur in Verneuil synthetic corundum by plunging of still heated stone into a much cooler liquid (thermal shock), which create fractures and it resemble closely to natural stone. By pursuing of this process developed *honeycomb pattern* due to creating fractures. Also called quench cracking.

**quench crackled synthetic quartz;** an unusual feature occur in synthetic quartz by plunging of still heated stone into a much cooler liquid (thermal shock), which create fractures. Also called quench cracking.

**quenched fluorescence in ruby;** when ruby contain iron impurity in addition to the chromium, the fluorescence is quenched.

**quercetin;** same as quercitin.

**quercitin;** yellow needle crystals of  $C_{15}H_{10}O_7$ . Soluble in alcohol, glacial acetic acid, and insoluble in water. Obtained from the bark of the trees. Also synthetically. Used as dyes. Also called quercitin.

**Queretaro;** location of fire and normal opal deposits in the northwest of Mexico City, Mexico.

**querkluftez;** a German-Slave term meaning cross-vein or dip-joint, which often is rich in quartz or milky dense quartz and occur in metallic mining areas or ores, suggested to be a contraction *name for quartz*. → Name of quartz.

**quetzal;** → quetzal chalchihuitl. Also called stone of quetzal.

**quetzal chalchihuitl;** a green and white, translucent jade

from Central America used by Aztec and Toltec Indians as magical carved objects.

**quetzalztl;** a cloudy green variety of jadeite or quetzal from Mexico, mistaken for emerald.

**quicksilver;** a common term for mercury.

**quicksilver jade;** a Chinese term for an unusual variety of jade.

**quilate;** a Spanish and Portuguese term for carat.

**qilin;** a Chinese term for mythical unicorn, a horn-shaped vessel for drinking, carved from jade in many variations. → Chinese ritual and symbol jades.

**quinalizarin test of beryl;** a red crystalline organic compound of  $CH_3C_9H_6N$ , having green metallic luster, used as chemical indicator (0.02%), with the solution of sodium hydroxide (1%), for quick test of small grains of beryl in placers on the field. If beryllium is present, the indicator solution turns vivid cornflower blue. → P-nitrobenzene-azo-orcinol, morin test of beryl, alkalinity test.

**quincite;** an attractive, pink colored variety of common opal.

**quincite;** a pink variety of sepiolite found in Quincy-sur-Mer, Loire Basin, France. Also spelled quinzite.

**quinzite;** same as quincite.

**quinoline;** an oily colorless, specific odor, insoluble basic heterocyclic with the formula  $C_9H_7N$ . Composed synthetically by heating aniline, nitrobenzene, glycerol, and sulfuric acid. Used as food preservative and in the manufacture of dyes and antiseptics. R.I.=1.621. Also spelled chinolite.

**quinone;** a group of organic yellow crystal, bad odor, soluble in alcohol, ether, alkalis, and slightly in hot water with the formula  $C_6H_4O_2$ .

**Quisumah diamond;** same as Arabic diamond.

**quoin facets;** the four quadrilateral facets of 8 main facets on the crown or on the pavilion of a brilliant-cut stone, which are also called bezel facets. The 4 on the crown touching the girdle with their apex and extending up to touch the table. There are four lozenge-shape facets on the pavilion touching the girdle with their apex and extended down to culet, which is adjacent to the pavilion facets. The other 4 facets, or main facets on the crown are known as *templets*.

# R r

**Ra**; a chemical symbol for the element radium.

**rabben**; a German term used for yellow hornstone.

**rabbit's-blood**; a Burmese term used for ruby of dark ruby with bluish range.

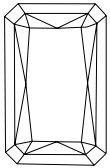
**radar**; an acronym for radio detecting and reading.

**radiability**; being transparent to X-ray radiation. → Transparency to X-rays.

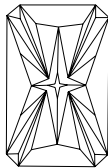
**radial**; crystal needles converging at a single point.

**radial aggregate**; same as sunburst aggregate.

**radiant cut**; a commercial term for cushion-shape or



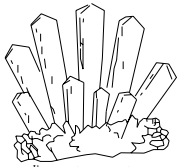
radiant cut



emerald-cut diamond with 70 facets. It has emerald-cut outline and emerald-cut facets on the crown and a brilliant-cut with triangular facets on

pavilion. Designed by Henry Grossbard in 1977-78.

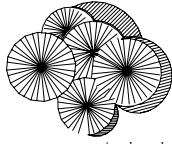
**radiated**; an aggregate of needle-like, scales, or column



divergent aggregate or radiated aggregate



sphaerulitic aggregate of wavelite



cross section through radiated ball of wavelite

two different kinds of radiated or divergent aggregates

crystals which radiate from a central point.

**radiated baryte**; same as Bologna stone.

**radiated quartz**; a term used for fiber quartz.

**radiated quartz**; a term used for quartz rayed.

**radiated quartz**; a misnomer for fiber sillimanite or fibrolite.

**radiation**; the emission of particles or electromagnetic waves from a source such as nuclear radiation, X-rays, neutrons, gamma rays, electrons positive or negative, protons. Radiation has the effect of artificially altering color by artificially creating color centers due to crystal defect in the space lattice. For example green irradiated diamond often turns to yellow or cinnamon brown when radiated for some hours by heat-treatment.

**radiation induced color change**; → diamond artificial coloration.

**radiation treatment**; → irradiation.

**radiated pyrite**; same as marcasite.

**radiant**; a commercial term for synthetic colorless spinel. Used as a diamond imitation. Also called corundolite.

**radioactive**; a property possessed by certain materials, which spontaneously emit unstable elementary particles or rays such as alpha, beta, and gamma by radioactive decay of atomic nuclei.

**radioactive**; emitting radioactivity or pertaining to radioactivity.

**radioactive carbon**; same as carbon 14 or radiocarbon.

**radioactive decay**; spontaneous radioactive disintegration of an unstable atomic nuclei or change of one nuclide into one or more different isotopes. Also called radioactive disintegration. → Radioactivity.

**radioactive disintegration**; same as radioactive decay.

**radioactive glass**; yellowish-green glass, which contain uranium. RI:1.635. SG:3.75-3.77. Under SWUV and LWUV light fluoresces chalky green and chalky orange. Absorption spectrum strong from 700 to 600 nm and from 440 to 400 nm, 470 and 460 nm. → Radioactive.

**radioactive isotope**; same as radioisotope.

**radioactive rays**; → radioactive.

**radioactivity**; describing of natural spontaneously, disintegration of certain unstable isotopes into new isotopes accompanied by the emission of alpha-rays, beta-rays, and gamma-rays and by the generation of heat. The length of delay is called the nuclide's half-life and ultimate end-product is an isotope of lead. → Radioactive decay.

**radioactivity in beryl**; some yellow beryl exhibits radioactivity because it contains traces of uranium oxide. A dark yellowish-red beryl from Brazil is known as *berilo bocade fogo*.

**radioactivity in diamond**; → Artificial treatment of gemstones, radium-treated diamond.

**radioactivity in ekanite**; → ekanite.

**radioactivity in zircon**; → metamict, high zircon, low zircon.

**radioactivity in monazite**; → monazite.

**radioactivity in spodumene**; some yellowish-orange spodumene exhibits radioactivity because it has been irradiated by exposure to isotope scandium-46.

**radioactivity in topaz**; → topaz.

**radioactivity in tourmaline**; → tourmaline, irradiation of.

**radioactivity in trinitite**; → trinitite.

**radioactivity in zircon**; → zircon.

**radiocarbon age**; same as radiocarbon dating.

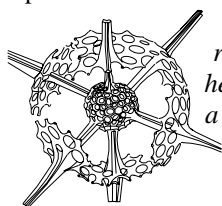
**radiography**; the method used to make a radiographic picture of a substance by means of short-wavelength

radiation, such as X-ray, or gamma-rays. The material is placed on a sheet of photographic plate and the picture serves for internal inspection of specimens or composition of pearls and diamonds. Natural diamond is transparent to X-rays, while diamond simulants are either opaque or translucent. → Autoradiography.

**radiography;** → radioluminescence.

**radioisotope;** an unstable radioisotope of an element that emits gamma rays and has about the same penetrating power as those of radium. Used in the artificial color treatment of diamond and gemstones. Also called radioactive isotope.

**radiolarian;** a large group of unicellular marine animal of genus protozoa, characterized by having a shell with a perforated membranous containing the endoplasm and



*radiolarian  
hexactinium,  
a biomineral*

siliceous or strontium sulphate, which may or may not secrete skeleton of various shaped ranging in size from 0.1 mm to 8

cm. They are warm water living from Cambrian in age.

**radioluminescence;** the luminescence effect, which is simulated by the impact of radioactive particles such as gamma rays or X-rays on a mineral. Also called roentgenoluminescence, ionoluminescence, radiography, or scintillation.

**radio opal;** smoky opal of common quality, the color due to organic impurities as inclusions. → Smoky opal.

**radio wave;** an invisible part of electromagnetic radiation ranges from about 10 kilohertz to about 300,000 megahertz used in radio and TV broadcasting.

**radium;** a term used for silver-white, naturally radioactive luminescent, metallic element of the alkali-earth metals of the Periodic System with the symbol Ra. Chemically resembling barium. Used to change the color of diamond. → Radium-treated diamond.

**radium bromide;** a chemical compound of  $RaBr_2$ , which is a colorless to white powder, radioactive, poisonous, soluble in water or alcohol. It is used for alteration of diamond color. → Radium-treated diamond.

**radium diamond;** a misleading term for smoky quartz.

**radium fluorescence;** radium treatment of minerals such as beryl to produce a bluish-white fluorescence only on the basal planes. Under SWUV and LWUV light beryl fluoresces bluish-white. → Fluorescence, radioluminescence, luminescence, radium.

**radium-greened diamond;** → radium-treated diamond.

**radiumite;** pitch-blende or uraninite and other uranium minerals, which sometimes cut as cabochon. Although they are radioactive.

**radium-treated diamond;** the color of diamond and other gem materials which can be artificially turned green, blue, brown, and yellow by exposure to radium bromide or other radioactive compositions, or if necessary by subsequent heat-treatment. Stones exposed to radium are called *radium-greened*. The color penetration is skin-deep and the radioactive film can be removed by repolishing. These treated stones can be recognized from other natural green stones by means of spectroscopy analysis when the umbrella effect can be seen, or colored diamonds which are radium treated have the ability to fog a photographic plate. Because the radioactivity of treated diamonds they are dangerous and can cause injury to the skin. → Diamond neutroned, artificial treatment of gemstones, cyclotroned diamonds.

**radium-treated diamond, examination of;** → scintillation.

**radius-dressing diamond tool;** a holder or diamond dressing tool that set is with a single diamond for dressing radial forms.

**ra-e-hani;** may be it is a corrupted term of *rihání* (*rihani*), an Arabic term for basil or basil color, which was used by Al-Biruni and other gem authorities in classification of emerald as deep green color of fine grade.

**rag;** same as ragstone.

**ragstone;** a term used in Scotland for hard, coarse sandstone with an irregular surface due to weathering. Used as building stone. Also called rag.

**rahu;** → ketu.

**raichanijj, rihání;** an Arabic-Farsi term that means emerald of basil green color.

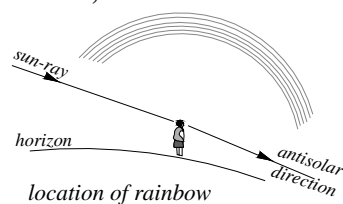
**raies sensibles;** those rays that are often found in the visible region of the spectrum. → Ultimate lines in spectra.

**raies ultimes;** those rays that lie mostly in the UV part of the spectrum. → Ultimate lines in spectra.

**railway diamond;** a misleading term for quartz crystal from India.

**rain;** inclusions of thin parallel capillary or elongated tubes in some stones similar to rain. Also called turbid clouds.

**rainbow;** an effect of a continuous spectrum of colored



arc seen in the sky, when the sun is illuminating the minute droplets, spray, or mist of rain in the air. The effect is obvious

only, when the observer has his back to the sun, caused by the refraction and internal reflection of light in water

droplets, which act as the dispersing system.

**rainbow;** a chromatic iridescence phenomenon observed in some stones resembling the colors of rainbow.

**rainbow agate;** a variety of agate with iridescent phenomenon of thin concentric slices, when cut cabochon resembles the colors of a rainbow. Same as iris agate.

**rainbow chalcedony;** same as rainbow agate.

**rainbow diamond;** a misleading term for a synthetic rutile. Used as a diamond imitation.

**rainbow gem;** a commercial term for a synthetic rutile. Used as a diamond imitation.

**rainbow magic diamond;** a misleading commercial term for a synthetic rutile. Used as a diamond imitation.

**rainbow obsidian;** an iridescent obsidian from Lake County, Oregon, USA.

**rainbow opal;** a pale chromatic iridescence observed in some opals resembling the colors of rainbow.

**rainbow quartz;** an iris quartz that resembles the colors of the rainbow.

**rainbow quartz;** a treated quartz crystal, where the stone has cracks artificially created by heating and suddenly cooling in dyed water, which imitate rainbow quartz, also known as *fire stone*. → Iris quartz.

**Rainbow Ridge opal;** a famous precious opal mine in Denio on the Oregon border, USA.

**rain forest agate;** same as rain forest jasper.

**rain forest jasper;** a local term used in USA for spheroidal rhyolite from Australia. Also called rain forest agate.

**rain like;** a term used to minute particles similar to parallel row which resemble the rain like, found as inclusions in Czochralski, Inamori and Kashan synthetic rubies.

**rain stone;** waterworn quartz found in the form of pebbles.

**raised line;** a term used to thin line which often executed with two other depressed parallel lines that give pseudo-feature of a raised thread-line between them.

**rajavaral;** a Sanskrit term for king beryl. Also called gujarati, rajanilam, rauhenayam.

**Raj Red Diamond;** a small diamond of brownish-orange color of 2.33 cts, believed to be originally from India.

**Rajah Diamond;** → Light of India Diamond

**Rajah of Matan Diamond;** same as Matan Diamond.

**rajanilam;** same as rajavaral.

**rakh;** a Farsi (Persian) term for cleavage. → Rekha.

**Raman effect;** a scattering effect of monochromatic light as it passes through a transparent medium. The scattered light is shorter in wavelength than the incident light caused by energy transformation, frequency

changes of some of the light in the addition of certain lines, such lines are called Raman lines to the spectrum, that is known as Raman spectrum. The Raman effect involves scattering of photons by molecules. Also called Raman scattering.

**Raman scattering;** same as Raman effects.

**Raman spectroscopy;** the study of the intensity of Raman spectrum in the infra-red light by means of a spectrometer.

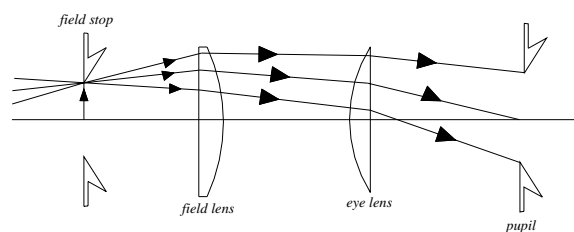
**Ramaura flux-grown synthetic ruby;** → Ramaura synthetic rubies

**Ramaura synthetic rubies;** a method of synthetic ruby, grown by a high-temperature flux-melt process with spontaneous nucleation, experienced by Overland Company Los Angeles, California, USA. Substantially is the same as the natural ruby. RI:1.762-1.770. Birefringence: 0.008. SG:3.94-4.00.

**Ramkharia;** location of alluvial diamond deposits along Baghin River, Majhgawan, India.

**Ramona Mine;** location of spessartite garnet in California, USA.

**Ramsden eyepiece;** a lens system consisting of 2 plano-convex lenses of equal power and focal length placed at



Ramsden eyepiece

separate distances of  $2/3$  focal length of either with their plane sides outward. Useful as eye-piece for cross-wire or scale, they have low spherical aberration and are fairly achromatic. → Huygenian eyepiece.

**rance;** same as rance marble.

**rance marble;** a dull red marble variety, with blue and white markings found in Hainault, Belgium. Also called rance, Belgian marble.

**rancid;** a taste or smell rank resulting from chemical change or decomposition. Also called rotten, odious.

**Rand Banket;** a gold mine in the Hoggar area, South-East Sahara Algeria, where some green diamonds were found.

**Ranjit Singh,** or Tiger of the Punjab, India. → Lahore Royal Treasury, Koh-i-Nûr Diamond, Jewels of India.

**rape oil;** same as rape seed oil.

**rape seed oil;** a viscous, unpleasant odor, brownish vegetable oil derived from the rape seeds, *Brassica napus* by expression or solvent extraction, used to

clarify cloudy amber. Soluble in alcohol. The amber immersed in warmed oil penetrates the air spaces that cause the cloudy appearance. Those clarified ambers in heated colza oil show some crack-like marks that resemble the nasturtium leaves and are known as *sun spangled*. Also called colza oil, rape oil. → Stress cracks in amber.

**rare-earth**; → rare-earth elements.

**rare-earth elements**; a group of fifteen metallic elements of the Periodic System with atomic number 57 to 71 inclusive, plus scandium 21 and yttrium 39. Possessing closely similar chemical and physical properties and resembling those of aluminum. They are trivalent, but similar to alkaline earth elements. They occur in monazite, bastnaesite or other rare minerals. Used as oxides and as color agent in synthetic gems. Also called lanthanides.

**rare-earth garnet**; a misleading term for non-silica synthetic stones that have garnet-like structures, containing rare earth metals oxides such as YAG, GAG, GGG, YIG, etc.

**rare-earth metal**; → rare-earth elements.

**rare-earth spectra**; spectral line of rare earth in a gemstone consisting of fine lines and not affected by the host.

**rare gas**; same as inert gas.

**rare white**; color grade for fashioned diamonds on the CIBJO and IDC color grading system equivalent in Scan. D.N. color system for top Wesselton and in GIA to G.

**rare white +**; color grade for fashioned diamonds on the CIBJO and IDC color grading system equivalent in Scan. D.N. color system for top Wesselton and in GIA to F.

**rarest white**; color grade for fashioned diamonds in Scan. D.N. color system for top river, equivalent to the color grading system of CIBJO and IDC for exceptional white + and exceptional white and in GIA to D and E.

**rarity of gems**; a term applied to criterion of value of a gem, appearing or occurring seldom which means there is only limited quantity of a gem mineral to find in the market, therefore the value is high because the few who can afford it. When discovered more sources the production increase and the price drops such as garnet minerals for hundreds of years mostly was produced from Czech Republic (Bohemian), which remained a highly prized stone. After discovery of another sources in other countries its price falls and never regained the same position.

**rashleighite**; an isomorphous mineral of turquoise and chalcocyanite  $\text{Cu}(\text{Fe}^{+3}, \text{Al})_6[(\text{OH})_2(\text{PO}_4)]_4 \cdot 4\text{H}_2\text{O}$ . Found in Arizona (USA), Saxony (Germany) and Cornwall (England).

**raspberry spar**; same as rhodochrosite.

**raspberry spar**; a misleading term for pink tourmaline.

**raspite**; → stolzite.

**Raspoli Sapphire**; a fine, flawless, brownish sapphire of 132 cts, in rough, known from the time of Louis XIV of France. Now on display in the Musée National d'Histoire Naturelle, Paris. Also spelled Rospoli, Rospogli, and Ruspoli Sapphire, the Wooden Spoon Seller's sapphire.

**rat**; a term used by Australian miners for an opal thief, who enter someone's shaft and take out hiding opal rock.

**rati**; an Indian/Myanmar (Burmese) unit of gemstone weight equal to 0.911 cts, named for scarlet seed of the licorice family. Also spelled ratti, rutee, and ruttee, → Mangelin and tola.

**ratio**; the numerical relation that one quantity has to another of the same kind.

**ratna**; a Singhalese term for gem.

**ratter**; a term used in Australia for opal thief.

**ratter**; another term for cannel coal used in Yorkshire.

**ratter**; some who (opal thief) enter someone's mine and take out hiding opal rock. Also called sandbagger.

**ratti**; same as rati.

**rauhennyam**; same as rajavaral.

**Raukshya**; a Sanskrit term used in past in India for defect grading of sapphire. → Sapphire, defects of in Hindu.

**Raulconda Diamond**; reportedly a diamond of 103 cts, have been seen by Tavernier at the Raulconda Mine in India.

**raw gypsum**; a term applied to unburnt gypsum.

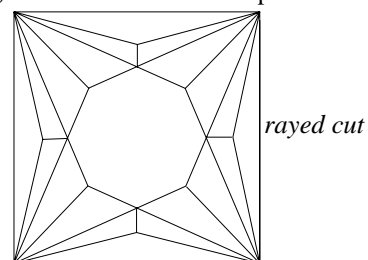
**raw minerals**; minerals that has undergone no manufacturing such as cut or polishing.

**raw quartz**; quartz that has undergone no manufacturing.

**ray**; a narrow beam of light, which emanate from a single bright source that proceed in one direction.

**ray**; an optical normal to the wavefronts, which indicate both the velocity and direction of propagation.

**rayed cut**; a modified faceted sharp-cornered square cut with



four-rayed star, 20 triangular facets and a large eight-edged table in the crown.

**rayed quartz**; → quartz rayed.

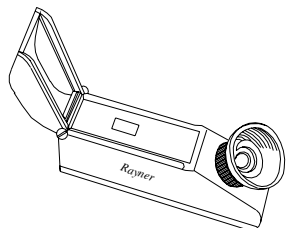
**Rayleigh scattering;** a fine blue schiller reflected from thin layer of moonstone plagioclase caused by interference of light.

**Rayner diamond gauge;** an instrument similar to Moe's gauge. → Diamond gauge

**Rayner dichroscope;** a dichroscope with a attachment for holding the stone during the observation.

**Rayner penlight torch;** a similar instrument to Hanneman penlight torch.

**Rayner refractometer;** a commercial term for a small



*Rayner refractometer*

pocket refractometer with a fixed prism of diamond, to determine the refractive index of gems up to 2.10.

**Rayner spectroscope;** a spectroscope developed by Rayner.

**Rayner diamond tester;** a commercial term for a diamond tester made by Rayner Optical Co., England.

**rayox;** a commercial term for titanium oxide.

**razor stone;** another term for novaculite.

**Rb;** a chemical symbol for the element rubidium.

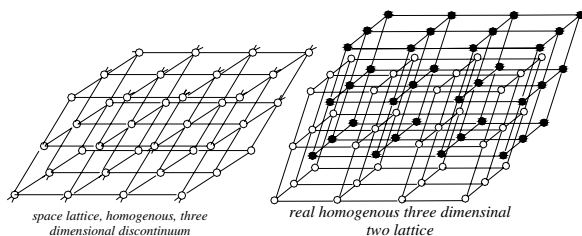
**Re;** a chemical symbol for the element rhenium.

**reactor, atomic;** → atomic pile.

**reagent;** in chemistry using a substance in assaying, floatation or in a chemical reaction.

**real amber;** a misleading term for a synthetic resin or plastic used to made beads and other ornamental objects represented to the natives as amber. Some pieces from Zanzibar may by are copal.

**real crystal;** especially identity or correspondence between appearance and essence of crystal in nature. This term related in crystallography to any departure of



*real homogenous three dimensional lattices*

a crystal from its ideal lattice and symmetry, which is often caused by vacancies, disorders, voids or stray crystal forms. Crystal lattice defect is usually described

as color center, where an electron or ion has been trapped. Hole centers in crystals that are formed by a negative ion vacancy with two bound electrons, which subsequent the color of minerals is known as F center. → Ideal crystal.

**realgar;** sometimes cut as gems and prized by collectors. Also called red arsenic.

System: monoclinic.

Formula:  $4[\text{As}_2\text{S}_4]$ .

Luster: resinous to greasy, adamantine.

Colors: dark orange-red, red, yellow.

Streak: orange-yellowish

Diaphaneity: transparent to translucent.

Cleavage: {010} perfect.

Fracture: conchoidal to uneven. Brittle.

SG: 3.50-3.60.

H: 1½-2.

Optics;  $\alpha$ : 2.538,  $\beta$ : 2.684,  $\gamma$ : 2.704.  $\ominus$ .

Birefringence: 0.166.

Dispersion: strong.

Found in Japan, Germany, the Czech Republic, Rumania, Nevada, Utah, and California (USA).

**realgar luminescence;** none, but decomposed on exposure to light.

**realgar pleochroism;** strong pale yellow to colorless pleochroism.

**real image;** a reproduction of an optical phenomenon or image formed at a point through, which the ray of light appear to come to the observer's eye but not actually, such an image can not be projected (or demonstrated) on a screen, camera or optical projector. The image can be seen in a plane mirror or through a diverging lens.

**Recent;** same as Holocene.

**recharge;** a term used for replenishment or nourishment of mineral or ore.

**reciprocal dispersion;** a term applied in optics to numerous values that express the deviation of an optical glass on light of different wavelengths or express the reciprocal of dispersive power. Also called Abbé number, constringence.

**reco;** → reconstructed ruby.

**recomposed;** ; same as reconstructed.

**recomposed rock;** ; a rock formed in situ by the cementation of the fragments, which produced due surface weathering.

**reconstituted;** same as reconstructed.

**reconstituted turquoise;** a misleading term for reconstructed turquoise.

**reconstructed;** also sometimes called reconstituted or recomposed.

**reconstructed amber;** same as ambroid or pressed amber.

**reconstructed emerald;** a misleading term for various



imitations of emerald such as glasses, smaragdolin, and other doublets.

**reconstructed flame-fusion rubies;** → Geneva ruby.

**reconstructed mica;** → micanite.

**reconstructed polymorphic reaction;** a term applied to transformation of crystal lattices such as aragonite to calcite.

**reconstructed ruby;** a misleading term for synthetic ruby. Also called reco. → Geneva ruby.

**reconstructed sapphire;** a misleading term for synthetic sapphire. → Geneva ruby.

**reconstructed stones;** a type of artificial gem consisted of fused fragments of a natural gemstone to make a larger stone, such as reconstructed ruby.

**reconstructed stones;** any artificial stone composed of concrete blocks, etc. faced to resemble true gemstone. Also known as precast stone.

**reconstructed turquoise;** a misleading term for imitation turquoise made of powdered ivory, which is cemented and stained in a solution of copper.

**reconstructed turquoise;** a term applied to bonded turquoise that is composed of mineral particles of turquoise, which are bonded together with a resin or synthetic plastic.

**recovery;** a general term for percentage of separated mineral, metal, gold, diamond or other ore obtained in the treatment after production.

**recovery mining;** a general term for percentage of separated gold or diamond or ore from product as value.

**recovery plant;** a facility developed for recovering of rough diamond particles from alluvial concentrates or crushed rock. Also called treatment plant, treatment and recovery plant.

**recrystallization;** the formation of new and purer crystal grains from pre-existing mineral grains in a rock by the diffusion of ions due to change of temperature and pressure condition, or composition of the rock. The new crystals may be kind of crystals new to the rock, or a variety of pre-existing crystal in rock.

**recrystallization;** same as fossilization of some shells.

**recrystallization;** changing the crystal fabric or grains so that the new grains have the same chemical and petrological composition as the pre-existing rock, such as fine calcite recrystallized to a coarse-grained marble.

**rectangle;** a parallelogram that has right angles.

**recut;** → recutting.

**recutting;** the style of refashioning a polished gemstone or diamond in order to enhance its clarity, proportions, remove the surface blemishes, repair damage, or modernize an old cut. → Repolishing, potentially flawless.

**Red Admiral Opal;** a black opal of 40 to 50 cts, from

Lightning Ridge district, New South Wales, Australia, found in 1920. It has play-of-color in a variety of vivid colors, the red color resembles that of the wing of a British butterfly. Synonym of Butterfly Stone. Present whereabouts unknown.

**red antimony;** same as kermesite.

**red arsenic;** same as realgar.

**red beryl;** same as morganite. A pale red-purple, rose, salmon to purplish red, cesium-bearing variety of beryl.

**red cobalt;** same as erythrite.

**red colored common opal;** another term for cherry opal.

**red coming out of the black;** a term used by Australian miners for red color pattern in black potch generally with a black background.

**red coming out of the blue;** a term used by Australian miners for red and blue color pattern when opal is moved.

**red copper ore;** same as cuprite.

**red coral;** same as blood coral.

**Red Cross Diamond;** a large canary yellow diamond of 375 cts, found in Griqualand, South Africa in 1900. Was cut into a 205.07 cts, square-shaped brilliant. After cutting it contained a curious feature like Maltese Cross was visible, when looking through the table. It was presented by London Diamond Syndicate to the British Red Cross in 1918. In 1973 it was sold by Christie's and again in 1977. Present owner unknown.

**red covered by blue;** a term used by Australian when the blue color pattern flow over pattern red as the opal is moved.

**red demons;** a nickname used in England by jet worker to polished jet with copperas, which gives the stone a reddish color.

**Re-dex;** a commercial term for reflectivity meter.

**Red Diamond;** a red, flawless emerald-cut diamond of 5.05 cts, was cut from a rough black diamond of 35 cts, found at Lichtenburg, Transvaal Province, South Africa, in 1927. Sold in 1970.

**red diamond;** a fancy color diamond term applied to natural diamonds of red-brown or rose-red body color.

**reddish chalcedony;** a trade term for carnelian.

**reddle;** another term for ocher.

**reddle;** an earthy, red variety of hematite mixed with clay. Also called red ocher, red ochre, ruddle, red ocker, red Japan earth.

**red earth;** a tropical red earth mixed with clay and moderately low in silica. Not to be confused with terra rossa. Also called red loam.

**red earth;** same as Pride of Australia.

**Red Emperor;** same as Pride of Australia.

**red flag effect;** a term used for red reflection seen in refractive index scale when reading is taken on the

crown of a garnet-glass doublet by using white light and examining with the loupe magnifier removed, while the red reflection become from bottom of gem.

**red flame opal;** a variety of precious opal, in which play-of-color is red, feature streaks over the entire stone.

**red glass;** glass melt containing about 1 % selenium and a minute amount of cadmium. It can also be produced by copper oxide or gold chloride, which is purple.

**red glassy copper ore;** same as cuprite.

**red gold;** an alloy of gold containing 25-50% copper, or copper and silver. Pure gold is yellow in color.

**red granite;** a variety of red granite from Egypt.

**red hematite;** a compact variety of hematite. Also called iron red ore, oligiste iron. Bloodstone, lapis hematite.

**red hot;** → incandescence.

**red in black;** a term used by Australian miners for red color pattern in black potch generally with a black background.

**red iron ore;** same as hematite.

**red jade;** a misleading term for a reddish variety of quartzite.

**red jade;** a misnomer for a quartzite variety containing red dumortierite.

**red jade;** an incorrect term for red dyed aventurine quartz that has been marketed as red jade, red tourmaline, topaz or pink jade.

**red jasper;** → jasper.

**red lead;** same as minium.

**red lead;** a bright-red, orange-red, which contains  $Pb_3O_4$ , which is used as an anti corrosive base and pigment. RI:2.40.

**red lead ore;** same as crocoite.

**red lead oxide;** same as minium.

**red limestone;** a term used in Devon, England. Also called trug.

**red limonite;** a term used for reddish limonite.

**red litharge;** another term for litharge a yellowish or reddish monoxide of  $PbO$ .

**red loam;** same as red earth.

**redmanol;** a phenol resin somewhat like bakelite.

**red ocher;** same as hematite. → Red hematite.

**red ogwell marble;** a red limestone marble variety containing white fossil coral known as favosites found in Devon, England.

**red on blue;** a term used by Australian for red color pattern in foreground flow over blue pattern in background.

**red-ore;** same as hematite ore.

**red orpiment;** same as realgar.

**redox;** an acronym for oxidation-reduction process.

**red oxide of copper;** same as cuprite.

**red oxide of zinc;** same as zincite.

**red Peking-jade;** same as rose-jade.

**redruthite;** same as chalcocite.

**red schorl;** a local misleading term used for rutile in Pennsylvania, USA.

**red schorl;** a misleading term for rubellite tourmaline.

**Red Sea;** a long, narrow arm of the Indian Ocean between Arabia and Northeast Africa with a connection to the Mediterranean Sea through Suez Canal. The pearls from here are salt-water bivalve mollusks of genus *Pinctada*.

**Red Sea pearl;** pearls from pearl oyster genus *Pinctada* are salt-water bivalve mollusks from the southern end of Red Sea, marketed mostly through Madras, India.

**Red Sea pearl;** once a misleading term used for coral beads.

**red sea pearl;** a misleading term for coral beads from Red Sea.

**red shift;** a term used in spectrometry for displacing of Fraunhofer spectral lines toward the end of the spectrum. Because in more distance the velocity up to 140.000 km/sec measured. Also called Doppler effect.

**red shifting;** → bathochromic.

**red silver ore;** same as proustite.

**red South Africa garnet;** a misnomer for adelaide ruby from South Africa.

**red spinel;** → spinel.

**red stone;** a commercial term for red-colored sandstone.

**red stones;** naturally occurring red gemstones are almandine, pyrope, ruby, spinel, topaz, tourmaline, zircon, etc.

**red-stuff;** an English term applied to rouge.

**red tides;** a yellow to reddish, poisonous warm sea-water bloom of plankton micro organism group called *dinoflagellates*, which is a natural enemies for oysters and other marine animals which chokes the oysters. Found on the coast of California and Florida.

**red top moss agate;** a variety of mocha stone with blackish dendritic inclusions at top and red stain at base found in Montana, USA.

**red topaz;** a term used for red topaz, which is misnomerly known as Brazilian ruby.

**red topaz;** a misleading term for red-dyed quartzite.

**red tourmaline;** same as rubellite.

**red tourmaline;** misleading term for red-dyed quartzite.

**red tourmaline;** a misleading term for Siberian ruby.

**red vitriol;** same as cobalt vitriol.

**red zinc ore;** same as zincite.

**reduction;** reaction with chemical change, in which the oxygen is removed. Also called deoxidation.

**reduction;** the addition of hydrogen to a compound.

**reduction;** chemical reaction where an element gains

one or more electrons.

**reef**; a local term for a metalliferous mineral deposit such as gold-bearing quartz.

**reef**; a term applied to rock mass surrounding a diamondiferous kimberlite rock.

**reef**; any off shore rock or chain of rocks that occurs at or near the surface of the water.

**reef lattice**; same as growth lattice.

**reef limestone**; a limestone which built up on the remain of active reef organism such as coral, sponges, bryozoans and calcareous algae.

**re-entrant angles**; a characteristic angle between two plane surfaces on a twin crystal, in which the external angle is less than  $180^\circ$ .

**reflectance**; → reflectivity, reflection.

**reflectance meter**; → reflectivity meter.

**reflected polarized light**; → polarization of light.

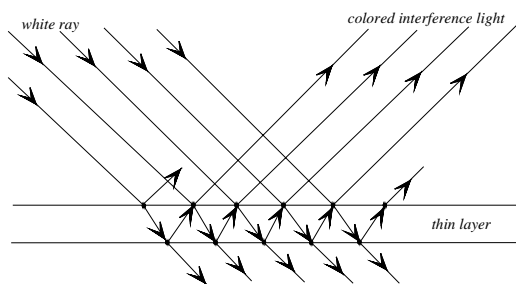
**reflected refraction**; reflection of light waves which are reflected back towards the incident light.

**reflecting goniometer**; same as goniometer.

**reflecting plane**; in crystallography same as plane of mirror symmetry. Also called mirror plane.

**reflecting prism**; in optic same as mirror prism.

**reflection**; the turning back of wave from surface, on which they are incident according to the definite *law of reflection*. A small part of ray 17.2% of incident light striking the surface vertically is reflected from the



incidence light, reflection, refraction and interference

surface (the 17.2% is upper limit of reflected light of diamond depends on perfect plane and well polished surface where for quartz is 4.6%) back into the air but greater part refracted into the stone, which may be internally reflected from the facets within the gemstone. Generally both part of reflected light together resulting the luster for example adamantine luster by diamond. → Law of reflection, total reflection, law of refraction, goniometer, reflectivity meter. Also called reflexion.

**reflection**; in crystallography same as atomic structure of crystal. Also called reflexion.

**reflection angle**; → reflection, angle of reflection.

**reflection, angle of total**; → angle of total reflection.

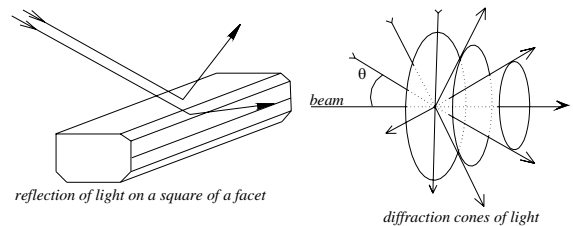
**reflection grating**; a device in optical spectroscopy for

reflecting grating made of a transparent base by which radiation reflected through the grating instead of transmitting. This is used in some types of spectroscopes.

**reflection, law of**; → law of reflection.

**reflection of light**; a property of smooth or polished gems reflecting or returning the light rays, which strike a surface according to definite *law of reflection*.

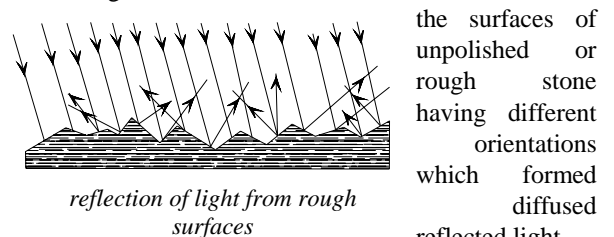
**reflection of light on facet**; reflection of light on the smooth or polished facets of a stone caused when the light strike the larger surface of stone according to definition of *law of reflection*, but reflection on the



reflection of light on facets and conical effect

minute facets happen with some distance later as seen in the figure because the reflected light has larger incident angle therefore reflected with larger angle. This effect is seen in needlic crystals, which caused asterisms. When more minute faces are adding to the facets of the stone it will be reflected as conical pattern similar to X-ray cone.

**reflection of light from rough surfaces**; light reflected from rough surfaces in different directions because on



reflection of light from rough surfaces

the surfaces of unpolished or rough stone having different orientations which formed diffused reflected light.

**reflection pleochroism**; same as bireflectance.

**reflection, total internal**; → total internal reflection.

**reflection, total**; → total internal reflection.

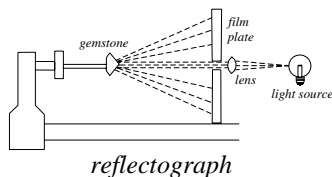
**reflectivity**; the ratio of the returning light from a surface, on which there are incident according to definite *law of reflection*, which is reflected from a perfect plane and well polished surface of incident light on a material of sufficiently thickness that there are no change of reflectance with increase in thickness but depends upon the material such as diamond with 17.2% reflection of and 4.6% for quartz. Reflectivity is measured by means of a reflectivity meter made by several manufactures. Also called reflectance. → Law

of reflection, reflectivity meter.

**reflectivity;** specular property of certain opaque minerals such as specularite.

**reflectivity meter;** an electronic apparatus for measuring the approximate reflectivity of a smooth surface of a gem based on the Fresnel relationship between reflectivity and refractive index. The measuring happens by using an infra-red light of wavelength of nearly 930 nm emitted by using gallium arsenide light-emitting diode with abbr.: LED (diodes and photo-detectors), which is reflected from the surface of the stone. Reflectivity meter is useful for gemstones with refractive indices above the range of the critical angle of standard refractometer RI:1.81, which ranges from 1.40 to 3.20 with an accuracy of  $\pm 0.02$ . Suitable for identification of diamond from diamond imitations. The result depends on cleanliness of the surface, scratch free, well polish, internal reflection, refractive index, dispersion. Flatness of the stone, which is now not necessary, while recent development with focused fiber wire make it possible to test cabochon cut stones. Results of reflectivity meter are not 100% accurate or repeatable and do not determine birefringence. Also called reflectance meter or commercially known as Re-dex. → Refractometer.

**reflectograph;** a device for reflection photography from facets of a gemstone by using striking incident light on the mounted stone.



reflectograph

During the reflection of the light from the smooth surface of a polished gemstone this can be observed on the screen or by using

a photography film can the reflection intensity of the stone measured. This instrument is not more in use.

**refractometer;** more correct term for refractometer. A device to determine the refractivity of materials. Same as total refractometer. → Reflectivity meter.

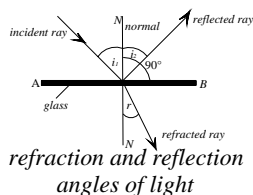
**reflector;** a term applied to multiple reflection effect that can be seen in a brilliant-cut diamond caused by an inclusion, when viewed through the table the image appears in more than one facet.

**reflector;** any surface that reflected views, particularly electromagnetic rays.

**reflector;** a brilliant-cut diamond that shows multiple reflection on an inclusion, when viewed through the table. → Relief.

**reflexion;** same as reflection.

**refraction;** the change of direction and velocity of propagation of any wave or ray of light, when it passes from one medium into another of different optical density as from air into a gemstone. The greater the



refraction and reflection angles of light

difference in the optical densities of two media, the greater will be the angle of refraction and reducing of speed. → Double refraction,

index of refraction.

**refraction angle;** → angle of refraction.

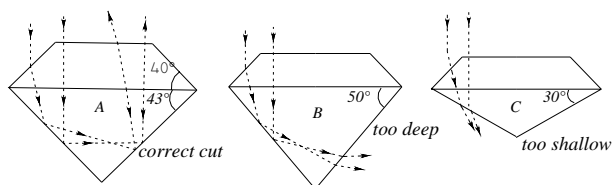
**refraction, angle of;** → angle of refraction.

**refraction anomaly;** refraction anomaly produced in transmitted ray by differences in anisotropy or density in unit of cell of a crystal. → Crystal anisotropy.

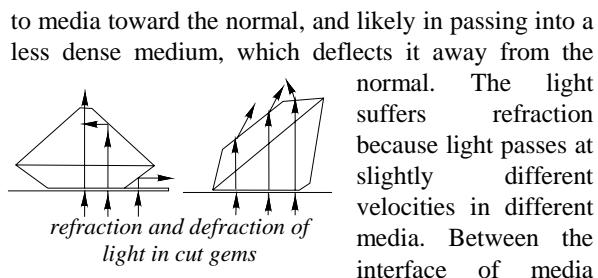
**refraction, double;** → double refraction.

**refraction, law of;** → law of refraction.

**refraction of light;** the change of direction and speed of light, when it travels obliquely from one medium into another, it is bent or refracted at the surface separating



refraction of light in cut gemstones and its effects. A: showing how correct angles of cut stone are. B and C showing incorrect angles will result in serious losses of light through the base of the gemstones



to media toward the normal, and likely in passing into a less dense medium, which deflects it away from the normal. The light suffers refraction because light passes at slightly different velocities in different media. Between the interface of media

there is a slight change of wavelength.

**reflection pleochroism;** same as bireflectance.

**refractive;** an optical quality to refracts.

**refractive index;** → index of refraction.

**refractive indices of glass;** the refractive index of glasses varies over a great range and some samples overlap those of natural gemstones. The refractive index of glasses extend from 1.44 to 1.70.

**refractive index measurement;** several methods are available for the measurement of refractive indices such as refractometer for total reflection, immersion method in liquid for Beck effect, shadow method, and minimum deviation method.

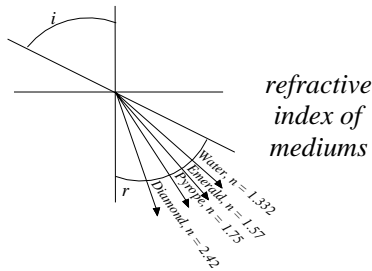
**refractive index measurement on curved surface;** →

distant vision method.

**refractive index measurement by immersion;** → distant vision method.

**refractive index measurement by minimum deviation;** → minimum deviation.

**refractive index of mediums;** here are some typical



refractive indexes:

table 14 : refractive index of mediums

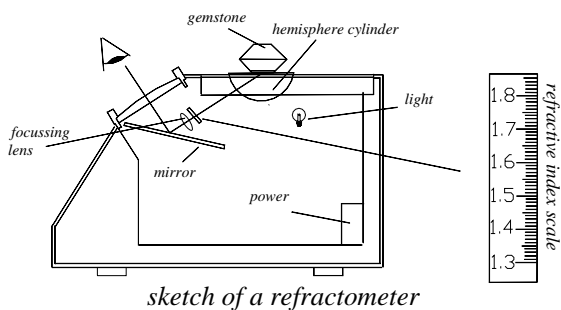
medium	refractive index
oxygen	1.000272
air	1.000293
carbon dioxide at 0° C	1.000450
water at 25° C	1.332000
ethanol at 25° C	1.359000
fluorite	1.430000
quartz	1.54-1.55
glass	1.50-1.70
pyrope	1.74-1.75
diamond	2.417300

→ Index of refraction, immersion liquids.

**refractive index of plastics;** refractive index range of 1.46-1.70. → Plastics properties.

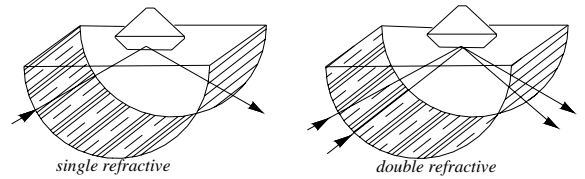
**refractivity;** an optical quantity of a gemstone has to refract light, which can be expressed  $(n-1)$  where  $n$  is the refractive index. Also called specific refractivity. Synonym for refractive power, refringence.

**refractometer;** an optical apparatus for the



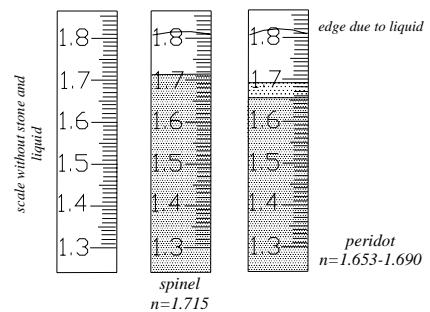
measurement of the refractive index (RI) of any substance, either liquid or solid. Usually determines the critical angle of total reflection as a shadow edge at the

surface between liquid and a hemisphere prism of known highly refractive index. *Critical angle* is that



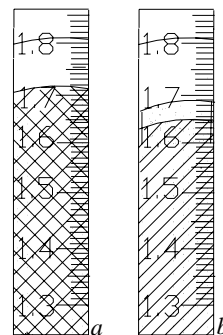
refractive index reading in a hemisphere by single and double uniaxial crystal

angle, at which a ray of light is passing from a dense medium such as a gemstone to one less dense, is reflected at an angle of 90 degrees to the normal. For



scale of a refractometer in three condition

determination the refractive index of a gemstone it is placing with the facet or a flat smooth face in contact with the reflecting surface of the hemisphere prism. To obtain a good contact between stone and hemisphere prism, a drop of certain contact liquid of highly refractive is placed on the surface of the prism. The calibrated scale of the device can read by eyepiece,



a: reading shadow edge by singly refractive spinel stone. b: shadow edge given by doubly refractive peridot stone by using monochromatic light

which is divided into two part of bright and shadow illuminated. The bright part represents the total reflection and the shadowed portion the reflected rays from the gemstone. The standard refractometers with glass hemisphere prism can measure the stone with refractive indices (RIs) below 1.70, to achieve higher ranges refractometers with hemicylinder of spinel are

used (1.726), blende, diamond, synthetic cubic zircon, or synthetic strontium titanate. The refractive index of cabochon or curved surface gemstones can be read on the refractometers by using the *distant vision method*. Using of monochromatic light and revolving stone or prism may be obtained the birefringence This means the highest and the lowest refractive index. → Abbé-Pulfrich-totalrefractometer, Bertrand refractometer, Dialdex refractometer, Erb and Gray refractometer, Herbert Smith refractometer, Rayner refractometer, spinel refractometer and Tully refractometer.

**refractometer,-Abbé-Pulfrich;** → Abbé-Pulfrich-totalrefractometer.

**refractometer, Anderson-Payne;** a special refractometer incorporating synthetic spinel, blende, and diamond hemicylinder to obtain higher refractive index.

**refractometer, Bertrand;** → Bertrand refractometer.

**refractometer, blende;** → zinblend refractometer.

**refractometer, bright-line reading on;** → bright-line reading on refractometer.

**refractometer, color fringes on;** most of pastes may be detected by their strong and wide fringed color, shadowed edges or by using a synthetic spinel refractometer.

**refractometer, Dialdex;** → Dialdex refractometer.

**refractometer, distant vision of reading;** → distant vision method.

**refractometer, Erb & Gray;** → Erb & Gray refractometer.

**refractometer, function of;** → refractometer.

**refractometer, gem;** → refractometer.

**refractometer, Herbert Smith;** → Herbert Smith refractometer.

**refractometer, Kerez effect of tourmaline on;** → Kerez effects.

**refractometer, liquids for;** → immersion liquids.

**refractometer, monochromatic filter for;** → monochromatic filter.

**refractometer, Rayner;** → Rayner refractometer.

**refractometer, satellite readings;** → float, Kerez effects.

**refractometer, shadow edges visible on;** → refractometer.

**refractometer, spinel;** → spinel refractometer.

**refractometer, Tully;** → Tully refractometer.

**refractometer, zinblend;** → zinblend refractometer.

**refractometry;** the measurement of the refractive index (RI) of any substance, either liquid or solid with refractometer.

**refractory;** a term applied to calcitrant of certain ores or minerals.

**refractory clay;** same as fire clay.

**regal;** a term used frequently for aventurine.

**regalaire;** a commercial term for synthetic YAG, used as a diamond imitation.

**Regale of France Diamond;** a legendary diamond as large as a bird's egg, belonged to Louis IX of France, who exchanged the stone for a lead figure of St. Thomas à Becket, in England. Present whereabouts is unknown.

**Regalia, British ;** → British Crown.

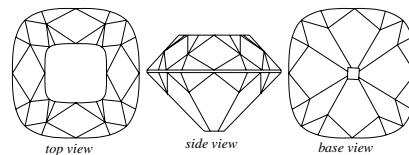
**regal jade;** same as Indian jade.

**Regency synthetic emerald;** a variety of synthetic emerald manufactured by the hydrothermal method. Optics;  $\omega$ :1.570,  $\varepsilon$ :1.576. Birefringence: 0.006. SG:2.67-2.69.

**regeneration of;** undergo a process of restoring a stone to regain its earlier condition.

**regeneration of heated opal;** some fire opals loose their play-of-color such stones are placed in water under high vacuum (700 mm) between 8-12 days sometimes repeatedly, the water content is restored and the stones regained their earlier fire.

**Regent Diamond;** a cushion-shaped brilliant diamond of 140.50 cts, cut from a rough stone of 410 cts, believed to be from Partaal Mine, India. Found in 1701



*Regent Diamond*

and purchased in 1702 by Thomas Pitt governor of Madras, Pitt was originally the name of the stone. It was bought by

Philippe II (1674-1723), Duc d'Orleans, Regent of France in 1717. Later it was mounted in a crown, which was worn by Louis XIV. It was stolen in the robbery from Garde Meuble along with other royal regalia in 1792 but was found again and mounted in the sword of Napoleon I for his coronation in 1802. In 1887 it was reserved from an auction of the French Crown Jewels. It is now on display in the Apollon Gallery of the Louver Museum, Paris. Sometimes called Millionaire Diamond, Pitt Diamond.

**Regent of Portugal Diamond;** reportedly a Brazilian gems-diamond found about 1775, which was cut into a circular brilliant of 215 cts, thought to be a topaz.

**Regent Pearl;** another spelling of La Régente Pearl.

**regional metamorphism;** the alteration of rock caused mainly by heat and high pressure over an extensive region, always associated with orogenesis. → Metamorphism.

**Registered Jeweler;** a certificated title awarded by the

American Gem Society to qualified retail jewelers. → Certified Gemologist.

**regular;** a sorting grade for a rough perfect-formed octahedron diamond crystal.

**regular;** a term applied sometimes to a medium quality of drill diamonds.

**regular reflection;** same as specular reflection.

**regular system;** same as cubic or isometric system.

**Reichenau Abby Emerald;** same as Benedictine Abbey Emerald.

**reindeer stone;** a literally name for tugtupite, while the term Tugtup in Greenland means reindeer.

**Reine Diamond;** → La Reine de Belges Diamond.

**Reitz Diamond;** same as Jubilee Diamond.

**reject;** → malaya.

**rejection;** very spotted rough diamond, which is only just good for cutting and polishing because it contains more inclusions, cracks, etc.

**rejection;** a clarity grade of polished diamonds. Also called rejection stone.

**rejection chip;** a miners grading for poor quality, minute, misshapen rough diamond crystals or a broken pieces.

**rejection stone;** same as rejection.

**rekha;** an Indian term for streak in emerald. May be that this term were used for cleavage because of its similarity to Farsi, (Persian) term *rakh*, which means cleavage.

**relation between refractive index and density;** → refraction.

**relative density;** another term for specific gravity in connection with liquids.

**relative index of refraction;** the ratio of velocity of light in one crystal to that in another crystal that give an index of refraction. Also called relative refractive index.

**relative refractive index;** same as relative index of refraction.

**relief;** a clarity grading of diamond. Inclusions in diamond provide a high relief, meaning they have a greater effect than low-relief inclusions. → Reflector.

**re-louse;** an informal term used by Australian miners for to go through the opal dirt on the ground for the second time because may be opal has been dropped.

**Rembrandt Diamond;** reportedly a black diamond of 42 cts, cut from a rough stone of 125 cts. Named after famous Dutch painter Rembrandt van Rijn. Present owner unknown.

**remineralization;** changing or restoration of mineralization.

**remolinite;** another name for atacamite.

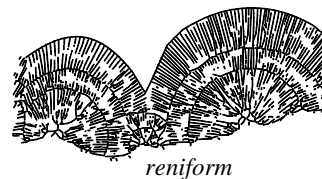
**removal of blue color of sapphire;** color removal of dark blue or inky sapphire, purplish and greenish-

yellow sapphires happen by 800-1900° C in an oxidizing atmosphere. → Heat treatment of sapphire and ruby.

**removal of silk of sapphire;** removal of cloudy silk in sapphire happen by 1000-1900° C and cooling rapidly. → Heat treatment of sapphire and ruby.

**renfrew;** a fine-quality prehnite mined in Renfrew, Scotland.

**reniform;** a mineral, in which radiation aggregates terminate in a rounded mass with smooth, hummocky rounded surface. Also called kidney-like, kidney shaped. → Mammillary.



**repeated twin;** same as repeated twinning.

**repeated twinning;** in crystallography successive twinning of more than two individuals of a crystal according to the same twin law and on parallel composition planes such as trilling in alexandrite. Same as polysynthetic twinning. Also called repeated twin.

**repelling in diamond;** have no affinity as in electric charge repels another charge such as in diamond there is a repelling between bands.

**repen zola;** a crinoidal limestone from peninsula Istria, Croatia. It was misnomerly known as *Roman stone*.

**replaceability;** same as ionic substitution.

**replacement;** the fossilization process; in which an organic constituents has been entirely or partially replaced by an inorganic matter such as silica for example agate or opal, replaces other organic substances. → Fossilized agate.

**replacement;** same as substitution, diadochy.

**replacement;** same as metasomatism.

**replacement by silica;** → replacement.

**replicas;** natural replica or reproduction of a fossil or other object with its exact size and shape.

**replicas;** replicas from famous gemstones or diamonds made from glass, quartz, citrine, or synthetic spinel.

**replicas;** an exact copy of an objects.

**replication;** → reproduction.

**replique;** a commercial term for synthetic YAG, used as diamond imitation.

**repolishing;** repolishing of a diamond or gemstone to remove its small faults in formerly proportion or clarity. → Potentially flawless.

**repoussé;** a technique used to make relief decoration on gold and silver thin plate of an image by punching and hammering from the reverse pre-designed side into a raised form. Also called embossing.

**reproduction;** the process of generation of an article that is a new copy of an original stone, this application

is without any intent to defraud. It include synthetic stones, reconstructed stones, and less, accurately, cultured pearls. Imitation articles are excluded, while they are not reproduction because they differ physically and chemically from genuine stones.

**reptilian age;** → Mesozoic.

**resembling jasper;** another term for jasperoid.

**reserve mining area;** prospected and also geologically and mineralogically known deposit but at the present not been worked.

**Residenz Museum, Munich;** → Bavarian Imperial Treasury.

**residual bond;** in bonding, a very weak electrostatic attractive forces between polar crystals or molecules or noble-gases. Also called van der Waals bonds.

**residual color;** difference between an observation color and true color of stone for instance the white color is composed of all the colors of the rainbow. A colored stone owing its color to light falling upon or transmitted trough it. Those rays that are absorbs are not visible to the eye but those rays, which are visible to the eye are called residual color. Residual color included the optical effects luminescent, dispersion, and internally reflection.

**residual deposit;** same as eluvium.

**residual induction;** same as residual magnetization.

**residual magnetization;** magnetization persisting in a ferromagnetic mineral or crystal when magnetizing force is removed.

**residual mineral;** an accumulation of mineral debris produced in place by the weathering and leaching of rock such as quartz.

**residual ray;** a term applied to almost metallic reflection of a crystal or mineral that occurs in otherwise nearly transparent crystal by which either the refractive index or the absorption coefficient is large.

**resin;** any of several amorphous carboxylic acids, essential oil and terpenes occurring as solid or semisolid as exudations on the bark of certain trees; pine or fir. Hard, brittle, translucent to opaque with a characteristic luster. Yellow to brown color. Conchoidal fracture and nonconductive. Synthetic resins are produced in many colors. The term is now applied to any natural or synthetic plastic substance. Also called, natural resin and hydrocarbon mineral. → Fossil resin.

**resine;** a synthetic wax that produced by bleaching of ozocerite.

**resin anchor;** chemical anchor, capsule anchor.

**resin damar;** → dammar.

**resinoid;** a commercial term for any thermoplastic synthetic resin such as bakelite.

**resin opal;** a honey-yellow common opal variety with a

resinous or waxy luster. Also called pitch opal.

**resinous;** resembling resin such as amber, garnets or yellow variety of sphalerite.

**resinous luster;** the reflection of light from certain mineral such as amber, garnets or sphalerite. It is dull but definitely shiny. → Luster. Also spelled resinous lustre.

**resinous lustre;** same as resinous luster.

**resins, artificial;** → resins,-synthetic.

**resins, synthetic;** an artificially amorphous organic polymer, which is the result of several molecules generating a new compound, usually with heat or a catalyst, which can be molded by heat or pressure, or both, such as bakelite, or lucite. Synthetic resins or plastics are classified into thermoplastic and thermosetting materials plastics. Also called resins,-artificial.

**resistivity;** a specific electrical resistance offered by a material or stone to the flow of current. It is a constant for any mineral or material equal to the reciprocal of its conductivity ( $\rho$ ). The unit of resistivity is ( $\Omega$ ) ohm/centimeter. Also called electrical resistivity.

**Resoglanz;** a commercial name for polystyrene made in Germany.

**resolution of microscope;** same as resolving power of microscope.

**resolving power of microscope;** a quantitative ability of an optical system or microscope to create detectable separate image of objects, which are very close together or can distinguish small particles. The human eye can detect objects of about 100 micron ( $\mu$ ). Also called resolution of microscope.

**resonance;** a term used in chemistry for aromatic compounds such as benzene. Describing of the structure of a chemical compound of definite valence state of its atoms with their whole numbers of valence bonds between the atoms of a molecule such as benzene, which represented five different resonance structures. Next sample is crystal violet with a resonance structure depend between two structures. Also called mesomerism, resonance forms, resonance hybrid.

**resonance;** a term used in physics to a system capable of an oscillation of a system, it means a small period as a frequency of vibration.

**resonance fluorescence;** → resonance radiation.

**resonance forms;** → resonance.

**resonance hybrid;** → resonance.

**resonance luminescence;** → resonance radiation.

**resonance radiation;** a spectrometry term applied to emission of radiation from gas or vapor when excited by photons of higher energy will now again re-emit light of same energy with the same color, but with the



difference that it is a re-emitted light which can be seen in sodium vapor absorption. Also called resonance luminescence, resonance fluorescence.

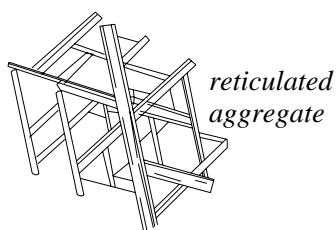
**Retail Jeweler of America, Inc.;** a national commercial association that was founded in 1957. Headquarters for this society are located at: 1025 Vermont Ave., NW, Washington, D.C. 20005, USA. Abbreviation: RJA.

**retardation;** a term used in optics for a rate of decrease of speed, or velocity of light.

**Retger's salt;** a solid compound at ordinary room temperature salt of thallium silver nitrate, melts to a yellow liquid of density 4.60 at 75 C. Lower specific gravity by dilution with hot water.

**reticule;** any wires, cross hairs, threads, dots, or very fine edged lines placed in the eyepiece of a microscope or other optical instrument perpendicular to its principal focus.

**reticulated;** a form of mineral or rock texture of



meshwork or network of intercalating crystals such as rutile needles.

**retina;** consisting of light sensitive or detecting layer of the eye, these cells are in the form of rods and cones, which is backed by a layer of antireflection pigment, choroids and fibrous sclera. → Eye.

**retinalite;** a honey yellow to light-green, massive, translucent variety of serpentine with resinous luster. Also known as *noble serpentine* or *precious serpentine*. → Serpentine.

**retinite;** a commercial term for a large group of fossil amber resins of variable composition attributed by amber appearance and absence of succinite. Also termed bentonite.

**retinol;** same as vitamin A<sub>1</sub>.

**retrogradic metamorphism;** a type of poly-metamorphism by which a rock of higher metamorphic grade converted to one of lower grade at the expense of minerals which are of a lower grade in response to a change in physical condition, such as lower temperature. Also called diaphoresis, retrogressive metamorphism.

**retrogressive metamorphism;** same as retrogradic metamorphism.

**return streamer;** when lightning streamer approaches and met positive ground in which the streamer ascend from the ground to its cloud base. By striking, the

ground may form fulgurites or lechatelierites when quartz is present on the ground. Also called return stroke.

**return stroke;** same as return streamer.

**Retzius, lines of;** → line of Retzius.

**re-using;** a term applied to the Chinese technique for producing of cultured pearl, which used now in several countries.

**revealing fracture filled diamond;** filled fractures with high refractive materials such as epoxy or lead-based glass and capable of obscuring the tiny cleavages, some resins, opticon and oil can be revealed by examining und magnifier or microscope. In filled diamond heavy metal of glass can reveal due to: (a) *orange flash* or *purple flash* interference by testing under dark-field illumination, (b) *blue flash* or *green flash* interference by testing by rotation the stone into a position when the background seen bright, (these two *flash effect* can be seen in untreated fractures of stones), (c) looking like *filled cracks* of dried river, (d) having a *melted flow* structure in filled breaks, (e) *flattened trapped* gas bubbles in filled portion.

**revealing fracture filled emerald;** filled dehydrated cracks or crazing on surface of emerald with oil or wax flaws are visible under lens examination after the oil is washed out with alcohol or benzene.

**revealing fracture filled tourmaline;** flaws filled with wax are visible under lens examination.

**reversals;** a term used for dyed black pearls which are soaked in a weak liquid of silver nitrate, placed under ultraviolet light or sunlight due to reducing of silver by action of organic constituent. The dried silver give to the pearl the hue of black that is known as *buffed up*, which means improving the color of pearls by staining. Radiographic negative film from this pearl shows this effect as faint white lines because the reduced silver nitrate at the drill hole give lighter effect like a white line, which is termed as reversals.

**reverse bias;** the both electrons and holes in a semiconductor substance are as opposite polarity field and moved backward from the junction region with of flow electricity such as in semiconductor diode. It is a relationship of *p-n* semiconductor junction or *n-p-n* or *p-n-p* configuration, which produced small current.

**reverse cabochon;** a term used to a rarely style of cutting cabochon with domed top and with a cone cave depression in it, usually the bottom is flat. It is often applied to produce unusual optical effects such as synthetic star sapphire.

**reverse effect;** piezoelectric effect that can be produced by application of a voltage between certain faces of a suitable cut plate of a piezoelectric crystal, which generates mechanical stresses and alters the length and

thickness of the material.

**reverse intaglio crystal;** shallow cabochon made of crystal with the carved intaglio on the bottom. The motif is practically painted and surrounded by a transparent mass. Used as brooch, pendant, button, studs, tie pins, etc. Frequently misnomered as Essex crystal, or Wessex crystal.

**reversible;** capable of being reversed by going through a series of changes in both directions (forward or backward).

**Rh;** a chemical symbol for the element rhodium.

**rhaetizite;** a local term for white variety of kyanite found in Pfitschtal, Tyrol, Italy.

**rhenum;** a hard, silvery-white metal, resembling platinum, resistant to corrosion of the Periodic System with the symbol Re.

**Rhine diamond;** a misleading term for colorless quartz crystal.

**Rhine diamond;** a misleading term for colorless beryl.

**rhinstone;** usually rolled pebbles of rock-crystal from Baden, Rhine River Valley, Germany.

**rhinstone;** a commercial term for colorless, iridescent lead glass used as a diamond imitation or other gemstone, sometimes it has been backed with a film of metallic foil. Used as a colorless paste.

**rhinoceros horn;** the horn of large, thick-skinned, mammals of family *rhinocerotidae*. Characteristic of a mass of molted or banded horny fibers appearance, which growing from the skin of the animal. SG:1.29. Low hardness about 2. Used as ivory in China for various decorative ornamental objects.

**rhinoceros skin;** → elephant hair.

**rhodamine B;** a synthetic green crystal or reddish violet powder of  $C_{28}H_{31}ClN_2O_3$ . Soluble in water, alcohol with bluish red fluorescence in solutions. Slightly soluble in alkalis or acid. Used as dyes and in laser dye with the wavelength 580-655 nm. → Oxazine 9.

**rhodamine 6G;** a brilliant, synthetic, organic compound, yellowish red basic dye. Used as dyes and in laser dye with the wavelength 450-605 nm. → Oxazine 9.

**Rhodesian moonstone;** a commercial term for translucent bluish white quartz from Zimbabwe (Formerly Rhodesian), Africa.

**rhodium;** a hard, silvery-white, ductile, metallic element, resembling platinum, resistance to corrosion of the Periodic System with the symbol Rh. Used as alloys and coating of silver to prevent tarnishing.

**rhodium plating;** coating of other metal objects in jewelry to improve the color and appearance.

**rhodizite;** a very rare gem mineral from Malagasy faceted as gemstones and prized by collectors. Weak yellow luminescence under SWUV light. Strong green

to yellowish fluorescence under X-rays.

System: cubic.

Formula:  $(Cs,K,Rb)Al_1Be_4[B_{11}O_{26}(OH)_2]$ .

Luster: vitreous to adamantine.

Colors: colorless, pale yellowish, yellowish white to yellowish gray, pale rose.

Streak: colorless.

Diaphaneity: transparent to translucent.

Cleavage: not diagnostic.

Fracture: conchoidal to uneven. Brittle.

SG: 3.36-3.44.

H: 8-8½.

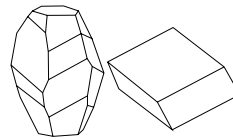
RI: 1.694.

Dispersion: 0.018.

Found in Malagasy, Africa, and Russia.

**rhodizite luminescence;** weak yellow luminescence under SWUV light. Strong green to yellowish fluorescence under X-rays.

**rhodochrosite;** isomorphous with calcite and siderite. The color rising with increasing of iron. Brown and yellow colors caused by calcium and manganese. An usually banded, massive, stalactitic, stalagmitic aggregate, attractively banded in



*rhodochrosite crystals*

various shades of pink and white. It occurs together with braunite and bixbyite found in Kalahari Desert, Cape Province, South Africa. Cut cabochon, and into bead-like articles. Is has fancy commercial names: The banded variety is known as *Inca rose* or *rosinca*. Also called dialogite, raspberry spar, manganese spar, capillitite, ponite, carbonate of manganese, manganosiderite.



*banded rhodochrosite under microscope*

System: hexagonalic.

Formula:  $2[MnCO^{+3}Fe,Ca]$ .

Luster: vitreous to pearly

Colors: shades of pink, rose, rose red, yellow, orange red, brown, gray, black.

Streak: white.

Diaphaneity: transparent, translucent to opaque

Cleavage: {1011} perfect rhombohedral.

Fracture: uneven to conchoidal. Brittle.

SG: 3.40-3.60.

H: 3½-4.

Optics;  $\omega$ : 1.786-1.840,  $\epsilon$ : 1.578-1.695.  $\ominus$ .

Birefringence: 0.201-0.220.

Found in Argentina, Mexico, Rumania, Germany, South Africa, Peru, and Colorado (USA).

**rhodochrosite absorption spectrum;** the absorption spectrum shows a band at 551 nm and a band at 415 nm and two weak lines at 535 and 565 nm.

**rhodochrosite cut;** cut cabochon, bead-like articles, and faceted gems

**rhodochrosite luminescence;** medium red under LWUV. Dull red to violet glow under SWUV light in Argentina and Colorado, USA rhodochrosite.

**rhodochrosite pleochroism;** shades of dark red.

**rhodoid;** a commercial term for a non-flammable artificial resin used as an amber imitation. RI:1.49 and SG:1.28.

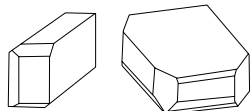
**rhodoise;** a synonym for erythrite.

**rhodolite garnet;** a commercial term for purplish-red to rose-purple, transparent, brilliant variety of garnet with a composition between pyrope and almandine. Ratio of Mg:Fe 2:1. Cubic system. Vitreous luster. RI:1.740-1.770. Dispersion:0.026. SG:3.79-3.80. H:7-7. Found in Malagasy, Tanzania, Sri Lanka, India, Zimbabwe, and North Carolina, USA. Any garnet is a *birthstone* for January. → Pyralspite.

**rhodolite garnet cut;** cut as faceted gems.

**rhodomacon;** a kind of isomorphous intermediate group of pyrope and almandine garnet associated the name rhodolite. → Rhodolite garnet.

**rhodonite;** a mineral of pyroxene group. Used as decorative, faceted gems and prized by collectors. Sometimes banded or spiderweb form in black color due to manganese oxide. Varieties are:



*rhodonite crystals*

bustamite, photicite, and fowlerite. Also called manganese spar, manganolite.

System: triclinic.

Formula:  $2[\text{CaMn}_4(\text{Si}_5\text{O}_{15})]$ . Contain Fe, and Mg.

Luster: vitreous to pearly.

Colors: shades of pink, rose, red-brown, rose-red, gray.

Streak: whitish.

Diaphaneity: transparent to opaque.

Cleavage: {001}, perfect, and {100} perfect.

Fracture: conchoidal to uneven. Brittle.

SG: 3.67-3.76.

H:5½-6½.

Optics;  $\alpha$ :1.711-1.738,  $\beta$ :1.716-1.741,  $\gamma$ :1.724-1.751. ⊕.

Birefringence: 0.013.

Found in Mexico, Australia, South Africa, Sweden,

California, New Jersey, and Franklin (USA).

**rhodonite absorption spectrum;** a broad band at 548 nm and a small line at 503 nm and a diffuse band at 455 can be seen.

**rhodonite cut;** the mineral takes good polish but rarely faceted as a gemstone or cut cabochon, into beads and

used as ornamental decorative objects like inlay.

**rhodonite luminescence;** medium red under SWUV. Dull dark red under LWUV.

**rhodonite pleochroism;** weak yellowish-red, pinkish-red and light yellowish-red.

**rhodopsin;** same as Vitamin A<sub>1</sub>.

**rhomb;** a parallelogram with three parallel pairs of lozenge-shaped faces. Same as a rhombohedron.

**rhombic;** same as rhombic facet.

**rhombic dodecahedron;** in cubic system a crystal form of dodecahedron having twelve faces. → Dodecahedron.

**rhombic facet;** a form of facet consisting of 4-sided of equal length with oblique angles.

**rhombic crystal system;** same as orthorhombic crystal system.

**rhombic dodecahedron;** a crystal form in the isometric crystal system with equal rhomb faces. Also called pyritohedron.

**rhombic mica;** same as phlogopite.

**rhombic spar;** a dolomite crystal in rhombohedral form.

**rhombic system;** same as orthorhombic crystal system.

**rhombohedral;** a class in the rhombohedral a subdivision of the hexagonal system with a 3-folded principal axis. Basic unit cell is a rhombohedron. Also called rhombohedral class. → Rhombohedral system.

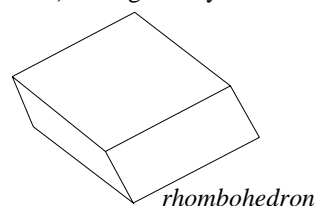
**rhombohedral;** a crystal having a six-sided form.

**rhombohedral class;** same as rhombohedral.

**rhombohedral iron ore;** same as hematite.

**rhombohedral system;** a subdivision of the hexagonal system with a 3-folded principal axis of rotation or inversion where  $a = b = c$  and  $\alpha = \beta = \gamma$  where more than 90° but less than 120°. → Rhombohedral.

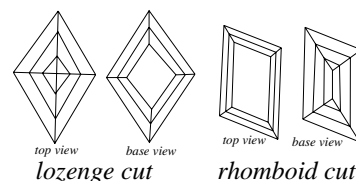
**rhombohedron;** in trigonal system a crystal form or a



*rhombohedron*

parallelogram consisting of 6 identical faces of rhombic outline.

**rhomboid;** a parallelogram without right angles, in which one pair of opposite sides differ in length from the other pair of opposite sides.



**rhomboidal;** a crystal have shape like a rhomboid.

**rhomboid cut;** 4-sided, parallelogram-shaped cut stone usually in step form.

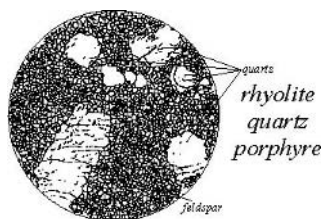
**rhomb spar;** same as dolomite.

**rhombus;** a parallelogram without right angles but, equilateral, all sides are equal in length.

**rhyaolite;** same as sanidine.

**rhodacite;** a group of extrusive porphyritic igneous rocks with intermediate composition which is between dacite and rhyolite containing quartz, plagioclase, biotite and hornblende that are found in a glassy to cryptocrystalline groundmass of alkali feldspar and silica. Also called dolente, taconite, quartz latté (obsolete term). Used as cladding stone.

**rhyolite;** a general term for light-colored, fine-grained, acidic extrusive, igneous rock often with flow texture. Generally is porphyric and contains small phenocrysts of quartz and alkali



feldspar in a glassy to cryptocrystalline groundmass. Also called rhyolite quartz, and liparite.

**rhyolite glass;** a term applied to a volcanic glass having similar composition to rhyolite.

**rhyolite glass;** a misleading term for obsidian.

**rhyolite quartz;** same as rhyolite.

**rhyolitic glass;** → rhyolite glass.

**rhythmic crystal;** crystals with different chemical composition but characterized by development of orbicular structure, are seen in igneous rocks.

**rhythmic crystallization;** → rhythmic crystal.

**rhylon;** a Chinese term for a horn-shaped drinking vessel carved of jade. → Chinese ritual and symbol jades.

**RI;** an acronym for refractive index.

**riband agate;** same as ribbon agate.

**riband jasper;** same as ribbon jasper.

**riband stone;** a sandstone of alternating thin layers.

**Ribaue-Alto Ligonía Topaz;** a topaz of ≈ 100kg in rough, found in 1951-1953 in Mozambique, Africa. Present whereabouts unknown.

**ribbon;** a mixed broad ribbon-like alternating colors run in strips, such as ribbon jasper, ribbon agate, ribbon quartz.

**ribbon agate;** a parallel wide banded variety of agate. Also called riband agate.

**ribbon jasper;** a variety of jasper containing mixed broad ribbon-like colors run in strips. Also called riband jasper, banded jasper, striped jasper, jasponyx. → Egyptian jasper.

**ribbon jasper;** a local term in Australia for brown and

white jasper.

**ribbon opal;** a term used by Australian for a parallel strips wide banded variety of opal with color variations within each strip.

**ribbon quartz;** a variety of banded quartz consisting of more or less colored ribbon that runs in strips.

**ribbon rock;** a banded rock consisting of successive thin layers of various composition and colors, which run in strips.

**ribbon structure;** → ribbon, ribbon rock.

**rib line;** ridge where two adjoining facets meet. Also called facet junction.

**rice jade;** a Chinese description for particular color and quality of jade.

**rice crispy pearl;** a term used in China for inferior quality of non-nucleated cultured pearls.

**rice stone;** stones, which are spotted like white rice corn.

**rice stone;** a variety of soapstone of color of unpolished rice.

**Riccia Diamond;** a rose color diamond of 15 cts, belonged to Prince de la Riccia of Italy. Current whereabouts is unknown.

**Richelieu Diamond;** a heart-shaped, rose-cut diamond of 19 cts, belonged to Cardinal Richelieu (1585-1642) Chief Minister under Louis XIII and during Louis XIV of France, who presented the stone to the French Crown. It was set in an earring and was stolen in the robbery of the Garde Meuble in Paris in 1792. Present owner unknown.

**richelieu pearl;** a commercial term for imitation pearls. Also called richlieu pearl.

**richlieu pearl;** same as richelieu pearl.

**ricolite;** a commercial local term for grayish to yellowish-green, banded variety of fine-grained serpentine or verde antique from Rico, New Mexico. Used as ornamental stone.

**riebeckite;** a blue mineral of fibrous variety of amphibole group, which occurs in some stones and caused tiger's-eye effect with the name crocidolite. Also called osannite.

System: monoclinic.

Formula:  $2[\text{Na}_2\text{Fe}_3^{+2}\text{Fe}^{2+}3\text{Si}_8\text{O}_{22}(\text{OH})_2]$ .

Luster: vitreous.

Colors: blue, deep-blue, bluish-black.

Streak: colorless to blue-gray.

Diaphaneity: translucent to opaque.

Cleavage: {110} perfect.

Fracture: uneven. Brittle.

SG: 3.02-3.42.

H: 5-5½.

Optics;  $\alpha$ : 1.654-1.701,  $\beta$ : 1.662-1.711,  $\gamma$ : 1.724-1.751.

Birefringence: 0.060. ⊖.

Found in Colorado (USA), Island Corsica (France), and Russia.

**Rietfontein South;** location of a large diamond operation center opened in 1992 by Alexander Bay, on the Atlantic Coast, South Africa.

**Rietkuil;** location of a small alluvial diamond deposits in Wolmaransstad area, Transvaal Province, South Africa.

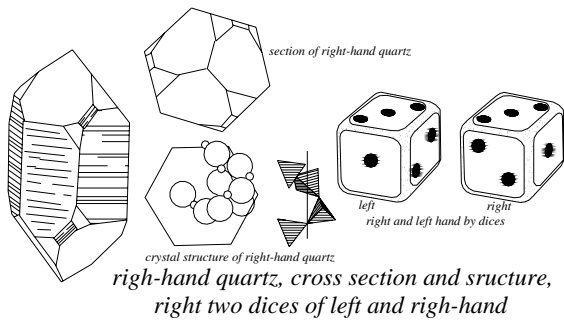
**Rietput;** location of a small alluvial diamond deposit in Schweizer Reneke, Transvaal Province, South Africa.

**Riggs Diamond;** reportedly a colorless diamond of 28.30 cts, in the Smithsonian Institution, Washington, D.C., USA.

**right hand (crystal);** → optical activity.

**right hand polarization;** → right hand quartz.

**right hand quartz;** an optically active quartz crystal, which rotates in the plane of polarization of light to the



right. Also called dextral quartz, dextrorotary quartz, dextrogyrate quartz. → Optical activity.

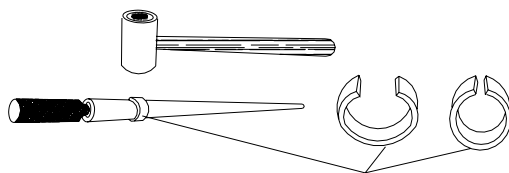
**Rig-Veda;** most important writings of Hinduism is Rig-Veda because of the lore of gems. → Veda.

**rihání;** → ra-e-hani.

**rihani;** → ra-e-hani.

**rind;** a term applied to outer layer of jade, which often blended with the inner mineral in carved pieces.

**ring buff;** a tapered buff tool used for polishing inside



ring buff or enlarging

of the rings. → Ring enlarger.

**ring agate;** a rhythmic orbicular ribbon agate whiteout characteristic color.

**ring enlarger;** a tapered felt buff for enlarging the diameter of rings from inside.

**Ringborg marble;** a dark-green to grayish serpentinous

Marble (or calcite) similar to Connemara marble of gem quality found in Ringborg, Sweden. Also called Swedish green marble.

**Ring of Polycrates;** a legendary ring, according to Pliny made of sardonyx (according to Herodotus an emerald ring) belonged to Polycrates the ruler of the Aegean isle of Samos in the 5<sup>th</sup> century B.C.

**ring silicate;** same as cyclosilicate.

**ring stone;** any gemstone that is used for finger ring.

**ringy ivory;** ivory with alternate dark and light concentric rings from Sudan, Africa.

**rings;** circlet finger rings or earrings, usually made of precious metals such as gold, silver or platinum. Finger rings worn on any finger, rarely on the thumb. It was used as signets or seal-rings for personal identification



and signature. Now are used as personal adornment for peculiar occasions such as betrothal, marriage, membership, birth-month stones, etc. Earrings worn suspended from the ear-lobes as ornamental objects in form of buttons, clips, pendant-shapes, spheres, rings, piercing, fashioned stones, etc.

**ring structures;** same as cyclosilicates.

**rinsed agent;** → methylated spirit.

**Rio Grande citrine;** a misleading term for a wine to reddish-brown colored citrine variety that has been produced by heat-treatment of amethyst.

**Rio Grande citrine cut;** cut as faceted gemstones and cabochon or tumbled. Sometimes has been carved.

**ripen;** some ruby and sapphire burner or dealers are in the believing when the crucible is wrapped in wet clay obtained from the origin mine it will help the stone to ripen.

**ripe pearl;** a term applied to pearls of fine remarkable orient in contrast to unripe pearls.

**ripple fracture;** an inclusion in amethyst like a thumb or finger print.

**rising-sun brooch;** same as sunburst.

**Rittlemago;** location of small alluvial diamond deposits in Hopetown area, Cape Province, South Africa.

**ritual;** a term applied to a jade used in ceremonial purpose especially in ancient China.

**river;** an old term for color grading of pure white

transparent diamond. The name was derived from river digging in South Africa.

**river;** a color grading for top color on the Scan. D.N. color-grading scale for stones over 0.47 cts.

**river;** diamonds that are found in river diggings.

**river agate;** rolled pebbles of water worn moss agate.

**river bort;** diamonds of inferior-quality coming from alluvial deposits.

**river digging;** alluvial gemstone or diamond deposits that are prospected along the river valley.

**river gold placer;** alluvial gold deposits that are prospected along the river valley. Also called river placer gold.

**river horse;** → hippopotamus ivory.

**river marble;** → landscape marble.

**River of Light Diamond;** same as Darya-i-Nûr.

**river pearl;** a variety of pearl found in various fresh-water mussel species *Unio margaritifera* that are known as *Mussel pearl*, found in rivers of Europe, and USA. Often are baroque form and have a variety of colors. Or *Clam pearl*, which are pearls of inferior quality in relation to oyster pearl in various colors. Fresh-water pearls are found in North America, Amazon basin, Mississippi River, Scandinavia, Scotland, and European waters. Mississippi region pearls usually are baroque in shape, strong color and orient, hence called *dogtooth pearl*, *wing pearl*, and *petal pearl*. Such pearls are used in jewelry to produce *flowers*. Commercially pearls of very irregular, distorted fresh-water are termed as *slug*. American fresh-water pearls are fished from the niggerhead *Quadrula ebena*, three ridge *Quadrula undulata* or *Quadrula plicata*. Other American fresh-water pearls are obtained from the bullhead *Pleurobema oesopus*, and the buckhorn *Tritogonia verrucosa*.

**river placer gold;** same as river gold placer.

**river quartz;** rolled pebbles of water worn masses of quartz found in river streams.

**river sapphire;** pale-blue sapphire seldom intense blue from Missouri River in Montana, USA.

**River Styx Diamond;** a black diamond found in Bulfontein Mine, South Africa, cut into a 28.50 cts, brilliant and a 7.00 cts, marquise. It was stolen in 1958 in an armed robbery. Present owner unknown.

**Riverview;** location of small alluvial diamond deposit in the Kimberley area, Cape Province, South Africa.

**riverworn stone;** same as waterworn stone.

**rizalite;** a local term for tektite from Philippine Islands, named after local tribes.

**rivière de diamants;** a French term for diamond necklace or neck chain.

**RJA;** an acronym for Retail Jeweler of America.

**riyoku-giyoku;** a Japanese term for green gemstones

usually emerald. Also called and spelled riyoku-ho-seki, riyoku-gi-yoku-seki, so-giyoku.

**riyoku-gi-yoku-seki;** another term for riyoku-giyoku.

**riyoku-ho-seki;** another term for riyoku-giyoku.

**roasting;** the process of heating sulfide or arsenide ores in air to convert to oxide.

**Roberts-Victor Mine;** location of small diamond deposit near Boshof, Orange Free State, South Africa. Also known as Rovic Mine.

**robin's egg blue;** an American local term for fine sky-blue turquoise.

**Robinsonkop;** location of a small diamond deposit in the Kimberley area, Cape Province, South Africa.

**Robodiam;** a commercial name for an automatically faceting and brutting machine made by Hakodiam in Belgium.

**robold pearl;** a commercial name for a pearl that is not quite spherical.

**Rochelle salt;** a colorless to white, transparent crystalline salt of potassium tartrate soluble in water, insoluble in alcohol salt with the formula  $\text{COOK} \cdot (\text{CHOH})_2 \text{COONa} \cdot 4\text{H}_2\text{O}$  or  $\text{KNaC}_4\text{H}_4\text{O}_6 \cdot 4\text{H}_2\text{O}$ . Having strong piezoelectric properties greater than any other substance or crystal. Also called potassium sodium tartrate.

**rock;** any naturally formed, solidified body of mineral material with usually more than one constituent, or occasionally of one mineral (monomineralic such as quartzite or marble). A genetic classification is; igneous rocks, metamorphic rocks, sedimentary rocks, and hybrid rocks.

**rock;** an unusual term for a diamond or gemstone.

**rock amber;** another term for block amber.

**rock cork;** same as mountain cork.

**rock crystal;** a clear colorless, transparent quartz crystal used as a gemstone and diamond imitation.

**rock crystal;** there are a few quartz crystals with the misleading prefix of diamond such as Alaska diamond, Alenon diamond, Bohemian diamond, Cornish diamond, Bristol diamond, Herkimer diamond, etc. Also called rock quartz.

**rock crystal;** glassware made of fused pure quartz at high temperatures.

**rock crystal;** a misnomer applied to Alaska diamond.

**rock crystal;** a misnomer applied to Arabian diamond.

**rock crystal;** a misnomer applied to Bornholm diamond.

**rock crystal;** a misnomer applied to Brazilian diamond.

**rock crystal;** a misnomer applied to Buxter's diamond.

**rock crystal;** a misnomer applied to German diamond.

**rock crystal;** a misnomer applied to Bohemian diamond.

**rock crystal cut;** quartz crystal cut into cabochon, and faceted gems such as emerald cut, brilliant cut,

engraving, beads and balls in any sizes and flat forms, roundels, other decorative objects and sometimes as replicas from famous brilliants. The roundels are used as doublets and composite stone with the name *soudé emerald*.

**Rocket;** → Foguete.

**rock forming minerals;** minerals that occur in constituents of a rock, and determine its classification. Including feldspars, quartz, amphiboles, pyroxenes, micas, feldspathoids, etc. Also called essential minerals, specific minerals, rock making minerals.

**rock glass;** another term for obsidian.

**rock gypsum;** a massive, coarse to fine-grained crystalline gypsum.

**rock hammer;** same as geological hammer.

**rock hound;** an amateur mineralogist who collects minerals, gems or other rocks.

**rock hound;** an amateur geologist who collects rocks and fossils.

**rocking cradle;** → cradle.

**rocking method;** a method used for distinguishing surface blemishes from internal features where a nearby external feature is chosen as a reference point, while the gemstone will be rocked back and forth, during this motion both the reference point and object are seen. When the object may be internal during rocking, it will appear to move a smaller amount, when the object is on the same surface as the reference point during rocking, they will appear to move in the same amount.

**rock making minerals;** same as rock forming minerals.

**rock meal;** same as diatomite.

**rock meal;** same as moon milk.

**rock milk;** same as moon milk.

**rock needle;** same as stack.

**rock particle;** rock grain.

**rock quartz;** same as rock crystal.

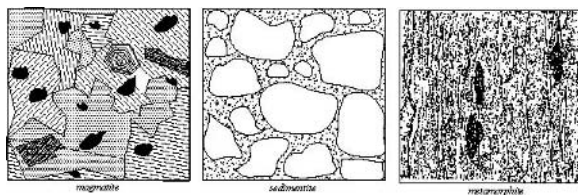
**rock rose;** → Old World Plants, Arctic Ocean amber.

**rock rose;** → labdanum.

**rock ruby;** a misleading term for fine red variety of pyrope garnet.

**rock igneous, metamorphic and sedimentary;** igneous rock formed by the solidification of a molten magma, which may be extrusive on the Earth's surface (volcanic) or intrusive inside the Earth (plutonic). Metamorphic rock, which has been derived from pre-existing rocks by mineralogical, chemical composition, textural and structural changing, essentially in the solid state due to processes operating in the earth's crust of heat or intense pressure, shearing stress, or other natural agents. The alteration causes generation of a new mineral or rock type. Thus, limestones have been changed into marble, and clay into slates, etc.

Sedimentary rocks formed by the deposition and compression of rock and mineral particles which has



*comparison of igneous, sediment and metamorphic rocks*

accumulated in layers, together with material of organic origin. The term included both consolidated and unconsolidated material. Sedimentary rocks may be classified as (a) terrigenous (breakdown of pre-existing rock), (b) organic (produced by organic process), (c) chemical (precipitation from water), (d) volcanogenic (pyroclastic).

**rocks;** → rock.

**rock salt;** same as halite.

**rock science;** same as petrology.

**rock silk;** a variety of green asbestos with silky texture.

**rock soap** same as saponite.

**rock stack;** same as stack.

**rock structure;** same as structure of rock.

**rock system;** → geological era.

**rock turquoise;** a groundmass of turquoise with minute grains of turquoise speckled in it.

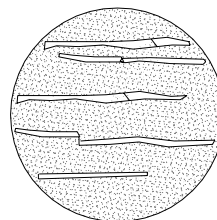
**rock waste;** those loose materials result from weathering of rocks by mechanical and chemical agents, which should be distinguished from debris. Also called debris.

**rock wood;** same as mountain wood.

**rock wool;** same as mineral wool.

**Rocky Mountain ruby;** a misleading term for fine red variety of pyrope garnet.

**rod;** a rod-like inclusions produced by flame-fusion



*rod-shaped inclusion*

synthetic spinel or corundum.

**rodingite;** a gabbroic rock of medium-to coarse-grained calcium enriched silicates, essentially grossular and diallage. Altered varieties containing serpentine or prehnite or both. Used as jade imitation.

**rodite**; → diogenite

**Roebing Black Opal**; a fine black opal, cut cabochon of 355.19 cts, found in Virgin Valley, Nevada, Purchased by W. A. Roebing who later presented it to the Smithsonian Institution, Washington, D.C., USA.

**Roebing Opal**; an opal of 2,610 cts, found in Virgin Valley, Nevada, USA. Purchase by W. A. Roebing who later presented it to the Smithsonian Institution, Washington, D.C.

**Roentgen ray**; same as X-ray.

**Röntgen ray**; same as X-ray.

**roentgenoluminescence**; → radioluminescence.

**roguelite**; a local commercial term for greenish variety of jasper from Rogue River, Oregon, USA.

**Rohrbach's solution**; a toxic, clear, yellow heavy liquid of barium mercuric iodide in water. RI:1.78. Density: 3.588, used for specific gravity determination and separating minerals by their density.

**roiled appearance of pressed amber**; same as undulated appearance of pressed amber.

**Rojtman Diamond**; a yellow, cushion-shaped diamond of 107.60 cts, from South Africa. It was purchased by Harry Winston in 1957, who repolished it into 107.46 cts, and set it in a clip-pendant. Sold in 1963 to Rojzman in USA.

**rolled gold**; a layer of gold or gold alloy rolled into sheets of varying thicknesses, which are thermally fused together on both sides of the base with metals such as brass or silver. → Filled gold.

**rolled garnet**; smooth, well roundish, waterworn pebble stones.

**rolled garnet**; microscopic determination of some garnet crystal shows that the stone of the matrix has been rotated during the dynamothermal metamorphic movement. Also called rotated garnet, pinwheel garnet, spiral garnet, snowball garnet.

**rolling flash**; a term used for moveable feature in an opal in which a flash or more flashes of color rolls across the stone.

**romanechite**; a manganese-oxide mineral, which is a major constituent of psilomelane. Used as a hematite simulant, which resembles it. Cut as gems. Strong electroconductivity. Found in botryoidal or stalagmitic aggregates.

System: monoclinic.

Formula:  $2[\text{BaMn}^{+2}\text{Mn}_8^{+4}\text{O}_{16}(\text{OH})_4]$ .

Luster: strong vitreous to silvery.

Colors: black, bluish-black to gray.

Streak: blackish to brown.

Diaphaneity: opaque.

Cleavage: none.

Fracture: conchoidal to uneven. Brittle.

SG: 4.71.

H:5½-6½.

Found in Russia, USA, Scotland, Sweden, India, Belgium, and Japan.

**Roman imitation pearl**; a term used for Glass beads from Roman times were silvered and coated with another coating glass material, which was not always satisfied. Not to be confused with Roman imitation pearl mentioned above. → Imitation pearl.

**Roman imitation pearl**; a term used for hollow wax-filled glass beads the wax increased the solid look of the beads. Was used as a pearl imitation. Not to be confused with Roman imitation pearl from Roman times. Glass beads from this time were silvered and coated with another coating glass material, which was not always satisfied. → Imitation pearl.

**romanite**; same as rumanite.

**Roman mosaic**; → mosaic, Byzantine mosaic, Florentine mosaic.

**Roman pearl**; a misleading term for hollow wax-filled glass beads the wax increased the solid look of the beads. Was used as a pearl imitation. → Imitation pearl, glass imitation pearls.

**Roman stone**; a misleading commercial term for marble from peninsula Istria, Croatia.

**Romanian amber**; same as Rumanian amber.

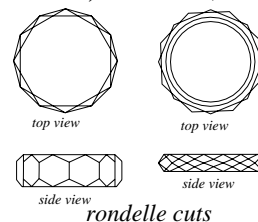
**romanzovite**; a brown to dark brown variety of grossularite garnet from Finland.

**rondel**; same as rondelle.

**rondelle**; sometimes rondelle is drilled through the center so that it can be strung between beads to make a necklace.

**rondelle**; frequently used to separate the largest stones of a necklace. Also spelled rondel, roundelle.

**rondelle cut**; a thin-flat, circular disk-like, faceted and polished gem made of gemstone, metal or other material but mostly from quartz crystal and frequently cut of diamond. The



rondels quartz are used to make *soudé emerald*, when cemented with a green cement.

**rondist**; → rondisting.

**rondisting**; a Dutch term for roughly rounded edge carried out by bruting is called rondist. It will finally become the girdle in the case of operation brilliant-cut. Same as girdling.

**roundel**; same as rondelle.

**Roodepan**; location of small alluvial diamond deposit in Ventersdorp area, Transvaal Province, South Africa.

**Roodepoortje**; location of a small alluvial diamond



deposit in Lichtenburg area, Transvaal Province, South Africa.

**roof;** another term for top rock.

**roof;** a term used by Australian miners for an overlying sandstone in an opal mine under which opal dirt is usually found. Also called top rock.

**Roosevelt Aquamarine, Alice;** a faceted heart-shaped aquamarine was presented to Alice Roosevelt, daughter of President Roosevelt from Vice President Taft in 1906 upon her marriage.

**Roosevelt Aquamarine, Franklin;** a fine quality step-cut Brazilian Aquamarine of 1847.00 cts. Was a present from Government of Brazil to Franklin Roosevelt. Now on display at Roosevelt Museum, Hyde Park, New York, USA.

**root;** a term applied to the bottom of a deposit, for example kimberlite pipe.

**root amber;** a term applied to an opaque kind of amber of various mixed brown shades from Myanmar (Burma), due to penetration of calcite into cracks and pores often filled as thin layers. This naturally swirled amber used to carve ornament but utilizing the stone swirls, which in China named *ch'iano-tiao*, meaning clever carving or ingenious carving.

**root of emerald;** same as mother-of-emerald.

**Rosa de Abaeté Diamond;** a diamond of 80.30 cts, found in 1935 in Abaeté River, Minas Gerais, Brazil.

**rosalite;** an opaque, pink, manganese rich variety of thulite zoisite.

**rosa pallido coral;** an Italian color classification of natural coral, equal pale red.

**Rosario Oeste;** location of alluvial diamond deposits in Mato Grosso, Brazil.

**rosary;** a chain strung of beads used in counting prayers of devotion.

**rosa vijo coral;** Italian color classification of natural coral, equal vivid red.

**rose;** rose colored gemstones such as rose quartz, rose topaz, etc.

**rose;** a rose or pink color diamond.

**rose;** rose-cut diamond or other transparent gemstones.

**rose;** any jewels made in the form of a rose, which attached to its stem such as brooch.

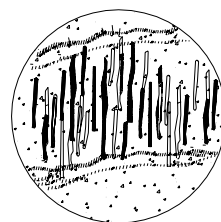
**rose;** a rosette or rose like aggregate of large, tabular crystals such as hematite (alpine rose), or barite (desert rose).

**rose;** a mosaic like rose composed of carved pieces of coral and other stones.

**rose;** ivory cut or carved in the form of a rose.

**rose agate;** a local term for alternate banded, gray, and rose agate from Brewster County, Texas, USA.

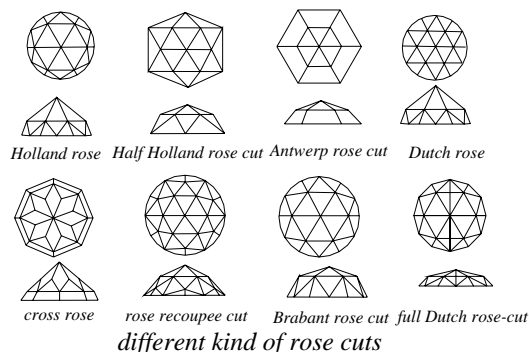
**rose beryl inclusion;** the internal features in rose beryl are feathers of negative crystals, straight rod-shaped



healing  
cracks  
conchoidal-form  
in rose-beryl  
from Brazil

healing cracks or tubes in conchoidal arrangement, which are like aquamarine inclusions. → Inclusion in aquamarine, inclusion in emerald.

**rose cut;** an ancient cutting style for diamond or other transparent stone, applied to flat facets, which is known as *rosette*, probably originated in India. Characterized by a flat base, symmetrical dome-shaped top covered with triangle facets in various shapes and relative sizes, which dominates a point. Now used mostly for small diamonds such as small cleavage fragments and macles.



The standard rose cut has 24 facets in the form of a round rose usually cut in multiples of six in two groups. In the rose cut the base facets are cross facets, which are known as *teeth* or *dentelle*, sometimes called *Dutch rose cut*. A *double rose cut* made when two pieces of dome-shaped rose cut are placed base to base in a circular-girdled diamond without a table and culet. When the crown of a double rose is cut excessively elongated to form a *drop-shaped* brilliant-cut this is known as *briolette*.

**rose cut;** same as Dutch rose, Holland rose, Antwerp rose cut, or Brabant rose cut.

**rose cut;** same as cross rose cut.

**rose cut;** same as rose recoupee cut. Also called rose, rosette cut, rosie.

**rose cut diamond;** same as rose cut.

**Rose D'Angleterre Diamond;** a circular-shaped diamond of unknown weight, which was bequeathed to Anne of Austria by Cardinal Mazarin in 1661. No further information available.

**rose de France;** a commercial term for purplish-pink amethyst from Brazil. Also called rose de France amethyst.

**rose de France;** a commercial term for synthetic pink sapphire.

**rose de France amethyst;** same as rose de France.

**rose diamond;** rose cut diamond.

**rose diamond;** small diamonds suitable for rose cut.

**rose fluor;** same as pink fluorite.

**rose-jade;** a term used incorrectly to refer to rhodonite or thulite. Also called red Peking-jade.

**rosée pearl;** a high quality pearl of pinkish color, spherical form and fine orient. Also spelled rosé pearl.

**rose garnet;** a misleading term for rhodolite.

**rose garnet;** a large crystal of pink or rose-pink variety of grossularite garnet, which occurs in marble found in Mexico. Also called landerite, roselite, and xalostocite.

**rose garnet;** a commercial term for a rose-cut garnet.

**rose garnet;** a commercial term for a rock composed of vesuvianite, rosolite and wollastonite from Xalostoc, Morelos, Mexico.

**roseki;** agalmatolite of Japanese.

**rose kunzite;** a misleading term for synthetic pink sapphire.

**roselite;** a large crystal of pink or rose-pink variety of grossular garnet, which occurs in a creamy marble. Found at Xalostoc, Mexico. Also called landerite, and rose garnet. Locally the stone is known as xalostocite. Also spelled rosolite.

**roselite;** a pink to dark red hydrated calcium-cobalt-magnesium-carbonate. SG:3.50-3.74. H:3½.

**rose moonstone;** a misleading term for pinkish scapolite from Myanmar.

**rose opal;** an attractive, opaque, pink colored variety of common opal, which is known as quincite.

**rose pearl;** a commercial term for pinkish, iridescent, baroque fresh water pearl.

**rosé pearl;** same as rosée pearl.

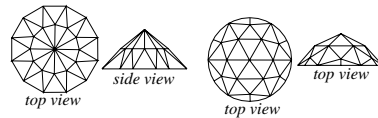
**rose quartz;** usually cloudy, translucent, pale pink, deep pink, rose-red to quasi white and often veined variety of quartz. The color is caused by a charge transfer between titanium  $Ti^{+4}$  and iron  $Fe^{-2}$ . It is believed that the fading rose quartz is caused by phosphate impurities. Cut cabochon, carving as netsuke, beads, ornamental objects, tumbled and prized by collectors. Rose quartz includes microscopic needles of rutile (frequently sillimanite needles, which are known as fibrolite), which sometimes if suitable is cut cabochon, a six-rayed star (diasterism) can be seen, when cut and observed in the correct direction. Used to imitate star sapphire. In some materials can be seen several cracks. Found in India, Japan, Namibia, Brazil, Malagasy, Russia, and South Dakota, USA. Frequently dyed with aniline. Misleadingly called Bohemian ruby. Also called rosy quartz. Misnomerly called Bohemian ruby, American quartz, Ancona quartz. A misnomerly

commercial term by jewelers as: Bohemian ruby when cut as a gem.

**rose quartz cut;** nearly clean, rose to pink or purple color faceted as gems or cut cabochon. → Rose quartz.

**rose recoupée;** same as rose recoupée cut.

**rose recoupée cut;** a modification of cutting a diamond or transparent gemstone derived from rose cut and cross rose-cut with 12-sided girdle and 36 facets in two rows. The 12 triangles facets of upper double rose are joined



two rose recoupé cuts

together base to the base with 12 triangles facets of double rose abutting the girdle with their points. Also the 12 triangles facets

abutting the girdle with base and joined with their points the upper row. Also called rose recoupée. Synonym for Double-Dutch rose cut, double-Holland rose cut.

**roses;** same as rose.

**rose spar;** rosy spar, derived from German rosenpat or manganese spar which is a general term for both minerals rhodonite and rhodochrosite.

**rose topaz;** a naturally occurring light rose or pink topaz.

**rose topaz;** a misleading term for a variety of yellow quartz altered its color to pink by heat treatment.

**rose vitriol;** same as cobalt vitriol.

**rosterite;** beryl from Elba, Italy which is slightly altered.

**rosette;** a type of rose cut.

**rosette;** a jewel or ornament made of stylized rose with a central gemstone.

**rosette;** same as barite rosette.

**rose vitriol;** another term cobalt vitriol.

**rose water;** scented solutions of odoriferous constituent used as perfume obtained by cooking with water or steam, made by the distillation of fresh rose or other fresh flower petals. It was used as medicine together with the powder of precious stones, rocks, minerals, etc.

**rosewood marble;** a misleading term for a fossil coral variety of limestone from Ashford, Derbyshire, England, which exhibit fine parallel lamination of wood but it is not true wood.

**rosickyite;** a term used in USA for gamma-sulfur.

**rosie;** same as rose cut.

**rosin;** a translucent, hard, brittle, combustible variety of resin or colophony colored from deep brown to light lemon yellow to colorless, derived from oil-resin of pine trees. Soluble in alcohol but not in water. Used as

varnish, adhesive, and polyesters.

**rosinca**; a fancy commercial term for banded rhodochrosite found in Argentina, which was known to the Incas. Also called Inca rose.

**rosolite**; a large crystal of pink or rose-pink variety of grossularite garnet, which is also called landerite and xalostocite. Found in white marble at Xalostoc and Morelos, Mexico. The stone is known as xalostocite.

**rosolite**; sometimes a name for rock, in which the gemstone occurs and is associated with vesuvianite, rose garnet and wollastonite. Found in Xalostoc and Morelos, Mexico.

**Rospogli Sapphire**; same as Raspoli Sapphire.

**Raspoli Sapphire**; same as Raspoli Sapphire.

**Rosser Reeves Star Ruby**; a fine-quality star ruby of 138.70 cts, from Sri Lanka. It has a 6-rayed star due to needle-like inclusions arranged at 60° to each other.

**rossini jewel**; a commercial term for synthetic strontium titanate used as a diamond imitation.

**rosso antico**; a commercial term for a red unglazed stoneware from Staffordshire, England.

**rosso antico marble**; a red marble with white and black veins from Cynopolis and Damaristica used by Etruscans and ancient Romans.

**rosso coral**; classification of coral color in Italy, for red color.

**rosso levanto marble**; same as verde antique.

**rosso scuro coral**; classification of coral color in Italy, for dark red color.

**Rosso Verona**; a north east Italian brownish-red limestone consisting of irregular conglomerates fragments embedded in marly matrix. *Porfido ramello* is similar to Rosso Verona.

**rosterite**; a local term for a rose-red variety of cesium beryl from Island of Elba, Italy. Also called vorobyevite or morganite.

**rosy spar**; same as rose spar.

**rotagem**; a rotatory accessory apparatus for Rayner refractometer, which holds the stone on to the dense glass.

**rotary dispersion**; the breaking up of white light into colors such as a dispersion prism by passing a crystal through an optically active material such as quartz or sugar. Also called rotatory dispersion, rotary dispersion of quartz.

**rotary dispersion of quartz**; same as rotary dispersion.

**rotary reflection**; in crystallography same as atomic structure of crystal. Also called rotary reflexion.

**rotary washing pan**; an apparatus applied to separate diamonds from accompanied material such as sand, soil, gravel, weathered ore, or crushed rock. The ore is placed into a circular washing pan and filled with water and fine clay particles. After the device put into motion

the lighter materials are floated off over, and the heavy materials and diamonds sinks to the bottom. Also called washing pan.

**rotated garnet**; microscopic determination of some garnet crystal shows that the stone of the matrix has been rotated during the dynamothermal metamorphic movement. Also called rolled garnet, pinwheel garnet, spiral garnet, snowball garnet.

**rotation**; turning of a rigid body about an axis passing through it such as rotation of the earth about its polar axis. → Lattice vibration.

**rotation axis**; same as axis of symmetry.

**rotation bomb**; same as volcanic bomb.

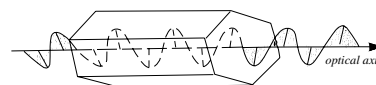
**rotation crystal twin**; symmetry of a twined crystal is formed by apparent axial rotation of 180°.

**rotation of angle**; same as angle of rotation.

**rotatory dispersion**; same as rotary dispersion.

**rotatory dispersion of quartz**; same as rotary dispersion.

**rotatory polarization**; same as circular polarization.



*rotation vibration of light  
in quartz crystal*

**rothoffite**; a yellowish-brown to dark brown variety of andradite garnet.

**rotifer**; microscopically very small funnel-shaped freshwater wormlike organism constitute of horny substance which enters the pearl oyster and become trap and preserved in its sarcophagus. → Pearl fish.

**rottenstone**; a light-colored, soft, very fine textured, siliceous earthy mass formed by weathering and decaying of chert or impure siliceous limestones or argillaceous limestones, the carbonate material being removed by percolating water. Used as an abrasive and polishing powder for final polishing of colored gemstones. Also known as tripoli, and silicon dioxide. English earth is a local term for rottenstone.

**rouge de rance**; a dull red and gray colored coral marble from Namur region, Belgium, which is specifically known as *rouge de rance marble* or *rouge byzantin marble*, and collectively called *Belgian rouge-et-gris marble*. → Coralline marble.

**rouge byzantin marble**; → rouge de rance.

**rouge-et-gris marble, Belgian**; → rouge de rance.

**rouge, jewelers**; same as jeweler's rouge.

**rouge royal marble**; → coralline marble.

**rough**; a commercial term for any gemstone in its uncut state such as a rough diamond, etc.

**rouge;** a brownish-red abrasive powder composed mainly of hematite ( $Fe_2O_3$ ). Also called ferric oxide, or jeweler's rouge. Green rouge is chromium oxide. *Crocus* is a commercial term for coarse-grained dark colored variety of rouge. Also called *crocus martis*.

**rough;** a term used by Australian for gem opal or opal that has not been cleaned and fashioned.

**rough;** a term applied to highly fractured material.

**rough diamond;** an uncut diamond or not fashioned diamond crystal. Also called brait. → Rough.

**rough gem;** any gem that has not been fashioned.

**rough girdle;** when the girdle of a diamond is cut too quickly and with unnecessary pressure, tiny irregular, pits or granular girdle surfaces are developed, often heavily bearded, instead of having the waxy or silky luster and smoothness. Also called porous, bruted.

**roughler;** any stone that has not been fashioned. Also called rough-stone, ashlar, unhewn.

**rough mineral;** gem or mineral that has not been fashioned.

**rough opal;** a term used by Australian for grinding the stony goods from the opal.

**roughs;** any uncut diamonds.

**roughs;** minute rough diamond pieces mounted in a cheap bunch ring.

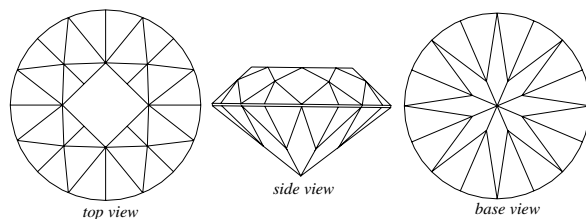
**rough-stone;** any gemstone that has not been fashioned. Also called, ashlar, roughler, unhewn.

**roumanite;** a variety of amber from Rumania. Same as rumanite.

**round bort;** → ballas, Brazilian ballas. same as brilliant cut.

**round brilliant cut;** same as brilliant cut.

**round brilliant cut with square table;** a modified round brilliant cut with a square edged table and 32

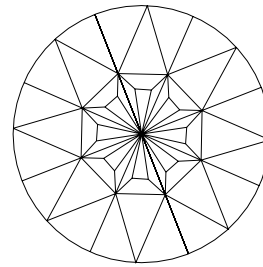


*round-brillinat-cut with square table and crossed crown*

triangular facets an 8-sided star surrounded the table.

**round brilliant cut with crossed apex,** a modified round brilliant cut with a 32 facets running from the apex of stone down to an octagonal shaped middle part and from this octagonal running, an 8-rayed star and 26 triangular facets surrounded the girdle. an 8-sided star surrounded the table totally 56 facets are in the crown.

An eight-rayed star, which is, parted into two triangular give the impression of a steer wheel of ship. Girdle and

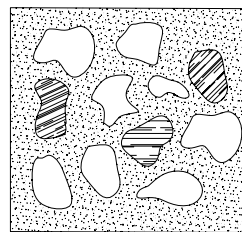


*round brilliant with crossed apex crown*

pavilion are similar to round brilliant-cut.

**rounded;** any particle or stone that has been rounded or is curved in shape, whose edges and corners have been smoothed by abrasion.

**rounded grain;** grains round or curved in shape, especially sedimentary particles whose sharp edged and corners have been smoothed by abrasion during moving and transportation of materials. These pebbles having sizes between



*rounded grains*

0.40 to 0.60 mm in diameter.

**rounding;** → girdling.

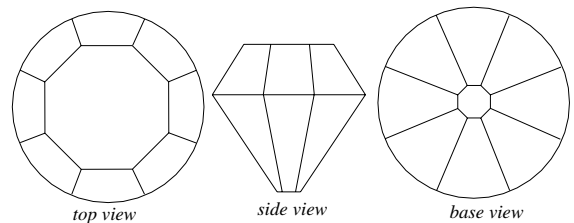
**round, in the;** a style of cutting that has the full form.

**rounding up;** → bruting.

**roundelle;** same as rondel.

**roundness;** degree of rounding the surface of a grain or stone due to abrasion.

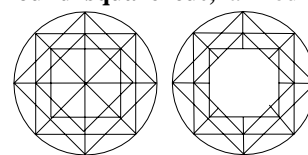
**round single cut;** a simply round brilliant cut with eight 4-sided facets and an eight-sided table in the crown.



*round single-cut*

Pavilion has an eight four-sided star with a culet.

**round square cut;** a modified round brilliant cut for diamond and other transparent colored stones with two crossed square of 56 facets, no table in the crown. Pavilion has two crossed

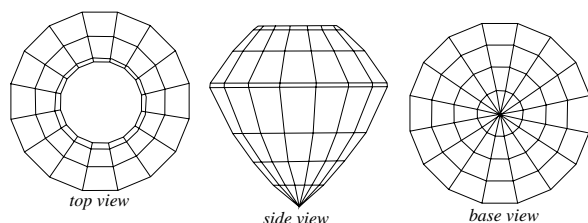


*modified round-squared cut*

square of 48 facets and large culet. Totally 105 facets.

**round step cut;** a style of modified round brilliant cutting similar to round step brilliant cut.

**round step brilliant cut ;** a modified semi-rounded brilliant cut (16-sided outline), for diamond and other transparent colored stones. It has extra shallow 3 rows



round step-cut

of 16 four-sided facets in the crown adjacent to the large table. Four extra rows of 32 four-sided facets in the pavilion down to the apex which is without culet. It has more brilliancy with totally 81 facets.

**roundstone;** e term applied frequently to rounded diamond crystal.

**roundstone;** e term applied to any naturally rounded rock fragments larger than 2mm in diameter.

**roundstone;** a rock fragment naturally rounded or semirounded with an average of 75-300mm in diameter. Also called cobble, cobble-stone, cople-stone (obsolete) and in Devonshire: popple.

**Rovensky Diamond;** a cushion shaped diamond of 31.40 cts, owned by J. E. Rovensky. Was sold to Harry Winston in 1957, who recut it into 31.20 cts, and gave it the name of Merriweather Post Diamond.

**Rovensky Diamond Necklace;** a necklace of diamonds and platinum of a total of 213.10 cts. The pendant of them is a colorless, flawless, pear-shaped diamond of 46.50 cts. Named after family of J. E. Rovensky. It was sold in 1957. Present owner unknown.

**Rovic Mine;** same as Robert-Victor Mine.

**royal agate;** a molted obsidian.

**royal azel;** a commercial term for a purple variety of sugilite, a silicate mineral. Found In Wessel Mine, Hotazel, Cape Province, South Africa. In the same composition and condition found Royal lavulite.

**royal blue;** a variable blue color similar to vivid purplish blue.

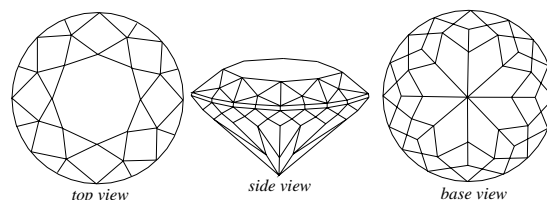
**royal blue sapphire;** Myanmar sapphire with unique, vivid purplish blue color.

**Royal Blue Star Sapphire of Venus;** a blue sapphire of 540 cts, from Sri Lanka. No additional information is available.

**royal cut;** a modern style of cutting a diamond with a

hexagonal table and 32 triangular and isosceles trapezium facets on the crown, which surrounded the table. 72 facets on pavilion and 48 facets on the girdle, totally 154 facets. It exist another royal cut with 144 facets for smaller diamond stones. → Royal 144 cut.

**Royal 144 cut;** a modern style of cutting diamond with usually 56 facets of full cut brilliant, 48 facets on pavilion and 40 facets on the girdle, totally 144 facets.



Royal 144 cut

Also called princess cut. → Royal cut.

**royal gem azurite;** azurite mixed with malachite and other copper mineral from Copper World Mine in Barstow, Las Vegas, USA. It is suitable for use in jewelry.

**Royal Gold Canary Diamond;** a canary yellow diamond of unknown weight was offered in 1951 in a rosette brooch at Palm Beach, Florida, USA. No further information available.

**royalite;** a commercial term for purplish-red glasses.

**royal lavulite;** → royal azel.

**Royal Ontario Topaz;** a cut topaz of unknown origin of 3000 cts. Now on display at Royal Ontario Museum, Canada.

**royal purple;** a term used to purple color which was restricted to nobility to be born in purple because son of Byzantine emperor was born in a room was decorated with porphyric rock of purple colored crystals.

**royal purple;** → Murex purpura haemestoma.

**royal topaz;** a blue variety of topaz.

**Royal Treasury of Lahore;** → Lahore Royal Treasury, Jewels of India.

**royite;** a variety of quartz crystal.

**rozircon;** a misleading commercial term for pink synthetic spinel.

**Ru;** a chemical symbol for the element ruthenium.

**rubace;** imitations of rubasse.

**rubasse;** a commercial term for quartz, which is colored by numerous small scales or flacks of iron oxide or hematite. Found in Brazil and other sources. The stone is misnomered as *Ancona ruby*, and *Mont Blanc ruby*. Imitations are produced by a crackled quartz stained ruby red known as rubace.

**rubbish;** a mining classification term for all inferior diamonds that can only be used for making powder.

**rubbish;** a general classification term comprises both combustible and non-combustible material.

**rubblerock;** same as breccia.

**rubblestone;** same as graywacke

**rubblerock;** same as boulder, fragment of bedrock, float.

**rub down;** a term used by Australian for grinding of an opal to prepare a face of the stone. → Face.

**rubellite;** a term for red or pink, transparent variety of elbaite or tourmaline. Sometimes misnomered as *Siberian ruby*. Also called elbaite.

**rubellite cut;** cut as faceted gemstones, some specimens show excellent cats-eye effects.

**ruberite;** another term for cuprite.

**rubicelle;** a misleading term for yellow to orange-red gem variety of spinel

**rubidium;** a soft, silvery-white, very reactive metallic element of the alkali group of the Periodic System with the symbol Rb.

**rubidium microcline;** a rubidium rich variety of microcline.

**rubino-di-rocca;** an Italian term for red to violetish garnet.

**rubinus;** a Latin term for red-stone or ruby.

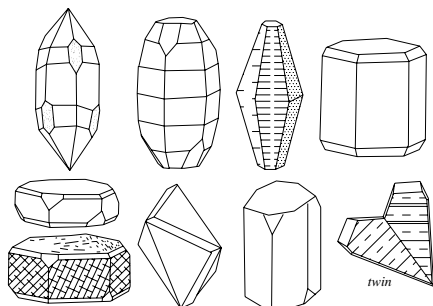
**rubis;** a French term for ruby.

**rubolite;** a red variety of common opal from Texas, USA.

**rub over setting;** same as collet setting.

**rubstone;** a rock or stone capable for making whetstone.

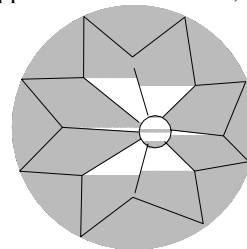
**ruby;** a red transparent gem variety of corundum. Some specimen shows excellent asterism *star ruby*. Flawless specimen are very rare and more costly than diamonds of the same size. The colors are intense red to pink due



corundum crystals and twin

to traces of chromium oxide. *Padmaragaya* is a Singhalese term for yellowish, pinkish-orange to reddish-orange variety of corundum (sapphire) from Sri Lanka, or a synthetic corundum of yellow to orange color, which means *lotus flower*. *Pigeon's blood* ruby is a dark red tending to purple, it contain some small

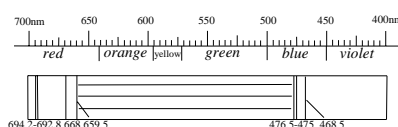
irregular inclusions of needle-like rutile, which give a silky effect to the stone. Rubies have been cut as brilliant, mixed cut, beads, tumbled, step cut, cut as star rubies, star sapphires and cabochon, asterism or with



ruby in methylene iodide under microscope with focus raised into liquid

cat's-eye (one ray). Also it is called *true ruby*, *red corundum* or *Oriental ruby*. It is the *birthstone* for July. Found in Sri Lanka (Ceylon), Mogok district in Myanmar, (Burma) and Thailand. Synthetic rubies are easy to distinguish because of rounded bubbles and striae in straight rather than curved lines. Sometimes the term ruby is misnomered such as balas ruby, or ruby spinel are true spinel. Famous rubies are: Rosser River Star Ruby, De Long Star ruby, Peace Ruby, Edward's Ruby, etc. → Corundum, inclusion in corundum.

**ruby, absorption spectrum;** a double line at 694.20 and 692.80 nm. for



ruby absorption spectrum

both natural and synthetic ruby. Two

fainter lines at 668 and 659.20 nm. A band in the green at

550 nm, and three small lines at 468.50, 476.5 and 475 nm.

**ruby, Adelaide;** a misleading term for red garnet from Adelaide, Australia.

**ruby, Arizona;** a misleading term for red garnet from Arizona, USA.

**ruby, almandine;** a misleading term for red spinel.

**ruby, balas;** a misleading term for rose-red spinel. Same as balas ruby.

**ruby blende;** a red, brownish-red, transparent variety of sphalerite (blende). Also called ruby zinc.

**ruby, Bohemian;** a misleading term for red garnet from Bohemian, the Czech Republic.

**ruby, Brazilian;** a misleading term for rose-red topaz from Brazil.

**ruby, Burma;** world's finest ruby from Mogok district, Myanmar, (Burma).

**ruby, Cape;** a misleading term for red garnet from Cape district, South Africa.

**ruby cat's-eye;** a misleading term for a star ruby with girasol or chatoyancy effect, it occurs very rarely and has a single line.

**ruby cat's-eye;** theoretically a true cat's-eye ruby is possible.

**ruby, Colorado;** a misleading term for red garnet from Colorado, USA.

**ruby colors terminology in Thai;** a classification of ruby colors used in Thailand by Gemological Institute (AIGS). type-A or *ploy daeng*: a term used for red stone, which has slightly purplish or brown color. Type-B or *daeng chompoo*: a term used for pinkish red stone, which has pinkish red to orangey color. Type-C or *daeng som*: a term used for orangey red stone, which has slightly orangey red color. Type-D or *daeng dum*: a term used for blackish red stone, which has pure red color on the brilliant areas and blackish on extinction areas. Type-E: a pink to purplish red but more purplish than Type-B. → Sapphire colors terminology in Thai, some.

**ruby copper;** same as cuprite.

**ruby copper ore;** same as cuprite.

**ruby crystal;** same as ruby.

**ruby cut;** → ruby.

**ruby, dichroism;** dichroism can be seen in natural colored ruby crystals.

**ruby, fluorescence;** ruby has a red spectacular fluorescence under ultraviolet radiations, sometimes green, blue or violet with a doublet spectrum at 692.80 and 694.20 nm, which appears as a single line.

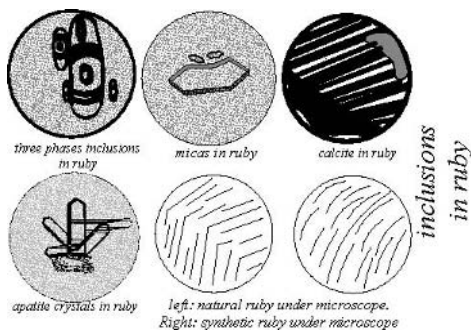
**ruby glass;** any glass having characteristic red color like ruby made by adding gold, copper, or selenium to the batch. Also called gold-ruby glass.

**ruby-heat treatment;** → sapphire heat-treatment, heat treatment of sapphire and ruby.

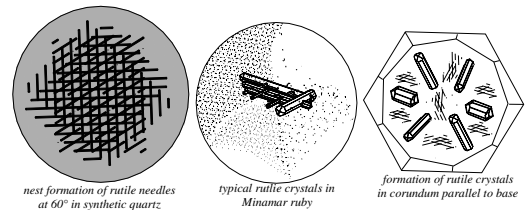
**ruby imitation;** imitation ruby and sapphires are made from composed stones, glasses, or several occur naturally such as garnets, spinels, or synthetic stones several of composed star sapphires or star rubies, and coating of white star sapphire with a red plastic.

**ruby in basalt;** → corundum in basalt.

**ruby, inclusion in;** → inclusion in corundum.



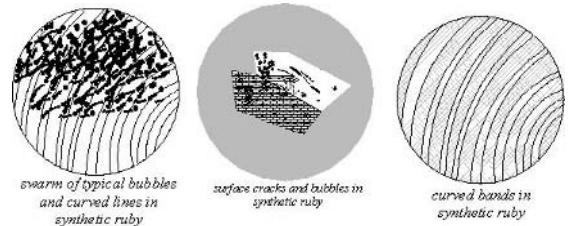
**ruby, inclusion in;** Common inclusions usually seen in various corundums are Long rods and tubes appear, which feather-shaped, repeated twinning (growth lines)



ruby inclusions of rutiles

are occasionally seen in corundums. An interesting inclusion found in corundum is the so-called *silk* inclusions. Formed from exsolved needle-like rutile crystal or hematite plate inclusions, which occur parallel to the hexagonal prism at 60 and 120. In stone they run parallel or criss-cross and subsurface reflection produce a whitish sheen resembling that of woven silk fabric. Other inclusions are negative crystals, *fire marks* (small, wavy, roughly parallel cracks are often seen at or near facet edges in natural or synthetic corundums), polysynthetic twinning, exsolved boehmite crystals, which are seen in synthetic corundum, calcite, zircon, mica, spinel, apatite, garnet, pyrochlore and uranium. → Inclusion in corundum.

**ruby, inclusion in synthetic;** the internal features of synthetic corundum are two-phase, curved lines or bands with gas bubbles in the form of tadpole-shaped,



curved lines, bands and bubbles in synthetic rubies

flask-shaped, bubble clouds, fire-marks, and silk. → Inclusion in corundum.

**ruby in marble;** in some metamorphic marbles from Mogok and Sagyin, Myanmar contains scattered ruby crystals and other gemstones. Also called ruby marble.

**ruby juice;** a clear red lacquer used as coating layer on the pavilion of some stones to improve its color. → Lacquerback.

**ruby laser;** synthetic ruby used to produce laser beam of coherent red light.

**ruby luminescence;** chromium-rich corundums or rubies are very strong crimson or frequently orange

colors under SWUV or LWUV light caused by exiting of Cr ion.

**ruby luster;** having characteristic luster similar to ruby.

**ruby marble;** → ruby in marble.

**ruby matrix;** any rock containing red corundum such as schist, marble, pegmatite, chromiferous zoisite, etc. Cut cabochon. Also called *mother of ruby*.

**ruby mica;** same as goethite, needle iron-stone.

**ruby mine;** an opening or excavation for the purpose of extracting rubies.

**ruby, Montana;** a misleading term for red garnet.

**ruby oils;** a term used by Thailand gem trader to ruby-red oils which are applied to rough stones but normally not used to faceted gemstones to improve the surface luster and color. The oil is pouring on rough stone at room temperature while the oil rarely penetrate the fractures, which may be removed during cutting process. These oils are soluble in alcohol, acetone, etc.

**ruby, Oriental;** → corundum.

**ruby powder;** same as aluminum oxide.

**ruby, reconstructed;** an artificial ruby produced by fusing together small fragments of natural rubies with addition of potassium dichromate, which is called reconstructed ruby or *reco*. Also called Geneva ruby. Now has been indicated as reconstructed flame-fusion rubies. Also once called *Wyse ruby*.

**ruby, sand;** a misleading term for red alluvial sand containing red garnets from Alaska.

**ruby sand;** small, sand-like particles of ruby from Myanmar used to produce mainly Geneva ruby by fusion process, which is a reconstructed ruby.

**ruby sapphire;** a misleading term for almandine sapphire or amethystine sapphire.

**ruby, Siberian;** true ruby from Russia.

**ruby, Siberian;** a misleading term for rubellite a red variety of tourmaline from Siberia, Russia.

**ruby, silk;** → silk in ruby.

**ruby silver (ore);** same as proustitite.

**ruby silver (ore);** same as pyrargyrite.

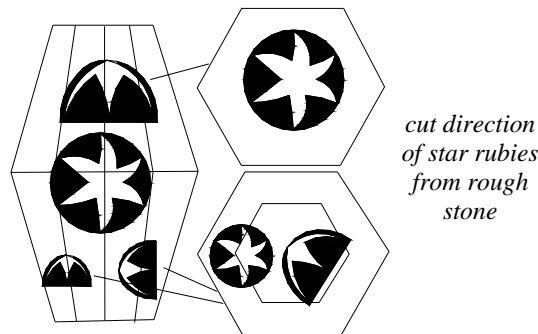
**ruby spinel;** a misleading term for a variety of red spinel containing small amounts of chromium. Also called spinel ruby. Sometimes called Balas ruby.

**ruby, Sri Lanka (Ceylon);** ruby and ruby star of gem quality found in Sri Lanka in an alluvial layer known as illam.

**ruby, star;** → star ruby.

**ruby star-cut direction;** an epiasteriated variety of ruby normally comprised of 6-rayed star, which has a silky structure, when cut cabochon. It is due to innumerable submicroscopic parallel crystal, bubbles or rod-like inclusions, which are also parallel to the 6-sided ruby crystal. Sometimes a 12-rayed ruby star can be seen in natural and synthetic ruby and sapphire. Star-cut rubies

and star-cut sapphires are cut as low cabochon because of greater effect of star. Dom cut acts as a condensing lens to collect the light together and reflected into star



effected inclusions. → Open star.

**ruby, synthetic;** → synthetic ruby, synthetic corundum.

**ruby sulfur;** same as realgar.

**ruby, Thailand (Siam);** rubies found in sandy layer in Chantabun and Battambang, owing their color to the presence of trace iron oxide.

**ruby tin;** a red variety of cassiterite cut for collectors.

**ruby, treacle in;** in some Myanmar, (Burma) natural gem ruby is a curious feature of patches of deeper color in the form of wisps and swirl to seen, which is named treacle.

**ruby, Vale;** a ruby source at Willows in Queensland, Australia.

**ruby zinc;** a dark-red, transparent variety of zincite.

**ruby zinc;** a dark-red, transparent variety of sphalerite.

**Ruigtelaagte;** location of small alluvial diamond deposit in the Lichtenburg area, Transvaal Province, South Africa.

**ruin agate;** a brecciated or dendritic variety of agate usually of brownish color with markings resembling the outlines of ruins of buildings on polished surface. May be used as topographic agate, landscape agate or fortification agate. → Paesinite.

**ruin marble;** a brecciated variety of yellow to brown marble or limestone with markings resembling the outlines of ruins of buildings on a polished surface. Also called Florentine marble, Florence marble, pietra Paesina, paesinite, Paesina marble, pictorial marbel. Used as ornamental stones. → Paesinite.

**Rukshma;** an Indian term means avoid to wear an emerald is not cool which will bring disease. → Emerald colors and superstitious in Indian.

**rule of thumb;** a term used for cutting of gemstones depend on the color of the stone, table of gems with deep color should be cut parallel to *c*-axis and table of gems with pale color should be cut perpendicular to *c*-axis.

**Rumanian amber;** another term for rumanite.

**rumanite;** a brittle, yellow-brown to red, variety of



amber from Rumania containing 1-3% sulfur. Also spelled rumanite, Rumanian amber. Varieties are: almashite, and delatinite.

**rumbler**; a misleading term used by Australian for tumbler.

**run**; a term used in Australian for vein of opal or color which occurring in a crack created by fault in sandstone.

**run**; a term used in Australian for a seam of opal to go ahead in a particular direction.

**run**; same as grain.

**runite**; same as graphic granite.

**running lines**; lines on facets of a fashioned stone caused by grinding or polishing.

**running true**; same as true, true opal.

**run-of-gold**; monthly production of gold.

**run-of-mine**; unprocessed monthly production of a gemstone ore mine.

**rupture**; fracture or deformation.

**Ruspoli sapphire**; same as Raspoli Sapphire.

**Russalmaz**; an external sales organization of polished diamond and other gemstones from Russia in Canada, Germany, Belgium, Switzerland, and Singapore.

**Russia**; formerly USSR.

**Russian alexandrite**; alexandrite from Ural, Russia.

**Russian amethyst**; amethyst from Siberia, Russia.

**Russian chrysolite**; a misleading term for demantoid garnet from Ural, Russia.

**Russian crystal**; a misleading term for colorless selenite from Russia.

**Russian Diamond**; → Almazni Fund.

**Russian Diamond Fund**; an official and the world's most famous museum of gems, diamond, and jewelry collection, which contain Russian Regalia, and Romanoff Jewels in the Kremlin, Moscow. → Almazni Fund. Also called Russian Treasury of Diamonds and Precious stones.

**Russian emerald**; emeralds from Ural and Siberia, Russia.

**Russian Emerald**; a dark green emerald of 2800.00 cts, from Russia. Now on display at American Museum of Natural History in New York, USA.

**Russian gemstones occurring**; principal gems are: ruby and varieties, beryl and varieties, diamond, garnet and varieties, chrysoberyl, topaz, tourmaline and varieties, phenakite, turquoise, lapis-lazuli, quartz and varieties, chalcedony, feldspars and varieties, nephrite, diopside, obsidian, hemimorphite, jade, etc.

**Russian jade**; a green variety of nephrite from Russia.

**Russian jasper**; red sparkled jasper from Russia.

**Russian jet**; jet from Russia.

**Russian lapis**; a commercial term for lapis-lazuli from Russian Badakhshan and Lake Baikal area.

**Russian Portrait Diamond**; same as Russian Table Portrait Diamond.

**Russian synthetic hydrothermal emerald**; synthetic emerald made in Russia by hydrothermal method in steel autoclaves by inserting colorless beryl seeds but no additional precious metals. Optics;  $\omega$ : 1.773-1.779,  $\epsilon$ : 1.780-1.786. Birefringence: 0.006-0.008.  $\ominus$ . SG:2.68-2.70.

**Russian Table Diamond**; reportedly a diamond of 68 cts, has been seen among the Russian Crown Jewels in Moscow in 1882. No further information about the stone.

**Russian Table Portrait Diamond**; a flat, irregular, pear-shaped diamond of 25 cts, from India. Mounted in gold-and-enamel bracelet. Now on display in the Russian Diamond Fund. Also called Russian Portrait Diamond.

**Russian topaz**; topaz from Ural, Russia.

**Russian Treasury of Diamonds and Precious Stones**; same as Russian Diamond Fund.

**Russia-Sakha Diamond**; same as Almazny Rossii-Sakha.

**rusty gold**; natural gold, which has become coated surface by natural staining with iron oxide or silica.

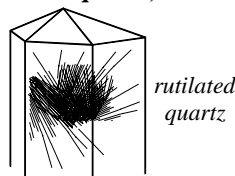
**rutania**; a commercial term for synthetic rutile used as a diamond imitation.

**rutee**; → rati.

**Rutenburg**; locations of small alluvial diamond deposit in Transvaal Province, South Africa.

**ruthenium**; a rare, hard, brittle, silvery white metal of platinum group of the Periodic System with the symbol Ru. Used in alloys and jewelry.

**rutilated quartz**; a variety of quartz containing rutile crystal needles as inclusions. Also known as sagenitic quartz, Venus's-hair stone, flèches d'amour. → Quartz inclusions, rutile.

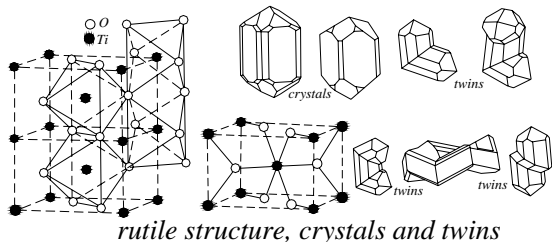


**rutilated quartz cut**; cut cabochon and occasionally step cut.

**rutilated topaz**; a commercial term for colorless and blue topaz from Brazil with brownish-yellow rutile inclusions visible to naked eye. Used as faceted gemstone.

**rutile**; it is trimorphous with anatase and brookite. Crystals are prismatic or acicular form. Acicular crystals as inclusions can be seen in many gemstones for example in quartz or topaz, which is called *rutilated quartz*, *rutilated topaz* and in quartz or agate as sagenitic. Also can be seen in corundum. Pleochroism in red, yellow, brown, green. Some transparent crystals are cut and faceted for gems and jewelry objects.

Varieties are: *Venus's-hair stone*, *flèches d'amour*, and *sagenitic quartz*. Has an obsolete name; edisonite. A synthetic rutile is made by the Verneuil flame-fusion



method, that is commercially known as titania, etc. Also called red schorl, money stone. → Rutile,-synthetic.

System: tetragonalic.

Formula:  $2[\text{TiO}_2]$ . Frequently contain Nb, Ta, and Fe.

Luster: metallic adamantine.

Colors: pale brown to yellowish or black, brownish-red, greenish, bluish.

Streak: yellowish-brown, brown to brownish-red, grayish.

Diaphaneity: transparent to opaque.

Cleavage: {110} distinct, and {100} less distincts.

Fracture: uneven. Brittle.

SG: 4.23-4.40.

H:6-6½.

Optics;  $\omega$ :2.62,  $\epsilon$ :2.90. ⊕.

Birefringence: 0.287.

Dispersion: 0.287.

Found in Russia, Switzerland, Brazil, Australia, Rumania, and Arkansas, Georgia, Carolina, California, and South Dakota (USA).

**rutile as inclusions;** rutile as inclusions can be seen in garnets, quartz, agate, sapphire, ruby, chrysoberyl, synthetic ruby and sapphire.

**rutile cut;** transparent crystals are faceted as gems but they are so dark that they look opaque and are cut cabochon and for jewelry objects. Black stone cut as mourning jewelry. Cut stones exhibiting doubling of bottom facets with great birefringence and has six times more fire than diamond.

**rutile needles;** → rutile.

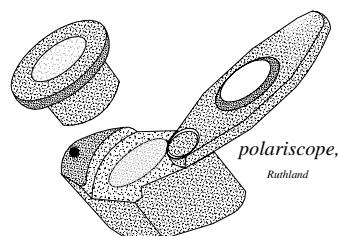
**rutile needles in quartz;** → rutilated quartz.

**rutile pleochroism;** shades of yellow, green, brown and red.

**rutile, synthetic;** → synthetic rutile.

**rutilio;** Spanish spelling for rutile.

**Rutland polariscope;** a small polariscope made for



microscopes to detect the double refraction of mineral or gemstones. → Polariscope.

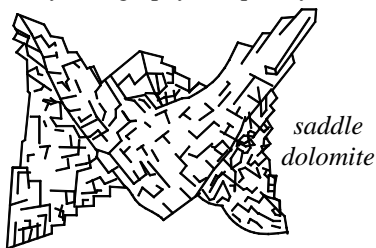
**ruttee;** → rati.

**ruw;** a Dutch term used by Dutch and Belgium diamond cutters to distinguish that the stones a rough or natural stone.

**ruyi;** a Chinese term for an auspicious double-curved scepter, carved from jade in combination with ru (meaning you) ani yi (meaning idea or thought). → Chinese ritual and symbol jades.

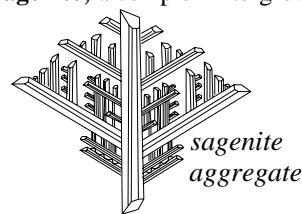
# S s

- S**; a chemical symbol for the element sulfur.
- saamite**; a variety of apatite containing 3-5% strontium oxide or other rare earths.
- sabalite**; a commercial term for banded variety of green variscite from Manhattan, Nevada, USA. Used as a gemstone. Also called trainite.
- sabarjad**; an Arabic term for peridot from Island Zeberjed, Red Sea.
- sabarjad**; a misleading term for emerald.
- sabarschah**; a corrupt and misleading Arabic term for emerald, because the term is for sabarjad or peridot.
- Sabkha**; Arabic term for desert or Kawir in Farsi.
- sábouni**; a Greek-Arabian term used in Persian, Indian and Arabian, etc., for a white and green mixture emerald. Also spelled sabuni, zabunijj.
- sabouni**; another spelling of sábouni.
- sac pearl**; → cyst pearl.
- saccharoidal**; a granular or crystalline texture, which resemble loaf sugar such as some sandstones, dolomites and marbles. Also called sugary, sucrosic.
- saccharoidal marble**; marble with a saccharoidal texture.
- Sacra Catina**; → Holy Grail, Cathedral of San Giovanni in Genoa.
- Sacra Catina glass**; Holy Grail, Cathedral of San Giovanni in Genoa.
- sacred turquoise**; a misleading term for light blue variety of smithsonite.
- Sacred Vessel**; → Holy Grail.
- sadbuks**; the name for pearl fishing-ship in Red Sea, also spelled sambuks?
- saddle**; a dressing diamond holder, wheel or tool that contains diamond crystals, which are used in the grinding of diamonds.
- saddle**; in crystallography frequently faces of some



crystal are curved similar to a saddle such as saddle shaped dolomite.

- saddle shaped**; → saddle shaped dolomite.
- saddle shaped dolomite**; frequently faces of dolomite crystal are curved and some of them so acutely as to form a saddle-shaped crystal.
- saddle stone**; same as apex stone.
- Saddle Hill**; location of alluvial diamond deposit in the Luderitz area of South West Africa.
- safety celluloid**; a synthetic cellulose acetate thermoplastic-plastic, which does not burn as easily as other celluloids. It smell vinegary when burnt or touched with the hot point of a needle the surface. RI:1.495-1.520. SG:1.29-1.40. H:2. Used as an imitation of amber, ivory, tortoise shell, etc. → Celluloid.
- safety precaution**; during testing of specific gravity of gemstones care should be taken using liquid ethylene dibromide or dibromoethane, because it is a suspected carcinogenic solution. Therefore the substance should not come into contact with the skin, or inhalation of vapor. No smoking while using volatile liquids such as carbon tetrachloride (CCl<sub>4</sub>). X-ray and ultraviolet apparatus, are also dangerous.
- saffron**; → crocetin.
- saffronite**; a rarely used term for a heat-treated citrine variety of quartz. Also spelled safronite and safranite.
- safranite**; same as saffronite.
- safirina**; a misleading term for blue variety of spinel or blue quartz.
- safronite**; same as saffronite.
- saga-the**; a Burmese term used for corundum stones of average 0.50 cts. → Corundum classification in Myanmar. Also spelled sagathai.
- sagathai**; same as saga-the.
- sagenite**; a complex intergrowth of an acicular variety of



rutile crystals, which occurs in reticulated slender, hair-like, or needle-like condition. Those often radiate from a common center in other

- minerals such as in quartz.
- sagenite**; any crystal of sagenitic form such as actinolite, tourmaline, goethite that occurs as an inclusion in quartz.
- sagenite**; rutilated quartz, which is known as sagenitic quartz or Venus's-hair stone, and flèches d'amour. Thetis hair stone is a quartz, which includes actinolite, tourmaline, goethite, epidote, or other crystals. → Quartz inclusions, rutile, rutilated quartz.
- sagenitic**; containing needle-like crystals as inclusions such as transparent quartz, in which acicular crystals of rutile, actinolite, tourmaline, goethite or other crystals

are included.

**sagenitic agate;** a translucent to semitransparent agate that contains acicular rutiles as inclusions.

**sagenitic quartz;** a variety of transparent rutiled quartz or sagenitic quartz, which is known as *Venus's-hair stone* and *flèches d'amour*. *Thetis hair stone* is a quartz, which includes actinolite, tourmaline, goethite or other crystals. Often cut as cabochon and sometimes are faceted. → Quartz inclusions, rutile, tourmalinated quartz, rutiled quartz.

**sagittarius;** same as Archer in zodiacal sign for month September. → Zodiacal constellation, birthstone.

**sahlite;** same as salite.

**sail;** a term used by Australian for a device like a scoop, bring it to the top of a ventilation to caught air and send direct down in the shaft.

**Saint Anne marble;** a dark blue-black variety of marble from Biesme, Belgium, which is white veined.

**Saint Augustine Mine;** location of a minute diamond pipe in Kimberley area, Cape Province, South Africa.

**Saint Baume marble;** a yellow variety of marble from Var, France, which is brown or red veined.

**Saint Edward's Crown;** British Imperial State Crown worn by Edward the Confessor, King of England (1042-1066). It was destroyed and later reconstructed by Sir Robert Vyner for the coronation of Charles II in 1662. Now the crown is in the form of a circlet set with pearls and 12 large stones outlined with diamonds clusters. It is ornamented with about 440 gemstones and weighs 1,800 grams (nearly 4 lb.). Also sometimes called Crown of England.

**Saint Edward's Sapphire;** a fine blue rose cut sapphire mounted with Black Prince Ruby and Stuart or Charles II's Sapphire in the Cross Formée on the British Imperial State Crown. Reportedly the stone was worn as a finger ring by Edward the Confessor, King of England (1042-1066).

**Saint Gotthard;** a region of the central Alps in Switzerland where many mineral of gem quality such as adularia, sanidine, sphene, nephrite, fluorite, etc. are found.

**Saint Miame diamond;** a misleading term for quartz crystal from Saint-Miame, France.

**Saint Peter sandstone;** sandstone quarried commercially from Illinois, USA.

**Saint Stephen's stone;** translucent, white or grayish variety of chalcedony spotted with tiny red spots. Also called Stephen's stone.

**sadja;** a Farsi jeweler term for smeared turquoise with butter, become darker color but the color is only temporary, also called *massiha* and *mescha*. → Turquoise classification in Nishabur, Iran.

**saka;** a Lithuanian term for resin or may be amber.

**Sakha;** a large diamond-bearing region in the Russian Federation, CIS. This autonomous republic is known as Yakutia, Siberia.

**sakai;** a Lithuanian term for resin or may be amber.

**sakal;** an Egyptian term for amber.

**sal;** an acronym for silicon-aluminum layer of the Earth's crust. Also spelled sail and called granite layer, granites layer.

**salaki;** a corrupt Farsi (Persian) term for shalgham or choghondar meaning rape with green stem used for emerald. Also spelled saluki, salughi, sulki.

**Salamanca topaz;** a misleading term for firey-colored citrine from Córdoba, not from Salamanca, Spain. Also spelled Hinjosa topaz.

**salam stone;** a transparent, pale red to blue variety of sapphire from Sri Lanka (Ceylon). Also spelled salamstone.

**salamstone;** same as salam stone.

**salina;** a term used for any deposit of halite or other soluble salt. Also spelled saline.

**saline;** same as salina.

**Salininha emerald;** natural green beryl minerals colored by vanadium from district Salininha, Brazil contain no chromium or only a trace of chromium, because of this the stone is classified as green beryl.

**salis gem;** an obsolete term for moonstone.

**salite;** a grayish-green, green to green-black intermediate member of diopside  $4[\text{Ca}(\text{Mg},\text{Fe})\text{Si}_2\text{O}_6]$ . Found in Northern Ireland, and USA. Used as a gem like as diopside. Also spelled sahlite.

**salted;** same as salting, fraudulent enhancement of mineral or gemstone samples.

**salting;** same as mine salting.

**salt-like grains;** a term used by Pliny for emerald inclusions.

**salt of amber;** another term for succinic acid. Also called amber salt.

**salt prism;** another term for rock salt prism.

**salt-water mussel;** → salt-water pearl.

**salt-water pearl;** pearl fished from any salt-water shell of the Persian Gulf, Red Sea, Gulf of Mannar, etc. such as Haliotidae, Pinctada, Placuna, Pinna, Mytilidae, etc. Also called sea mussel. → Pearl varieties.

**salughi;** another spelling for salaki.

**saluki;** another spelling for salaki.

**samadiam pearl;** a commercial term used in Sri Lanka for reddish, pear shaped pearl with a dull appearance.

**Samada Mine;** location of kimberlite open pipe diamond mine in Orange Free State, South Africa.

**Samantabhadra;** a Chinese term used for another Bodhisattvas figure sitting on the back of an elephant. → Chinese ritual and symbol jades.

**Samantha Smith;** a term applied to a fine-quality

diamond.

**Samaritan Spinel, the;** a gem spinel of 500 cts, now on display in the National Jewel Treasury of Iran, Teheran, open to the public.

**samarium;** a pale gray or silvery gray, metallic element of the rare earth group of the Periodic System with the symbol Sm.

**samaraskite;** cut into cabochon or as collectors curiosities, rarely faceted. Moderately to strongly radioactive. Also called ampangabeite, uranotantalite.

System: orthorhombic.

Formula:  $(Y,Er,Ce,Ca,U,Pb,Fe,Th)(Nb,Ti,Ta,Sn)_2O_6$ .

Luster: resinous, vitreous, semimetallic. Dull after alteration.

Colors: dark to velvet black, dark brown to yellowish.

Streak: dark reddish-brown.

Diaphaneity: opaque.

Cleavage: {010} indistinct.

Fracture: conchoidal. Brittle.

SG: 5.25-5.69 and variable.

H:5-6.

RI: 2.20. Metamicts.

Found in Russia, Norway, Malagasy, Japan, Zaire, Brazil, North Carolina, Colorado, and California, USA.

**samarrud;** a Farsi (Persian) term for emerald. Also spelled samurd, or somorod.

**Sambalpur Group;** location of historic alluvial diamond digging along the Mahanadi River in the north east of India.

**sambuks;** the name of pearl fishing-ship in Red Sea also spelled sadbuchs?

**Samland;** a formerly region of East Prussia (today a part of Kaliningrad Oblast, Russia, Kaliningrad in German is named Königsberg). Also called Peninsula of Sambia.

**Samland amber;** a formerly major amber production region of East Prussia (today a part of Kaliningrad Oblast, Russia, Kaliningrad of German is named Königsberg). Samland cliffs rise almost vertically from the sea.

**sammatti;** a Sinhalese (Sri Lanka) term for master of a fishing ship.

**sammyi;** another Myanmar (Burmese) term for byon.

**Sao Domingos Topaz;** a blue topaz from Brazil of 350.000kg in rough. Reference, of non-gem quality.

**somorod;** same as samarud.

**samotsvet;** natural color gemstone in Russian.

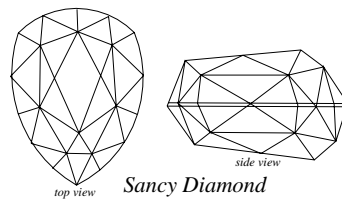
**samurod;** same as samarud.

**Sancy;** a pear-shaped diamond of 60.40 cts, owned by Maharajah of Patiala, India.

**Sancy Diamond;** a pear-shaped, double rose stone with a 5-sided table diamond of 55.23 cts, probably coming from India. It was bought in Constantinople by Nicolas

## Samaritan Spinel – sand hole

Harlay, Sieur de Sancy (1546-1629) in 1570. Later he lent it to Henry III and Henry IV of France. It was sold in 1604 to James I in England and was inherited by Charles I, son of James I. Queen Henrietta Maria wife



of Charles I, took it with other jewels to France, where it was forfeited to the Duke of Épernon, after non-payment of the loan. Purchased when

Cardinal Mazarin died. It was bequeathed to the French Crown in 1661 to Louis XIV. Earlier it had been pledged to a Spanish Marquess. Sold to Russian Prince Nicholas Demidoff in 1828 and purchased by William Waldorf Astor in 1892. In 1978 bought by the Banque de France and Musées de France. Now it is exhibited in the Louver Museum in Paris. Also called Grand Sancy. Not to be confused with Sancy, Astor Sancy. → Little Sancy.

**Sancy Diamond, the Little;** → Little Sancy Diamond.

**sand;** a small fragment of detrital rock with a grain size of 0.06 mm to 2 mm in diameter, mostly composed of quartz and easily distinguishable to the unaided eye.

**sand;** a sorting grade for rough diamond.

**sand;** a trade term for diamonds obtained in form of gravels. → Sands.

**sandalwood jade;** a descriptive Chinese term for a particular variety of jade.

**sandarach;** same as red arsenic.

**sandarchar;** a Chinese term for a three-cut cicada made of jade. → Chinese ritual and symbol jades.

**sandawana;** a pegmatite dike contains small colorful emeralds near Sandawana, Zimbabwe, Africa.

**Sandawana emerald;** location of small colorful emerald from Sandawana, Zimbabwe, Africa.

**sandbagger;** a term used by Australian miners for an opal thief who uses violence.

**sandbagger;** same as ratter.

**sand diamonds;** a commercial term for smaller rough gem diamonds, which are named as *sand* that can pass through a 1.78 mm (or 0.070-inch) sieve. → Melée, diamond sorting.

**sand diamonds;** a trade term for diamonds obtained in the form of gravels.

**sanded;** a term used by Australian miners for defects in opal formed due to penetration of sand grains into opal. Also called sandspotty.

**sand hole;** a term used for a minute fissure or fracture remain on the surface of a glass, caused by the rough grinding and not been removed later by subsequent fine grinding.

**sand hole;** a term used in Australian for a minute cavity remain in the material where opal occurs round in sandy stone.

**sand hole;** a term used for a small cavity in stone.

**sand-shot;** a term used by Australian for defects usually formed when sand damages gem opal.

**sand-shot opal;** a term used by Australian for opal caused by sand shot. Also called shot, sand-shot.

**San Diego County;** a gem-bearing region of California, USA, where such minerals as beryl, topaz, tourmaline, and spessartite garnet are found.

**San Diego ruby;** a misleading term for rubellite a red variety of tourmaline from San Diego, California, USA.

**San Domingo amber;** a misleading term for transparent, yellow to brownish fossil resin variety of retinite from San Domingo, West Indies.

**sanding;** a procedure of final polishing stage occurs where abrasive action is very fine grit 320-400, for stones of greater hardness than 8 fine grit 600 to remove deep scratches on the surface. Mostly applied for cabochon cut with garnet paper, emery cloth or silicon carbide cloth. For final polishing of colored stones of greater hardness than 8 fine grit of levigated alumina, tin oxide, chrome oxide cerium oxide, and Linde A. are used.

**sanding disk;** a device with a sheet of wet or dry silicon-carbide paper or like that mounted vertically on a wheel disc, when mounted horizontally it is known as lap.

**sanding wheel;** an aluminum or plywood wheel disc mounted with sanding paper vertically or horizontally on it for polishing.

**sandpaper;** a heavy paper, cloth or leather with a thin coating of fine sand, which is glued on one side and used, as an abrasive sheet. → Sand.

**sand rock;** a term applied to a sandstone, which is not firmly cemented.

**sand rock;** same as sandstone.

**sands;** particles of crushed ore in a mill.

**sands;** fragments of detrital rocks or crushed ores that they settled in water. → Sand.

**sand-shell;** an elongated and extremely long (15 cm) and flat shell, used to make buttons. Also called Lampsilis

**sand-shot;** same as sand-shot opal.

**sand-spit;** a term used by Australian miners for a lump of sand in an opal rock, which when removed leaves a sand hole. → Sand hole.

**sand-spit;** a applied to a spit composed mainly of sand.

**sandspotty;** same as sanded.

**sandstone;** a cemented or compacted sedimentary rock comprising of grains between diameters of 0.06 mm to 2 mm, the main constituents are quartz, feldspar, mica,

generally rock particles, and heavy mineral grains. According to the nature of binding or cementing materials, varieties are argillaceous, siliceous, calcareous, ferruginous, etc. Sandstones are classified as arenaceous rocks. Also called sand rock.

**sandstone;** a term used in Australian for main cemented or compacted sedimentary rock of cretaceous age comprising of grains which overlies the opal-bearing dirt and clay. The Thickness of sandstones varies up to 15-20- meters. Sandstone becomes hardening to a silicified bandstone before opal dirt is reached.

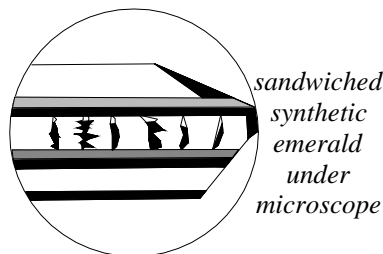
**sandstone boulder;** a term used in Australian for sandstone in which spheroidal or ellipsoidal ironstone of different sizes and irregular occurred

**sandstone opal;** a term used in Australian for sandstone covered all free opal.

**sandstone opal;** opal found in sandstones alternating layers of thickness to 25 mm or more.

**sand track;** a term used by Australian miners for those thread of sand through opal material which interfering the value of it.

**sandwich emerald;** a term applied to layered synthetic



emerald made by Lechleitner.

**sandwich smaragd;** a German term applied to layered synthetic emerald made by Lechleitner.

**sandwich stone;** a jewelers commercial term for doublet or triplet stones.

**sandy sard;** translucent sard mineral sprinkled with dark spots.

**sandy whisker;** an informal term used by Australian miners for those opal with only small streaks of color or frequently with reddish iron discoloration.

**sangandhike;** a Hindu term for bright ruby of red-orange lotus flower dashed with blue, which resembling with the leaf of asoka tree, also may be a spinel. → Saraca indica.

**sang de boeuf;** same as ox-blood citrine.

**sang de boeuf;** a red glaze produced in China during the Sung dynasty. Coloring agent was copper.

**sang de boeuf citrine;** a reddish-brown variety of citrine quartz. Used as gemstone. Found in Brazil and Malagasy. Also called sang de boeuf.

**sang de boeuf citrine cut;** cut as faceted gemstones in various sizes, cabochon, or are tumbled.

**sang de boeuf glass**; → copper-ruby glass.

**sange-sakhat**; a Farsi term for hard green stone (generally hard stone), composed of copper component and other minerals. → Turquoise imitation in Iran.

**sang-i-yashm**; → sang-i-yeshan.

**sang-i-yeshan**; a Persian or Farsi word: sang-i-yashm, meaning jade. A misnomer for dark-green bowenite from Punjab, Afghanistan, and northeastern China. Used as amulets, knife handles, and artistic articles.

**sanguinaria**; a Spanish term including both heliotrope and hematite. → Piedra de sangra.

**sanidine**; a high-temperature polymorphous, disordered, glassy variety of alkali feldspar group identical in chemical composition with orthoclase:  $(K,Na)AlSi_3O_8$  but physically different. Monoclinic and often tabular crystals. Colorless to light-gray to yellowish-brown. Formed under different conditions and occurring in different rock types. Optics;  $\alpha$ :1.518-1.527,  $\beta$ :1.522-1.533,  $\gamma$ :1.522-1.534. Birefringence: 0.005-0.007.  $\ominus$ . SG:2.57-2.62. H:6. Found in Texas, Oregon and California (USA), Mexico, and Germany. Also called ice spar, glassy feldspar, rhyacolite.

**sanidine cut**; cut as faceted gems.

**sanipriya**; → sapphire, name of.

**sanmartinite**; an isomorphous mineral with wolframite, and isostructural with ferberite and huebnerite of chemical composition:  $2[(Zn,Ca,Mn,Fe)(WO_4)]$ . Monoclinic Crystal. Blackish-brown color. Resinous luster. SG:6.60-6.70. Hardness not determined. Cleavage: {100} distinct, and {010} distincts. Sometimes cut as gemstones. A colorless, transparent synthetic sanmartinite has been produced, which is doped with  $YVO_4$ , used as an imitation stone.

**San Pedro de Las Bocas**; location of alluvial diamond deposits in the upper part of the Paragua and Caroní Rivers in Venezuela.

**Santa Elena**; location of alluvial diamond deposits in the Gran Sabana Field, Venezuela.

**Santander**; a local term for translucent, banded, bluish-green smithsonite in Spain.

**saphir d'eau**; a misleading French term for water sapphire, which is applied to an intense-blue variety of cordierite or iolite and topaz. Topaz was found as waterworn gravel in the river of Sri Lanka.

**saponite**; a soft, massive, soapy, white, greenish, bluish or reddish mineral of the phyllosilicate of the montmorillonite groups. Monoclinic crystal. Greasy luster. Optics;  $\alpha$ :1.480,  $\beta$ :1.486-1.493,  $\gamma$ :1.50-1.59. Birefringence: 0.012.  $\ominus$ . SG:2.20-2.30. H:1-2. It has an unctuous feel, but does not adhere to the tongue. Used as ornaments or for carving decorative objects. Found in Michigan, Ontario (USA), and Lizard (Scotland). Also called soapstone, bowlingite, mountain soap,

## *sang de boeuf*– sapphire absorption

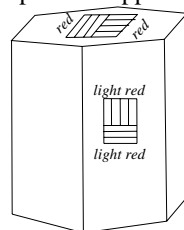
piotine. Plombières saponite is misleading term for clay mineral.

**sappare**; a synonym for sapphire.

**sappare**; a synonym for translucent cyanite. Also spelled sapper.

**sapper**; same as sappare.

**sapphire**; any pure, transparent, gem-quality corundum other than ruby, specially the blue color variety of corundum. Blue color being due to traces of oxides of cobalt, chromium, and titanium. Sapphire color ranges from light-blue, to dark velvety blue (shades of blue). Other colors, which are known as *fancy sapphire* are colorless, purple sapphire, pink sapphire, yellow sapphire, brown and black. Sapphire shows strong dichroism and often asterism. Some specimens alter their color in daylight and artificial light. Slightly different tones or hues or different colored zones in transparent sapphires are classified as phantoms or ghost crystals.

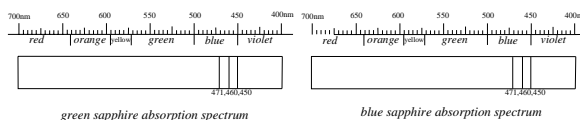


*dichroismus of sapphire an optic uniaxial crystal*

Misnomerly so-called *Oriental topaz*' is a yellow sapphire and *Oriental emerald* is a deep green

sapphire, and purple sapphire is misnomered as *Oriental amethyst*. Some stones from South and South East Asia are heat-treated or irradiated. Used as cut gemstones and obtained from Sri Lanka, Myanmar, Kashmir, Thailand, Cambodia, Australia, Tanzania, and India. Stones of fine blue color from India do not change their color in different lights, this is named as *bleed*. It is a *birthstone* for September. Colorless sapphire often used as a diamond imitation. Synthetic sapphire and ruby in various colors is made by different manufactures. Also called blue corundum, sappare. → Corundum, ruby.

**sapphire absorption spectra**; ferric iron spectrum



*green and blue sapphire absorption spectrum*

dominates in green and blue-green, most common lines are at 470, 460, and 450 nm.

**sapphire, Brazilian;** a misleading term for blue tourmaline, or blue topaz from Brazil.

**sapphire cat's-eye;** impure stones with a silk effect have minute, needle-like inclusions of rutile, are cut cabochon, show asterism or cat's-eye (one ray) effects. → Ruby cat's-eye.

**sapphire color treatment by X-rays;** iron-rich yellow and greenish-blue sapphire from Sri Lanka turns color to a yellow topaz by bombardment of X-rays, therefore the color is not permanent and revert to its original color, when subjected to sunlight or heat about 239° C.

**sapphire colors;** the color of blue sapphire is apparently caused by combination traces of oxides of iron and titanium replacing aluminum in corundum structure. The color of green sapphire caused by a mixture of two yellow and blue sapphires. The color of yellow sapphire is caused by charge of oxygen to metallic iron (O → Fe<sup>+3</sup>) or combination of ferrous and ferric iron to a pair (Fe<sup>+3</sup> Fe<sup>+3</sup>). Orange colored sapphire is a mixture of red and yellow. Dark brown or black sapphire contains hematite and impurities.

**sapphire color centers;** after Nassau and Valente 1987 there are seven kinds of yellow to orange sapphire because of color center: (a) natural stable color center from Sri Lanka, (b) natural or treated-irradiation lightening color center from Sri Lanka, (c) natural iron-create stable color from Thailand, Tanzania and Australia, (d) heat-treated stable color from Sri Lanka, (e) surface-diffused additional color, (f) Verneuil synthetic sapphire with impurity of nickel and (g) Verneuil synthetic sapphire irradiated lightening color center.

**sapphire colors terminology in Thai, some;** a classification of sapphire color used in Thailand by Gemological Institute (AIGS). Type-A, is a rich royal blue color to violet but darker than type-c. Type-B, a rich royal blue color but slightly silky or milky. Type-C, a cornflower-blue but lighter than type-A. Type-D, a very dark inky blue. Type-H, a pure yellow sapphire without greenish or brownish of Sri Lankan-type. Type-K, a dark-yellow orange sapphire with brownish overtone. Type-L, a greenish yellow sapphire without brownish overtone like type-k. → Ruby colors terminology in Thai, some.

**sapphire crystals;** sapphire crystallized in trigonal system, bipyramidal spindle-shaped, hexagonal prism columnar-shaped, tabular prism, trigonal rhombohedron, and other combinations.

**sapphire cut;** mostly sapphires are fashioned as brilliant or mixed cut or in various step-cut form, sometimes cut cabochon, when dichroism shows beads are formed, and tumbled. → Ruby star-cut direction.

**sapphire, defects of Hindu;** there are six kind of

defects with the name Avarka, Trasa, C'itraka, Mridgarva, Asmagarva and Raukshya.

**sapphire glass;** blue-colored glass used as sapphire imitation.

**sapphire green;** green sapphire contains iron and the spectrum bands are at 450, 460, and 471 nm.

**sapphire heat-treatment;** heat treatment of the corundum gem materials have been applied in South East Asia as in Mogok, Myanmar to improve transparency and remove silk effect or induce asterism in ruby and sapphire, lighten the dark color in sapphires and rubies, improve the colors of rubies and sapphires, induce natural feature inclusions in natural and synthetic sapphire or ruby such as fingerprint. → Sapphire surface diffusion, heat treatment of sapphire and ruby.

**sapphire, inclusions in;** → inclusion in sapphire.

**sapphire, luminescence;** generally sapphires are inert under SWUV, and LWUV light and X-rays, except stones from Montana (USA), Sri Lanka, and India (Kashmir), which exhibits a cloudy red to yellowish apricot glow. → Sapphire color treatment by X-rays.

**sapphire, name of;** a name may derived from Sanskrit term of *sanipriya* (sani for Saturn and priya for noble), or Farsi (Iranian) *sépéhr* for sky, sphere, sky-colored, blue-colored, in Hebrew *sappir* for blue stone and in Assyrian *sipru* meaning hard blue stone. In ancient time, sapphire was listed under *hyacinth* with other stones not always in blue color such as topaz, quartz, zircon, etc.

**sapphire, occurrences;** corundum gemstones such as ruby or sapphire are metamorphic minerals mostly in limestone, dolomite, gneiss and schist. In igneous rocks such as granite and nepheline syenite.

**sapphire, lux;** a misleading term for blue iolite.

**sapphire, lynx;** a misleading term for pale blue iolite.

**sapphire powder;** → alumina, aluminum oxide, aloxite.

**sapphire, purple;** purple sapphire is misnomered as Oriental amethyst.

**sapphire quartz;** a misleading term for light sapphire-blue chalcedony. Used as gemstones.

**sapphire quartz;** a rare, opaque, sapphire-blue variety of quartz containing fibers of silicified crocidolite. Used as a gemstone. Also called azure quartz, blue quartz, siderite (obsolete). → Hawk's-eye.

**sapphire quartz;** a sapphire-blue variety of silicified crocidolite obtained in Salzburg, Austria. Used as gemstones.

**sapphire spar;** kyanite or disthene crystal with opalescence effects.

**sapphire, spinel;** a misleading term for sapphire-blue spinel according to ruby spinel.

**sapphire, star;** same as star sapphire.



**sapphire, star cut;** → ruby star-cut direction.

**sapphire surface diffusion;** for improving the color and appearance of some pale-colored stones such as corundum or sapphire, the composition of surface layers of a pre-fashioned gemstone were altered by means of diffusion method by high temperatures. The pale-colored stone were heated at 1750° C for 96 hours, and embedded in a fine dust of alumina containing suitable color agent such 6% Cr and 22% Ti oxide. Also used color transition elements such as Fe, and Ni oxide. The thickness of this blue colored layer is ca. 0.5 mm. For detection of diffusion-coated stone the stone is put in di-iodomethane with RI:1.74, the thin coated blue layer can be seen by diffused transmitted radiation. This treatment also induces the asterism and alteration of fingerprint inclusion in the stones, which is useful for detection. → Sapphire heat-treatment.

**sapphire, synthetic;** → synthetic corundum, synthetic ruby.

**sapphire, synthetic white;** synthetic white sapphire used as a diamond imitation.

**sapphire, synthetic yellow;** yellow color synthetic sapphire.

**sapphire, water;** a misleading term for dark blue iolite.

**sapphire, white;** natural white sapphire used as a diamond imitation.

**sapphire yellow;** natural yellow sapphire.

**sapphire, inclusion in;** → inclusion in sapphire, inclusion in corundum.

**sapphire, star;** → star sapphire.

**sapphirin;** same as sapphirine.

**sapphirine;** a misleading term for blue quartz.

**sapphirine;** a misleading term for blue chalcedony.

**sapphirine;** a misleading term for sapphire-blue spinel.

**sapphirine;** a misleading term for cobalt blue-colored glass, all of them used as sapphire imitation. Also spelled sapphirin.

**sapphirine;** a silicate mineral rarely faceted as gems.

System: monoclinic.

Formula:  $4[\text{Mg,Al}]_8(\text{Al,Si})_6\text{O}_{20}$ ].

Luster: vitreous.

Colors: pale blue, bluish, greenish-gray, shades of blue, sometimes purplish.

Streak: colorless.

Diaphaneity: transparent.

Cleavage: {010} distincts.

Fracture: subconchoidal to uneven. Brittle.

SG: 3.40-3.50.

H:7½.

Optics:  $\alpha$ :1.716,  $\beta$ :1.721,  $\gamma$ :1.723.

Birefringence: 0.007. ⊖.

Found in Italy, Sri Lanka, India, England, Malagasy, Greenland, South Africa, Scotland, Quebec

(Canada), and USA.

**sapphirized titania;** a commercial term for synthetic rutile used as a diamond imitation.

**sappir;** a biblical term for fifth stone in the Jewish High Priest Breastplate, it means sapphire or lapis lazuli. Engraved the name Issachar.

**sappir;** → sapphire, name of.

**sap rock;** same as stained rock.

**sap stone;** another term for amber, which comes from succus for gum or resin.

**Saraca indica;** a kind of showy tree of the family *Leguminosae* with orange flower from tropical Asia, the leaf of this tree compare with a kind of spinel in Indian with the name sangandhike.

**Sarasota Jemeter Digital;** an infra-red digital instrument for direct measurement and readout of refractive index and double refraction of gemstones down to 0.01. Manufactured in USA.

**sarcolite;** sometimes faceted as a gemstone and prized by collectors.

System: tetragonal. Pseudo-cubic.

Formula:  $4[(\text{Ca,Na})_9(\text{Al,Si})_4(\text{SiO}_4)_6\text{O}_2]$ .

Luster: vitreous.

Colors: reddish-white, rose red.

Streak: colorless.

Diaphaneity: translucent.

Cleavage: no diagnostic.

Fracture: conchoidal. Very brittle.

SG: 2.92.

H:5½-6.

Optics;  $\omega$ :1.604-1.640,  $\epsilon$ :1.615-1.657.

Birefringence: 0.011-0.017. ⊕.

Found in Monte Somma, Mount Vesuvius, Italy.

**sarcophagus;** a kind of limestone was used by ancient Greeks for coffins. Also called stone coffin.

**sard;** A commercial term for translucent, uniformly colored light to dark brown or deep orange-red variety of chalcedony or sometimes variety of carnelian. Also called sardius, sardine. → Carnelian.

**sard;** a term for a variety of banded agate, which is similar to sardonyx in coloring. This found near the Aegean coast of Turkey.

**sard agate;** a variety of banded agate, which is similar to sardonyx or sard in coloring.

**sard and sardonyx;** sard is dark reddish-brown, sardonyx is sard with white bands.

**sardinia;** a variety of smithsonite occurs on the coast of Island Sardinia, Italy.

**sardinia;** coral fished on the coast of Island Sardinia, Italy.

**Sardinian coral;** an Italian trade classification for hard and excellent quality of red coral. → Coral,-trade classification of.

**Sardinian coral;** coral from Sardinian Island, Italy.

**sardium;** a term applied to artificially brown colored sard.

**sardius;** same as sard.

**sard, name of;** a Farsi-Hebrew term for a variety of banded agate, which is similar to sardonyx in coloring.

**sardoine;** a French term for dark variety of carnelian.

**sardónice;** Spanish term for sardonyx.

**sardonyx;** a gem variety of reddish-brown colored sard with white or black banded chalcedony or onyx, used to make cameo with the raised black, red or brown background. Misnomerly the term used for carnelian and sard. → Carnelian.

**sardonyx cut;** cut cabochon and tumbled. Mostly sardonyx are carved as cameo, in which the relief being worked in the white layer with raised black, red or brown background.

**sard shell;** a hollow cabochon of sard, which is hollowed out from the back to improve the color. → Shell cut.

**sard stone;** a term frequently applied to sard.

**sard stone;** a term occasionally applied to sardonyx.

**SAREMCI;** an acronym for Société de Recherches et d'Exploitations Minières en Côte D'Ivoire.

**sarium;** a term applied to artificially stained sard.

**sark stones;** a commercial term for a variety of amethyst formerly obtained from Sark a channel island off England. The term now applied to amethyst material from Brazil.

**sark stones;** a term applied to amethyst colored glass. Also spelled sarkstone.

**sarkstone;** same as sark stone.

**sarraku (pearl fishing);** a local term used by pearl fisheries for the remaining debris of shells in a ballam (fishing boat) in Gulf of Mannar. The finally searching for small pearls is done by women.

**satelite;** a commercial term for fibrous serpentine with slightly chatoyant effects. It resembles chrysotile. Found in Tulare County, California, USA.

**satellite readings;** → float, Kerez effects.

**satellites;** indicator minerals that are associated with diamond such as garnet, ilmenite, diopside, rutile, and zircon. → Indicator minerals.

**satin;** removing deep scratches on the surface of a cut diamond after grinding has left a dull surface, this is named satin, satiny finish or semi-gloss.

**satin glaze;** a semi-matt glaze with a characteristic satin appearance.

**satin spar;** a fibrous, translucent, silky luster, white variety of gypsum, when cut cabochon shows pearly chatoyant effects. Cut as cabochon, beads, slabs and carving objects. Also called satin spar gypsum, satin stone, Atlas stone, fibrous gypsum, Atlas spar.

**satin spar;** a term used less correctly for a fine fibrous, translucent, silky white or pink variety of calcite or aragonite, when cut cabochon shows pearly chatoyant effects. Found in Alton Moor, North USA. Also called satin spar calcite, or calcite satin spar.

**satin spar calcite;** → satin spar.

**satin spar gypsum;** → satin spar.

**satin stone;** → satin spar.

**satiny finishing;** → satin.

**saturation;** a degree of color responsible for vividness of colored of stones. Also called color saturation, purity, chroma. → Color,-definition.

**saturation;** description of state of a liquid that can normally take up no more solution under the given conditions.

**Saturn inclusions in ruby;** a feature can be seen in Thailand and Cambodia rubies in which the solid or negative crystals are surrounded by liquid inclusions similar to fingerprints which are unique in appearance like Saturn.

**saualpiti;** an original and obsolete term for zoisite.

**Saukville Diamond;** a rough diamond of 6.57 cts, found in 1881 near Saukville, Wisconsin, USA.

**saupurnam;** a Sanskrit term applied emerald.

**saussurite;** a rough, compact, moss-green, white-green or greenish-gray to white, altered rock. It is an alteration product of albite feldspar, zoisite, or epidote, with variable amounts of mica, calcite, prehnite, etc. Used as jade imitation. RI:1.57-1.70. Birefringence: 0.013. ⊖. SG:3.20-3.40. H:6-7. Found in Switzerland, and Lake Superior (USA). It has an absorption band at 455 nm.

**saussurite;** a massive variety of zoisite is used as a jade imitation.

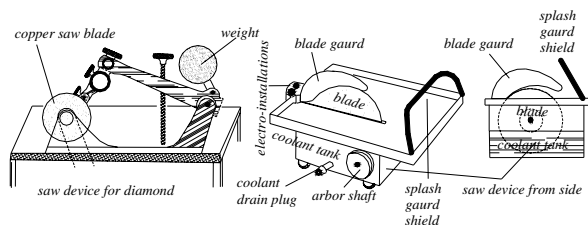
**sautoir;** a long neck chain of approximately equal-sized beads, worn by women loosely from shoulders extended down to below the waist. It is 80 to 110 cm (31 to 47 inch) in length. Also called lariat.

**Savoy Diamond;** a table-cut diamond of 54 cts, that was reported by Tavernier in the 17<sup>th</sup> century among the Crown Jewels of the House of Savoy, France. Present owner unknown.

**sawable;** rough diamonds or other mineral goods having blocky shape so that can be divided by sawing before being polished.

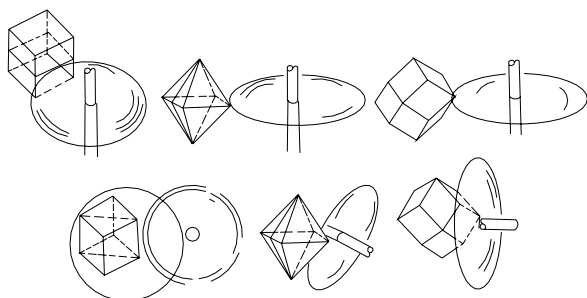
**sawing;** a process used to cut a diamond or other gemstones into two or more parts in directions other than the cleavage directions. It is carried out by a phosphor bronze disc charged with diamond abrasive powder and olive oil or castor oil for diamond crystals and other gemstones, running at 5,000 to 10,000 rev/min. For softer stones a sheet of soft iron is used under the same process. The sawing of diamonds was

discovered in modern times and new ways of grinding and polishing were achieved, therefore it was believed



*saw apparatus for diamond and other stones*

that it is possible as too to split diamonds in the same



*sawing diamonds in different directions*

way, but till today is not a suitable machinery for this purpose developed. Because most gemstones have a relatively inferior hardness to diamonds are much easier and quicker to fashioned them than diamond.

**sawing diamond;** → sawing.

**sawing dop;** a brass retainer, in which a diamond is soldered to be held during sawing.

**sawing grain;** → grain.

**sawing of rough stones;** → sawing.

**sawing other gemstones than diamond;** → sawing.

**sawing rate;** the time required to saw through a diamond stone.

**sawyer;** a diamond cutter who is responsible for sawing diamonds or sawing machines.

**Saxon chrysolite;** a misleading term for greenish-yellow topaz. Also called Saxony chrysolite.

**Saxon diamond;** a misleading term for colorless topaz. Also called Saxony diamond.

**Saxon Diamonds;** a large historic collection, which included the Dresden Green, Dresden White, and many others, were supposedly more than 7000 old carats in weight. The collection was started by Augustus the Strong Duke of Saxony (1670-1733). They are now on display in the Green Vaults (Grüne Gewölbe) in Dresden, Germany.

**saxonite;** a peridotite rock composed mainly of olivine

*sawing diamond - scalenohedron*

and orthopyroxene. Used as ornamental stone.

**Saxon topaz;** a misleading term for citrine a yellow variety of quartz. Also called Saxony topaz.

**Saxon White Diamond;** same as Dresden White Diamond.

**Saxony;** east part of Germany.

**Saxony beryl;** a misleading term for apatite from Saxony, Germany.

**Saxony chrysolite;** same as Saxon chrysolite.

**Saxony diamond;** a misleading term for colorless topaz. Also called Saxon diamond.

**Saxony topaz;** same as Saxon topaz.

**sayadi;** same as sayyadi.

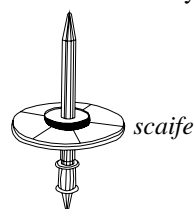
**sayyadi;** an Arabic-Farsi term for hunter. A term used in Indian for a variety of emerald when looked upon may be able to seen a man with eyes shut. Also spelled sayadi.

**Sb;** a chemical symbol for the element antimony.

**sbaragd;** an Arabic corrupt term of zabargad for epidote but here for emerald.

**Sc;** a chemical symbol for the element scandium.

**scaife;** a horizontal, cast-iron, rotating mill or grinding wheel of 31 to 46 cm. in diameter, used for grinding and polishing facets on diamonds, running at 2,500 to 5,000 rev/min. Usually is charged with diamond



powder and olive oil or other liquid (castor oil). The diamond is doped in a holder. Scaifes are often charged with diamonds powder

by manufactures and used for colored stones. Also spelled skaif, skeif, skaaf, skief, scaive. Also called loopkring, mill, lap.

**scaive;** same as scaife.

**scale;** any various balances or devices used for weighing.

**scale;** a standard of measurement, in which the units or degrees are defined in relation to what is determined for example hardness scale, temperature scale, weighing scale, etc.

**scale;** chart or graphic representation.

**scale;** loose, thin, flat particles of rocks or minerals such as sericite, micas, graphite, plate or tabular crystals.

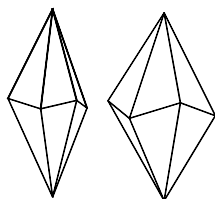
**scale;** the crust of metallic oxide formed by hammering, or cooling of hot metals in air.

**scale;** a thin, compact, flaky, horny crust of the protective coating of the body certain fishes used to produce essence d'orient. → Flaky.

**scale;** a term applied to map scale.

**scalenohedron;** a closed crystal form with 12 scalene triangle faces in hexagonal scalenohedron and 8 faces

in tetragonal scalenohedron.



ditrigonal scalenohedrons

**scalenohedral**; adjective of scalenohedron.

**scale of hardness**; same as hardness scale.

**Scallop Shell**; a symbol or pattern of St. James made of jet, which is a symbol of eternity and pilgrim.

**scaly**; a mineral consisting of scales or having scaly aggregate such as mica.

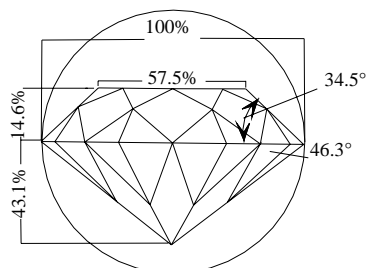
**scaly mineral**; same as scaly.

**SCAN**; a term applied to scanning laser acoustic microscope.

**scandium**; a gray-silvery, white metallic element of rare-earth of the Periodic System with the symbol Sc.

**Scandinavian diamond nomenclature and grading standard**; a standard grading system for polished diamonds was introduced in 1970. This standard had a guideline for clarity grading, color grading and nomenclature, cut grading, description, and certification. Abbreviation: Scan. D.N. → Appendices.

**Scandinavian standard round brilliant**; a standard cut of brilliant for maximum brilliance by suitable proportions and symmetry ratios calculated by Herbert Tillander. Proportions are: height of crown 14.60%,



proportion of facets and their angles on an ideal Scan DN brilliant cut. The angles are related to girdle diameter

pavilion depth 43.10%, table diameter 57.50%, and crown height to pavilion depth ratio 1:2.95.

**Scan. D.N.**; a semi-abbreviation for Scandinavian diamond nomenclature and grading standard system (for fashioned diamonds).

**Scan. D.N. brilliant cut**; same as Scandinavian standard round brilliant.

**Scan. D.N. clarity scale**; a classification of fashioned diamonds according to their clarity using the standard nomenclature suggested by Scan. D.N.: flawless (FL) and internally flawless (IF), very very slightly included

two subgrades VVS<sub>1</sub>, VVS<sub>2</sub>, very slightly included two subgrades VS<sub>1</sub>, VS<sub>2</sub>, slightly included two subgrades SI<sub>1</sub>, SI<sub>2</sub>, and piqué included three subgrades piqué<sub>1</sub>, piqué<sub>2</sub> and piqué<sub>3</sub>. → Appendices.

**Scan. D.N. color scale**; color grading in polished diamonds ranges from colorless to yellow, traditional terms and descriptions are: River (Rarest White), Top Wesselton (Rare White), Wesselton (White), Top Crystal (Slightly Tinted white), Crystal (Slightly Tinted White), Top Cape (Tinted White), Cape (Slightly Yellowish), Light Yellow (Yellowish), Yellow (Yellow). Sometimes River described into GIA letter grade: River (D), and River (E). → Appendices.

**Scan. D.N. scale for the quality of cut diamond**; describing and evaluating the proportion and finishing of a fashioned diamond with regard to their brilliance, dispersion, and relationship between them. Four main grades and 10 subgrade descriptions: very good divided into 2 vg (+), vg (-), good divided into three g (+), g (0), and g(-), medium divided into three m (+), m (0), m (-), and poor divided into two p (+), p (-). → Appendices.

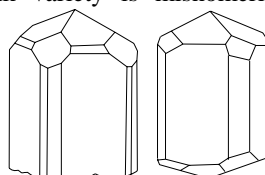
**scanning**; process of repeating and recording of a mosaic in a cathode-ray tube by means of focused electron beam.

**scanning electron microscope**; a device, which enables the study of the surface structure of a specimen to be examined, it creates visual three dimensional images of the small fragments with great depth also opaque objects by means of a focused beam of electrons (or X-ray) in an electrical or magnetical field. The resulting second electrons from the surface of the sample being proportional to the geometry and other properties of the specimen. Also called scanning microscope, electron microscope.

**scanning microscope**; same as scanning electron microscope

**scapolite**; a rare gem mineral cut cabochon and faceted.

A group of minerals forming a solid solution isomorphous series between marialite  $3[\text{Na}_3(\text{AlSi}_3\text{O}_8)\cdot\text{NaCl}]$  and meionite  $3[\text{Ca}_3(\text{Al}_2\text{Si}_2\text{O}_8)\cdot\text{CaCO}_3]$ , mizzonite is an intermediate mineral. Other intermediate minerals of the scapolite are wernerite, dipyrte. and dipyre. Also called wernerite. Opalescent pink variety is misnomerly called *pink moonstone*,

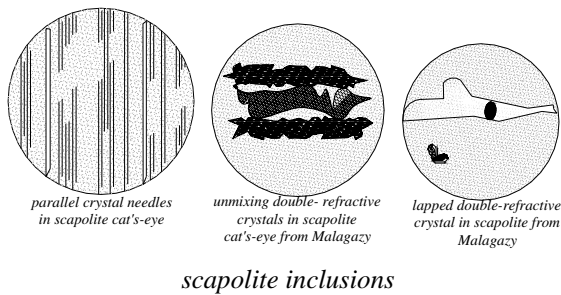


scapolite crystals

pinkish red variety is known as *wilconite*. Some pale pink, pale yellow, and blue-violet variety from Myanmar shows

chatoyancy effect, when cut in the correct direction

caused by parallel rod-like cavities.



System: tetragonal.

Formula: an isomorphous mineral series between marialite and meionite  $(\text{Na,Ca,K})_4[\text{Al}_3(\text{Al,Si})_3\text{Si}_6\text{O}_{24}](\text{Cl,F,OH,CO}_3,\text{SO}_4)$ .

Luster: vitreous to resinous, pearly on cleavage.

Colors: colorless, white, gray, deep blue, bluish-gray, pink, purple, red, brown, yellow, orange, orange-yellow.

Streak: white.

Diaphaneity: transparent, translucent to subtranslucent.

Cleavage: {110} distinct, and {100} less distincts.

Fracture: conchoidal to uneven. Brittle.

SG: 2.50-2.78. Increase with meionite.

H:6.

Optics; of marialite  $\omega$ :1.546-1.550,  $\epsilon$ :1.540-1.541, and of meionite  $\omega$ :1.568-1.571,  $\epsilon$ :1.550-1.552.  $\ominus$ .

Birefringence: 0.004-0.008 for marialite to 0.024-0.037 for meionite.  $\ominus$ .

Dispersion: 0.017.

Found in Brazil, Malagasy, Myanmar, Tanzania, Kenya, Canada, Sweden, Norway, and Mozambique.

**scapolite absorption spectrum;** absorption spectrum bands of pink and violet scapolite in the red at 663, and 652 nm in yellow spectrum because of chromium.

**scapolite cat's-eye;** pale pink, pale yellow, and blue-violet variety of scapolite from Myanmar shows perfect cat's-eye, when cut cabochon.

**scapolite cut;** faceted gems are seen in step-cut, and cut cabochon because cat's-eye in pale pink variety from Myanmar.

**scapolite pleochroism;** deep-blue, violet and lavender-blue in pink and lilac stones. Colorless, yellow and light yellow in yellow to colorless stones.

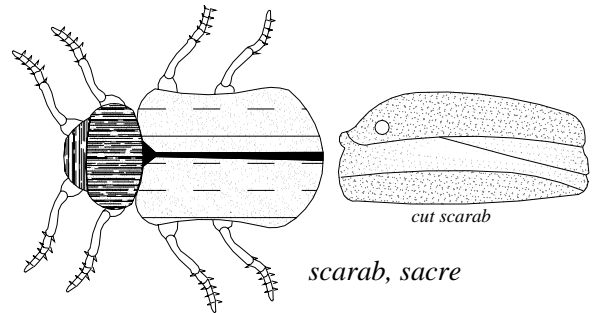
**scapolite luminescence;** yellow fluorescence under LWUV light and pink under SWUV light of scapolite from Myanmar and under X-rays it glows in pinkish-orange.

**scapolite yellow;** pale yellow varieties from Myanmar have chatoyancy effects.

**scarabs;** steatite, other stones, metals or Egyptian faience carved in the form of a scarabaeus beetle specially *Scarabaeus sacer*, which was worn by ancient Egyptians as an amulet of fertility, immortality and

### *scapolite absorption – scattering light*

resurrection usually with an inscription cut on the flat base. The scarabs beetle being the symbol of the god of the morning sun, called *Khepera*. The form of carving



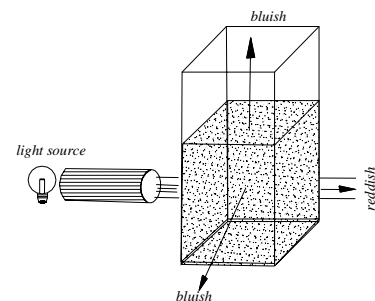
varied from well formed shaped to only a bare outlines and was frequently carried out the human head. It was used for ornaments and symbols or talismans in form of pendants or finger rings and were buried with the dead. When the carved inscription on the base is in the form of an intaglio it is used as a seal such as a finger ring seal. Later they were copied by other cultures such as Phoenicians, Greek, Etruscans, etc.

**scarab ring;** finger rings in several forms with an ornament in the form of a scarab stone made by Egyptian from steatite, gemstones, metals or Egyptian faience, which were later copied by Phoenicians, Greek, Etruscans and other.

**scaraboid;** a modification of Egyptian scarab made in Greece.

**scattered emission;** → stimulated emission.

**scattering;** deflection or irregular reflection or change in direction of light from the main direction by passing



*scattering of light passing through diluted milk*

through a medium such as fine particles of solid, liquid, or gaseous matter. Also called → dispersion.

**scattering, blue;** blue scattering can be observed from particles smaller than 0.0003 mm, which is 300 nm and smaller than 400 nm wavelength of violet light. Scattering of blue or violet light depends on the size of scattering particles.

**scattering;**

**scattering light;** → Tyndall effects.

**scattering of light;** → Tyndall effects.

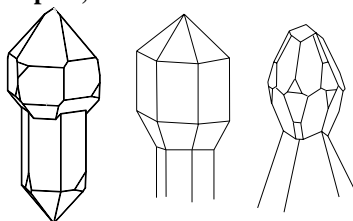
**scenic;** stones containing dendritic inclusions, which are arranged resembling a natural pattern or scene. → Scenic agate.

**scenic agate;** same as landscape agate.

**scenic jasper;** jasper that has fanciful pattern which may resemble sceneries such as landscape, ocean wave, etc. → Landscape agate, ruin agate.

**scenic landscape;** → landscape agate, scenic jasper, ruin agate.

**scepter;** a rod or baton borne in the hand by a sovereign as an emblem of regal or imperial authority. It was used by several cultures made of gold and sometimes



quartz scepters, an overgrowth

decorated with animals figures such as dove, eagle or mounted the Hand of Justice.

**Scepter Diamond;** same as Orloff Diamond.

**scepter like quartz;** same as scepter quartz.

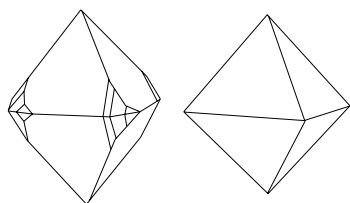
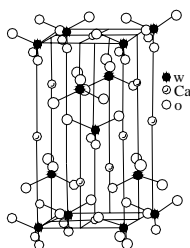
**Scepter of Harun-al-Rashid;** allegedly, an emerald or beryl regalia scepter belonged to Harun-al-Rashid calif of Baghdad (746-809 A.D.). It was carved from a single piece of emerald and was capped with a carved ruby bird. The whereabouts of this scepter in unknown.

**scepter quartz;** quartz crystal resembling a scepter in outline. Also called scepter like quartz.

**Schaumberg diamond;** a misleading term for a variety of quartz crystal from Schaumberg, Germany. Used as a diamond imitation.

**scheele's green;** → copper arsenite.

**scheelite;** an isomorphous mineral with powellite. The yellow color resembles the colored diamond. It is easy



scheelite crystals and crystal structure

to distinguish, while strong double refractive and less hardness. Sometimes cut as faceted gems and prized by collectors. Tungsten is an obsolete term.

System: tetragonalic.

Formula:  $4[\text{CaWO}_4]$ .

Luster: vitreous to adamantine.

Colors: colorless, white, gray, pale yellow, violet, yellowish-white, reddish, brown, orange-yellow, green.

Streak: white.

Diaphaneity: transparent to translucent.

Cleavage:  $\{101\}$  distinct, and  $\{112\}$  less distincts.

Fracture: conchoidal to uneven. Brittle.

SG: 5.90-6.30.

H:  $4\frac{1}{2}$ -5.

Optics;  $\omega$ : 1.918-1.920,  $\epsilon$ : 1.934-1.937.

Birefringence: 0.016.  $\oplus$ .

Dispersion: 0.038.

Found in Switzerland, Korea, Sri Lanka, Mexico, Japan, France, Germany, Italy, Canada, Australia, the Czech Republic, England, Peru, Bolivia, and USA.

**scheelite cut;** cut as very attractive faceted gems.

**scheelite luminescence;** bluish white fluorescence in SWUV ray, sometimes dull yellow. Inert under LWUV.

**scheelite absorption spectrum;** spectrum at 584 nm in yellow and green, when stone contains molybdenum.

**scheelite synthetic;** clear various colored crystals of synthetic scheelite produced by the Czochralski pulling process. Cut as gems.

**schemochrome;** color of a feather, reflected from within the feather through refraction of light and structure of feather independed from pigments. → Biological coloration, feather.

**Schettler Emerald;** an Indian emerald of 87.64 cts, now on display at the American Museum of Natural History, New York City, USA.

**schiller;** an optical phenomenon of variously colored metallic iridescence of some minerals just below the surface caused by the reflection of light from small lamellar inclusions, cavities or cracks within a stone or parallel to the passage of rays from one layer to another. Schiller is related to sheen, can be seen in moonstone, bronzite, bastite, etc. Schiller effect can be produced by alteration of some stones by heat treatment. A synonym for play of color. → Adularescence, aventurescence, schillerization.

**schiller chrysolite;** a misleading term for chrysoberyl cat's-eye.

**schillerization;** the development of play-of-color or metallic iridescence due to the arrangement of small lamellar inclusions within the crystals. → Schiller.

**schiller obsidian;** schiller effect that can be seen in some obsidians.

**schiller quartz;** same as quartz, cat's-eye.

**schiller spar;** the first applied the name schiller was first applied to bastite a variety of ortho-pyroxenes, composition near to serpentine. An opaque, leak-green to dark-green variety of altered enstatite or bronzite having approximately the composition of serpentine.

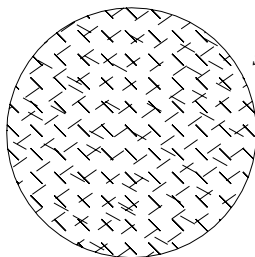
Optics;  $\alpha$ :1.730,  $\beta$ :1.735,  $\gamma$ :1.791. Birefringence: 0.061.  $\ominus$ . SG:2.6. H:3½-4. Found in Germany. Also known as bastite.

**schillerization**; artificial production of schiller effect in some gems by means of heat-treatment such as when synthetic white spinel becomes schiller effect and is used as a moonstone imitation. To indicate from other gemstones it has a bright blue-white fluorescence under SWUV light.

**schist**; a strongly foliated, crystalline regional metamorphic rock characterized by a parallel arrangement of the bulk of constituent minerals such as mica, chlorite, talc, feldspar, hornblende, emerald, etc., which can be readily split into thin slabs or flakes.

**schist, mica**; same as mica schist.

**schistose**; easily to split. Closely foliated texture due to planar fabric of micas or similar minerals.



*schistosity:  
sheet minerals  
arranged  
parallel in  
one direction  
due to one  
directional  
pressure*

**schistose quartzite**; → firestone.

**schlossmacherite**; a trigonal crystal with chemical formula:  $3[(\text{H}_3\text{O}, \text{Ca})\text{Al}_3(\text{AsO}_4, \text{SO}_4)_2(\text{OH})_6]$ . Shades of green color. Resinous luster. Similar to turquoise. RI  $\approx$  1.597. Often associated with coeruleite. Found in Guanaco, Chile.

**schmelze glass**; any kind of glass, which is colored red by metallic salt such as gold or copper.

**schmelze glass**; a misleading term for a kind of glass made in Alexandria in Roman times, which was green in color, but red in transmitted light.

**schnapperskin triplet**; a variation of triplet made of red or blue-dyed fish skin layers. It is to be discerned by gray color of skin at the girdle. Used to imitate opal doublet.

**schnecken topaz**; same as schneckenstein topaz.

**schneckenstein topaz**; true topaz from schneckenstein, Saxony, Germany.

**schnide**; a term used by Australian miners for glassy, bluish common opals which are found in large pieces but almost valueless, also described as potch. Found in Queensland, Australia.

**schistosity**; characteristic parallel foliation in schist or other coarse-grained crystalline rock caused by plane parallel arrangement of constituent mineral grains, which are platy, prismatic or ellipsoidal, usually mica.

**Schoongezicht**; location of a small alluvial diamond deposit in the Christina area, Transvaal province, South

Africa.

**Schottky defect**; a singly ion (charged atom), can not be absent in a crystal structure when electrical neutrality of crystal is preserved, but a pair of electrically balanced ions (positive and negative), or vacancies can be absent and removed to the surface of the crystal. → Defects in crystal and color effect.

**Schutsekama**; location of a small alluvial diamond deposit in the Herbert area, Cape province, South Africa.

**schorl**; a black, iron-rich, opaque variety of tourmaline. Formula:  $3[\text{NaFe}^{3+}\text{Al}_6(\text{Si}_6\text{O}_{18})(\text{BO}_3)_3(\text{OH})_4]$ . Crystal system trigonal. Optics;  $\omega$ :1.660-1.671,  $\epsilon$ :1.635-1.650. Birefringence: 0.017-0.035.  $\ominus$ . SG:3.10-3.24. H:7. Used as a mourning jewelry. Intensive color of schorl-dravite series decreases from black-brown to light brown to colorless because of decreasing in Fe-content. Also spelled shorl, schorlite, schüerl.

**schorl**; a term used sometimes for dark blue tourmaline which is intergrowth with fine-grained bertrandite found in South Crofty, Cornwall, England.

**schorl**; an obsolete term for any dark to black colored mineral other than tourmaline such as hornblende.

**schorl**; a modern substitute for jet.

**schorl agua marina**; a misleading Spanish term for epidote. French spelling: schorl aigue-marine.

**schorl aigue-marine**; French spelling for schorl auguamarine.

**schorlemite**; a titanium rich black variety of andradite garnet. SG:3.78-3.90. H:6½-7½. IR:1.872-1.935. Also misleadingly called melanite.

**schorlfels**; a term for tourmaline quartz rock.

**schorlschiefer**; a term for tourmaline quartz rock.

**schorlite**; same as schorl.

**schorlite**; a term applied to dravite-schorl series.

**schorlomite**; a term used for titanium garnet.

**schorlomite**; a misleading term for black tourmaline.

**schorlous beryl**; a misleading term for light pink pycnite a variety of topaz.

**schorlquartzite**; a term for tourmaline quartz rock.

**schorl rock**; a granular rock consisting essentially of needle-like crystals of black tourmaline or schorl and quartz. It results from the end product of tourmalinization of granite. Also called tourmaline quartz rock.

**Schottky defect**; → Frenkel defect, color center.

**schraufite**; a reddish fossil rein with general formula  $\text{C}_{11}\text{H}_{16}\text{O}_{12}$ . Found with lignite and jet in Russia and Austria.

**schrötterite**; an obsolete term for opal-allophane.

**Schüller Mine**; same as Lena Mine.

**schüerl**; an old term for schorl.

**Schweizer Reneke**; a town where diamonds are dug and

location of small alluvial diamond deposits in Transvaal Province, South Africa.

**science of rocks;** same as petrology. Also called rock science.

**scientific alexandrite;** an obsolete and erroneously used term for vanadium oxide colored synthetic corundum or sapphire with color change which imitate alexandrite. The color change is reddish-green in daylight and much redder in artificial light. → Alexandrine sapphire, vanadium in synthetic corundum.

**scientific brilliant;** a misleading term for colorless synthetic sapphire.

**scientific emerald;** a misleading commercial term for chromium oxide green-colored beryllium glass or beryl glass, which is known as fused emerald with the emerald composition. → Beryl glass.

**scientific emerald;** a misleading term for green synthetic corundum or spinel.

**scientific emerald;** a misleading term for any green colored glass. Used as an emerald imitation.

**scientific gems;** same as scientific stones.

**scientific hematite;** a misleading term for a metallic alloy resembled hematite, used as a hematite imitation.

**scientific ruby;** a misleading term for red ruby glass.

**scientific sapphire;** a misleading term for sapphire blue glass.

**scientific stones;** a term applied to synthetic, reconstructed, or imitation gemstones. Also called scientific gems.

**scientific topaz;** a misleading term for topaz colored glass.

**scientific topaz;** a misleading term for pale pink colored synthetic sapphire and to imitate topaz.

**scintillation;** countless number of alternating flashing or sparkling of light from the polished facets of a gemstone, when the stone is turned between light source and the observer. Displaying of spectrum colors.

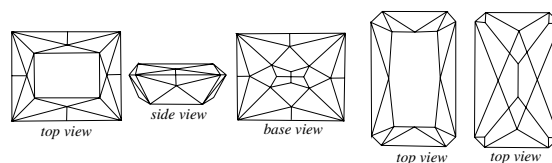
**scintillation;** the brilliancy of polished stones and degree of the returned light to the eye after refraction and reflection back out through the crown.

**scintillation;** an examination method of radioactive treated diamond, the stone placed on a zinc-sulfide screen in darkness, when the stone is examined with a magnifier can be seen tiny flashing light representing the effect of alpha-particles, which striking the phosphorescence screen. Also called sparkle.

**scintillation;** → radioluminescence.

**scissors cut;** a variation of rectangular step-cut diamond and other transparent gemstones, in which 4 sided crown main facets surrounding the table are cut as 4 elongated triangular facets meeting at an apex. This style of cut is used to increase the scintillation of diamond and other transparent gemstones of lower

refractive index such as quartz, beryl, tourmaline, and topaz. Also called cross facet.

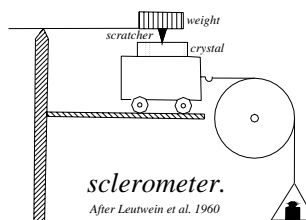


two different kind of scissors cut or cross cuts

**sclera;** the hard outer coat layer of eye consisting of fibrous, acting as a protective layer between sclera and retina. → Eye.

**sclore;** a term applied to skeletal element.

**sclerometer;** a device for relative numerical measuring the degree of hardness of a mineral by means the pressure on a moving diamond point necessary to effect a scratch under a known



pressure.

**scleroprotein;** → conchiolin.

**solecite;** a rare mineral of the zeolite group. Two minerals natrolite and mesolite having nearly the same properties. Usually in delicate radiating aggregate. Cut as cabochon or faceted gems.

System: monoclinic.

Formula:  $8[\text{Ca}_2(\text{Al}_2\text{Si}_3\text{O}_{10}) \cdot 3\text{H}_2\text{O}]$ .

Luster: silky to vitreous

Colors: colorless, white, greenish, reddish, yellowish, brownish.

Streak: colorless.

Diaphaneity: translucent to opaque.

Cleavage: {110} distincts.

Fracture: Brittle.

SG: 2.10-2.40

H: 5-5½.

Optics:  $\alpha$ : 1.512,  $\beta$ : 1.519,  $\gamma$ : 1.520.

Birefringence: 0.098. ⊖.

Found in Poonah (India), Isle of Mull (Scotland), Ural (Russia), and Colorado (USA).

**scoops;** a miniature spoon-like shovel used to move diamond. → Diamond shovel, shovels.

**scoop stone;** ambers dredged along certain shores of Baltic Sea, North Europe. Also called drawn-amber.

**Scorgie Diamond;** a golden-yellow diamond of 21 cts, found in Kimberley Mine, South Africa. Named after its discoverer. Sold to a Scottish doctor, was cut in



England. Present whereabouts unknown.

**scorodite**; a mineral of mansfieldite or scorodite series. Rarely cut as gemstones but prized by collectors.

System: orthorhombic.

Formula:  $8[\text{Fe}^{+3}(\text{AsO}_4)\cdot 2\text{H}_2\text{O}]$ . Soluble in HCl.

Luster: vitreous to resinous.

Colors: leek green, pale green, yellowish brown, brown, grayish green.

Streak: greenish white.

Diaphaneity: transparent to translucent.

Cleavage: {120} imperfect.

Fracture: subconchoidal. Brittle.

SG: 3.28-3.40.

H: 3½-4.

Optics:  $\alpha$ : 1.785,  $\beta$ : 1.796,  $\gamma$ : 1.816.

Birefringence: 0.031. ⊕.

Found in Minas Gerais (Brazil), England, Namibia, Ontario (Canada), Japan, Mexico, and California, Idaho, Washington Nevada, Utah, and South Dakota, USA.

**scorodite absorption spectrum**; one spectral line in the green at 450 nm.

**scorodite luminescence**; strong bluish to purplish pleochroism.

**scorpion hill garnet**; an early garnet mine in New Mexico, Arizona and Utah, USA where large ants and scorpions were constructed the sites by using of garnet grains.

**scorpion stone**; another term for coral.

**scorpion stone**; a synonym for jet.

**scorzalite**; an end member of lazulite series. Chemical formula:  $(\text{Fe}, \text{Mg})\text{Al}_2(\text{PO}_4)_2(\text{OH})_2$ . Monoclinic crystal. Blue to blue-green. Optics;  $\alpha$ : 1.629,  $\beta$ : 1.655,  $\gamma$ : 1.66. Birefringence: 0.032. ⊖. SG: 3.38. H: 5½-6. Used as gem. Found in Brazil.

**scotch and water**; a term used for irregular color swirls inclusions in natural and Chatham synthetic rubies similar to scotch and water. Also known as treacle and heat wave.

**Scotch cut**; a modified brilliant-cut rarely used for large stones.

**Scotch pearl**; fresh-water pearl fished from many river in Scotland. Also called Scottish pearl.

**Scotch pebble**; a misleading term for rounded fragment varieties of quartz or agate, carnelian, and cairngorm, found in some river-gravels and on the shingle beach of Ayrshire and Kincardineshire, Scotland. Used as gem material specially for articles of Highland dress.

**Scotch pebble**; red and green moss agate pebbles found in diverse sources in Scotland.

**Scottish pearl**; same as Scotch pearl.

**Scotch stone**; a misleading term for cairngorm from Scotland. Also called Scottish stone.

**Scottish stone**; same as Scotch stone.

**Scotch topaz**; a local misleading term for cairngorm from Scotland.

**Scotch topaz**; a local misleading term for smoky quartz from Scotland.

**Scotch topaz**; a local misleading term for citrine from Scotland, used as gemstone. Also called Scottish topaz.

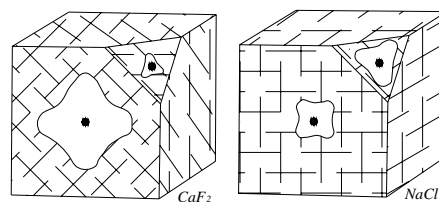
**scotophore**; a term applied to material, usually potassium chloride that darkened under electron bombardment, which used for display of radar or cathode radiation tubes. It means dark-bearer.

**Scottish topaz**; → Scotch topaz.

**scratch**; same as striation. Narrow, shallow abrasion marks on the surface of a diamond, which can be seen by means of magnification, caused by rubbing with other stones.

**scratched**; in ceramics industry making ornaments with rough scratches in the paste.

**scratch hardness**; any minerals resist once to scratching, which in the hardness scale will scratch



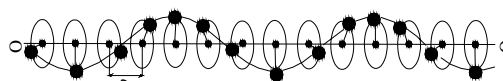
*scratch hardness curves on the cubic and octahedron crystal surfaces*

those of lower numbers and be scratched by those of higher number. Same as micrometer gauge. Also called scratching hardness.

**scratch test**; → scratch hardness.

**screening**; a term applied to separating of various-sized gravels, usually by using water, rotating, vibrating, or shaking to eliminate large and very small particles of stones.

**screening**; a term used by Australian miners for separating of various-sized gravels by using of wire screen to eliminate large and very small particles of dirt and leave concentrates material to be searched for opal.



*screw rotation symmetry*

**screw axis**; a type of crystal symmetry element, which

is combined, with a rotation of  $360^\circ/n$  and translation.  $n$  may be 1,2,3,4, or 6.

**screw dislocation;** same as rolled garnet. → Beryl surface growths features.

**screw micrometer;** → micrometer, millimeter screw micrometer.

**scriber;** a pointed steel tool or an aluminum pencil used for making an incised mark on metal or gemstone to guide cutting operation.

**scribbling ring;** rings mounted with octahedral crystal of diamond with the point of a 4-sided pyramid, once was known as scribbling ring.

**scrubber;** a recovery device, in which coarse and sticky ore is washed free from clay or other adherent substances. Used on broken kimberlite in the diamond mines.

**sculptured growth;** a term used for natural etching on stones especially on brownish-green tourmaline such as nepheline-bearing pegmatite from Seiland, Norway.

**scum;** a term used rarely in Australian for loss of brilliance, a blemish that appeared with the age as a film over the surface of opal stone.

**Scythian emerald;** emerald from Scythian district, once north-east of Khorassan, Persian. Today Izumrud district in Russia. Sometimes called Cythia.

**Scythian emerald;** frequently a misleading term for diopside from this district.

**Se;** a chemical symbol for the element selenium.

**sea amber;** amber, which has been scooped along certain shores, in contrast to pit amber. Sea ambers are semi-polished because of action with sand and partly with water and some of them are smoothed on all surfaces.

**sea amber;** ambers washed out from sea bed, due to their low density.

**sea cucumber;** small eel-like fish (but it is not eel), which is a member of Carapidae living as parasites inside of Holothuroidea and as parasite enters the pearl-bearing oyster and become trapped and coated, with nacreous secretion to create a pearl. Also called béche de mer. → Pearl fish.

**sea deposit;** same as marine deposit.

**sea horse ivory;** ivory items made from the teeth of the hippopotamus.

**sea mineral;** same as submarine mineral such sea diamond from South Africa. Also called marine mineral, subsea mineral, undersea mineral.

**seals;** seals are small printing intaglio incised coat-of-arms or symbols carved on stone or metal used to indicate something. Frequently the depression left as-is or filled with metal. Seals have been made from gold, agate, carnelian, coral, faience, glass, etc. Flat form of them is called *stamp seal*, in the form of a cylinder is

named *cylinder seal*, those are mounted on a ring known as *signet rings* or *seal ring* and also set on a *shank*. → Cylinder.

**seal cylinder;** → cylinder.

**seals ring;** same as signet ring. → Seals.

**seam;** a thin tabular or flat deposit. A thin vein of metallic minerals in a stratum or bed.

**seam;** a term used in Australian for veins of opal deposit, usually runs in seams through horizontal levels, which occur in form of desert sandstone. Found in White Cliffs, Australia.

**sea mining;** same as beach mining

**sea mussel;** → salt-water pearl.

**seam opal;** opals occurring in sandstone.

**seam opal;** white fine gem-quality opal (precious opal) which has been embedded as thin veins in common opal from White Cliffs, New South Wales, Australia. Seam opal can always recognized by the matrix surface, which occurs on each side of the piece. Also called vein opal.

**Sea of Glory Diamond;** a diamond of 66 cts, Once believed to be among the Iranian Crown Jewels, but no report in 1966 by Meen and Tushingham, from this diamond. Present owner unknown.

**Sea of Light Diamond;** same as Darya-i-Nūr Diamond.

**Searcy Diamond;** a well-formed hexahedron diamond crystal of light-yellow color of 27.21 cts, found in 1925 near Searcy, Arkansas, USA. Now on display in its rough form by Tiffany & Co. New York City. Also called Arkansas Diamond.

**sea stone;** → floating amber.

**seastone;** amber fished from sea. → Floating amber.

**sea washed jet;** jet, which has been scooped along certain shores.

**seaweed agate;** a variety of mocha stone that contains inclusions like sea algae.

**sebedschedget;** a corrupt spelling of zeberged.

**seberget;** another spelling of Zeberged.

**second;** a term used by Australian miners for a level running quasi parallel below the existing bed.

**secondary;** arising later. Minerals or rocks formed from pre-existing minerals or rocks by decay, altering, or decomposition.

**secondary color;** a color obtained by mixing two primary colors such as red and yellow to make orange.

**secondary deposit;** same as alluvial deposit.

**secondary diamond deposit;** same as alluvial diamond deposit.

**secondary group of rocks;** an old term used for rocks of the Mesozoic era.

**secondary liquid inclusions;** a term used for cracks filled with growth liquid and healed. The healing may take place after stopping the growth of host. Also

called epigenetic inclusions. → Inclusions.

**secondary minerals;** minerals resulting from alteration of pre-existing mineral (primary mineral) by decay, altering, or decomposition.

**secondary mineral deposits;** same as secondary minerals.

**secondary optic axis;** one of two optic axes in a crystal along, which all electromagnetic light rays travel with equal velocity.

**secondary rocks;** rocks formed from pre-existing rocks by decay, altering, or decomposition.

**secondary spectrum;** an optic term used for residual chromatic aberration between red and blue image in a multiple glass lenses corrected to bring two wavelengths to the same focus. Between red and blue image exist yellow image.

**secondary twinning;** twin formed by gilding or pressure within a pre-existing crystal or crystalline mass. → Polysynthetic twinning, repeated twinning.

**second bye;** an obsolete term for color-grading of rough diamonds, which are white slightly-yellow. That is second quality of byewater. → Bye (diamond).

**second cape;** an obsolete term for color-grading of rough diamonds that are white slightly-yellow.

**secondo coloro;** a coral color classification for salmon rose used in Italy.

**second order bipyramid of beryl;** doubly terminated beryl crystal (closed form), faces of these forms could appear at both ends, may growth as elongated prism of [h0h 1], which is called second order bipyramid.

**second water;** a slightly lower quality than first water. → Water, first water.

**Secretaris Mine;** location of small diamond mine in Kimberley area, South Africa.

**sectile;** capable of being tenacious enough cut with a knife as into a slice without breaking into pieces, such as gypsum, talc, etc.

**sectile mineral;** → sectile.

**sectility;** a mineral is sectile, when cut with a knife it slices and it will not crumble or crack, but is not malleable, such as gypsum, talc, etc.

**section;** → thin section.

**secundina;** a clay sheet, which often covered the diamond bearing mines in western Minas Gerais, Brazil.

**sediment;** settling and deposition of particles of rock and mineral under gravity force that being transported by water, which has accumulated in layers, together with material of organic origin.

**sedimentary marble;** same as crystalline limestone

**sedimentary rocks;** rock formed by the deposition and compression of rock and mineral particles which has accumulated in layers, together with material of organic

origin. The term included both consolidated and unconsolidated material. Sedimentary rocks may be classified as (a) terrigenous (breakdown of pre-existing rock), (b) organic (produced by organic process), (c) chemical (precipitation from water), (d) volcanogenic (pyroclastic). Also called stratified rock, derivative rock.

**sedimentation;** the act of settling of particles under gravity force that being transported by water.

**sea foam;** synonym for sepiolite.

**seed crystal;** a minute, suitable piece of crystal introduced into a supersaturated solution in order to initiate crystallization or crystal seeding.

**seed crystal;** a small natural crystal around, which another natural crystal or crystals may grown. May can seed plate used instead seed crystal, which are slices of natural stone such as beryl swan parallel to *c*-axis and right angles to the prism  $m\{101\ 0\}$  in 2mm dick.

**seed jewelry;** seeds and stones of fruit used to make various article of jewelry.

**seed pearl;** very small round or occasionally baroque shaped pearl, natural or cultural that weighed less than ¼ grain. Used as gems and ornamental or jewelry articles. Mounted in some jewelry as openwork in pavé setting. Fished in the Gulf of Mannar between India and Sri Lanka.

**seed plate;** → seed crystal.

**seeing with both eyes;** same as binocular vision.

**seeing with one eye;** same as monocular vision.

**see through effect;** → transparent, transparency, window.

**segment;** an individual part of a gemstone, mineral, or rock.

**Segima Diamond;** reportedly a diamond of 70 cts, has been seen in 19<sup>th</sup> century by Sultan of Matan, Island Borneo, Asia.

**Seiko synthetic corundum;** a method to produced corundum or emerald by melt-growth technique, which is known as floating-zone process. The stones appear dusty caused by gas bubbles in various sizes, irregular color swirls, rectilinear parting and secondary lamellar. RI:1.561-1.565. Birefringence: 0,004. SG:2.66. Hattori Seiko emerald or corundum are red, blue and orange in color, corundum from Novosibirsk, Russian Federation is red.

**sekaninaite;** same as iron cordierite.

**selbite;** same as gray silver.

**selected natural diamond;** a method for selecting natural abrasive diamond or mineral grains, mechanically.

**selective absorption;** the absorption of electromagnetic radiation of certain wavelengths or frequencies in preference to others as in colored stones and pigments.

Absorption lines or bands in the spectrum depend on the chemical component and crystal structure of the gemstone. All substances show selective absorption.

**selective reflection;** reflection of certain wavelengths of light usually by opaque gemstone in preference to others.

**selective transmission;** that part of color which results from a combination of wavelengths reach the eye such as a stone which has absorbed blue tone, will be red. Also called complementary color. The human eyes are not equally sensible to all colors for example mostly is sensible to green color. Diopase and emerald are deep green in color, while the emerald transmitted the red wavelength yet diopase absorbs most of red spectrum.

**selenita;** Spanish term for moonstone feldspar.

**selenite;** a transparent, colorless variety of gypsum occurring in crystals or cleavage. Used as an ornamental. Spectacle stone is an obsolete and popular name for selenite. Also called fine crystallized gypsum, spectacle stone, clear transparent gypsum.

**selenite plate;** same as gypsum plate.

**selenites;** an obsolete term for moonstone feldspar.

**selenium;** a nonmetallic element with the symbol Se in the sixth group of the Periodic System. It is used as decolorizer in glass industry in red orange glasses and enamels. Resembling sulfur in properties.

**selenium glass;** a red orange glass used as filter.

**selenium spectrum;** selenium is a red color agent in glasses shows absorption bands in the green at 532, 537, 540, and 560 nm.

**selenolite;** a rock composed of gypsum and anhydrite.

**self-colored;** → idiochromatic.

**self-darkening glass;** → photosensitive glass.

**self-darkening sunglass;** → photosensitive glass.

**sellaite;** a rare mineral isomorphous with rutile. Rarely cut as gems.

System: tetragonal.

Formula:  $2 \text{ [MgF}_2\text{]}$ .

Luster: vitreous.

Colors: colorless, white

Streak: white.

Diaphaneity: translucent.

Cleavage: {010} perfect, and {110} perfect.

Fracture: conchoidal. Brittle.

SG: 3.285.

H: 5-5½.

Optics:  $\omega$ : 1.379,  $\epsilon$ : 1.389.

Birefringence: 0.011. ⊕.

Found in Norway, Italy, France, Russia, and Brazil.

**selwynite;** an ornamental, fine-grained, opaque green rock composed chiefly of green chromium muscovite-mica or fuchsite and compact clay. Formed from altered material of basalt. RI: 1.55. SG: 2.79-3.11. Found in

Victoria, Australia and Saxony, Germany.

**semargad;** a Chaldeic term for emerald.

**semeline;** synonym for spinthère.

**semence;** French term for seed pearl.

**semetic liquid crystal;** whole the molecules are straight but perpendicular layers. → Liquid crystal.

**semibastard amber;** partly cloudy amber, between bastard and bone amber.

**semi-black;** a term used by Australian miners for a kind of transparent opal with stronger concentration of potch color than crystal. Also called in Chinese ts'ung.

**semicarnelian;** an obsolete term for yellow carnelian.

**semiconducting crystal;** a term applied to a crystal of a semiconductor property such as silicon, germanium, diamond Type IIb.

**semiconductor;** a crystal material having conductivity intermediate between that of a conductor and a non-conductor. The effect increases with rising temperature and presence of impurities, such as diamond Type IIb. Electrical semi-conductivity is depend on two factors: extrinsic semiconductor or intrinsic semiconductor or both.

**semiconductor band-gap colors;** sequence colors are black, red, orange, yellow, and colorless, including galena, cinnabar, metacinnabar, greenockite, and colorless diamond.

**semiconductor coloration;** crystals with covalent bonding and sharing of electrons between atoms. The color in semiconductor crystals depends upon the energy gap, between *conduction band* and the *valence band* such as diamond containing trace of boron beside nitrogen, while boron atom has one less electron than carbon that is known as *acceptor* with a *hole*, which caused the blue color in diamond. Also called doped semiconductors. The sixth group of chemical elements has covalent bonding and therefore they are semiconductors other minerals than diamond are pyrite or galena both with metallic luster. The coloring of minerals by irradiation caused by producing color centers in material such as diamond. → Color, Type IIb diamonds.

**semiconductor diamonds;** natural Type IIb diamonds contain boron, are usually blue body colored and semiconductors. Used as counters of gamma rays. → Color, Type IIb diamonds.

**semiconductor diode;** → reverse bias.

**semicrystalline;** it means partly crystalline and partly amorphous. Synonym for hypocrystalline, hemicrystalline, merocrystalline

**semi-genuine doublet;** an assembled stone consisting of either genuine crystal or simulated crystal on the crown cemented or otherwise joined together with the pavilion of another material such as crown. → Doublet, semi-

genuine doublet.

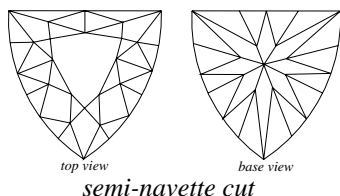
**semi-genuine triplet;** → semi-genuine doublet.

**semi-gloss;** → satin.

**semi-jade;** a term used to describing the altering of amphibole and pyroxene rocks into jade, which was interrupted before the process finished.

**semi-mounting;** in jewelry a style of mounting with only small stones, to which one or more stone may be added.

**semi-navette;** a fancy shape of cutting gemstones like half a navette or marquise. Applied to recut broken



marquise.

**semi-nephrite;** a term used to describing the transformation of amphibole such as tremolite rocks into nephrite which was interrupted before the process finished. Also called tremolite jade.

**semiopal;** a hard, opaque common opal distinguished from precious opal or fire opal. It has a little commercial value.

**semiopal;** hydrophane a variety of opal.

**semiopal;** any partly dehydrated opal with a duller luster. Synonym for hemiopal.

**semiprecious;** same as semiprecious stone.

**semiprecious stones;** a discouraged term for all gemstones other than the so-called precious stones, which exclude all synthetic stones, paste, glass, organic materials such as coral, amber, ivory, etc. and plastics. → Precious stone.

**semitranslucent;** a degree between opaque and transparent, it means that transmits light through edges of a cut cabochon stone or material but very little through the thicker parts.

**semitransparent;** a mineral or material that partially absorbs and partially transmits light, a degree between transparent and opaque. Objects may be seen through them but without perfect outline.

**semiturquoise;** a misleading term for turquoise-like materials.

**sen;** a Chinese term for clear transparent, white nephrite. → Nephrite colors in Chinese, Chinese ritual and symbol jades.

**senaille;** a promotion term for minute diamond chips cut with a flat base and irregular triangular facets, usually in circular rose cut. Set around large gems.

**senarmontite;** isomorphous with valentinite and arsenolite. Rarely cut as gems.

System: cubic.

Formula:  $16[\text{Sb}_2\text{O}_3]$ .

Luster: resinous.

Colors: colorless, grayish-white.

Streak: white.

Diaphaneity: transparent to translucent.

Cleavage:  $\{111\}$  indistinct.

Fracture: uneven. Brittle.

SG: 5.40-5.50.

H: 2-2½.

RI: 2.087. Often anomalous double refraction.

Found in Brazil, Italy, France, Algeria, Canada, and USA.

**Sendelingsdrift;** location of alluvial diamond deposit on the south bank of the Orange River, Namaqualand, South Africa.

**sensitization;** the chemical process by which a substance or dye used to increase the sensitivity of a color such as phosphor in sensitive panel as cathode ray tube (CRT). In such a chemical process phosphor must contain two processor; manganese as activator, and lead as *sensitizer*. Also frequently called co-activator, sensitizer.

**sensitizer;** → sensitization.

**separation;** any treatment of ores or diamonds to separate values from other material.

**separation;** any treatment to separate a mixture of mineral grains of different specific gravity by means of heavy liquids.

**separation;** separation of mineral species and varieties from each other, also natural and synthetic stones.

**separation;** in optic, dispersion of light.

**separation filters;** colored filters used for color separation.

**separation plane;** the layer that separates part of a composite stone.

**separation rupture;** rupture by dispersion.

**séphér;** a Farsi (Iranian) term for sky, sphere, sky-colored, blue-colored. A term may be used for sapphire. → Sapphire, -name of.

**sepiolite;** a, clay-like, smooth, porous, composed of crystal fibers ( $\alpha$ -sepiolite) and amorphous ( $\beta$ -sepiolite) mineral. When contains nickel it is called *falcondoite*, and if sodium is present it is called *loughlinitite*. It fluoresces white. It was used as a soap-dish, it was named *pierre de savon Maroc*. Used in tobacco-pipes, cigarette holders, cigar holders, carved articles, finger rings, brooches, ornaments and in jewelry. Also called meerscham, agaric chalk, sea foam.

System: orthorhombic.

Formula:  $2[\text{Mg}_4(\text{OH})_2(\text{Si}_6\text{O}_{15}) \cdot 6\text{H}_2\text{O}]$ .

Luster: dull.

Colors: white, gray, ivory-yellow, reddish.

Streak: white.

Diaphaneity: translucent to opaque.

Cleavage: none.

Fracture: conchoidal to uneven. Brittle.

SG: 2.00.

H:2-2½.

Optics;  $\beta$ :1.53.  $\ominus$ .

Found in Minor Asia, Spain, and Russia.

**sepiolite cut**; → sepiolite.

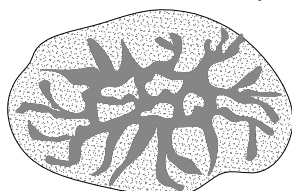
**septarian**; an irregular, polygonal, vary-layered, often radially, geodic stone, composed of calcite or clay ironstone which intersected within by internal cracks filled by calcite or other minerals with irregular star pattern when cut through it. The vary-colored stone is cream, brown and dark brown. Found in Utah, USA and Pelos Klando, Czech Republic. → Septartium.

**septarian boulder**; same as septartium.

**septarian nodule**; same as septarian boulder. Also called, septartium, boulder septarian, septarian boulder, beetle stone.

**septarian nodule**; a roughly, irregular spheroidal concretion of few centimeters to several meters in diameter, usually composed of argillaceous carbonate or clay-iron stone often hollow or transected by veins of a cementing substance such as calcite. Same as Septartium. → Septartium.

**septartium**; roughly, irregular spherical concretion of 8-100 cm in diameter, usually composed of argillaceous



septarian concretion with filled cracks

carbonate or clay-iron stone.

Characterized by an internal irregular polyhedral blocks which is formed by a

series of radiating cracks. Cracks are partly or invariably filled by crystalline materials, mostly such as calcite, and it become cemented together. The formation results of a hard exterior to the nodule caused by development of an aluminous gel on the surface, followed by shrinkage due to dehydration of the colloidal material in the interior, leading to cracking and mineral filling of the radiating of the radiating pattern of cracks. Also known as septarian boulder, beetle, septarian nodule and turtle stone. → Septarian.

**sérandite**; very rare mineral of inosilicate of pectolite series. Cut and faceted as gems in any size.

System: triclinic.

Formula:  $2[\text{NaH}(\text{Mn}, \text{Ca})_2\text{Si}_3\text{O}_9]$ .

Luster: vitreous, pearly on cleavage.

Colors: rose red, rose pink, pinkish, orange

Streak: colorless to pale rose.

Diaphaneity: transparent to translucent.

Cleavage: {001} perfect, and {100} perfect.

Fracture: uneven. Brittle.

SG: 3.46.

H:4-5½.

Optics;  $\alpha$ :1.672,  $\beta$ :1.675,  $\gamma$ :1.707.  $\oplus$ .

Birefringence: 0.035.

Found in Quebec (Canada), and Guinea (Africa).

**Serendipity Diamond**: a light grayish olive-green, rough diamond of 14.33 cts, consists of seven intergrown cubes. Found in 1987 in California, USA. Present owner unknown.

**Sergio Diamond**: → Carbonado do Sergio Diamond.

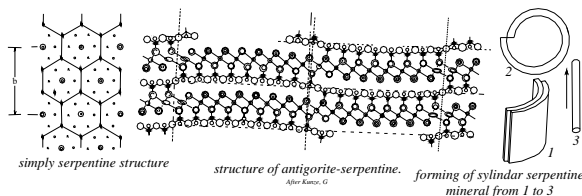
**sericite**; a flaky, fine-grained variety of potassium mica, usually muscovite but may be also illite paragonite formed from alteration of aluminum bearing silicates such as feldspars in metamorphic rock, it occurs as a silky luster with white scales and flakes. Also called sericite mica. → Mica.

**sericite mica**; → sericite, mica.

**serie**; a commercial term for polished diamonds between about 0.19 cts, to 1.49 cts, in weight.

**series**; a commercial term for rough diamonds, which range from 1 to 10 cts, in weight.

**serpentine**; a group of monoclinic or orthorhombic phyllosilicates group including antigorite, chrysotile,



serpentine structure and mineral forming

clinocrysotile, and lizardite, which are altered products of basic and ultra-basic rocks. In mineralogy serpentine is divided into chrysotile, lizardite or antigorite by some other authorities only into serpentine and antigorite. In gemology serpentine is divided into *common serpentine* and *noble serpentine* or *precious serpentine*, which is translucent and oily-green those with waxy yellow to yellow-green known as retinalite. Ornamental serpentine is classified into two varieties; (a) the massive variety such as bowenite and (b) serpentine marble. Cut and polished as gemstones and cabochon, carved as cameos, intaglios and ornamentals. It is prized by collectors. A light green variety of bowenite resembling nephrite a variety of jade, which is frequently misleadingly called as *new jade*. Korean

jade, is a bowenite serpentine. *Bowenite* is a hard variety of serpentine. Other varieties are: in massive form such as retinalite, ophiolite. Crystalline form; such as bowenite, which in Farsi (Persian language) known as *sang-i-yashm* or in China as *Soochow jade*, and bastite. Lamellar; such as williamsite an oil-green, translucent include white veins. Fibrous form of serpentine are lizardite, and chrysotile, which are also known as asbestos. Amorphous variety is known as dewelite (gymnite). Other varieties are: *verde antique* a variety of serpentine marble, which in Roman times was known as *lapis atracius*, tangiwai, falso-nephrite, *Connemara marble* or *Irish green marble*. A serpentine mixed with calcite, dolomite or magnesite, ricolite a fine-grained serpentine, satellite a greenish gray-blue, fibrous with cat's-eye effect, pseudophite a soft stone known misnomerly as so-called *Styrian jade* is a jade green serpentine. Another source of serpentine is in Styrian, Austria, which is ornamental material sold under the name *miskeyite*. A mixture of brucite and lizardite is misnomerly named as *serpentine* by natives of Kashmir. Some serpentine has been dyed for jade imitation and sold misnomerly as *serpentine-jade*. → Precious serpentine, brucite.

System: monoclinic.

Formula:  $2[\text{Mg}_3\text{Si}_2\text{O}_5(\text{OH})_4]$ .

Luster: resinous to greasy, pearly, waxy.

Colors: white, yellowish, yellowish green, shades of green, brownish red, brownish green, brownish, black.

Streak: colorless.

Diaphaneity: translucent to opaque.

Cleavage: {001} perfect.

Fracture: uneven. Brittle.

SG: variable from 2.44 to 2.62, bowenite 2.58-2.62.

H: 2½, bowenite 4-6.

Optics of antigorite;  $\alpha$ : 1.560,  $\beta$ : 1.566,  $\gamma$ : 1.571.

Birefringence: 0.014. ⊖.

Found worldwide.

**serpentine absorption spectrum;** serpentine has absorption spectrum bands at 497 and 464 nm.

**serpentine, asbestos;** synonym for chrysotile.

**serpentine cut;** only the green variety such as bowenite, ricolite, and williamsite are used for cutting and polishing into gemstone or cabochons. Used as cameo, intaglio and ornamental or decorative objects. It resembles nephrite a variety of jade

**serpentine cat's-eye;** a misleading term for satellite.

**serpentine, dyed;** a variety of bowenite serpentine that has been stained with aniline to produce an imperial jade color to imitate jade, which is sold as serpentine jade.

**serpentine, gems in;** several gemstones found in association with serpentine or gneiss such as spinel,

peridot, garnets, and jade.

**serpentine jade;** a misleading term for green variety of serpentine, which resembles nephrite a variety of jade in color and texture. Used as an ornamental stone.

**serpentine jade;** a misleading term for naturally green bowenite a variety of serpentine, which resembles nephrite a variety of jade in color and texture, occurring in China and Afghanistan. Used as an ornamental stone.

**serpentine jade;** a misnomer for serpentines dyed with aniline to an imperial jade color. Used as jade imitation.

**serpentine luminescence;** may be seen weakly whitish-green glow under LWUV.

**serpentine marble;** same as verde antique.

**serpentine rock;** a synonym for verde antique and serpentinite.

**serpentine, stained;** → serpentine dyed.

**serpentine ware;** a variety of wedgwood ware, which is colored like serpentine.

**serpentinite;** an altered rock formed from a basic or ultrabasic pre-existing rock, such a rock consists almost wholly of serpentine group minerals normally of green or red color with a banded or streaked texture. Also called serpentine rock.

**serpentinite breccia;** dark-green serpentinite containing fragments of white calcite marble from Casambala, a few miles north-east of Larissa in Thessaly, Greece. It was known as verde antico (also spelled vert antico), and to the Roman as lapis atracius, obtained near ancient town of Atrax. Also called verde marble.

**serpentinite breccia;** a misleading term that sometimes applied to opicalcite.

**serpent's stone;** same as adder stone.

**serra points;** loose amethyst crystals from southern Brazil.

**Serrinba Mine;** location of important diamond deposit in Minas Gerais, Brazil.

**serra stone;** agate from Serra do Mar, southern Brazil.

**servicoes do rio;** a Brazilian name for alluvial diamond deposits in river beds.

**sesquioxide;** a metal oxide in the portion 3:2 such as chromium oxide ( $\text{Cr}_2\text{O}_3$ ).

**sesquioxide;** same as chromium oxide.

**set;** a manufacturer's name used by brillianteerer for a group of facets composed of two star facets, 4 adjacent upper-girdle facets, which is called a face, or a group consisting of 4 lower-girdle facets on a brilliant cut diamond.

**set;** any kind of gemstones set in a mount.

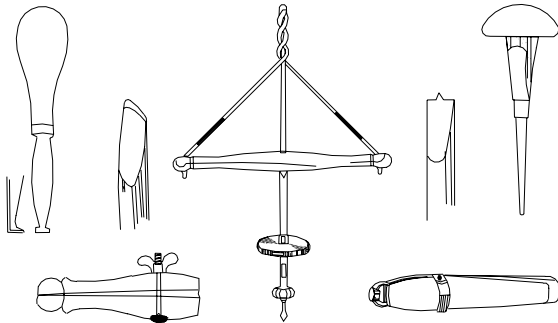
**setter;** now, who sets a rough or prepared diamond crystal of m el e size in a sawing dop.

**setter;** a person who sets gemstones in a mount.

**setting;** the mounting of a gemstone in a mount with claws, bezel, or clamping the girdle of the gemstone to

hold it in place. Same as mount.

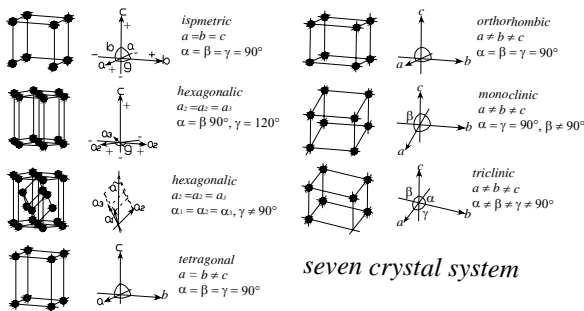
- setting;** placing of fashioned diamond in a mount.
- setting;** setting or mounting of a diamond stone in a dop for sawing, bruting, and polishing.
- setting edge;** → bezel.
- setting gemstones;** → setting.
- setting jewelry;** → setting.
- setting of crystals;** exhibition of minerals.
- setting tools for jewels;** special tools for mounting of a cut gemstone in a prong, claws, bezel, or clamping the



setting tools. After Schmuckbuch 1901

girdle or provided places of the gemstone to hold it in place. For this purposed are some peculiar tools for workers in jewelry as seen in figure. → Setting.

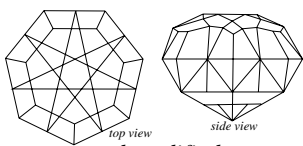
**seven crystal systems;** one of six (or seven) group



classifications of a crystalline mineral according to the symmetry of its crystal faces. Each species occurring in only one of those systems. They are cubic, tetragonal, hexagonal (trigonal), orthorhombic, monoclinic and triclinic. → Seven-crystal system under their respective names, Bravais lattice.

**seven defects in emerald;** → emerald colors and superstitious in Indian.

**seven rayed star-cut;** a modified unpaired brilliant cut



seven rayed modified star-cut

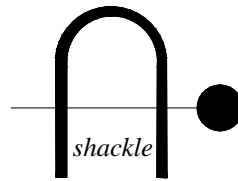
with 55 facets and seven-rayed star and an seven edged table in the crown. Pavilion has 42 facets without culet it is similar to step-cut in

base.

**sextant;** same as index glass.

**SG;** an acronym for specific gravity.

**shackle;** a term used for a U-shaped earring with a black-headed pin, which passes through it to secure the drop, made of gemstones such as jet.

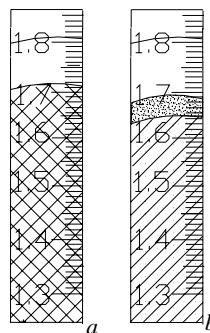


**shade;** description the difference between colors that results from a difference in luminosity, for example a dark shade of a color has lower luminosity.

**shade;** the color obtained with a mixture of pigments or dyes, which has some black pigment in it.

**shade;** a gradation of color, usually equivalent with dark tone. → Definition of color.

**shadow-edge in refractometer;** when looking through the eye-piece of refractometer a part of the scale is brightly illuminated. The remainder has a shadow edge



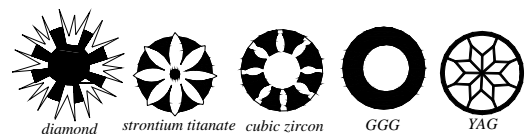
a: reading shadow edge by singly refractive spinel stone.  
b: shadow edge given by doubly refractive peridot stone by using monochromatic light

cut across the scale. If is a single shadow edge is visible the stone is isotropic or amorphous (singly refraction), when two separated shadow edges are visible the stone is anisotropic (doubly refraction). When scale remains dark, only the shadow edge can be seen, that is coming from immersion liquid, this case is a negative reading.

**shadow method;** same as shadow pattern method.

**shadow method of RI approximation;** → shadow pattern method.

**shadow pattern method;** the polished or faceted



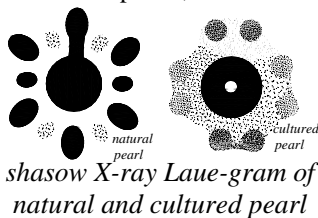
shadow patterns.  
After Haribut and Kammerling 1991

gemstone is immersed in a dish, which is filled with



appropriate liquid, and placed on a white surface or paper. A piece of black card with a straight edge is slid under the dish so that somber light shows through one edge of the stone. When the stone and liquid have the equal refractive index there is no deviation of light and there is no broken edge by the stone. If the liquid has a higher refractive index than the immersed stone the edge of the black card is cut into the stone, but when the liquid has a lower refractive index the stone will advance into the black straight card. Also used to distinguish brilliant-cut diamonds from imitations such as fabulite, YAG, GGG, cubic zircon, etc.

**shadowgraphs, X-ray;** a X-ray photograph of pearls, also known as the skiagram or direct method. A method for rapid testing of pearls to distinguish between natural and cultured pearls, and imitations or a mixture of all three. On the X-ray picture the natural pearl may show up rings or segment of rings near the center of pearl, while the cultured pearl will show only a single zone surrounding the large mother-of-pearl nucleus. In case of imitation pearls the beads in picture are opaque to X-ray beam.



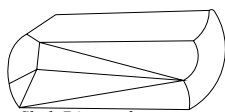
**shaft mining;** usually a vertical or nearly vertical passage leading from ground-level into an underground excavation for purpose of extraction of rocks in a diamond pipe.

**Shah;** same as Shah Diamond.

**Shah Abbass;** a shah of Iran, reign from 1587 to 1628. Royal Jewel Collection of Iran, accumulated by him.

**Shah Akbar Diamond;** same as Akbar Shah Diamond.

**Shah Diamond;** a slightly yellow, elongated octahedron diamond of 88.70 cts, with 15 facets and a groove, by



which it was fastened to a cord, probably from Golconda, India. Reportedly looted from India by Nadir Shah in 1739 brought to Persia. On it are

engraved in Persian Script with the date (of the Hegra) the names of three rulers *Burhan-Nizam Shah II*, 1000 (1591), *Jehan Shah*, 1051 (1641), and *Fatkh Ali Shah*, 1242 (1824). It was presented in 1829 to Russian Tsar Nicholas, as condolence for the assassination of the Russian ambassador in Iran. Now on display in the Russian Diamond Fund in Moscow.

**Shah Jahan Table Cut Diamond;** a pale pink, octagonal, table cut diamond of 56.71 cts, signed in a portrait of Shah Jahan (1592-1666), which is probably one of the three table diamonds described by Tavernier. Believed after sack of Dehli, India it was taken to

Persia in 1739. It was offered for sale in 1985 in Geneva.

**Shah Jehan Diamond;** → Great Mogul diamond.

**Shah of Persia;** Also called Shah of Persia Diamond.

**Shah of Persia Diamond;** a cushion-shaped, yellow diamond of 99.52 cts, from India. Believed to be looted from India by Nadir Shah in 1739, brought to Persia. It was presented by Persian government to General V.D. Starosselky for his duty to the Persian army after World War I. He took it to the USA and sold it to a Los Angeles jeweler. Purchased by Harry Winston and sold in 1965 to a private buyer.

**Shah Shoja Finger-ring Emerald;** in the middle of 19<sup>th</sup> century Shah Shoja or Shuja (1780?-1842), of India presented a beautiful finger ring carved from a single emerald to the East India Company, which had the shape of a ring and the image of Jahangir the Mogul Emperor of India is carved.

**shagreen;** a kind of rough and untanned leather with a granular surface now made from the belly part of shark skin and ray fish. It is stained green, blue, red, and black used as a decorative material and as an abrasive.

**shaker tray;** → joplin jig (mining).

**Shakespeare Marquise Diamond;** a marquise-cut diamond of 50.62 cts, which was one of two stones cut from a stone of 154 cts, in 1970.

**Shakyamuni;** a Chinese term used for a human sign carved on jade as a category of the Lord Buddha figures with beard, big ears and in meditation sitting. → Chinese ritual and symbol jades.

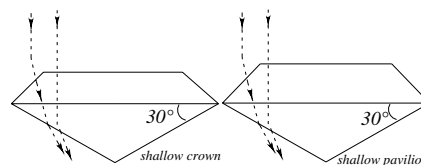
**shale;** a fine-grained, solidified sedimentary rock of mud or clay, which break readily into thin layers.

**shalgham;** → salaki.

**shallow acceptor;** when an acceptor in a crystal do not seat deep in contrast to deep donor. For interaction between two the donor and acceptor both must be either deep or shallow.

**shallow country;** a term used in Australian for a landform of soil and gravel, followed by possible sandstone over the first dry bed of opal dirt. The term used as contrast to deep country.

**shallow crown angle;** when the angle between the plane



shallow crown and pavilion

of the girdle and the crown facets is less than 32°, this often reduces dispersion of diamond.

**shallow cut;** same as shallow diamond.

**shallow diamond;** fashioned diamond with a total depth less than 58-60%, which reduce the brilliancy or

increase light leakage. → Shallow crown angle.

**shallow pavilion;** when the depth of the pavilion is less than 40%, which reduce the brilliancy and can cause the internal reflection of the girdle, that may be visible through the table, this is sometimes called fisheyes. → Shallow crown angle.

**shallow stone;** same as shallow pavilion.

**shamir;** in Jewish mythology a stone, on which the name of the 12 tribes of the Aaron's Breastplate are engraved, believed to be emery (corundum).

**shan;** a Chinese term for a mountain, hill or peak made of jade. → Chinese ritual and symbol jades.

**Shanghai jade;** any of both kinds of jade, jadeite or nephrite from Shanghai market, China.

**Shanghai jade;** a misleading term for soapstone a variety of steatite or talc from Shanghai.

**shank;** the portion of a finger ring that surround the finger or handle of seal. → Seals.

**shank pearl;** a synonym for chank pearl.

**Shannon Diamond Factory;** a synthetic diamond industry in Shannon, Republic Ireland.

**shape;** in popular usage designated to form, but in crystallography refers to habit. → Shapes.

**shape;** form, configuration. → Shapes.

**shape and cut;** a term used for cut form of diamond.

**shape categories of rough diamonds;** → shapes class of rough diamonds.

**shapes;** shape of a polished gemstone, when seen in face-up girdle position, such as round brilliant, marquise, heart, oval, trap, pear, etc.

**shapes;** one of the basic sorting categories of unbroken, irregular, untwined rough diamond crystals. Less valuable than stones. → Diamond sorting, shapes class of rough diamonds.

**shapes;** a sorting grade of rough diamonds that are irregular means two of the octahedral axes are longer than the third and desirable color but cuttable.

**shapes;** same as bruting rough diamonds before polishing.

**shapes class of rough diamonds;** one of the basic sorting categories of rough diamond crystals at the Central selling Organization: (a) stones, (b) shapes, (c) cleavages, (d) macles, (e) irregular shape, and (f) flats. → Diamond sorting.

**shapes of pearls;** shapes of pearls vary from *paragon pearl* in form of finest spherical used as necklace; oval and egg-shape known as *drop pearl* used for ear-rings and pendants; irregular in shape such as *baroque pearl*, *hinge pearl*, *button pearl*, *hammer pearl* used as ear-studs, dress-studs, ring; and very small pearl are *seed pearl*. Terms also used: rounded pearl, pear-shaped pearl, half pearl, dust pearl, and slug pearl.

**shaping;** an American name for bruting.

**shard;** a term applied to glassy fragment in pyroclastics rock with a curved surface of fracture. Also spelled *sherd*.

**sharp filter;** → color filter, Chelsea color filter, filtered light.

**Shark's Bay pearl;** pale yellow to straw pearl from small mollusks *Pinctada carcharium* with an attractive golden hue, from Shark's Bay, western Australia. Frequently classified as colored pearls.

**sharp;** a piece of diamond crystal used for notching a diamond to be cleaved.

**sharp-cornered emerald cut;** a style of emerald-cut with 30 facets

**sharpstone;** a term applied to any rock fragment with angular edges and corners. Also spelled sharp stone.

**sharp stone;** another spelling for sharpstone.

**sharpstone conglomerate;** a term used for sedimentary breccia.

**Shasta;** a Hindu term meaning scripture. → Purana.

**shatter marks;** same as fire marks.

**shattuckite;** often pseudomorphous after malachite. Now is called planchêite. It is similar to turquoise, and azurite. Cut into cabochon and tumbled.

System: orthorhombic.

Formula:  $4[\text{Cu}_5(\text{Si}_2\text{O}_6)_2(\text{OH})_2]$ .

Luster: vitreous to silky.

Colors: shades of blue.

Streak: bluish.

Diaphaneity: translucent.

Cleavage: {100} good, and {010} good.

SG: 3.80-4.11.

H:  $3\frac{1}{2}$ .

Optics:  $\alpha$ :1.753,  $\beta$ :1.782,  $\gamma$ :1.815.

Birefringence: 0.062. ⊕.

Found in Katanga, Zaire (Africa), and at Shattuck, Arizona (USA).

**shearing cleavage;** another term for fracture cleavage.

**Shebo;** a biblical term for eighth stone in the breastplate of the Jewish High Priest. Generally equivalent with agate (achates). Engraved with the name Benjamin. Also spelled Shebho.

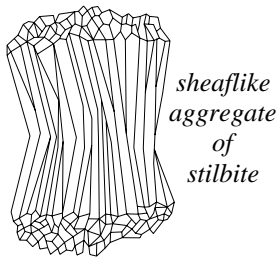
**Shebho;** same as Shebo.

**shebu;** an Egyptian name for a kind of necklace or collar made of gold and Egyptian faience with reddish color button-shaped beads, which are strung closely together with ornaments in two or four rows. Also spelled shebyu.

**shebyu;** same as shebu.

**sheaflike;** a sheaflike aggregate arranged as bundle of crystals that is characteristic for certain fibrous, needle-like minerals such as stilbite.

**shedding;** a term used by Australian miners for pieces of potch or dirt opal, which hold opal colors where it



sheaflike  
aggregate  
of  
stilbite

comes to the surface.

**sheen;** the optical effect caused by reflection of light ray and refractive index from structures within the stone. All terms of optical phenomenon included chatoyancy, labradorescence, asterism, iridescence, adularescence, peristerism, aventurescence, schiller, etc. Not to be confused with luster.

**sheen obsidian;** obsidian containing numerous minute spangly inclusions that is known as gold sheen.

**sheen obsidian cut;** cut cabochon, while attractive sheen.

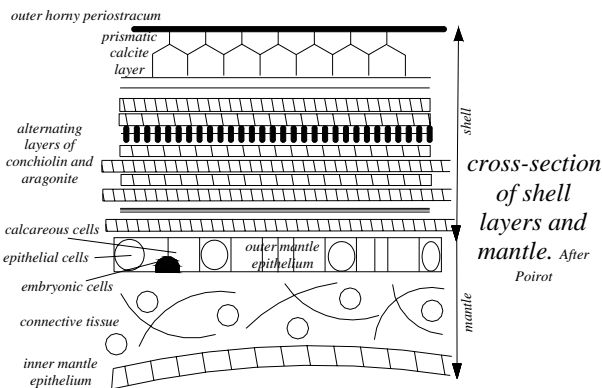
**sheeting;** same as spalling.

**sheet jointing;** same as spalling.

**sheet minerals;** same as phyllosilicates.

**shelf mining;** marine mining.

**shell;** a protective, hard, horny, rigid, outer layer covering of certain salt-water and fresh-water animal such as snail, mollusks, turtles, etc., which consist largely of calcareous, chiefly or partly chitinous, siliceous, or horny. The inner surface of the shell is made from smooth nacre which covers the mantle.



Shell used as inexpensive various purpose in jewelry, for carving shell cameos, ornamental objects and utensils. It displays pearly iridescence for making small spoons, knife handles, carving boxes, in jewelry for brooches, finger rings, ear-studs, dress-studs. *Cat's-eye* effect can be produced from black-lip pearl oyster, when cut suitably, which misnomerly is called *cat's-eye* shell. *Paua shell* has a bright green and blue colored nacre found on the coast of New Zealand. Some shells are dyed by soaking in organic dyes but the colors are

unstable. Other shells such as trochus, pink conch pearl, nautilus, Antilles pearl, sea-snail are fished because of their shells. Coque de perle is cut from the center whorl of nautilus. → Shell, using as ornaments. The so-called tortoise shell used as piqué work.

**shell;** the outer nacreous shell of pearl oyster is used to make mother-of-pearl buttons or other objects.

**shell;** same as crust of the Earth, Earth shell.

**shell;** → shell crystals, skeleton crystal.

**shell;** a thin hard layer of rock.

**shell;** a hollow cabochon, which is hollowed out from the back to improve the color and eliminate the undesirable inclusions for example garnet shell.

**shellac;** a natural white, yellow to brown, orange, transparent, thermoplastic molding natural resin exuded from trees indirectly by an east Indian and Thailand scale insect (*Laccifer lacca* or *Coccus lacca*). Used as low-melting alcohol-soluble glue to secure pallet and roller jewels, in polishes and varnishes. Known as lac. Chemical formula:  $(C_{16}H_{32}O_5) + (C_{15}H_{20}O_6) + 3\%-5\%$  wax.

**shell agate;** agate with silicified mollusks shell.

**shell agate;** agatized shell.

**shell agate;** agate similar a shell.

**shell agate;** → agate shell.

**shell cameo;** a kind of cameo cut in many varieties of mollusks shell, which are generally composed of two or more colored layers (particular banded). In one of these layer a raised figure or design is carved, while the under layer or the second layer, which must be dark in color forms the background. For this purpose the *Cassis* mollusks, a genus that includes conch pearls is used, Alternatively are called, helmet conch, cameo conch, queen conch with a brown background. The shells of *Strombus* mollusk genus such as giant conch, and fountain conch from West Indies and Florida provide pink against a white ground. → Shell, stone cameo, assembled cameo, imitation cameo, molded cameo, genuine cameo.

**shell cat's-eye;** a misleading term for an operculum.

**shell cat's-eye;** a misleading term for some brown or black colored variety of black-lipped shell of mother-of-pearl cut cabochon or carved to display an effect like *cat's-eye*. Used to produce button and other jewelry articles.

**shell crystals;** a term used for beryl crystal grown within pegmatite in zones close to the face of the prism, may be interior of crystal is filled with other pegmatite crystals but not with beryl. Also called cored, stuffed, skeletal, or hollow. → Skeleton crystal.

**shell cut;** shell has long been popular for beads in the manufacture of necklaces, cabochon, bracelets and rosaries and for carved objects and figurines as a cameo

or intaglio. Sometimes used as an imitation for pink conch pearl. → Shell.

**shell dying;** → shell treatment.

**shell fracture;** in mineralogy another term for conchoidal fracture.

**shell-like form;** a term used for quartz crystal on the surface of which a film of hydrocarbon is formed. A second quartz crystal grows parallel to the first mineral, because of the film there is no contact between both crystals. Now due to tectonic event, the first crystal makes a contact with the second crystal and both crystals remain established in a shell-like form.

**shell limestone;** conchoidal limestone. → limestone, shell.

**shell mantle;** that part of a shell, which covers the soft body, viscera, gills, and other internal part of oyster and secreted calcite, aragonite and conchiolin.

**shell marble;** a variety of ornamental marble in various colors containing fossil-shell. Also called Fossil marble, fire marble or lumachella marble, etc.

**shell, opening;** → pearl, shell opening of.

**shell, pearl;** → pearl shell.

**shell speculum;** to open the valves of shell, pincer or opening forceps or so-called shell speculum are used. They are inserted between the shell.

**shell speculum;** in the opening of valves of shell, pincer or opening forceps or called shell speculum, which insert between the shells.

**shell treatment;** frequently shells are stained by soaking in organic dyes but the color is unstable or stained in silver nitrate to produce dark brown color and placed under ultraviolet light or sunlight to darken to black. Gamma rays will darken mother-of-shell to black. Fresh-water shell treated with X-rays darken to black.

**shell, using as ornaments;** popularly shell is used for its mother-of-pearl as beads in the manufacture of necklaces, buttons, cabochon, bracelets and rosaries and for carved objects and figurines as a cameo or intaglio. Some brown or black colored varieties of mother-of-pearl are cut cabochon or carved to shows an effect like cat's-eye, which misleadingly is known as *shell cat's-eye*. Paua shell with its bright green nacre, trochus, and abalones are used as mother-of-pearl. Helmet shell or *Cassis madagascariensis* with white to brown background and giant conch or *Strombus gigas* with white on a pink color are used to carved cameos. Some objects are cut from sea-snail or *turbo* shell, which are known as *Antilles pearl* or *oil pearl*, which are yellowish non-nacreous. Objects from *nautilus shell* are misleadingly known as *coque de perle*. The inner part of this shell is used in inlay work. → Shell, shell cut.

**shell-based imitation pearls;** → imitation cultured

pearls, imitation pearls.

**shelly;** pertaining to the shell or having shell such as sedimentary rock.

**shelly amber;** a kind of partly cloudy amber with loosely adhered layers.

**shelly layer;** the second layer after conchiolin layer is shelly layer, which consists of prismatic columns of aragonite or calcite crystals. The calcium carbonate prisms of the layer are arranged at right angles to the surface of the shell and a cement of conchiolin hold it together.

**shelly limestone;** same as conchoidal limestone.

**shelly marble;** same as shell marble.

**shen;** in ancient Egyptian mythology a symbol of life and infinity in the form of a circle or ring used in Egyptian jewelry, which is held in each claw of the falcon or vulture.

**Shengli First Mine;** location of a small kimberlite diamond pipe at Mengyin, Shandong Province, China.

**shen kwei;** a Chinese term used for tortoise carved on jade. → Chinese ritual and symbol jades.

**Shepherd Diamond;** a flawless, canary-yellow, cushion-shaped diamond of 18.30 cts, on display at the Smithsonian Institution, Washington, D.C., USA.

**Shepherd Stone Diamond;** same as Akbar Shah Diamond.

**sherd;** same as shard.

**sherry topaz;** a brownish-yellow to sherry variety of topaz.

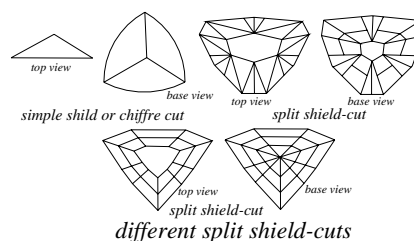
**sherry topaz;** a misleading term for variety of citrine altered its color to sherry wine by heat-treatment.

**shewan opal;** a variety of iridescent, precious opal of dark-red, cherry-red to light red or some other very dark color, almost opaque. Its internal reflections are usually bloody red or yellow-green when displayed against a dark bodycolor. Shewan opal consists of small, iridescent, opal spheres, which causes a play-of-color, due to diffraction of light. Shewan opals, are found only at province Shewan in Ethiopian. → Ethiopian opal.

**shewenshi;** a Chinese term for green serpentine used as jade.

**shewlu;** a Burmese (Myanmar) term for light green jadeite. → Jadeite colors in Burmese.

**shield cut;** a variety of polygonal step-cut or brilliant cut



resembling a shield in outline.

**shimian**; a Chinese term for green asbestos used as jade.

**shimo**; a Chinese term for graphite used as jade.

**shinarump**; a term applied in the southwestern USA to petrified wood. Also spelled chinarump.

**shin cracker**; a term used in Australian to a common fine-grained Coocoran clay stone, which becomes hard, brittle, siliceous rock when exposed at the surface.

**shincracker**; same as coocoran.

**shining (luster)**; minerals are reflected indistinctly.

**Shinyanga**; location for diamond deposit near Shinyanga, Tanzania, Africa.

**shiny luster**; a term used in the USA for brilliant luster.

**Shipley colorimeter**; a diamond colorimeter that was once manufactured by American Gem Society.

**Shipley immersion stage**; a glass cell once manufactured by American Gemological Institute.

**Shipley Robert M.**; (1887-1978) American gemologist who founded the American Gemological Institute (GIA) in 1931 and later American Gem Society (AGS) in 1934. Author of several books.

**shirbu**; a Farsi or Persian term meaning milky of whitish color, also called *shirfam*. → Turquoise classification in Iran.

**shirfam**; same as shirbu.

**shisha**; glass paste or glass. → Turquoise imitation in Iran.

**shiying**; a Chinese term for green quartz used as jade.

**shlig**; washed or cleaned ore. Also called clean ore.

**shock conversion**; the process of subjecting substances to the action of very high temperature and high-pressure shock waves to convert into other material such as graphite into synthetic industrial diamond and/or lonsdaleite.

**shock waves**; due to shock waves can produce defects in crystal, which may give rise to thermoluminescence. → Defects in crystal and color effect.

**Shoham**; a biblical term for the eleventh gemstone in the Breastplate of the High Jewish Priest. It is translated as onyx. Stone is engraved the name of Gad. Also spelled shohan.

**shoham**; same as shohan.

**shore catching amber**; same as shore collecting amber.

**shore collecting amber**; succinite amber collecting from the shores of all countries on the Baltic Sea. Also called shore catching amber, shore poking amber.

**shore poking amber**; same as shore collecting amber.

**shorl**; same as schorl.

**short-columnar crystal**; a short habitus of a columnar crystal such as aragonite.

**short cist**; an archeological term used for single burial, which take place in a small grave.

**shorter-lived terminal level**; → inverted population.

**shortite**; very rare mineral cut and faceted as gem and prized by collectors. Pyroelectric effect.

System: orthorhombic.

Formula:  $2[\text{Na}_2\text{Ca}_2(\text{CO}_3)_3]$ .

Luster: vitreous.

Colors: colorless, pale yellowish to yellow.

Streak: colorless.

Diaphaneity: transparent.

Cleavage: {010} distinct.

Fracture: conchoidal. Brittle.

SG: 2.60-2.63.

H:3.

Optics:  $\alpha$ :1.531,  $\beta$ :1.555,  $\gamma$ :1.570.

Birefringence: 0.039. ⊖.

Found in Wyoming, and Utah USA.

**shortite luminescence**; pink to orange-brown luminescence under SWUV.

**short periods**; a term used for the 18 lighter elements of the Periodic System between hydrogen and argon (atomic number 1-18) because these 18 elements constitute the first three periods. → Periodic Table of the Elements.

**short-prismatic crystal**; a short habitus of a prismatic crystal.

**short rods**; a synonym for short needles.

**short-wave**; an electromagnetic radiation that is shorter than a wavelength of visible light. → Ultraviolet light.

**short-wave lamp**; → ultraviolet light.

**short wave pass filter**; → color filter, Chelsea color filter, filtered light.

**short-wave radiation**; the electromagnetic radiation where its wavelength ranges from 0.4 to 1.0 micrometer. → Ultraviolet light.

**short-wave UV**; → ultraviolet light.

**short-wave UV filter**; to obtain ultraviolet long wave (LWUV) of 365 nm to ultraviolet short-wave (SWUV) 245 nm suitable for gem testing usually the lamps are provided with a suitable filter to transmit those waves, which absorbed the other undesired wave. → Ultraviolet light.

**shot**; same as sand-shot opal.

**shot**; a term used in Australian.

**shot ballas**; same as ballas.

**shot boart**; same as ballas.

**shot balls**; same as ballas.

**shou**; a Chinese term for long live or longevity.

**shoulders**; the wider part of a finger ring extended from the shank to the center of mount.

**shovels**; any miniature trough-shaped, stainless steel scoop used for handling large number of rough or cut diamonds or other gemstones. → Scoop.

**shovels**; a small lap used for polishing stones with a tail-

stock guide to polish cylindrical pivots.

**showstone;** drop-shaped or rounded gem made of hardstone such as quartz or agate, set in a metal frame used as pendant.

**shredded;** some small liquid drops as inclusions in spessartite which formed wavy feathers, which take on a shredded appearance.

**shudra;** an Indian term for deep green variety of emerald.

**shwelu;** an Indian term for veined and sprinkled pale jadeite.

**Si;** a chemical symbol for the element silicon.

**SI;** an acronym for small inclusion in diamond A clarity grade. Also spelled s.i.

**SI;** an acronym system international units.

**sial;** an acronym for silicium-aluminum layer or the upper layer of the Earth's crust. Also spelled sal and called granite layer, granitic layer.

**Siam;** formerly name for Thailand.

**Siam aquamarine;** a commercial misleading term for a heat-treated bluish-green zircon from Thailand (Siam).

**Siam aquamarine;** a commercial misleading term for a bluish-green spinel from Thailand (Siam).

**Siam aquamarine;** a commercial misleading term for a blue zircon. Also spelled Siamese aquamarine.

**Siamese amber;** same as Thailand amber

**Siamese aquamarine;** same as Siam aquamarine.

**Siamese ruby;** same as Siam ruby.

**Siamese sapphire;** same as Siam sapphire.

**Siam ruby;** any deep red ruby with a touch of red-brown from Thailand (Siam). To distinct from Myanmar pure red to bluish-red ruby, Siam ruby shows far less fluorescent and lacks the fine rutile needle inclusions, which have bubbles filled with liquid and crystals inclusions.

**Siam ruby;** sometimes red to purplish rubies from Myanmar, (Burma) are marketed through Thailand.

**Siam ruby;** a misleading term for dark red spinel found with rubies. Also spelled Siamese ruby.

**Siam sapphire;** any sapphire from Thailand (Siam). Also spelled Siamese sapphire.

**Siam zircon;** an erroneous term for zircon from Sri Lanka, Myanmar, Cambodia, and Vietnam, heat-treated in Bangkok, Thailand (Siam) to improve or alter the color.

**Siam zircon;** zircon of inferior quality from Thailand (Siam).

**SIBEKA;** an acronym for Société d'Entreprise et d'Investissements.

**Siberia;** a part of the Russian Federation, CIS, extending from the Ural to Pacific Ocean. An important area for several gems and diamond mines.

**Siberian amethyst;** a commercial term for fine-quality,

reddish purple to dark purple amethyst from Siberia, the Russian Federation, CIS. Cut as gemstones in vary size.

**Siberian aquamarine;** a commercial term for bluish-green aquamarine from Mursinka, Siberia, the Russian Federation, CIS.

**Siberian emerald;** a misleading term for green tourmaline from Siberia, the Russian Federation, CIS.

**Siberian chrysolite;** a misleading term for andradite or demantoid garnet from Siberia, the Russian Federation, CIS. Also misnomered as Ural chrysolite.

**Siberian Diamond;** a rough diamond of 166 cts, found in 1968 in Sakha (Yakutia), Russia. Now on display in the Russian Diamond Fund in Moscow. Also called Stalingrad Diamond

**Siberian emerald;** emerald from Siberian, Russia, Also called Russian emerald.

**Siberian garnet;** almandine garnet from Siberian, Russia.

**Siberian jade;** emerald-green nephrite a variety of jade from Lake Baikal region, Siberian, Russia.

**Siberian jade;** an inaccurate term used to refer to green glass from Siberia, Russia.

**Siberian lapis;** lapis lazuli from near Lake Baikal, Siberian, Russia. Inferior quality when compared to Russian or Afghanistan lapis lazuli and contains fewer pyrite sprinkles.

**Siberian olivine;** a local misleading term for green demantoid garnet from Siberian, the Russian Federation, CIS.

**Siberian ruby;** a misleading term for rubellite a pink variety of tourmaline from Siberia, the Russian Federation, CIS.

**Siberian topaz;** topaz from Uralian, Trans-Baikal, and peninsula Kamchatka Russia. → Tauridan topaz.

**Siberian tourmaline;** pale violet-red variety of tourmaline or rubellite from Ural, Russia, which is misnomered as Siberian ruby.

**siberite;** a synonym for rubellite, a peculiar violet-red variety of tourmaline from Siberia, the Russian Federation, CIS.

**Sicilian amber;** a wine red to yellow and dark red amber from Sicily, Italy. It has strong yellow-green to bluish fluorescence. Also known as simetite.

**Sicilian coral;** a trade classification of coral in Italy. → Coral,-trade classification of.

**Sicilian marble;** a misleading term for Italian marble.

**Sicily;** → amber.

**sickness of pearls;** pearl which have deteriorated in luster due to the decay of the conchiolin constituent.

**sideraerolite;** → stony iron meteorite.

**siderite;** an isomorphous mineral with calcite and rhodochrosite. Rarely cut as faceted gem but prized by collectors. Varieties are chalybite, gyrite, bemmelenite,

iron spar, sparry iron.

System: hexagonalic (trigonalic).

Formula:  $6[\text{FeCO}_3]$ .

Luster: vitreous, also pearly or silky, dull.

Colors: shades of yellow-brown and gold-brown, pale green, red-brown, gray-brown, black-brown.

Streak: white.

Diaphaneity: rarely transparent, translucent to subtranslucent.

Cleavage: {1010} perfect.

Fracture: conchoidal to uneven. Brittle.

SG: 3.83-3.96.

H: 3½-4.

Optics;  $\omega$ : 1.873,  $\epsilon$ : 1.633.

Birefringence: 0.240.  $\ominus$ .

Found in Greenland, Portugal, Bolivia, Austria, France, England, Brazil, Italy, Germany, and USA.

**siderite**; an obsolete term for sapphire quartz.

**siderite**; synonym for chalybite.

**siderite**; a misleading term for hornblende, lazulite, and pharmacosiderite.

**siderite**; a term applied to iron meteorite composed mainly of iron alloy with nickel.

**sideritis**; an obsolete and old name for a variety of diamond.

**sideromelane**; same as tachylite or jaspoid.

**siderosphere**; same as inner core.

**siegstone**; a corrupted German term applied to star sapphire.

**Sienna marble**; a fine yellow often variegated with violet or white variety of marble from Sienna, Tuscany, Italy.

**Sierra Leone**; alluvial and kimberlite diamond pipes from Sierra Leone, in Western Africa, which were found in 1930.

**Sierra Leone copal**; raw copals from Sierra Leone are produced by a tree family of Caesalpiniaceae with the name *Copaifera guibourthiana*.

**Sierra Leone I Diamond**; a diamond of 75 cts, found in 1959. It was cut in New York into two stones, one pear-shaped of 32.12 cts, and a brilliant of 3.95 cts, Present owners unknown.

**Sierra Leone II Diamond**; a rough diamond of 115 cts, found in 1959. It was cut into three stones, one a marquise-cut of 15.78 cts, and two pear-shaped brilliant with total weight of 27.14 cts. Present owners unknown.

**Sierra Leone Diamonds**; some famous diamond are found in Sierra Leone: (a) Woyie River Diamond in 1945, which is called Victory Diamond. (b) Light of Peace in 1960. (c) Star of Sierra Leone in 1972. (d) Star of Independence in 1975.

**sieves**; → diamond sieves.

**sight**; view.

**sight**; one of the 12 merchandising hold program in each year of rough gem diamonds offered by the Diamond Trading Company, the principal company in De Beers Central Selling Organization. At which the clients examine the parcels before purchase. Sights held in London (England), Lucerne (Switzerland), Kimberly (South Africa). After diamonds are graded and valued they are put in parcels and assorted into shapes and sizes.

**sightholder**; diamond retailer or manufacturer informed by Central Selling Organization to purchase rough stones at first sight.

**sighting microscope**; same as focusing microscope.

**signature**; a characteristic or combination of characteristics by which a diamond, gemstone or other material or object may be identified or represented as an image or photograph by an authorized deputy.

**signet rings**; a kind of flat finger ring with an engraved initial or figure, made of so-called signet or *stamp seal*, which is used for authenticating a document by impressing the seal of the wearer on a wax seal. When it is in form of a cylinder it is called *cylinder seal* and are mounted on a ring. → Cylinder, seals.

**sign of double refraction**; → optical sign.

**sign of refraction**; → optical sign.

**Sikajan River**; location of alluvial diamond deposit on the island of Borneo, Asia.

**Silesian chrysoprase**; chrysoprase a green variety of chalcedony quartz from Silesia a region in central Europe partly in Prussia and partly in Poland.

**silex**; a French term for flint, a variety of chalcedony.

**silex**; a kind of brown jasper with red spots, which is a variety of chalcedony.

**silex**; a fine powder of quartz.

**silex**; an old term for a hard, dense rock such as basalt.

**silex**; a commercial term for a kind of heat resistance glass.

**silexite**; an igneous rock composed essentially of quartz. Quartzolite is the preferred term. Also called igneous quartz, peracidite, quartzfels, quartzolite, perasidite.

**silexite**; a French term for chert, especial those occurring in calcareous beds.

**silica**; dioxide of silicon ( $\text{SiO}_2$ ), which appeared in five crystalline polymorphous such as quartz (alpha and beta), tridymite, cristobalite, coesite, and stichovite, in cryptocrystalline such as chalcedony and chert, and in amorphous such as opal (a hydrated silica) and lechatelierite. It is an essential constituent of silicate group of rock forming minerals. It occurs in sand, diatomite, tripoli, flint, chert, etc. Important minerals yield as several gem varieties. Also it is basis form of most glasses and used as an abrasive, to ceramics, etc.

**silica glass**; any amorphous, pale yellow to pale green

natural silica glass such as moldavite, Libyan Desert glass, contains nearly 98% silica. RI:1.462. SG:2.21. H:6. Dispersion: 0.01. Glassy or vitreous luster. Frequently are cristobalite included. Cut as gems and prized by collectors.

**silica glass**; any artificial glass produced by fusion of quartz in an oxy-hydrogen flame at 1700° C, characterized by low coefficient of thermal expansion. → Vitreous silica.

**silica glass**; same as lechatelierite a naturally fused glass.

**silica glass**; furnace slag a blackish mass of glass striped with brown and grayish-blue similar to obsidian, which has been used as gemstone.

**silica glass**; also applied to tektites.

**silica glass**; a transparent, layered, brown natural glass with iridescence effect, found in San Luis, Mexico, which is misleadingly termed *ad iris opal*.

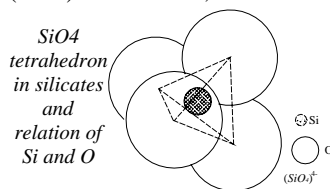
**silica glass, artificial**; → silica glass.

**silica glass, natural**; → silica glass.

**silica petrification**; same as silicification.

**silica replacement**; same as replacement of silica. → Silicification.

**silicates**; any mineral consisting of silicon and oxygen ( $\text{SiO}_4$ )<sup>-4</sup> tetrahedral, an intermediate bond between ionic



and covalent, which is classified according to the structural arrangement of ( $\text{SiO}_4$ )<sup>-4</sup> tetrahedral as (I) nesosilicates, (II) sorosilicates, (II)

cyclosilicates, (IV) inosilicates, (V) phyllosilicates, (VI) and tectosilicates. The silicates are most important and abundant group of rock-forming minerals.

**silicate, classification**; → silicates.

**silicate minerals**; gemstone minerals that are used from different silicate groups: silica groups, feldspar groups, pyroxene groups, amphibole groups, garnet groups, peridot, topaz, tourmaline, zircon, rhodonite, etc. → Silicates.

**siliceous**; containing or resembling silicate or silica.

**siliceous**; a rock rich in silicate or silica. Also spelled silicious.

**siliceous malachite**; a misleading term for chrysocolla.

**silicic**; silica-rich igneous rock and magma. An acidic magma. Also called acidic, oversaturated, persilicic.

**silicification**; the entire or partial replacement of an organic components or an organism by silica, either as quartz, opal, or chalcedony. → Silicified wood.

**silicification**; introducing of cryptocrystalline silica into a non-silicate via igneous origin or ground-water, which replaces entire or partial pre-existing minerals or

filled pore space in the rocks or sediments. Also called silicified and spelled silification, silica petrification, petrification by silica, petrification by silica, silica petrification, silica petrification.

**silicified**; made or convert into silica. Same as silicification.

**silicified wood**; same as fossil wood, agatized or petrified wood.

**silicified crocidolite**; same as tiger's-eye, tigerite.

**silicious**; another spelling of siliceous.

**silicophite**; chrysotile-serpentine penetrated by opal.

**silicium**; same as silicon.

**silicon**; a nonmetallic element of the Periodic System with the symbol Si. Also called silicium.

**silicon carbide**; same as carborundum.

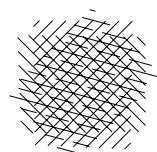
**silicon dioxide**; a colorless crystal or white powder with the composition of  $\text{SiO}_2$ . Insoluble in water and alcohol. It occurs in nature as in different forms with name silica. Used as an abrasive, to make glass, ceramics, etc. The dust of silicon dioxide is toxic on inhalation.

**silicon dioxide**; same as rottenstone.

**silicon-oxygen tetrahedron**; → silicates.

**silification**; same as silicification.

**silk (inclusion)**; exsolved very small to microscopically, needle-like rutile crystal or hematite plate inclusions



*silky nest formation of rutile needles at 60° or 120° in ruby or sapphire*

forming parallel to the hexagonal prism at 60 and 120 in gemstone such as ruby, sapphire, or garnet, which run parallel or criss-

cross and subsurface reflection produce a whitish sheen resembling that of woven silk fabric. Considered as a flaw in minerals.

**silk in garnet**; → silk, Siberian ruby.

**silk in quartz**; needle-like inclusions of rutile crystals causes same effect as in corundum. → Silk.

**silk in ruby**; an inclusions effect in Myanmar ruby due to fine reddish needles of rutile, intersecting at angles 120° each other, which appears in reflected light like silk. → Silk.

**silk in sapphire**; → silk.

**silk in synthetic star sapphire**; synthetic star sapphire with silk effects. → Silk.

**silkijj selngi**; an Arabic term for leaf-green emerald.

**silkstone**; an analogous mineral to binghamite, in which the fibers are randomly oriented.

**silkworms of the sea**; a term used for silky fibers or byssus of the mollusk *Pinna seminuda* because the shell secures an anchorage. The silky fibers with an iridescence color were washed and corded to put into



gloves.

**silky**; having the luster like silk such as fibrous calcite or calcite. → Satin spar.

**silky cymatolite**; altering product of tourmaline to a mixture of albite and muscovite.

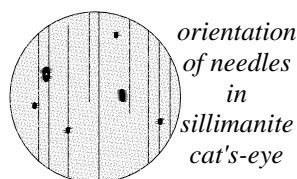
**silky geuda**; a Singhalese term used for a translucent to sub-translucent stone of silky appearance of sapphire, which is caused because of whitish bands impurity follow the crystal form. → Geuda.

**silky look**; a misleading term used in Thailand by gem dealers for turbid sapphires from Bo Ploi, which is no real silk.

**silky luster**; a silk-like sheen, which is reflected from fibers in fibrous crystalline aggregates such as satin spar, or as shown by cat's-eye, tiger eye. Also spelled silky lustre and called silky sheen. → Chatoyancy.

**sill**; a concordant or tabular intrusion of igneous rock that lies more or less planar to the surrounding rock

**sillimanite**; a sapphire-blue mineral trimorphous with andalusite and kyanite Cut as faceted gemstones and



sometimes with blue-green chatoyant effect, which is erroneously known as *cat's-eye*. Greenish or brownish varieties used as an

inferior substitute for jade. Also called fibrolite and frequently bucholzite.

System: orthorhombic.

Formula:  $4[Al_2SiO_5]$ .

Luster: vitreous to silky.

Colors: colorless, yellowish, gray, brownish, greenish, bluish, white. Pleochroism strong green, dark-green, and blue. Chatoyant effects.

Streak: colorless.

Diaphaneity: transparent to translucent.

Cleavage: {010} perfect.

Fracture: uneven.

SG: 3.23-3.27.

H:  $6\frac{1}{2}$ - $7\frac{1}{2}$ .

Optics:  $\alpha$ :1.654-1.661,  $\beta$ :1.658-1.660,  $\gamma$ :1.673-1.683.

Birefringence: 0.019. ⊕.

Dispersion: 0.015.

Found in Oklahoma, Pennsylvania, New York, and North Carolina (USA), Canada, Ireland, Germany, India, Sri Lanka, Myanmar, Korea, Malagasy, South Africa, and Scotland.

**sillimanite absorption spectrum**; absorption spectrum weak bands at 462, 441, and 410 nm.

**sillimanite as an inclusion**; frequently sillimanite needles, which are known as fibrolite are included in rose quartz caused asterism. → Sillimanite.

**sillimanite cat's-eye**; a misleading term for fibrolite

cat's-eye. → Sillimanite.

**sillimanite cut**; → sillimanite.

**sillimanite pleochroism**; strongly pleochroitic: pale-brown or pale yellow to green, greenish-brown and blue-violet or blue to deep brown.

**silt**; a type of fine-grained, uncemented arenaceous rock, the grains having a diameter of 0.002 mm to 0.06 mm, which can be see with unaided eye.

**siltstone**; an indurated silt without lamination and fissility of shale, in it can be found some gem minerals.

**silt pearl**; → mud pearl.

**Silurian**; third of the six periods of the Paleozoic Era with a rock system, which succeeded the Ordovician and precede the Devonian. The period extended from 435 to 395 million years ago, having a duration of 40 million years.

**silver**; a soft, white, precious metallic element of group I of the Periodic System with the symbol Ag. It is an isometric mineral, ductile, malleable, capable of high polish, tarnish by exposure in the air and by contact with sulfur, thermal and electroconductivity, resistant to oxidation or corrosion. Used in jewelry, for ornaments, utility articles and coinage. Often has variable admixture of alloys; gold, copper and platinum.

**silver Cape**; an old color grading for polished diamonds with a very slight tint of yellow, which follow the blue white and white, in term of color grading.

**silver lipped oyster**; a large oyster of genus of *Pinctada maxima*, which is fished from the tropical waters of Australia mainly for the shell proposal. This term used to the mantle of oyster due to protein in the environment of the food

**silver mounting**; a general principle and identification that diamonds are not usually mounted in silver jewelry.

**silver obsidian**; a variety of obsidian with iridescent effect caused by reflections from small inclusions, which are cut as beads and necklaces. Also called silver sheen obsidian.

**Silver Peak jade**; a local misleading term for malachite from Silver Peak, Nevada, USA, used as a jade imitation.

**silver sheen obsidian**; same as silver obsidian.

**silver solder**; an alloy of silver, copper, and zinc used in jewelry as a solder for uniting silver components below 800° C. Also called brazing solder.

**silver stone**; same as moonstone.

**silver travertine**; a silvery gray travertine from Siena, Italy.

**silver-yellow glass**; any glass having characteristic silvery-yellow appearance due to silver *flashing* on the surface of a clear glass object.

**simaostone**; a misleading term for Simav opal.

**sima**; the lower layer of the earth's crust consisting of silica and magnesia-rich rocks. Also called basaltic layer, intermediate layer, gabbroic layer, silicium-magnesium shell, magnesium-silicium shell, subcrust.

**simav opal**; milky-colorless, brownish, orange to red variety of fire opal from vicinity of north-east of Smyrna (now Izmir), Turkey. Also called simav stone, and misleadingly Simon stone.

**simav stone**; same as simav opal.

**simetite**; reddish-brown to pale orange, yellow variety of amber from the Simeto River, Sicily, Italy. Having high content of oxygen and sulfur and low succinic acid. It has strong yellow-green to bluish fluorescence. Used in jewelry articles. Also called Sicilian amber.

**simetite amber**; same as Sicilian amber.

**simili diamond**; a misleading term for colorless variety of lead glass used as a diamond imitation. Often with high dispersion, when it contains thallium.

**simili diamond**; a misleading term for colorless variety of quartz used as a diamond imitation.

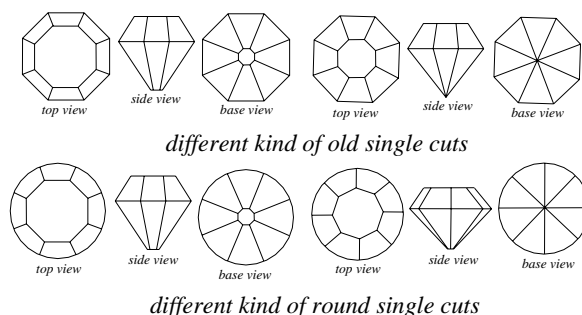
**Simon stone**; misleading term for simav opal.

**simple cabochon**; → cabochon.

**simple coral**; another term for solitary coral.

**simple contact twin**; same as contact twinning.

**simple cut**; a simple modification of the brilliant-cut of the 17 to 18 facets, usually with a circular girdle used for small m $\acute{e}$ l $\acute{e}$ e diamonds usually under 0.05 cts, with eighteen facets, in which eight triangular facets and



*simple forms of cubic system* very rarely a culet on pavilion, an octagonal table on crown being surrounded by eight bezel four-sided isosceles-trapezoid facets. Pavilion is slightly deeper than crown. Also called eight side cut, eight side brilliant, old English cut, and single cut, or rounded single cut. → Eight cut.

**simple form, crystal**; a characteristic crystal form that may be formed with similar relation of symmetry of crystals such as octahedron, dodecahedron or cubes are single crystal forms of isometric system.

**simple microscope**; the simple microscope is a convex lens of short focal length, used to form a virtual image of an object placed just inside its principal focus.

**simple mineral**; a mineral found in nature such as galena, calcite or hematite, as distinguished from rocks.

**simple ore**; an ore with a single metal.

**simple rock**; a rock consisting of a single essential mineral such as quartzite, marble.

**simple substitution**; replacing of two elements with the same valence state and particularly same size (misfit of about 15%), such as replacing of Cr<sub>2</sub>O<sub>3</sub> the compound Al<sub>2</sub>O<sub>3</sub> or Cr<sup>3+</sup> for Al<sup>3+</sup>.

**simple twin**; same as contact twinning.

**simpsonite**; rarely cut as faceted gemstone.

System: hexagonalic.

Formula: Al<sub>4</sub>(Ta,Nb)<sub>3</sub>(O,F,OH)<sub>14</sub>.

Luster: vitreous to adamantine.

Colors: colorless, pale yellowish to pale brown, creamy white.

Streak: colorless.

Diaphaneity: transparent.

Cleavage: none.

Fracture: conchoidal. Brittle.

SG: 6.70-6.71.

H: 7-7½.

Optics: ω: 2.040, ε: 1.994-2.060.

Birefringence: 0.046-0.100. ⊖.

Found in Australian, Zimbabwe and Alto de Gis, Rio Grande, Brazil.

**simpsonite luminescence**; pale yellow, bluish-white, and yellow to blue fluorescence under SWUV.

**simulant**; to simulate or imitate a natural gemstone, which is made from components that are easier, cheaper, or more convenient to manufacture. Simulated stone having superficial appearance to the true stone but differs from it either in chemical composition, structure, or physical properties. For example strass or paste used to copy diamond. Other simulants are composed materials, faience, porcelain, ceramic, plastics, metallic substances.

**simulant**; any material fashioned as a gemstone.

**simulate**; → simulant.

**simulated hematite**; same as scientific hematite.

**simulated pearl**; same as imitation pearls.

**simulated stone**; → simulant.

**Singapore dammer**; → dammar.

**Singhalese cat's-eye**; same as Ceylon chrysoberyl or Ceylon cat's-eye. Now is known as Sri Lanka.

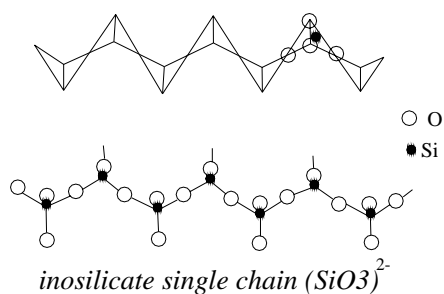
**Singhalese garnet**; same as Ceylon almandine garnet.

**single bevel cut**; a modification of double flat sides (top and base) cut for opaque stones.

**single cabochon**; a synonym for simple cabochon.

**single cabochon**; or inosilicates, a group of silicate structures, in which the SiO<sub>4</sub> tetrahedral may link into linear single chain of indefinite lengths by the sharing of oxygens of indefinite length, the ends, of which are

at the surface of the crystal. Single chain such as



pyroxenes. Synonym for chain silicate, and obsolete as metasilicate.

**single circle goniometer;** a kind of goniometer used for determination of the index of refraction by the method of minimum deviation.

**single crystal;** → single form, crystal.

**single-faceted pebble;** the term applies to a one faceted stone formed by natural agents, such as by wave erosion, the grinding action of a glacial region or wind action in the desert. Same as windkanter. → Faceted boulder, dreikanter, einkanter.

**single inclusion;** one inclusion.

**single form, crystal;** → simple form, crystal.

**single-layer diamond dressing tool;** a diamond dressing tool, which is used to dress, consisting of several diamonds on the tool face. → Diamond dressing tool, impregnated diamond dressing tool.

**single mirror method;** a hollow needle, which is provided with two mirrors at the end for distinguishing the natural pearls from cultured pearls. → Pearl illuminator, endoscope.

**single refraction;** → isotropic.

**single terminated crystal;** when natural faces of a crystal occur only on one end such as a prism. → Termination.

**sinhalite;** rarely cut as faceted gems. Brown, green-brown pleochroism. Until 1952 it was known as brown peridot or brown chrysolite because it has similar properties and refractive index to peridot. Absorption spectrum at 493, 475, 463, and 452 nm. Pleochroitic.

System: orthorhombic.

Formula: 4[MgAlBO<sub>4</sub>].

Luster: vitreous.

Colors: pale yellowish, yellow, brown, greenish-brown to black.

Streak: white.

Diaphaneity: transparent.

Cleavage: none.

SG: 3.475-3.50.

H:6½-7.

Optics: α:1.666, β:1.699, γ:1.707.

Birefringence: 0.041. ⊖.

Dispersion: 0.018.

Found in Sinhala, the Sanskrit name for Sri Lanka (Ceylon), Myanmar (Burma), Tanzania, and USA.

**sinhalite absorption spectrum;** distinct spectrum at 493, 475, 463, 452 and 435 nm.

**sinhalite cut;** faceted as gem resemble yellow or brown chrysoberyl.

**sinhalite pleochroitic;** light-brown, deep-brown and greenish-brown.

**Sinkiang jade;** a variety of nephrite from Sinkiang, East Turkestan.

**Sinkankas Cat's-Eye Golden Beryl;** a cabochon cut golden beryl of 43.50 cts, from Malagasy. Cut by Sinkankas. Now on display at National Museum of Natural History in Washington, D.C., USA.

**Sinkankas Golden Beryl;** a step-cut golden beryl of 2054.00 cts, cut by Sinkankas. Now on display at National Museum of Natural History in Washington, D.C., USA.

**sinker;** a term used in Australian for some who sinks a shaft.

**sinopal;** a misleading term for blood-red to brownish-red variety of quartz from Hungary containing hematite. Also spelled sinople, sinopel.

**sinopel;** same as sinopal.

**sinople;** same as sinopal.

**Sivonelles;** location of small alluvial diamond deposit in the Herbert area, Cape Province, South Africa.

**sinter;** a term used in Australian for common opal as valueless incrustation on rocks.

**sinter;** → sintering.

**sinter cone;** a cone-shaped feature which formed below the area of fusion as alumina powder continues to fall, which grown upward towards the fusion-zone with the hottest flame point and liquefied in this zone such as Verneuil synthetic ruby.

**sintered pyritic ore;** same as purple ore.

**sintered synthetic spinel;** powdered synthetic spinel mixed with cobalt oxide and sintering then at temperatures below 2130° C (melting point of spinel) forms an opaque, intense blue to blue-violet mass similar to lapis lazuli. The pyrite sprinkles can be imitated by adding gold filing fragments. RI:1.725. SG:3.52.

**sintering;** forming of fine particles of a material into a single mass under influence of heat or heat and pressure without entirely melting. A method used to produce simulated lapis lazuli or moonstone. Also called incipient fusion. → Sintered synthetic spinel.

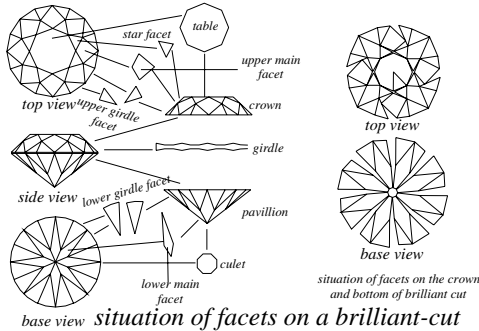
**sintering;** chemical deposition by activity of surface or underground waters or hot water springs, which precipitated from calcium bicarbonate-rich solved in spring waters such as travertine, or as common opal deposited around some hot springs or geysers.

**Sioux Falls jade;** a misleading term for a brown variety of quartzite from Sioux Falls, South Dakota, USA. Used for decoration item.

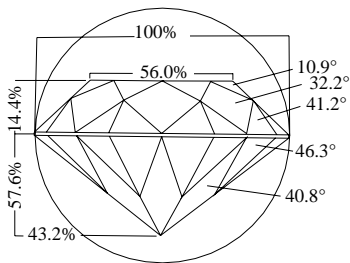
**sira;** a commercial term for a synthetic aluminum oxide used as an abrasive.

**sirippu pearl;** a commercial grade used in Sri Lanka for pearls, which are grooved with irregular wrinkle-like furrows.

**situation of facets on a brilliant-cut diamond;** the



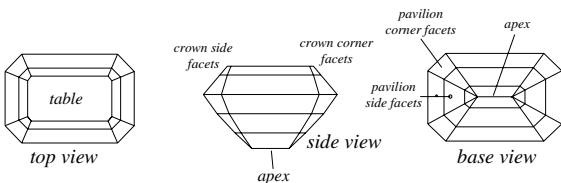
round classic brilliant cut form contains 32 facets and a



situation of facets and their angles on a brilliant cut. The angles are related to girdle diameter

table on the crown, and 24 and a culet facets on the pavillion. The facets are: 8 table facets, 8 upper main facets, 16 upper girdle facets on the crown, and 8 lower main facets and 16 lower girdle facets on the pavillion.

**situation of facets on a step-cut stone;** a rectangular or 4-sided (6 or 8-sided) trap-cut with long, parallel, usually narrow facets. Favored for emeralds and diamonds and other transparent colored stones with the

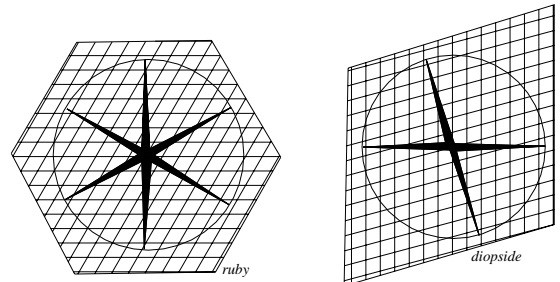


situation of facets on a step-cut

corners beveled and all surfaces covered by a series of

rectangular or square facets or steps on the crown and pavillion, parallel to girdle. Usually on the crown there are two or three rows, and two or three rows on pavillion, this may vary, depending on the size of the stone. The table is large and the outline of such a stone can be rectangular, square, octagonal or hexagonal, drop-shaped, trapezoidal, step-cut bead, lozenge-shaped, oval or semi-circular, which is known as *lunette*. Different forms of step cut are expressed by their outline, such as square step-cut, baguette cut, rectangular step-cut, emerald cut, cross cut, carrée cut, calibré, scissors cut, etc.

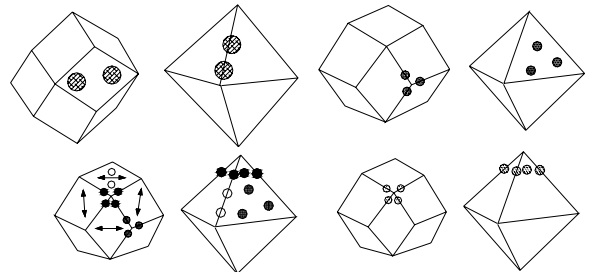
**situation of inclusions in ruby;** exsolved very small to microscopically, needle-like rutile crystal or rutile or hematite plate inclusions forming parallel to the



situation of inclusions in ruby and diopside

hexagonal prism at 60 ad 120 in gemstone such as ruby, sapphire, diopside, or garnet, which run parallel or cross-cross and subsurface reflection produce a whitish sheen resembling that of woven silk fabric. Considered as a flaw in minerals.

**situation of points on a diamond crystal;** the two,

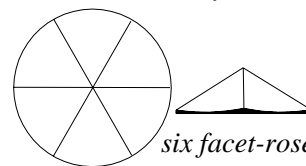


situation of two, three and four point on octahedron and dodecahedron diamond crystals

three or four point on a diamond dodecahedron.

**Sitykans;** same as Sytikansk pipe.

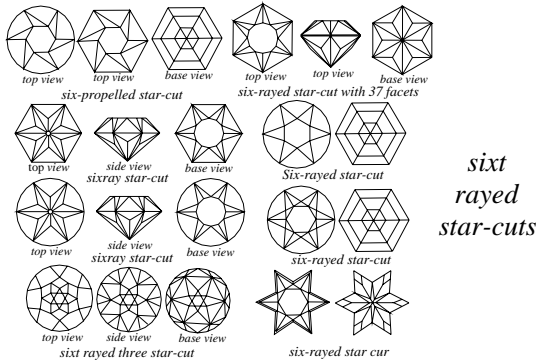
**six-facet rose cut;** a style of rose cut diamond with a circular girdle outline and a pointed six facets on the crown like a dome and a flat unfaceted bottom.



**six-prong setting;** → prong setting.

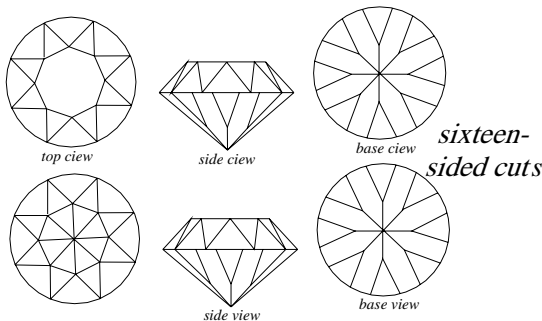
**six-rayed star beryl;** same as star beryl.

**six-rayed star cut;** a simple modification of the brilliant-cut of the 12 to 18 facets, usually with a 8-sided or circular girdle used for small m  lee diamonds usually under 0.05 cts, with eighteen facets, in which



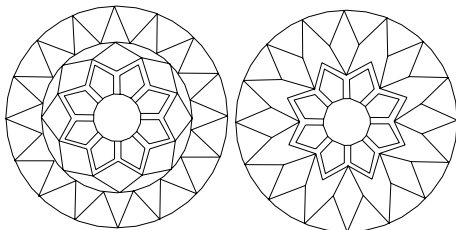
six triangular star facets are seen with very rare a culet in the pavilion, a hexagonal table on crown being surrounded by six triangular-sided facets (rarely four-sided facets). Pavilion is slightly deeper than crown. Also called six side cut, six side brilliant.

**sixteen corner cut;** a style of brilliant cut of small and



poor diamonds with 34 facets, similar to single cut.

**sixteen rayed star;** a modified style of brilliant cut of 64 facets and a sixteen-sided table in the crown. Draw



two different sixteen rayed star-cuts

after a Mandala signs from author.

**sixteen-side cut;** same as Swiss cut.

**sixth;** a commercial term for a sixth of one cts, 1/6 cts.,

**size classification;** same as sizing.

**size of nuclei of cultured pearl;** acceptance of bead from oysters is different it depend from 6-10mm in

diameter, by large oyster from 7-16mm.

**sizes;** a size classification or category for rough diamonds with the weight over 2 carats, smaller particles are called m  lee.

**sizes;** a size classification or grading for polished diamonds weighing more than 1.50 cts.

**sizes;** particle size of pearls. → Pearl.

**sizing;** sorting, grading, or classification of rough diamonds or alluvial particles into certain groups. Also called size classification.

**skaaf;** same as scaife.

**skaif;** same as scaife.

**skarn;** a contact metamorphic rock consisting of calcium, magnesium, and iron silicates formed by the replacement of limestone and dolomite through the action of hot solutions.

**skarn minerals;** those minerals resulting from contact metamorphism such as iron-pyroxenes, epidote, idocrase, wollastonite and iron-garnets.

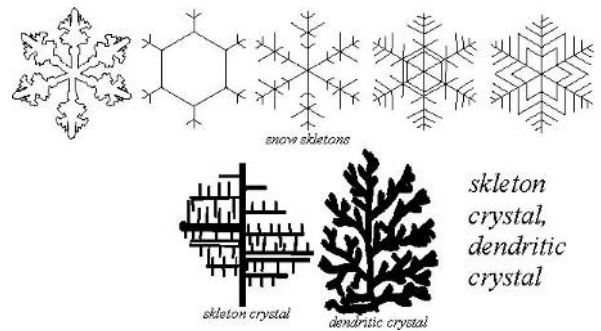
**skeif;** same as scaife.

**skeletal;** same as shell crystal.

**skeletal;** same as skeleton.

**skeletal crystal;** same as skeleton crystal.

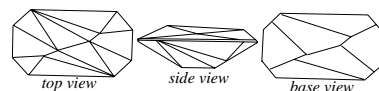
**skeleton crystal;** hollow or imperfectly developed



crystals of small size formed in glassy igneous rocks by rapid crystallization. Also spelled skeletal crystal.

**skeleton crystal form;** same as skeleton crystal.

**skew cut;** a modified faceted brilliant cut consisting of 12 triangular facets in zigzag form in the crown and 6

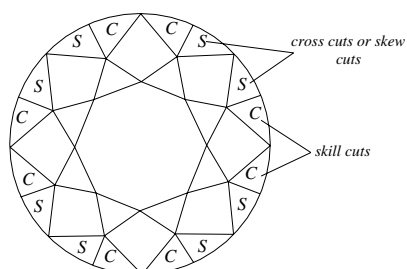


skew bevel-cut

triangular zigzag facets in pavilion.

**skew facets;** an old, collective term, applied, in one of nomenclature, to the 16 small triangular facets on the crown and edging of the girdle, and to the 16 similar

facets on the pavilion of a brilliant cut. Now the 16



*crown of an early form of brilliant cut*

facets above are called *upper girdle facets*. Once known as top break facets, upper break facets, skill facets, or half facets or halves. The 16 facets below are called *lower girdle facets*. These were once called bottom break facets, or lower break facets. → Girdle facets and girdle facet.

**skiagite**; a variety of garnet. → Garnet, garnet species and varieties.

**skiagram**; same as shadowgraphs.

**skief**; same as scaife.

**skill facet**; → break facets, girdle facets.

**skin**; the outer layer of pearls or layer of nacre.

**skin**; the natural surface of a rough diamond crystal is referred to as its skin by cutters. Often can be left on the girdle of a fashioned diamond by the cutter to indicate that maximum has been retained. → Natural.

**skin**; an informal term used in Australian for removing of rough outer layer of opal.

**skin-deep irradiation**; irradiation of ruby or sapphire with WSUV light affected only the surface of specimen because of less energetic nature of WSUV caused the stone to look slightly deeper in color around the girdle.

**skin divers**; a term used in Australia for naked divers pearl shell fisheries.

**skin flotation recovery**; a separation method for minute diamond crystals from less valuable minerals by means of boiling the mass in concentrated hydrochloric acid, after stirring and decanting diamond particles rise up to the surface.

**skinning (pearl)**; same as pearl skinning.

**skin of diamond**; → skin.

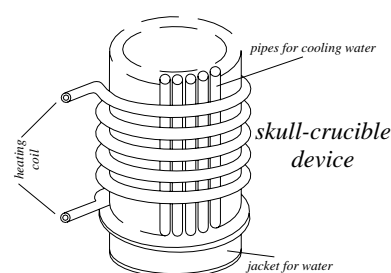
**skin shell**; a term used in Australian for a solid opal has only a thin skin of opal stone, but inside is composed of sand.

**skiver**; a term used by diamond manufactures to describe the formation of long, narrow, shallow chips on a diamond due to badly use of setting tools for example excessive pressure along a cleavage plane.

**sklo berylové**; a Czech term for emerald green glass.

**skull crucible**; a water-cooled crucible made of metal used to melt metals together in it or skull by radio-

frequency heating of 4 MHz and up to 100 kW. Also



called skull melting.

**skull crucible process**; a technique or process to produce synthetic zirconium oxide or so-called cubic zirconia ( $ZrO_2$ ), due to the high melting point of zirconia powder. The powder is mixed with a chemical stabilizer and melted together in a crucible or skull by radio-frequency heating of 4 MHz and up to 100 kW. Also called cold crucible melting method. → Synthetic cubic zirconia.

**skull melting**; → skull crucible.

**skutterudite**; cut cabochon in any size and prized by collectors. Smaltite is a variety.

System: cubic.

Formula:  $8[(Co,Ni)As_3]$ .

Luster: metallic.

Colors: tin white to steel gray. Occasionally tarnishes and iridescent.

Streak: black.

Diaphaneity: opaque.

Cleavage: {001} distinct, {111} distinct, and {011} in trace.

Fracture: conchoidal to uneven. Brittle.

SG: 6.40-6.90.

H: 5½-6.

Found in Chile, Canada, Norway, and Morocco.

**sky blue topaz**; a commercial term for sky blue with less greenish hue irradiated topaz.

**sky stone**; same as benitoite.

**skystone**; same as meteorite.

**slabbing**; cutting a slide.

**slabs, sawn**; large saw used for cutting a large stone into slabs or flags.

**slabstone**; same as flagstone

**slate**; a compact, fine-grained, low grade regional metamorphic rock composed of mica, chlorite, clay, quartz, hematite, and other minerals. It is gray, green, yellow, brown, or red color. It is easily split into flat sheets. Used as decoration utilities and building. Also called roofing slate, clay-slate.

**slaty cleavage**; parallel foliation of platy fine-grained minerals always perpendicular to the direction of compression.

**slaves diamonds**; a Portuguese misleading term for

colorless topaz, marketed as a diamond imitation.

**sleeper**; an informal term used in Australian for a slip known as small slide.

**sleepy**; transparent faceted stone combined with attractive color having dull glow rather than a sparkle appearance such as some zircon or green to yellowish green prehnite.

**slice**; a thin broad piece cut off from the pillar or face of an ore.

**slice**; rock slice.

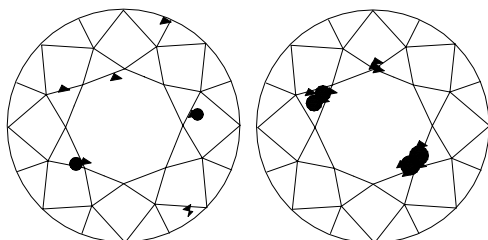
**slide**; a term used for displacement appeared in sandstone sea layer due to earthquake seen in opal mine.

**slightly brown**; → brown diamond.

**slightly etched**; weakly etched.

**slightly imperfect**; → slightly included.

**slightly included**; a grade of relative imperfection on the GIA clarity-grading scale for diamonds with internal blemishes and on the surface, which are



*diamond clarity slightly included  
(SI-1), right (SI-2)*

invisible to the unaided eye but are visible under 10x magnification. Slightly included are divided into two subgrades with abbreviation SI<sub>1</sub> and SI<sub>2</sub>, which are used by CIBJO, IDC, and Scan. D.N.

**slightly tinted white**; a color grading for fashioned diamonds nearly colorless stones on the CIBJO and IDC color-grading scales equal to GIA color grades I to J.

**slightly tinted white**; another term for top crystal on Scan. D.N. color grade system.

**slightly yellow**; a commercial color grade for a diamond with yellowish tint to the naked eye.

**slightly yellowish**; another term for cape on Scan. D.N. color grade system.

**Slijper Diamond**; an octahedron diamond of 7.25 cts, consisting of two octahedron, within the larger octahedron a second octahedron can be seen, which is described as an example of random overgrowth. The second small octahedron is not in crystallographic orientation with the surrounded crystal. It was on display at the University of Michigan, USA in 1950.

**slip**; a term used for small slide result due to movement of the earth's crust which caused sandstone fault that may carry opal.

**slippery back**; a term used in Australian for a main slide in the opal dirt.

**slitting**; dividing of colored gemstones or diamonds by means of sawing into slabs suitable for faceting.

**slitting saw**; slitting wheel or saw used for cutting stones into slabs but smaller and thinner than slabbing saw.

**slitting wheel**; a bronze diamond saw used for slitting colored gemstones.

**Sloane Collection**; Hans Sloane, an English collector that willed his stones to the British Museum, London. Among them was a rose-cut sapphire of 31.50 cts.,

**Sloane Sapphire**; a rose-cut sapphire of 31.50 cts, was among the Hans Sloane collection, who willed this stone together with other stones to the British Museum, London.

**slocum amber**; same as slocum imitation amber.

**Slocum imitation amber**; a transparent amber imitation, made of acrylic, styrene or polyester resin, which contains plant and or insect inclusions or sun-spangle fissures. Available in light orange or red-shades. It has a similar refractive index to amber R:1.50-1.55. SG:1,17. H:3 harder than amber. Smell after burned fruit when touched with a hot point. Made in Michigan, USA by Slocum Laboratories.

**slocum stone**; an old term for opal essence.

**slot cutter**; same as template cutter.

**slot mining**; same as open bench mining.

**slug**; a commercial term for very irregular or grape-like clusters of intergrown fresh-water pearls, often without luster.

**slug**; a lump of alluvial gold more than one pound weight.

**slug**; a piece of valuable mineral such as cassiterite, etc.

**sluice box**; a long trough applied to recover gems and minerals. Also called launder and in Malaya: palong.

**slum**; an informal term used in Australian for a soft bed of clay, which does not contain opal, but below layer of sandstone may hold opal.

**slush box**; a box around and beneath the lap, in which the silt or mud from polishing procedure is accumulated

**Slypklip**; location of a small alluvial diamond deposit in the Kimberley area, Cape Province, South Africa.

**Sm**; a chemical symbol for the element samarium.

**small fragment**; chip.

**small inclusions**; minute inclusion in a gemstone with the acronym s.i.

**smalls**; an assortment for any rough diamond less than 0.75 cts.

**smalls**; an assortment for any fashioned diamond, smaller than m el e or 0.15 cts. → Sizes.

**smaltite**; a variety of skutterudite.

**smarag**; a Scottish or Gaelic term for emerald.

**Smaragd**; a German term for emerald.

**smaragd Bahjský**; a term for used in Brazil for emerald from State of Bahia. Also called smaragd Bahjský.

**smaragd Bratislávský**; → smaragd Bahjský.

**smaragd crystal**; a misleading term for rock crystal.

**smaragde**; another spelling for emerald.

**smaragdfluss**; a German misleading term for quartz.

**smaragdfluss**; a German misleading term for fluorite.

**smaragdine**; a rarely used term for relating to emerald.

**smaragdine**; a misleading term rarely used for chlorophane a green variety of fluorite.

**smaragdite**; a massive, emerald-green, foliated to fibrous, jadeite-like variety of chromium-bearing actinolite amphibole, which is often found in diallage. SG:3.25. Smaragdite or a form of it with the name *chloromelanite*, which is used as a jade imitation. Also called edenite.

**smaragdite**; it is an obsolete term for diopside.

**smaragdite**; a misleading term used for zoisite, beryl, or green beryl glass.

**smaragdkrystall**; a German misleading term for rock crystal.

**smaragdmatrix**; a German misleading term for emerald matrix.

**smaragdocalcite**; a German misleading term for atacamite, or diopase.

**smaragdolin**; a commercial term for fused beryl glass chemically similar to beryl. RI:1.62. SG:3.30-3.45. H:5-5½.

**smaragdo prase**; a misleading term used for plasma or prase.

**Smaragdo prasem**; a German misleading term used for plasma or prase.

**Smaragdo prassius**; a term used in past for a transparent green stone, which may were between emerald and prassius, therefore is named bastard smaragde.

**Smaragdo prasus**; a German misleading term used for differently green stones such as variety of quartz.

**smaragdos**; → emerald,-names of.

**Smaragdo spath**; a German misleading term used for green feldspar such as amazonite.

**smaragdus**; a Greek/Latin term for emerald.

**smaragdus calcedonius**; a Greek/Latin term for amazonite feldspar.

**smarakata**; → emerald, names of.

**smaryll**; a commercial term for an assembled stone composed of crown and pavilion of true beryl or emerald of poor quality or poor color for top and bottom, jointed together by an emerald-green organic cement of duroplastic. To indicate smaryll made of pieces of aquamarine can be seen the *rain* effect due to negative crystals or canals in stone. To distinguish the

Chelsea filter and spectroscope are used, which show the dyestuff line in the red. → Assembled stone, doublet,-emerald, soudé emerald.

**SMEO**; an acronym for Société Minière De l'est-Oubangui.

**smearing**; → sadja.

**smeraldo**; Italian spelling for emerald.

**smeraldo Africano**; an Italian misleading term for green fluorite from Africa.

**smeraldo degli Urali**; an Italian misleading term for green demantoid garnet from Ural, Russia.

**smeraldo di Bahia**; an Italian term for emerald from Bahia, Brazil.

**smeraldo del Brasil**; an Italian misleading term for green tourmaline from Brazil.

**smeraldo del Capo**; an Italian misleading term for green prehnite from Cape, South Africa.

**smeraldo di Colombia**; an Italian term for emerald from Colombia.

**smeraldo di lithio**; an Italian misleading term for green lithium hiddenite.

**smeraldo orientale**; an Italian misleading term for green sapphire.

**smeraldo di rame**; an Italian misleading term for diopase.

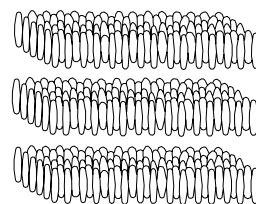
**smeraldo ricostituto**; an Italian misleading term for green glass.

**smeraldo saldato**; an Italian misleading term for green composite stone.

**smeraldo synthetico**; an Italian misleading term for synthetic emerald.

**SMI**; an acronym for Société Minière Intercoloniale.

**semetic crystal**; an organic, viscous, jelly-like chemical compound in a transition form between liquid and solid



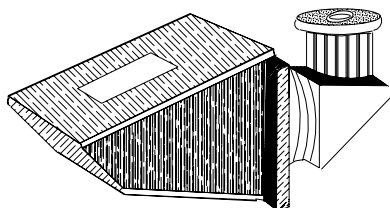
condition of ordered liquid molecules in smectic phase. After Bohm

states, which has optical properties like a crystal but other properties are similar to liquids, commonly anisotropic over a definite range of temperature above their freezing points. Mostly can exhibit left-handed or right-handed twisted structure. Under the influence of an electric field, liquid crystals undergo realignments leading to optical effects. Liquid crystals are divided into threefold category the third of the is *semetic liquid crystal* whole the molecules are straight but perpendicular layers.



**smink**; a term applied to powder earth.

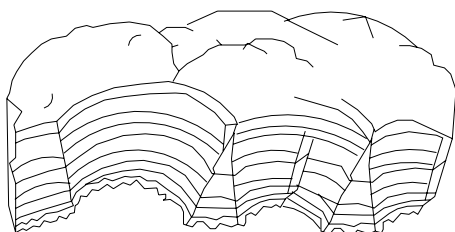
**Smith, Herbert refractometer**; a very small or pocket



*Herbert Smith refractometer*

refractometer with nonrotating hemisphere prism. → Herbert Smith refractometer.

**smithsonite**; a calcite group mineral, usually associated with hemimorphite. A suitable mineral for collectors but rarely faceted and cut as cabochon. Banded blue and green have been found in Greece. A blue and green copper-stained variety is named as *herrerite*. Also



*layered smithsonite from Greece*

called bonamite, zinc carbonate, azulite, Aztec stone, azurite, calamine (in England), zinc spar, dry-bone, sacred turquoise, santander, szaskaite, chalchihuitl, Sardinia, and sometimes misleadingly termed *hemimorphite*, which is a zinc silicate and associated with smithsonite.

System: hexagonal (trigonal).

Formula:  $6[\text{ZnCO}_3]$ .

Luster: vitreous, pearly to earthy and dull.

Colors: in many hues such as white, colorless, gray, pale yellow to dark yellow, green, apple green, yellowish-brown, brown, blue, pink.

Streak: white.

Diaphaneity: transparent to translucent.

Cleavage:  $\{1011\}$  semi-perfect.

Fracture: subconchoidal to uneven. Brittle.

SG: 4.30-4.45.

H: 4-4½.

Optics:  $\omega$ : 1.848,  $\epsilon$ : 1.621.

Birefringence: 0.227.  $\ominus$ .

Dispersion: 0.037.

Found in Italy, Greece, Zambia, Mexico, Spain, Algerian, Tunisia, Australia, Belgium, France, Namibia, Colorado, New Mexico and Arkansas, USA.

**smithsonite cut**; yellow-colored stones are rarely

faceted and massive form are cut into cabochons.

**smithsonite luminescence**; whitish-blue, rose red, brown, blue-white under SWUV. Lavender, greenish-yellow under LWUV.

**Smithsonian Institution, Washington, D.C., USA**; same as U.S. National Museum.

**Smithsonian Topaz**; a green cut topaz from Brazilian of 2.4kg. Now on display at Smithsonian Museum, USA.

**Smithsonian Topaz**; a yellow step-cut, oval-shaped topaz from Brazilian of 7725 cts. Now on display at Smithsonian Museum, USA.

**Smithsonian Topaz**; a yellow-green oval-cushion cut topaz from Brazilian of 1469 cts. Now on display at Smithsonian Museum, USA.

**Smithsonian Topaz**; a crimson-red imperial topaz, round step-cushion from Brazilian of 129 cts. Now on display at Smithsonian Museum, USA.

**Smithsonian Topaz**; an irradiated blue topaz. Cut as step-cushion of 572 cts. Now on display at Smithsonian Museum, USA.

**Smoke Creek**; location of alluvia-bearing area in the eastern of Australia's Kimberley District where there are some diamond pipes in Smoke Creek, AK1, and Limestone Creek.

**smokestone**; a synonym for smoky quartz.

**smoke quartz**; a synonym for smoky quartz.

**smoky**; smoke gray variety of color.

**smoky crystal**; an obsolete name for smoky variety of quartz.

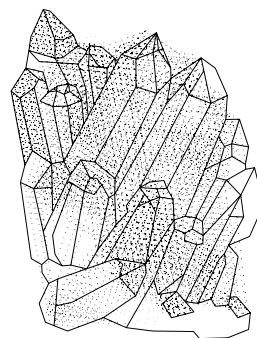
**smoky opal**; common opal with smoky-brown color.

**smoky opal**; white opal from Mexico turns its color to smoky brown by heat treatment, which is known as smoked opal, radio opal. It tends to adhere to the tongue.

**smoky opal**; a term used in Australian for translucent variety of patch opal with smoky or blackish nature.

**smoky opal**; a term used in Australian for cloudy smoky feature opal without definite clear-cut color, which can detract the value.

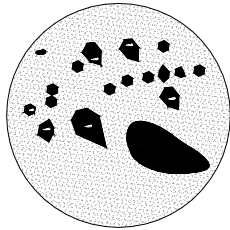
**smoky quartz**; a smoky-brown to brownish-black, or



*smoky quartz*

smoky shade of yellow often transparent variety of

quartz. The color is probably caused by natural color center produced by impurity of aluminum or irradiation or may be organic substances. Some irradiated and natural brown quartz turns its color to greenish yellow by heat treatment. Deep blackish color is named as *morion*, brownish to yellow is called *cairngorm* found

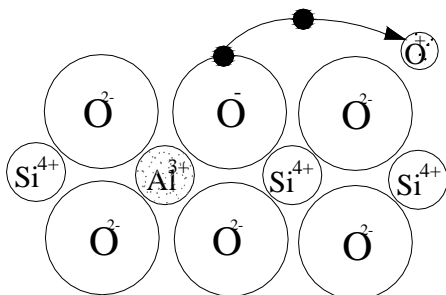


*smoky quartz healing cracks with negative two ohases crystalas*

in Cairngorm, Scotland. The term *cairngorm* used for faceted brown quartz. When it is cut as gems misleadingly it is termed

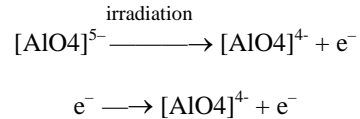
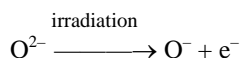
*smoky topaz*. Much of it altered its color to yellow or yellow-brown. Sometimes the smoky quartz is erroneously called as topaz quartz. Some specimens are misnomered as diamond for example Colorado diamond. Also called smoke quartz, smokestone. *Smoky crystal* was an old name for smoky quartz. Used as faceted gems in any sizes. Mostly of *cairngorms* in trade are heat-treated amethyst from Brazil. Found in Malagasy, Brazil, and California (USA). → Brown quartz.

**smoky quartz, color of;** the color of smoky quartz is probably caused by natural defect color centers produced by impurity of aluminum and irradiation. For producing smoky color in quartz is an unpaired electron necessary this will happen by trivalent aluminum ion replacing tetravalent silicium ion. This replacement needed an alkali element (monovalent)



*smoky quartz and irradiation. After Nassau 1983*

such as sodium ion or a hydrogen ion for electrical balance. During irradiation of such quartz with an impurity of aluminum one of a pair of electrons may be thrown off its position such as an oxygen ion adjacent to an aluminum. This action leaves the other electron unpaired which giving rise to a hole color center:



**smoky quartz cut;** cut as faceted gems, used for carving, beads, ornamental objects and tumbled.

**smoky quartz synthetic;** → synthetic quartz.

**smoky topaz;** a misleading commercial term for smoky quartz used as gem.

**Smolensk;** a city in south eastern of the Russian Federation, CIS, for a diamond manufacturing plant that is administered by Kristall, a Russian Diamond Manufacturing Concern.

**smyris;** a stone from Greece used for an abrasive powder, it consists of emery.

**Sn;** a chemical symbol for the element tin.

**snail;** → shells.

**snake-skin;** a term applied to a peculiar structure can be seen in synthetic opal similar a snake-skin or chicken-wire, sometimes showing a columnar honeycomb outlook.

**snake stone;** a local term used in England for shales and jet rock were rich in ammonites fossils.

**Snell's law;** same as law of refraction. → Index of refraction.

**snide;** → chip up.

**snip;** a term used by Australian miners for a rough opal by which the edges of stone be pare to ascertain quality degree by faceting or rubbing down. Also called chip up.

**snip;** same as chip up.

**snips;** a term used by Australian miners for a tool for opal digging, which is like a pair of pincers with sharp jaws to removed minute pieces op nobby to study for its color.

**snake bites amulet;** an amulet sign such as scarab made of emerald or beryl which mean elevation, worn in ancient Egyptian and were said protect against snake bites.

**snowball garnet;** some pyrope garnets contain circular arrangement of quartz crystal inclusions similar to snowball found in Cromarty, Scotland.

**snowball garnet;** same as rotated garnet, rolled garnet.

**snowball inclusions in ruby and sapphire;** some ruby and sapphire contain circular and white inclusions similar to snowball surround by irregular tension cracks due to heat treatment.

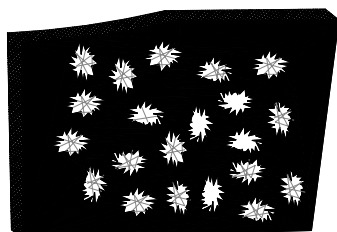
**snowflake cut;** some modified brilliant cut for diamond, imitation glad and other stone.



*four modified snowflake-cuts*

**snowflake jade;** → jade matrix.

**snowflake obsidian**; a kind of white to grayish flower-like patched silica in a black matrix of obsidian. Also



*snowflakes on obsidian*

called flowering obsidian. → Obsidian inclusions.

**snowflake obsidian cut**; mostly cut cabochon or beads.

**snow on the roof**; some or all faces of some tourmaline crystals are typically coated with pink, white or colorless elbaite in which the *c*-axis lie more or less on the coated crystal surfaces like snow.

**snowy**; an obsolete term for very white rough stone.

**snuff box**; a small pocket bottle or box for holding snuff, with a hinge and cover.

**snuff bottles**; → snuff box.

**Snyder's Rush**; location of a small alluvial diamond deposit in the Barkly West area, Cape Province, South Africa.

**soap clay**; same as bentonite.

**soap earth**; same as lardite.

**soaplike liquid crystal**; same as smectic liquid crystal.

**soap-rock**; same as soapstone, figured stone.

**soapstone**; a popular term for any massive, very soft rock or mineral having a greasy touch, a variety of talc or steatite. According to the softness it is ready for carving into ornamental objects. It is opaque, silvery-white, because of impurities vary its color varies from green, brown, reddish-brown to yellow. Optics;  $\alpha$ :1.480,  $\beta$ :1.486-1.493,  $\gamma$ :1.50-1.59. Birefringence: 0.012.  $\ominus$ . SG:2.20-2.80. H:1 (due to impurities is higher). Synonym for saponite, soaprock, piotine, image stone (in India a variety of agalmatolite is known as pratima culler). Found in India, Zimbabwe, South Africa, and Canada. Also called figure stone, figured stone.

**soapstone**; a term used sometimes for agalmatolite. → Steatite.

**soapstone**; a term used frequently for lardite.

**soapstone**; a term used by miners and driller's for any soft, unctuous rock (mineral) such as sericitic schist or micaceous shale.

**soapy**; same as unctuous or unctuous rock.

**sobo-riyoku**; a Chinese term for sea-green stone similar to aquamarine.

**sobrisky opal**; a variety of opal from Death Valley, California, USA.

**Société Belge de Gemmologie**; Headquarters for this

society are located at: Rue du Midi 118, 10000 Bruxelles, Belgium.

**Société d'Entreprise et d'Investissements**; a Belgian mining diamond company founded as Société Minière du Bécéka to explore diamonds in Congo (now Zaire). Abbreviation: SIBEKA.

**Société de Recherches et d'Exploration Diamantifères**; a subsidiary of Compagnie Minière De L'Oubangui Oriental with the abbreviation: SOREDIA. A diamond company in Central African Republic.

**Société de Recherches et d'Explorations Minières en Côte d'Ivoire**; principal diamond-mining companies on the Ivory Coast, Africa with the Abbreviation: SAREMCI.

**Société Diamantifères de la Côte d'Ivoire**; a small diamond-mining company in Ivory Coast, Africa with the Abbreviation SODIAMCI.

**Société de l'E.K.L.**; a group of diamond mining companies in Zaire, Africa. This association included Société Minière de la Lueta, Société Minière du Kasi and Société Minière du Luebo.

**Société Forestière et Minière du Congo (FORMINIÈRE)**; → L'office Forestière et Minière du Congo.

**Société Guinéenne de Recherches et d'Explorations Minières**; a subsidiary of Consolidated Africa Selection Trust (CAST) founded in 1932 for obtaining minerals from 4 alluvial deposits along the Baoule River, Guinea, Africa. Abbreviation: SOGUINEX.

**Société Minière de Bakwanga**; state diamond mining company in Mbuji-Mayi, Zaire, Africa. Abbreviation: MIBA.

**Société Minière de Beyla**; a diamond mining company, which operated in Kankan district of eastern Guinea, Africa.

**Société Minière de Carnot**; a nationalized diamond mining company operated in Central African Republic, Africa.

**Société Minière de la Lueta**; a diamond mining company in Zaire, Africa.

**Société Minière De L'est-Oubangui**; a diamond mining company, which operated in Central African Republic. Abbreviation: SMEO.

**Société Minière du Bécéka**; a diamond mining company, which operated in Zaire Africa. → Société d'Entreprise et d'Investissements (SIBEKA).

**Société Minière du Kasi**; a diamond mining company, which operated in Zaire, Africa.

**Société Minière du Luebo**; a diamond mining company in Zaire, Africa.

**Société Minière du Zamza**; a diamond mining company in Zaire, Africa.

**SODIAMCI**; an acronym for Société Diamantifères de

la Côte d'Ivoire.

**Société Minière Intercoloniale;** a diamond mining company, which operated in Zaire, Africa. Abbreviation: SMI

**soda;** another term for sodium carbonate.

**soda alum;** another term for sodium alum.

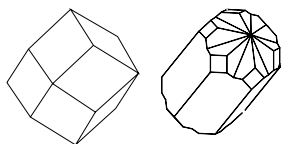
**soda anorthite;** another term for sodic anorthite.

**sodaclase;** another term for albite, sodium feldspar, white feldspar, white shorl.

**soda hornblende;** another term for arfvedsonite.

**soda-jadeite;** true jadeite from Myanmar, (Burma) distinguished from diopside jadeite.

**sodalite;** a feldspathoid mineral of sodalite group, a principal component of lapis lazuli and responsible for its color. Often mottled or veined with nephelite, magnetite, mica, and cancrinite and sometimes with specks of pyrites. *Blue stone* is a commercial term for sodalite used for inlay, also is termed as *Canadian blue stone* and princess blue. Cut into cabochon, spheres,



*sodalite crystal and twin*

carving ornamental objects, rarely faceted as gemstones, and tumbled. It tend to lose color, when exposed to sunlight. Hackmanite is a sulfur-rich, transparent, pink variety from Canada. Synthetic and imitations sodalite are made. Also called Princess blue, bluestone, alomite.

System: cubic.

Formula:  $\text{Na}_8\text{Cl}_2(\text{AlSiO}_4)_6$ .

Luster: vitreous, greasy, adamantine.

Colors: colorless, white, yellowish, bluish to dark blue, greenish, reddish. May turn raspberry-red after exposure to SWUV and tone fades in sunlight.

Streak: colorless to white.

Diaphaneity: transparent to translucent.

Cleavage: {110} poor.

Fracture: conchoidal to uneven. Brittle.

SG: 2.27-2.40.

H: 5½-6.

RI: 1.483-1.487.

Dispersion: 0.018.

Found in Canada, Italy, Bolivia, Portugal, Greenland, Brazil, Russia, Namibia, India, Norway, French Guina, South Dakota, Arkansas, Colorado, and Massachusetts (USA).

**sodalite cut;** cut into cabochons, spheres, carving ornamental objects, inlay, rarely faceted as gemstones from Ontario material, and tumbled.

**sodalite luminescence;** orange red to violet luminescence under LWUV light. Weak pink under SWUV.

**soda mica;** another term for paragonite.

**soda microcline;** another term for anorthoclase.

**sodalite, synthetic;** synthetic lapis lazuli is made in China.

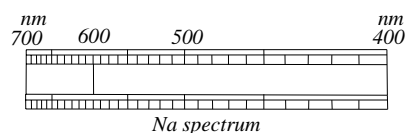
**sodden snow jade;** same as imperial sodden snow jade.

**SODIAMCI;** an acronym for Société Diamantifères de la Côte d'Ivoire.

**sodic;** another term for acid plagioclase.

**sodic anorthite;** another term for soda anorthite.

**sodium;** a soft, silvery-white, very reactive metallic



element of the alkali group of the Periodic System with the symbol Na, from natrium. It tarnishes rapidly.

**sodium alum;** a cubic mineral of alum group with formula  $\text{NaAl}(\text{SO}_4)_2 \cdot 12\text{H}_2\text{O}$ . Also called soda alum.

**sodium carbonate;** a compound of  $\text{Na}_2\text{CO}_3 \cdot 10\text{H}_2\text{O}$ , used as flux substance in blowpipe analysis.

**sodium calcium feldspar;** another term for plagioclase.

**sodium chloride;** same as halite.

**sodium feldspar;** another term for albite.

**sodium light;** in gemology a standard monochromatic yellow light of wavelength 589 and 589.3 nm used to obtain sharp shadow edges on the refractive indices of gemstones in a refractometer. The source in street lighting with yellow color is a sodium vapor lamp.

**sodium polytungstate;** a white powder of  $3\text{Na}_2\text{WO}_4 \cdot 9\text{WO}_4 \cdot \text{H}_2\text{O}$  used as a safer heavy liquid for specific gravity of about 3.10 it will produce a saturated liquid with absolute distilled water. Applied to determine specific gravity of tourmaline or quartz. It will dilute with distilled water. The specific gravity of sodium polytungstate has a linearly relation to its refractive index therefore can be measured with the specific gravity of stone, when determining the refractive index of liquid by means of refractometer.

**sodium salicylate;** a brilliant, white, scaly crystals or amorphous powder. Soluble in water, slightly in alcohol. It is a saline salt. Used as dyes and in laser dye with the wavelength 395-418 nm. → Oxazine 9.

**sodium vapor lamp;** a yellow monochromatic light (sodium or D line of Fraunhofer lines) source produced by passing an electric discharge between two electrodes in a lamp containing sodium vapor at low-pressure. Used to obtain sharp shadow edges of the refractive indices of gemstones determining by refractometer, and used in yellow-colored street lights.

**softening**; a term used in microscopy for diffused light (reduced light). such as frosted incandescent bulb lights for locating and observing the straight color bands in sapphires from irregular feature color zoning.

**soft ivory**; a promotion term for those type of ivory that are easier to cut than hard or glassy ivory.

**soft jet**; → varieties of jet.

**soft mineral**; a mineral that is softer than hardness scale seven or quartz, such as calcite.

**soft rock**; a term applied loosely for sedimentary rock such as limestone, sandstone, dolomite, pumice, as distinguished from hard rock such as igneous rock or metamorphite.

**soft rock**; a term applied to rock that is relatively resistance to erosion.

**soft soldering**; the jointing of metal pieces using relatively lower-melting-point metal (usually an alloy of lead and tin) to unite the surfaces. It is a weaker join.

**sogdianite**; an extremely rare mineral of cyclosilicates of the osumilite group. Cut cabochon and as faceted gems.

System: hexagonalic.

Formula:  $2[(K,Na)_2(Zr,Ti,Fe)_2(Li,Al)_3(Si_{12}O_{30})]$ .

Luster: vitreous.

Colors: bright violet like kunzite.

Streak: colorless.

Diaphaneity: transparent.

Cleavage: {0001} perfect.

SG: 2.82-2.90.

H:7 if pure.

Optics;  $\omega$ :1.608,  $\epsilon$ :1.606.

Birefringence: 0.002.  $\ominus$ .

Found in South Africa, and Tadjikistan the Russian Federation, CIS.

**sogdianite absorption spectrum**; intense spectral lines at 411, 419, and 437 nm and weak lines at 488 to 493 and 630 to 645 nm.

**sogdianite luminescence**; weak red under SWUV and weakly violet under LWUV.

**so-giyoku**; another term for riyoku-giyoku.

**SOGUNEX**; an acronym for Société Guinéene de Recherches et d'Explorations Minières.

**Soko**; a Japanese term for emerald.

**solar cell**; due to absorption of sun radiation because of reverse bias can produce a voltage across the junction with an efficiency electrical light of 20%.

**solarization of glass**; → glass solarized.

**solar spectrum**; a group of dark absorption lines of the solar spectrum, which extends over the entire electromagnetic spectrum. During a sun, eclipse when the sunshine is blocked off by the monde Fraunhofer lines from solar atmosphere can determine as bright lines. → Fraunhofer lines.

**solder**; a metal that is used in molten form to unite the surfaces of metals.

**solder dop**; a metal holder (usually brass cup with a soft copper tail), which is filled with a relatively low-melting-point solder (lead-tin), into which diamond can be secured during the polishing. Sometimes called polishing dop or lead dop. → Dop.

**soldered emerald**; a misleading term for soudé emerald.

**soldering**; the process of joining pieces of metal by using a solder metal in molten form to join surfaces. Used to make jewels or repair them. → Hard soldering, soft soldering, brazing.



**soldering jewelry**; → soldering.

**soldier's stone**; same as amethyst variety of quartz.

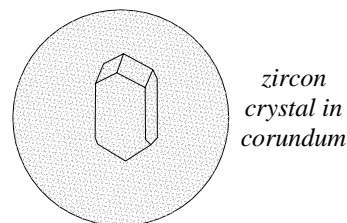
**Soleil D'Or Diamond**; an emerald-cut diamond of 105.54 cts, of uncertain origin.

**Soleimani**; a term used in Iran for blue but slightly milky turquoise. → Turquoise classification in Nishabur, Iran.

**solid**; a term used by Australian miners for an opal gem made of one piece or a full stone without doublet or triplet. The stone has not been trimmed after cutting and polishing.

**solid gold**; a misleading term for 100% gold or pure gold.

**solid inclusions**; inclusions within the host mineral that may have same substance as the host or foreign materials to the host such as mica and rutile in zircon.



**solidification**; the process of transition of a liquid or gaseous state into the solid state.

**solid solution**; a homogenous crystalline material that is a mixture of two or more chemical compounds, which replacing some ions, atoms, or molecules of the other chemical compounds in its normal crystal structure such as sold solution of gold and copper in which some gold atoms replacing some copper atoms. that can be seen in some other alloys, without the appearance of an additional phase. Also called isomorphous substitution. → Isomorphic replacement.

**solid solution**; another term for mixed crystal, mix crystal.

**solitaire**; a finger ring mounted with a single diamond or

other stone.

**solitaire;** mounted with a single diamond or other stone, or a symmetrical pearl in an ornament.

**Solnhofen stone;** light-colored, partly fine dendritic limestone from Solnhofen, Germany, used as building and decoration stone.

**Solomon's gem;** probably a paste, which is green in incident light and red in transmitted ray.

**solvent dye;** a misleading term for dye solvent. An effect that changed the hue of a color by adding another concentric solvent. Also called dye-dye interaction.

**Somali amber;** a misleading term for a synthetic resin or plastic used to make beads and other ornamental objects represented to the natives as amber.

**somberite;** → apatite.

**somerset;** a commercial term for synthetic yttrium aluminum garnet (YAG), used as a diamond imitation.

**somorrod;** another Farsi (Persian) spelling for zomorrod meaning emerald.

**Somondoco emerald;** a commercial term for emerald from Somondoco, Colombia. It is known as Chivor emerald and was mined by Inca Indians. → Muzo Mine, Chibcha stone.

**Somondoco mine;** emerald mines from Somondoco district, Colombia. It was mined by Inca Indians. Also known as Chivor.

**somorrod;** another Persian-Arabic spelling for emerald.

**sonoluminescence;** luminescence effect that is create in certain substances by high-frequency photons or sound waves passing through a liquid.

**Sonoma diamond;** a misleading term for quartz crystal from Sonoma County, California, USA.

**Sonstadt's solution;** an amber colored, saturated heavy liquid of potassium iodide and mercuric iodide soluble in water used for measuring of specific gravity. RI:1.733. SG:3.196. Also known as Thoulet solution.

**Soochoo jade;** same as Soochow jade.

**Soochow jade;** a misleading term for a fine-grained bowenite or steatite from Soochow, China. Suitable for carving and cut cabochon.

**SOREDIA;** an acronym for Société de Recherches et d'Exploitation Diamantifères.

**sorella;** a commercial term for synthetic strontium titanate used as a diamond imitation.

**sorosilicates;** a silicate structure characterized by the linkage of two SiO<sub>4</sub> tetrahedra sharing one oxygen to form Si<sub>2</sub>O<sub>7</sub><sup>6-</sup>, with a Si:O ratio of 2:7. An example is hemimorphite. → Silicates, sorosilicates, cyclosilicates, inosilicates, phyllosilicates, tectosilicates.

**sorted;** another term for graded.

**sorter;** who sorts polished diamonds or rough gemstones into shape, weight, color and clarity.

**sort house;** sorting facility or building for separating rough diamonds from other minerals. The process is done by hand.

**sorting;** process of sorting polished diamonds or rough gemstones into shape, weight, color and clarity.

**sortex machines;** a diamond sorting machine, which works with X-ray, by which any diamond lights up.

**soudé beryl doublet;** an assembled stone made of two pieces of inferior quality beryl or pale colored emerald cemented together by a green glass of suitable thickness. Another assembled stone composed of crown and pavilion of true beryl or emerald of poor quality or poor color for top and bottom, jointed together by an emerald-green organic cement of duroplastic, which in trade named as *smaryll*. → Soudé emerald.

**soudé emerald;** a misleading term for an early type of counterfeit of emerald is soudé emerald (soudé: soldered or fused), in which two pieces of rock crystal forming the crown and pavilion fused together by a green colored gelatin or dense green glass such doublet is better to termed as *quartz doublet*. Soudé made of beryl will not be revealed. Also called soldered emerald. → Quartz doublet.

**soudé emerald;** a misleading term for another type consisting of a crown and base of synthetic white spinel or colorless quartz cemented together by gelatin or green coloring layer. French spelling: Émerald soudée. → Soudé spinel.

**soudé spinel;** a type of counterfeit of assembled stone, in which two pieces of colorless synthetic spinel forming the crown and pavilion are cemented together by a sintered glass or plastic substances. It is very easy to distinguish, when put in water or suitable immersion liquids and viewed sideways. Both layers have strong bluish-white glow under SWUV light but not the cement layer. Also known as synthetic spinel doublet, soudée sur spinelles, soudé spinel doublet.

**soudé spinel doublet;** → soudé spinel.

**soudée sur spinel;** → soudé spinel.

**soudé-type of other stones;** a composite stone of peridot-colored synthetic corundum, which has been formed like soudé emerald. → Soudé spinel.

**source;** a term described the geological formation, in which mineral, ore, or gemstone are generate and found.

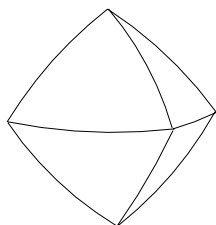
**sources of light;** → standard sources of light, sodium vapor lamp, fiber optics, fiber light-guide.

**sousmansite;** a local term for wardite from Sousmans, Montebbras, Creuse, France.

**South African;** variety of diamonds from South Africa in contrast to diamonds from other countries.

**South African bort;** a natural diamond of the lowest quality, badly flawed, or discolored crystals suitable

only for use as abrasive powder, for industrial processes. Also called industrial diamond. The varieties of bort are: ballas or shot boart, hailstone boart,



*South Africa Diamond*

carbonado, stewartite, and framsite. Found in South Africa. → Abrasive material.

**South African diamonds;** diamonds from South Africa are smooth when contrasted to the pebbly and encrusted surface diamonds from Congo.

**South African emerald;** a misleading term for a green colored fluorite from Namibia, which is sold misleadingly under such a name.

**South African emerald;** a misleading term for a green colored glass used as an emerald imitation.

**South African emerald;** emerald from Transvaal, South Africa. Also called Transvaal emerald.

**South African jade;** a misleading term for massive grossular garnet from Transvaal, associated with black chromite. Used as decorative items. Also called Transvaal jade, African jade.

**South African nephrite;** a misleading term for Transvaal nephrite.

**South African ruby;** a misleading term for fiery ruby-colored pyrope garnet from South Africa, which is known as Cape ruby.

**South African tourmaline;** same as Transvaal tourmaline.

**South African turquoise;** turquoise from neighborhood of Kimberly, South Africa.

**South African wonderstone;** → koranna stone, pyrophyllite.

**Southern Cross Diamond;** a pink-rose diamond of 118 cts, found in 1929 in the Abaeté River, Minas Gerais, Brazil. Named after place where the Southern Cross Constellation was found in 1825. Present owner unknown.

**Southern Cross Opal;** a famous opal from Australia was purchased by Khedive of Egypt. Further information not available.

**Southern Cross Pearl;** same as Great Southern Cross Pearls.

**southern emerald;** same as Colombian emerald.

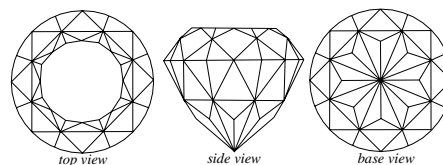
**Sovêr;** location of alluvial diamond deposit in the Barkly West area, Cape Province, South Africa.

**Sovêr Mine;** location of a small kimberlite diamond-bearing fissure near Barkly West area, Cape Province, South Africa.

**space;** a three dimensional regular pattern, in which atoms, molecules, and ions are arranged such as in crystal structure. → Lattice.

**space lattice;** → lattice.

**sparklera cut;** a modified faceted brilliant-cut with 48 facets and 16-sided table in the crown. Pavilion is taller and stepped than crown with 48 facets without culet and a 8-rayed star, totally 97 facets.



*sparklera cut with 97 facets*

**spacer plate;** some plates or spacer plates and pieces of gemstones such as jet or amber are dotted with pointille pattern.

**spallation;** a type of nuclear reaction in which several particles result from a collision of an atom and a high-energy particle such as cosmic rays with atoms of atmosphere, chain-reaction in a nuclear reactor or weapon, by which results in the formation of different large number of protons, neutrons, and other light particles that is not a fission product.

**spallation;** a type of nuclear reaction in which ejection (protons, neutrons, and other light particles), of atomic from a nucleus result from a collision of an atom and a high-energy particle such as cosmic rays with atoms of atmosphere, chain-reaction in a nuclear reactor or weapon, that is not a fission product.

**spalling;** the process of exfoliation of a concentric scaly or platy rock by which the shells of several thickness (one centimeter to several meters), are successively spalled or stripped from the bare surface. Also called sheeting, desquamation, sheet jointing.

**spalmandite;** a contraction of isomorphous intermediate group of almandine and spessartine garnet. Also called spandite.

**spandite;** formerly a suggested name for intermediate between anderadite and spessartite. Also called spalmandite.

**spangles;** a term applied to a small nearly circular inclusions in some spinels, which are surrounded by iridescent stress features.

**spangles;** pieces of glass having inclusion of micas, which flash in various colors.

**Spanish amethyst;** a misleading term for amethyst,

which once was marketed through Spain.

**Spanish citrine;** any citrine from Spain. → Hinjosa topaz.

**Spanish emerald;** emerald from Peru, South America, at the time of the conquest of Spain and marketed through Spain.

**Spanish emerald;** a misleading term for green glass used as an emerald imitation.

**Spanish Gemmological Association;** → Association Española de Gemología.

**Spanish Inquisition Necklace Emerald;** the largest emerald in this necklace is ca. 60 cts, set in a diamond necklace, now on display at National Museum of Natural History in Washington, D.C., USA. It is named because thought were made during inquisition period.

**Spanish jet;** jet from Aragon and Oviedo, Spain.

**Spanish lazulite;** a misleading term for iolite a variety of cordierite.

**Spanish topaz;** a misleading term for citrine from Hinjosa del Duero, district of Córdoba, Spain.

**Spanish topaz;** a local commercial misleading term for an orange-brown citrine quartz from Spain. Is often heat-treated amethyst.

**spar;** a term used for ornamental objects made from fluorite or fluorspar, which are named as spar ornament. Spath is an obsolete term.

**spar;** a term applied to transparent, or translucent, nonmetallic, easily cleavable, light colored mineral with vitreous luster such as calcspar (calcite), heavy spar (barite), feldspar, and fluorspar (fluorite). Spath is an obsolete term.

**sparr;** an old term used in England for quartz?, such as christal six squares sparr.

**spar;** a local Cornish name for quartz.

**spark;** in jewelry very minute gemstones that are used in jewel settings to surround large stone to enhance their brilliance.

**sparkle;** same as scintillation.

**sparite;** same as sparry calcite, sparry limestone.

**sparklite;** a commercial term for colorless heat-treated zircon, used as a diamond imitation.

**spar ornament;** → spar.

**sparry;** resembling, pertaining to or consisting of spar such as sparry luster.

**sparry calcite;** relative clean, coarse-grained, recrystallized calcite in sparry matrix. Also called sparite, calcsparite.

**sparry limestone;** a coarse-grained limestone or marble in which the sparite is more abundant than the micrite groundmass. Also called sparite.

**spartalite;** same as zincite.

**spat;** a very young oyster ca. one week old of 0.1 mm in diameter that are free-swimming when released from

the body of the parent oysters until they attach themselves to rocks or other solid objects by means of byssus. → Spat fall.

**spat fall;** settling and attachment of young bivalves, oysters or mussels to the paar, which is very important feature of the surviving environment. → Spat.

**spath;** an obsolete term for spar. → Spar.

**spathic;** pertaining to spat or resembling spar according to the cleavage.

**spathic gypsum of Montmartre;** same as Montmartre gypsum wedge. → Gypsum.

**spathic iron;** same as siderite.

**spatial;** another term for three-dimensional effect.

**spatial effect;** another term for three-dimensional, triple-dimensional.

**Spaulding Diamond;** same as Stewart Diamond.

**spear pyrites;** a twin form of marcasite mineral that resemble the head of a spear. → Cockscomb pyrites.

**special;** a commercial term for rough diamond over 10.08 cts, in weight, used by Central Selling Organization.

**special;** said to be a special stone.

**special forms;** all other forms other than general form are special forms.

**special mineralogy;** study of occurrence, description, mode of formation, uses, chemical and physical properties of minerals.

**species mineral;** a class of particular chemical and physical properties of minerals, which distinguish them from others, but which may have varieties.

**species of gem;** mostly of gems are minerals, which mean a class of gems with particular chemical and physical properties (usually with a crystallographic structure), which distinguish them from others, and within which may be numerous, for example corundum is a mineral species. In organic gem species are seen pearl, coral, amber, jet, ivory and shell. Species are divided into *varieties*.

**specific gravity;** the ratio of the weight of any substance to that of pure water at temperature of 3.98° C (39.2° F) and standard atmospheric pressure. Specific gravity of gems and minerals are determined by means by hydrostatic weighing method. Also called relative density.

**specific gravity attachments;** the accessory items, which are used for determination of specific gravity of gems and minerals with a gemstone balance such as wire stone basket, beaker stand, beaker, and counterbalance.

**specific-gravity balance;** balance with special accessories for obtaining specific gravity of gem by hydrostatic weighing method. → Hanneman balance, Westphal balance, Penfield balance.



**specific gravity bottle;** → pycnometer, density bottle.  
**specific gravity heavy liquid method;** → heavy liquid.  
**specific gravity hydrostatic method;** → hydrostatic weighing method.  
**specific gravity indicators;** → indicator, glass specific gravity indicators.  
**specific gravity liquid;** same as heavy liquid.  
**specific mineral;** same as essential mineral.  
**specific gravity of cultured pearls;** specific gravity of cultured pearls from Japan ranges from 2.72 to 2.78, and non-nucleated cultured pearls from Japan ranged from 2.57 to 2.70. → Pearl.  
**specific gravity of imitation pearls;** specific gravity of imitation pearls ranges from 2.85 to 3.18. Rarely 2.30 to 2.56. → Pearl.  
**specific gravity of natural pearls;** specific gravity of natural pearls ranges from 2.60 to 2.78 and rarely to 2.85. → Pearl.  
**specific refractivity;** same as refractivity.  
**specimen;** a minor mass of rough gem, mineral, ore or rock, which gives an idea of the nature of the deposit. A specimen is not acceptable as a sample.  
**specking;** a term used by Australian miners to fossicking for small pieces of potch and opal on the Earth surface in a heap.  
**speckled hen;** an informal term used by Australian miners to describe a variety of sandstone or clayey nodule material bands, which known as mottled sandstone, or cuckoo sandstone.  
**speckled inclusions in beryl;** same as peppery inclusions in beryl.  
**spectacle crown;** a white alkali-lime-silica crown glass of RI:1.523.  
**spectacle stone;** clear transparent gypsum, selenite, finely crystallized gypsum. → Selenite.  
**specter of the Brocken;** same as glory.  
**spectra;** plural of spectrum. → Absorption spectrum.  
**spectra, absorption;** → absorption spectrum.  
**spectra, band;** → band spectrum.  
**spectra, bright line;** → bright-line spectra.  
**spectra, emission;** → emission spectrum.  
**spectra, flame;** → flame spectra.  
**spectrafloat technique;** a process of inserting copper electrolytically into glass layer during the continuous spectrafloat method to made bronze colored glass, which controls the sun light transmission.  
**spectra, fluorescence;** → fluorescence spectrum.  
**spectra, infra-red;** → infrared spectrum.  
**spectra, solar;** → Fraunhofer lines.  
**spectra, swan;** → band spectrum.  
**spectra, ultimate lines in;** → ultimate lines in spectra.  
**spectra, X-ray;** → X-ray spectrum.

**spectral colors;** same as spectrum color.  
**spectrochemical;** a term used by a series of ligand fields, there is a consistent change in strength of the ligand field central metal complex in a variety of surrounding when oxygen ligands are replaced by other atoms, ions, or molecules. In this, condition the six-coordinated  $\text{Cr}^{3+}$  by oxygen, the eV-value changes from 3.3 by  $\text{CN}^-$  to 1.6 By I. The series of some common ligand are:



This fact explaining some optical, spectroscopic, and magnetic properties of chemical compounds.

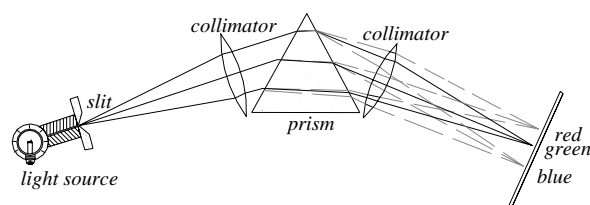
**spectrograph;** a camera or other device arranged for recording a map or photograph from spectrum lines in a spectroscope by using a quartz prism, which transmits UV light down below 200 nm.

**spectrograph;** a photograph taken from a spectrum by mean of such instrument.

**spectrolite;** a term applied to blacker and iridescence labradorite feldspar from southeastern Finland carved as ornamental objects.

**spectrometer;** any device for determination of the absorption spectrum of a gemstone.

**spectrometer;** an instrument like spectroscope, which is suitable for precise determination of refractive indices



sketch of a spectrograph

by the method of minimum deviation. Also often called spectroscope. → Goniometer.

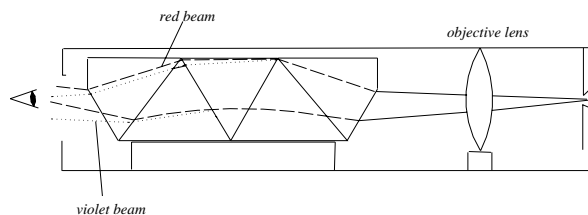
**spectrophotofluorometer;** a device used to measure the particular wavelength of light, which excites fluorescence in a gemstone. → Spectrophotometer.

**spectrophotometer;** a device for determining and recording the intensity of each wavelength of the lines of emission spectrum of visible light. It consists of a light source of visible and ultraviolet light or sometimes infra-red radiation, an optical prism for producing monochromatic radiation, and an instrument for determining and comparison the luminous intensity of the light.

**spectrophotometer, infra-red;** → spectrophotometer.

**spectroscope;** a small hand optical device for obtaining

and visually observing spectrum, in which collimated light passes through a narrow slit onto either a prism or



section through a spectroscope

diffraction grating, its spectrum being viewed by a lens system or telescope. The angle between the collimator and telescope can be varied. It is useful instrument for identification of gemstones. → Diffraction grating.

**spectroscope diffraction;** → diffraction grating.

**spectroscope, digital scanning;** → digital scanning spectroscopy.

**spectroscope, direct vision;** → direct vision spectroscopy.

**spectroscope grating;** → diffraction grating.

**spectroscope prism;** → prism.

**spectroscope video in;** → video in spectroscopy.

**spectroscope wavelength scale;** an accessory tube containing a scale on nanometer or Ångström unite, used to measure wavelengths it is installed in spectroscopy.

**spectrum;** any array of electromagnetic visible light ordered according to its constituent wavelengths or colors, when the white light is dispersed by a prism or *diffraction grating*, ranging from about 750 to about 400 nm. The spectra can be obtained by means of a spectrometer. Spectra produced from a stone emitting radiation are known as *emission spectra*. If white light traversed a quasi translucent medium, selective absorption of certain wavelength or bands of wavelength takes place. This is known as an *absorption spectrum*. The rainbow colors in a *continuous spectrum* or *Newtonian spectrum*, in which all wavelengths, between certain limits are present. A number of sharp bright vertical lines caused by absorption of glowing vapors elements, is called *line spectra*. When the red flames from lithium and strontium salts are observed through a prism a different bright-line spectrum is given by each. It is caused by emission spectrum up of bright lines on a dark background is known as bright-line spectra. When a band containing a series of spaced lines, which are very close together so that can not be resolved. This is called *band spectra*. The emission and absorption spectra of gemstones are characteristic, which serve to identify the elements present in a

material, while it exists in different positions of bright lines in the spectrum for different elements in any chemical compounds. → Fraunhofer lines.

**spectrum, absorption;** → absorption spectrum.

**spectrum analysis;** the study and identification of a rough quantification of a chemical substance by observation of the spectrum for detection of traces or impurities in a gemstone, because each substance has a characteristic spectrum.

**spectrum color;** visible hues of white light in a continuous spectrum caused by passing through a prism. The colors (6 hues are easily to seen), wavelengths and frequencies are given in a table.

**spectrum color of opal;** a term used by Australian for visible spectrum color seen in a precious opal which radiate from the stone but different from patch color.

**spectrum, continuous;** → spectrum, continuous spectrum.

**spectrum, electromagnetic;** → electromagnetic spectrum.

**spectrum, emission;** → emission spectrum.

**spectrum, Fraunhofer;** → Fraunhofer lines.

**spectrum of aluminum;** → aluminum spectrum.

**spectrum of cobalt;** → cobalt spectrum.

**spectrum of copper;** → copper spectrum.

**spectrum of iron;** → iron spectrum.

**spectrum of manganese;** → manganese spectrum.

**spectrum of mercury;** → mercury spectrum.

**spectrum of light;** spectrum of light extending from ultraviolet to infra red: ultraviolet 100-390, violet 390-430, blue 439-490, blue green 490-510, green 510-550, yellow-green 550-575, yellow 575-590, orange 590-630, orange red 630-650, red 650-700, dark red 700-780, and infra red 780-1,000,000 nm.

**spectrum of rare earth;** → rare earth spectrum.

**spectrum of selenium;** → selenium spectrum.

**spectrum of uranium;** → uranium spectrum.

**spectrum of vanadium;** → vanadium spectrum.

**specular galena;** same as lead glance, galena.

**specular hematite;** same as specularite.

**specular iron;** same as specularite.

**specularite;** gray to black variety of hematite ( $\alpha\text{-Fe}_2\text{O}_3$ ) in tabular, foliated, or disc-like crystals with a splendid metallic luster. Often showing iridescence. Used for engraving into an intaglio and signet ring. Also called specular hematite, specular iron, gray hematite.

**specular;** a synonym for mirror like.

**specular reflection;** reflection of light from a polished surface to distinguished from light reflection below the surface. Also known as mirror reflection, regular reflection, direct reflection.

**specular stone;** a synonym for mica.

**speculative stone;** a term describing the quality of rough

diamond such as color, shape, inclusions, or coating or combination of those factors, which make it uncertain about the final yield.

**speculum**; a Medieval term for the crystal balls applied in divination or lithomancy, or Margaritomancy.

**speculum**; any mirror or other object with a reflective surface due to polished or smooth covered surface. → Speculum metal.

**speculum metal**; a hard, silvery alloy of copper and tin in a 2:1 portion, used for mirror and reflectors.

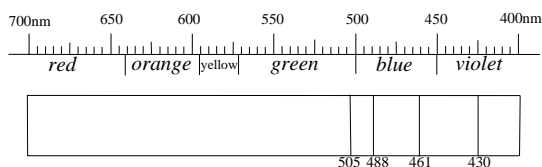
**speed of light**; the speed of propagation of light in a vacuum, which is a natural constant equal to 299,792.4580 0.0012 kilometer per second. The speed of light of any other medium is obtained by dividing light velocity by the refraction index of the medium. Also called velocity of light.

**sperm-whale ivory**; a coarse kind of ivory from sperm-whale or cachalot (*Physeter catodon*), narwhal, and wart-hog, resembling walrus ivory. RI:1.55-1.57. SG:1.90-2.00. H:2¾. Source: in warmer parts of oceans. Used for carving small objects. Sperm whale is also known as black whale.

**spessartine**; another term for spessartine garnet.

**spessartine garnet**; same as spessartite garnet.

**spessartine absorption spectrum**; weak bands at 495, 485, and 462 nm and a weakly band at 432 nm flowing



*spessartite absorption spectrum*

at 424, and 412 nm due to manganese.

**spessartite**; a term applied to a kind of lamprophyre consisting of hornblende, and plagioclase feldspar. → Spessartine garnet

**spessartite as inclusion**; spessartine is included in topaz, and quartz

**spessartite cut**; red-orange to orange color variety of spessartine from Brazil are cut as gems of any size.

**spessartite garnet**; an endmember of the garnet group. A mineral rarely cut as gems, but prized by collectors. It shows no luminescence despite manganese compound. Some small liquid drop inclusions in spessartite formed a wavy feathers, which have a *shredded* appearance. *Camptospeessartite* is a variety. Some species are green like grossular garnet and a flesh colored spessartite from Morehead, USA is misnomered as *flesh-red*. Also spelled spessartine.

System: cubic.

Formula:  $8[\text{Mn}_3\text{Al}_2(\text{SiO}_4)_3]$ . May contain Mn, Fe.

Luster: vitreous.

Streak: white, colorless.

Colors: hyacinth-red, red, yellow-orange, yellow-red, flesh-red, yellow-brown.

Diaphaneity: transparent to translucent.

Fracture: conchoidal to even. Brittle.

Cleavage: none.

SG: 3.80 - 4.25.

H:7-7 .

RI: 1.800.

Birefringence : none.

Dispersion : 0.027.

Found in Brazil, Afghanistan, Australia, Malagasy, Canada, England, Finland, the Czech Republic, New Zealand, Sri Lanka, and USA.

**spessartite garnet, inclusion in**; → inclusion in spessartite garnet.

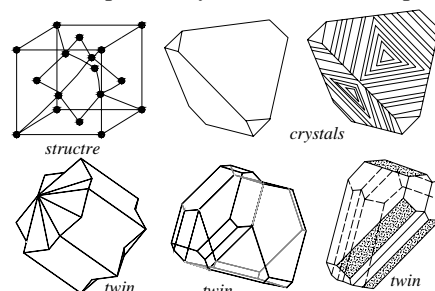
**sphaerocobaltite**; same as cobaltocalcite.

**sphaerolite**; same as spherulite.

**sphaerule**; same as spherulite.

**sphaerulite**; same as spherulite.

**sphalerite**; a trimorphous mineral with wurtzite and matraite. Yellow color sometimes cut as faceted gems, cabochon and prized by collectors. Cleiophane is a



*sphalerite structure, crystals and twins*

colorless, marmatite is a black iron-rich variety. The colorless sphalerite is used as *dense-glass prism* in refractometer, which extends the range of refractive index to 2.371. Also called zinc blende, jack, blackjack, blende, steel jack, mock ore, false galena, mochl lead (Cornwall), wild lead, pseudogalena.

System: cubic.

Formula:  $4[\text{ZnS}]$ . Contain iron.

Luster: resinous to adamantine.

Colors: colorless, white, yellow, green, red, black, gray.

Streak: colorless to pale brown.

Diaphaneity: transparent to translucent.

Cleavage:  $\{011\}$  perfect.

Fracture: conchoidal to uneven. Brittle.

SG: 3.90-4.10.

H:3½-4.

RI: 2.368-2.371.

Dispersion: 0.157 over three times more than diamond.

Found in Spain, Mexico, Namibia, England, Zaire, Sweden, Scotland, Rumanian, Australia, and USA.

**sphalerite absorption spectrum;** frequently three bands in the red at 690, 667, 651 nm due to cadmium.

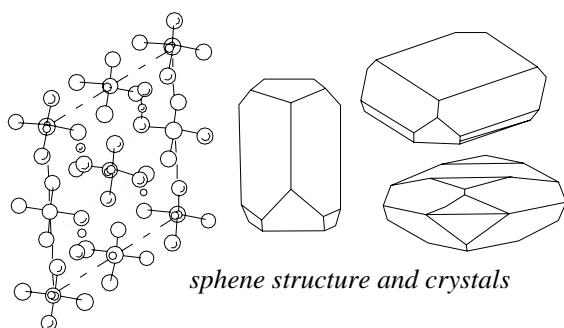
**sphalerite as inclusions;** sphalerite as inclusions can be seen in almandine garnet.

**sphalerite cut;** yellow, red, orange, or green color and sometimes brown cut as a gem and as cabochon. After polishing some yellow color sphalerite resembles a canary diamond.

**sphalerite luminescence;** light orange-red to red under SWUV and LWUV.

**sphalerite refractometer;** → zinblende refractometer, sphalerite.

**sphene;** very rare nesosilicate gem mineral, which is brilliant and sparkles like diamond. Dark colored



natural stones are made lighter by heat treatment. Cut as faceted gems and prized by collectors. Contains niobium, chromium, sodium, iron, manganese, fluorine, and yttrium. Strong pleochroism. Also called titanite, grothite. Greenovite is a variety.

System: monoclinic.

Formula:  $4[\text{CaTi}(\text{O})(\text{SiO}_4)]$ .

Luster: adamantine to resinous.

Colors: colorless, yellow, green, rose, red, brown, blue, gray, black.

Streak: white.

Diaphaneity: transparent, translucent to nearly opaque.

Cleavage: {010} distinct, and sometimes {111} distincts.

Fracture: conchoidal to uneven. Brittle.

SG: 3.45-3.55.

H: 5-5½.

Optics:  $\alpha$ : 1.843-1.950,  $\beta$ : 1.870-2.034,  $\gamma$ : 1.943-2.110.

Birefringence: 0.100-0.192. ⊕.

Dispersion: 0.051.

Found in Canada, Malagasy, Mexico, Myanmar, Austria, Sri Lanka, India, Brazil, Switzerland, and USA.

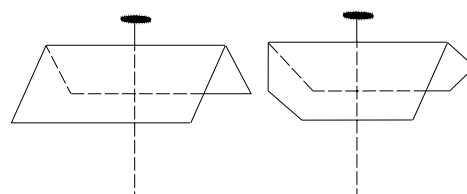
**sphene absorption spectrum;** spectral lines at 586, 582, and 530 nm due to didymium or rare earth spectrum.

**sphene as inclusions;** sphene as inclusions are seen in spinel.

**sphene cut;** chromium-rich green color from Baja, California and Mexico are cut as round brilliant, emerald-cut, and other forms.

**sphene luminescence;** strong: light-yellow, orange-brown to brownish-yellow and colorless-blue.

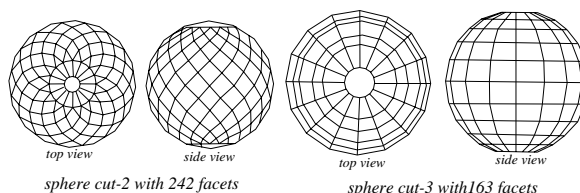
**sphenoid;** a wedge-shaped object with two nonparallel



*sphenoids or dihedrons*

faces symmetrical with respect to a 2-fold rotation axis.

**sphere cut;** globules of precious stone, glass, wood or metal, with or without facets. The form of beads varies from cylindrical, to polyhedral, oblate, or, irregular.



*two different sphere-cuts*

Beads are made from gold, silver, other metals, glass, porcelain, wood, coral, bone, jet, amber, and other organic or inorganic substances. Used as personal adornment, ornamental objects or talismans, ear-rings, necklaces, bracelets, brooches, rosaries, etc.

**spheres and beads;** → beads.

**spherical aberration of lens;** → aberration.

**spherical bort;** same as ballas.

**spherical coordinate;** space or three-dimensional coordination.

**spherical bubbles;** spherical bubbles are inclusions in some synthetic stones.

**spherolites;** same as spherulitic.

**spherule;** same as spherulite.

**spherulite;** a globular to ellipsoidal mass of radiating acicular or prismatic crystals or crystallites structure arranged around one or more centers, usually quartz or alkali feldspar, found in vitreous groundmass of volcanic rocks such as obsidian, perlite, agate. Formed as a result of the devitrification of glassy igneous rocks. Spherulite ranges in diameters from microscopic to

several centimeters.

**spherulite**; a term applied to an obsidian containing sphaerules. Also spelled sphaerolite, sphaerule, sphaerulite, spheruloid.

**spherulitic**; a term described relating to the texture of a rock composed of numerous spherulites. Also spelled spherolites.

**spherulitic jasper**; jasper, in which spherulites usually quartz are distributed through out in different colors from the matrix.

**spherulitic texture**; a texture with radiating mass of fiber from a center point of area like spherulite.

**spica virginis**; → *la spica turginis*.

**spicular chert**; same as spicularite.

**spicules inclusion**; a peculiar tapered, two-phase, dragged-shaped inclusion extending from phenakite crystals in hydrothermal synthetic emerald and synthetic amethyst.

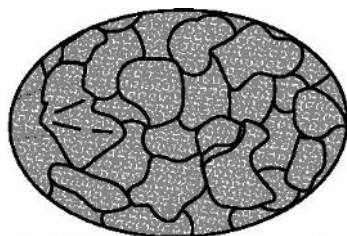
**spiculite**; same as spicularite.

**spicularite**; a sediment rock containing abundant sponge or other siliceous spicules. Also called spiculite, sponge spicule rock.

**spider**; a term used by Australian miners for a small iron device with a ring, which hold a candle to lighten the place of shaft. → *Candleholder*.

**spiderweb obsidian**; a type of brecciated obsidian rock similar to spiderweb.

**spiderweb turquoise**; a network of fine black-brown



*spiderweb turquoise as oval-ring*

veins of metallic oxides, which look like a mosaic at the surface of light blue turquoise.

**spiller amber**; an old term for pressed amber.

**spillikins**; → *jackstraw-like*.

**spill test**; → *light spill test*.

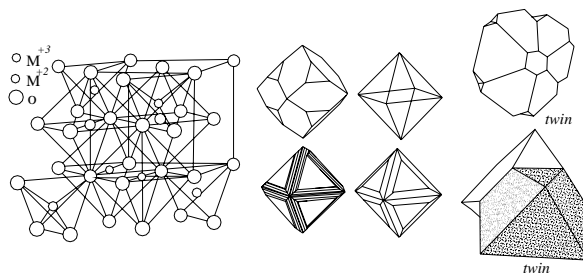
**spinach jade**; dark-green with black flecked nephrite.

**spindle bomb**; same as volcanic bomb.

**spindle whorls amber**; a kind of carved amber in form of spindle whorls put it in the flat-mound graves of females to empowered to prevent evil spirits.

**spinel**; an isomorphous mineral of spinel group. A wide range of colors and shade of gemstone. Red-orange is named as *flame spinel*, an iron-rich dark-green to black, which is known as *green spinel*, *pleonaste* or *ceylonite*, grass-green as *chlorospinel* (iron-rich), brownish-black as *picotite*. *Galaxite* is a black ferrous oxide rich spinel,

blue zinc-rich as *gahnospinel*. *Nin* is local term for black spinel from Thailand. Some specimen with prefix or suffix are erroneously named as ruby or sapphire such as fine red as *ruby spinel* (in Roman times as



*spinel structure, crystals and twins*

*ballas ruby*), and *balas spinel* or *spinel sapphire*. Misnomered are orange-yellow as *rubicelle*, *almandine spinel*. Another stone frequently misnomered as spinel such as *Arizona spinel* or *Kandy spinel*, both of which are garnet. *Star spinel* with 4 and 6-rayed stars are extremely rare. Cut as faceted gems in the brilliant cut, step cut, emerald cut, or mixed cut. Famous spinel gems are: over 500 cts, a stone in National Jewel Treasury of Iran, *Black Prince's Ruby* estimated 170 cts. Timur ruby 361 cts, among British Crown Jewels. The Diamond Fund in Moscow, Russia features a stone of over 400 cts. Synthetic spinel is produced by flux-grown or flame-fusion method. Colorless natural and synthetic variety of spinel is used as a diamond imitation. Also spelled *spinelle*, *spinelite*. → *Synthetic spinel*, *gahnite*, *spinel*s.

System: cubic.

Formula:  $8[\text{MgAl}_2\text{O}_4]$ .

Luster: vitreous.

Colors: shades of red, garnet red, yellow, blue, blue, green, brown, orange, and black.

Streak: white.

Diaphaneity: transparent to opaque.

Cleavage:  $\{111\}$  indistincts.

Fracture: conchoidal to uneven. Brittle.

SG: 3.53-3.65.

H:  $7\frac{1}{2}$ -8.

RI: 1.72.

Dispersion: 0.020.

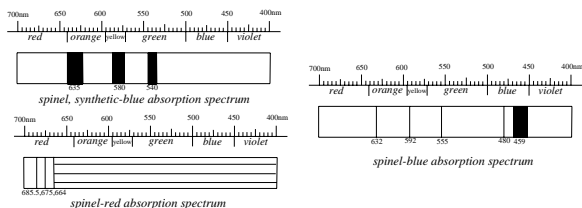
Found in Malagasy, Sri Lanka, Australia, Afghanistan, India, Myanmar, Cambodia, New Zealand, Sweden, Nigeria, Canada, France, Finland, and USA.

**spinel**; a group of minerals with general formula  $\text{AB}_2\text{O}_4$ .

**spinel**; a mineral member of the spinel group.

**spinel**; any mineral or substance that has similar chemical formula and same crystal structure as spinel.

**spinel absorption spectrum;** a characteristic broad band in the yellow-green at 540 nm for red and pink



absorption spectrum of red, blue and synthetic blue spinel

spinel contain chromium. Blue spinel contains iron lines at 458 nm. In the blue and green weak line at 478 nm, and weaker at 443, 433 nm. In the yellow, orange, and green at 635, 585, 555, 508 and 458 nm. The line at 458 nm is not seen in synthetic stones, which is very important for detection.

**spinel as an inclusion;** spinel inclusions are seen in peridot, sapphire, aquamarine, and garnets.

**spinel blue;** gives single refractive index extended from 1.715 to 1.747 and absorption spectrum at 458 nm.

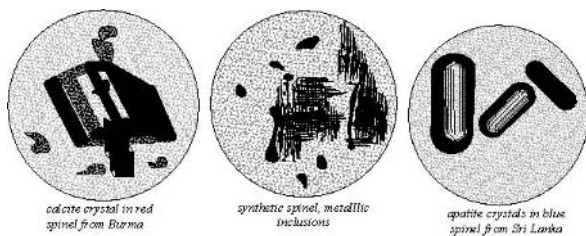
**spinel cat's-eye;** reportedly also exist a cat's-eye spinel.

**spinel cut;** spinel has been cut as faceted gem in the brilliant cut, step cut, or mixed cut set in bracelets, rings, earrings, etc.

**spinel emery;** a mixture of corundum, spinel, and magnetite.

**spinel, fluorescence;** natural red spinel exhibits fluorescence under LWUV light due to chromium impurities. Synthetic green colored spinel by chromium shows red fluorescence under LWUV light and blue synthetic spinel colored by cobalt shows red fluorescence under LWUV light, while under SWUV light fluoresces whitish-blue.

**spinel, inclusion in;** inclusions in spinel are less common than in similar other stone like ruby or sapphire. Rarely silk inclusions, and angular inclusions



inclusions in spinel

that is named as *spangles*, which are inclusion crystals with iridescent stress features surrounded the spots. The internal features seen in some blue spinel from

Myanmar, (Burma) are cracked, negative hollow cavities of octahedral crystals, which may be a member of the spinel group very interesting like a fingerprint, which known as *ghost-like feather* (arranged of thousands very minute crystals), very seldom silk unlike ruby. Sri Lanka (Ceylon) spinel contains zircon haloes, cracks caused by unequal thermal stress in host stone. Red to black star spinels are usually a rarity, when four-pointed caused by needle-like inclusions of rutiles oriented parallel to the cube axis. Sometimes are seen other solid inclusions such as apatite prisms, calcite or dolomite, sphene, quartz, olivine, spinel, limonite crystals.

**spinnelle;** same as spinel.

**spinelite;** same as spinel.

**spinel, luminescence;** pink and red spinel exhibits a strong red glow under LWUV light and weaker under SWUV light, it shows red glow under X-rays. Dark blue shows no luminescence and is inert under X-rays.

**spinel, red;** gives single refractive index extended from 1.715 to 1.735 and absorption spectrum at 450 nm, plus organ pipe fluorescence lines in the red. → Organ-pipe fluorescence, spinel.

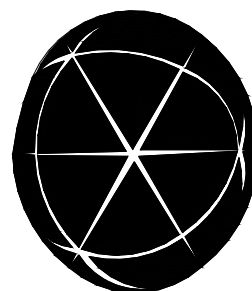
**spinel refractometer;** to achieve higher ranges of refractive index a prism of colorless synthetic spinel of refractive index of 1.726 is used. The majority of stones nearly have this refractive index.

**spinel ruby;** a misleading term for deep red variety of spinel. Also misnomerly called ruby spinel.

**spinel sapphire;** a misleading term for deep blue variety of spinel.

**spinel;** a group of minerals of general chemical formula  $AB_2O_4$ , where A = Mg,  $Fe^{+2}$ , Mn, Zn, and B = Al,  $Fe^{+3}$ , V, Ti, and Cr.

**spinel star;** star spinel in 4 and 6-rayed stars are extremely rare found in Sri Lanka (Ceylon), caused by



star spinel 6-rayed from Sri Lanke. After Guebelin

exsolved sphene needles. A cat's-eye spinel also reportedly exists.

**spinel, synthetic;** → synthetic spinel.

**spinel, synthetic composite stone;** → soudé spinel.

**spinel, synthetic schillerised;** those synthetic white spinel, which are used as an imitation moonstone with

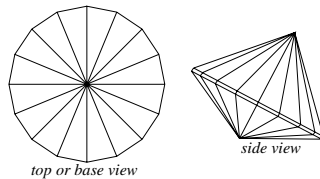
schiller effect caused by secondary heating of stone.

**spinel, synthetic sintered;** → sintered synthetic spinel.

**spinel twin;** the simplest type of contact twin planes of two octahedral faces of two individuals producing flattened triangular form.

**spinel zinciferous;** zinc-rich variety of spinel, which is known as gahnospinel or gahnite.

**spinning wheel cut;** a modification of diamond or other transparent



*spinning wheel-cut*

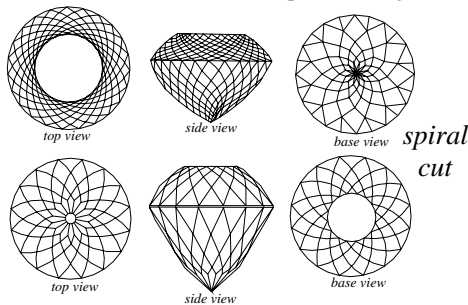
gemstone cut, which has no table, no break facet and no culet similar to a spinning wheel. It is effective for

low-refracting stones, such as quartz.

**spinning wheel lathe;** a kind of lathe device in 19<sup>th</sup> century for turning cylindrical round the articles from amber.

**spinthere;** a greenish variety of sphene.

**spiral cuts;** a modified and complicated style of round



brilliant cut with 154 facets in a spiral arrangement on crown and pavilion. Also called *star cut*.

**spiral dislocation;** same as rolled garnet. → Beryl surface growths features.

**spiral garnet;** same as rolled garnet.

**Spirit of Hope Diamond;** same as Star of Persia Diamond.

**spiropyran;** a colorless aromatic organic compound of 6-nitro-spiro, which reverse convert into purple by both thermochroism and photochroism due to absorption of heat and photon, because of cleavage of a bond.

**splendent;** a degree of luster of gemstones with brilliancy reflection such as hematite or cassiterite. Mirror-like.

**splendent (luster);** crystal surface reflecting light as in a mirror such as hematite or cassiterite.

**spliatir ring;** same as gypsy ring.

**splinter;** a small splinter-like fragment of a diamond crystal, less than one carat in weight.

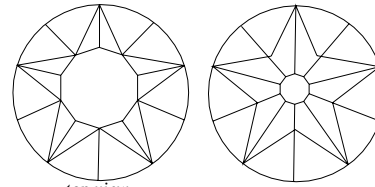
**splintery fracture;** a kind of fracture consisting of long

fibrous, elongated splinter-like fragments such as nephrite or jadeite.

**splints;** small splinter-like or chips of a large fashioned diamond.

**split brilliant;** a term applied to a brilliant cut diamond from a perfect octahedron crystal by sawing into two part at the center.

**split brilliant;** a modified round brilliant cut with 20



*split brilliant-cut*

facets on crown and 20 facets on pavilion plus a table and a culet totaling 42 facets. The star on the crown and on

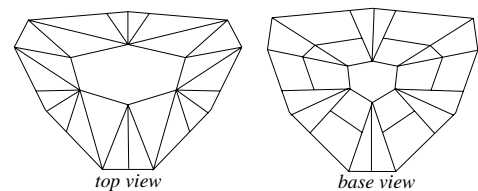
the pavilion are 5-rayed. Used for small stones. Also called split brilliant cut.

**split brilliant cut;** same as split brilliant.

**split facet;** same as break facet, cross facet, skew or skill facets.

**split grade;** a color grading sometimes used as midway between two color grades such as I-J in GIA color-grading system.

**split shield-cut;** a modification brilliant cut for diamond or other transparent gemstone cut with 24 triangular



*split shield-cut*

facets, which has a 6-sided table in the crown and 24 facets with a small 6-sided culet in the pavilion. This cut is similar to shield.

**split stones;** a term applied to diamond classification for cleavage.

**split, to;** another term for cleave.

**splitter;** in diamond manufacture the person who splits a rough diamonds along a cleavage plane after kerfing by means of LASER radiation. Not to be confused with a cleaver.

**splitting;** an industrial sorting of rough diamonds by De Beers for sight of buyers. The diamonds of all categories of shape, weight, color and quality are sorted or split into parcels.

**splitting;** dividing of rough diamonds along a cleavage plane and kerfing by means of LASER radiation. Not to be confused with a cleaver.

**splitting;** dividing of stone crystals due to intergrowth

inclusions in it such as end splitting of some tourmaline because of presence of muscovite in larger tourmaline crystals.

**spodumene;** an inosilicate mineral with single chain of pyroxene group. Cut as faceted gems in all sizes. Pleochroism pink by pink crystal and green by hiddenite. Cut as faceted gems in all sizes. Fluorescence under UV light. Varieties are: *hiddenite* or misnomerly *lithia emerald* in emerald green color due to chromium, and most attractive *kunzite* in pink color. Spodumene is imitated by synthetic pink spinel, and pink colored glasses, it is very easily to distinguish from both, while they are single refractive. Also called triphane.

System: monoclinic.

Formula:  $4[\text{LiAlSi}_2\text{O}_6]$ .

Luster: vitreous sometimes dull.

Colors: colorless, gray, pink, violet, pale green to dark green, blue-green, blue, pale yellow to dark yellow.

Streak: colorless to white.

Diaphaneity: transparent to translucent.

Cleavage:  $\{110\}$  perfect.

Fracture: subconchoidal to uneven and hackly. Brittle.

SG: 3.10-3.20.

H:  $6\frac{1}{2}$ - $7\frac{1}{2}$ .

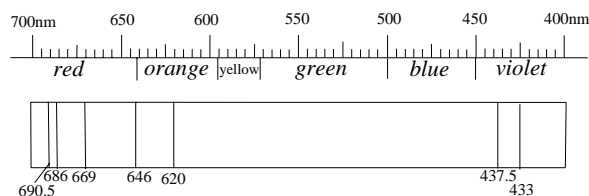
Optics:  $\alpha$ : 1.653-1.670,  $\beta$ : 1.660-1.669,  $\gamma$ : 1.665-1.682.

Birefringence: 0.014-0.027.  $\oplus$ .

Dispersion: 0.017.

Found in Sweden, Scotland, Ireland, Malagasy, Afghanistan, Myanmar, Brazil, South Africa, Zimbabwe, North Carolina, Massachusetts, South Dakota, and California (USA).

**spodumene, absorption spectrum of;** chromium



*spodumene absorption spectrum*

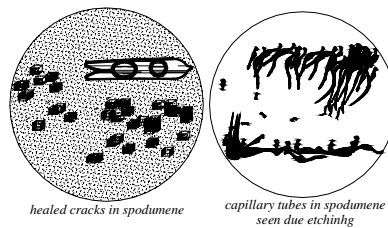
spectrum lines by green stones at 690.5, 686, 669, and 646 nm and broad band at 620 nm, by yellow stones in the blue at 437.5 and 433 nm.

**spodumene cut;** cut as faceted gems in various shades of color and all sizes from kunzite and hiddenite.

**spodumene imitation;** synthetic pink spinel and some pink colored glass are used as a kunzite imitation, both are easily to distinguish, glass is amorphous and spinel cubic, while spodumene is double refractive. Amethyst

is also used but the refractive indices and specific gravity of amethyst are different from spodumene.

**spodumene, inclusions in;** there are some beautiful



*spodumene inclusions*

capillary due to etching or healed cracks are seen.

**spodumene luminescence;** kunzite luminescence under LWUV and SWUV light golden-pink to orange. Strong orange fluorescence under X-ray and phosphorescence, which changes the color of stone to a blue green after phosphorescence phenomenon ceases. Yellow-green variety of spodumene exhibits under LWUV and SWUV light orange-yellow. Hiddenite is inert under UV light but glows under X-ray light orange.

**spodumene pleochroism;** pink stones: lilac-violet to colorless. Green stones: colorless to green, green-blue and green. Spodumene is dichroic but glass and spinel are not dichroic.

**spokes in wheel;** → fixed star emerald.

**spontaneous emission;** a process involving with the emission of light (photons), by an atomic system without any external stimulation (electromagnetic radiation). Emission occurs by transition from an excited state to the ground state. The average of spontaneous fluorescence lifetime, depend on the specific level, which is involved. In contrast to stimulated emission.

**Spoon-Maker's Diamond;** same as Kaikci Diamond.

**spot contact method;** same as distant vision method.

**spot contact refractometer technique;** same as distant vision method.

**spot method;** same as distant vision method.

**spotted;** a clarity sorting grade of rough diamond containing inclusions in the form of spots visible to the naked eye. It is a low purity of stones. Also called spotted goods, spotted goods clarity grade, spotted stones.

**spotted;** a clarity grade of polished diamonds containing spots noticeable to the unaided eye.

**spotted;** a group of contact-metamorphic rocks with characteristic structure such as spotted slate which have a knotted or spotted appearance. Also called maculose, knotted.

**spotted goods;** → spotted.

**spotted goods clarity grade;** → spotted.

**spotted stones;** → spotted.



**spread;** the width proportion to the depth of a cut gemstone or brilliant-cut diamond. → Spread stone.

**spread reflection;** reflection of electromagnetic ray from a rough surface of a gemstone with large irregularities. Also called mixed reflection.

**spread stone;** a trade term for brilliant-cut diamond or other gemstone with a shallower crown and large table over about 60% of the width of girdle, instead of the usual 50%. Also called fisheyes. → Open table, swindled stone.

**spread table;** → spread stone, open table.

**spring;** a term used by Australian miners to some who to go to one's hiding place to take out opal frequently adding opal.

**spring balance;** a device, in which the weight of large specimens of gemstone are measured by the extension or compress of a coiled spring.

**spring gauge;** a device or gauge used in determining the thickness of gemstone or other material in millimeter units.

**spiritual content of gemstones;** a believing of metaphysical idealism of relating to soul, gems or mediums to the moral feelings from external action.

**spurrite;** an attractive, opaque to translucent but rare mineral. It is dimorphous with paraspurrite. Rarely cut as gems.

System: monoclinic.

Formula:  $4[\text{Ca}_5(\text{SiO}_4)_2(\text{CO}_3)]$ .

Luster: vitreous.

Colors: colorless, gray-white, lavender-gray, purple.

Streak: colorless.

Diaphaneity: translucent to opaque.

Cleavage: {001} distinct, and {100} poor.

SG: 3.00-3.01.

H:5.

Optics:  $\alpha$ :1.640,  $\beta$ :1.674,  $\gamma$ :1.679.

Birefringence: 0.039. ⊖.

Found in Ireland, Mexico, California, and New Mexico (USA).

**sputnik mine;** location of diamond mine near the Mir, Siberia, the Russian Federation, CIS, which was discovered in 1959.

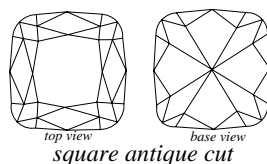
**sputtering;** → vacuum sputtering.

**sputtering, vacuum;** → vacuum sputtering.

**Spyfontein Mine;** location of a small diamond pipe in the Kimberley area, Cape Province, South Africa.

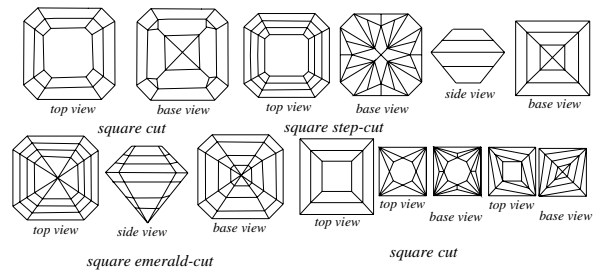
**square;** a trade term for calculation of pearl, price calculation.

**square;** an earlier band of jewels, which is an outlines of a square neckline on women's garment.



**square antique cut;** an old form of square brilliant cut with rounded corner. Older styles of this shape are known as old mine cut.

**square cut;** a modification of cutting a diamond or other

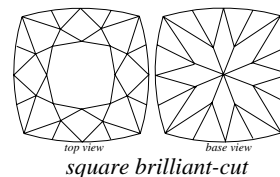


### different square cuts

transparent stone in the form of 4-equal sided, sharp corner and square table with narrow and long facets of step cutting. Emerald cut is an elongated form.

**square cut;** a simple form of fancy cut consisting of 4-sided facets and a culet or without culet on the pavilion.

**square cut;** any square cut stone.



**square cut brilliant;** a style of cutting a diamond or other transparent stone with 36 facets, which is a modification of 18-facet

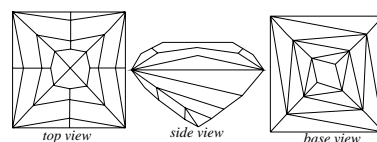
single cut by abutting each of its edges with a double-cut facets. → Square cut.

**square cut glass;** optical glass cut in the form of a square.

**square emerald cut;** a style of step cutting a diamond or other transparent stone with square girdle outline plus modified corner facets. Same as emerald cut with 4-equal-sided girdle outline. → Square cut.

**square hexagon cut;** → hexagon cut.

**square foog cut;** a modified faceted square brilliant-cut in square outline for diamond or other transparent stones with 28 triangular facets without table in the crown. Pavilion has 20

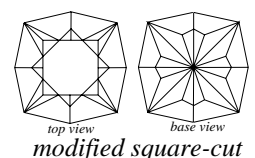


square foog-cut. After N. W. Steele

triangular facets without culet.

**square method;** same as square.

**square modified cut;** a modified faceted brilliant cut in octagonal outline for diamond or other transparent stones with 28 triangular and lozenge

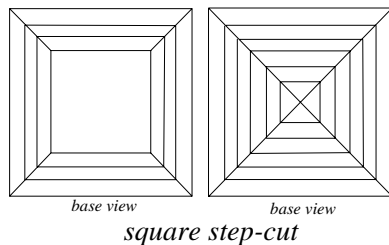


facets with an 8-sided table in the crown. Pavilion has 24 triangular and lozenge facets with a 4-rayed star, no culet.

**square setting;** a setting technique of minute precious stones in a finger ring to make them look larger by securing them with circled metal chips, which are worked up from the surrounding metal.

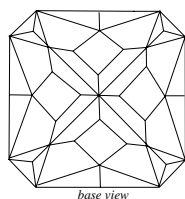
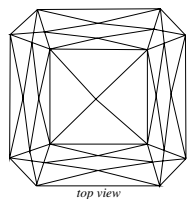
**square shape;** same as square cut.

**square step cut;** an old form of square step-cut with 12



lozenge facets and a 4-sided large table in the crown. A cut form used as finger ring.

**square wafer-cut;** a modified faceted brilliant cut in square outline for diamond or other transparent stones



*square-wafer-cut. After Strout*

with 48 triangular and lozenge facets with a 4-sided domed table in the crown. Pavilion has 48 triangular and

lozenge facets with a 4-rayed star and no culet.

**squibby;** an informal term used by Australian miners the third bed up from the bottom. → Bodgie.

**Sr;** a chemical symbol for the element strontium.

**Sri Lankan Gemmologists' Association;** same as Gemmologists' Association of Sri Lanka

**stability;** a property of gem and other materials, which resists alteration or destruction by heat, light or chemicals or resistance to weathering.

**stack;** a type of steep-sided mass of rock that rising above its surrounding on all sides. Also called rock needle, rock stack.

**staffelite;** a crusty, botryoidal, nodule stalactite variety of colorless flour-apatite containing amounts of carbon oxide. Found in England. Prized by collectors. Synonym for satellites, kurskite, carbonate-flourapatite, carbonate-apatite. Also called francolite.

**stage;** in polarizing microscope a small platform of 3, 4 or 5 axes, which rotates the specimen for study. Pearl or gem testing microscope is provided with special rotating stage. Used for determining the orientation of crystals in relation to the section surface and its symmetry. Also called Fedorov stage, U-stage,

universal motion stage, universal stage, universal immersion stage. → Immersion stage, pearl illuminator.

**stage micrometer;** a device for examining small objects or small distances mounted on a stage used for calibration. The micrometer is set in the ocular or eyepiece of the microscope. → Micrometer eyepiece, Ramsden eyepiece.

**stag horn;** same as deer horn.

**stag horn coral;** any stony coral of the genus *Acropora*, having large skeleton like the horn of a stag or deer horn.

**stag stone;** a stone exists in Grecian mythology, which is believed to prevent baldness and is found in the brain of a stag.

**stain;** a color agent or similar reagent applied to dye some specimens for microscopic study, or stones which are been artificially dyed by using a coloring agent, or by soaking in a substance or chemical and moderately heated, this usually produces a permanent and more pronounced color. → Stained gemstone.

**stained agate;** → dyed chalcedony, stained stone.

**stained chalcedony;** → dyed chalcedony.

**stained jasper;** → dyed gemstone, stained gemstone.

**stained gemstone;** stones, which are been artificially dyed by using a coloring agent, or by soaking in a substance or chemical and moderately heated, this usually produces a permanent and more pronounced color. Some stones are altered by means of radium emanations. The so-called Swiss lapis is a red jasper, which is blue dyed. The two words dyeing and staining are often applied interchangeably. → Color change, dyed stone, coloring gemstones, dyeing, heat-treated stone, irradiation.

**stained pearl;** → dyed pearl, pearl staining.

**stained quartz;** some quartz stones have been stained to improve their appearance and color such as so-called *red jade* is a dyed quartz. To produce artificial iris quartz with rainbow effect (which is called *rainbow quartz* or *iris quartz*), the stone is heated and suddenly cooled in dyed water, such artificially cracked and red- or green dyed quartz is frequently used for this purpose and is called *fire-stone*, which imitate rainbow quartz. For example *Indian emerald* is a misnomer for green crackled quartz. Also called dyed quartz. → Cracked stone, dyed stone.

**stained quartzite;** same as dyed quartzite.

**stained rock;** → quartzite, stained gemstone. Also called sap rock.

**staining;** a method of artificially altering or improving the color of a gem material, especially porous stones such as chalcedony, turquoise, calcite, jade, coral, etc., which are easy to stain with a certain dye used on mineralogical, biological, and other substances. →

Stained gemstone, dyeing, colorant.

**staining gem material;** same as stained gemstone or dyeing.

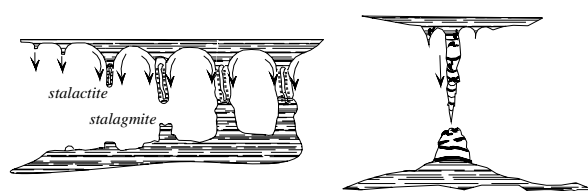
**staining of beryl;** → quinalizarin, P-nitrobenzene-azo-orcinol, alkalinity test, stained gemstone.

**stain, to;** to dye some specimens for microscopic study with a color agent or similar reagent. → Stained gemstone.

**stalactite;** a concretionary, elongated, inverted conical or cylindrical body of dripstone descending from the roof of a cave, usually formed by calcite precipitation as excess carbon dioxide diffuses, when water droplets enter a cave or cavern. Having the shape like an icicle. Found in Mammoth Cave, Kentucky (USA), Han Cave (Belgium), and Carniola Caves (Yugoslavia). Also called tubular stalactite.

**stalactitic marble;** banded marble obtained from roofs and floors of caves consisting of calcareous deposits, which commercially are known as onyx marble. Also called stalagmitic marble.

**stalagmite;** a conical or cylindrical formation of dripstone rising upward from the floor underneath a



formation of stalactite (top) and stalagmite (below)

stalactite of a cave in a Karst environments, sometimes the two may join to form a column. It usually formed by calcite precipitation, as excess carbon dioxide diffuses, when water droplets drip from the roof of a cave or cavern.

**stalagmite;** a conical or cylindrical formation of lava rising upward from the floor of a cavity in a lava flow similar to a stalagmite. Generally measures up to 30cm in high and up to 10cm in diameter.

**stalagmitic calcite;** a variety of opaque, wavy banded travertine, which is known as stalagmitic marble and named in the trade as onyx marble. → Stalactitic marble.

**stalagmite de Bedat;** a variety of various colored stalagmitic marble from de Bedat of Ariège, France.

**stalagmitic formation;** → stalagmite.

**stalagmitic marble;** → stalagmitic calcite.

**stalattite;** an Italian spelling for stalactite and the name of a stalactitic marble from Friuli-Venezia Giulia, Italy.

**Stalingrad Diamond;** same as Siberian Diamond.

**stalky;** consisting of long and slender fibers.

**stamping;** → hallmark, repoussé.

**stamp gold;** crushed or milled gold.

**stamp seal;** → die stamping, seals, stamping.

**standard brilliant;** a rounded brilliant cut diamond usually with 57 or 58 facets and an unpolished girdle. Same as standard round brilliant. → Brilliant cut.

**standard brilliant cut;** same as standard round brilliant cut.

**standard comparison stones;** → master diamonds.

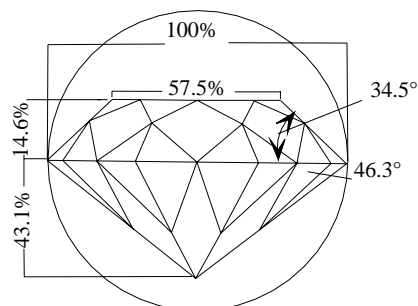
**standard cut;** → standard round brilliant cut.

**standard magnification;** effective way of handling the stone and lens, one hand touching to hold the stone steady and adjust the focus, while the lens must be near the eye. This method and another method are used for diamond grading.

**standard minerals;** a term applied to those minerals, whose presence in a rock theoretically is possible on the basis of certain chemical analysis, but may or may not be always present. Also called normative mineral.

**standard round;** → standard round brilliant cut.

**standard round brilliant cut;** a rounded brilliant cut diamond usually with 57 or 58 facets and unpolished



proportion of facets and their angles on a standard Scan DN brilliant cut. The angles are related to girdle diameter

girdle. On the crown are table, 8 star facets, 8 bezel facets, and 16 upper-girdle facets. On the pavilion are 8 main facets, and 16 lower-girdle facets, it may or may not have a culet. → Brilliant cut.

**standard stones;** → master diamonds.

**standard sources of light;** for testing of gemstones a so-called white light or sun light and artificial light is used. Artificial light must be nearly the same as north light from the northern hemisphere or south skylight. This light is recommended for color grading of diamonds.

**stannian tourmaline;** tourmaline containing stannic.

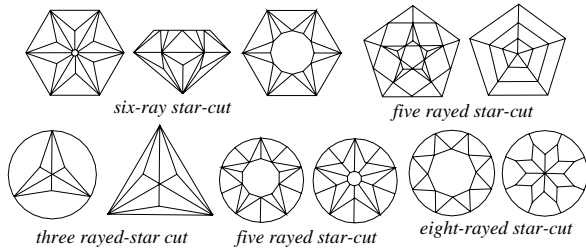
**stannic dioxide;** same as stannic oxide.

**stannic oxide;** a white powder of SnO<sub>2</sub>. Also called flowers of tin, tin dioxide. Same as putty powder.

**stantienite;** an opaque, dark brown to black variety of fossil resin or retinite containing 23% oxygen, black fractured and extremely brittle. Found on the Prussian

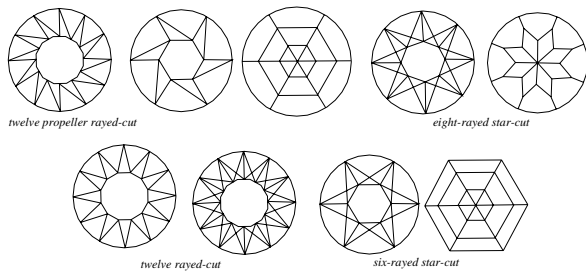
shore, Germany together with yellow amber. Also known as black amber or black amber of Whitby and called Becker amber.

**star;** a rayed figure with any number of arms in a gemstone normally 4, 6 or 12, consisting of two or



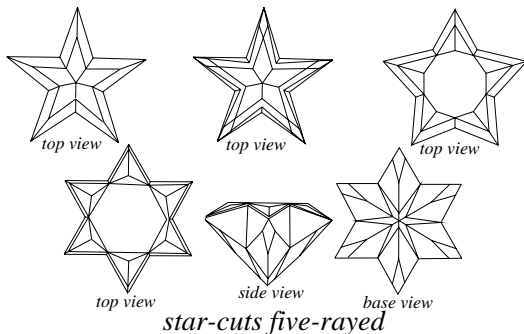
different kind rayed star-cuts

more intersecting bands of light radiating from a bright center. In case of the 6 rayed star it is caused by the presence of fine parallel fibers or crystal inclusions or channels at 60° angles to each other. It can be observed,



different kind of star-cuts

when the stone is cut cabochon with top of the dome perpendicular to the included structure viewed from a certain direction using a strong single reflected light,



star-cuts five-rayed

which is known as *epiasterism*.

**star;** a star can be easily observed, when light is transmitted through the stone, which is termed as *diasterism*. Sometimes occurs star with 3, 5, 6, 7, 9 and 12 rays, caused by absence of a portion of inclusions. Also called asteriated. → Epiasterism, diasterism, asterism, chatoyancy.

**star;** stones, which show such an effects.

**star;** star cut, star facet.

**star agate;** a variety of agate with star shaped effects. Also called asteriated agate. → Ruin agate, landscape agate, fortification agate.

**star almandine sapphire;** purplish sapphire with star shaped effects.

**star amethystine sapphire;** a violet variety of amethyst with star shaped effect, caused by thin fiber of hematite upon the terminal faces. Found in Mexico. It is misnomered as star ruby.

**star aquamarine;** → star beryl.

**star beryl;** a term used for a weak six-rayed asterism beryl, which has been seen in some deep brown variety from Minas Gerais, Brazil. May be caused by oriented ilmenite needles. Cut as cabochon. Also called six-rayed star beryl.

**star bronzite;** brown bronzite with 6-rayed star from Sri Lanka (Ceylon). Star effect caused by oriented hollow rods or tubes. Optics;  $\alpha$ :1.680,  $\beta$ :1.689,  $\gamma$ :1.693.  $\oplus$ . Birefringence: 0.014. SG:3. H:5-6. Star can be seen, when cut cabochon. → Enstatite, bronzite.

**star chrysoberyl;** an unsymmetrically 6-rayed star, which is very rare. Star can be seen, when cut cabochon.

**star corundum;** → star ruby, star sapphire, corundum.

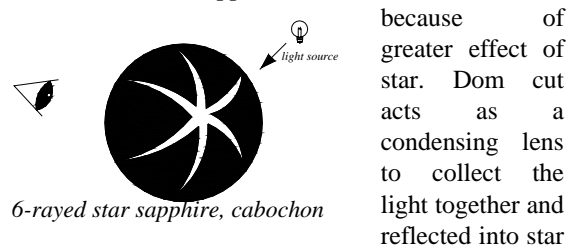
**star corundum, synthetic;** → Linde synthetic star corundum.

**star cut;** a term used for any brilliant cut diamond or other stone whose pavilion facets form a star pattern, when observed through the table. → Star.

**star cut;** a modified round brilliant cut with 154 facets used mostly for colored stones. Also called spiral cut.

**star cut;** a style of fancy-cut, which consists of a 5-rayed star brilliant cut. → Star.

**star-cut cabochon;** a cabochon with star effect. Star-cut rubies and star-cut sapphires are cut as low cabochon



6-rayed star sapphire, cabochon

because of greater effect of star. Dom cut acts as a condensing lens to collect the light together and reflected into star

effected inclusions. → Star sapphire, star ruby.

**Star Cut of Cairo;** same as Cairo star cut.

**star diopside;** a virtually opaque and blackish star-diopside showing a 4-rayed star caused by needles of magnetite crystal as inclusions. RI:1.674-1.700. SG:3.35. Star can be seen, when cut cabochon. Found in Nammakal, southern India.

**star doublet;** an asteriated composite stone constructed

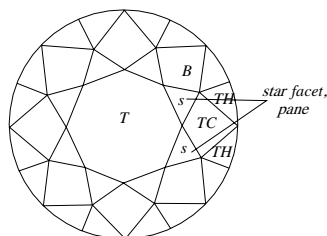
of a star stone for the top of a cabochon, usually heat-treated rose quartz cemented or otherwise joined together with some other stone on the base to imitate a star sapphire or star ruby. Or a thin layer of mirror added to the base of sapphire by using the sputtering method or a ruby colored sapphire used for the top, joined to a base of some other stone, which is provided with intersection lines at  $120^\circ$ . Or some doublet made from star sapphire as base and synthetic sapphire as top, or star sapphire as base and synthetic blue spinel as top, or two pieces of synthetic blue spinel cemented together with a thin layer foil, which is provided with intersection lines at  $120^\circ$ . → Star of destiny, doublet.

**star dune;** an isolated pyramidal shaped hill of sand, its base resembling plane of several-pointed star. Also called pyramidal dune, heaped dune.

**star ekanite;** some specimens of ekanite exhibit a 4-rayed star from Sri Lanka (Ceylon). Star can be seen, when cut cabochon.

**star enstatite;** a dark-brown variety of star enstatite showing a somewhat irregular 6-rayed star. RI1.68. SG:3.10-3.40. Star can be seen, when cut cabochon. Found in southern India.

**star facets;** the 8 small triangle facets on the crown of a



top view of a round brilliant-cut diamond

brilliant cut stone surrounding the table. It is similar to a star.

**star facets;** six three-sided facets on the crown of a rose cut forming a 6-rayed star. The other 18 facets are called cross facets or dentelle. Synonym of star.

**star garnet;** asterism effect can be seen in some varieties of garnet, for example star almandine with 4 or 6-rayed star, when cut en cabochon, or star rhodolite from Zimbabwe, Africa.

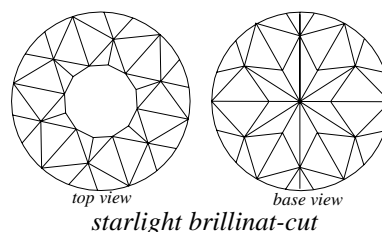
**star glass imitation;** star imitation from glass can be made by pressing a translucent piece to an opaque piece, white glass in a mold, which provided the ridges of the star rays, the outer layer coated with a dark blue glaze.

**starilian;** a commercial term for synthetic strontium titanate used as a diamond imitation.

**starlight;** a corrupt term for starlite.

**starlight;** a modified faceted round brilliant-cut of 42 triangular facets with an octagonal table in the crown which is surrounded by two 8-rayed stars. Pavilion has

44 triangular facets by which a six-rayed star spread from the apex to the girdle.



**starlite;** a fanciful term for fine blue zircon from Thailand. Some specimens are heat treated. Used as a gemstone.

**star kornerupine;** some kornerupine from Mogok, Myanmar, (Burma) contain a star figure.

**star malachite;** a misleading term for a variety of prase malachite or chalcedony including malachite crystals, which are arranged in the form of a star.

**Star Mine;** location of a narrow, vertical kimberlite fissure, diamond mine in Theunissen, South Africa.

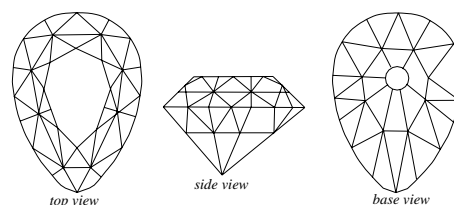
**Star of Abdul Aziz Diamond;** a pear-shaped, flawless diamond of 59 cts, named after the King of Saudi Arabia. It was sold in 1988. Present owner unknown.

**Star of Africa Diamond;** same as Great Star of Africa (Cullinan I) and Lesser or Second Star of Africa Lesser or Second Star of Africa (Cullinan II). → Cullinan Diamond.

**Star of Arkansas Diamond;** a flawless, colorless diamond of 15.33 cts, it was the largest diamond ever found in the kimberlite pipe named the Crater of Diamonds, near Murfreesboro, Arkansas, USA. It was found in 1955 and cut into a marquise of 8.27 cts. In 1968 the star was purchased by a Tucson jeweler and he sold it to a private collector.

**Star of Artaban Sapphire;** a blue star sapphire of 316 cts, now on display at the Smithsonian Institution, Washington, D.C., USA.

**Star of Africa;** a very fine, pendeloque-shaped diamond Type IIa of 530.20 cts, with 74 facets, mounted in the Royal Scepter of the British Regalia.



Star of Africa or Cullinan I

Display among the British Crown Jewels. Also known as Cullinan I, the Great Star of Africa. → Cullinan diamond.

**Star of Asia Diamond;** reportedly (1951) a diamond of

unknown weight worn by Princess Barbe Maria Romanovsky-Tirtoff at her marriage. No further information available.

**Star of Asia Sapphire;** a clear deep blue sapphire of 330 cts, from Myanmar, (Burma) has a strong sharp 6-rayed star. Now on display at the Smithsonian Institution, Washington, D.C., USA.

**Star of Australia (Opal);** an Australian precious opal sold by Percy Marks of Sydney, to a collector from Los Angeles, USA.

**Star of Beaufort Diamond;** esteemed diamond of 100 cts, from South Africa. No additional information is available.

**Star of Bombay Diamond;** a yellow, cushion-shaped diamond of 47.39 cts, of uncertain origin.

**Star of David;** a Hebrew symbol of 6-rayed star formed of two equilateral triangles used in jewelry. Also called Magen David.

**Star of David Diamond;** a rough diamond crystal shaped like Hebrew symbol of 6-rayed star or so-called Star of David composed of two equilateral triangles used in jewelry. Found in 1955 in Transvaal Province, South Africa. Present owner unknown.

**Star of Denmark Diamond;** reportedly a rough, fancy yellow diamond of 105 cts, found in 1885 at the Kimberley Mine, South Africa. It was cut into a diamond of 34.29 cts. Also called Kapiolani Diamond, was once owned by Queen Kapiolani of Hawaii. Present owner unknown.

**star of destiny;** a commercial term for a composed stone used to reproduce the star sapphire and ruby. It consists of a synthetic corundum or spinel on top, a ceramic back and a thin metallic sheet between them. The star effect is produced by reflection of three sets of parallel lines provided on the base of top material. → Star doublet.

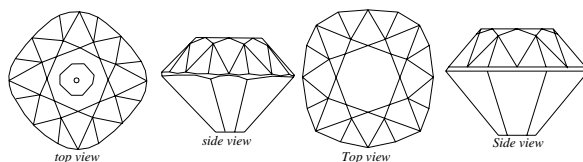
**Star of Diamonds;** a brilliant-cut diamond of 107.50 cts, from South Africa. Assumed to be the same as Rojman Diamond.

**Star of Dresden Diamond;** same as English Dresden Diamond.

**Star of Egypt Diamond;** an octagonal step-cut diamond of 106.75 cts, from India ? It was recut into 105.19 cts, and acquired by Khedive of Egypt around 1850. At the time it weighed 250 cts, in oval shape. He sold it in 1880 and it was refashioned into an emerald cut. It was sold to the London jewelers Wilson & Gill and was later purchased by Farouk Pasha of Egypt. Present owner unknown.

**Star of Este Diamond;** a cushion shaped diamond of 26.16 cts, from India. It was named after Grand Duke Franz Ferdinand of Austria-Este. After his assassination it was passed to the Austrian Crown, and was said to be

owned by Emperor Charles, who died in exile in 1922. Reportedly a diamond of similar description was



*Star of Este Diamond with two different cuts*

bought by Farouk Pasha of Egyptian in 1951. Present owner unknown.

**star of Freyung sapphire;** same as gemma sapphires.

**Star of Independent Diamond;** a flawless, pear-shaped diamond of 75.52 cts, found in 1976 in Sierra Leone, Africa, weighing rough 204.10 cts, Bought by Harry Winston. It was named in honor of the American Bicentennial celebration. Owned by a Middle Eastern Client in 1976.

**Star of India Sapphire;** a clean and flawless star sapphire of 563.35 cts, found in Sri Lanka (Ceylon) about 300 years ago. Now it is in the J. P. Morgan collection of the American Museum of Natural History, New York City, USA. It was stolen but has been recovered.

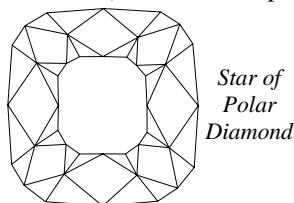
**Star of Minas Diamond;** a diamond of 179.38 cts, found in 1910 or 1911 in Bagagem, Mines, Minas Gerais, Brazil. Whereabouts unknown. Also known as Estrêla de Minas and Estrêla do Sul.

**Star of Murfreesboro Diamond;** a blue, rough diamond of 35.25 cts, found in 1964 at the crater of Diamonds State Park, Murfreesboro, Arkansas, USA. It is the second largest diamond ever found. Present owner unknown.

**Star of Peace Diamond;** a flawless diamond of over 500 cts, found in 1976 in Central Africa, after cutting it weighed 170.49 cts. It was sold in 1981.

**Star of Persia Diamond;** a light yellow, round brilliant cut diamond of 88 cts, set in a brooch with 107 baguettes. It was sold by Harry Winston to a Middle Eastern Client. Also called Spirit of Hope Diamond, Turkestan Diamond, and Good Hope Diamond.

**star of Polar;** a cushion shaped square brilliant cut with 40 lozenge and triangular facets with an octagonal table in the crown surrounded by eight-rayed star which is divided in



two parts.

**Star of Sarawak Diamond;** a diamond of 70 cts, from Borneo Island. In 1870 it was Bought by Rajah of Sarawak. Present owner unknown.

**Star of Sierra Leone Diamond;** a rectangular cleavage diamond of 968.90 cts, found in 1972 in Kono Mine, Sierra Leone, Africa. It was purchased by Harry Winston in 1972. cut it into 17 stones; (I) a pear-shaped of 53.96, (II) an emerald cut of 32.52, (III) an emerald cut of 30.15, (IV) a marquise cut of 27.34, (V) an emerald cut of 23.01, (VI) a pear-shaped cut of 22.27, (VII) a marquise cut of 11.35, (VIII) a pear-shaped cut of 6.44, (IX) a pear-shaped cut of 5.7, (X) a marquise cut of 4.29, (XI) a marquise cut of 3.92, (XII) a marquise cut of 3.73, (XIII) a pear-shaped cut of 2.25, (XIV) a marquise cut of 2.97, (XV) a marquise cut of 2.87, (XVI) a marquise cut of 2.86, (XVII) and a pear-shaped cut of 1.85 cts, with a total weight of 238.48 carats. These were auctioned at Sotheby's in 1988 in New York, USA. Present owner unknown.

**Star of South Africa Diamond;** a pear-shaped brilliant-cut diamond of 47.69 cts, cut from a rough stone of 83.50 cts, it was found in 1869 in Zandfontein farm near Vaal River, South Africa by Swartboy, a native shepherd. It passed through a number of hands until it was sold to Countess of Dudley. It was resold in 1974. Also called Dudley Diamond. Present owner unknown.

**Star of Spalding Diamond;** same as Stewart diamond.

**Star of Suleiman Diamond;** same as Star of Süleyman Diamond.

**Star of Suleman Diamond;** same as Star of Süleyman Diamond.

**Star of Süleyman Diamond;** an oval cut diamond of 93.86 cts, was cut from a rough stone of 149 cts, belonging to the Süleyman Sultan of the Ottoman Empire, Turkey (1495-1566). It was sold in 1957. Also spelled Suleman, Suliman and Suleiman Diamond. Present owner unknown.

**Star of Suliman Diamond;** same as Star of Süleyman Diamond.

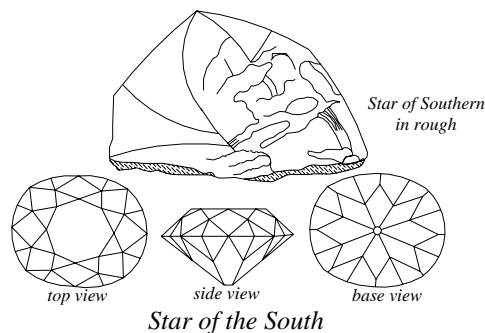
**Star of Texas Diamond;** a sherry-color, round brilliant cut diamond of 48.19 cts, from Africa. It was cut in Belgium. Present owner unknown.

**Star of the East Diamond;** a pear-shaped diamond of 94.80 cts, believed to come from India. It was among the jewels of Sultan Abdul Hamid II of the Ottoman Empire (Turkey) in the early 1900. In 1908 in Paris it was sold by Cartier to Evalyn Walsh McLean. In 1949 it was purchased by Harry Winston together with The Hope Diamond and was resold to the Farouk Pasha of Egypt in 1951. Sold in 1969 to a new client. The stone was repurchased by Harry Winston in 1992.

**Star of the Sky Diamond;** a blue, pear-shaped diamond

of 40.68 cts, from India. Owned by Harry Winston in 1957, set in a pendant. Sold to a European client.

**Star of the South Diamond;** a rough diamond of 261.24 cts, found at Bagagem Mines in Minas-Gerais, Brazil in 1853, and called Estrêla de Minas or Estrêla do Sul Diamond, or Star of Minas diamond. It was cut into a colorless oval brilliant of 128.80 cts, and was named by a French diamond dealer as the Star of the South.



Purchased by Mulhar Rao, Gaekwar of Baroda, India.

**Star of the South Diamond;** a kite-shaped diamond of 15.28 cts, was cut for first time in India, after repolishing by Harry Winston it weighed 14.37 cts, In 1981 it was sold privately.

**Star of Yakutia Diamond;** a diamond of 232 cts, found in 1973 in Sakha (Yakutia), the Russian Federation, CIS. Now on display in the Russian Diamond Fund in Moscow.

**Star of Zion Diamond;** a diamond of 85 cts, found in 1917 at Barkly West, Cape Province, South Africa. Present owner unknown.

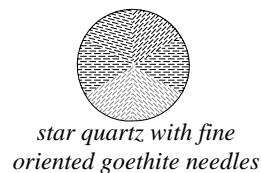
**starolite;** a commercial term for star doublet made from rose quartz with colored back. Used as imitation in star sapphire or star ruby. Also spelled star-o-lite.

**star-o-lite;** same as starolite.

**star opal;** a variety of opal with a star pattern effects.

**star parasite;** 6-rayed star parasite from Muzo mine, Colombia.

**star quartz;** an asteriated variety of quartz, when cut cabochon. The effect caused by submicroscopic inclusion needles of other goethite crystals, which are arranged in parallel orientation.



**star quartz;** an asteriated variety of rose quartz.

**star quartz doublet;** an asteriated doublet made from star quartz. → Starolite.

**star rose quartz doublet;** an asteriated doublet made from star rose quartz and a blue-colored mirror on the back in vacuum. → Doublet, star rose quartz, starlet.

**star rose quartz;** → rose quartz.

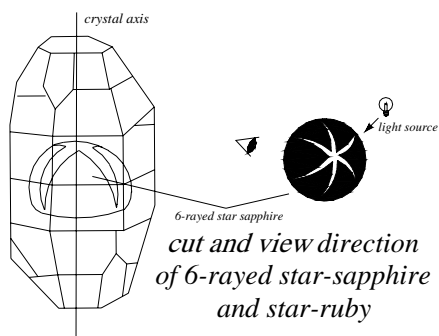
**star ruby;** an epiasteriated variety of ruby normally comprised of 6-rayed star, which has a silky structure, when cut cabochon. It is due to innumerable submicroscopic parallel crystal, bubbles or rod-like inclusions, which are also parallel to the 6-sided ruby crystal. Sometimes a 12-rayed ruby star can be seen in natural and synthetic ruby and sapphire. → Open star, ruby, sapphire.

**star ruby sapphire;** a misleading term for purple, violet, or pink star sapphire.

**star ruby, synthetic;** → Linde synthetic star corundum.

**star rutile, synthetic;** by production of synthetic rutile added 0.5 % magnesium oxide to the compound, which caused star effect, when cut cabochon. → Synthetic rutile.

**star sapphire;** an epiasteriated variety of ruby or sapphire normally comprised of 6-rayed star seen in transparent stones. Asterism caused by innumerable exsolved submicroscopic parallel oriented of rutile



needle or hematite plates, which are known as *silk*, bubbles or rod-like inclusions, which are also parallel to the 6-sided sapphire crystal. This effect can be seen in natural and synthetic sapphire, when cut into cabochon with the bottom parallel to basal pinacoid. In some black sapphires a 12-rayed star can be seen, when enough inclusions of rutile and hematite are present. → Open star.

**star sapphire, synthetic;** → Linde synthetic star corundum.

**star setting;** a style of setting, in which the principal stone is mounted at the center of a provided star and secured at base with metal at each point.

**star-shaped core;** a term used for some small translucent chalcedony, or agate-filled geodes found in rhyolite lavas and tuffs in central Oregon, USA, may be banded or spotted. Some shows a 5-pointed star, when cut into cabochon with the name star-shaped core. Also called agate thunder egg, chalcedony thunder egg.

**star spinel;** a very rare epiasteriated variety of natural star spinel with either 4 or 6-rayed star or both together

from Sri Lanka, caused by exsolved sphene needles.

**star stone;** correctly, same as asteria.

**star stone;** less correctly, any gemstone or mineral stone showing asterism, including petrified wood, in which numerous star-like pattern are included.

**star stone doublet;** → star doublet, star of destiny doublet.

**star tania;** a commercial term for man-made rutile used as a diamond imitation.

**star topaz;** a misleading term for a yellow star sapphire.

**star triplet;** → star doublet.

**starred agate;** a variety of agatized coral from southwest shore of England. The corals are replaced by a pale brown chalcedony included figure of chalk-white stars. Also called Wessex starred agate.

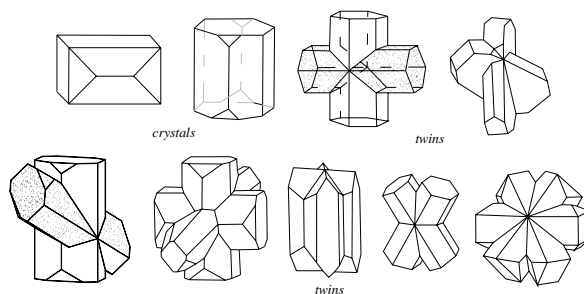
**State Mining Company of Tanzania;** a government society formed after nationalization in 1971, to manage all the mineral and diamond corporations in Tanzania, Africa.

**static cone;** a facility for recovering diamond, composed of a large cone-shaped container, which is filled with water, finely grained ferrosilicon, and crushed ore material. After the apparatus is put into motion the lighter materials or waste float off, and the heavy materials or diamonds sinks to the bottom.

**statuary marble;** white, fine-grained saccharoidal marble used for sculpture, when free from markings. Also called statuary stone.

**statuary stone;** same as statuary marble.

**staurolite;** twined crystals often common as cruciform (at 90° and 60°), known as cross stone or *fairy stone* or



crystals and twins of staurolite

called *cross stone*. Twined crystals are cleaned and polished as charms, amulets, rosaries, cut gems and prized by collectors. *Zincian staurolite* a red-brown, transparent, trichroic zinc-rich variety that is used as a gemstone and prized by collectors. Red or yellow pleochroism. Also called twin stone, lapis crucifer, lusakite, staurotide, grenatite.

System: monoclinic (pseudo-orthorhombic).

Formula:  $2[(\text{Fe}, \text{Mg}, \text{Zn})_2\text{Al}_6(\text{Si}, \text{Al})_4\text{O}_{22}(\text{OH})_2]$ .

Luster: vitreous to resinous.



Colors: reddish-brown to brownish-black.

Streak: colorless to pale gray.

Diaphaneity: translucent to opaque.

Cleavage: {010} distincts.

Fracture: subconchoidal to uneven. Brittle.

SG: 3.70-3.80.

H:7-7½.

Optics;  $\alpha$ :1.739-1.747,  $\beta$ :1.745-1.753,  $\gamma$ :1.751-1.76.

Birefringence: 0.011-0.015. ⊕.

Dispersion: 0.023.

Found in Brazil, Switzerland, Zambia, Scotland, Russia, France, Canada, Austria, Mexico, New Hampshire, Maine, Virginia, and North Carolina (USA).

**staurolite absorption spectrum;** weak band at 578 and 449 nm. Zincian staurolite: strong at 610, 632, and weak at 531 and 490 nm.

**staurolite cut;** faceted gems of dark brown are rare, but twined crystals are cleaned, polished and oil impregnated and used as baptismal stones, curio stones, charms, amulets, rosaries, cut gems are prized by collectors.

**staurolite cut;** faceted gems of dark brown are rare, but twined crystals are cleaned, polished and oil impregnated and used as baptismal stones, curio stones, charms, amulets, rosaries, cut gems are prized by collectors.

**staurolite pleochroism;** golden-yellow, colorless and red or yellow.

**staurolite absorption spectrum;** weak band at 578 and 449 nm. Zincian staurolite: strong at 610, 632, and weak at 531 and 490 nm.

**staurolite cut;** faceted gems of dark brown are rare, but twined crystals are cleaned, polished and oil impregnated and used as baptismal stones, curio stones, charms, amulets, rosaries, cut gems are prized by collectors.

**staurolite pleochroism;** golden-yellow, colorless and red or yellow.

**staurolite absorption spectrum;** weak band at 578 and 449 nm. Zincian staurolite: strong at 610, 632, and weak at 531 and 490 nm.

**staurolite cut;** faceted gems of dark brown are rare, but twined crystals are cleaned, polished and oil impregnated and used as baptismal stones, curio stones, charms, amulets, rosaries, cut gems are prized by collectors.

**staurolite pleochroism;** golden-yellow, colorless and red or yellow.

**staurolite absorption spectrum;** weak band at 578 and 449 nm. Zincian staurolite: strong at 610, 632, and weak at 531 and 490 nm.

**staurolite cut;** faceted gems of dark brown are rare, but

twined crystals are cleaned, polished and oil impregnated and used as baptismal stones, curio stones, charms, amulets, rosaries, cut gems are prized by collectors.

**staurolite pleochroism;** golden-yellow, colorless and red or yellow.

**staurolite, zincian;** → zincian staurolite.

**staurolite;** same as staurolite.

**St. Claude;** a diamond cutting center in Jura region, France.

**stearic acid;** an organic compound of  $C_{17}H_{35}CO_2H$  mixed with bee wax used as incandescence in a candle flame.

**steatite;** a soft, coarse, fine-grained variety of talc. Formula:  $4[Mg_3Si_4O_{10}(OH)_2]$ . Monoclinic system. Opaque. Yellowish-gray, greenish, reddish, brown to yellow. Greasy luster.  $\beta$ :1.584. Birefringence:0.039. ⊕. SG:2.58-2.83. H:1 but often higher owing to impurities. Consequently it has a greasy touch. It is easy to carve as ornamental objects. In ancient Egypt it was carved into scarabs. Sometimes the green variety is carved as jade imitation. Found in Norway, Austria, Italy, USA, Canada, India, Zimbabwe, and Central Africa. Also called soapstone, lard stone, lardite, soap earth and napal (Malayan term). In India a variety of agalmatolite or steatite known as pratima culler. Terms agalmatolite and pagodite applied to talc and pyrophyllite. → Agalmatolite, talc, pagodite.

**stealite;** an obsolete term for chialtolite.

**steatite, glazed blue;** beginning of trade of gemstone motivated the dealers to try to make synthetic Lapis lazuli and began to glazed steatite with blue enamel and sell as Lapis lazuli because of similar blue color, but modern science considered it as an imitation, however it was first step of the birth of synthetic gems. → Synthetic.

**steatite nucleus for cultured pearls;** to artificially insert a hemisphere nucleus in the blister pearl oyster a substance must be chosen, which is not foreign to the oyster. Sometimes hemisphere nucleus beads for mabe cultured pearl made from steatite (soaponite), a soft mineral because it offers no affinity to nacreous. This covered hemisphere cemented to the inner nacreous wall of mussel, which will cut off from the wall. In Japan steatite hemisphere removed by sawing and hollow nacreous is filled with an especial resinous compound and the base of hollow hemisphere is sealed with a disc of mother-of-pearl, after polishing result a symmetrical large cultured pearl blister. This kind of blister pearl is known as *composite cultured blister pearl* or *mabe pearl*. → Nucleus.

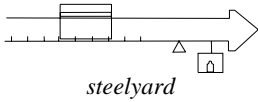
**steel, cut;** → cut steel.

**steel band;** a term used by Australian miners for

bandstone.

**steel jack;** same as sphalerite or zinc ores.

**steelyard;** a weighing balance with two unequal arms, the longer having a moveable counterpoise for holding and immerse of gemstone and the shorter arm for holding weight. Useful for determination of specific gravity of larger specimens. A variety is called Walker's steelyard.



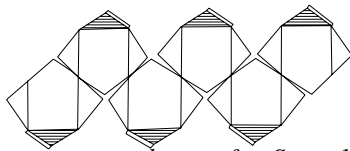
**stellar crystal;** crystal having the form of a flat hexagonal star.

**stellarite;** a commercial term for a variety of blue quartz veined by blue green and metallic gray black quartz material. The color is caused by copper matrix, hematite, and chrysocolla. Sometimes interference colors can be seen due to the presence of planchêite. Found in USA.

**stencil gauge for diamond;** a gauge or stencil of circular or cushion-shaped form for examining the approximately weight of brilliant-cut diamonds, or of pearls corresponding to the girdle diameters of stone. → Moe gauge.

**stengel gneiss;** a German term for pencil gneiss.

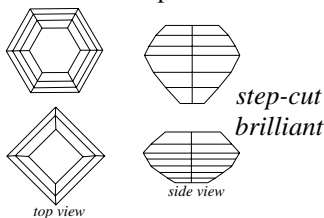
**Steno Quartz;** an original sign of quartz crystal in



Steno quartz, redrawn after Steno 1669

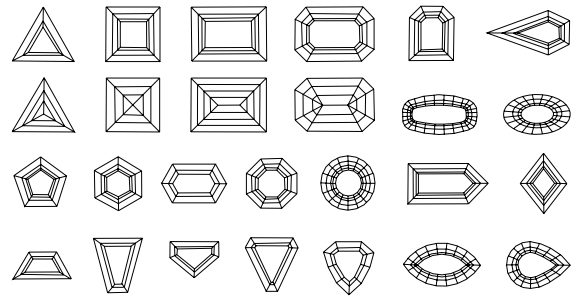
opened two dimensional from N. Steno (Stensen) 1669.

**step brilliant cut ;** a modified brilliant cut for diamond and other transparent colored stones. It has extra shallow row of 12 three-sided facets in the crown adjacent to the table. An extra row of 8 three-sided facets in the pavilion down to the culet. It has more brilliancy with totally 78 facets.



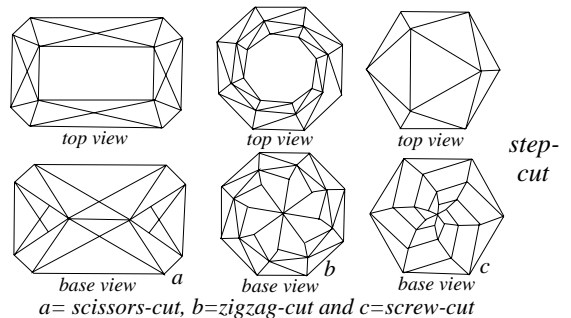
**step cut;** a style of rectangular or 4-sided (6 or 8-sided) trap-cut with long, parallel, usually narrow facets. Favored for emeralds and diamonds and other transparent colored stones with the corners beveled and all surfaces covered by a series of rectangular or square facets or steps on the crown and pavilion, parallel to

girdle. Usually on the crown there are two or three rows, and two or three rows on pavilion, this may vary,



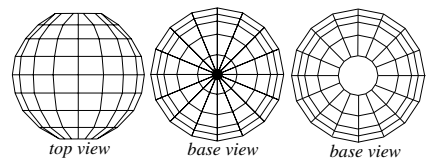
step cuts and mixed cuts

depending on the size of the stone. The table is large and the outline of such a stone can be rectangular, square, octagonal or hexagonal, drop-shaped, trapezoidal, step-cut bead, lozenge-shaped, oval or



semi-circular, which is known as *lunette*. Different forms of step cut are expressed by their outline, such as square step-cut, baguette cut, rectangular step-cut, emerald cut, cross cut, carrée cut, calibré, scissors cut, etc. Also called trap cut. A square cut also known as carrée cut.

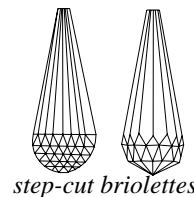
**step-cut beads;** spherical beads, which are entirely



step bead-cut with two different bases

covered with varying 4-sided facets.

**step-cut briolette;** a briolette shaped gemstone, which is entirely covered with varying 4-sided facets except at the ends, which have triangular facets and are circular in cross section.



**step-cut pampile;** a variety of fancy drop-shaped cut

similar to briolette but more shorted with circular cross section that may be polygonal. → Pampille cut, step-cut briolette.

**Stephanie Diamond;** a round brilliant cut diamond of 67.55 cts, bought by Harry Winston in 1957, he set it in a clip and sold it in 1965 to a private Saudi Arabian client.

**stephanite;** a gray-black mineral of  $\text{Ag}_5\text{SbS}$ . Prized by collectors. Also called black silver, melaconite, brittle silver, brittle silver glance.

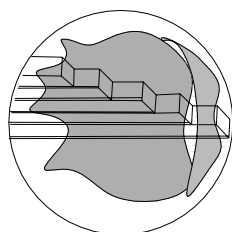
**Stephen's stone;** same as Saint Stephen's stone.

**steplike break;** a kind of fracture exist of a combination of cleavage and fracture in which cleavage is seen in more than one direction such as diamond, sphalerite and fluorite.

**stepped inclusions in corundum;** same as terraced inclusions in corundum.

**stepped leader;** a lightning streamer moving down intermittently appears as a stepped leader, this streaming ionized gas particles.

**stepped twin;** a style of twin with appearance like steps



*step form  
twinning  
in  
chrysoberyl*

caused by parallel planes of brachydome within the crystal such as chrysoberyl.

**stepped twin planes;** → stepped twin.

**stepping;** diamond with a shallowish wavy, or rough surface which appears to be rounded due to stepping grooved, corrugated, or scaly appearance such as nyf or gum-like skin diamonds. Also known as crinkles.

**stereomicrography;** photograph obtained by using a microscope from an subjects. → Binocular microscope.

**stereo microscope;** → binocular microscope.

**stereo zoom;** a commercial term for a binocular magnification system, which is used in a Gemolite or Gemscope device.

**sterling;** same as sterling silver.

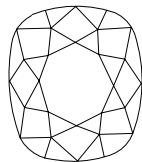
**sterlingite;** same as zincite.

**sterling silver;** an alloy of 925/1000<sup>th</sup> parts or 92½ % silver and 7½ % copper. Used in jewelry.

**Sterns Diamond;** a fancy yellow octahedron diamond of 223.60 cts, found in 1973 in Dutoitspan Mine, Kimberly, South Africa. Cut into a brilliant of 85.93 cts, an emerald cut of 21.04 cts, and a marquise cut of 6.08 cts. It was purchased by Sterns Company and resold in New York, USA. Also called Sterns Star Diamond.

**Sterns Star Diamond;** same as Sterns Diamond.

**Stewart Diamond;** reportedly a yellow diamond of 296 cts, in rough found in 1872 on the Vaal River, South Africa. Cut into a brilliant of 123 cts. It was sold to Stewart a merchant from Port Elizabeth, who



*Stewart  
Diamond.  
After  
Tagore  
1879*

fashioned the stone. Also called Star of Spaulding Diamond.

**stewartite;** a steel-gray, ash-gray variety of bort similar to carbonado containing some iron oxides, having magnetic character, found in Kimberly, South Africa.

**stewartite;** a manganese, iron phosphate mineral of no use in gemology.

**Steyn Diamond, A.;** → A. Steyn Diamond.

**stibiotantalite;** rarely cut as gemstones but prized by collectors. A mineral of stibicolumbite-stibiotantalite series.

System: orthorhombic.

Formula:  $4[\text{Sb}(\text{Ta}, \text{Nb})\text{O}_4]$ .

Luster: vitreous, resinous to adamantine.

Colors: dark brown to pale yellow-brown, reddish-yellow, greenish, yellow.

Streak: pale yellow-brown.

Diaphaneity: transparent to translucent.

Cleavage: {010} distinct, and {100} indistinct.

Fracture: subconchoidal to uneven. Brittle.

SG: 7.34-7.46.

H: 5-5½.

Optics:  $\alpha$ : 2.374,  $\beta$ : 2.404,  $\gamma$ : 2.457.

Birefringence: 0.092. ⊕.

Dispersion: 0.146.

Found in California (USA), Mozambique, Sweden and Western Australia.

**stibium;** same as stibnite.

**stibnite;** a dimorphous mineral with metastilbite. Pale to dark lead-gray, bluish with a tarnished iridescence. Formula  $\text{Sb}_2\text{S}_3$ . Orthorhombic crystal. Opaque. Luster: metallic to adamantine. H: 2. SG: 4.61-4.65. Streak: lead-gray. Cleavage: (100). Fracture: uneven, conchoidal. Very flexible. Reflection pleochroism very strong. Found in China, Japan, USA, Italy, Peru, Germany, Algeria, Thailand, Canada, Mexico, Bolivia and France. Prized by collectors. Also called antimonite, antimony glance, gray antimony, stibium.

**stichtite;** dimorphous of barbertonite. Cut cabochon, used for carving and are faceted, prized by collectors. Greasy touch.

System: hexagonalic.

Formula:  $3[\text{Mg}_6\text{Cr}_2(\text{CO}_3)(\text{OH})_{16}\cdot 4\text{H}_2\text{O}]$ .

Luster: pearly, greasy, waxy.

Colors: lilac to pale violet.

Streak: white to lilac.

Diaphaneity: translucent.

Cleavage: {0001} perfect.

Fracture: inelastic.

SG: 2.15-2.22.

H:2-2½.

Optics;  $\omega$ :1.545,  $\epsilon$ :1.518.

Birefringence: 0.027.  $\ominus$ .

Found in Morocco, South Africa, Australia, Canada, and Algeria.

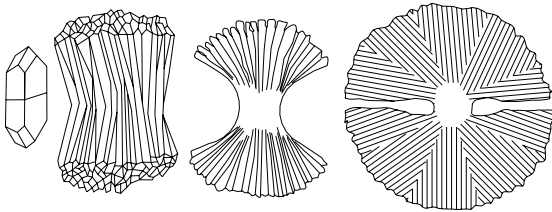
**stichtite absorption spectrum**; absorption spectrum in the red at 665.5, 648, and 630 nm due to chromium and in the blue at 500 nm. Another spectrum exists in the yellow and in the violet.

**stichtite pleochroism**; pale to deep red pleochroism.

**stick**; the wooden holder made of branch of a tree about 20 cm long, to which the stones are jointed for cutting and polishing into gemstones. → Dop.

**stickiness**; resinous material of amber, which was adhered fast as fresh flourished from the tree which contain volatile compounds.

**stilbite**; a zeolite group mineral. Used as an ornamental object because of its cross-shapes twin crystals. It occurs in sheaflike aggregate of crystal. Also called



*crystal and sheaflike aggregate of stilbite or desmine. After Grigor'ev, D.P. and Zabin, A.G.*

desmine, epidesine heulandite. Varieties are: foresite, hypostilbite, syhedrite (obsolete). Found in India.

System: monoclinic and triclinic.

Formula:  $2[\text{NaCa}_2(\text{Al}_5\text{Si}_{13}\text{O}_{36}) \cdot 14\text{H}_2\text{O}]$ .

Luster: vitreous, pearly on cleavage.

Colors: colorless, white, gray, yellowish, pink, reddish.

Streak: colorless.

Diaphaneity: transparent to translucent.

Cleavage: {010} perfect.

Fracture: uneven. Brittle.

SG: 2.10-2.20.

H:3½-4.

Optics;  $\alpha$ :1.484-1.500,  $\beta$ :1.492-1.507,  $\gamma$ :1.494-1.513.

Birefringence: 0.028.  $\ominus$ .

Found in India, Korea, Sweden, Mexico, Brazil, Scotland, Switzerland, Oregon, California, Pennsylvania, and New Jersey (USA).

**stilboite**; same as gehlenite.

**stimulated emission**; a process involving with the emission of light (photons), by an atomic system in presence of an electromagnetic radiation (or stimulation). The emission occurs by exciting of an atom due to absorption of a photon of the adequate energy, than atom can emit a photon. The average of stimulation photons depend of density of photons of electromagnetic radiation. In contrast to spontaneous emission. Also called induced emission, scattered emission.

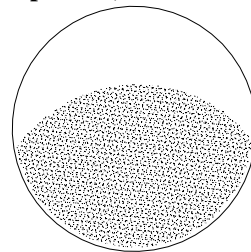
**stinkquartz**; a variety of quartz which emits a fetid odor when rubbed or struck.

**stink stone**; a variety of boulder of phosphate rock emits a fetid odor when rubbed or struck. Also called swinestone, anthraconite, lacullan.

**stink stone**; any stones that emits a fetid odor when rubbed or struck because of decomposition of organic matter such as bituminous limestone or brown dolomite.

**stippled crystal pattern**; a term used for tourmaline cluster aggregate with fine-dotted pattern on the crystal faces.

**stippled pattern**; a fine-dotted pattern, which can be



*stippled pattern after etching a tourmaline sphere with c-axis vertical to positive end.*

*After Kulaszewski*

seen after etching the surface of a tourmaline sphere with *c*-axis vertical at positive end pole.

**stirian**; an early term for nickel-bearing marcasite.

**Stokes' law**; the characteristic wavelength of luminescence glow is always longer than that of the radiation used to excite the luminescence.

**Stolberg diamond**; a misleading term for quartz crystal variety from Stolberg near Aachen, Germany.

**stolzite**; a mineral of scheelite group, dimorphous with raspite. Cut as gems and prized by collectors.

System: tetragonalic.

Formula:  $4[\text{PbWO}_4]$ .

Luster: greasy, resinous to subadamantine.

Colors: gray, shades of brown, yellow, red, greenish.

Streak: white, colorless.

Diaphaneity: transparent to translucent.

Cleavage: {001} imperfect, and {011} indistinct.

Fracture: conchoidal to uneven. Brittle.

SG: 7.90-8.34.

H:2½-3.

Optics;  $\omega$ :2.268,  $\epsilon$ :2.182.

Birefringence: 0.086. ⊖.

Found in Utah, Arizona, Pennsylvania, and Massachusetts (USA), Brazil, Australia, Sweden, Namibia, England, and Sardinia (Italy).

**stone;** in sorting rough diamonds a shape grading term for well formed octahedral crystal over 2 cts, in size, less than 2 cts, is known as *melée*.

**stone;** any minute fragment of natural mineral or rock.

**stone;** a commercial term for cut and polished natural minerals or frequently rocks such as lapis lazuli, or a precious stone or gemstone.

**stone;** an incorrect term for artificial production of gems, or imitation materials.

**stone;** any substance (except pearl) used in gemology because of its appearance (color, brilliance, luster, and diaphaneity) used in cut and polished forms for jewelry, ornamental or decorative objects. Most stones, which are used are minerals or rocks, but some nonminerals are included such as ivory or coral (animal), jet, corozo nut, doum palm nut (vegetable) and amber.

**stone;** a commercial term for any cut and polished natural diamond or gemstone.

**stone;** a suffix for different kind of lithified materials such as sandstone, gemstone, limestone, etc.

**stone;** a term applied to a small piece of rock.

**stone;** a term applied to stony meteorite.

**stone;** a general term used in Australian for opal-bearing material.

**stone;** a term used in Australian for opal.

**stone;** a term used in mining and quarrying industries to cover any hard rock.

**Stone Age amber;** ambers found in tombs of the people of Neolithic Period (since 6000 years, New Stone Age) are crusted with a reddish brown shell, inside is yellow when removed the crust.

**stone cameo;** same as cameo.

**Stone Canyon jasper;** a variety of brecciated jasper from Stone Canyon, California, USA.

**stone coal;** same as anthracite.

**stone coffin;** same as sarcophagus.

**stonecutter;** a term used in stonework industry for one who cut and shaped building stone and monumental figures by hand from rough blocks and slabs of marble, granite, and other stones. According to the style of cutting work or kind of stone is calling granite worker, marble cutter, marble worker, building stonecutter, monument cutter. Also called chisel worker, jagger, stoneworker, stonecutter, -hand.

**stonecutter;** one who cut gemstone.

**stonecutter;** an apparatus for facing stone.

**stonecutter, hand;** same as stonecutter.

**stone dammar;** same as dammar batu.

**stone gauge;** a device used to measure the dimensions of

a gemstone or diamond, after measurements will computed the weight.

**stone gauge;** a gauge, for determining both mounted and unmounted gems such as Leveridge gauge.

**stone gauge;** a card or plate made of metal or other material provided with various sizes of hole of appropriate dimensions for each size. → Caliper gauge, micrometer, stencil gauge for diamond, dial gauge, diamond gauge.

**Stonehenge;** a term applied to the people in England who built vicinity of Stonehenge, which may contain amber ornaments while they are sun-worshippers because they think amber is a sun substance.

**stone of quetzal;** → quetzal chalchihuitl.

**stone of Rome;** → lapis porphyrites.

**stone of Rome porphyry;** → lapis porphyrites.

**stone packets;** → paper wear, stone paper.

**stone paper;** a sheet of folded paper (often white paper) in the form of a pocket, in which gemstones are stored. Often containing lint or cotton wool to prevent stones from rubbing against each other, which is known as *paper wear*. Also called diamond paper. → Appendices.

**stone per carat;** cut diamonds that weighs exactly 1 carat, which are easier to sell in the jewelry trade. Also called diamond per carat. → Magic carat.

**stone quarry;** an open mine where stone is quarried.

**stone to eyeball;** → visual optics.

**stone tongs;** small metal tongs used for holding, picking up and manipulating gemstones made in a variety of forms. → Tweezers, diamond tweezers, pincers.

**stones;** → stone.

**stones, class of rough;** → sorting.

**Stonewin Diamond;** an emerald cut diamond of 78.54 cts, fashioned from a rough stone of 232 cts. Was bought by Harry Winston in 1958, who set it in a burst clip-pendant with 162 small baguettes. It was sold in 1962 in Geneva.

**stonework;** setting of stone for paving.

**stoneworker;** → stonecutter.

**stony-iron;** → stony iron meteorite.

**stony-iron meteorite;** a general term used for meteorites which consisting largely at least 25% nickel-iron and 25% basic silicates such as olivine and pyroxene. Also called stony-iron, iron-stony meteorite, aerosiderolite, sideraerolite, lithosiderite, syssiderite. Prized by collectors.

**stony meteorite;** a general term used for meteorites, which are composed largely, or entirely of silicate such as olivine, pyroxene and plagioclase. Also called stone, aerolite, meteoric stone, meteorlite, asiderite, brontolith. Prized by collectors.

**stope;** the underground working place where extraction

of ore or diamonds occurs in a series of steps.

**stope;** any extraction of ore or minerals in an underground.

**stopping;** the extraction of ore or diamonds in underground, which occurs in step formation.

**stoplight red ruby;** same as traffic signal red ruby.

**Stoppani gauge;** a determining instrument for calculating the dimensions of a mounted gemstone or diamond.

**stop sign;** a term used for triangular feature similar to traffic stop sign seen as surface graining on Itami synthetic diamond from Japan.

**stowing;** a term used by Australian for removing of opal material and dirt into another near space.

**strahlite;** a German term for actinolite.

**straight extinction;** in optics a phenomenon that occurs, when the vibration of rays is parallel to the face of crystal or cleavage inside the mineral. As a thin section of an anisotropic crystal (monoclinic or triclinic) is revolved between crossed Nicols in a polarizing microscope so light is transmitted, when the mineral planes of vibration are parallel to polarizer and eliminated by the analyzer. This occurs 4 times during a complete rotation of 360° of the thin section. Also called parallel extinction.

**straight striae;** lines running more or less parallel seen internally in some natural stones. → Striae.

**strain;** the change of pattern of a crystal or part of them caused, when a body is subject to stress for example in diamond often an inclusion of minute crystal of diamond or other mineral produces anomalous double refraction. This effect can be seen in some singly refractive stones such as garnet, spinel, glasses, etc. → Anomalous double refraction.

**strain birefringence;** → strain, anomalous double refraction.

**strain double refraction;** → strain, anomalous double refraction.

**strained calcite;** a term applied to deformed calcite.

**strain in glass;** glass body usually contains irregular curved striae caused by imperfect mixing material. → Strain, swirl marks, anomalous double refraction.

**strain knot;** peculiar strain knots or so-called pseudo-

spinel, when rotated between polarizing filters. → Tabby extinction.

**strain shadow;** same as undulatory extinction.

**strain twin;** → deformation twin. Also called glide twin, mechanical twin.

**strain twining;** twining which is formed by gliding. Also called twining secondary twining, deformation twining.

**straits stones;** a term applied to poor quality of diamonds from Island Borneo.

**stras;** same as strass.

**strass;** a transparent, brilliant paste of flint glass with high content of lead or thallium, which causes a higher refractive index and specific gravity. RI:1.59-1.68. SG:3.15-4.15. H:5. Used to imitate various transparent gemstones. When colorless used to simulate diamond with addition of metallic oxides obtained colored glass for imitation colored gemstones. Now commercially made in Austria, France and the Czech Republic. Also spelled stras.

**strass;** incorrectly used for any glass used as imitation. → Lead glass, flint glass.

**strass diamond;** a misleading term for glass used as a diamond imitation.

**strass emerald;** to imitate colored transparent emerald added oxides of copper, iron oxide, copper acetate, and chrome oxide to strass glass to obtain emerald green glass with RI:1.59-1.68. SG:3.15-4.15. H:5. Also called emerald imitation, emerald imitation glass.

**strata;** plural of stratum. A sedimentary rock beds.

**stratum;** a single bed or layer of sedimentary rock.

**straticulate;** numerous of very thin parallel layers in sedimentary deposition or of deposition from solution such as banded agate or stalagmite.

**straticulate ironstone;** same as banded ironstone.

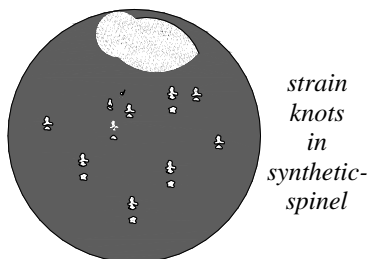
**straw;** a term used in Australian for a pattern of flat sprinkled color on the surface of opal similar to overlapping irregular lines.

**strawberry pearls;** fresh-water, baroque-shaped pearl of pink color with pimply surface.

**strawberry quartz;** a local term used in Sonora State of Mexico for quartz crystal mixed with pale amethyst which contain platy parallel hematite in the outer crystal face of quartz. Used as ornamental stone.

**straw stalactite;** a term used in the USA for a hollow, thin-walled dripstone, which is uniform in diameter through the length.

**streak;** the color of the powder of a mineral usually obtained by rubbing the mineral on a unglazed white porcelain surface, which is known as *streak plate*. With some minerals, this differs from its body color, but is generally constant for the same sample. Pyrite gives a greenish-black streak, body color is brassy yellow.



interference patterns that can be seen in some synthetic

Streak mark is a useful test to identify minerals especially one with metallic luster. Also called streak-test. → Idiochromatic.

**streak;** a mark left on a touchstone to test for its purity and to identify the metals consisting of an alloy.

**streak;** a term used in Australian for on the streak, that mean good color of opal have struck in the digging.

**streak plate;** a piece of unglazed white porcelain used for testing mineral powder color or streak. Hardness of plate is about seven.

**streak-test;** same as streak.

**stremlite;** a commercial term for heat-treated blue zircon.

**strengite;** a mineral of variscite group. Dimorphous with phosphosiderite. It is mixed with other phosphates minerals. Cut cabochon and spheres and made into decorative objects.

System: orthorhombic.

Formula:  $8[\text{Fe}^{+3}\text{PO}_4 \cdot 2\text{H}_2\text{O}]$ .

Luster: vitreous.

Colors: colorless, pale violet to deep violet, carmine, red.

Streak: white.

Diaphaneity: transparent to translucent.

Cleavage: {010} good, and {010} poor.

Fracture: conchoidal. Brittle.

SG: 2.87.

H:  $3\frac{1}{2}$ - $4\frac{1}{2}$ .

Optics:  $\alpha$ :1.704,  $\beta$ :1.719,  $\gamma$ :1.741.

Birefringence: 0.037. ⊕.

Found in Sweden, Brazil, Australia, Rwanda, and California, Alabama, Carolina, Nevada, Arizona, and Florida (USA).

**stress;** an internal force set up inside a stone as a result of strain, which tend to stretch, to compress, to shear or change its dimensions. → Strain.

**stress birefringence;** a property of transparent mineral or gemstone by which birefringence induced by the application of mechanical stress or rapidly cooled substance. Also called stress double refraction.

**stress double refraction;** same as stress birefringence.

**stress cracks;** any external or internal crack responsible for the cloudy appearance of certain stones due to tensile, compressive, or shearing loads.

**stress cracks in amber;** cloudy amber, which has been clarified in heated colza oil or rape oil shows some crack-like marks that resemble the nasturtium leaves and are known as *sun spangled*. Overheating of oil in amber caused stress cracks. Sometimes they are artificially colored. The staining of some fragments of amber to redden the yellow-brown color in order to imitate the so-called *aged* color of samples, also to create green color.

**stress cracks in moonstone;** an impurity inclusion in

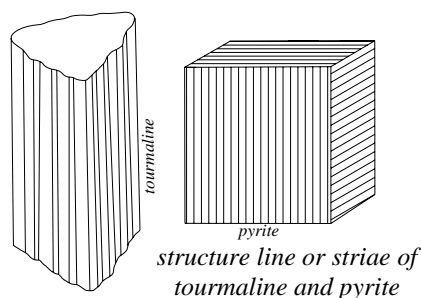
moonstone, seen as aeroplane or pseudo-insect or centipede.

**stress minerals;** an obsolete term for minerals occurring in metamorphic rocks is favored by shearing stress such as kyanite, garnets, ruby, amphiboles, etc.

**strewn field;** a term used for tektites that are found in groups in widely disturbed areas on the earth's surface such as in Moldavian, Czech Republic, Libyan, etc. Those occurring has no relation to the geological formations.

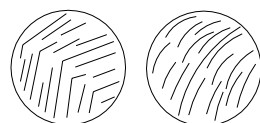
**stria;** one of a series of small parallel or concentric lines. Plural: striae.

**striae;** a series of small, narrow parallel lines or bands



on the surface of crystals such as pyrite caused by oscillation between two crystal forms.

**striae;** the growth-lines of the internal structure of the



left: natural ruby under microscope. Right: synthetic ruby under microscope

stone, which are seen as lines between different colored sheets such as natural sapphire with parallel and straight lines, in

synthetic sapphire they are parallel and curved. Some different striae are mentioned such as cooling striae, straight striae, crystal striae, and curved striae.

**striae;** any parallel, small straight lines on the cleavage planes of a stone such as calcite, etc.

**striae, curved;** → curved striae, strain.

**striae, swirl;** → swirl marks, strain in glass.

**striated crystal;** → striae, strain.

**striations;** any very shallow, parallel lines on the face of a crystal or cleavage of a mineral.

**striations;** any short, narrow, straight or curved scratches cuts in exposed rock by abrasive action.

**striations on crystal faces;** → striations.

**strike of rubies;** a misleading term applied in Australia (1800s), for arousing of local interest to mine pyrope garnet.

**striking;** gold content of gold-ruby glass 0.01% or less, the glass is reheated up to 600-700°C. At this temperature small amount of gold is no longer soluble,

which formed gold crystals.

**stringer**; a term used in Australian for a thin seam of opal color which may be followed for a possible thick and valuable opal stones which occur in a ferruginous hard siliceous groundmass.

**stringer**; an informal term used in Australian for a small vein of potch and color opal, which encourages one to go ahead.

**stringers**; a term used for baulks, small bubble-like cavities may found in cubic zirconia, which is filled or partially filled with not melted zirconium oxide powder.

**stringing**; for precaution of string-bunch of opal, pearl, amber, amethyst or other stones used silk or lined thread with knot between each beads because two reasons (I) to prevent mutual rubbing and chipping, (II) knots also protect the string in the circumstance of string breaking, here only one bead may fall, the rest of string is safety knotted.

**stringing pearls**; → Bombay bunch of pearl.

**strings**; minerals, which occur in a continuous pattern or string in the host rock.

**strip mining**; a method of surface mining of ores in alluvial deposits, in which the overburden is removed in narrow strips. → Opencast mining.

**striped**; another term for banded, rocks having thin and nearly parallel bands or varying colors such as zoned minerals.

**striped sands**; another term for amber banded sands.

**striped jasper**; another term for banded jasper.

**stripy**; the measurement of cultured pearl using a lucidoscope preferably employed in a darkened room where the pearl is rotated slowly in front of a strong light. In the cultured pearl, the parallel layers of mother-of-pearl core are seen as lines across the pearl (stripes).

**stromatolite marbles**; a mushroom-shaped fossilized marble from Rhaetic, England.

**Strombus gigas**; pink conch of genus haliotis found in tropical waters of Florida and Gulf of California/West Indies. Its 20-25 cm pink shell used for decorations and making cameos. Rarely produced valuable pink pearl with the name *conch pearl* with a peculiar appearance on the surface known as *flame pattern*, which is found in the fleshy mantle. SG:2.81-2.87. → Flame pattern pearl.

**strongite**; a commercial term for colorless synthetic spinel used as a diamond imitation.

**strongite**; a trade term for colorless synthetic sapphire used as a diamond imitation.

**strontianite**; a mineral of aragonite group. Rarely cut as faceted gems and prized by collectors.

System: orthorhombic.

Formula:  $4[\text{SrCO}_3]$ .

Luster: vitreous to resinous.

Colors: colorless, white, gray, yellowish-green, rose, brownish, reddish.

Streak: white.

Diaphaneity: transparent to translucent.

Cleavage: {110} semi-perfect, {021} poor, and {010} in trace.

Fracture: subconchoidal to uneven. Brittle.

SG: 3.76-3.79.

H:3½.

Optics:  $\alpha$ :1.520,  $\beta$ :1.667,  $\gamma$ :1.669.

Birefringence: 0.149.  $\ominus$ .

Dispersion: 0.008-0.028.

Found in Austria, India, Canada, Scotland, Mexico, California, New York, Ohio, New Mexico, Texas, and Washington (USA).

**strontianite luminescence**; white, Green, bluish-green, olive-green luminescence under LWUV and SWUV.

**strontium**; a silvery-white reactive metallic element of common alkaline-earth group of the Periodic System resembling calcium with symbol Sr.

**strontium titanate**; a synthetic compound made by the flame fusion method of the Verneuil furnace, introduced in 1953. Occurs naturally with the same composition and is called *tausonite*. It has a high degree of brilliancy and dispersion (0.190) to make a firey diamond imitation. Cubic system. Formula:  $\text{SrTiO}_3$ . Transparent. Colorless, brown, yellow, red and other hues, when doped with pigment metal oxides. RI:2.409. SG:5.13. H:5-5½. Dispersion: 0.190. Used to make doublet or as *mêlée* for diamond imitation. It is marketed under several names but preferred name is strontium titanate. Also called *fabulite*. Inert under X-ray radiations.

**strontium titanate cut**; cut as faceted gems.

**structural**; pertaining to, part of, or consequent upon the crystal structure. → Atomic structure.

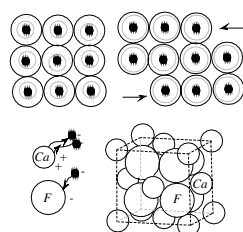
**structural colors**; same as schemochrome. → Biological coloration.

**structural facies**; certain characterized structural feature of an igneous rock or group of such rock.

**structural feature**; megascopic feature of a rock mass or rock unit. Also called structure, large-scale feature, megascopic feature.

**structure**; crystal structure. → Atomic structure.

**structure**; a term applied to the relationship between



crystal  
structure  
formation

different part of a megascopic feature of a rock mass or rock unit such as fibrous, bladed, tabular,



etc. Also called structural feature, large-scale feature, megascopic feature.

**structure lines;** a series of growth-lines with the internal structure of the crystal between different colored layers such as natural sapphire with parallel and straight lines, in synthetic sapphire they are parallel and curved. → Striae.

**structure of rock;** megascopic feature of a rock mass or rock unit may be slaty, stratified, brecciated, fibrous, bladed, tabular, etc. Also called rock structure.

**structure similarities of peal and shell;** structure material of pearl and inner shell lining with the same substance, which was noted by Anselmus de Boot at 1636.

**Stuart Range;** an opal locality at Coober Pedy, Australia. Opals from here are milky in ground color and resemble the White Cliffs opal. Cut as gems.

**Stuart Sapphire;** a fine blue sapphire of 104 cts, set in the back of the British Imperial State Crown. Also called Charles II Sapphire.

**stud;** a button-like fastener used in jewelry to set ornamental objects on a shank, which is passed through an article of garment.

**stylboite;** same as gehlenite.

**style of cutting;** there are many style of cutting such as rose cut, step cut, brilliant cut, antique cut, cabochons, double cabochon, doublets, triplets, intaglios, cameos, mosaics, etc.

**stylolite;** a term applied to a seam or a thin surface of contact usually occurring in carbonate rocks such as marbles, limestones, dolomites, layered siderite and calcareous shales and rarely in quartzites or sandstones.

**styrene resin (plastics);** → polystyrene.

**Styrian jade;** a local misleading term for pseudophite, a variety of clinochlorite, aluminous serpentine, and pennine resembling jade. RI:1.57. SG:2.70. H:2.50. Found in Bernstein, Burgenland, Austria.

**styron;** a commercial term for polystyrene.

**subadamantine luster;** a kind of luster, which is not as highly reflective as adamantine, but higher than vitreous. → Luster.

**subcrust;** another term for sima.

**subconchoidal;** a stone having partially conchoidal surface.

**subcutaneous markings of cultured pearl;** some cultured pearls with green hue show a subcutaneous markings rather similar to *varicose veins*, an indication for cultured pearls.

**subhedral;** a stone showing partially crystal faces. Same as anhedral.

**subjective;** a term applied to stone classification by color, clarity or cut by naked eye rather than by

quantitative measuring using of instruments.

**submarine mineral;** another term for marine mineral, sea mineral.

**submarine mining;** another term for sea mining.

**submetallic;** same as submetallic luster.

**submetallic luster;** a kind of luster between metallic and nonmetallic such as chromite, columbite, and wolframite.

**subsieve;** a subgrade of finer diamond dust or powder extended from 20 to 1 micron (1/1000 of a millimeter).

**subsilicic;** a term applied to an igneous rock by which silica content is less than 55%. Also called basic.

**substage;** a device for holding polarizer or other parts fitted below the stage, used in microscope.

**substage condenser;** a system of lenses fitted below the stage of microscope, often in a focusing mounting, which are employed to converge the light received from the mirror on to the object being examined. → Condenser.

**substage iris diaphragm;** polarizing microscope.

**substitute;** in gemology any imitation substance, which represents a gemstone.

**substitute;** replacement of one atom or molecules in a compound with other elements or molecules.

**substitution;** replacement of an alien atom, or radical by another as a result of chemical reaction, those sites which are reserved for regular atoms. Substitution is divided into simple substitution and charge substitution. *Simple substitution* happen when two elements with the same valence state and particularly same size (misfit of about 15%), replace each other such as replacing of  $\text{Cr}_2\text{O}_3$  the compound  $\text{Al}_2\text{O}_3$  or  $\text{Cr}^{3+}$  for  $\text{Al}^{3+}$ . Substitution of larger size misfits more than 15% are possible at higher temperatures. *Charge substitution* happen when two elements having different valences, a valence misfit of one unit is normal but crystal must always remain electrically neutral. When some MgO added to ruby compound, both aluminum oxide and chromium oxide. As we know chromium can exist in several valence but magnesium only as  $\text{Mg}^{2+}$ . When  $\text{Mg}^{2+}$  replace  $\text{Al}^{3+}$  there is one positive charge missing. Now one oxygen could be omitted from lattice for two  $\text{Mg}^{2+}$  ions, which provided equilibrium of missing negative charge. Or may be a trivalent Chromium  $\text{Cr}^{3+}$  could enter into  $\text{Cr}^{4+}$  state, it mean one  $\text{Cr}^{4+}$  for one  $\text{Mg}^{2+}$  take the place of two  $\text{Al}^{3+}$  and providing a neutral crystal lattice, now the red ruby will be orange brown in color resulting from  $\text{Cr}^{4+}$ , which is named as padparadschah. → Defects in crystal and color effect.

**substitution solid solution;** replacing of particular atom in a crystal by any of two or more elements. → Solid solution.

**subtractive color process;** a term used in optics to process of producing or reproducing by mixing absorbing media such as filter or by three different dyes (pigments). → Additive primary colors, additive color process.

**subtranslucent;** having partially translucent. Same as semitranslucent.

**subtransparent;** having partially transparent. Same as semitransparent.

**subvitreous;** having not quite vitreous luster.

**successive brightness contrast;** same as chromatic adaptation.

**succinic acid;** a colorless crystalline organic dibasic acid of  $\text{COOH}(\text{CH}_2)_2\text{COOH}$  or  $(\text{CH}_2\text{COOH})_2$ , soluble in water, alcohol, and ether, combustible, odorless with an acid taste. Occurring in amber and a constituent of wood bark of certain trees. Obtained from amber together with amber oil and colophony. Succinic acid is used for dyes, lacquers, and perfume and colophony for preparation of varnish. Also called salt of amber, amber salt, amber acid.

**succinite;** an obsolete term for a variety of amber, specially from East Prussia, Poland along Baltic Sea area, which yields succinic acid.

**succinite;** a term applied to amber color variety of grossular garnet mineral.

**succinite garnet;** pale yellow amber-colored variety of andradite garnet.

**succinum;** an ancient term for amber.

**succinum nigrum;** a misleading term for jet used by Parkinson.

**sucrosic;** same as saccharoidal.

**stuffed;** same as shell crystal. → Skeleton crystal.

**suffusion;** bursting out of material on the surface.

**sugar spar;** Cornish term for granular quartz. Also known as sugary quartz.

**sugar stone;** compact, white to pink variety of datolite from Michigan, USA. Cut cabochon.

**sugary;** an informal term used in Australian for opal in which crazing or fissures are so unusual that is likely to crumble like sugar grains with an irregular interlocking.

**sugary;** same as saccharoidal.

**sugary quartz;** a term for massive granular variety of quartz. Also called sugar spar.

**sugilite;** a mineral of osumilite group, similar to sodgiantite. Rarely cut as gems. Variety: wesselite from South Africa. Royal lavulite and royal azel are commercial names for purple variety of sugilite from Wessel Mine, Hotazel, Cape Province, South Africa.

System: hexagonalic.

Formula:  $2[(\text{K},\text{Na})_2(\text{Fe},\text{Mn},\text{Al})_2(\text{Li},\text{Al})_3(\text{Si}_{12}\text{O}_{30})]$ .

Luster: vitreous.

Colors: brownish-yellow, deep rose, reddish-pink, lavender, purplish.

Streak: colorless.

Diaphaneity: translucent to opaque.

Cleavage: {0001} poor.

SG: 2.74.

H: 6-6½.

Optics;  $\omega$ : 1.610,  $\epsilon$ : 1.707.

Birefringence: 0.003. ⊖.

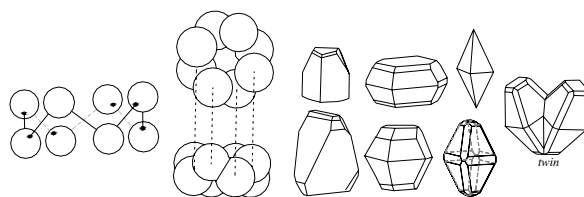
Found in Iwagi Islet, Ehime Prefecture, Japan, and South Africa.

**sugilite absorption spectrum;** in the violet at 411, 419, and 437 nm due to manganese.

**sui;** a Chinese term for a girdle clasp made of jade. → Chinese ritual and symbol jades.

**suite;** same as parure.

**sulfur;** a nonmetallic element in the group VI of the



*sulfur structure, crystals and twin*

Periodic System with the symbol S. Also spelled sulphur.

System: orthorhombic.

Formula:  $16[\alpha\text{-S}_8]$ .

Luster: resinous to greasy.

Colors: shades of yellow, yellowish brown, yellowish green, reddish.

Streak: pale yellow.

Diaphaneity: transparent to translucent.

Cleavage: {001} imperfect, {110} imperfect, and {111} imperfect.

Fracture: conchoidal to uneven. Brittle to sectile.

SG: 2.07-2.10.

H: 1½-2½.

Optics;  $\alpha$ : 1.9597,  $\beta$ : 2.0377,  $\gamma$ : 2.2452. ⊕.

Birefringence: 0.287.

Dispersion: 0.155.

Found in Mexico, Sicily (Italy), California, Wyoming, Nevada, and Texas, USA.

**sulfur;** alpha modification stable above 95.5°. Rarely cut as gems. Synonym brimstone.

**sulfur;** a mining name for pyrite occurring in coal seams.

**sulfur diamond;** a misleading term for pyrite.

**sulfur dye;** one of nonmetallic water insoluble dyes obtained by heating various organic compounds with

sulfur. Made in leuco form by mixing sulfur and sodium sulfide in alkaline solution. Used as dyes.

**sulfur pleochroism;** shades of yellow.

**sulfuret of lead;** same as galenite.

**sulfuric acid;** a colorless liquid, toxic, corrosive, strongly acid ( $H_2SO_4$ ), frequently used to removed polishing residue from diamonds which is called lpolish.

**sulfur stone;** a synonym for pyrite. Also spelled sulphur stone.

**sulki;** another spelling for salaki.

**sulphur stone;** another spelling for sulfur stone.

**Sultan Abdul-Hamid II Diamond:** a fancy yellow diamond of 70.54 cts, which belonged to Ottoman Empire of Turkey, Istanbul. Was sold in 1983, together with the Idol's Eye and Emperor Maximilian Diamond. Present owner unknown.

**Sultan of Morocco Diamond:** a blue gray, square cushion-shaped diamond of 35.27 cts. Bought in 1922 by Cartier in New York from Felix Youssouppoff. It was resold in 1972 in America. Present owner unknown.

**Sulu pearls;** fine pearls from Sulu island, Philippine.

**Sumelpur Mine;** a group of old diamond mines on the Koel River near Sumelpur, India.

**Sumitomo synthetic diamonds;** non-gem quality synthetic yellow diamonds of Type Ib made by Sumitomo Electric Company in Japan. Frequently cut as gems. Its fluorescence is chalky greenish yellow or yellow under SWUV light but inert under LWUV light. Under X-rays fluoresces bluish-white. Not conductive of electricity.

**summit;** a term for crown, apex, peak, top, mountain.

**Summit of crystal faces;** another term for appearance.

**Summit Diamond;** reportedly a diamond of 21.60 cts, sold in 1960 to a Monnickendam director of a diamond company in Hove, England.

**sumptuary law;** a discrimination law was passed in the Middle Ages prohibited the use of certain jewelry objects such as pearl by lower classes.

**sunburst;** a brooch in the form of a sun with 32 projecting straight or wavy rays set with small gemstones. It has a central cluster made of large stones. It varies. Also called *rising-sun brooch*.

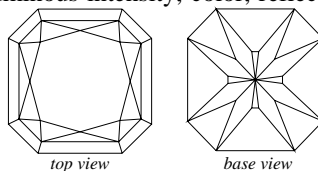
**sunburst aggregate;** a term applied to a kind of mineral aggregate resembling sunlight such as some tourmaline with radial pattern. Also called radial aggregate.

**sun dial ring;** a miniature sundial in form of a portable ring.

**sun flash;** a term used in Australian for a pattern of color unlike flashes of sun usually with opaque, weak dark potch groundmass.

**Sunflower Cut;** a registered name for one of 5 new Flower style cuts, which is a symmetrical cushion-

shape step cut such as emerald, baguette, carré and trapezium with 63 facets. It is said to achieve maximum luminous intensity, color, reflection and profitability. It



Tolkowsky Sunflower Cut.

Courtesy of De Beers

is suitable for pears with 49 facets, navettes with 69 facets, and hearts cut with 55 facets diamonds.

Designed by CSO consultant Gabi Tolkowsky in 1988. It has proportion: Table 53-58%, crown height 17.5-24%, pavilion depth 42.5-51.5% and girdle thin to thick. → Flower Cuts: Fire Rose Cut, Dahlia Cut, Marigold Cut, Sunflower Cut, Zinnia Cut.

**sun-gilded;** a literally term for heliodor.

**Sun God Opal;** another term for El Aguila Azteca Opal.

**Sun of Light Diamond;** → Dewey Diamond.

**sun opal;** variety of fire opal, pyrophanes.

**sun-spangled amber;** → stress cracks in amber, colza oil, clarification of amber.

**Sunrise Diamond;** a fancy yellow, emerald-cut diamond of 100.52 cts, of uncertain origin.

**sun's rays;** same as amber.

**sun-spangled amber;** cloudy amber, which has been clarified in heated colza oil or rape-seeds oil shows some discoidal crack-like marks that resemble the nasturtium leaves and are known as sun-spangled, may caused by droplets of trapped water or overheating of oil. Sometimes discoidal crack-like fissures show an *elegant* appearance with characteristic radiating circular forms within the stone, which are very attractive. The staining of some fragments of amber to redden the yellow-brown color in order to imitate the so-called *aged* color of samples, also to create green color. Occurring of sun-spangled appearance in clarified amber with brown edges discriminated it from natural amber. Recently sun-spangled inclusions are induced into ambroid technically.

**sun-spangled imitation amber;** duplicating of stress cracks in imitation amber, which resemble the nasturtium leaves and are known as sun-spangled.

**Sun spectrum;** → absorption spectrum.

**sunstone** when the inclusions in a mineral are very thin as hematite flakes or goethite or both with metallic sheen known as sunstone.

**sunstone;** a term eventually used by Viking for tourmaline as a navigation compass in the north Atlantic during 8-10<sup>th</sup> centuries.

**sunstone, oligoclase feldspar;** a translucent, grayish white or reddish variety of albite or oligoclase feldspar may be adularia, includes many thin flakes of hematite or goethite or both. Parallel oriented to planes of

repeated twinning. RI:1.54-1.55. SG:2.62-2.65. Cut as faceted gemstones. Found in Norway, Malagasy, Canada, India, Russia, California, Pennsylvania, North Carolina, New York and Virginia, USA. Same as aventurine feldspar.

**sunstone cut;** mostly cut cabochon, or as carved object, and finger ring.

**sun worshippers;** a term used in archaeology for the ancient people of Baltic Sea suggesting a religious in fact the oldest known symbols in the form of a cross with a perforation in the center known as symbol for the cult of the sun wheel (like in India and East Iran today), made of amber.

**super American blue topaz;** → super blue topaz, topaz.

**super blue topaz;** a trade term for dark blue topaz colored by a combination of radiation and linac and then heat treatment. Also marketed as super American blue topaz, super Swiss blue topaz. The induced radioactivity usually decays after one or to two years.

**super Swiss blue topaz;** → super blue topaz, topaz.

**superficial deposit;** same as surficial deposit.

**superficial geology;** same as surficial geology.

**surface blemish;** any flaw on the surface of a fashioned diamond such as scratch, natural, nick (grain, knot, twinning line), cavity, girdle chip, bearded girdle, extra facets, wheel mark, bruise (concussion mark and percussion mark), slight polishing marks, etc. Also known as external characteristic, finish fault, surface marking.

**surface color;** selective reflection of light waves from the surface of a metallic mineral or strongly absorbing materials, which do not lose their color on being grinding. These reflected wavelengths or colors are distinguished from bodycolor, which arises from reflection after penetration into the crystal. When light is transmitted into a crystal the observed surface color is complementary to the reflected color. → Bodycolor.

**surface color-treated amber;** some amber has been made colorless by overheat treatment and then by mean of oxidation to obtain a surface color.

**surface-diffused;** a term applied to adding color to surface-diffused sapphire. → Sapphire color centers.

**surface diffusion;** → sapphire surface diffusion, diffusion technique.

**surface feature;** surface feature of a gemstone can provide valuable information and indication about it. Typical feature are fracture and its luster, cleavage directions and their number, hardness, abraded facet, subjected to a heat-treatment because this tends to increase the brittleness, and indication about the health of the stone. Also called surface structure.

**surface graining;** lines on the surface of a polished diamond, which are usually caused by different

crystallographic orientation of stone.

**surface growth feature;** same as surface feature.

**surface mining;** surface working, opencast mining.

**surface indication;** a term used in Australian for special sign on the surface like a potch or opal area, weathered samples of opal, opalized woods or bones.

**surface marking;** same as surface blemish. → Growth markings (on diamond).

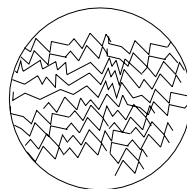
**surface repair;** a new method to fill the surface defects of ruby with a transparent colorless glass, which reduced the view of surface blemishes and increased the weight of the stone.

**surface structure;** same as surface feature.

**surface structure of conch pearls;** the orient of the conch pearl is non-nacreous of inferior quality with a porcelain like surface the appearance and sheen of these pearls is like watered silk with markings similar to a *flame* effects.

**surface structure of imitation pearls;** imitation pearls have an unridged surface and feel smooth between teeth, whereas natural pearl and cultured pearls feel chalky and gritty. Studying the surface with a hand loupe shows that the surface appears like *blotting paper*. Recently made imitation pearls feel gritty, there are distinguished with a pin pressed into the surface, which scratches the coated bead or puts an indent in it.

**surface structure of pearls;** the orient of the pearl is a surface phenomenon, which is caused by diffraction and reflection due to the diffused light source at the edge of overlapping plates of



surface  
of a  
pearl

calcium carbonates.

**surface tension;** a phenomenon of fluid mechanics due to unbalanced molecular cohesive forces near the surface of liquid, it appears to minimize the area of that surface. The surface tension of the water causes the swing of the balance wire-loop basket of the balance. For the reduction of the surface tension of water add a drop or two of detergent to the water. Also called surface tensiety.

**surface tensiety;** same as surface tension.

**surface texture;** a term applied to aggregate of the surface of sedimentary rock particles, independent of size, shape, and roundness which occurring by polish, frosting, and striations.

**surficial deposit;** deposit occurring on or near the Earth's surface. Also called superficial deposit.

**surficial geology;** a term applied to geology of surficial deposits. Also called superficial geology.

**Suriam diamond;** location of small alluvial diamond

deposits of insignificant production in Surinam, Myanmar (formerly Burma).

**Suriam garnet;** same as Syriam garnet.

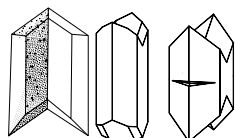
**surmá;** another spelling for surmah.

**surmah;** a Farsi (Persian) term for collyrium with which the eye-lashes and eye-brows are tinged, generally was composed of antimony and frequently of lead-ore. Also spelled surmá.

**susanchi;** a Chinese term for a disc with teeth or cogs made of jade may be used as an astronomical instrument. → Chinese ritual and symbol jades.

**Sussex marble;** a blue-gray to reddish-brown variety of marble belonging to shelly marble containing the gastropod shells of fresh-water snails the genus *Viviparus*. Also known as shelly marble, or Purbeck marble. Found in Sussex, England. Used for building cladding.

**swallow-tail twin;** a type of penetration twin may be seen in gypsum in which one crystal divides into two along a twin plane, giving crystal the shape of a swallowtail or V.



*swallowtail twins*

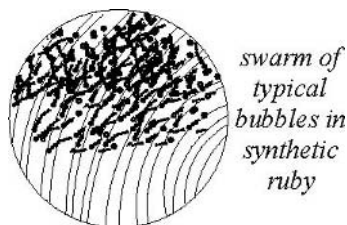
**Swan Diamond;** reportedly a hexagonal mixed-cut diamond of 36 cts, worn by the Queens of Spain, Portugal, Bavaria (Germany), Belgium, France, Holland and Austria. Present whereabouts unknown.

**Swan-Egg Emerald:** a pictorial masterpiece made by Fabergé, shows a lake made of pale aquamarine on which float a platinum swan, which are fits into an egg. Now on display at Diamond Fund Museum in Moscow, Russia. Also called Fabergé's Egg.

**swan mussel;** same as *Anodonta cygnea*.

**swan spectra;** → band spectrum.

**swarm inclusions;** typical bubble inclusions which can be seen in synthetic ruby.



*swarm of typical bubbles in synthetic ruby*

**Swartboy;** a native shepherd who in 1869 found the Star of South Africa of 83.50 cts. Also spelled Zwartboy, Zwartbooi, Swaartboy, Swartbooi.

**swastika;** a Chinese term used for a Buddhism emblem to symbolize to decorate Buddha and his heart. → Chinese ritual and symbol jades.

**Swaziland diamonds;** location of small diamond pipe in the north-east of Kingdom of Swaziland, Africa.

**Swedish amber;** amber found on the Baltic Sea along the shore of Sweden.

**Swedish green marble;** same as Ringborg marble.

**sweetwater agate;** translucent, dark-gray, fluorescent, dendritic agate from Sweetwater River area, Wyoming, USA.

**sweet-water pearl;** same as fresh-water pearl.

**swell;** less preferred synonym for dome and arch.

**Swerdlovsk;** location of a mining, cutting and trading center (city) of gemstones in Ural, Siberia, the Russian Federation, CIS.

**swimming stone;** a lightweight, porous, friable variety of opal that floats on water and is in grayish color, spongy, and concretionary or tuberous mass. A synonym for float opal. Also spelled floatstone.

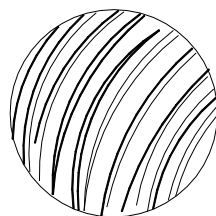
**swindled stone;** a brilliant cut diamond with large table exceeding about 65%, and little depth to retain maximum weight at the expense of accuracy of cut. Swindled stones look like a much heavier stone than they actually are. → Spread stone.

**swindling;** → swindled stone.

**swinestone;** same as stinkstone.

**Swine Creek diamond;** a misleading term for quartz crystal from Ashtabula County, Ohio, USA.

**swirl marks;** irregular curved lines observed within a glass imitation gem or glass bead caused by imperfect mixing of ingredient. Also called swirl striae. → Strain in glass.

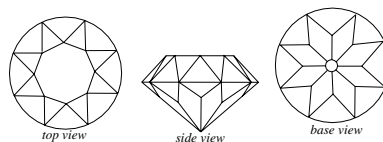


*a typical swirl striae in a paste*

**swirl striae;** same as swirl marks.

**Swiss blue topaz;** → super blue topaz, topaz.

**Swiss cut;** a modified brilliant cut used for small diamond (a) with 16 facets and a table on the crown and



*Swiss cut*

16 facets and a culet on the pavilion. (b) Sometimes it consist of 24 facets and a table on the crown.

**Swiss Gemmological Association;** → Gemmological Association of Switzerland.

**Swiss jade;** a local misleading term for a variety of green-dyed agate or jasper.

**Swiss Lake Habitation;** location of some prehistoric implements made of nephrite, chloromelanite, or jadeite, were found.

**Swiss lapis;** a misleading term for imitation of lapis

lazuli made of blue-stained jasper or chalcedony. Colored by potassium ferrocyanide and ferrous sulfate (components of Prussian blue or Berlin blue). It is distinguished by its high luster, small gray knots of quartz that do not take the dye, and the lake of pyrite sprinkles. Also called False lapis, German lapis. When chalcedony dyed with chromium alum or potassium dichromate, becomes green or greenish-blue color and, when colored with nickel compound it become apple green, with iron when subjected to heat becomes red or brown red.

**SWUV**; an acronym for short-wave ultraviolet. → Ultraviolet ray.

**syenodiorite**; same as monzonite.

**Syferfontein**; location of small alluvial diamond deposit in the Transvaal Province, South Africa.

**Syfergat**; location of small alluvial diamond deposit in the Transvaal Province, South Africa.

**Sydney shell**; → Queensland shell.

**syenite**; a medium to coarse-grained, crystalline plutonic rock, consisting of alkali feldspar such as orthoclase, microcline, biotite, hornblende, augite, corundum, apatite, and diopside.

**symant**; a commercial term for synthetic strontium titanate used as a diamond imitation.

**sylvine**; same as sylvite.

**sylvite**; a potassium chloride salt (KCl). Also spelled sylvine and called leopoldite. Prized by collectors.

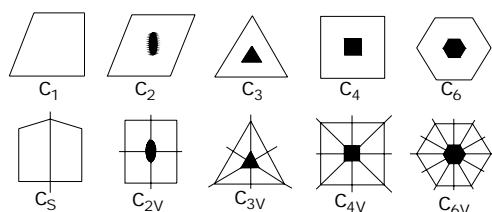
**sylvinitic**; a mixture of halite and sylvite.

**symbol**; in chemistry a letter or combination of letters, which represent an atom of an element such as O for oxygen, Sr for strontium, etc.

**symbol of external symmetry of brilliant**; → blemish symbols of external symmetry.

**symbol of facet plotting**; → blemish.

**symbol of faces of crystal**; in crystallography a natural flat, smooth, planar of geometrical surfaces that bound



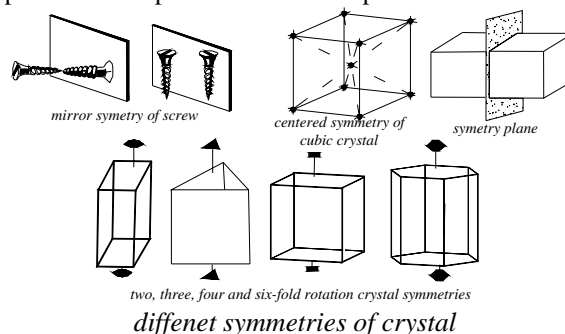
symbols of faces of crystals

crystal, and intersect to form sharp edges, and reflect its internal orderly structure. Crystals with well-developed faces are known as *euhedral* in contrast to *anhedral* and having their crystallographic symbols in relation to symmetry axes.

**symerald**; a commercial term for a natural faceted beryl,

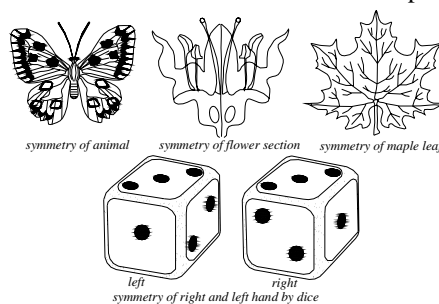
which is coated hydrothermally with synthetic beryl. Developed for first time by Lechleitner of Innsbruck, Austria. → Lechleitner emerald simulant.

**symmetry**; in crystallography; arrangement of the pattern or operation on the pattern leaves then



indistinguishable from their original position, which results in their peculiar internal atomic structure. Four elements of symmetry are described: plane of symmetry, axis of rotation symmetry, axis of rotary inversion symmetry and center of symmetry.

**symmetry**; in gemology a grading term for exactness of alignment and balance of facets or shaping of a



symmetry items. After Tarassow 1982

fashioned stones. Symmetry fault are imperfections or irregularities such as off-center, wavy girdle, out-of-round diamond, etc.

**symmetry axis**; in a crystal, an imaginary line passing through the center of symmetry, when crystals are rotated they comes to the same position in space more than once in a complete 360° turn. There may be two, three, four, or six repetition. Also called axis of symmetry.

**symmetry center**; → center of symmetry.

**symmetry class**; → crystal class.

**symmetry elements**; → symmetry.

**symmetry of crystals**; → symmetry.

**symmetry planes**; → plane of symmetry.

**sym-tetrabromoethane**; same as acetylene tetrabromide.

**syndite**; a commercial term for composite diamond (reminiscent of reconstructed ruby) produced from sintered diamond, no value as a gem but for machine

tool tips.

**syngenetic**; describing of inclusions in a mineral, which were developed, originated or existed at the same time as the host mineral. → Contemporary inclusion.

**syngenetic inclusions**; → syngenetic, contemporary inclusion.

**synapse**; the contact points with axon of bipolar nerves, which influence the dendrites of another nerves of eye. → Eye.

**synthetic**; artificially made substance that has the same appearance, physical properties and chemical compound as its natural counterpart mineral. Some synthetic stones have no counterpart in nature they are synthetic gemstones except if they used as an imitation for a natural stone. Many gemstones have been produced synthetically, but only a few of them are used as cut gems. To distinguish a synthetic stone from a natural stone a microscope is usually used. Sometimes the term *imitation gemstone* is used when a natural gemstone imitates another natural gemstone such as phenakite, or periclase. Also called synthetic stone, synthetic gemstone.

**synthetic alexandrite**; a misleading term for synthetic spinel or corundum (sapphire), which is able to change color like alexandrite reddish-green in daylight and reddish at artificially light, such stones were at first misnomered as *scientific alexandrite*. Synthetic sapphire in trade is known as *syntholite*.

**synthetic alexandrite**; synthetic alexandrite and synthetic cat's-eye has been manufactured but not for trade. → Synthetic chrysoberyl, vanadium in synthetic corundum.

**synthetic amethyst**; after producing colorless synthetic quartz, the iron-rich crystals are irradiated by gamma rays by using lithium salt such as  $\text{LiNO}_2$  to prevent the presence of aluminum, the color will be smoky purple.

**synthetic aquamarine**; a misleading commercial term for pale blue spinel or corundum (sapphire).

**synthetic aquamarine**; synthetic aquamarines produced using a hydrothermal method are made in Siberia, Russia.

**synthetic asterias**; synthetic star stone such as star corundum and star sapphire have been produced. → Linde synthetic star corundum.

**synthetic berlinite**; an isomorphous stone with quartz of formula  $\text{AlPO}_4$ . It shows nearly similar interference figure, exhibits left- and right-handed effect like quartz.

**synthetic beryl**; synthetic beryl has been produced by Biron hydrothermally method in pink color, when added  $\text{Ti}^{3+}$ . → Synthetic emerald, Biron hydrothermal synthetic emerald.

**synthetic beryl, doped**; synthetic beryl has been doped in pink brown by cobalt, deep blue by iron, light green

by nickel, grayish green by manganese. → Synthetic emerald.

**synthetic bismuth germanate**; a transparent compound of  $\text{Bi}_4\text{Ge}_3\text{O}_{12}$  or  $\text{B}_{12}\text{GeO}_{20}$ , in orange color. Isotropic crystal. RI:2.07. SG:7.12. H:4½.

**synthetic bismuth silicate**; a compound of  $\text{B}_{12}\text{SiO}_{20}$ , usually colorless, orange to brown. Isotropic crystal. RI 2.00.

**synthetic blue corundum**; same as synthetic sapphire.

**synthetic boron carbide**; → boron carbide.

**synthetic boron nitride**; → borazon.

**synthetic boules**; → boule.

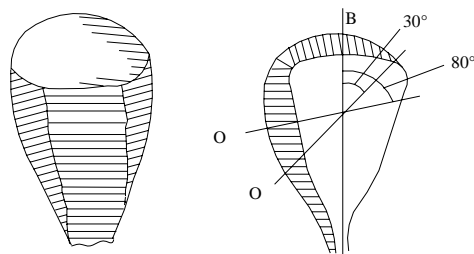
**synthetic bromellite**; a colorless, transparent, hexagonal stone of formula  $\text{BeO}$ . Optics;  $\omega$ :1.719,  $\epsilon$ :1.735. Birefringence: 0.016.  $\oplus$ . SG:3.0.  $H \approx 9$ .

**synthetic chrysoberyl**; synthetic alexandrite chrysoberyl has been made by melt-growth method including Czochralski pulling technique and floating-zone process or solution-growth method (flux process). → Synthetic alexandrite.

**synthetic citrine**; iron oxide or hydroxide must be added to the growth solution of synthetic quartz. To produce yellow color it needed oxidizing conditions, to which will be added the components  $\text{LiNO}_3$  or  $\text{LiNO}_2$ .

**synthetic coral**; → Gilson-synthetic coral.

**synthetic corundum**; various colored synthetic corundum have been produced by hydrothermal method, Czochralski pulling technique and floating-zone process or solution-growth method include flux process, and melt-growth method. Synthetic corundum is produced from pure alpha aluminum oxide free from potash (corresponds to white sapphire, which is known as *walderite*) in an oxyhydrogen flame. Synthetic rubies are produced by Kashan, Chatham, and Knischka in the form of a single crystal with the name *boules* in many shapes such as rods, slender, carrots, etc. by adding nearly 2.5 %  $\text{Cr}_2\text{O}_3$ . Green synthetic corundum is named as *amaryl*, and also used as simulates, yellow



left: a synthetic ruby boule. Right: cross section through a ruby boule. O: optical axis. B: boule axis

colors is misnomered as synthetic topaz. Blue sapphire is made by adding titanium and iron caused by intervalence charge transferring between  $\text{Fe}^{3+}$ - $\text{Ti}^{3+}$  and

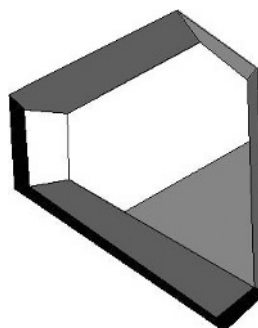
$Fe^{2+}$ - $Ti^{4+}$ . Purple sapphire is obtained by adding about 3 % vanadium, which is misnomerly named *synthetic alexandrite*. Star sapphire or star ruby of different colors are produced by addition of 0.1-0.3 % titanium oxide and reheated at high temperature about 1300° C to precipitated it as needle crystals of rutile. Characteristic by synthetic corundum are several curved striae and spherical gas bubbles and may be round in cross-section, but elongated and they may be found in groups of many tiny bubbles using a microscope other characteristic marks are flask or tadpole shape inclusions. Other methods used to make synthetic rubies is applying *Geneva ruby* technique, by which stone is produced from particles of natural rubies fused together by addition of potassium dichromate, which was called *reconstructed ruby* or *reco*, also once was called *Wyse ruby*. To test use ultraviolet light with the SWUV light synthetic rubies show intensive glow and blue synthetic sapphire glows bluish-green and sometimes different intensity of bands can be seen. Absorption spectrum in synthetic ruby is same as natural ruby. → Linde synthetic star corundum.

**synthetic cubic zirconia;** a transparent synthetic substance with the formula  $ZrO_2$ . Cubic system. Colorless to light yellow and brown. Naturally counterpart is baddeleyite. Produced in all colors by the addition of rare-earth and transition metal oxides. Crystals are grown by the *skull crucible* method by addition of calcium oxide or yttrium oxide, which stabilizes the cubic crystal system. Its refractive index and dispersion are near to the diamond, but its specific gravity is much higher and its hardness is lower. RI:2.09-2.18. Dispersion: 0.060-0.065. SG:5.54-6.00. H:8¼-8½. Transitional elements such as oxides of bivalent and trivalent cerium create yellow, red or orange colors; oxides of copper, iron, nickel, titanium and praseodymium create amber brown to yellow colors; oxides of holmium, europium and erbium create pink color; oxides of cobalt, manganese and neodymium create pink or lilac; oxides of chromium, and vanadium create green to olive-green colors. Also called cubic zirconium oxide, phianite, and djevalite. In Russia known as phianitex and in England as Windsor Gem. Yellow color used to imitate fancy yellow diamonds and cut as cabochon and beads. Examination of absorption line at the 415 nm lack, which shows natural fancy yellow diamonds. Inert under X-ray radiations. Abbreviation: CZ.

**synthetic cubic zirconia;** misnomered as American diamond. → Skull crucible process.

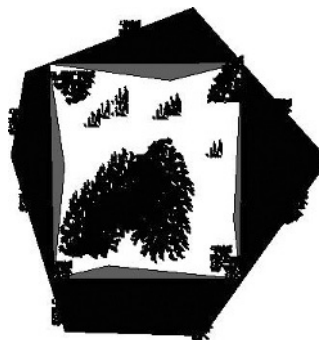
**synthetic diamond;** man-made diamond produced by dissolving carbon-bearing material such as graphite at high temperature about 3000° C and pressure 110,000 atmospheres in molten iron or nickel, in special

apparatus. Simplified synthetic diamond produced by means of thermite; a mixture of aluminum or magnesium powder and barium peroxide or other metal oxide (1:1). When ignited by magnesium ribbon very



*synthetic  
diamond from  
Adamant  
Research Lab.  
South Africa*

high temperature about 2200° C are produced. Soapstone mixed with thermite is also used for production of synthetic diamond. Saponite mixture is placed in a hollow ½ sphere in the center of this sphere will placed another hollow ½ sphere of tantalum, and in the last hollow ½ sphere center is placed the reagent composed of graphite and iron carbide. Also created by



*synthetic  
diamond  
with  
nickelcarbide  
inclusion*

using the chemical vapor deposition technique. Synthetic diamonds are colorless, yellow, amber-yellow, gray, blue, green, and black and some pieces shows magnetic response. Some man-made stones are marketed as diamond imitation such as YAG, cubic zirconia, fabulite, titania, etc. → Belt of synthetic diamond pressure.

**synthetic diamond grit;** → natural grit.

**synthetic doublet;** → doublet.

**synthetic emerald;** synthetic emeralds are produced by flux-melt or hydrothermal method, also made by coating method of pre-shaped natural beryl with synthetic emerald by hydrothermal technique known as symerald. Using a microscope in natural emerald three phase inclusions are detected, while in synthetic emerald feather or two phase inclusions seen. Fluorescence effect in synthetic emerald is stronger than natural emerald. Synthetic emeralds made in Germany are marketed as igmerald.

**synthetic emerald, of Biron method;** → Biron



hydrothermal synthetic emerald.

**synthetic emerald, by Emerald Pool Mining Company;** → Biron hydrothermal synthetic emerald.

**synthetic fish-scale essence;** an inorganic imitation product of essence d'orient made synthetically of basic platy or needle-shaped tiny crystals of lead carbonate. Other inorganic imitations are made of small crystals of mica covered completely on both sides with sheets of titanium oxide or so-called anatase so that both materials are uniquely spread in pyroxylin, a nitrated cellulose. The nearly parallel oriented layers cause the effect of iridescence and interference of light through thin layers, which are called *Bragg lattice*.

**synthetic fluorite;** various colored synthetic fluorites are made, which resemble the natural stone with the same properties but it is too soft to cut as gems. Prized by collectors. It shows fluorescence under X-rays.

**synthetic gadolinium gallium garnet (GGG);** a garnet-type synthetic diamond substitute made in 1973 of  $Gd_3Ga_5O_{12}$  or  $3Ga_2O_3 \cdot 5Ga_2O_3$ , by Czochralski process can be colored with 3-valent elements such as Cr, Pr, and Nd in green, yellow, and pink. Bivalent elements can be added but coupled with 4-valent element such as replacement of  $Al^{3+}$  from  $Co^{2+}$  happen by adding of  $Si^{4+}$ , which give a blue color. With silicon and cobalt a blue color is obtained. When manganese is coupled with silicon lilac red stone is produced. Cubic system. RI:2.02-2.03. Dispersion: 0.045. SG:7.00-7.09. H:6¾. No counterpart exists in nature. Its color changes to brown when exposed to sunlight or ultraviolet light due to impurities, this effect is irreversible. It glows yellowish under SWUV and LWUV light, under X-rays glows violet. Commercially is named as galliant. Used as a diamond imitation. Abbreviation: GGG or three Gs.

**synthetic gahnite;** synthetic gahnite has been produce with small differences in specific gravity and refractive index.

**synthetic garnet;** a misleading term for a kind of colorless (or various colored) synthetic stones, which has no counterpart in nature but similar structure as garnet. Formula:  $Gd_3Ga_5O_{12}$  or  $3Ga_2O_3 \cdot 5Ga_2O_3$ . It is made by Czochralski process. It can be colored with trivalent elements (rare earths) or sometimes with divalent ion. RI:2.02-2.03. Dispersion: 0.045. SG:7.00-7.09. H:6¾. A variety of them is known as YAG an abbreviation for yttrium aluminum garnet or diamonair used as a diamond imitation. RI:1.83. Dispersion: 0.028. SG:4.55. H:8¼. → Synthetic gadolinium gallium garnet.

**synthetic gemstones;** → synthetic.

**synthetic germanates;** a compound of general formula  $A_5Ge_3O_{11}$ , where A can be bismuth or lead.

Germanates are transparent and have similar properties to silicon. → Synthetic lead germanate.

**synthetic greenockite;** a transparent, orange-yellow colored synthetic greenockite made with the formula: CdS. RI:2.50. SG:4.90. H:3½.

**synthetic grit;** → natural grit.

**synthetic hematite;** a misleading term for steel-gray synthetic titanium dioxide, and yellow brown streak, while hematite has a cherry red streak. SG 4.00. H 5.

**synthetic hematite;** also a misleading term for a synthetic stone made of lead sulfide with some silver. SG:6.50-7.00. H:2½-3. Readily fusible.

**synthetic hematite;** an imitation is grown from silicon by the pulling method. SG:2.33. H:7.

**synthetic hematite;** a hematite imitation made of deep-red synthetic iron-rich garnet with the name *hematite garnets*, which have appearance like hematite. SG:4.16.

**synthetic hematite;** → hematine, hematite imitation.

**synthetic hematite garnet;** → synthetic hematite, hematite garnet.

**synthetic hydrophane;** an orange color, which appears when the synthetic hydrophane with play-of-color is put in water. After removal the stone from the water it look slightly more transparent than before.

**synthetic jadeite;** a synthetic jadeite was made by General Electric in USA In 1987. The properties are similar to the natural jadeite but color is rather more intense than natural. → Jade imitations.

**synthetic lapis lazuli;** an uncommercial and very complex method used to produce lapis lazuli, which was developed by a Canadian company. Also a synthetic lapis lazuli made by P. Gilson, Pas de Calais, France. SG:2.36.

**synthetic lapis lazuli;** a misleading term for lapis lazuli imitation. → Lapis colored synthetic spinel, lapis lazuli imitation.

**synthetic lead germanate;** a yellow, transparent compound of  $Pb_5Ge_3O_{11}$ . It has similar properties to silicon.

**synthetic lead tungstate;** a transparent, tetragonal, yellow synthetic stone made of stolzite mineral with the formula:  $PbWO_4$ , a soft and highly disperse stone.

**synthetic lithium niobate;** → lithium niobate.

**synthetic lithium tantalate;** → lithium tantalate

**synthetic lithium titanate;** → lithium titanate.

**synthetic lithium zirconate;** → lithium zirconate.

**synthetic lithium-zirconium silicate;** → lithium-zirconium silicate.

**synthetic malachite;** synthetic malachite is made of aqueous solution in three kinds in banded, silky and bud-like structures.

**synthetic minerals;** same as synthetic.

**synthetic oolongolite;** → oolongolite.

**synthetic opal;** synthetic opal can produce uniform spheres of silica. A synthetic white or black opal manufactured by Pierre Gilson in Pas de Calais, France and in Switzerland. Made by dehydrating sodium silicate or a silicon ester or tetraethyl orthosilicate  $(C_2H_5O)_4Si$ . Which has a *lizard skin* shrinkage cracked effects. Using a microscope a chalky blue fluorescence can be seen. H:4½.

**synthetic opal;** some products similar to opal are made from various substances such as *latex plastic* the stone has low specific gravity and hardness, or some other plastics of styrene has RI:1.48 and SG:1.17.

**synthetic opal;** Kyocera opal made by Kyocera company, Kyoto, Japan that stone consists of amorphous silica but without water therefore it is not a synthetic but imitation opal. Imitations are made from vary materials such as plastics, doublets, triplets, glass, etc. Imitation opal was known in medieval times as ophthalmius. → Imitation opal.

**synthetic padparadschah sapphire;** a fancy trade term for synthetic orange sapphire made by Kyocera company, Kyoto, Japan. Marketed under the name inamori padparadschah.

**synthetic periclase;** a colorless, transparent periclase synthesized by Verneuil process by 3000° C, and marketed as a commercial term *lavernite*, used as a spinel imitation. RI:1.73. SG:3.55-3.60. H:5. Natural crystals are small and nor pure in color.

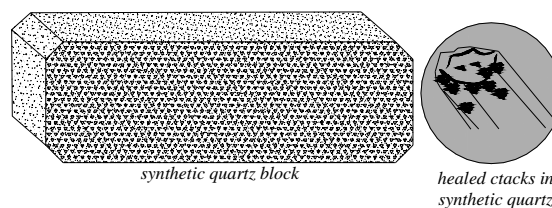
**synthetic phenakite;** colorless, light blue, transparent synthetic phenakite with the formula:  $Be_2SiO_4$ , doped with vanadium is made. Optics;  $\omega$ :1.654,  $\epsilon$ :1.670. Birefringence: 0.016.  $\oplus$ . Dispersion: 0.015. SG:2.95-2.97. H:7½-8. Physical properties are similar to the natural.

**synthetic powellite;** a pink, blue to colorless, transparent, tetragonal system. Synthetic powellite has been manufactured with formula:  $Ca(Mo,W)O_4$ . Optics;  $\omega$ :1.974,  $\epsilon$ :1.984. Birefringence: 0.011.  $\oplus$ . Dispersion: 0.058. SG:4.23-4.39. H:3½-4.

**synthetic proustite;** a transparent red colored synthetic proustite is manufactured with the formula:  $Ag_3AsS_3$ .

**synthetic quartz;** transparent, colorless synthetic quartz manufactured by both the hydrothermal and flux-melt processes, for this purpose used a quartz crystal as a seed supported by a silver wire. Colored synthetic quartz are doped, when trace of aluminum and after growing the crystal is irradiated with X-rays or gamma rays obtained smoky quartz, it take greenish-yellow, when subjected to heat. Yellow quartz or citrine is obtained, when trivalent iron ( $Fe^{+3}$ ) is added to the feed, this stone takes violet color or amethyst color by irradiation. Other doping agents are  $LiNO_3$  or  $LiO_2$  for yellow and 0.01 %  $Fe_2O_3$  for medium yellow. Green

quartz obtained by  $Fe^{+2}$ , when oxygen is not present. Blue synthetic quartz can be produced by adding divalent cobalt ( $Co^{+2}$ ). In jewelry citrine, amethyst, and



*synthetic quartz and cracks inclusion due to heat*

smoky variety of synthetic quartz are use. → Synthetic citrine, synthetic amethyst, synthetic smoky quartz.

**synthetic resin;** → resins,-synthetic.

**synthetic resins (plastics);** → resins,-synthetic.

**synthetic rock;** a man-made rock. → Synthetic.

**synthetic rose beryl;** a misleading term for synthetic rose spinel.

**synthetic ruby;** synthetic rubies or synthetic sapphires are similar in chemical, physical and optical properties to natural rubies or sapphires. → Synthetic corundum.

**synthetic rutile;** transparent synthetic rutile in various colors is produced by a modified Verneuil furnace by the flame-fusion method. The boules are opaque black but after reheating in a stream of oxygen they are turned to different colors. Synthetic blue rutile is strong electroconductive. It has been polished and faceted as various gemstones under different commercial names such as *titania*, *zaba gem*, *titanstone*, *Kenya gem*, *titangem*, *tirungem*, *titania brillante*, *diamothyst*, *miridis*, *sapphirized titania*, and many others and misnomered as rainbow diamond. The colors include pale yellow, yellow, blue, green, bluish-green, yellowish-green, etc. RI:2.616-2.903. Birefringence: 0.287.  $\oplus$ . Dispersion: 0.330. SG:4.26. H:6½-7, and high dispersion several times than diamond. Synthetic rutile with star effect obtained by adding of 0.5 % magnesium oxide, when cut cabochon. Cut as diamond imitations.

**synthetic sanmartinite;** → sanmartinite.

**synthetic sapphire;** also called synthetic blue corundum. → Synthetic corundum, synthetic ruby.

**synthetic scheelite;** transparent synthetic scheelite in various colors is produced. It has strong sky-blue fluorescence under SWUV. Used as a diamond imitation.

**synthetic silicon carbide;** → carborundum.

**synthetic smoky quartz;** → synthetic quartz.

**synthetic sodalite;** sodalite has been synthesized in China.

**synthetic spinel;** synthetic spinel is produced using flux-grown or flame-fusion method as synthetic corundum in a variety of fine colors. In chemical and physical properties nearly identical with true spinel. Widely used as gemstones and as imitation such as imitation of lapis lazuli and moonstone. Also used to imitate ruby, sapphire, diamond, aquamarine, tourmaline, alexandrite, zircon, etc. Imitation moonstone with schiller *schillerised synthetic spinel* can produce by heat treatment of colorless synthetic spinel stone. A colorless synthetic spinel used as a diamond imitation is incorrectly name as *Jourado diamond*. Red colored has RI:1.722-1.725, other colors than red RI:1.728 ± 0.003. SG:3.63-.67. Sintered lapis lazuli imitation has RI:1.725. SG:3.52. It can be distinguished by striae (or growth lines) in colored stones, by several inclusions that can be seen in natural stones, and gas bubbles in synthetic stones, refractive index, and specific gravity.

**synthetic spinel doublet;** → soudé spinel.

**synthetic star corundum;** → Linde synthetic star corundum.

**synthetic star rutile;** by adding of about 0.5% magnesium oxide to the ingredients and reheating the boule a star effect can be seen, when cut cabochon.

**synthetic star sapphire;** → synthetic star corundum, Linde synthetic star corundum.

**synthetic stones;** same as synthetic, reproduction.

**synthetic strontium titanate;** → strontium titanate.

**synthetic topaz;** a transparent, colorless and colored synthetic topaz is manufactured but not for jewelry purposes as a gemstone. Frequently in trade another synthetic stones are misnomered as synthetic topaz such as synthetic spinel or corundum.

**synthetic topaz;** sometimes similar natural stones are misnomered as synthetic topaz such as spinel, corundum, tourmaline, aquamarine, euclase, brazilianite, spodumene, apatite, scapolite, danburite, morganite, beryllonite, feldspar varieties, quartz and glasses. Specific gravity of topaz is more than those stones, which floats in di-iodomethane.

**synthetic topaz;** a misleading term for glass, which is used as imitation synthetic topaz or natural topaz, which has single refractive index.

**synthetic turquoise;** a synthetic turquoise that has been manufactured but mostly marketed stones are imitation turquoise made from copper phosphate and calcium carbonate, manufactured by P. Gilson, Pas de Calais, France. RI:1.592. SG:2.635. A few natural minerals resembling turquoise such as wardite, chrysocolla, lazulite, and variscite and fossiled tooth or bone (non mineral), which is known as odontolite or bone turquoise colored with vivianite are used as turquoise imitation. Also imitation turquoise is produced from

died calcedony, enameled glass, ceramics and plastics. Other imitations are Viennese turquoise, pressed compositions, Swiss lapis, German lapis, reconstructed turquoise, blue-dyed howlite, doublet turquoise and neolite. → Gilson-synthetic turquoise.

**synthetic wulfenite;** a lead molybdate, which has been made synthetically.

**synthetic yttrium aluminum garnet (YAG);** → synthetic garnet.

**synthetic yttrium compounds;** an isotropic compound of yttrium oxide (Y<sub>2</sub>O<sub>3</sub>) is known as *yttralex*, which is a ceramic of high dispersion. RI:1.92. SG:4.84. H:7½-8. Used as a diamond imitation and for optical devices. Other yttrium compounds have an isotropic crystal of composition of YAlO<sub>3</sub>. RI:1.938. SG:5.35. H: about 8. Rare earths are used as dopants. Used as a diamond imitation. A light green yttrium is made. Compound of Y<sub>3</sub>(Al,Ga)<sub>5</sub>O<sub>12</sub> with RI:1.88-1.90. SG:5.06. Strongly red fluorescence under LWUV light. Used as a grossular imitation.

**synthetic zincite;** a transparent synthetic zincite that has been manufactured colorless or in various colors. Formula (Zn,Mn)O<sub>2</sub>. Hexagonalic crystal. RI:2.00, SG:4.50. H:4-4½.

**synthetic zircon;** a transparent synthetic zircon has been grown hydrothermally, which is usually doped with vanadium to obtain a fine purple color. Used as a diamond imitation

**syntholite;** a commercial term for synthetic corundum.

**Syriam garnet;** an obsolete and misleading term for almandine garnet named after the capitol of the old kingdom of Pegu, Myanmar (formerly Burma). Also spelled Syrian garnet.

**Syrian garnet;** a misspelling of Syriam garnet.

**syrup of amber;** a mixture of succinic acid and opium was used in China as sedative, anodyne, etc.

**syrtitae;** a term used by Pliny for second variety of carbuncles.

**syssiderite;** → stony iron meteorite.

**system;** same as construction.

**system of crystals;** same as crystal systems.

**syssiderite;** same as lithosiderite.

**Sytikansk Pipe;** location of kimberlitic diamond pipes in Sakha (Yakutia), the Russian Federation, CIS. Also spelled Sitykansk.

**szaskaite;** a term used Hungary for smithsonite from Szaska.

**szechenyite;** a term used for a variety of jadeite, a mixture between jadeite, ureyite and eckermanite (an amphibole mineral).

**szmargd;** a Polish term used for emerald.

**s'zmulu;** a term used in orient for emerald from Island of Sumatra.

# T t

**Ta**; a chemical symbol for the element tantalum.

**taaffeite**; a very rare beryllium magnesium mineral. Rarely cut as gems, resembles a mauve colored spinel but can be distinguished by its birefringence. It was formerly called taprobanite.

System: hexagonalic.

Formula:  $2[Mg_3Al_8BeO_{16}]$ . Contains elements Fe, Mn, V, Cr, and Zn.

Luster: vitreous.

Colors: colorless, pale mauve, pinkish, purple, lilac, greenish, bluish-violet, bluish, reddish.

Streak: colorless.

Diaphaneity: transparent to translucent.

Cleavage: not determined.

Fracture: not reported.

SG: 3.60-3.613.

H: 8-8½.

Optics;  $\omega$ : 1.721-1.724,  $\epsilon$ : 1.717-1.720.

Birefringence: 0.004-0.007.  $\ominus$ .

Found in Hunan Province (China), Sri Lanka, Myanmar, eastern Siberia (Russia), and South Australia.

**taaffeite absorption spectrum**; similar to spinel.

**taaffeite inclusions**; in Sri Lankan stones: garnet, muscovite, apatite, phlogopite, zircon, spinel, healed fractures, fingerprints of negative crystals.

**taaffeite luminescence**; green luminescence in UV light and X-rays.

**taaffeite pleochroism**; it shows dichroism, bluish in daylight and reddish in artificial light.

**tabarget**; may it is an Arabic corrupt term of zeberjed which were used for emerald.

**tabarзад**; a Farsi, (Persian) term for cleavage.

**tabasheer**; an amorphous, translucent to opaque, white to bluish-white opal-like silica of organic origin found in the joints of certain species of bamboo. It resembles hydrophane a variety of opal and becomes transparent, when saturated with water. Used in the East Indies as a medicine and as native jewelry. Also spelled tabashir, tabaschir. Also called tabasheer opal → Opaline silica, opal.

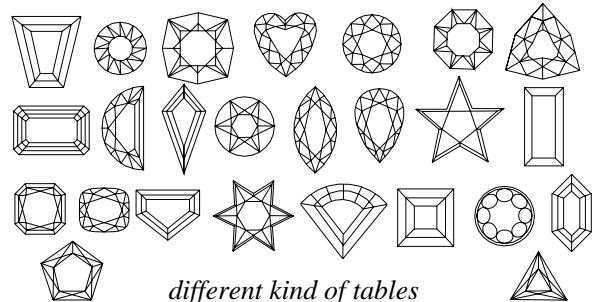
**tabasheer opal**; same as tabasheer.

**tabashir**; same as tabasheer.

**tabby extinction**; anomalous double refraction can be seen in some isotropic gemstones and typically in synthetic spinel, when rotating the stone between

crossed polariscope filters. The effect shows alternate light and dark stripes similar to marking on a tabby cat. It is caused by the presence of alumina in the synthetic spinel strains in the crystal lattice. This effect can be seen in some garnets. → Strain knot, cross-hatch effect.

**table**; a large flat facet in the center at the top of the crown of a transparent gemstone or diamond. The table

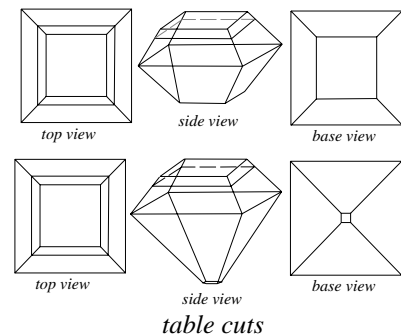


can be octagonal, square, oblong, etc. according to the proportion of cut stone. Table facets larger than normal are called *open table*. Also called table facet.

**table**; a round sheet of crown glass.

**table**; in alluvial mining deposits a box to used recover gold or other valuable ores from other materials.

**table cut**; probably an early symmetrical style of cutting diamond or other transparent gemstones, in which the



natural points of an octahedral crystal were removed to form a large square or oblong table on the crown and similar but very smaller parallel facet on the pavilion. The remaining parts of the 8 octahedral faces were polished, therefore it called *point stone*. This cut was in use by the ancient cutters of India until the rose cut was introduced in the middle of 17<sup>th</sup> century. *Portrait stone* is a variety of table cut.

**table cut**; a term applied to describe any variation of the bevel cut with a large table facet. Also sometimes called tablet cut diamond.

**table-cut diamond**; same as table cut.

**table cutter**; who cuts table or plane facets on gemstones or diamonds.

**table facet;** same as table.

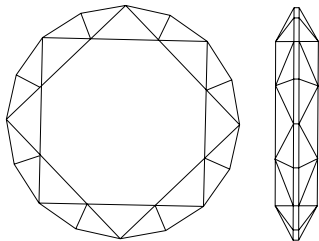
**table diameter;** the greatest distance between two opposing points of table of round gemstones or brilliant-cut diamond expressed in millimeter.

*table diameter of a brilliant-cut*

Diameter of an emerald cut is determined across narrowest direction. Also called table size. → Diamond diameter gauge.

**Table Diamond;** reportedly a large diamond of high quality owned by Francis I of France (1494-1547) in 1532. Present owner unknown.

**table diamond;** cut diamond with relatively flat table.



*table brilliant-cut wit 50 facets*

Same as table.

**table dop;** a dop, in which a diamond is placed for polishing its table.

**table down;** the position of a cut gem or diamond, which is resting on its table, or when its culet is facing up. This method is used for color grading of stones. → Face up, face down.

**table spectrometer;** same as goniometer.

**table spar;** same as wollastonite.

**table stone;** an ancient style of cutting diamond derived from an octahedron.

**table stone;** a flat fashioned stone for finger ring, may sometimes be engraved.

**table gauge;** an instrument for measuring table size in millimeters, it consists of a calibrated scale made from transparent acetate by the means of magnification.

**table measurement;** it means determining the dimension of table of a fashioned diamond or other gemstones in millimeters normally by means of table gauge.

**Table of Solomon;** a fabulous table said it was made of emerald, other gem and adorned by gold feet.

**table percentage;** the table diameter percentage of round brilliant or other cut to the average girdle diameter, achieved by dividing.

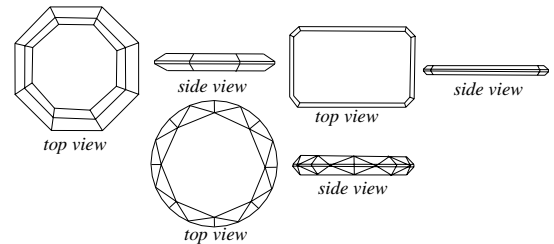
**table reflection;** an effect seen in round brilliant cut stones caused by reflection of the table facets, when observed perpendicularly from the crown to the pavilion. The viewed size of the table reflection

depends on the pavilion depth or angle. → Pavilion depth

**table size;** → table diameter, table percentage, table measurement.

**tablet;** a term sometimes used for a tabular crystal.

**tablet cut (diamond);** a modification of table cut, in which a row of narrow trap parallel facets are added on



*tablet cuts*

both the crown and pavilion.

**Tablet of Islam;** a black, emerald-cut diamond of 160.18 ct, of uncertain origin.

**Tablet Stone Diamond;** reportedly a pear-shaped diamond of 23 or 25 cts, was mounted in a gothic gold bracelet, later in the Russian Grand Imperial Crown. Now on display in the Russian Diamond Fund.

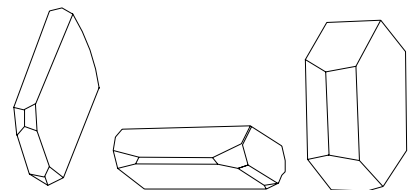
**Tabriz marble;** a transparent, fine variety of marble from Maragheh near Tabriz, Iran.

**tabular;** same as tabular crystal.

**tabular;** a slab-like shape of a sedimentary body, in which two dimensions are much longer than the third.

**tabular basalt;** basalt n tabular form mass.

**tabular crystal;** a crystal form having flattened table-like faces such as wollastonite, hematite, feldspar, etc.



*tabular crystals*

**tabular habit;** thick platy crystal formed parallel to one pair of faces.

**tabular spar;** same as wollastonite.

**tabular structure;** certain crystalline or igneous rocks tend to separate into plates or laminae.

**Tabula Smaragdina glass;** → *Tabula Smaragdina*, the.

**Tabula Smaragdina, the;** a fabulous emerald table or tablet made of a single huge emerald. Mentioned in the celebrated Egyptian priest and scientific writer Hermes or Hermon Trisemegetus (100 A.D.), known as Egyptian god Thoth or Toth, famous as the founder of chemistry. Also called Emerald Table. Some

authorities suggest that it was made from glass or green stone, because it is unbelievable at this time creating a huge table like that from emerald.

**tachylite**; a lustrous, semi-transparent to opaque, black-brown to black, glassy form of natural volcanic basalt. Conchoidal fracture. Usually cut cabochon in various dark colors. Also called sideromelane, basalt obsidian, basalt glass, jaspoid, wichtisite, hyalobasalt, and spelled tachylite, sordawallite, wichtisite.

**tachylite**; same as basalt glass.

**taconite**; same as rhyodacite.

**tactite**; a term used in USA for skarn.

**tadpole-shaped**; a style of inclusion, which occurs in curved lines of synthetic corundum in the form of nearly round bubbles.

**tagilite**; same as pseudomalachite.

**Tagore, Sourindro Mohun**; the famous Indian Author of the gem book *Mani-Mâlâ* in Sanskrit, Hindu, Bengali and English, 1879 and 1881. Suggested that he translated several unspecified sources and believed to be Purana.

**tagua**; → corozo nut.

**Tahiti pearl**; white, yellowish, gray to black pearls found in tropical waters of Tahiti, which are like other pearls from islands in the South Sea.

**Tahiti shell**; pearl oyster variety of Margaritifera from Tahiti Island, South Pacific. The nacre is green and black edged.

**Tai Hang Star Diamond**; a rough diamond of 120 cts, from Kimberley Mine, South Africa. It was cut into a 60 cts, stone. No additional information is available.

**tail**; a term used in Australian for poor-grade opal or thirds, which is a sorting grade coming after firsts and seconds.

**taille en seize**; a French term used for cut in sixteen. A modification of cutting diamond with 16 facets, plus a table and a culet.

**tailing**; rejected portion of rocks and ore minerals from a mining operation.

**tailing**; waste portion washed away in water concentration, which is thrown behind the tail.

**tailing**; the light particles of minerals or rocks that pass through a sieve.

**taira gai**; a Japanese term for Placenta placenta.

**Taiwan cat's-eye**; a translucent to opaque, greenish-yellow, yellow, deep green to black tremolite or actinolite with chatoyant effect from Taiwan. Optics;  $\alpha$ :1.56,  $\beta$ :1.613,  $\gamma$ :1.624. Birefringence: 0.024.  $\ominus$ . SG:3.05. H:6½-7. Used as gemstone.

**Taiwan ruanyu**; a Chinese term for green nephrite from Taiwan used as jade.

**Taj-e-Mah Diamond**; a colorless, irregular rose-cut diamond of 115.06 cts, said to be from Golconda, India.

It is considered to be a sister stone of the Darya-i-Nûr It was taken to Persia by Nadir Shah after the Sack of Dehli in 1739. Now on display at National Jewel Treasury of Iran, Tehran, open to the public. Taj-e-Mah means Crown of the Moon or Crest of the Moon Diamond.

**Taj Mahal Diamond**; same as Taylor Heart Diamond.

**takara pearl**; imitation pearl produced from the shell of a mussel.

**Takawaya**; an emerald mining center and name of a river in the Takawaya, Urals, Russia. Also occur there. Chrysoberyl (alexandrite), beryl, and phenakite. Also spelled Takovaya, Takowaya, and Tokowaya.

**take**; an ore or mineral bearing district that is all permitted to work.

**take a pillar**; a term used by Australian miners for pillar snatching in an opal mine. Dig out a column of earth to use as roof support to search stone.

**take up**; an informal term used by Australian miners for reopening of an abandoned shaft of opal.

**take up**; a term used to any device for taking up or removing the slack or particles.

**takin**; an Indian term for an engraved emerald.

**Takovaya**; another spelling for Takawaya.

**Takawaya alexandrite**; alexandrite found together with emerald and other mineral in Takawaya, Russia.

**Takowaya**; another spelling for Takawaya.

**talc**; a very soft mineral from the phyllosilicates groups. It feel greasy between the fingers. Used for carving objects, utensils, ceramics, and talcum powder. Steatite, soapstone are the massive varieties. iron-rich variety is known as minnesotaite. Usually associated with serpentine and chlorite schist.

System: monoclinic and triclinic.

Formula:  $4[\text{Mg}_3\text{Si}_4\text{O}_{10}(\text{OH})_2]$ .

Luster: greasy, pearly and dull.

Colors: shades of green, brownish, gray, grayish-green, white,

Streak: white.

Diaphaneity: translucent.

Cleavage: {001} perfect.

Fracture: none. Inelastic, sectile.

SG: 2.58-2.83.

H: 1 and harder due to impurities.

Optics; monoclinic talc has  $\alpha$ :1.539-1.550,  $\beta$ :1.589-1.594,  $\gamma$ :1.589-1.600. Triclinic talc has  $\alpha$ :1.545,  $\beta$ :1.584,  $\gamma$ :1.584.

Birefringence: triclinic: 0.039, monoclinic: 0.050.  $\ominus$ .

Found widespread.

**talc**; a rock consisting chiefly from talc, tremolite, chlorite, anthophyllite and related minerals such as steatite, potstone and soapstone.

**talc**; sometimes used for a thin layer of muscovite mica.

**talc as an inclusion in emerald**; in emerald from the Santa Terezinha Mine, Brazil talc, chromium spinel,

calcite-dolomite, and pyrite are included.

**talc luminescence;** pinkish under LWUV.

**talcite;** a massive variety of muscovite, which is named as damourite.

**talcite;** massive talc.

**talcoid;** a mineral that resembles talc.

**talcose;** soapstone or steatite that pertains to talc, or contains talc.

**talcum powder;** another term for powdered talc. Also called French chalk.

**Tali;** an Indian term for neck ornament.

**Talifu jadeite;** a famous jadeite market in Talifu of Tayhy-fu, Yunnan Province, China. It is not a mining source for jadeite.

**talisman;** a polysemous term used for an article that is supposed to possess occult powers to ward off evil or make lucky, worn as an amulet or charm, according to magical charms or astrological symbols. Talisman objects are certain gemstones, stones, rings, engraved stones with occult inscriptions, signs of astrological characters. Believed that talisman has more and wider positive power than amulet. → Abraxas, amulet.

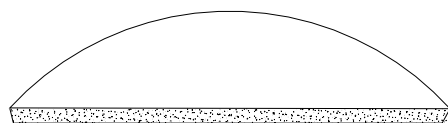
**Talisman of Charlemagne;** an assembled jewel consisting of two large cabochon-cut sapphires surrounded by many other gemstones. It was seen in the cathedral of Aachen, Germany. Also called Charlemagne's talisman

**Talisman Diamond;** a square, emerald-cut diamond of 24 cts, it was held by Brock and Company in Los Angeles, USA. Present whereabouts unknown.

**tallite;** same as epidote.

**tallow drop;** a gemstone cut cabochon with flat base or low-domed on both sides.

**tallow top;** a gemstone cut cabochon but with a shallow



*tallow top cabochon*

dome.

**tallow topped cabochon;** same as tallow top.

**talmi gold;** same as abyssinian gold.

**ta-lou;** in China a lead silicate containing little copper used by Chinese as an enamel color on porcelain.

**taltalite;** an obsolete term for emerald-green tourmaline containing copper from Brazil.

**taltalite;** another term for tourmaline.

**tama;** a Japanese term used for jade, same as gigaku.

**tama-ire-san;** a term used in Japan for who pushed

nucleus in oyster for producing cultured pearl.

**tambac;** same as tombac.

**tambikir quali;** a Malayan (Burmese) name for quartz with black encrustation.

**Tammaw jade;** another spelling of tawmaw jade.

**Tancheng;** location of alluvial diamond deposit in Shandong Province, China.

**tandem diamond dressing tool;** a diamond dressing tool that consists of more than one diamond set one below the other in the matrix.

**tang;** in diamond cutting a special device, in which the dop holding a diamond for polishing with a soft copper tail, is gripped in a moveable clamp. Often weighted on the arm of the tang to increase the pressure bearing on the scaife during the polishing. Frequently spelled tong.

**tangiwai;** same as tangiwaite.

**tangiwaite;** a dark-green variety of antigorite serpentine used by the Maoris of New Zealand to make ornament objects. It is similar to nephrite a variety of jade and bowenite. RI:1.52. SG:2.58. H:5½.

**Tanganyika;** same as Tanzania.

**Tanganyika rubies;** a misleading term for garnet from Tanzania. Garnets from Cape were sold as Cape ruby.

**tang in diamond cutting;** → tang.

**tangawaite;** same as tangiwaite.

**tangiwai;** same as tangiwaite.

**tangwaite;** same as tangiwaite.

**tania-59;** a commercial term for synthetic rutile. Used as a diamond imitations.

**tank;** a weight unit used in Sri Lanka (Ceylon) is equal to 21.84 cts. Also called chow, and chevvü.

**tantalite;** an isomorphous mineral with columbite and dimorphous with tapiolite. Faceted as gemstones and cut cabochon, prized by collectors.

System: orthorhombic.

Formula: 4[(Fe,Mn)Ta<sub>2</sub>O<sub>6</sub>].

Luster: vitreous to submetallic.

Colors: brownish-black, black, brownish-red, red.

Streak: brown to black.

Diaphaneity: translucent to opaque.

Cleavage: {100} distincts.

Fracture: uneven. Brittle.

SG: from 5.30 (columbite) to 8.20 (pure tantalite).

H: 6-6½.

Optics: α:2.260, β:2.235, γ:2.430.

Birefringence: 0.160. ⊕.

Found in Colorado, California, Dakota (USA), Sweden, Australia, Malagasy, Brazil, Finland, and Canada.

**tantalite;** a commercial term for lithium tantalate.

**tantalite of yttrium;** same as yttrium tantalite.

**tantalite pleochroism;** strong pleochroitic in brown to red-brown.

**tantalum**; a gray, lustrous, malleable, hard, brittle, heavy metallic element in the group V of the Periodic System with the symbol Ta. It is resistant to corrosion.

**Tanzania**; a country in eastern Africa, which was formerly known as Tanganyika. Locations of alluvial and kimberlite pipe diamonds. The first pipe was discovered by John T. Williamson and is named as Williamson Diamond Mine. Since 1992 the government and De Beers Company have entered into a joint exploration. Also a source for tanzanite, a variety of violet zoisite.

**Tanzania amber**; a transparent, pale champagne color amber from Tanzania, which is softer than Baltic amber. It is older than copal resin and younger than amber. Also called young amber.

**Tanzanian diamonds**; → Tanzania.

**Tanzania ruby**; hexagonal plates of rubies from Longido in Tanzania, which found enclosed within chromium-green zoisite. Stones are cracked because stress and shows polysynthetic twinning.

**Tanzania sapphire**; hexagonal tabular sapphires from Umba Valley in Tanzania of fancy color in the rainbow effect. Show basal polysynthetic twinning.

**tanzanite**; transparent blue to violet gem variety of zoisite, which exhibits strongly trichroic property in deep blue, deep red, and greenish yellow. Optics;  $\alpha$ :1.692,  $\beta$ :1.693,  $\gamma$ :1.700. Birefringence: 0.009.  $\oplus$ . Dispersion: 0.019. SG:3.38. H:6-7. Absorption spectrum in the yellow-green at 595 nm, in the green at 528 nm, in the blue at 455 nm. Most tanzanites are heated to reduce the pleochroism and obtain just blue and violet. Faceted as gemstone and cut cabochon. Found in Tanzania. → Midnight Blue.

**tanzanite**; a commercial term for cut stones of zoisite.

**tanzanite absorption spectrum**; → tanzanite.

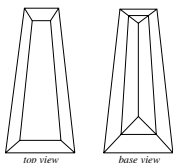
**tanzanite pleochroism**; → tanzanite.

**Taoist symbols**; objects of nature-centered religious symbols carved on materials by Chinese to the basic Tao philosophy.

**taoti**; a Chinese term for an animal mask made of jade. → Chinese ritual and symbol jades.

**t'ao t'ieh**; a Chinese term used for a monster design with two big round eyes carved on jade. → Chinese ritual and symbol jades.

**taper**; small obelisk like, fancy-shaped, step-cut diamond or other gemstone.



tapered baguette-cut

**tapered baguette**; an elongated keystone or modification of a standard baguette. → Keystone.

**tapered pentacut**; same as tapered pentagon.

**tapered pentagon**; same as epaulet cut. Also spelled tapered pentacut.

**tapers of necklaces**; a form of pearl necklace, in which a graduated and uniform decrease in size or diameter strings from end to end.

**taperzeta**; may an it is a corrupt term of zeberged, which were used in Middle Ages for emerald.

**tapillion cut**; a commercial term for a mixed cut of tapered baguette and brilliant cut, which is marketed by World Francies.

**tapiolite**; → tantalite.

**taprobanite**; another name for taaffeite.

**tap-ya-car**; an American Indian name for green stone, which were used by Muzo Indian in Colombia for emerald.

**tare**; the weight of a container, in which goods are weighed.

**tarkshya**; a Sanskrit term for emerald.

**tarmalah**; a Farsi term literarily means impure or despised may be derived from *damalah* for cabochon, turquoises furrowed by other stones, which are used as decoration. → Turquoise classification in Nishabur, Iran.

**tarnish**; a thin film of color that is formed on the exposed surface of a mineral or ore specially on metallic mineral, due to corrosion resulting from exposure to atmospheric actions such as copper bearing or silver bearing material.

**tarnish**; a thin external deposit of fine dust, which covers the mineral.

**tarshish**; a biblical term for the tenth stone in the breastplate of the High Priest, The word tarshish means golden stone. It is likely that it referred to chrysolite, topaz, citrine quartz, and also yellow jasper. Engraved with the name Naphtali. → Chrysolithos.

**Tarkwa**; location of diamond deposits in Western Ghana, Africa.

**Tasmania**; several locations of diamond deposits in Tasmania, south-east Australia.

**Tasmanian alexandrite**; alexandrite of gem quality from Tasmania, Australia.

**Tasmanian diamond**; a misleading term for colorless variety of topaz from Tasmania, Australia, used as a diamond imitation.

**Tasmanian diamond**; a misleading term for colorless variety of quartz from Tasmania, Australia, used as a diamond imitation.

**Tasmanian topaz**; topaz in pale blue or colorless from Tasmania, Australia. Used as a gemstone.

**Tasmanian zircon**; zircon in yellow-brown to deep red from Tasmania, Australia. Used as a gemstone.

**tassie**; same as tassie paste.

**tassie paste**; a series of glass pastes used in the



reproduction of engraved ancient famous gems in white and colored made by Scottish sculptor James Tassie (1735-1799) and later by his son William Tassie (1777-1860). It was an inferior glass quality for imitating diamonds with formula: silica 49%, lead monoxide 34%, potassium oxide 10%.

**taste**; one of the quality characteristic properties of certain minerals by tasting with the tongue such as common salt (salty), bitter salt (bitter), etc.

**tataya**; a Burmese (now Myanmar) term for topaz.

**tau cross**; a peculiar cross symbol used by ancient Egyptian as symbol for life, in the form of a “ T ” having expanded ends and foot.

**Tauridan**; another term for Tauridan topaz

**Tauridan topaz**; a very light blue topaz from Tauridan, Siberian, Russia. Also known as Siberian topaz.

**tausonite**; a mineral of perovskite group. Synthetic strontium titanate or so-called *fabulite* was made before the mineral was found in 1987, therefore it was named as synthetic strontium titanate or *fabulite* because it was believed that no counterpart exist in nature.

System: cubic.

Formula: SrTiO<sub>3</sub>.

Luster: adamantine.

Colors: red, ruby red, deep red, brown, brownish red, gray.

Streak: not reported.

Diaphaneity: transparent.

Cleavage: none.

Fracture: conchoidal. Brittle.

SG: 4.88.

H: 6-6½.

Found in Murunskii, Aldan, Russia.

**Tavernier**; Tavernier, Jean Baptiste (1605-1689) A French traveler, and merchant, who traveled 6 times to India and the Middle East. As memoir-writer he wrote his experiences in a book named *Les Six Voyages de Jean Baptiste Tavernier*, in which he described many famous gemstones and treasures at that times such as Great Mogul, etc.

**Tavernier A Diamond**; an oval-shaped Indian diamond of 51 cts, was acquired by Tavernier with other stones in India, brought back to France and sold to Louis XIV of France in 1669. It was among the stolen jewels from the French Royal Treasury in 1792.

**Tavernier B Diamond**; an uncut Indian diamond of 32 cts, was purchased by Tavernier among other stones in India, brought back to France and sold to Louis XIV of France in 1669. Present owner unknown.

**Tavernier Blue Diamond**; reportedly a blue, Mogul cut diamond of 112.50 old carat, it was purchased by Tavernier in India about 1642. He sold it to Louis XIV of France in 1669. Was said to be cut into a heart-shaped diamond of 67.50 cts. It was among the stolen

jewels from the French Royal Treasury in 1792. Also believed to have been recut into 45.52 cts, stone and renamed as Hope Diamond. Also called Blue Diamond of the Crown. → Blue Tavernier Diamond, French Blue Diamond.

**Tavernier C Diamond**; a brilliant cut diamond of 31 cts, was bought by Tavernier with other stones in India, brought back to France and sold it to Louis XIV of France in 1669. It was among the stolen jewels from the French Royal Treasury in 1792. Present owner unknown.

**Tavernier Pear Diamond**; reportedly a pear-shaped diamond of 54.75 cts, was seen by Tavernier in 1658 in India, probably was taken by Nadir Shah to Persian after Sack of Dehli in 1739. Present owner unknown.

**Tavernier rule**; a technique to calculate the value of gemstones. Price of gemstones increases by the square of weight in carats or grains. It is not satisfactory for very small or for very large diamond or other gemstone. Also called Indian rule.

**Tawma**; same as Tawmaw.

**Tawmaw**; fine-quality jadeite from Upper Myanmar, (Burma). Also spelled Tawma, Tammaw, Tawmaw jade.

**Tawmawite**; a yellow, green to deep green chromiferous variety of epidote with strong pleochroism from Tawmaw, Upper Myanmar. Also found in Zimbabwe, Africa.

**Tawmaw jade**; same as Tawmaw.

**taxoite**; a term applied to a green variety of serpentine from Chester County, Pennsylvania, USA.

**Tay pearl**; fresh-water pearls fished from the river Tay, Scotland.

**Taylor-Burton-Cartier Diamond**; a pear-shaped diamond of 69.42 carats. → Cartier-Taylor-Burton Diamond.

**Taylor Heart Diamond**; a flat, heart-shaped diamond of unknown weight from India. It is engraved with the name Queen Momtaz, the favorite wife of Mogul Emperor Shah Jahan (1592-1666), who built the Taj Mahal. It was bought by Richard Burton as a gift for his wife, Elizabeth Taylor on her 40<sup>th</sup> birthday in 1972. Now it is mounted in a heart-shaped pendant surrounded by small rubies and diamonds. Also called Taj Mahal Diamond. Present owner unknown.

**taylorite**; → bentonite.

**Taylor's Kopje**; location of diamond deposit in the Kimberley area, Cape Province, South Africa.

**Tb**; a chemical symbol for the element terbium.

**Tc**; a chemical symbol for the element technetium.

**Te**; a chemical symbol for the element tellurium

**tears**; same as drops. A term used for tear-shaped or small globular drop-shaped piece of amber.

**Tears of Heliade;** a fabulous tale in Greek, which mean tear-shaped ambers are the tears of Heliade.

**Tears of Juraté;** a popular legend by Lithuanians, which mean tear-shaped ambers are the tears of Juraté.

**teat;** a term used by Australian miners as informal name for Chinaman's hat. It means hut round at one end sloping to a point of solid cone shaped nobby.

**tecalco;** same as tecali.

**tecali;** a misleading term for a green variety of onyx marble from Tecali, Mexico, which is known as Mexican onyx and used as a jade imitation. Also spelled tecalo, tecati, and called tecali marble. Tecali is a corrupt term of the Aztec name *Teocal* for Mexican Indians temples.

**tecali, marble;** same as tecali.

**tecati;** same as tecali.

**Tecla emerald;** a misleading term for false triplet made from quartz or glass with a green central layer.

**Tecla pearls;** a misleading commercial term for imitation pearls made of solid glass or wax-filled.

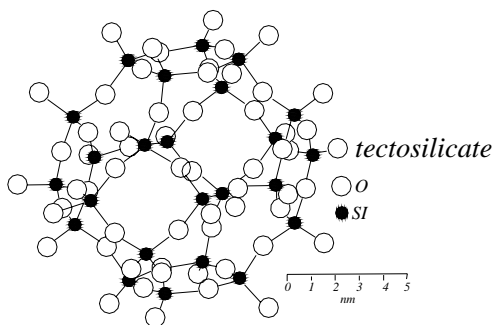
**technetium;** a radioactive element of the Periodic System with the symbol Te, which is the most stable isotope. It is not found in ores.

**technical carbonate;** a white, granular variable mixed substance composed approximately  $4\text{MgCO}_3 \cdot \text{Mg}(\text{OH})_2 \cdot 4\text{H}_2\text{O}$ , which is mixed with about 15% of asbestos fiber to produce a so-called 85% magnesia. Used in making molded form for heat insulation.

**tektite;** another term for tektite.

**tectonic;** pertaining to the forces responsible for structural change of the Earth's surface.

**tectosilicates;** a silicate structure characterized by three dimensional framework with the sharing of all four



oxygens of the  $\text{SiO}_4$  tetrahedra with surrounding oxygen of other four tetrahedra to form  $\text{Si}_2\text{O}$ , with a Si:O ratio of 1:2. An example is feldspar or quartz. → Inosilicates, sorosilicates, cyclosilicates, phyllosilicates, nesosilicates.

**tedding;** a term used in Australian for the searching through the dirt for opal.

**teeth, ivory;** a hard calcareous or organic horny body supported by the jaws in mammals used for fashioning

and carving and as source for ivory. See dentine.

**teeth, ivory;** → Dentelle.

**teeth on cut stone;** → dentelle.

**teflon;** a commercial term for a thermoplastic synthetic resin made by polymerization of polytetrafluoroethylene  $\text{CF}_2$ . An unsaturated gaseous fluorocarbon.

**tektite;** a general term for natural siliceous glasses like volcanic glass obsidian, which occurs as small, rounded, pitted particles of nonvolcanic origin and may be extra-terrestrial. Varieties are: moldavite, bediasite, australite (button-shaped), billitonite, javaite, Libyan desert, Darwin glass, etc. Used as faceted gems and cut cabochon usually from moldavite varieties. Cut stones are commercially misnomered as *water chrysolite*, *bottle stone*, *pseudochrysolite* or *bouteillenstein*. *Lechatelierite* a rock, which is the result of lightning or of the heat generated by the impact of meteorites, which is found in fulgurites. Also was named as obsidianite and spelled tectite.

System: amorphous.

Formula: a variable composition but mostly 68-82%  $\text{SiO}_2$  and very low water, contain oxides of Ca, Na, K, Mg, Fe, Al, Ti, Mn.

Unlike that of obsidian.

Luster: vitreous.

Colors: dark gray, jet-black, brown, green, olive-green, bottle-green, and colorless.

Streak: colorless.

Diaphaneity: translucent to opaque.

Cleavage: none.

Fracture: conchoidal to uneven. Brittle.

SG: 2.27-3.40, for moldavite, or 2.75-2.94 for Darwin glass. It varies.

H: 5-6½.

RI: 1.48-1.54. It varies.

Found in the Czech Republic, Australia, Libya, Java, Indochina, Philippine, Ivory Coast, and Texas, Georgia, and Massachusetts (USA).

**tektite absorption spectrum;** moldavite may exhibit to weak bands in the blue and orange.

**tektite cut;** stones are faceted in brilliant and step-cuts, or cut as cabochon and curiosities usually from javaite, billitonite, Libyan desert and moldavite.

**tektite inclusions;** torpedo-shaped bubbles, swirl striae.

**tektite luminescence;** yellowish-green under X-ray.

**television stone;** a term applied to cut ulexite. Where a ulexite is cut perpendicular to fibrous and polished, during it is putted on a text, the stone looks like a TV screen.

**tellurium;** a silvery-white, brittle, metallic luster, semi-metallic element in the group VI of the Periodic System with the symbol Te. Used in alloys, ceramics, and in the glass industry. Poisonous compounds.

**temperature color;** different colors noticeable to the eye by incandescent substances, which occur at different temperatures.

**temperature radiation;** → incandescence.

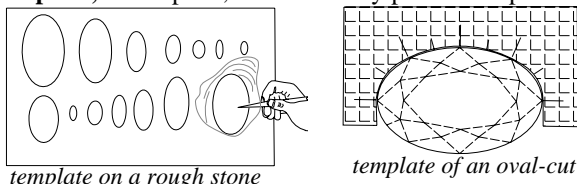
**temperature scale;** same as absolute temperature.

**tempered glass;** glass mass, which has been rapidly cooled to induce residual compressive stress in the surface of them.

**tempering;** to increase or alter the hardness and strength of a metal by controlled heat treatment and cooling.

**tempest;** a term used to banishment of dangerous or avoidance by use of green stone amulet or beryl amulet.

**template;** a thin plate, cut with many patterns or profiles



and sizes, which are required for outlining the shapes of cabochons on the piece of slabbed chosen stone materials. Frequently called templet.

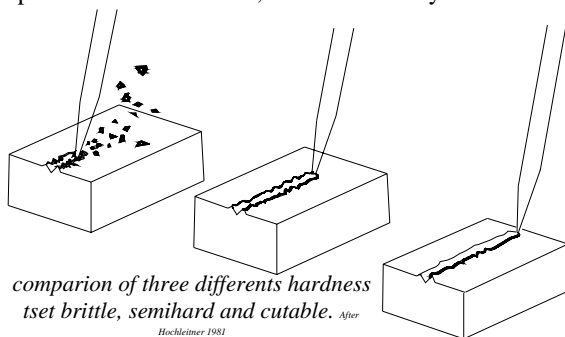
**templet;** an old alternate term for the first 4 lozenge-shaped bezel facets on the crown of a brilliant, which are polished after the table facet. The other 4 lozenge-shaped similar facets with the name quoins are considered together as eight templets. Now all lozenge-shaped facets are named as kite facets or main facets. Also called templet facets.

**templet;** → template.

**templet facets;** same as templet.

**complementary color;** → selective transmission.

**tenacity;** the property or force, with which the particles of a minerals or material hold together or resist separation. Soft minerals, which are easily flattened are



named as malleable such as gold, copper, etc. Or a mineral is brittle, which crumbles easily such as fluorite, pyrite, etc. Those minerals, which can be bent but return to their original shape are known as flexible. Also called toughness.

**ten celestial stems;** → Chinese ritual and symbol jades.

**tenebrescence;** reversible darkening and bleaching of a crystal color under influence of radiation (usually X-rays or cathode rays) owing to absorption of light such as hackmanite which is a transparent variety of sodalite with pink color on fresh fracture, this effect can be seen in some kunzite a variety of spodumene. The color bleached, when mineral is exposure to strong sunlight and darkened, when kept in darkness for a few weeks or exposure to X-rays or cathode rays. Bleaching may be obtained by heat or by photons of certain wavelength. Yellowish-brown spodumene altered to purple after heat treatment. → Transichromatic.

**Tennant Diamond;** a large yellow diamond of 112 cts, in rough owned by James Tennant a London mineralogist in 1873. It was cut into a flawless brilliant of 68 cts. Present owner unknown.

**tension;** stress, which tends to pull a mineral or stone apart.

**tension crack;** an irregular fracture patterns around an inclusion caused by tensile stress. Also called tension fracture.

**tension fracture;** same as tension crack.

**teocal;** → tecali.

**teotetl;** same as iztli.

**teoxihuitl;** a term used by native Indians of Mexico for small fine turquoise piece which meaning divine turquoise.

**tephrite;** a deep-colored volcanic rock, usually porphyritic. → Basanite.

**tephroite;** a nesosilicate mineral of the olivine group. Blue, green, reddish, and brown pleochroism. Cut as cabochon and faceted gems.

System: orthorhombic.

Formula:  $4[\text{Mn}_2\text{SiO}_4]$ .

Luster: vitreous to greasy.

Colors: reddish brown, olive green, bluish green, gray, flesh red.

Streak: light gray.

Diaphaneity: transparent to translucent.

Cleavage: {010} distinct, and {010} imperfect.

Fracture: conchoidal to uneven. Brittle.

SG: 3.90-4.11.

H: 6.

Optics:  $\alpha$ :1.770-1.788,  $\beta$ :1.807-1.810,  $\gamma$ :1.817-1.825.

Birefringence: 0.037-0.047.  $\ominus$ .

Found in Japan, Australia, Sweden, England, France, and California, Colorado, and New Jersey, USA.

**tephroite absorption spectrum;** may Mn lines be observed.

**tephroite pleochroism;** brownish-red, reddish and green-blue.

**terbium;** a silvery gray, metallic luster of rare-earth element or lanthanide serie of the Periodic System with the symbol Tb. It resembles yttrium.

**Tereschenko Diamond;** a fancy blue, pear shaped diamond of 42.92 cts, of Type IIb, probably from India. It was purchase by the Tereschenko family of Russia. Was sold in 1916. In 1984 sold to a Saudi Arabian merchant.

**term diagram;** a term used in crystallography for a diagram which explain energy level and transition diagram for isolated atom in which levels are usually represented by color, fluorescence and absorption such as in ruby.

**Termier;** a pale-red elbaite tourmaline of 20x13 cm from Malagasy. Found 1908. Present whereabouts unknown.

**Termier;** a pale-red elbaite tourmaline of 38x9 cm from Malagasy. Found 1983? Present whereabouts unknown.

**terminal bead;** a bead, which is attached to the end of a multiple necklace or chain.

**terminal state level;** → inverted population level.

**terminal summit;** such as summit of a pyramid.

**terminated;** external grown form of a crystal.

**termination;** crystal faces at the end of a natural crystal such as end of a prism as distinguished from polished or broken end.

**terminology;** the system of terms belonging to a science, art, commercial, or industry.

**ternary feldspar;** any feldspar containing more than 5% of the three principal feldspar components such as anorthoclase, natron-sanidine, potassium oligoclase or potassium andesine.

**terpenes;** an unsaturated liquid of hydrocarbons of the formula  $(C_5H_8)_n$ , found in oil, plants, resins and balsams used in industries to produces synthetic organic items.

**terpenoid;** → isoprene units

**terra adamica;** a kind of common red clay. Also called Adamic earth, Adam's earth.

**terra alba;** a kind of white, compact, fine-grained gypsum as contrast to the shaded alabaster.

**terrace;** a nearly flat level of a landscape usually narrow in comparison with its length, which is on one side terminated by a steep edge.

**terraced inclusions in corundum;** a term used to step-like appearance of twinning striations of corundums found in corundum crystals may be seen as tabular or rounded inclusions, which is developed of the basal pinacoid. Also called growth steps, stepped inclusions in corundum.

**terrace mining;** an alluvial deposit of diamonds or other minerals formed on a nearly flat level of raised river or river bank, or marine platform and beaches. Also called bench placer. → Bench terrace.

**terra cotta;** generally unglazed, lightweight, burned clay widely used for ornamental work such as tile, sculpture, pottery, and architecturally work. Composed

of fine clay, fine sand and crushed pottery waste, etc. typically red in color.

**terrain;** an area or region where a rock or a group of rocks predominates.

**terra rossa;** a residual reddish-brown clay-like soil covered in iron-oxide-rich material or limestone bedrock in subcontinental climates.

**terra verde;** same as green earth.

**terra verde;** another spelling for terra verte.

**terrestrial;** pertaining to the land as distinct from the water or air.

**terrestrial deposit;** alluvial deposits laid down on land as distinct from marine deposit, which not resulted from water action.

**terre verte;** a French term for any various naturally occurring of green sedimentary earth, especially silicates of iron such as glauconite and celadonite. Used chiefly as bases pigments for green dyes. Also called terra verde (Italian), green earth, Verona earth.

**Tertiary;** the first period of the Cenozoic era, which spans approximately between 65 to 62 million years with a rock system on the Earth's surface. In Tertiary period the strata ranges from the Eocene to Pliocene. Tertiary follows the Mesozoic. → Precambrian, Paleozoic, and Cenozoic.

**Tertiary level;** a term used in Australian exposure of a mine, which is mixed of ironstone, quartz, agate, gravel, etc.

**tessellated mosaic;** a pattern arranged from cubes or shapeless of small pieces of stone like a checkerboard made of marble, agate, etc. resembling a mosaic.

**tessellation;** a geomorphic plane surface divided into cubes or shapeless pattern formed of small pieces of stones.

**tesseral system;** same as cubic or isometric system. Also called monometric system.

**testing;** same as prescreening method, irradiation.

**test stone** fine grained black jasper or basanite rock used for testing of precious metals.

**tetrabromoethane liquid;** same as acetylene tetrabromide, heavy liquid.

**tetracoral;** a term used for coral with four-folded symmetry.

**tetrad axis;** sometimes used for tetragonal axis.

**tetragonal;** belonging to tetragonal system.

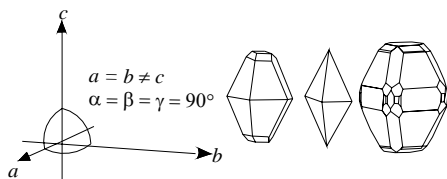
**tetragonal crystal;** a crystal of tetragonal system.

**tetragonal mineral;** a mineral of tetragonal system.

**tetragonal stone;** a stone of tetragonal system.

**tetragonal system;** one of the seven crystal systems, in which having two axes of equal length perpendicular to each other, the third axis of a different length is at right angles to the plane of the other two. The third axis is known as principal (*c*) axis and is either longer or

shorter than the other two with 4-fold rotation axis.



### tetragonal system

Also called dimetric system, quadratic system, pyramidal system.

**tetrahedral**; a geometrical crystal with the smallest number of faces having the symmetry or form of a tetrahedron of the cubic system.

**tetrahedral cobalt**; → isoelectronic.

**tetrahedral crystal**; a crystal having a tetrahedral form.

**tetrahedral, pyrophyllite**; → pyrophyllite tetrahedron.

**tetrahedron**; an equilateral triangles, 4-faced polygon body belonging to cubic system, which has the smallest number of faces. Adjective: tetrahedral.

**tetrahexahedron**; a polygon of cubic system in the highest symmetry consisting of 24 equal triangular faces. Also called tetrakis hexahedral crystal.



**tetraiodoethylene**; a light-yellow crystal of  $I_2C=CI_2$ , insoluble in water. Used with sulfur solved in methylene-iodide as a contact liquid with high refraction RI:1.81 in refractometer. It turns brown color on exposure to light. Also called iodoethylene, diiodoform. → Anderson and Payne liquid.

**tetrakis hexahedral crystal**; same as tetrahexahedron.

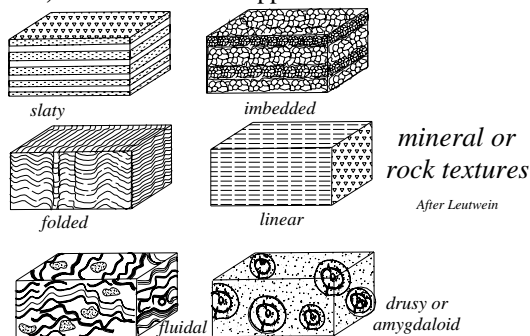
**tetrakis hexahedron**; same as tetrahexahedron.

**tetrazo**; a compound contain four azo group.

**Texas agate**; a banded jasper agate found as gem gravel in the Pecos River, Texas, USA.

**Texcoco Emerald**; → Cortez Emerald, Tezcoco.

**texture**; the characteristic appearance and mode of rock,



including the size, shape, and arrangement of particles in rock and relationships between the grains of minerals

forming a rock such as glassy texture, granular texture, fine textured, etc. The classification and name of rocks given by mineral composition and texture.

**texture clouds**; exsolved silk and minute particles inclusions in Sri Lankan sapphire in brownish yellow color of oily golden to milky appearance in transmitted light. In Sri Lanka is termed as *diesel* because it resembles the diesel oil.

**Tezcoco**; a palace and treasure of the Mexican Indian a principal hall of theirs was named as *tribunal of god*, in which a throne of pure gold set with turquoises and other jewels. Also spelled Texcoco. → Cortez Emerald.

**Th**; a chemical symbol for the element thorium.

**thai**; a Burmese term used for very minute corundum stones similar to sand. → Corundum classification in Myanmar.

**Thailand**; the new name of Siam.

**Thailand diamond**; diamond frequently found on Phuket Island and at Phangnga, Thailand.

**Thailand gemstones**; there are source of Siam aquamarine, Thailand diamond, Siam ruby, Siam sapphire, and Siam zircon.

**thalasus marinus**; a German term were used for aquamarine.

**thallite**; same as delphinite a yellowish green variety of epidote.

**thallium**; a bluish-white, lead-like, malleable, metallic element in the group III of the Periodic System with the symbol Tl. It forms a toxic composition, when it comes in contact with moisture. Used in alloys, glass industry and heavy liquid such as Clerici's solution.

**thallium glass**; a variety of flint glass, which contains thallium of high refractive index and specific gravity up to 5.40. Used as imitation gemstones.

**thallium malonite**; a heavy liquid of  $CH_2(COOTl)_2$  made of a mixture of thallium formate and organic thallium compound of specific gravity of 4.25. Soluble in water. Strongly toxic.

**thaumasite**; a fibrous mineral of zeolite group. Cut cabochon frequently with relatively weak cat's-eye effect or beads, prize by collectors.

System: hexagonalic.

Formula:  $2[Ca_3(CO_3)(SO_4)Si(OH)_6 \cdot 12H_2O]$ .

Luster: vitreous to nearly silky or greasy.

Colors: colorless, white, pale yellow.

Streak: colorless.

Diaphaneity: transparent to translucent.

Cleavage: {1011} in trace.

Fracture: Brittle.

SG: 1.92.

H:  $3\frac{1}{2}$ .

Optics;  $\omega$ : 1.500-1.507,  $\epsilon$ : 1.464-1.468.

Birefringence: 0.030-0.038.  $\ominus$ .

Found in California, Utah, Arizona, New Jersey, and Virginia (USA), Sweden, Norway, and Hungary.

**thaumasite pleochroism;** white glow under SWUV with phosphorescence.

**The Arc Diamond;** a diamond of 381 cts, found in 1921 in South Africa. No additional information is available.

**the-bauk;** a Burmese term used for corundum stones of average 0.75 cts. Also called haibauk. → Corundum classification in Myanmar.

**Thénard's blue;** same as cobalt blue.

**Theophrastus;** Greek peripatetic philosopher (ca. 372-287 B.C.), who wrote the book *Peri Lithon* book of stones. He was a disciple of Aristotle.

**theory of light;** the theory that electromagnetic light is a wave motion may explain all the observed phenomenon as emission, interference, diffraction and absorption of light. Suggesting that the vibrations of light caused by periodic changes in the electrical and magnetic condition of the ether. Another theory, the quantum theory says that light energy emitted or absorbed in small *packets*, which are called photons or quanta. Both theories are in use, although the two have not been completely unified. Optical instruments used in gemology are mainly concerned with the nature of wave theory of light. Also called electromagnetic theory of light.

**the horn of the unicorn;** → narwhal ivory.

**the Pearl King;** → Pearl King, the.

**the Pearl of Asia;** a baroque-shaped pearl of 2.420 grains. → Pearl of Asia.

**Theresa Diamond;** a diamond of 21.25 cts, found in 1886 at Kohlsville, Wisconsin, USA. It was cut in 1918 into two stones a 9.27 cts, and a 1.48 cts, stones. Also called Kohlsville Diamond. Present owner unknown.

**the Ridge;** an informal term used by Australian miners for Lightning Ridge, a famous field of rich opals.

**thermal conductivity;** characteristic ability of a substance to transfer thermal energy in the presence of a temperature grade. The value of thermal conductivity (*K*) of rocks is measured in watts per meter per °C in SI unit. For example rocks with abundant quartz have a high conductivity. Diamond Type I have twice as much and Type IIa six times the thermal conductivity than copper. *K* of glass: 1, *K* of ZrO<sub>2</sub>: 10, *K* for corundum: 40, *K* for gold: 320, *K* for silver: 320, *K* for diamond Type I: 1000. Therefore the thermal conductivity of diamond is the highest of any material other than for copper or silver and it feel cool to the touch. Glass feels warm to the touch, while it has no thermal conductivity. Most minerals with high electrical conductivity tend to have high thermal conductivity. Also called heat conductivity, thermic conductivity.

**thermal conductivity diamond tester;** a device for

testing thermal conductivity of diamond. Used to distinguish true diamonds from imitations and other natural stones. Ceres Diamond Probe is one of these instruments.

**thermal conductance;** a quantity given by heat transfer through a stone or material. → Thermal conductivity.

**thermal conductance meter or probes;** same as thermal conductivity diamond tester.

**thermal glass;** an ordinary lime soda glass, in which boron oxide replaces the calcium oxide and has low coefficient of expansion.

**thermal inertia of diamond;** the thermal conductivity of diamond is the highest of any material other than for copper or silver and it feel cool to the touch. Thus thermal inertia condition is used for electronic test of diamond to separate it from its simultants.

**thermal metamorphism;** a type of metamorphism, in which heat is the principal agent in contact with an igneous body. Also called contact metamorphism.

**thermal reaction tester;** → hot-point tester, GIA thermal reaction tester.

**thermal stress;** stress in a gem caused by rapidly cooling or by a local temperature, which is gradient within the stone.

**thermistor;** a temperature-sensitive semiconductor instrument made of ceramic with a negative temperature coefficient, whose resistance decreases as temperature increases used as a device for measuring thermal conductivity of diamonds.

**thermistor;** an abbreviation for **thermally sensitive resistor**.

**thermit;** another spelling for thermite.

**thermite;** a mixture of aluminum or magnesium powder and barium peroxide or other metal oxide (1:1). When ignited by magnesium ribbon it produces very high temperature about 2200° C. Soapstone mixed with thermite is used for production of synthetic diamond. This take place: in the hollow center will placed a hollow ½ sphere of saponite mixture, in this hollow is a another hollow ½ sphere of tantalum, and in the last hollow ½ sphere center placed the reagent composed of graphite and iron carbide. Also spelled thermit.

**thermochroism;** the science of high temperature of one subject to change its color, because by increasing of temperature expands the bond length of lattice, reduced the ligand field. A red compound of 10% Cr<sub>2</sub>O<sub>3</sub> and 90% Al<sub>2</sub>O<sub>3</sub> by increasing the temperature to over 400°C the color turn to gray and a little about 400°C to green. Thermochroism seen in both reversible and irreversible. Thermochroism seen in organic compositions combined with color change when the ligand field is in transfer with metal ion and when temperature change. The color change is reversible in solution such as

yellow anil dye to red anil dye by heat, but in the solid, the change may remain permanent on cooling. Also spelled thermochromism. → Photochromism.

**thermochroism in organic compounds;** → thermochroism.

**thermochromism;** → thermochroism.

**thermoluminescence;** a variety of luminescence where certain rocks or minerals showing the property due to application of heat or infrared. Some diamonds exhibits blue thermoluminescence, when heated to about 200° C. Thermoluminescence emitted when the color traps are disappeared by heat. This method used in the dating of stones, rocks, pottery, etc, in archeological determination. → Calorescence, cathodoluminescence.

**thermophosphorescence;** a phenomenon where luminous glow persists and continues even through the source of the energy or heat is removed. → Luminescence, fluorescence.

**thermosetting plastics;** same as thermoplastic.

**thermoplastic resins;** a term usually applied to any group of high polymer, which becomes temporarily softened, when heated and can be molded into a shape. After cooling the shape retains such as cellulose derivatives, acrylic resins, polyamides, vinyl resin, etc.

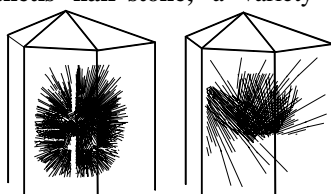
**thermosetting resins;** a term describing any group of high polymer that is molded under heat and pressure by chemical reaction into a permanent shape, which is irreversible, such as phenol formaldehyde, aniline formaldehyde, etc. Also called thermosetting plastics.

**thermuticle;** → porcellanite.

**Theron's Mine;** location of a minute diamond pipe in the Kimberley area, Cape province, South Africa.

**thetis's hair-stone;** same as thetis hair-stone.

**thetis hair-stone;** a variety of colorless crystalline quartz (hairstone) containing tangled balls and thread-like inclusions of green fibrous asbestos or hornblende. Also



*Thetis-Hair or Venus Hair,  
rutile needles in quartz*

spelled Thetis's hair-stone. → Quartz inclusions, rutiled quartz.

**thickness;** a term applied to the vertical distance of a brilliant cut diamond or other cut gemstone from the table to culet.

**thickness of pearl layers;** a term applied to the secretion of nacre from the cells around the pearl sac which produced 3-4 layers per days but depend on season and temperature in average 1000 layers in a year approximately 0.5 microns.

**thick crown;** in a brilliant-cut diamond or other

gemstone the height of crown is greater than 16.2% (standard) of the average girdle diameter. → Overspread stone, spread stone.

**thick girdle;** in a brilliant-cut diamond or other gemstone the thickness of the girdle is greater than the typically medium girdle, which can be seen easily with the naked eye. This cut is made in order to retain more weight.

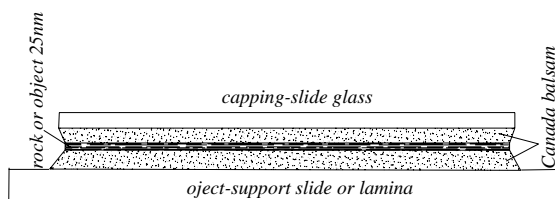
**thick stone;** → lumpy diamond.

**thin crown;** in a brilliant-cut diamond or other gemstone the height of the crown is less than 16.2% (standard) of the average girdle diameter. → Overspread stone, spread stone.

**thin film diamond coating;** sputtering a thin film of diamond by chemical vapor onto a surface of a gemstone to improve its resistance or increase its thermal conductivity.

**thin polished section;** a thin section of rock or mineral which is highly polished. Thin sections are used for study of opaque and minute minerals in rock by plane or polarized reflected light. Also called polished thin section, microsection.

**thin section;** a thin slice of a transparent or translucent rock or mineral mechanically ground down to a thickness of nearly 0.03 mm on an abrasive plate or



*thin section, side view*

paper, polished and glued between two glasses with resin of a certain refractive index of usually 1.54. This is prepared for examination under a polarizing microscope by means of transmitted light.

**thin stone;** an old term for cut stones with thin table according to the dimension of rough material.

**thioindigo;** a natural with small hypsochromatic blue dye of indigo family with formula  $C_{16}H_8S_2O_2$ , where having -S- atoms replacing two imino -NH- groups in composition. Also used as dyes. → Indigo, hypsochrome.

**thiorsaite;** an obsolete term from anorthite from Iceland.

**third;** it means a  $\frac{1}{3}$  of a carat.

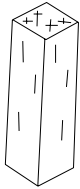
**thirds;** a term used by Australian miners for poor grade opal or tail, which is a sorting grade coming after firsts and seconds.

**thiruvana;** a term used by Singhalese for a whitish rocky gravel, which is an indicator for gem-bearing alluvial.

**Thoh;** same as Thoth.

**tholoid;** same as volcanic dome.

**thomsonite;** a mineral of zeolite group with circular bands like agate. Due to the radial arranged of fibers also named as *eyestone* or *eyed thomsonite*. Cut as



*thomsonite crystal*

cabochons, gems and rarely faceted. Prized by collectors as curio stone. It accepts a good polish. Brown and white luminescence

under LWUV light. *Lintonite* is a translucent olive-green variety, which resembles jadeite. A snow white massive variety of thomsonite is called ozarkite.

System: orthorhombic.

Formula:  $4[\text{NaCa}_2(\text{Al}_5\text{Si}_5\text{O}_{20})\cdot 6\text{H}_2\text{O}]$ .

Luster: vitreous to pearly, porcelaneous.

Colors: colorless, white, pale yellowish, grayish, greenish, pale pink, salmon, red.

Streak: colorless.

Diaphaneity: transparent to translucent.

Cleavage: {010} perfect, and {100} distincts.

Fracture: subconchoidal to uneven. Brittle. Pyroelectric.

SG: 2.30-2.40.

H: 5-5½.

Optics;  $\alpha$ :1.529,  $\beta$ :1.531,  $\gamma$ :1.542.

Birefringence: 0.014-0.021. ⊕.

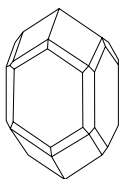
Found in Scotland, Italy, India, Canada, Ireland, Greenland, New Jersey, Colorado, Arkansas, California, and Oregon, USA.

**thomsonite cut;** it is a soft mineral and accepts a good polish, cut as cabochons, gems and rarely faceted. Frequently shows chatoyancy, when cut cabochon.

**thomsonite luminescence;** brown and white luminescence under LWUV light.

**thool;** a commercial term used in Sri Lanka for seed pearls. Also spelled tul.

**thorite;** a mineral with composition of  $(\text{Th,U})\text{SiO}_4$  is included in some zircon crystals, which emits alpha particles and wholly breaks down the structure of the stone in amorphous state, which is known as metamict zircon. SG:6.70-4.10. H:4½.



*thorite crystal*

**thorium;** a dark silvery-white, soft, radioactive metallic element in the group III of the Periodic System with the symbol Th.

**thortveitite;** a very rare scandium mineral  $2[(\text{Sc,Y})_2$

$\text{Si}_2\text{O}_7]$ . Monoclinic crystal. Transparent to translucent. Diamond to vitreous luster. Color: grayish green to black. Streak: pale grayish green. Cleavage {100} distinct and {001} parting. Fracture: fine conchoidal to uneven. Brittle. Optics;  $\alpha$ :1.750-1.756,  $\beta$ :1.789-1.793,  $\gamma$ :1.800-1.809. SG: 3.50-3.60. H:6.5. Radiated to rosette aggregate. Found in Norway, Russia, Malagasy, Japan. Prized by collector and frequently cut as gem.

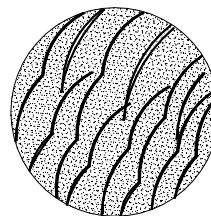
**Thorvaldsen Museum;** a historical museum in Copenhagen, Denmark, where are several gems and jewels of Greek and Roman times.

**Thoth;** an Egyptian god, famous as the founder of chemistry. Also spelled Toth. → Tabula Smaragdina, the.

**Thoulet solution;** also called Sonstadt's solution.

**thread-grinder diamond dressing tool;** a diamond dressing instrument for a rough or a lapped single diamond, which is used to dress thread grinder wheels.

**thread-like;** a tuft or bundle of long, tough, asbestos-like, capillary, hair-like or silky filaments. These thread-like cavities are formed when tubes are filled



*threadlike or trichite inclusions in green tourmaline*

with liquid and bubbles of gas. The thread-like cavities, which are formed when tubes are filled with liquid and bubbles of gas.

The tubes usually run parallel to the *c*-axis, which causes a cat's-eye effect, when cut cabochon. Occasionally fractures and flat films reflect light from these tubes, which then appears as black patches. Also called trichites.

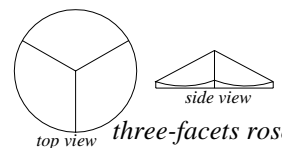
**thread-like liquid crystal;** same as nematic liquid crystal. → Liquid crystal.

**thread setting;** a modified of a setting a stone in a finger ring where the edge of the bezel is held in the collet by a thin thread of metal.

**three-facet cut;** same as three-facet rose cut.

**three-faceted pebble;** the term applies to a three faceted stone formed by natural agents, such as by wave erosion, the grinding action of a glacial region or wind action in the dessert. Same as windkanter. → Faceted boulder, dreikanter, einkanter.

**three-facet rose cut;** a simple style of rose cut with a circular girdle outline, dome-shaped three large facets, and unfaceted base.



**three-fold brilliant;** same as ideal brilliant.

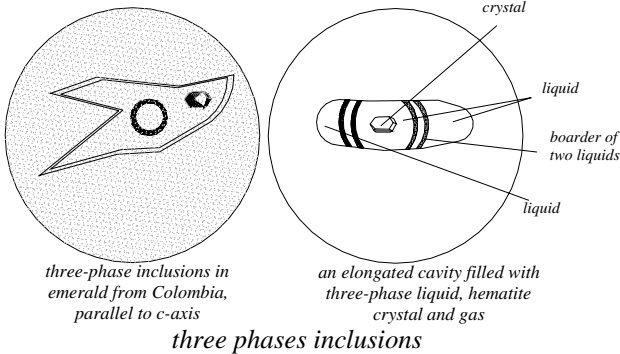
**three-layer structure;** structure of some minerals are



composed of repeated layered units such as mica group in which an aluminum octahedral layer between two silicon tetrahedral layers.

**threeeling**; another spelling of trilling.

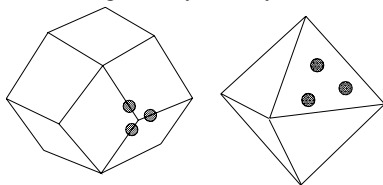
**three-phase inclusions**; irregular or long stretched



*three phases inclusions*

cavities filled with a moveable liquid, a bubble and a solid crystal or mineral. → Inclusions.

**three-point**; a brilliant cutting orientation for diamond whose table is parallel to the an octahedral direction a face of trigonal symmetry. This direction can not be



*situation of three point on octahedron and dodecahedron diamond crystals*

sawn but can be cleaved, the polishing process of such surfaces is very slow.

Also called three-point

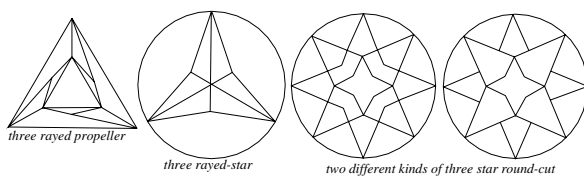
diamond. → Four-point diamond, two-point diamond.

**three-point diamond**; same as three-point.

**three rayed propeller**; a modified faceted triangular cut with 9-triangular facets in zigzag form like a propeller and a 3-sided large table.

**three rayed star round**; two modified faceted triangular round cuts with 9-triangular facets without table.

**three rayed star**; a modified faceted triangular round



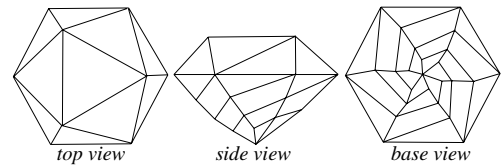
*three rayed-stars*

cut with 20 facets with a 4-rayed star table. Other cut has 16 facets with a 4-rayed star table.

**three-ridge mussel**; same as blue-point mussel.

**three six-twist-cut**; a modified faceted zigzag triangular

cut with 9-triangular facets and a 3-sided table. Pavilion



*three-six-twist-cut. After Steele*

has 24-triangular zigzag facets without culet.

**three square**; a commercial term for triangular file.

**Three Tables**; reportedly 3 table-cut diamonds weighing 48 to 52 old cts, according to Tavernier seen in 1665 in India. Believed to have been taken to Persia after the Sack of Dehli in 1739. Present owner unknown.

**Throne Diamond**; reportedly a diamond of 90 cts, seen in India by Tavernier, it was one of the principal ornament in the Peacock Throne. Present owner unknown.

**thulite**; an opaque, rose-red to pink variety of zoisite owing its color to the presence of manganese. Used as ornamental and decorative stone. Optics;  $\beta$ :1.688-1.710. Birefringence: 0.003-0.008.  $\oplus$ . SG:3.55. H:6½-7. Found in Norway.

**thulite cut**; cut cabochon and sometimes as faceted gems but mostly used as an ornamental or decorative stone.

**thulium**; a silvery-gray metallic element of the rare earth group of the Periodic System with the symbol Tm.

**thumb marks**; the minute ripples and marking or fractured surface of amethyst quartz, which contain twinning laminae.

**thunderbolts**; a popular local term for small nodules of pyrite found in Sussex, England, often thought by finder to be a meteorite but it is not. Also called ceraunite and spelled thunder-bolts.

**thunder-bolts**; another spelling of thunderbolts.

**thunder eggs**; a popular local term for a small chalcedony, opal, or agate-filled geodes found in rhyolite lavas and tuffs in central Oregon, USA. Some shows a 5-pointed star, when cut into cabochon. Also called agate, opal or chalcedony thunder egg.

**thumerstone**; same as axinite.

**thunder-stone**; another term for belemnite.

**Thursday Island pearl**; pearls from Thursday Island between Australia and New Guinea.

**Ti**; a chemical symbol for the element titanium.

**ti**; a Chinese term for a white jade piece worn on girdle as a sincerity sign. → Chinese ritual and symbol jades.

**tiara**; usually a piece of curved or semi-circular head

ornament, coronet worn by women on the hair, which is encrusted with gems diamonds and other stones. The original was a head dress worn by ancient Persians. → Diamond Tiara of the Queen of Sweden.

**Tibet stone;** a trade term for a mixture of white and rose-colored quartzite rock and aventurine quartz. Used for ornamental carvings and curio stone.

**Tibet stone;** an obsolete term for eosite, an aventurine like quartz.

**Tibetan turquoise;** turquoise from Batang and Chando, Lhasa, Tibet.

**tickal;** a Myanmar (Burmese) unit of weight equal to 80 carats.

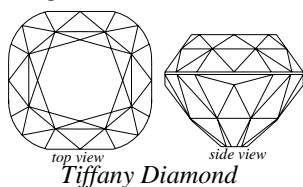
**tidal mining;** remaining alluvial gravel beds caused by tides in a flat coast area, in which ore or diamonds can be found.

**tie;** a Chinese term for an archer ring worn on thumb made of jade, frequently used instead as *kueh*. → Chinese ritual and symbol jades.

**tiff;** in South-East of Missouri for barite.

**tiff;** in South-West of Missouri for calcareous spar.

**Tiffany Diamond;** a fancy canary yellow, octahedron rough diamond of 287.42 cts, found around 1878 in



South Africa. Cut into a cushion-shaped brilliant of 128.51 cts, with 90 facets, 40 facets on crown and 48 facets on the pavilion, a table and a culet. Bought by

Tiffany and Co. in New York, USA in 1879 and still owned by them. Also called Tiffany Yellow Diamond, Yellow Tiffany Diamond, Canary Diamond.

**Tiffany head;** same as Tiffany setting.

**Tiffany Mine;** location of a turquoise mine near Los Cerillos, New Mexico, USA. Reportedly was mined till 1915.

**Tiffany mount;** same as Tiffany setting.

**Tiffany Queen Pearl;** another name for Queen Pearl.

**Tiffany setting;** a style of setting a transparent solitaire gemstone or diamond in a finger ring with six high prong head (frequently four prong) generally round in shape. Also called Tiffany head, Tiffany mount.

**Tiffany Yellow Diamond;** same as Tiffany Diamond.

**tiger amber;** a term used in China to a kind of transparent, brown striped amber, in Chinese is calling *hu peh*.

**Tiger of the Punjab;** → Koh-i-Nûr Diamond.

**tiger's-eye;** a variety of cat's-eye. The name is given to a highly chatoyant, translucent golden silky sheen quartz, which is pseudomorphous after crocidolite a greenish-blue fibrous variety of riebeckite-asbestos, which changes its chemical composition but not the

form. The coloration caused by oxidation of iron impurities usually limonite, which changes partially the color of crocidolite into yellow-gold and gold-brown before replacement by quartz. Sometimes blue, brown, green or streaked colors can be seen. Frequently silicified or pseudomorph without alteration of the blue color has been, which is known as *sapphire-quartz*, *azure-quartz*, *siderite*, *hawk's-eye* or *falcon's-eye*.



*crocidolite-quartz needles of tiger's-eye in thin section under microscop*

When it is partially colored in variegated blue and gold-brown it is known as *zebra crocidolite* or *zebra tiger-eye*. By heat

treatment the limonite gold-brown crocidolite stones are changed to hematite to obtain red to brown red luster. Silky luster can be seen intensively, when cut en cabochon. Found in West Griquatown, South West Africa. Varieties are: binghamite, silkstone. Used as engraved gems, tumbled, ornamental objects and cut en cabochon. Occasionally stones that are dyed, are easily to distinguish. Also spelled tigereye, tiger-eye, and called tigerite.

**tiger's-eye cut;** cut en cabochon, engraved gems and items, tumbled, and ornamental objects.

**tiger's-eye cameo;** carving relief of classical motifs on tiger's-eye.

**Tiger-Eye Diamond;** a deep natural amber-colored rough diamond of 178.50 cts, found in 1913 in Droogefeld, Vaal River, South Africa. It was cut in Amsterdam into a brilliant of 61.50 cts, Whereabouts is unknown.

**tigerite;** same as tiger's-eye.

**tiger's sandstone;** a kind of striped sand.

**tiger stripes in amethyst;** a typical liquid-filled ducts inclusion in parallel arrangement with a structure appear as striations similar to zebra or tiger stripes, which may occur due to some kind of growth disturbance or pressure may caused internal shearing. → Amethyst inclusions.

**tiki;** a local Maori term used for carved objects and figures from nephrite sometimes with eyes made of mother-of-pearl. Worn as a pendant by Maori women in New Zealand.

**tilestone;** same as flagstone.

**till;** a term applied to unstratified, unsorted, generally unconsolidated, heterogeneous mass of rocks and gravels left behind from glacial action in which can found several important minerals.

**till;** a stiff hard clay often containing gravels, boulders, sand, etc.

**tilted table;** fashioned gemstone table that is not parallel

to plane of the girdle.

**Timur Ruby;** a large unfaceted red spinel of 352.50 cts, which was known in the East for nearly 600 years as Khiraj-i-Alam, that means Tribute of the World and as ruby. It was seized by Timur-i-Leng (the Lame Timur) in 1398 in Dehli. After it passed through a number of hands at last came into possession of the East India Company in 1849 it was presented to Queen Victoria in 1851. The stone is now among British Crown Jewels set in a diamond necklace with other spinels. The Persian inscription indicated its six owners.

**tin;** a soft, silvery-white, malleable, ductile metallic element in the group IV of the Periodic System with the symbol Sn. Existing in 3 allotropic form. It is unaffected by air and water.

**tincal;** an old Persian term used as synonym for crude borax mineral  $\text{Na}_2\text{B}_4\text{O}_7 \cdot 10\text{H}_2\text{O}$ , which came from salt lakes. Also spelled tinkal, and called borax.

**tincal bead;** a type of bead of borax group used in blowpipe analysis of metallic compounds. Also called borax bead.

**tin cut;** a misleading trade term for glass imitation stone, which has been cut and polished on a tin lap using tin oxide, as distinguished from molded stone.

**tinctorial agents;** metal oxides, which are used as color agents. → Tenebrescence, transichromatic, transition elements.

**tincture;** a tint.

**tincture;** same as foil back, lacquer back.

**tincture;** a substance used as dye.

**tindal;** a Singhalese (Ceylonese) term for ship master of pearl oyster fishing.

**ting;** a Chinese term used for a four-legged casket carved on jade. → Chinese ritual and symbol jades.

**Tingha;** location of diamond and opal deposits on the Queensland border, Australia.

**tinge;** literally a slight degree of coloration.

**ting or hu;** a Chinese term for a tablet made of jade, worn by Emperor on his girdle and used as a source for writing. → Chinese ritual and symbol jades.

**tingzi;** a Chinese term for a nail-like edge made of jade. → Chinese ritual and symbol jades.

**tinkal;** same as tincal.

**tin-lap;** a flat steel part covered with pure tin. → Blocking.

**tinned;** objects covering with pure tin.

**tin ore;** same as cassiterite.

**tin oxide;** same as putty powder.

**tin polished;** gemstones that have been polished on tin lap. Sometimes misleadingly used as a synonym for tin cut.

**tin spar;** a synonym for cassiterite.

**tinstone;** a synonym for cassiterite.

**tint;** same as a low saturated or unsaturated color.

**tint;** a color lightened by addition of white.

**tint;** colors, which have same hue but different saturation.

**tint;** any slightly tone of hue.

**tint;** same as tinge.

**tint;** misleadingly used frequently as a synonym for tone.

**tinted color;** a color classification for fashioned diamonds on the CIBJO color grading system.

**tinted diamond;** natural very light colored diamond, usually yellow, brown or gray.

**tinted diamond;** same as coated diamond.

**tinted gold;** the surface of objects made of gold with different hue on a certain part of an article, which is made of gold alloy or copper. → Depletion gilding. objects of gold, gilding.

**tinted white;** a color grading scale for fashioned diamonds on the CIBJO and IDC for faint yellow stones. Equivalent to K to L on the GIA color grading system. On the Scan. D.N. color grading scale for the top cape.

**Tintinbar opal;** location for opal mining in North East New South Wales, Australia. The opals from this locality are similar to that of Rainbow Ridge, which developed cracks by exposure in the air and this causes loss in color.

**tinting;** to improve the color and brilliance of certain gemstone by backing or painting the facets of the pavilion. For example yellowish diamond is usually tinted with a violet dye. Often tinted stones are mounted in a closed setting.

**tinting;** frequently used to deceptively improve the appearance of inferior materials, minerals or gemstones. → Treated diamond.

**tinzenite;** → magnesioaxinite.

**tipi pounamu;** a Maori term for flattened alluvial green jade pebbles, used for ornamental purposes or amulet gems and as weapon by natives of New Zealand. The term meaning true greenstone. → Pounamu.

**tiree marble;** a pink to white variety of marble from the Western Isles of Scotland, which contains minute crystal of diopside.

**Tiros;** location of several diamond deposits near the town Tiros on the Abaeté River in Minas Gerais, Brazil.

**Tiros I Diamond;** a rough brown diamond of 354 cts, found in 1938 near Tiros on the Abaeté River in Minas Gerais, Brazil. Present owner unknown.

**Tiros II Diamond;** a rough rose diamond of 198 cts, found in 1936 near Tiros on the Abaeté River in Minas Gerais, Brazil. Present owner unknown.

**Tiros III Diamond;** a rough colorless diamond of 182 cts, found in 1936 near Tiros on the Abaeté River in

Minas Gerais, Brazil. Present owner unknown.

**Tiros IV Diamond;** a rough brown diamond of 173 cts, found in 1938 near Tiros on the Abaeté River in Minas Gerais, Brazil. Present owner unknown.

**Tiros Lilac Diamond;** a rough lilac diamond of 12.25 cts, found in 1938 near Tiros on the Abaeté River in Minas Gerais, Brazil. Present owner unknown.

**tirungem;** a commercial term for synthetic rutile. It has high color dispersion hence used as a diamond imitations. Also spelled tirum gem.

**tirum gem;** → tirungem.

**tissue-graft cultured pearls;** a fragment of mantle tissue from fresh-water mussel *Hyriopsis schlegeli*, which is inserted into the body of the mussel to produce non-nucleated cultured fresh-water pearl, which are grown at Lake Biwa, Honshu, Japan. The non-nucleated product is typically brown to salmon colored, and rarely white, oval or baroque in shape, has an attractive luster. → Non-nucleated cultured pearls.

**titanate of barium;** another term for barium titanate.

**titangem;** a commercial term for synthetic rutile. It has high color dispersion hence used as a diamond imitation.

**titania;** a commercial term for synthetic rutile. It has high color dispersion. Used as a diamond imitation.

**titania brilliant;** a commercial term for synthetic rutile. Used as a diamond imitation.

**titania cut;** titania with star effect can be seen, when cut cabochon. → Synthetic rutile.

**titania midnight stone;** a commercial term for synthetic rutile. It has highly color dispersion hence used as a diamond imitation.

**titanic iron ore;** same as ilmenite.

**titanic schorl;** same as rutile.

**titanite;** a synonym for sphene.

**Titan Oval Diamond;** a flawless oval brilliant diamond of 51.31 cts, cut from a rough stone of 98 cts, from South Africa. Present owner unknown.

**titanium;** a silvery-white, malleable, ductile, metallic element of the Periodic System with the symbol Ti, resembling iron. One of the 8 elements responsible for color in minerals and gemstones such as sapphire.

**titanium;** a commercial term for synthetic rutile or titania. It has high color dispersion and hence is used as a diamond imitation.

**titanium coloration;** one of the eight transitional metallic elements (trivalent) in form of trace colored gemstones in blue such as sapphire, tanzanite and benitoite. It is responsible for rose or pink colored quartz, synthetic beryl, synthetic blue sapphire together with small amounts of iron oxide, and in some glasses causes yellow-brown color by the presence of titanium oxide.

**titanium dioxide;** → lithophone.

**titanium in sapphire;** → titanium coloration.

**titanium rutile;** a commercial term for synthetic rutile or titania. It has high color dispersion hence used as a diamond imitation.

**titanstone;** a commercial term for synthetic rutile or titania. It has a high color dispersion and hence is used as a diamond imitations.

**Tl;** a chemical symbol for the element thallium.

**tlilavotic chalchihuitl;** a green and black, translucent jade from Central America used by Aztec and Toltec Indians as magical carved objects. → Tolteca-iztli.

**tlilayotic;** a term used by native American Indians for a relative stone to chalchihuitl or turquoise, because the common people were not permitted to wear chalchihuitl.

**Tm;** a chemical symbol for the element thulium.

**toad's-eye;** same as toad's-eye tin.

**toad's-eye tin;** reniform or botryoidal reddish variety of cassiterite with internal concentric structure. Cut cabochon. Also called toad's-eye, wood tin.

**toadstone;** an old Derbyshire term for certain amygdaloidal basalt lava.

**toadstone;** once a fossilized object consisting of the petrified fish tooth or parallel bone occasionally worn as a protective or curative power, charm or an antidote to poison. Set in finger rings as an amulet. Also called *virtuous stone*, when it is made from gemstones.

**toasted amber;** heat-treated amber become a brown toasted color with sun-spangle. Also known as antique amber.

**tobacco jack;** a mining name for wolframite.

**to dai;** a Sinhalese (Sri Lanka) term for pearl fishing boat.

**todo mundo stone;** a Brazilian term for common dark-green tourmaline from Salinas, Minas Gerais, Brazil.

**toe;** a term used by Australian opal miners for a base of opal level in a mine with along sloping toe dirt.

**toe pick;** a term applied by miners for a large pick used to remove toe dirt in opal shaft.

**tofal;** literally topal, a Farsi or Persian term meaning metal or metallic. Large, flat, slab-like pieces of turquoise used for setting in metal such as bracelets, bazu-bands, amulets, etc. → Turquoise classification in Iran.

**tokhom-morgh;** same as khagi.

**Tokowaya;** same as Takawaya.

**tokay lux sapphire;** a misleading term for brownish-black obsidian from Hungarian. Also spelled tokay lynx sapphire.

**tokay lynx sapphire;** another spelling for tokay lux sapphire.

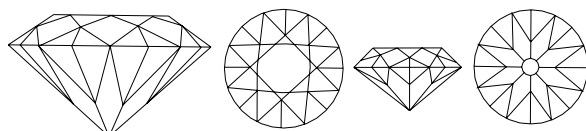
**tola;** unit of weight used in India for pearls and precious

metals such as gold. One tola is equivalent to 58.32 carats.

**Toktogul Diamond;** a rough diamond of 37.56 cts, found in 1955 at Mirnyi, Sakha, the Russian Federation, CIS. Now on display in the Russian Diamond Fund in Moscow.

**Tolfa diamond;** a misleading term for quartz crystal from Tolfa, Italy.

**Tolkowsky brilliant cut;** one of several ideal cuts for round brilliant based on theoretical work of Marcel Tolkowsky, mainly favored in USA. The table facet

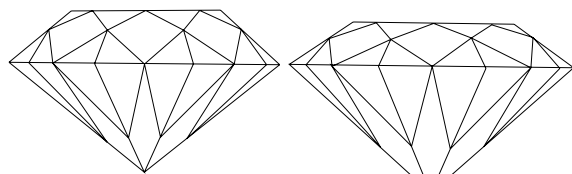


*Tolkowsky brilliant-cut*

*early brilliant-cut or Tolkowsky-cut*

*Tolkowsky brilliant-cuts, modern and early-cut*

diameter 53%, 16.2% crown height, 43.1% pavilion depth, 0.7% to 1.7% girdle thickness and total depth from table to culet 60-61%. The crown angle is  $34^{\circ}30'$ ,



*Tolkowsky brilliant-cut*

*ideal brilliant-cut*

*Tolkowsky and ideal brilliant-cut*

and the base angle is  $40^{\circ}83'$ . Compared with the girdle diameter and a crown height to pavilion depth ratio of 1:3. Also called Tolkowsky theoretical brilliant cut.

**Tolkowsky flower cut diamonds;** a registered name for 5 new diamond cuts of an exceptional cut style especially effective in improving the appearance of fashioned diamonds of the lower color ranges and to increase the yield of stone. Created by CSO consultant Gabi Tolkowsky in 1988. Those five cuts are: Fire Rose Cut, Dahlia Cut, Marigold Cut, Sunflower Cut, and Zinnia Cut.

**Tolkowsky Marcel;** (1907-1973) mathematician who calculated and published the proportion and facet angles of brilliant cut diamond to obtain maximum brilliancy. Frequently called America cut, and ideal cut.

**Tolkowsky Sunflower Cut;** → Sunflower Cut.

**Tolkowsky theoretical brilliant cut;** same as Tolkowsky brilliant cut.

**tolteca-iztli;** a green, clear, translucent, fine-quality of jade from Central America used by Aztec and Toltec Indians as magical carved objects. → Tlilavotic chalchihuitl

**toluene;** a volatile, colorless, flammable, toxic, benzene-like odor liquid with low surface tension of formula:  $C_6H_5CH_3$ . Insoluble in water but soluble in alcohol, benzene, and ether. Used in the specific gravity measuring of heavy liquid as dilution of bromoform and methylene iodide. RI:1.49. SG:0.8737. Flammable, toxic by ingestion, inhalation, and skin. Also called toluol, methybenzene, phenylmethane.

**toluidine, ortho-;** a liquid with refractive index of 1.575 usually used for refractive index determination of beryl. Also spelled ortho-toluidine and spelled o-toluidine.

**toluidine red;** an organic compound contains an azo group pigments based on coupling of meta-nitro-paratoluidine and beta-naphthol. Used as dyes and in enameling.

**toluol;** a commercial term for toluene.

**tomato amber;** a term used for bastard or semi-bastard amber, which is darkened in color due to aging.

**tombac;** an alloy of 70-92% copper with zinc, used for gilding and making cheap jewelry items. Also spelled tombak, tambac, and called Prince's metal, Mannheim gold, Dutch gold, Dutch metal.

**tomb jade;** jade pieces, which have been buried in a tomb usually with the dead as a Chinese custom that has altered color to brown or reddish skin by associated bronze articles. → Mouth jade.

**tombak;** same as tombac.

**tomb of parasitic worm;** a term used by Spencer for morbid condition of the mollusk due to parasitic worms.

**tonaka bean camphor;** → coumarin.

**tone;** a quality of color, which is dependent upon the degree of absorption or reflection of light and determines its position in a scale from dark to light. For example maroon is dark tone of brown or rose is a light tone of red. Also called lightness.

**tong;** same as tang.

**tongs;** an arrangement that hold the cup, in which a diamond or other gemstone is mounted to press it against the polishing wheel.

**tongs;** a tool for holding and manipulating the diamonds or another gemstones. → Pearl tongs, corn tongs, tweezers.

**tongs;** any various device with long-handles for holding and gripping of objects.

**Tongo;** location of diamond deposits in Sierra Leone, Africa.

**tongs, diamond;** → diamond tongs.

**tongue test;** glass jewels are readily distinguished from genuine gemstones. Glasses feel warmer, when held to the tongue than other gemstones, because of poorer or non-thermal conductivity.

**tongue test;** testing of minerals with the tongue for their taste such as common salt, salty, etc.

**tool-stone diamond;** a term applied to industrial diamonds, which has quality and form that is suitable for cutting of metals.

**tooth;** any hard, sharp, bone-like, chitinous or calcareous structures set in jaw of most vertebrates for biting, tearing, or chewing.

**tooth test of pearl;** imitation pearls such as glass beads, hollow glass, wax-filled glass, solid-coated glass-beads or plastics beads are smooth to the teeth by the feel of their surface against the teeth, while both the natural or cultured pearl have an irregular edges of the overlapping crystal plates of aragonite cause the optical effect, luster or orient, which are best seen by microscopically study the surface of pearls. This surface structure of overlapping platelets of pearls gives a peculiar rough feeling to the teeth. Newly some imitation pearls have same surface similar to natural or cultured pearls.

**tooth turquoise;** a misleading term for odontolite, used as a turquoise imitation.

**toowoomba;** location of light green crystal of peridot from Toowoomba, Aubigny County, Queensland, Australia.

**top;** the part above the girdle of a cut gemstone, which is called the crown.

**top;** same as overburden.

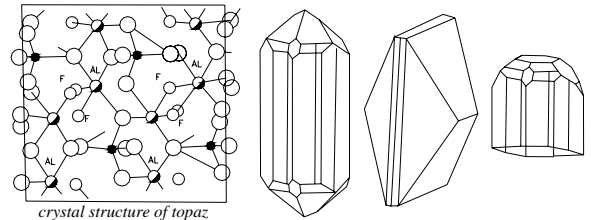
**top and apex;** the top or highest point of a vein relative to surface.

**topacio;** Spanish spelling for topaz.

**top rock;** same as roof.

**topaz;** a hard mineral cut as faceted gems and as brilliant cut, mixed cut and pendeloque. Sometimes the term topaz is misnomered such as *Oriental topaz*, which is a yellow sapphire. *False topaz* is a yellow quartz, when heated or citrine, also *Spanish topaz* or *Scotch topaz* or *Brazilian topaz* is a citrine. Colorless quartz, corundum, tourmaline or green colored aquamarine or pink variety of tourmaline (rubellite) are misnomered as topaz. By heat treatment reddish-brown topaz turns its color to pink (*pinking*) and by irradiation and heat treatment colorless topaz change its color to deep blue, which is called *super blue topaz*, *super American blue topaz*, *super Swiss blue topaz*, *London blue topaz*, and *mid Electra blue topaz*. *Ocean green topaz* is an irradiated topaz in a nuclear reactor, which turns its color to green. Commercially synthetic topaz is

not made, but misleadingly yellow-colored synthetic corundum is named as synthetic topaz. Erroneously some yellow stones are given the suffix topaz such as quartz-topaz, or glass-topaz. Varieties of topaz are pycnite, pycnite-columnar (an amber colored topaz



### crystal structure and topaz crystals

from Brazil with chatoyancy effect), pyrophyssalite, Brazilian sapphire, Saxon chrysolite or frequently misnomered as *Brazilian ruby*. Reddish-brown, brownish-yellow to orange yellow-brown variety is called *sherry topaz* and orange is known as *precious topaz*, which is also reserved for noble topaz. *Aqua aura topaz* is a commercial term for a coated blue topaz, which is coated with gold and a superficial iridescence. *Imperial topaz* is a pinkish-orange, reddish-orange to sherry brown topaz. *Goutte d' eau* and *pingo d'agoa* are French/Brazilian terms applied to water-worn pebbles of colorless topaz crystal in Brazilian. Topaz is a *birthstone* for November.

System: orthorhombic.

Formula:  $4[Al_2SiO_4(F,OH)_2]$ . 30% mol OH substitute F because of large size of OH.

Luster: vitreous.

Colors: colorless, white, yellow, yellowish-brown, bluish, gray, green, orange, purple, reddish.

Streak: colorless.

Diaphaneity: transparent to translucent.

Cleavage: {001} perfect break easily.

Fracture: subconchoidal to uneven. Brittle.

SG: 3.50-3.57.

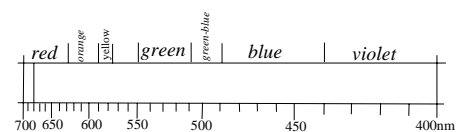
H: 8.

Optics:  $\alpha$ : 1.606-1.634,  $\beta$ : 1.609-1.637,  $\gamma$ : 1.616-1.644.

Birefringence: 0.008-0.011. ⊕.

Dispersion: 0.014.

Found in Sri Lanka, Malagasy, Brazil, Zimbabwe, Australia, Pakistan, Namibia, Russia, Nigeria, and



absorption spectrum of heated topaz

USA.

**topaz;** colorless topaz is misnomered as Saxony diamond.

**topaz absorption spectrum;** only be seen by heated stones due to chromium at 682 nm.

**topaz, Brazilian;** same as Brazilian topaz.

**topaz cat's-eye;** very rarely seen cat's-eye effect in true blue or yellow topaz.

**topaz cat's-eye;** reportedly some topaz shows weak cat's-eye effect due to several parallel etch ribbons of light-yellow color which is colored by limonite or of subparallel tubes of hard inclusions. Found in Brazil and Sri Lanka.

**topaz cat's-eye;** a misleading term used for chatoyancy topaz-colored sapphire. Found in Sri Lanka.

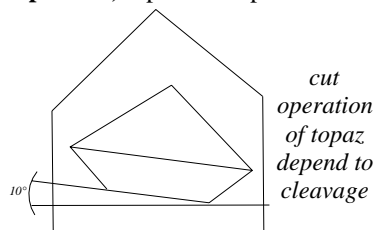
**topaz chatoyancy;** amber colored topaz from Ouro Preto, Brazil shows weak chatoyancy effect due to several parting parallel to the *c*-axis because of probably two-phase inclusions along *c*-axis. Also called amber topaz.

**topaz cleavage;** the cleavage of topaz is perfect but breaks easily therefore it is difficult to polish perfectly.

**topaz, coated;** same as coated topaz.

**topaz color and habit;** different habits of topaz crystal have also different color such as yellowish-brown as (100), blue (120) and pinkish-brown and blue (011).

**topaz cut;** topaz takes polish well with a high luster, cut



as faceted gems and as brilliant cut, mixed cut, pendeloque but cleavage of topaz break very easily, difficult to polish well. Cut blue

irradiated topaz is called *fantasy* cut.

**topaz foiled;** → coated stone, heat treatment and irradiation of topaz.

**topaz glass;** yellow-colored glass like topaz. RI: up to 1.77.

**topaz, heat treatment;** → heat treatment of topaz.

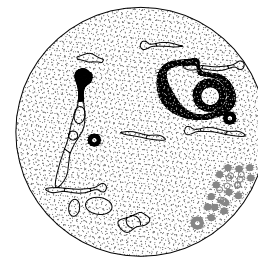
**topaz, heat-treatment and irradiation;** → topaz, heat treatment and irradiation of topaz.

**topaz imitation;** topaz imitations are made of glasses or used other natural stones as imitations.

**topaz,-imperial;** → imperial topaz.

**topaz, inclusions in;** some topaz contains drop-shaped cavities with two or three unmixed liquids (three phase). White topaz from Nigeria, Africa contains cubic crystals. Solid materials found as inclusions as mica, spessartine garnet, monazite, quartz, monzonite, limonite, fluorite, albite, and brookite. In Brazilian topazes needle-like inclusions of limonite-stained

etched dislocation channels or cavities in trade are



three phases inclusions in topaz

known as *rutilated topaz*. → Topaz inclusion.

**topaz irradiation;** → topaz, heat treatment and irradiation of topaz.

**topaz,-large and notable;** a unique mineral with large crystals and mostly derived from mesozonal pegmatite and flawless. → Topaz table, notable topaz.

**topaz luminescence;** luminescence varies according to fluorine-rich or hydroxyl-bearing variety. Colorless and blue stones exhibit weak yellow-green under LWUV light, very weaker under SWUV light. Under LWUV light natural lilac stones glow weak deep red under SWUV dull green. Sherry-brown stones and heat-treated pink samples glow orange-yellow under LWUV light, and weaker under SWUV light.

**topaz, nomenclature of;** → topaz.

**topaz, occurrences of;** → topaz.

**topaz,-optics of;** optical properties of topaz varied due to function of OH content.

**topaz, Oriental;** a misleading term for yellow variety of sapphire. → Topaz.

**topaz, parting of;** amber colored topaz from Brazil with chatoyancy effect because of several parting parallel to the *c*-axis, probably refer to two different inclusions elongated along *c*-axis. → Topaz chatoyancy, topaz.

**topaz, pink;** → pink topaz.

**topaz pleochroism;** strong pleochroism in pink heated stone, in brown, yellow and blue stone is medium. Dichroism can be seen in the pink stones, weaker in yellow. Pleochroism of some colored topaz are seen in below table:

table 15; pleochroism seen in colored topaz. Color of light vibrating parallel to axes X, Y and Z. After Hoover D.B. 1992

topaz color	X or $\alpha$	Y or $\beta$	Z or $\gamma$
purple	colorless	light purple	dark pink
pale blue	pale blue	colorless	very pale blue
brown irradiat	deep brown	light brown	brown
natural brown	brown pink	brown pink	colorless
light-brown	dark yellow	brown yellow	pale pink
amber	dark amber	pinkish amber	pink

**topaz, polish of;** topaz takes a high polish and some pieces can be recognized by their slippery effects. → Topaz cut, topaz.

**topaz quartz;** a misleading term for topaz-colored citrine. Also mislabeled by jewelers when cut as a gem. Also called Bohemian topaz, Colorado topaz, citrine topaz, false topaz, yellow quartz, quartz topaz.

**topaz quartz;** a misleading term for topaz-colored quartz.

**topaz quartz;** a misleading term for amethyst heated to a golden brown color.

**topaz, saffronite;** a misleading term for topaz-colored heat-treated citrine a variety of quartz. Also called safronite, safranite.

**topaz, Scottish;** → Scottish topaz.

**topaz, slippery feel of;** → topaz, -polish of.

**topaz star;** frequently seen star effect in Sri Lankan topaz.

**topaz, synthetic;** synthetic topaz has been made but not commercially. → Topaz, synthetic topaz.

**topazolite;** a misleading term for transparent yellow, greenish-yellow variety of andradite garnet. Found in Norway, Russia, and New Jersey, USA. → Demantoid.

**top break facets;** same as upper girdle facets.

**top cape;** an old diamond color grading for polished diamond with yellowish tinge visible to an unaided eye, which is between crystal and cape. Frequently called light cape.

**top cape;** a color grade on Scan. D.N. for diamonds over 0.47 cts, roughly equivalent with K-L on the GIA color grading scale.

**top corner facets;** same as bezel facets or quoin facets.

**top crust;** same as upper crust.

**top crystal;** an old diamond color grading for polished diamond with light yellowish tinge, which is between Wesselton and crystal.

**top crystal;** a color grade on Scan. D.N. for diamonds over 0.47 cts, roughly equivalent with I on the GIA color grading scale.

**top half facets;** same as girdle facets.

**tophus;** → tufa.

**top jewel;** same as end stone.

**Topkapi Cabochon Emerald;** a dark green to black engraved emerald carved as a flattish cabochon of 16300.00 carats. Now on display at Topkapi Museum in Istanbul, Turkey.

**Topkapi Hemisphere Emerald;** a Columbian dark green emerald (it appeared black), carved as a hemisphere of 6550.00 carats. Now on display at Topkapi Museum in Istanbul, Turkey.

**Topkapi Museum;** a treasury museum in Istanbul, Turkey. There are several jewels of historical interest preserved. Open to public.

**top light brown;** an old term of an approximately colorless diamond, equivalent with J on the GIA color grading scale.

**top main facets;** same as bezel facets.

**top rock;** a term used by Australian opal miners for overlying hard rock under which opal dirt is usually found and provides a safe work. Also called roof.

**top shell;** a common term for any of the marine conical spiral shell of the genus *Trochidae* (Trochus). They have a pearly interior and a thin, horny operculum mainly from tropical and temperate waters. Used for ornamental objects and small nacre articles. Fished in large quantities from Australian waters. Also called Trochus shell, commercial top shell.

**top silver cape;** an old diamond color grading for polished diamond of faint yellow color.

**top Tresselton;** a term used for diamond color grading for approximately fine-white color such as white or blue-white Tresselton.

**top Wesselton;** an obsolete term for diamond color grading for polished diamond of small sizes, approximately colorless, when colored is noticeable to the trained eye.

**top Wesselton;** a color grade on Scan. D.N. for diamonds between River and Wesselton, roughly equivalent with F-G on the GIA color grading scale. On the CIBJO and IDC for Rare White+ and Rare White.

**Topcon hand-scope;** a portable, hand-held pocket diamond proportion scope made by Topcon Company, Japan. It works in any reasonable light and has a fitting for mounted rings and loose stones. It is provided with Scan. D.N. proportions and with Tolkowsky proportions.

**Topcon refractometer;** a refractometer made by Topcon Company, Japan, which enables determination of the refractive index of cabochon cut stones by using the distant vision or spot method.

**Topkapi Museum;** one of the world famous museum for gems. It was the former palace of the Ottoman Empire in Istanbul, Turkey.

**topographic agate;** a variety of fortification agate with fine markings like contour lines on a topographic map. May be used as ruin agate, landscape agate or fortification agate.



*topographic agate*

**topping tool;** → bruting.

**torá;** an Indian term were used for beryl that is tinged with yellow color.

**torbanite;** a type of boghead or algal coal with high carbon oil shale. Found in Torbane Hill, Scotland.

**torc;** same as torque.

**torch;** a portable gas burner used to braze, cut, or weld.



**torch of happiness;** a symbolic legend of courage was made of amber used by Baltic people holding a lustrous torch above his head.

**toréká;** an Indian term used for emerald.

**torque;** same as rotation moment as in a motor.

**torque;** a style of neck ring or amulet made of metal in the form of a penannular hoop. Also spelled torc.

**torrelite;** a fine crystalline jasper variety of chalcedony.

**torsion;** twisting or turning of a solid body about an axis in opposite directions from either end, which is a state of shear stress induced in the material.

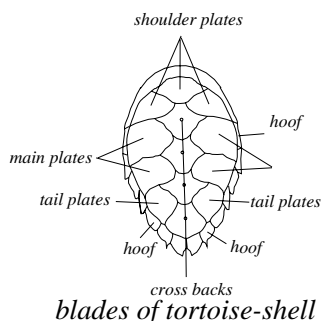
**torsional wire;** same as torsional balance filament.

**torsion balance;** a delicate instrument for measuring specific weak gravity of mineral fragments, which operates on the principal of the torsion on a small horizontal rod of metal. Berman balance is a sample for this type. Also called gravity-variometer.

**torsion balance filament;** a wire that is used in a torsion balance. Also called torsional wire.

**tortoise blonde shell;** a plain orange-yellow shell without mottling. Obtained from the plastron of the hawksbill turtle. It is easily mistaken for amber, when fashioned as beads.

**tortoise shell;** a mottled dark brown to yellow horny organic gem material obtained from the hawk's-bill sea turtle of *Chelone imbricata* plates covering the carapace (upper shell). It is translucent and can be molded by heat. RI:1.55-1.56. SG:1.26-1.35. H:2½.



Localities: tropical and subtropical seas, Brazil, Celebes, New Guinea, Malaysia, China, India, Australia, and Africa. Used as an ornamental articles, inlaying for so-called piqué, and jewelry. Imitation are made from plastics, as amber imitation and made hair combs and beads. → Blonde shell, belly shell.

**tortoise, blonde shell;** → blonde shell.

**tortoise shell, fashioning of;** tortoise shell is curved and ridged, first it must be flattened. After cleaning the surface is polished by charcoal dust or with mechanically operated dolly wheel. It is used for inlaying as piqué work with silver, gold or mother-of-pearl. → Tortoise shell.

**tosa coral;** a white red coral of medium quality from Japanese waters.

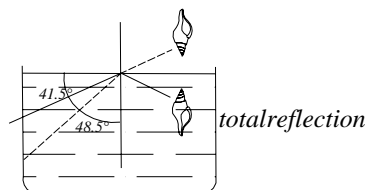
**tosanite;** same as rhyodacite.

**total depth;** → total depth percentage.

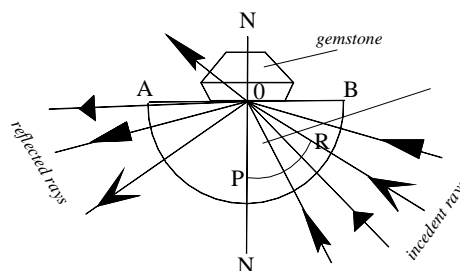
**total depth percentage;** the depth of a round fashioned stone measured from table to culet, expressed as a percentage of the average girdle diameter. Total depth depend between 53 to 63%.

**total height;** → total depth percentage.

**total internal reflection;** when electromagnetic radiation strikes from one medium to another, which is optically less dense for example, when light reflects back from the pavilion facets of a cut gem to the crown facets, the reflected light from the pavilion facets travels through crown facets at angles less than the critical angle. This effect improves the brilliance of cut gemstone.



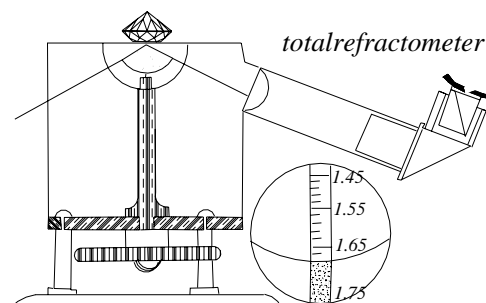
**total reflection;** an optical condition after light enters a dense medium and strikes any boundary of that



depending of critical angle or total-reflection from refraction of light between gem and glass sphere

(gemstone) at an angle greater than its critical angle (the angle of incidence). Returning of all incident waves.

**total reflectometer;** a device for measuring refractive



indices of cut gemstones, by determining the angles of total reflection. Also called refractometer.

**totoweka;** a Maori term for a green variety of nephrite

with reddish spots from New Zealand, it is a common variety of kawakawa. → Pounamu.

**touching needle;** a needle-like or slender strip-like of gold either pure or alloyed with silver, of known composition for measuring the fineness of a gold, silver or another alloy by comparing the streaks made by the article on a touchstone. Also spelled touch needle.

**touch needle;** same as touching needle.

**touchstone;** a fine grained, black, flinty (chert, or jasper), siliceous stone, used for testing the purity of noble metals by the streak left on the stone when tested with various acids. Also called touchstone and Lydian stone in ancient times. → Basanite.

**touchstone;** a fine grained, black, unglazed wedgwood pottery.

**tough;** a term applied to a flexible mineral without being brittle.

**tough;** another term for fine.

**tough;** a French term for a rock with confused structure.

**toughness;** the ability of hard materials or gemstones to resist due to absorb energy from plastic deformation, which do not fracture by a blow or breakage, to distinguished from hardness or scratching. The popular term for toughness is brittleness. Diamond is hardest mineral but rather brittle would not withstand a heavy blow. Also called tenacity.

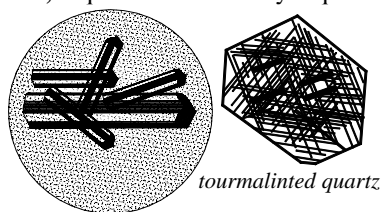
**toughness, degrees of;** toughness are seen in descending order: exceptional such as jadeite and nephrite, excellent such as corundum, fair such as tourmaline, good such as quartz and poor such as topaz and feldspar.

**touhuishi;** a Chinese term for green diopside used as jade.

**tourist stone;** a term applied to inferior stones sold to tourists from overseas.

**tourmalated quartz;** → quartz inclusions, tourmalinated quartz.

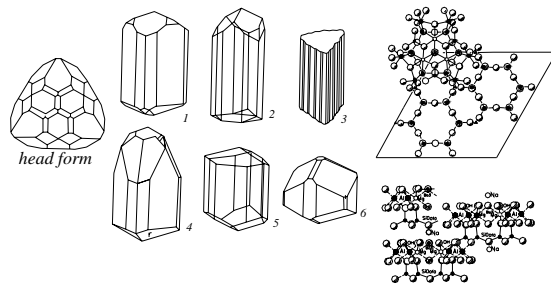
**tourmalinated quartz;** quartz or smoky quartz containing black needles, or other color tourmaline. Cut into cabochon. → Quartz inclusions.



**tourmalinated quartz cut;** cut cabochon, tumbled or used as carved materials.

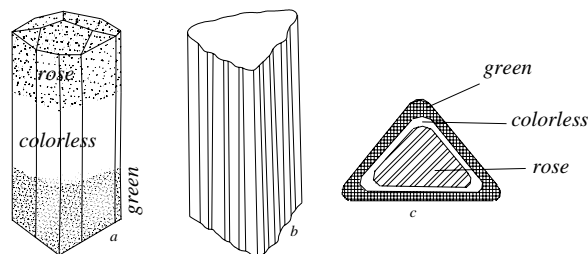
**tourmaline;** an important gem mineral with several varieties: colorless as *achroite*, ferrous iron-rich and opaque-black as *schorl* or *black tourmaline*, parti-colored green and pink in lengthwise or radially as *watermelon* tourmaline, pale red as *elbaite*, blue as

*indicolite* or *indigolite*, green as *verdelite*, yellow to orange-brown a magnesium-bearing tourmaline as *dravite*, violet-red as *siberitered* or pink as *rubellite*. Other color varieties called with the prefix tourmaline.



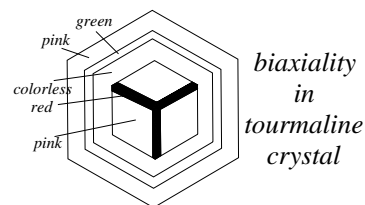
crystals and structure of tourmaline. 3: striation on tourmaline

Other varieties are: *uvite* a calcium, aluminum, magnesium-bearing tourmaline is brown to green color, *liddicoatite* is a calcium-bearing variety of elbaite in pale red color, *buergerite* is a ferric iron-bearing tourmaline in dark brown to black, *chromdravite* is a



a : zoning tourmaline crystals. b: striation tourmaline. c: cross section of a zoning tourmaline

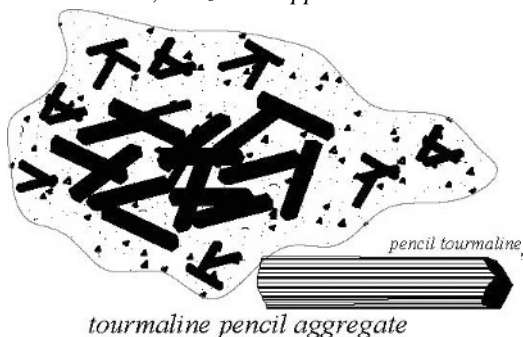
chromium-bearing dark green, and *ferridravite* is a ferrous iron and magnesium-rich in peculiar black. *Tsilaisite* is a deep pink to red, manganese-bearing variety of elbaite-tourmaline. Some specimens with inclusions exhibit chatoyancy or *cat's-eye* effect in green, blue and pink, when cut cabochon. Usually tourmaline crystals are long prismatic and vertically striated caused by oscillation between the prisms. *Pencil tourmaline* is slender, acicular or pencil-like crystal of tourmaline. It has pyroelectricity and piezoelectricity effects. *Pyroelectricity* effect can be produced, when the stone is heated to about 100° C, which is also known as *aschentrekker*, owing to polarity of tourmaline crystal, which produces negative electricity at one end and positive at the other end. Schorl tourmaline does not exhibit pyroelectricity effects. In some tourmalines an optical effect can be



seen, where multiple shadow edges instead of two edges on a critical-angle refractometer is visible, which is known as the *Kerez effects*.



This new shadow edge is caused by local overheating during polishing, which can be removed by repolishing. Also called *float*, or *satellite readings*. Tourmaline is misnomered as *Brazilian chrysolite* a green tourmaline, *Brazilian sapphire* a blue tourmaline,



*Brazilian peridot* a yellowish-green tourmaline, *Brazilian emerald* a green tourmaline, *Siberian ruby* a pink to violet tourmaline, *Ceylon peridot* a green tourmaline, *Ceylon chrysolite* a yellowish-green to greenish-yellow tourmaline. Tourmaline has strong dichroism and total absorption of ordinary rays by green and brown tourmaline, therefore used to produce *tourmaline tongs* for hand polariscope. Tourmaline has been subjected in all parts of sciences more than 2500 articles. Synthetic tourmalines are not produced. Sometimes spelled turmaline. Imitations are made from red dyed quartzite, which is miscalled *tourmaline*. → *Kerez effect*, *float*, *tourmaline tongs*, *tourmaline minerals*.

System: hexagonal (trigonal).

Formula:  $3[XY_3Z_6(Si_6O_{18})(BO_3)_3(O,OH,F)_4]$ . Where X = Ca, K, Na; Y = Mg, Mn<sup>+2</sup>, Fe<sup>+2</sup>, Fe<sup>+3</sup>, Li, Al; and Z = Al, Cr<sup>+3</sup>, V<sup>+3</sup>, Fe<sup>+3</sup>.

Luster: vitreous. Schorl vitreous to resinous.

Colors: colorless, green, pink, violet, red, blue, brown, black, yellow, parti-colored.

Streak: colorless.

Diaphaneity: transparent to translucent. Schorl to opaque.

Cleavage: {1120} distinct, and {1011} distincts.

Fracture: conchoidal to uneven. Brittle.

SG: 2.90-3.18.

H: 7-7½.

Optics:  $\omega$ :1.634-1.661,  $\epsilon$ :1.612-1.632, for dravite,  $\omega$ :1.633-1.651,  $\epsilon$ :1.615-1.630 for elbaite, and  $\omega$ :1.660-1.671,  $\epsilon$ :1.635-1.650 for schorl.

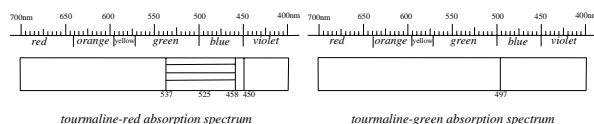
Birefringence: 0.017-0.035. ⊖.

Dispersion: 0.017.

Found in Malagasy, Myanmar, Sri Lanka, Russia, Brazil, Namibia, Tanzania, Kenya, Zambia, New York, California, and New Jersey, USA.

**tourmaline**; a misleading term for red dyed quartzite, which is used as a tourmaline imitation.

**tourmaline absorption spectra**; tourmaline shows very weak absorption spectra. The green stone in the red at 640 nm and near 560 nm, a small band in the green at 498 nm and a very weak band at 468 nm. Red and pink



*tourmaline green and red absorption spectrum*

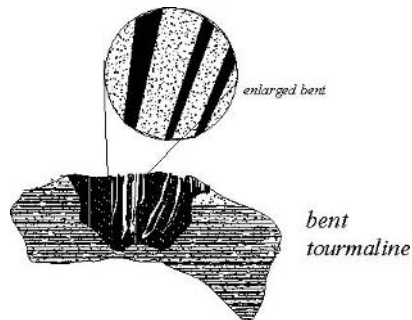
stone exhibits a band in the green at 525 nm, and narrow line at 537 nm. Green stones and some blue tourmalines exhibits a strong band in the violet at 415 nm. Broad Bands at 520 and 590, 460, and 470 nm be seen in dark brown to red dravites from Zambia, Africa.

**tourmaline alteration**; common alteration of tourmaline to micaceous substances may be related to the kaolin kind nucleus of tourmaline which can be seen in central core of stone. → *Lithomarge*.

**tourmaline as an inclusion**; tourmaline as inclusions are seen in corundum, beryl, and in quartz crystals. → *Tourmalinated quartz*.

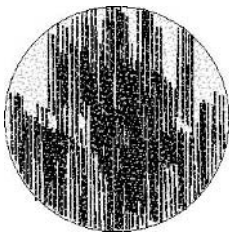
**tourmaline as birthstone**; tourmaline and opal are widely accepted as birthstone for October.

**tourmaline bent**; a typical feature can be seen in elbaite tourmaline crystal from San Diego, which is bent but not twisted. In which *c*-axis and sometimes



healed fracture are present, material of healed fracture is fibrous tourmaline or may be quartz fibers. These parts of bent and fractured crystals are so-called *in line* within their host.

**tourmaline cat's-eye;** tourmaline with nearly fine fibrous or needle-like inclusions or hollow tubes running parallel to the length of the stone exhibit chatoyancy or cat's-eye effect in green, blue and pink, when cut cabochon.

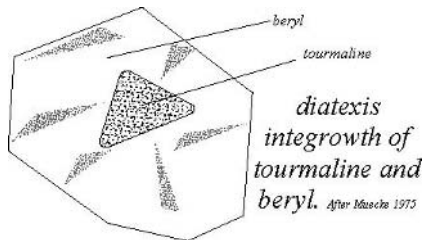


*tourmaline cat's-eye with parallel crystal fibers from California, USA*

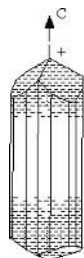
**tourmaline corundum rock;** a rock containing tourmaline and corundum.

**tourmaline cut;** cut as faceted gems, step-cut, mixed-cut, tale-cut, mixed-cut, fantasy cut, cabochon those with appropriate inclusions, tumbled and carved. Schorl or black tourmaline used as mourning jewels.

**tourmaline diatexis;** tourmaline nearly, but not



completely involving with high melting point in anatexis in metamorphic rock such as with beryl.



*pyroelectricity tourmaline crystal*

**tourmaline dichroism;** tourmaline is strong dichroism it is weak in paler stones.

**tourmaline, electricity effect of;** tourmaline shows pyroelectricity and piezoelectricity. Pyroelectricity effect can produced, when the stone is heated to about 100° C, negative at one end and positive at other end, which is also known as *aschentrekker*, due to hemimorphism or polarity feature of the crystal, which produces electricity.

**tourmaline green;** a misleading term for deep green synthetic spinel.

**tourmaline growth hillocks;** a surface growth feature of tourmaline occur on basal or pedion face like a vicinal hillock.

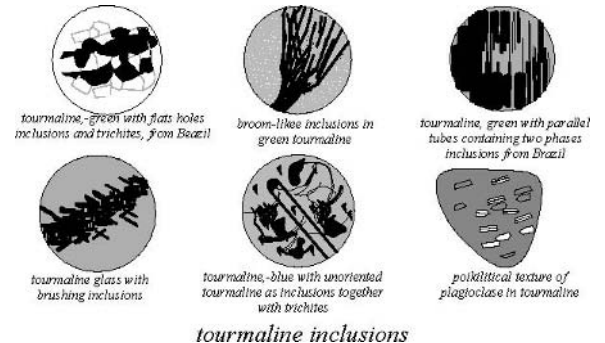
**tourmaline growth steps;** a surface growth feature of

tourmaline occur on surface of stone like steps.

**tourmaline, heat treatment of;** → heat treatment and irradiation of tourmaline.

**tourmaline imitation;** imitations are made from red dyed quartzite, which is also miscalled as *red jade*. A light green to bluish-green apatite from Malagasy known as *paraiba apatite*, which resembles tourmaline from Paraiba, Brazil. Even composite stone are seen with chatoyancy effects.

**tourmaline, inclusions in;** thread-like cavities also in



*tourmaline, green with flat holes inclusions and trichites, from Brazil*  
*broom-like inclusions in green tourmaline*  
*tourmaline, green with parallel tubes containing two phases inclusions from Brazil*  
*tourmaline glass with brushing inclusions*  
*tourmaline, blue with unoriented tourmaline as inclusions together with trichites*  
*poikilitic texture of plagioclase in tourmaline*

*tourmaline inclusions*

two-phase pattern, apatite crystal, tourmaline, mica, quartz, zircon, and microlite, etc. are as inclusions in tourmaline. Hollow tubes of inclusions running parallel

to the length of the stone exhibit chatoyancy or cat's-eye effect in green, blue and pink tourmaline. In some tourmalines can be seen single or loose and mesh-like patterns of twisted hair-like or tread-like, coiled cavities inclusions, which are know as *trichites*.

**tourmaline, irradiation of;** irradiation used to change the color of tourmaline, colorless stone turned to violet, pink or red. Also green, blue, or light pink can changed to purple and red. Yellow altered to orange. → Heat treatment and irradiation of tourmaline.

**tourmaline luminescence;** tourmalines usually show no luminescence under LWUV light, but under SWUV light some yellow specimens exhibit very weak luminesce. Some red and pink stones from Brazil under SWUV light and X-rays, exhibit violet to blue glow. Golden yellow to brown and green gem tourmalines from Tanzania show yellow glow under SWUV light. Colorless tourmalines from Afghanistan glow light violet under SWUV light.

**tourmaline minerals;** tourmaline minerals are seen in below table.

table 16: name and chemical composition of tourmaline minerals

chemical composition	name
$\text{Na}(\text{Li},\text{Al})_3\text{Fe}^{+2}_6(\text{Si},\text{Al})_6\text{O}_{18}(\text{BO}_3)_3(\text{O},\text{OH},\text{F})_4$	elbaite
$\text{NaMg}_3\text{Al}_6(\text{Si}_6\text{O}_{18})(\text{BO}_3)_3(\text{O},\text{OH},\text{F})_4$	dravite
$\text{Na}(\text{Fe},\text{Mn})_3\text{Al}_6(\text{Si}_6\text{O}_{18})(\text{BO}_3)_3(\text{O},\text{OH},\text{F})_4$	schorl
$\text{NaFe}_3\text{Al}_6(\text{Si}_6\text{O}_{18})(\text{BO}_3)_3\text{F}_4$	buergerite
$\text{Na}(\text{Mn},\text{Al})_3\text{Al}_6(\text{Si}_6\text{O}_{18})(\text{BO}_3)_3(\text{O},\text{OH},\text{F})_4$	tsilaisite
$\text{CaMg}_3(\text{Al}_3\text{Mg})(\text{Si}_6\text{O}_{18})(\text{BO}_3)_3(\text{O},\text{OH},\text{F})_4$	uvite
$\text{Ca}(\text{Al},\text{Li})_3(\text{Si}_6\text{O}_{18})(\text{BO}_3)_3(\text{O},\text{OH},\text{F})_4$	liddicoatite
$\text{NaMg}_3\text{Cr}_6(\text{Si}_6\text{O}_{18})(\text{BO}_3)_3(\text{O},\text{OH},\text{F})_4$	chromdravite
$(\text{Na},\text{K})(\text{Mg},\text{Fe}^{+3})_3\text{Cr}_6(\text{Si}_6\text{O}_{18})(\text{BO}_3)_3(\text{O},\text{OH},\text{F})_4$	ferridravite

**tourmaline, multicolored;** commonly tourmaline exhibits color zoning they are parti-colored, bi-colored or tri-colored. In bi-colored the core is colorless or green and outer segments are pink. In tri-colored tourmaline the color is separated in three zones; the core is frequently pink or red and the outer ends are white and green or any combination of these colors. Mostly tourmalines are strong dichroism it is weak in paler stones. → Watermelon tourmaline.

**tourmaline pleochroism;** strong in deep green and brown stones. Pale samples have weak dichroism.

**tourmaline quartz rock;** a granular rock consisting essentially of needle-like crystals of tourmaline or and quartz. It results from the end product of tourmalinization of granite.

**tourmaline replacement by arsenopyrite;** sometimes pegmatitic tourmaline crystals mostly schorls are replaced through arsenical pyrite or common pyrite.

**tourmaline replacement by pyrite;** → tourmaline replacement by arsenopyrite.

**tourmaline rock;** a rock consisting chiefly from tourmaline. Also called tourmalinite, luxullianite.

**tourmaline sun;** tourmaline with radiated crystal aggregate.

**tourmaline surface growths;** some feature on the tourmaline crystal faces are seen such as: hillocks, steps, snow on the roof, chicken tracks, discoidal shapes, conical protuberances, splinter-like forms, truncated prisms, pockmarks, indented marks, etc.

**tourmaline, synthetic;** tourmaline has been synthesized hydrothermally in small sizes but not for commercial use.

**tourmaline, synthetic;** a misleading term for synthetic corundum or spinel of tourmaline colors. Mostly the green stones are misnomered as green tourmaline.

**tourmaline tongs;** early hand polariscope, which was made of two thin sections parallel to the vertical crystal axis of green or brown color tourmaline placed in rotation polariscope. These sections make a plane of

polarized light, due to strongly dichroism and total absorption of ordinary ray by green and brown tourmaline.



tourmaline tweezer

Tourmaline tongs was used especially by jewelers to distinguish

isotropic from anisotropic gems. It was an easy portable polariscope.

**tourmaline twinning;** tourmaline twinning is very rare and described with twin planes  $\{10\bar{1}1\}$ ,  $\{4041\}$  from several localities.

**tourmalinite;** same as tourmaline rock. Also called luxullianite.

**tourmalinization;** introduction or replacement of pre-existing minerals or rocks wholly or partly by tourmaline, a late-magmatic or pneumatolithic process.

**tournai marble;** a misleading term for monochrome black marble from Belgium, used for clock cases and tombstones, etc.

**Tous-Diamond;** a commercial term for a diamond faceting instrument.

**toushan shi;** a Chinese term for green tremolite used as jade.

**toushan shimian;** a Chinese term for green tremolite asbestos used as jade.

**Townshed Collection;** a splendid collection of gemstones and jewels old and new in Victoria and Albert Museum in London, England.

**trace elements;** those elements, which occurs in microscopic quantities in Earth's crust.

**trace elements;** those elements, which occurs in microscopic quantities in gemstones or rocks, much less than 1%, they are not part of the chemical formula of the stone, rock or mineral. Trace elements may alter some physical properties of gems for example its color. Also called accessory elements, guest elements, minor elements.

**trace elements in diamond;** aluminum, nitrogen, boron are very important trace element in diamonds, other are calcium, copper, iron, silicon, barium, magnesium, sodium, titanium, strontium, chromium, and silver.

**tracer;** a steel point device used for tracing or drawing on metal for engraving.

**tracer;** an element, which occurs in microscopic proportions in minerals and rocks, much less than 1%. It is not part of the chemical formula of the stone.

**tracer;** one who lays out or traces lettering or signing on the surface of granite, marble or other rocks to prepare the stone for cutting. Also called decorator.

**tracer;** one who make tracing or plans with drawing machines on transparent paper to prepare the stone or gem for cutting.

**tracer**; an index mineral.  
**tracer**; an index isotope.  
**tracheids**; a term applied to ligneous nature of jet with a spiral arrangement of cellulose fibrils.  
**tracht**; → appearance.  
**trachyte**; a light-colored, fine-grained intermediate extrusive igneous rock, or glassy volcanic rock composed essentially of alkali feldspar. Equivalent of syenite.  
**trade classification of cloudy amber**; in trade the cloudy ambers are divided into flohmig, bastard, semi-bastard, fatty, foamy or frothy and bone or osseous varieties.  
**trade classification of coral**; → coral,-classification of.  
**traffic signal red ruby**; a term suggested for pigeon's-blood ruby because of comparing color. Also called stoplight red ruby.  
**trainite**; a local term for banded variety of green variscite from Manhattan, Nevada, and Utah, USA. Also called sabalite.  
**tranquil garden**; a term used in Thailand for secret holding of heat-treatment of *geudas* sapphire from Sri Lanka before the secret was unlocked.  
**transcrystalline**; same as intracrystalline.  
**transducer**; an acoustical device for detecting and determining sudden large hydrostatic pressure differences formed by explosions under water or in air which convert electrical energy into acoustic energy by using tourmaline as both pyroelectricity and piezoelectricity.  
**transformation**; the altering from one crystal polymorph to another such as by beta quartz to alpha quartz at 575 C. Also called inversion.  
**transformation**; any constitutional change of physical properties, specially an alteration of phase between solid, liquid, or gas states. Also called transition.  
**transformation**; essentially a metamorphic process or group of process by which a solid rock is converted into a granite. Also called granitization, granitification.  
**transformation twinning**; twinning, which is caused by an alteration in the crystal structure under different condition of temperature and pressure.  
**transichromatic**; some stones have the property altering their color temporarily. The color of numerous diamonds darkened, when kept in darkness and bleached, when the mineral is exposure to strong sunlight or X-ray, soon reverts to its original color. → Tenebrescence, transichromatic.  
**transition**; same as transformation.  
**transitional elements**; same as transition elements.  
**transition elements**; those eight metallic elements of Periodic System from atomic number 22 titanium to 29 copper, which are principal color agents in gemstones:

titanium, vanadium, chromium, manganese, iron, cobalt, nickel, and copper. The ions of elements copper, iron, chromium and manganese are as idiochromatic color agents in idiochromatic minerals. The ions of elements cobalt, nickel, vanadium and titanium are as allochromatic agents, which occur as impurities in minerals and increase the depth of the colors. These elements are involved with 3d electrons. Those transition elements involving with 4d electrons starting with Zr and ending with silver, and those involving with 5d electrons starting with Hf and ending with Au are named as *outer transition elements*. Because of color in these elements involving with transitions between d-orbitals to create light absorptions are called d-d colors, d-d absorptions and d-d transitions. Next row below is known as *lanthanide series* are involved with 4f electrons starting with Ce and ending with Lu. The next row is *actinide series* are involved with 5f electrons starting with Th and ending with higher transuranic elements Lw. These two rows of lanthanides and actinides are labeled as *inner transition elements*. Also called transition metal colors. In the tow table in below showing the idiochromatic and allochromatic transition metal element colors only in a few samples.

table 17: idiochromatic transition metal element colors

element	color
chromium	<b>green</b> in uvarovite, <b>purple</b> in chrome alum
manganese	<b>red</b> in rhodochrosite, <b>pink</b> in rhodonite, <b>violet</b> in manganese alum, <b>white</b> in manganese (II) hydroxide, <b>orange</b> in spessartite, <b>green</b> manganese (III) oxide, <b>brown</b> in manganite
iron	<b>red-brown</b> in hematite, <b>green</b> in melanite, <b>yellow</b> in goethite
nickel	<b>yellow</b> in nickel (II) chloride, <b>green</b> in bunsenite
cobalt	<b>blue</b> in spinel, <b>green</b> in cobalt (II) oxide, <b>pink</b> in erytherite
copper	<b>blue</b> in azurite, <b>green</b> in malachite, <b>yellow</b> in copper (I) oxide

table 18: allochromatic transition metal element colors

element	color
chromium	<b>green</b> in grossular, <b>pink</b> in topaz, green-red in alexandrite, red in ruby
manganese	<b>red</b> in red beryl, <b>pink</b> in morganite, <b>violet</b> in <b>green yellow</b> in andalusite
iron	<b>yellow</b> in chrysoberyl, <b>green to blue</b> in tourmaline
cobalt	<b>blue</b> in spinel, synthetic
nickel	<b>green</b> in chrysoprase
vanadium	<b>green</b> in V-emerald, <b>green red</b> in alexandrite

**transition elements;** any of a number of elements, which have chemical characters similar to those of their horizontal neighbors in the Periodic System, have the filling of the outermost shell to 8 electrons but incomplete inner electron shells and characteristic by their variable valences. Also spelled transitional elements. → Tenebrescence, transichromatic.

**transition metal colors;** same as transition elements.

**translucency;** description the ability of a gemstone whereby light passes through but objects cannot be seen distinctly such as moonstone, porcelain, etc. → Translucent.

**translucent;** gemstone transmits light but no object can be seen clearly through it such as moonstone. Translucent gemstones are not suitable for brilliant cutting but cut cabochon.

**transmit;** a property of some gemstones of allowing the rays or other energy to pass through it.

**transmission;** same as transmittance.

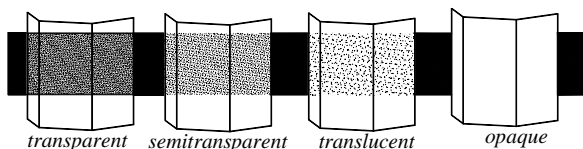
**transmission method in X-ray;** → X-ray back reflection method.

**transmittance;** an optics term applied to the ratio of radiation of light transmitted by a body to that falling upon it. Also called transmission.

**transmitted light;** that part of light passed through a gemstone as distinguished from reflected light.

**transopaque;** a gemstone, which is transparent in one part and opaque in another to visible spectrum such as hematite or goethite.

**transparency;** a gemstone is transparent, when electromagnetic radiation passes through it and objects can be seen distinctly. Transparency is roughly divided into transparent, semi-transparent, translucent, semi-



*transparency or diaphaneity*

translucent, and opaque. Transparency depend on thickness of materials, while thin section of most opaque minerals and substances transmits the light or part of them. Also called transparency of light. → Diaphaneity.

**transparency of light;** → transparency.

**transparency to UV light of diamond;** there are two types of diamond according to transparency of UV light: Type I, and Type II. Type I is transparent to about

300 nm, while Type II is transparent to about 225 nm. Type II diamonds are subdivided into Type IIa, and Type IIb. Type IIa diamonds are not phosphorescent and not conductive, while Type IIb are phosphorescent under the same condition and conduct electricity. Electricity conductivity in diamonds Type IIb is due to boron impurity in the stone. Frequently reddish afterglow can be seen in some Type IIb diamonds. → Types I and II,-diamonds, or diamond,-phosphorescence of.

**transparency to UV light of synthetic corundum;** synthetic corundum have greater transparency than the natural corundum to SWUV light. The natural corundum absorbs UV light below 290 nm.

**transparency to UV light of synthetic emerald;** synthetic emeralds has greater transparency than the natural emeralds to SWUV light. The natural emerald absorb UV light below 295 nm.

**transparency to X-rays;** the greater atomic mass of the element the less transparent the material is to X-rays such as mineral diamond with atomic number 6 is transparent to the X-rays, while zircon a gemstone with atomic number 40 for element zirconium. This method is used to distinguish between true diamond and imitation or composite stones. → Transparency.

**transparent;** a gemstone permits the pass of electromagnetic radiation through it without distortion so that the object can be seen clearly and distinctive through it, such as quartz crystal. It is a see through effects. → Window.

**transparent smoky quartz;** a transparent smoky quartz which is misnomered as Colorado diamond.

**Transvaal;** location of kimberlite pipes and alluvial diamond-bearing province of South Africa.

**Transvaal;** a gem-bearing province in northeastern of South Africa.

**Transvaal Blue Diamond;** a blue pear-shaped diamond of 25 cts, it was cut from a rough stone found in Premier Mine, Transvaal Province, South Africa. Present owner unknown.

**Transvaal Diamond;** a champagne, pear-shaped diamond of 67.89 cts, was cut from a rough stone of 240 cts, found in Premier Mine, Transvaal Province, South Africa. Presented to the Smithsonian Institution in Washington, D.C., USA, where it is now on display. Also called Victoria-Transvaal Diamond.

**Transvaal emerald;** a misleading term for African emerald.

**Transvaal garnet;** grossularite garnet from Transvaal Province, South Africa.

**Transvaal jade;** a local misleading term for a compact, fine-grained, light-green variety of hydrogrossular garnet from Buffelsfontein, Transvaal Province, South

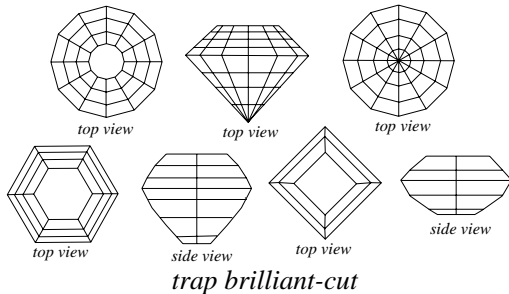
Africa. Used as a jade imitation for ornamental objects and cut into cabochon. It contains chromite as an inclusions. RI:1.70 to 1.73. SG:3.45 to 3.47. H:6½. Also misnomerly called South African jade, or garnet jade.

**Transvaal Province;** → Transvaal.

**Transvaal tourmaline;** a green tourmaline marketed through Transvaal, South Africa.

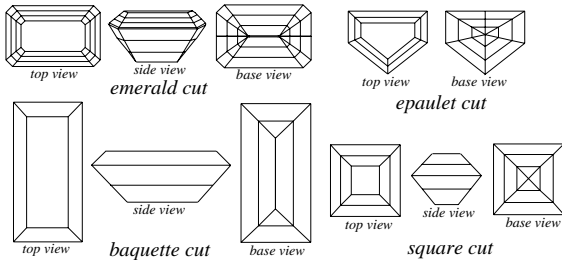
**trap brilliant;** same as trap brilliant cut.

**trap brilliant cut;** a modified brilliant cut with



approximately round girdle outline and parallel facets in step cut.

**trap cut;** a style of rectangular or square trap-cut faceted large stones. Favored for emeralds, diamonds, and other transparent colored stones with the corners beveled and

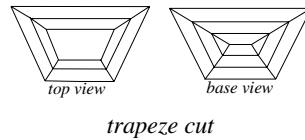


*different kind of step or trap cuts*

all surfaces covered by a series of rectangular or square facets or steps on crown and pavilion, parallel to girdle. The table is a large rectangular or square, etc. If the form is square, it is known as *square emerald cut*. A mixed cut consists of brilliant-cut on crown and trap-cut on pavilion. Observing a trap cut through the table, when it is cut perpendicular to the optic axis (or to the length of the prism), a yellowish-green hue caused by ordinary ray can be seen. A cut at right angle to this direction, or when the table is parallel to the optic axis or prism causes a bluish-green color, owed to mixture of extraordinary (more than 50%) and ordinary ray to be seen. Also emerald trap cut, step cut, oblong cut, emerald cutting. → Square emerald cut.

**trap rock;** a quarry worker's term for basalt rock.

**trapeze cut;** a fancy trap cutting diamond or other gemstone, which has profile and girdle outline of a

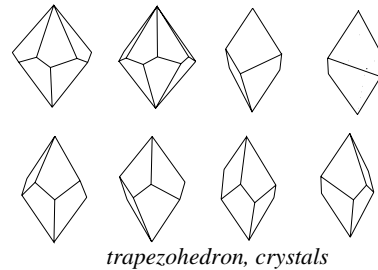


trapezium, two large parallel but unequal sides and two inclined but equal sides.

**Trapeze Diamond;** a commercial term for modified diamond cut with 48 facets tapered or straight baguette, which has a brilliant cut pavilion.

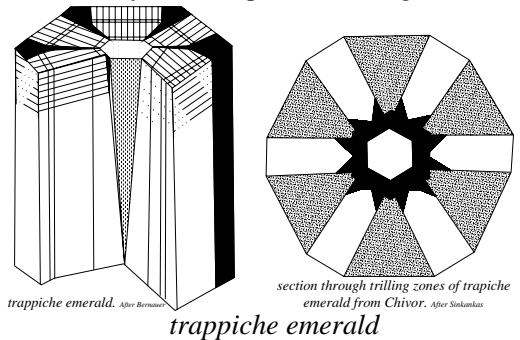
**trapezium;** a flat pattern contained by two large parallel but unequal sides and two inclined but equal sides.

**trapezohedron;** in the isometric system one of the 7 basic forms, which has 24 trapezium-shaped faces.



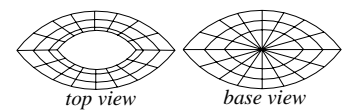
**trapiche;** a Spanish term for gear used in crushing sugar cane.

**trapiche emerald;** an unusual radially arrangement of inclusions or growth sectors of fine-grained, colorless albite and beryl with separates clear green emerald



segments of six dark spokes radiating from the prism faces of a dark central core. The appearance is similar to a spur wheel or clock pinion, and the name trapiche emerald. The clear emerald parts are cut as gemstones. RI:1.583-1.590. Found in Chivor, and Peñas Blancas, Muzo district, Colombia, South America. The name is derived from the Spanish, which means cane-crushing gears.

**trap marquise;** a modified faceted trap cut in form of a marquise with an oval girdle outline and parallel facets in step cut. Crown has 48 facets in three steps and a large 16-sided table.

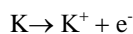




Pavilion has 48 facets in three steps without culet.

**trapped;** → trapping, defects in crystal and color effect, electron center, real crystal, color centers.

**trapping;** any electron from an ion in a crystal defect or impurity when moved downward may become trapped in a crystal vacancy such as in a halide ion that can be seen in Frenkel and Schottky defects



This can be seen as fluorescence for short time in crystals. Electrons and holes in a crystal can move as bands through the crystal but not in activator levels. When the trapped electron is released the crystal becomes bleaching again.

**Trasa;** a Sanskrit term used in past in India for defect grading of sapphire. → Sapphire, defects of in Hindu.

**traversellite;** a green clear variety of diopside from Traversella, Piedmont, Italy.

**travertine;** a translucent to opaque, decorative, hard, dense, fine crystalline, massive limestone and often cavernous of white or light-cream colored sedimentary rock of non-marine physicochemical or biological origin. with deposits from surface or underground waters or hot water springs, which precipitated from calcium bicarbonate-rich solved in spring waters. Also occurring as dripstone in caves such as stalactite or stalagmite or as fillings of some veins. The massive, parallel banded varieties, suitable for a good polish is known as *Mexican onyx* or *onyx marble*. While cellular without banding materials are known as calcareous sinter, calcareous tufa, calc-sinter, tufa, spring or cave deposit. *Silver travertine* is a silvery gray travertine from Siena, Italy. Travertines are roughly divided into translucent, crystalline, various colored caused by iron and manganese salt, which is known as *stalagmitic calcite* or *onyx marble*. The term onyx in connection with calcium carbonate is due only to the structural similarity with chalcedony onyx but not the composition. *Glazing marble* is a fine variety used as windows in Roman times and in India and the Middle East. The windows from India and Middle East were true marbles. *Alabaster* is an incorrect ancient name for a banded form of stalagmitic calcite occurring in Egypt, which was known as *Egyptian alabaster* and *Oriental alabaster*. Tyrolese onyx and Gibraltar stone are also stalagmitic marble. The stone is easily dyed and used for ornamental articles, decorative objects, and as cladding stone. → Onyx, tecali marble, Pedrara marble, oran marble, Yava onyx, Brazilian onyx.

**travertine;** partial synonym for dripstone.

**travertine marble;** → travertine.

**travertine red;** onyx marble from Israel.

**treacle;** → treacle inclusion.

**treacle inclusion;** appearance of oily streak inclusions as rounded outlines or fused can be seen in the interior of some hessonite, a variety of grossular garnet. Treacle streaks. → Inclusion in hessonite.

**treat;** → treated Andamooka matrix.

**treated Andamooka matrix;** a term used by Australian opal miners for pale porous Andamooka opal matrix with minute dispersion, or poor quality opal can be improved by dehydration and cooking of opal in a sugar solution, glucose or a black carbonaceous compound and later treating it with sulfuric acid, which produces a black background due to carbonization of the sugar by low heating.

**treated diamond;** any process used to improve the apparent, color, clarity, intensity, attractiveness, quality, etc. of diamonds. Industry enhancement is caused by irradiation, fracture filling with a glass of similar refractive index to the diamond, coating, heating, and laser cutting down to the inclusion by laser beam and often bleaching. Diamond that has been heated to alter its color eliminating the color or improving the color by controlled heating. Green irradiated diamond changes its color to skin thin yellow or cinnamon brown for some hours at about 500-900 C, but the stone remains radioactive for varying periods of time. For changing some stones to light blue or bluish color electron bombardment in an electron accelerator is carried out. The coloring is skin thin and soon because its radioactivity condition. Also called treatment. → Painted diamond, dyeing, laser drilling, staining, bleaching, heat treatment.

**treated emerald;** some emeralds from Bogotá, Colombia are treated in cedar oil. The treatment of emeralds in cedar oil occurs because the oil has nearly the same refractive index as emerald. Emerald crystals are immersed in hydrochloric acid in a vacuum, after that the stone will be cleaned with acid and subjected to ultrasonic procedure to clean the surface from remaining particles by polishing. Then it is placed in the warm cedar oil, which penetrates the air from spaces, pores, canals, cracks, etc., which improves the color and appearance of the stone.

**treated-irradiation;** lightening color center seen in sapphire from Sri Lanka. → Sapphire color centers.

**treated jade;** artificial pale jadeite dyed green, which looks like an imperial jade, but the color is visible along cracks. In such stones the absorption spectrum exhibits two bands in red. Some pink or purple jade turns its color or is bleached, when heated between 220° to 1000° C. Another technique is immersion of jade in hydrochloric acid to remove brown color due to iron oxide, then impregnation with opticon, a polymer

and by paraffin wax, in trade is known as *grade B-jade*, or *B-jade*. Such stone is readily detectable under microscope. → Jadeite triplet.

**treated opal;** the play-of-color in white or poor quality opal can be improved by cooking of opal in a sugar solution, glucose or a black carbonaceous compound and later treating it with sulfuric acid, which produce a black background due to carbonization of the sugar by low heating. Many white opals from Mexico, and yellowish to grayish opals from Brazil are impregnated with a black plastic to enhance the effect, RI:1.41-1.46. SG:1.85. Other method to treat opal be seen in some pieces of opal, which are placed in cinders, used motor oil is poured over and set fire. Such stones have color like a peculiar mosaic patches, which resemble the structure like oolitic opal.

**treated pearls;** → pearl staining, pearl doctor, dyed pearl, decraqueler.

**treated gemstones;** certain gemstones can be improved or have their color completely altered, or their flaws decimated by means of any sort of controlled heat-treatment. → Stained stone, heat-treated stone, coated stone, irradiation, X-rays, pearl doctor.

**treated turquoise;** frequently natural pale colored turquoises are impregnated with paraffin, oil, glycerin, sodium silicate, or liquid plastic after polishing. A glow needle, which causes the stone to melt and smell or flow.

**treated turquoise;** aniline colored stone can be detected by wiping the surface. Sometimes dyed with Prussian blue.

**treated turquoise;** small pieces of natural turquoise are pressed or bonded together, which have lower specific gravity than true turquoise.

**treatment;** → enhancement, stained stone, heat-treated stone, coated stone, irradiation, X-rays, pearl doctor.

**treatment of marble;** marble has been artificially dyed by the use of a coloring agent such as aniline, or by soaking in a substance or chemical as wax, plastics or paraffin, which caused a coating layer, it is reveal by using a heated needle.

**treatment of mother-of-pearls;** occasionally mother-of-pearls of sea-water and freshwater are soaked in organic materials in various colors to improve the appearance but the colors are unstable. Staining with silver nitrate darkens the color to brown, when exposed to intensive light or X-rays the color changes to black. → Pearl.

**treatment of pearls;** → pearl doctor, pearl skinning, pearl.

**treatment plant;** → recovery plant.

**treatment and recovery plant;** → recovery plant.

**tree agate;** a variety of agate, same as mochastone.

**tree exuding amber;** → exuding tree, amber.

**tree like agate;** → tree agate.

**tree pinfire;** a term used for a pattern similar to tree pinfire. Also called fern.

**tree-ring;** same as conchiolin coral.

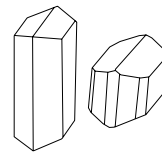
**tree stone;** a variety of agate, same as mochastone.

**trees;** → picture jasper.

**trematode worms;** → cestode worm.

**tremblant;** a French term for ornamental object decorated with flower or other pattern, which is made of gold with inset gemstones such as pendant, brooch, hair ornament, aigrette, etc.

**tremolite;** one of the end members of amphibole group and one of the actinolite series of inosilicates of double chains. Also called *grammatite*. Green and fibrous form is known as *mutton fat* or *nephrite* with greasy luster a variety of jade. *Hexagonite* is a transparent, pink to purple, manganese rich, chatoyant variety found in Ontario, Canada and a variety with weak cat's-eye found in USA. Rarely cut as gems and cabochon, but prized by collectors. Hexagonite is cut as a faceted gem.



tremolite crystals

System: monoclinic.

Formula:  $2[\text{Ca}_2(\text{Mg}, \text{Fe}^{+2})_5(\text{Si}_8\text{O}_{22})(\text{OH}, \text{F})_2]$ . May contain chromium and manganese.

Luster: vitreous.

Colors: colorless, greenish, gray, purple, pink, brown.

Streak: colorless.

Diaphaneity: transparent to translucent.

Cleavage: {110} good.

Fracture: conchoidal to uneven. Brittle.

SG: 2.99-3.2. Specific gravity increased when contains iron.

H: 5-6.

Optics;  $\alpha$ :1.56,  $\beta$ :1.613,  $\gamma$ :1.624. Refractive indices increased when contains iron.

Birefringence: 0.017-0.024. In hexagonite 0.019-0.028.  $\ominus$ .

Dispersion: weak.

Found in Sierra Leone, Myanmar, Tanzania, Austria, Canada, Italy, Switzerland, and USA.

**tremolite absorption spectrum;** frequently some stone shows a line at 437 nm, similar to jadeite.

**tremolite-actinolite;** tremolite-actinolite as inclusion are seen in emeralds from Malagasy, Africa.

**tremolite as an inclusion;** tremolite as inclusion are seen in emeralds from Zimbabwe, Brazil, and Austria.

**tremolite jade;** a term applied for semi-nephrite with the same chemical composition as nephrite, which turned into nephrite under high heat and heavy pressure.

**tremolite pleochroism;** tremolite hexagonite has a

bluish red, deep-red violet pleochroism. Green tanzanite: pale yellowish-green, pale-green and green.

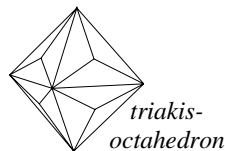
**tremolite luminescence;** tremolite heaxgonite shows orange, pink to pinkish fluorescence under SWUV and LWUV light. Sometimes medium green-white under SWUV.

**Trenton diamond;** a misleading term for quartz crystal from Trenton, Herkimer County, New York, USA.

**treptomorphism;** same as isochemical metamorphism.

**triad axis;** a symmetry axis with repeated rotation of  $120^\circ$ .

**triakis octahedron;** a 24-sided crystal of isometric crystal system, each face is an isosceles triangle. Also called trisoctahedron.



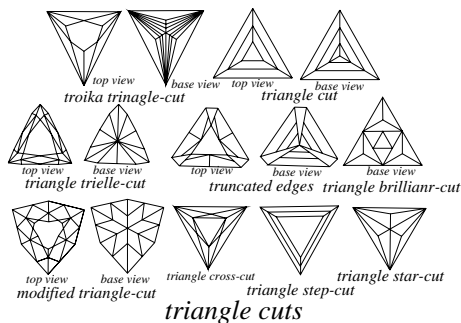
**triakis tetrahedron;** a 12-sided crystal of isometric crystal system, each face is a triangle or quadrilateral. Also called tristetrahedron, trigonal tristetrahedron.

**triamond;** a commercial term for synthetic yttrium aluminum garnet (YAG), used as a diamond imitation.

**triangle;** a commercial term for rough diamond, which is triangular-shaped with pointed corners, may or may not be a macle.

**triangle;** a plane figure bounded by 3-sided rectilinear.

**triangle cut;** usually a fancy 3-sided two or three step cut diamond with 3-sided table. Some are truncated and



not in trap form.

**triangular brilliant cut;** same as trilliant cut.

**triangular modified brilliant cut;** same as trilliant cut.

**Trias;** → Triassic.

**Triassic;** the first period of Mesozoic era of time between 225-295 million years ago with a corresponding system of rocks.

**triboelectric effect;** the emission of light of certain minerals or gemstones produce, when stroked or by friction or mechanical pressure, such as amber, glasses and synthetic resins shows frictional electricity.

**triboelectricity;** same as frictional electricity. → Triboluminescence.

**triboluminescence;** a property observed in some

*tremolite luminescence – triclinic system*

gemstones, when they are scratched or rubbed caused by triboluminescence effect such as by some diamonds.

**Tribunal of God;** → Tezcuco.

**Tribunal of God Emerald;** → Cortez Emerald, Tezcuco.

**tribute;** a term used by Australian opal miners for sharing of produced opal as partnership obligation, usually as a basis when working on another man's area or mine.

**Tribute of the World Spinel;** same as Timur Ruby.

**tributer;** a term used by opal miners for some who working on another man's area or mine. Also spelled tributor. → Tribute.

**tributor;** same as tributer.

**trichites;** inclusions of straight or twisted hair-like or coiled crystalline cavities, which can be seen singly, radially arranged in clusters, or in loose and as mesh-like patterns in some tourmalines or obsidians or glassy igneous rock. Also called thread-like.

**trichopyrite;** same as millerite.

**trichloroethylene;** a colorless, nonflammable, photo-reactive, toxic liquid of  $\text{CH}_2\text{Cl}_2$ , soluble in alcohol and ether, used as a detergent agent. Also called methyl chloroform.

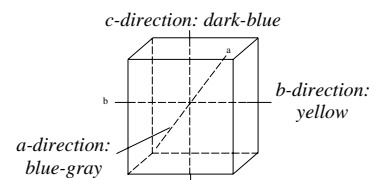
**trichroic;** a gemstone, which displays trichroism.

**trichroic color;** different colors observed in a gemstone.

**trichroic gem;** a gemstone, which display trichroism.

**trichroic stone;** a mineral or gemstone, which display trichroism.

**trichroism;** a transparent gemstone that displays pleochroism, when light is passed through it from



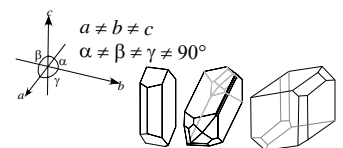
different directions. Also called polychroism, dichroism. → Dichroism.

**triclinic;** same as triclinic system.

**triclinic mineral;** a mineral, which crystallized in the triclinic system.

**triclinic stone;** a mineral, which crystallized in the triclinic system.

**triclinic system;** one of seven crystal systems, which has the lowest symmetry. There are 3 axis, all



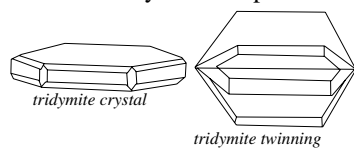
of different lengths inclined toward each other. It has a center of symmetry, but no axes or planes of symmetry, such as albite feldspar.

**Tridacana giga**; pearl-bearing bivalve giant-clam from Indian Ocean of white color and non-nacreous. → Tridacna gigas linné

**Tridacna gigas linné**; the largest and heaviest of the living shelled bivalve mollusk. The pearls are white in color, dull, non-nacreous, often quite large and similar to conch pearl. Found in tropical waters of southwest Pacific and Indian Ocean and Australian coast. Sometimes used as a benitier fir holy-water font. Also known as *giant clam* and misnomered as *man-eating clam*.

**Tridacna pearls**; the peals are of inferior quality similar to conch pearl with a *flame* pattern effect on the surface.

**tridymite**; a colorless or white, high temperature polymorph of silica (SiO<sub>2</sub>) of quartz minerals. Monoclinic system but pseudo-hexagonal symmetry. It



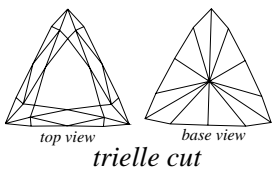
tridymite crystal and twinning

is stable between 870° to 1470° C at normal pressure. SG:2.26. H:7.

Polymorphous with quartz, cristobalite, coesite, and

stichovite. Found as tabular plates cavities of volcanic rocks. Also called christensenite.

**Trielle Cut**; a style of diamond cut developed by



trielle cut

Trillion Diamond Company, New York, USA. It consists of 24 facets and a table on the crown and 12 facts on the pavilion. It has a shield-shaped outline with rounded sides for additional weight retention. Also called trillion cut.

**trig**; a very rarely used term for ornament.

**trigon**; an equilateral triangular growth, or etch figure, which occurs on the surface of octahedral faces of rough diamond crystal.

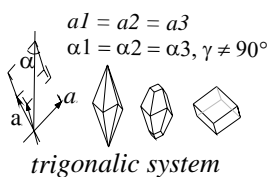
**trigonal**; → trigonal system.

**trigonal crystal**; → trigonal system.

**trigonal mineral**; → trigonal system.

**trigonal stone**; → trigonal system.

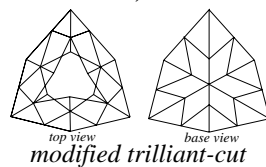
**trigonal system**; a division of the hexagonal system, in which the principal axis is a 3-fold instead of 6-fold symmetry, however it has a lower symmetry than the hexagonal system. Some crystallographers divided



the hexagonal system into two systems. → Rhombohedral system.

**trigonal tristetrahedron**; same as triakis tetrahedron.

**trilliant**; another term for a triangular brilliant cut with cushion-shaped or curved sides and a higher crown with a total of 74 facets, including 30 small facets on the girdle. Used as a solitaire stone.

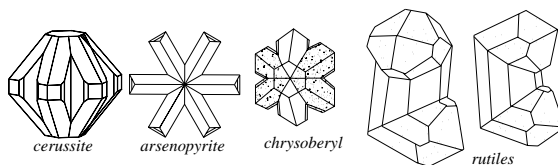


modified trilliant-cut

a modern style of cutting brilliant diamonds of 44 facets, consists of 25 facets on the crown and 18 facets on the pavilion plus culet with a polished rounded triangular girdle.

Developed by Asscher Diamond Company of Amsterdam, Holland. Also called triangular brilliant cut, triangular modified brilliant cut.

**trilling**; a cyclic form of twinning, in which three



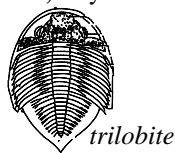
trilling twin of cerussite, chrysoberul and arsenopyrite

crystals are symmetrically intergrowth such as chrysoberyl.

**trillion cut**; same as Trielle Cut.

**trillium**; a commercial term for a fine deep green apatite from Quebec and Ontario, Canada. Used as a gemstone.

**trilobite**; any member of the extinct fossils of marine arthropod of the Trilobita genus from Paleozoic time, characterized by a three-lobed body. Used in jewelry as ornamental and decorative



trilobite

objects. Known as arthropods.

**trimetric system**; another term for orthorhombic system.

**trimming of diamonds**; removing inclusions and other unwanted materials from diamonds, which could cause problems during the cutting of the stone.

**trimorphism**; having the property of crystallizing in three different forms with same chemical compound. → Polymorphism.

**trimorphous**; adjective of trimorphism. → Polymorphism.

**Trinacria**; an old trade Phoenician name for Sicily, Italy. Because of amber trading.

**trinitite**; a strongly radioactive, vesicular, greenish fused silica glass, formed due to intense heat generated by the experimental atomic bomb in New Mexico, USA in 1945. Used as an ornament.

**triolette cut**; a commercial term for modified shield shape cut for diamond or other gemstones. → Incomparable Diamond.

**tripestone**; an intestinal twisted concretionally variety of anhydrite.

**tripestone**; an intestinal twisted concretionally variety of barite.

**tripestone**; a stalactite resembling twisted intestinal.

**triphane**; another term for spodumene.

**triphenylmethane**; → phenolphthalein.

**triphylite**; a rare mineral of serie lithiophilite with formula:  $4[\text{LiMn}(\text{PO}_4)]$  and triphylite with formula:  $4[\text{LiFe}(\text{PO}_4)]$ .

System: orthorhombic.

Formula:  $4[\text{Li}(\text{Fe},\text{Mn})\text{PO}_4]$ .

Luster: resinous, vitreous, greasy.

Colors: greenish gray, blue-gray, gray, yellow, honey yellow, bluish gray, externally brownish black.

Streak: colorless to gray.

Diaphaneity: translucent to transparent.

Cleavage: {001} perfect, {100} distinct, and {010} imperfect.

Fracture: subconchoidal to uneven.

SG: 3.43 to 3.56.

H: 4-5.

Optics:  $\alpha$ :1.688-1.693,  $\beta$ :1.693,  $\gamma$ :1.695-1.702.

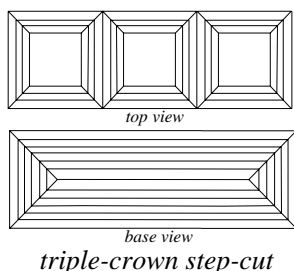
Birefringence: 0.006-0.008. ⊕ or sometimes ⊖.

Found in Brazil, Sweden, Finland, France, and USA.

**triphylite pleochroism**; some pieces show dark-pink, light greenish-yellow and light pink.

**triple A.**; a diamond grading term used by dealers.

**triple-crown step-cut**; a modified fancy cut with four



steps tri-square crowns. The pavilion has six oblong steps.

**triple cut brilliant**; a modified full cut brilliant developed in the 17<sup>th</sup> century from the old single and then double cut brilliant. Also called full cut brilliant.

**triple pearl**; a term applied to a pearl when it is formed of 3 distinct pearls.

**triplet**; a composite stone made of 3 parts. Two portions

the top and bottom bound together by a colored layer to improve the color or cemented with other substance to produce a gem sandwich. When an assembled stone consists of both parts being cut from colored genuine gemstones plus a binding layer this is called a *genuine triplet*. When an assembled stone or composite stone, which is not genuine crystal or simulated crystals cemented together it is known as *false doublet*. If an assembled stone, which may be or may not be genuine crystal or simulated crystal on the crown is cemented or otherwise joined together with a pavilion of another material such as crown this is named as *semi-genuine doublet*. If an assembled stone consists of two pieces of colorless glass or no genuine mineral it is called *imitation triplet*. → Soudé emerald, smaryll, doublet.

**triplet**; → triplet opal.

**triplet**; a composite lens or loupe made of three parts. → Triplet loupe.

**triplet distinguish**; the girdle part of a triplet stone can be seen when the stone immersed and viewed parallel to girdle plane. When joined thin-plane layer revealed while the crown and pavilion appear actually colorless by using magnifier or sometimes with unaided eye with a penlight. Sometimes inclusions are seen in the crown which may be not similar to the pavilion inclusions or do not align properly.

**tripletin**; → tripletine.

**tripletine**; a commercial term for assembled stone made of emerald-colored beryl triplet. In German spelled tripletin.

**tripletine**; a commercial term for triplet made of green-colored imitation stones.

**triplet jade**; a composite stone consisting of three part, which may or may not all, made of true jade.

**triplet lens**; same as triplet loupe.

**triplet loupe**; an assembled magnifying lens system, which consists of three separate lenses, which correct both spherical and chromatic aberration. Also called triplet, triplet lens.

**triplex opal**; a commercial term for an assembled stone of fine play-of-color of *opal triplet* consisting of two pieces of opal, which are covered with a colorless quartz, glass, or synthetic spinel, sapphire, and resin as dome, when cut cabochon it give more brilliancy to the opal. The quartz cover of opal seems a little unreal. → Opal doublet.

**tripoli**; same as rottenstone.

**tripoli powder**; another term for diatomaceous earth.

**tripolite**; a synonym of diatomaceous earth.

**triptych**; an incised pattern composed of 3 parts hinged as a folding window side by side, a central panel and 2 flanking panels half the size of the central panel. Used as pendant and decorative objects.

**Tri-Sakti Diamond;** a blue-white rough diamond of 166.85 cts, found in 1965 on the island Borneo. Cut into a flawless emerald cut brilliant of 50.53 cts, in Amsterdam. Sold to a private buyer in Europe. Tri-Sakti is an Indonesian term it means 3 principles.

**trisazo;** a compound contain three azo groups a sample is acid brown 120.

**triskele;** same as triskelion.

**triskelion;** a jewelry brooch with a motif consisting of 3 parts, sometimes more parts radiate from the center or are arched like three and as falcon heads. Also called triskele.

**trisoctahedron;** same as triakis octahedron.

**tristetrahedron;** same as triakis tetrahedron.

**Tritogonia verrucosa;** fresh-water pearls, which are obtained from the shellfish buckhorn or Tritogonia verrucosa.

**triton pendant;** a form of pendant made from baroque pearl which is similar to human trunk or so-called torso and other parts of human body or other objects are enameled with gold and set with precious stones.

**Trochus niloticus;** member of salt-water shell mollusk with inverted top shaped, hard shell consisted of iridescent mother-of-pearl and horny operculum. Found in tropical



trochus

waters. Used as ornamental such as buttons, and beads. Also called commercial top shell and spelled Trocus.

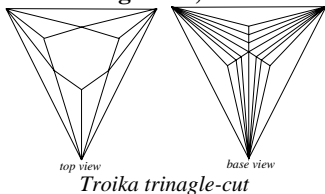
**Trochus shell;** same as top shell.

**Trocus;** another spelling of Trochus niloticus.

**troida cut;** a modern of brilliant cut diamond designed for macles with 47 triangular facets plus a culet. It was developed in Belgium. Also called troida.

**troika triangle;** same as troika triangle cut.

**troika triangle cut;** a modern cut stone consisting of a triangular outline with 9 facets consists of 3-sided triangular and a 6-sided table on crown, and 21 triangular facets on the pavilion. Also



called troika triangle.

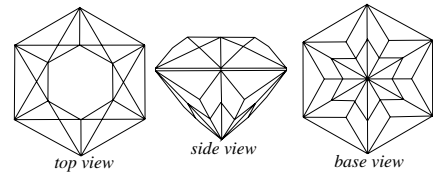
**troilite;** a variety of pyrrhotite (FeS) mineral, which occurs in small hexagonal crystal in meteorites found in the Cañon Diablo, USA, as an associated diamond-troilite. SG:4.67-4.82. H:3½-4½.

**troletul;** a commercial name for polystyrene thermoplastic resin made in Germany.

**trommel;** a cylindrical rotating sieve for sieving diamond-bearing, placers, gravels, crushed ores, or

rocks.

**trophy cut;** a modified faceted brilliant cut for diamond or other gemstones consisting of a six-sided girdle outline with 24 triangular facets forming a six-rayed star and a six-edged table in the crown. Pavilion has 30 triangular facets forming two six-rayed stars which are spreading from top of base to the girdle outline. The



trophy cut with 55 facets

smaller star in inside of larger star.

**Troy's Cathedral Gemstones;** a part of Oratorium of Charlemagne at the Cabinet des Médailles, Paris, France. There are collection of some splendid gemstones and jewels preserved.

**troy weight;** a unit of weight sometimes used for noble metals and gemstones equivalent to 31.1035 grams or 155.517 cts.

**trucker;** a term used by opal miners for a merchandiser who involver with buying and selling of opal.

**true amber;** any natural amber distinguished from treated or imitation amber.

**true amber;** a term was used in the past only for natural amber from Baltic Sea.

**true amber;** scientifically no one fossil resin is a true amber, but some fossil resins may deserve the name *amber* such as succinite, retinite, etc.

**true canary;** an old term for fancy yellow-colored diamond usually of Type Ib, it is to distinguish from yellow stones by a natural cape spectrum.

**true doublet;** two sheets of the same natural gemstone being cemented together, owing a large stone. → Doublet, triplet.

**true jade;** a term used for natural jade. which in Chinese is known as chen yü.

**true marble;** a pale massive crystalline aggregate produced of pre-existing limestone by regional metamorphism process.

**true opal;** frequently seen that a thin fine true opal with flashes spectrum colors grown in nature on potch opal, which is cut and misleadingly named as *opal doublet*, while there is no distinctive join.

**true opal;** a term used by Australian opal miners for bands of opal which are long veins and do not merge into inferior common opal (or do not terminate abruptly), therefore is known as running true.

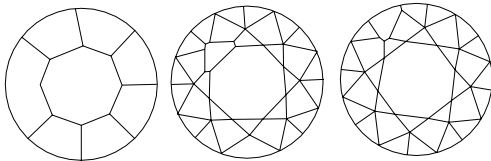
**true pearl;** any natural pearl distinguished from cultured, treated or imitation pearl.

**true star;** a misleading commercial term for a cabochon cut glass with the star effect which imitates star sapphire with the star incised in the bottom.

**true star;** an assembled stone (triplet) composed of synthetic stones cut cabochon and an unpolished backing plastic or other material used to imitate star sapphire, while the parallel lines of star have been engraved upon the foil.

**true topaz;** same as the genuine topaz.

**truncated brilliant-cut;** a series of imperfections of facets on the brilliant-cut stone, occurred by the too-

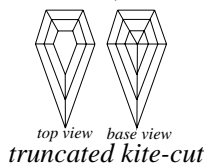


*truncated diamond cut*

rapid cutting and polishing of gem crown, pavilion or girdle. → Fuzzy girdle, feathered girdle, fringed girdle.

**truncated crystal;** break or cutting corner of crystal faces to form a blunt-ended face or facet by which an apex is replaced by a plane section such as eight-corners of a cubic crystal are truncated.

**truncated kite;** a five-sided trap-cut (lozenge cut) stone having an outline of a bull-head or key because an apex of the cut stone is blunted. The stone having a five-sided table. Pavilion has 15 lozenge facets

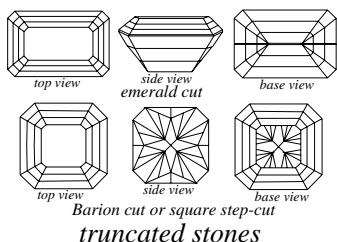


*truncated kite-cut*

without culet. → Kite.

**truing;** correcting any irregularity of abrasive or grinding wheel so that it runs exact or true.

**truncated gemstones;** gemstones, which are blunted at the edges or apex of cut stone.



*truncated stones*

**trumpet etching marks on beryl;** some beryl crystals on the both ends of bipyramid hexagonal showing orientated with the *c*-axis etching figures similar to trumpet. → Bipyramid etch marks on beryl.

**trystine;** same as amethyst-citrine.

**tsan;** a Chinese term for a cicada made of jade. → Chinese ritual and symbol jades.

**Ts'ao Kuo-Chin;** a Chinese term used for a human symbol carved on jade as a patron with cap, beard and fine dress always with a castanets instrument in hand, it is a recent immortal figure. → Chinese ritual and symbol jades.

**Ts'ao Kuo-Chiu;** a recent jade sculpture of the immortals carved in China. It portrays a bearded man with beautiful robes wearing a hat or cap. Always with a pair of clapper-like castanets in hand.

**Ts'ao P'i Heng;** a descriptive Chinese term for a skin red jade.

**Tsar Alexander II emerald;** a dark green emerald of 107.00 cts, allegedly belonged to Tsar Alexander II of Russia. Recently sold to Cartier of New York.

**tsavolite;** another spelling for tsavorite.

**tsavolithe;** another spelling for tsavorite.

**tsavorite;** a transparent, bright green to emerald green variety of grossular garnet colored by chromium and vanadium from Tanzania, and Kenya, Africa. RI:1.734-1.744. SG:3.68. H:6½-7. Also spelled tsavolite, and tsavolithe

**Tschantabun ruby;** another spelling for Chantabun ruby.

**tschermigite;** same as ammonalun.

**Tshibua;** location of a kimberlite diamond mine in Katsha, Zaire, Africa.

**Tshikapa working;** location of alluvial diamond mine and center of rough diamond trading in Western Kasai, Zaire, Africa.

**tsilaisite;** a deep pink to red, manganese-rich variety of elbaite-tourmaline. Trigonal crystal. Formula:  $3[\text{Na}(\text{Mn}, \text{Al})_3\text{Al}_6(\text{Si}_6\text{O}_{18})(\text{BO}_3)_3(\text{OH}, \text{O}, \text{F})_4]$  with up to 9.2% MnO. Optics;  $\omega$ :1.645-1.648,  $\epsilon$ :1.623. Birefringence: 0.023-0.024.  $\ominus$ . → Tourmaline.

**tsie-mu-lu;** a Chinese term were used for emerald. → Emerald,-names of.

**tsu-mu-lu;** a Chinese term were used for emerald. → Emerald,-names of.

**ts'ung ritual jade;** a Chinese term used for an open cylindrical hollow vase? (or tube), whose outer surface is in form of square cross section to symbolize the Earth with yellow color which was placed on the chest of the body in tomb. → Chinese ritual and symbol jades.

**ts'ung-yu;** a Chinese term were used for green colored gemstone and frequently for emerald. → Emerald,-names of.

**tsuni;** a Bengalese term were used for green colored gemstone also for emerald. → Emerald,-names of.

**Tuamotu pearl;** fished pearls from the Tuamotu Island, South Pacific Ocean. The pearls are similar to Tahiti

pearl.

**tube;** → growth tube.

**tube agate;** a variety of agate with inclusions of parallel cavities or tubes, or channels, often filled with running liquid. Also spelled tubular agate.

**tube drill;** a cutting tube for rock drill in geological prospecting, in which the cutting head are set with diamond, and frequently with carbonado.

**tube stalactite;** a conical or cylindrical stalactite hang from ceiling of cave. Also spelled tubular stalactite.

**tubular agate;** same as tube agate.

**tubular stalactite;** same as tube stalactite.

**tufa;** a term used in England for travertine. Also spelled tophus. Not to be confused with *tuff*.

**tuff;** a compacted deposit of consolidated volcanic ash fragments with the grain size of less than 2 mm. Not to be confused with *tufa*. Also called volcanic tuff.

**tugtupite;** a related mineral to sodalite and hackmanite of cyclosilicates. Used as an ornament and cut into cabochon. Also called beryllosodalite and reindeer stone. Tugtup means reindeer.

System: tetragonal.

Formula:  $2[\text{Na}_4\text{AlBeSi}_4\text{O}_{12}\text{Cl}]$ .

Luster: vitreous, greasy.

Colors: light cyclamen, pale pink, rose red, white, greenish, bluish.

Streak: colorless.

Diaphaneity: transparent to translucent.

Cleavage: {111} distincts.

Fracture: conchoidal. Brittle.

SG: 2.30-2.57.

H: 4-6½.

Optics:  $\omega$ :1.496,  $\epsilon$ :1.502.

Birefringence: 0.006-0.008.  $\oplus$  or  $\ominus$ .

Found in Tugtup, Greenland, and Kola peninsula, Russia.

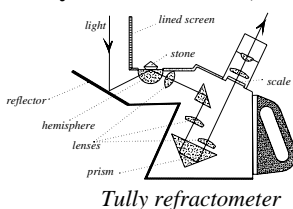
**tugtupite luminescence;** fluorescence in orange and apricot under LWUV and red-pink under SWUV.

**tugtupite pleochroism;** strong pleochroism in orange-red and bluish-red.

**tul;** a commercial term for seed pearl of Ceylonese (Sri Lanka). Also spelled thool.

**tulip;** a modern fancy-shaped cut for gemstones looks like a tulip flower.

**Tully refractometer;** the first table refractometer designed by Bristow G. Tully in 1925 for gem testing. It has a rotateable hemisphere of dense lead glass of high refractive index for the purpose of obtaining



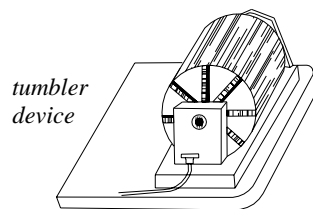
birefringence and a erect scale. → Rayner refractometer, Smith refractometer.

**tumbled stone;** → tumbling.

**tumbler;** a rotating or vibrating drum machine used to polish gemstones without first having been preshaped, into baroque shaped pebbles.

**tumbler;** a rotating or vibrating drum machine used to sift dirt and pebbles from possible gem opals.

**tumbling;** the process of polishing gemstones without first having been preshaped, into irregular, rounded,



baroque shaped pebbles. Large quantities of cheaper stones are tumbled in a rotating or vibrating drum known as

*tumbler*, first with abrasive powder and than with a polishing agent. The process need time and clean materials. Also called barrel polishing.

**tumbling abrasive;** abrasive agents for tumbling device.

**tungsten;** a white or gray, very hard, ductile, malleable metallic element of chromium family in the sixth group of the Periodic System with the symbol W. Also called wolfram.

**tungsten;** an obsolete term for scheelite.

**tungsten;** an obsolete term for wolframite.

**tungsten carbide;** a black hexagonal crystal with gray powder used as abrasive with the chemical formula: WC. SG:15.63. H:9.

**Tunisian coral;** a trade classification for coral from the Mediterranean coast of Tunisian.

**tunnel mining;** the excavating, driving, and creating tunnels to reach the economically importance rocks, minerals, gemstones, etc.

**turbid;** gems or minerals that are not clear or translucent due to containing inclusions such as in some feldspars.

**turbid clouds;** a term used for roughly parallel-zoned arrangement of small particles as inclusions in Kashan synthetic rubies, which appeared similar to turbid clouds found. Also called rain or fog. → Rain-like.

**turbidity in amber;** a commercial grade for translucent to opaque amber. Its approximate opal effect is due to inclusions of minute bubbles. It takes a good polish but is more turbid than fatty amber. Also called cloudy bastard amber.

**turbo;** a sea-snail genus of *Turbo marmoratus* or *Turbo petholatus* mollusks with hard, limy operculum fished from Australian or Indo-China



coast it is used as a source of mother-of-pearl, pearl buttons, imitation



pearls and other objects, which are known as *Antilles pearls* or *oil pearl*. The pearls are detected by yellowish non-nacreous bottom. Also called green snail shell, green turban. → Operculum.

**turbo marmoratus;** → turbo.

**Turbo operculum;** → turbo, operculum.

**turbo pearl;** a member of mollusks with little commercial importance of pearls. Porcelaneous to dark pink color used as a source of mother-of-pearl, pearl buttons, imitation pearls and other objects. → Turbo.

**turbo shell;** → turbo.

**turbo scaife;** a hard scaife for polishing naats or macles, it is harder than conventional scaife.

**turchese;** an Italian term for turquoise.

**turchina;** an Italian term for turquoise.

**turcos;** an Italian term for turquoise.

**turk's head;** a term applied to Brazilian tourmaline with a red end.

**Turkestan Diamond;** same as Star of Persia Diamond.

**Turkestan jade;** a nephrite a variety of jade from Chinese Turkestan.

**Turkestan turquoise;** a turquoise variety from the Russian Federation, CIS, Turkestan.

**Turkey I Diamond;** reportedly a diamond of 140 to 147 cts, which once belonged to Turkish Regalia in 1882. Also known as Ottoman Diamond. Present owner unknown.

**Turkey II Diamond;** same as Kaşıkçı Diamond or Spoon Maker Diamond.

**turkey fat;** a popular local term for yellow smithsonite from Arkansas, USA. Yellow color is caused by greenockite or Cadmium (Cd). Also called turkey fat ore, turkey ore.

**turkey fat ore;** same as turkey fat.

**turkey's nest;** a term used by Australian opal miners for base of a mineshaft where collapsing dirt, timber, etc.

**turkey ore;** same as turkey fat.

**turkey red;** → madder.

**turkey slate;** a fine grained whetstone or honestone or novaculite from Turkey.

**turkey slate;** same as turkey stone.

**turkey stone;** a fine grained silicious rock of hard oilstone from Turkey, used as whetstone. Same as honestone, or novaculite. Also called Turkey slate.

**turkey stone;** same as turquoise.

**turkis;** an Italian term for turquoise.

**turkois;** an Italian term for turquoise.

**turmali;** another spelling for tourmaline.

**turmaline;** another spelling for tourmaline.

**turnbull's blue;** an inorganic blue dye of  $\text{Fe}^{\text{III}}_4\text{Fe}^{\text{II}}(\text{CN}_6)_2$  similar to Prussian blue. Used as color agent for some minerals and as printing dye. Here  $\text{Fe}^{\text{II}}$

ions are surrounded as an octahedron by six carbon ligands, belonging to cyanide  $\text{CN}^-$  groups and  $\text{Fe}^{\text{III}}$  surrounded as an octahedron by six ligands in which some of these six are nitrogen belonging to  $\text{CN}^-$  groups, while others are oxygens belonging to the water of molecules. Similar arrangement can be seen in magnetite  $\text{Fe}_3\text{O}_4$  or  $\text{Fe}^{\text{II}}\text{O}\cdot\text{Fe}^{\text{III}}_2\text{O}_3$ . Also called black iron oxide.

**turning tools, diamond;** → diamond turning tools.

**turpentine;** an oil between gasoline and illuminating oil with formula:  $\text{C}_{10}\text{H}_{16}$ . Used as thinner and mixer of paint mass and for refractive index test RI:1.47.

**turquerenite;** a term applied to the dyed magnetite.

**turquesa;** a Spanish term for turquoise.

**turqueza;** a Portuguese term for turquoise.

**turquoise;** a commercial term for imitation turquoise made of reconstructed pieces of turquoise.

**turquois;** another spelling for turquoise.

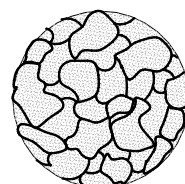
**turquoise;** an isomorphous mineral with chalcociderite.



turquoise crystal

Generally cut cabochon gemstone but frequently are faceted or engraved. Often has an attractive blue, or sky-blue color of fine-quality. A matrix of turquoise with minute

grains of turquoise speckled in it is called *rock turquoise*. Turquoise matrix, which includes inferior turquoise is named as *new rock turquoise*. A network of fine black-brown veins of metallic oxides normally limonite, which look like a mosaic at the surface of turquoise is known as *spiderweb turquoise* or *Persian spiderweb*. fine-quality turquoise with permanent color is known as *old rock turquoise*. The fine sky-blue variety of turquoise from USA locally is known as *robin's egg blue*. North American turquoise is more porous and therefore paler than Persian stone. In Egypt the ancient turquoise was mined 2000 BC, it was called *majkaat*.



turquoise mosaic ring

*Duklij* was an old name for turquoise by the Apache Indians and by Mexican Indian as *chalchihuitl*. The stone is porous but takes high polish. Turquoise fluoresce under LWUV light from greenish-yellow to light blue and inert under SWUV light or X-rays. Some pieces lose color if exposed to daylight but that is temporary and can be restored. Dyed stones are detectable by scratch or by placing a drop of ammonia on the stone surface, which will turning the stone greenish. Sometimes particles of true turquoise are *bonded* together with a resin or

synthetic plastic, which is named as *reconstructed turquoise*. Occurs as reniform with botryoidal mass. Occasionally is misnomered the term turquoise such as *sacred turquoise*, which is a light blue smithsonite. Imitations are made from sodalite, haüyne, lazulite, variscite, prosopite, and wardite. Soaked or dyed imitation stones are plaster of Paris, glass, howlite, chalcedony, and odontolite of organic origin. Sometimes gibbsite is coated with plastic to imitate turquoise and added pyrite as inclusions and apparent dendritic matrix is known as *coated gibbsite*. There are also turquoise imitation made of plastics. Also called calaite, turkey stone. Also spelled turquois. Varieties are: chalcocite, faustite, rashleighite, chalcocite, which also is spelled chalchuite. → Synthetic turquoise, Viennese turquoise, Persian matrix.

System: triclinic, cryptocrystalline.

Formula:  $[\text{CuAl}_6(\text{PO}_4)_4(\text{OH})_8 \cdot 5\text{H}_2\text{O}]$ . Containing Fe.

Luster: vitreous, greasy, waxy, dull.

Colors: sky-blue, pale-blue, greenish-blue, grayish-green, apple-green. Sometimes veined with limonite matrix.

Streak: colorless.

Diaphaneity: subtranslucent to opaque.

Cleavage: {001} perfect, and {010} good.

Fracture: conchoidal, even to smooth.

SG: From Iran: 2.750-2.850, China: 2.70, USA: 2.60-2.70, Brazil: 2.40-2.65, Israel: 2.56-2.70, Tibet: 2.72.

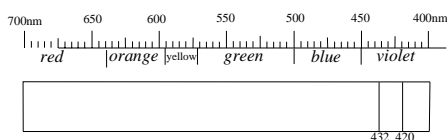
H: 5½-6.

Optics:  $\alpha$ :1.610,  $\beta$ :1.620,  $\gamma$ :1.650. Massive variety by distant vision of 1.620.

Birefringence: 0.040. ⊕.

Found in Nishapur (Iran), Australia, Arizona and Nevada (USA), Eilat (Israel), Tibet, Bahia (Brazil), Zacatecas (Mexico), China, and Sinai Peninsula (Egypt).

**turquoise absorption spectrum;** a band at 460 nm and two lines at 432 and 420 nm in violet difficulty to seen.



*turquoise absorption spectrum*

Also a very weak band is seen at 460 nm.

**turquoise, American;** turquoise from Stormy Mountain Mine and Fox Mine in Nevada, Kingman and Bisbee in Arizona, Santa Rita in New Mexico, and Leadville in Colorado, USA. American turquoise is more porous and therefore paler than Persian stone.

**turquoise bonded;** particles of true turquoise are

bonded together with a resin or synthetic plastic, which is named as reconstructed turquoise. → Turquoise, imitation turquoise.

**turquoise classification in Iran;** turquoises from Nishapur are divided in three classes: (a) *angoshtari*, a Farsi or Persian term meaning stone for finger ring which is a sky blue turquoise without dendrite (matrix). (b) *barkhaneh*, a Farsi or Persian term meaning sandy stone (size) of intermediate quality, sky-blue dendritic turquoise, from Khorassan, in NE Iran, which is divided into four categories, mostly used for inlaying and incrusting jewelry, *bazu band* (armlets), trappings, water-pipe, etc. Another spelling is barchaneh, barkhan or barchane. (c) *arabi*, a Farsi or Persian term for pale colored, patched, or dendritic turquoise. (d) *shirbu* or *shirfam*, a Farsi or Persian term meaning milky of whitish color. (e) *chagaleh*, a Farsi or Persian term meaning unripe, turquoise with white crust. (f) *tofal* (literarily topal) a Farsi or Persian term meaning metal or metallic, large, flat, slab-like pieces of turquoise used for setting in metal such as bracelets, bazu-bands, amulets, etc. (g) *goleh-kasni*, a Farsi or Persian term meaning dandelion, stones of greenish color mostly bought by Afghans.

**turquoise classifications in Nishapur, Iran;** turquoises from Nishapur are divided according to its different sources into different qualities by mine owner as: (a) *Abu-Eshaghi*, have fine dark color with high brilliant and quasi pure. (b) *Azhari*, fine and dark color but not like Abu-Eshaghi. (c) *Soleimani*, blue but slightly milky. (d) *Zarmuni*, contain golden spots of pyrite with less brilliance. (e) *Khaki*, sky-blue colored. (f) *Abdul-Madjidi*, fine dark color but not pure and soft. (g) *Andelibi*, milky but lesser than Soliemani. (h) *abrash*, a Farsi term for mottled or stone with two colors. (i) *Sadja*, a jeweler term for smeared turquoise with butter, become darker color but the color is only temporary, also called *massiha* and *mescha*. (j) *tarmalah* (literarily means impure or despised, may be derived from *damalah* for cabochon), turquoises furrowed by other stones which are used as decoration. Beside of classification of turquoise mentioned above there are other two degrees because of their age: (I) *old rock* by which the color and luster not change. (II) *new rock* by which the color and luster change soon.

**turquoise cut;** generally cut cabochon gemstone often with brown to black matrix but frequently faceted, some flat stones are engraved, or used in inlay work and tumbled. Cut as pendants, brooches suitable in pavé setting. It takes a high polish.

**turquoise cut in Iran;** there are five kinds of cut in Iran mostly of which are cut in Meshed: (a) most popular is *pikani* (mean pointed), or high cabochon. (b) *arabi* (mean flat stone, in Arabic: mossatah), cut-form

preferred by Arabs. (c) *pakh-dar* (mean faceted), stone with facets. (d) *kandeh-kari* (mean engraved) mostly engraved stones are provided with poesy, religious aphorisms or figures. (e) *khagi* or *tokhom-morghhi* (mean egg-shaped).

**turquoise doublet;** a misleading term for a type of composite stone, in which the crown of a cabochon of turquoise-colored opalified glass is cemented to the bottom of blue-colored chalcedony, or other suitable material. Frequently the cabochon is made of bone.

**turquoise, Egyptian;** same as Egyptian turquoise.

**turquoise-faustite;** a zinc-rich member of the turquoise group. → Faustite.

**turquoise, imitation;** → turquoise, imitation turquoise.

**turquoise imitation in Iran;** kind of turquoise imitations made Iran are: (a) *Maadjun-e-chini*, a term meaning Chinese paste, which used in Iran for false turquoise, Also called *boreizeh*. (b) Glass paste of green or blue color, *shisha*. (c) Hard green stone composed of copper component and other minerals, *sange-sakhat*, a term meaning hard stone.

**turquoise luminescence;** blue to greenish-yellow under LWUV.

**turquoise matrix;** turquoise with brown to black veined limonite matrix or dark gray sandstone, which is cut cabochon to provide color and patterns. Sometimes called turtle back.

**turquoise mines of Nishabur, Iran;** turquoise mined in Nishabur from several shafts, galleries and cavities with names: Abdulrazzaghi (or Abu Eshaghi the oldest mine), Maleki, upper and lower Zaki, Mirza Ahmadi, Abdul Karim, etc. See Manutchehr-Danai (1977).

**turquoise mining of Nishabur, Iran;** turquoise is mined in two kinds: (a) mining through shafts and galleries in underground in the solid rock, (b) the *Khaki* mines that mean digging in the detritus of rock washed down toward the bottom of valley.

**turquoise, name of;** generally in all European language supposed that the name of turquoise is derived from the name of Turkey. For author it is not an evident because of the name of another turquoise locality of Iran in Khorassan near the formerly city Turshiz (mentioned by Pogue, pp.39, 1915) now Torbat-Hydariéh. In the past mostly turquoise from other mines of Khorassan, was merchandized in this city and resembling of the names Turkey and Turshiz must be believed or mislabeled as stone of Turkey?

**turquoise occurrence;** → turquoise.

**turquoise, neolite;** → neolite.

**turquoise pleochroism;** weak in colors, light blue, light green and colorless.

**turquoise, Persian;** → Persian turquoise.

**turquoise, pressed;** → pressed turquoise.

**Turquoise Roof Bridge;** an old term used in Tibet for a family thrived turquoise trade during the eight century whose name meaning Turquoise Roof, because the house of this family is near a bridge in Lhasa called Turquoise Roof Bridge.

**turquoise, stained;** some pieces of turquoise lose their color if exposed to daylight it can be restored temporary by soaking in ammonia. Pale colored stones can be dyed with Prussian blue, which is distinguished by scratching or by a drop of ammonia on the stone surface, which turns it greenish. Aniline colored stones can be detected by wiping the surface with an acetone moistened cotton. Sometimes, when a stone loses its color, the origin color will be regained when the turquoise is soaked in uric acid or water.

**turquoise, synthetic;** → synthetic turquoise.

**turquoise, variation of;** an old variation of turquoise: (a) johnite, a vitreous scaly variety. (b) Agaphite, a vitreous variety of Persian turquoise from Nishapur, Iran. (c) Calaité, a mammillary or botryoidal variety of turquoise. → Turquoise, variation of.

**turquoise, waxed;** → waxed turquoise.

**turquoise, Viennese;** a misleading term for imitation turquoise, which is made by pressing aluminum phosphate powder dyed with copper oleate. → Vienna turquoise.

**turritella;** a fossilized spiral shell of marine gastropod, which is replaced by silica in a deep brown groundmass. Found in Utah, Colorado, Wyoming, USA. Used as an ornamental stone.

**turritella agate;** a variety of agate consisting of orbicular fossilized turritella shells from Utah, Colorado, Wyoming, USA. Used as ornamental objects and polished by tumbling.

**turritella jasper;** same as turritella agate.

**turtle back;** same as turquoise matrix.

**turtle back;** a fibrous green variety of chlorastrolite with harlequin-like patches, cut cabochon.

**turtle back;** same as variscite matrix.

**turtle back;** same as turtle-back shaped pearl.

**turtle-back pearl;** a commercial term for a fresh-water pearl of irregular shape like a turtle's shell.

**turtle-back pearl;** a variety of Rounded pearls from turtle back clam.

**turtle-back pearl;** an oval-shaped blister pearl like a high dome.

**turtle stone;** same as septartium.

**Tuscany Diamond;** same as Florentine Diamond.

**Tushan-jade;** a misleading term used for mixture of albite and zoisite from China.

**Tushan-jade;** a misleading term used for mixture of diopside and anorthite from China.

**tusk turquoise;** same as odontolite.

**tut**; a short spelling for ockamatutt used in England for a special glue applied by jet worker when the piece is small to hold with hand.

**tutae kiori**; a Maori term for a common poor-quality of nephrite a variety of jade from New Zealand. → Pounamu.

**Tuticorin pearl**; pearls from Tuticorin along the coast of Madras, India. Similar to Sri Lanka pearl.

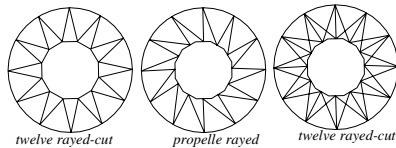
**tuxtlite**; a pea-green, massive variety of jadeite of clinopyroxene, which is an intermediate between jadeite and diopside of  $\text{NaCaMgAlSi}_4\text{O}_{12}$ . Monoclinic system. It is a principal component of mayaite. Found in Tuxtla, Mexico. Used as an ornamental objects. Also called diopside jadeite. → Mayaite.

**TV stone**; same as television stone or ulexite.

**Tweepad**; location of alluvial diamond deposits in Buffels Marine Complex, on the Atlantic coast, South Africa.

**tweezers**; any small metal pincers or tongs used for quick picking up and handling gemstones. Made from steel, iron or other materials with two short handles and two jaws by a pivot. Different varieties are available such as spring-loaded, locking and retractable prong model. → Pearl tongs, corn tongs, tongs.

**twelve rayed-cut**; a modified faceted brilliant cut for diamond or other gemstones consisting of a round girdle outline with 24 (or sometimes 48 facets),



twelve rayed-cuts

triangular facets with a twelve-rayed star spread from table to girdle and twelve-sided table.

**twelve terrestrial branches**; a Chinese term used for twelve signs of zodiac. → Chinese ritual and symbol jades.

**Twentieth-Century Cut**; a modified brilliant-cut diamond with totally 80 facets, which is similar to the Jubilee cut, and the table is replaced by the extension of the eight star facets.

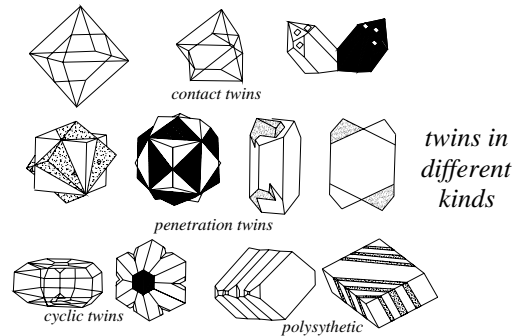
**twin**; a term equivalent with twin crystal. Also called macle.

**twin axis**; a crystal axis of twinned crystal normally at about right angles one part of a twin crystal may be rotated normally at  $180^\circ$ .

**twin colors**; a sure sign for double refractive stones such as aquamarine, dichroite, etc.

**twin crystal**; a composite crystal made of two or more individual crystals of the same mineral, which are

oriented differently but are related to one other, either by rotation about a certain axis through  $180^\circ$  or by



reflection across a plane of symmetry, or by inversion. There are three kinds of twins: contact twins or interpenetration twins, polysynthetic twins or repeated twins, and rotation twins. Also called twinned crystal, geminate crystal, macle.

**twinkle**; a term used by opal miners for a feature of minute star-like colors, which are similar to a scattered pinfire.

**twinned crystal**; same as twin crystal.

**twined pearl**; another term for double pearl.

**twinkling**; an optical phenomenon, which can be seen in plane polarized light, when differences of refractive index of a thin section of an anisotropic gemstone are sufficiently large enough, when the stage turns rapidly and causes the change of relief.

**twinklones**; a Myanmar (Burmese) term for small rounded holes sinking down to the alluvial gem-bearing stratum of *byon* for mining rubies or sapphires, also used for mining amber, in Myanmar.

**twinning**; in crystallography the act of twin crystal caused by intergrowth, transformation, or gilding according to a twin law.

**twinning**; parallel lines occurs on the surface of a crystal, which are also called twinning striations.

**twinning, contact**; → contact twinning.

**twinning in amethyst**; those natural amethysts, which under a microscope shows interference, color pattern due to Brazil twinning but in synthetic amethyst, the successive broad color bands are seen. → Quartz.

**twinning in aragonite**; aragonite twinned usually in form of pseudo-hexagonal prisms.

**twinning in cassiterite**; cassiterite frequently twinned plane parallel to one of the pyramid faces in elbow-shaped (knee-shaped) with a characteristic notch is known as geniculate twins. → Cassiterite.

**twinning in chrysoberyl**; chrysoberyl commonly twinned as pseudo-hexagonal as *trilling*, also known as *cyclic twins*, or *flowers twins*. → Chrysoberyl.

**twinning in corundum**; corundum twinned as polysynthetic along rhombohedron on  $\{1011\}$ , and

{0001}. → Corundum.

**twinning in corundum, synthetic;** → twinning in corundum.

**twinning in diamond;** diamond twinned on {111} like spinel law, usually flattened parallel to the twin plane.

**twinning in feldspar;** feldspar twinned commonly as Carlsbad, Manebach, and Baveno, which are twinned according to the pericline law with the twin axis [010], and albite law with the twin plane {010}, or polysynthetic twinning on {010} in albite. → Feldspar.

**twinning in fluorite;** fluorite often twinned as penetration twins on [111]. Also called interpenetration twins. → Fluorite.

**twinning in gypsum;** gypsum twinned common on {100} or in form of swallowtail twins. This type of gypsum is prized by collectors but not for ornamental purposes. → Gypsum.

**twinning plane;** same as twin plane.

**twinning in quartz;** twins according to different laws, are very frequent in three types; Dauphiné twins, Brazilian twins, and Japanese twins. → Quartz.

**twinning in ruby;** → twinning in corundum.

**twinning in rutile;** often twinned in elbow-shaped or knee-shaped forms, sometimes repeated with twin plane {011}, which known as geniculate twins. → Rutile.

**twinning in spinel;** spinel twinned in contact twin form or spinel twin. → Spinel twin.

**twinning in staurolite;** staurolite twinned as interpenetrant in cruciform with twin plane {031} at 90° and twin plane {231} at 60°, which is known as *fairy stone* or called *cross stone*. Frequently both twins are combined in one group. Twinned crystals of staurolite are cleaned and polished as charms, amulets, rosaries, and cut gems. → Staurolite.

**twinning in synthetic amethyst;** → twinning in amethyst, quartz.

**twinning, internal;** such as in diamond twinned internally as a mirror image.

**twinning, interpenetrant;** → interpenetration twins.

**twinning in zircon;** zircon twinned in contact twin form of the pyramid faces in elbow-shape, which are known as geniculate twins. → Zircon.

**twinning, laminae;** separable plates, sheets or layers in crystals, usually, but not always, of repeated or polysynthetic twinning.

**twinning lines;** a term used by cutters for the visible twinning lines within or on a diamond crystal, which are caused by twinning in diamond.

**twinning, repeated;** → repeated twinning.

**twinning star;** a twin form rarely seen in diamonds where a six point star-shaped stone is alternatively below and above the central plane.

**twinning striations;** → twinning.

**twinning, synthetic;** twinning can be seen in synthetic stones as can be seen in natural stones. → Polysynthetic twinning.

**twinning wisp;** same as graining, grain lines.

**twin pearl;** another term for double pearl.

**twin plane;** a common plane of symmetry, which divides twinned crystals, which are symmetrically arranged or reflected, such as a mirror image of the other. Also called twinning plane.

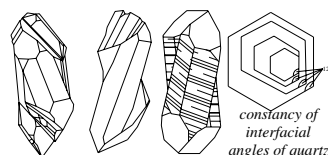
**twin, spinel;** on the plane of the octahedral face producing flattened triangular contact twin.

**twins;** a semi-acronym used by miners for twinlones.

**twins;** a plural term applied for twin.

**twin stone;** another term for staurolite.

**twisted (crystal);** the act of deformation of a crystal,



*twisted or distorted quartz*

when its shape is twisted out, so that the angles between its crystal faces may differ widely from those on the regular form. Also called

strained crystal.

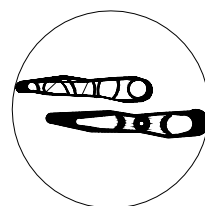
**two color pearl;** natural pearl with two colors used in jewelry, but not for necklace. Also called two colored pearl.

**two colored pearl;** same as two color pearl.

**two grainer;** diamonds, weighing two fourths of a carat.

**two piece opal;** same as opal doublet.

**two phase inclusions;** an angular or long stretched

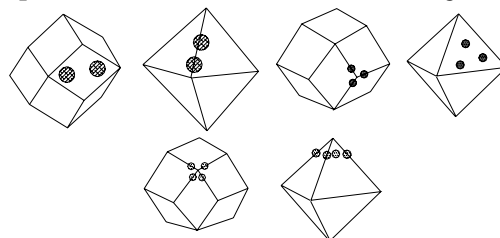


*typical two-phase, bubbles filled with liquid in Sri Lanka sapphire*

cavity filled with a moveable liquid, and gas bubble in the liquid in a crystal or gem mineral. → Inclusions,

three-phase inclusions.

**two-point diamond;** orientation of cutting diamond



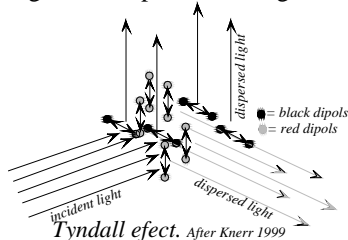
*situation of two, three and four point on octahedron and dodecahedron diamond crystals*

with a table parallel to a dodecahedral face, which has two directions for polishing. → Diamond point.

**two-point diamond;** diamond weighing 0.02 carat.

**Tylos;** ancient name for Isle Bahrain in Persian Gulf.

**Tyndall effect;** the bluish visible scattering of light of extremely small particles of matter along the path of light as it passes through a medium containing the



particles, such as particles of dust floating in the air of a room. Blue light beam is much more strongly scattered than red light

beam in the same medium. This effect caused the milky opalescence phenomenon in some moonstones, chalcedony and in opals or in some glasses. It is responsible for some bluish hues seen in some gemstones, when the light is reflected. This effect is utilized in the ultra-microscope.

**type-A ruby;** a Siamese term used for ploy daeng, a classification of ruby used in Thailand for red stone, which has slightly purplish or brown color. → Ruby colors terminology in Thai, some.

**Type-A sapphire;** a Siamese term used for classification of sapphire used in Thailand for a rich royal blue color to violet but darker than type-c. → Sapphire colors terminology in Thai, some.

**Type-B ruby;** a Siamese term used for daeng chompoo, a classification of ruby used in Thailand for pinkish red stone, which has pinkish red to orangey color. → Ruby colors terminology in Thai, some.

**Type-B sapphire;** a Siamese term used for classification of sapphire used in Thailand for a rich royal blue color but slightly silky or milky. → Sapphire colors terminology in Thai, some.

**Type-C ruby;** a Siamese term used for daeng som, a classification of ruby used in Thailand for orangey red stone, which has slightly orangey red color. → Ruby colors terminology in Thai, some.

**Type-C sapphire;** a Siamese term used for classification of sapphire used in Thailand for a cornflower-blue but lighter than type-A. → Sapphire colors terminology in Thai, some.

**Type-D ruby;** a Siamese term used for daeng dum, a classification of ruby used in Thailand for blackish red stone, which has pure red color on the brilliant areas and blackish on extinction areas. → Ruby colors terminology in Thai, some.

**Type-D sapphire;** a Siamese term used for classification of sapphire used in Thailand for a very dark inky blue. → Sapphire colors terminology in Thai, some.

**Type-E ruby;** a Siamese term used for classification of ruby used in Thailand for pink to purplish red but more purplish than Type-B. → Ruby colors terminology in Thai, some.

**Type-H sapphire;** a Siamese term used for classification of sapphire used in Thailand for a pure yellow sapphire without greenish or brownish of Sri Lankan-type. → Sapphire colors terminology in Thai, some.

**Types I diamonds;** diamonds of Type I or normal are transparent only to about 300 nm and contained free nitrogen as a constant impurity shown to account for many of the absorption bands in the infra-red and ultraviolet light. Diamond Type I has been divided into two sections: *Type Ia*, in which the nitrogen has platelets, and *Type Ib* the nitrogen is dispersed into a substitutional site in a paramagnetic form.

**Type Ia diamonds;** most common type of diamonds are Type Ia containing platelet aggregates of nitrogen as a constant impurity, which shows a dark line at 415 nm and are nonconductive of electricity due to the presence of aluminum. This type of diamond can be seen in most light yellow diamonds. Frequently subdivided in three Type IaA, Type IaB, and Type IaAB. These are distinguished by differences in infrared spectrum caused by differences in nitrogen arrangement.

**Type Ib diamonds;** in Type Ib diamonds, the nitrogen is dispersed in substitutional sites in a paramagnetic form. This type of diamonds are a small percentage of true diamonds, while the color is darker yellow (Cape series) than Type Ia diamonds. The yellow color is due to absorption of light at the violet end of the spectrum, which causes yellow body color of stones by presence of nitrogen. All synthetic diamonds of yellow color contain nitrogen as Type Ib. Also called canary diamond, or *true canary diamond*. → Transparency to UV light of diamond.

**Types II diamonds;** Type II Diamonds are more transparent to ultraviolet light to about 225 nm. Rare types have been subdivided into Types IIa and IIb based on differences in phosphorescent behavior.

**Type IIa diamonds;** the diamonds of Type IIa are rare and contain no nitrogen or boron. Usually colorless but frequently bluish-green, brown, or violet. Inert under SWUV light. They are nonconductive of electricity but heat conductive. Used in electronic industry as heat sinks.

**Type IIb diamonds;** Type IIb diamonds are very rare containing boron, usually have natural blue body color. Bluish phosphorescence under SWUV light and conductive of electricity due to presence of boron. Frequently afterglow in red. Extremely sensitive to heat, used to measure temperature within 0.002° C.

**Type III diamonds;** same as lonsdaleite.

**Type-K sapphire;** a Siamese term used for classification of sapphire used in Thailand for a dark-yellow orange sapphire with brownish overtone. →

Sapphire colors terminology in Thai, some.

**Type-L sapphire;** a Siamese term used for classification of sapphire used in Thailand for a greenish yellow sapphire without brownish overtone like type-k. → Sapphire colors terminology in Thai, some.

**Types of diamond;** → Type I diamonds, Type Ia diamonds, Type Ib diamonds, Type II diamonds, Type IIa diamonds, Type IIb diamonds, Type III diamond.

**types of glass;** glass is generally divided in two categories: (a) crown glasses, which containing silica, soda, potash, and lime. (b) Flint glasses, which consisting of silica, soda, potash, and lead oxide.

**types of opal;** → opal.

**typomorphic mineral;** same as zone mineral. Also called zonal mineral.

**tyrian purple;** an ancient vivid purplish-red dye from the city of Tyre. A crimson purple colorant of  $C_{16}H_8Br_2N_2O_2$  of indigo class obtained from the adrectal gland of a gastropod mollusks (with the name *Murex brandaris*), or produced synthetically. Naturally produced dye is very expensive because from 10.000 shellfish can obtain only one gram colorant. It is white, which turns to a reddish-purple on oxidation by exposure to air. Used by Greeks and Romans as dye. Also called dibromoindigo. → *Murex purpura haemestoma*.

**Tyrol;** a part of Austria and locality of some gem minerals.

**Tyrolese onyx;** a local misnomer for semitranslucent orange veined onyx marble from Tyrol, Austria. Cut and carved as small objects for tourist souvenirs.

# U u

**U**; a chemical symbol for the element uranium.

**Ubangi**; two diamond districts of Central African Republic: West Oubangui, and East Oubangui

**ubiquitous mineral**; a mineral occurring in any deep zones of metamorphic rocks.

**uda**; a term used in Hindu for glazed pottery containing purple to brown pigments in ceramic decoration.

**Udachnaya mine**; a town and location of kimberlite diamond pipe deposits on the Arctic Circle in Sakha (Yakutia), the Russian Federation, CIS. Also called Polyarnyi.

**Udaipur**; beryl of fine green color from Kaliguman near Udaipur, India. It occurs in bands of biotite-schist.

**ugandite**; a rock of extrusive origin consisting of leucite, augite, and olivine in a soda-rich glassy matrix.

**ugrandite garnet**; a combination of name used for isomorphous series of calcium garnet minerals consisting of uvarovite, grossular, and andradite. → Pyralspite.

**ugrandite group**; an isomorphous intermediate group of uvarovite-grossularite-andradite garnet. → Garnets.

**uhligite**; an old term applied to an amorphous variscite or fischerite.

**uhligite**; a black mineral consisting of titanate, zirconate of aluminum and calcium.

**uigite**; a banded, silky luster variety of chlorastrolite from Uig on the Isle of Skye in the Hebrides, NW Scotland. It relates to prehnite. Cut cabochon.

**uintaite**; a jet-black, brilliant variety of natural asphalt found in Uinta Valley, Utah, USA. Brown streak. Conchoidal fracture. Brittle. SG:1.065-1.070. H:2-2½. Used as a jet imitation. Also called gilsonite and spelled uintahite.

**uintahite**; same as uintaite.

**Uitgevonden**; location of alluvial diamond mines in Lichtenburg area, Transvaal Province, South Africa.

**Uitkyk**; location of alluvial diamond deposits in Bloemhof area, Transvaal Province, South Africa.

**ulexite**; a fibrous and reniform mineral of borate, calcium, and sodium. When it is cut cabochon with the fibers at right angles this create a cat's-eye effects. It is very soft and fragile. Cut and polished stone of ulexite is called *television stone*, TV stone, also known as cotton ball, boronatrocalcite, natroborocalcite.

System: triclinic.

Formula:  $2[\text{NaCaB}_5\text{O}_6(\text{OH})_6 \cdot 5\text{H}_2\text{O}]$ .

Luster: vitreous to silky, sometimes chatoyant.

Colors: colorless, white.

Streak: colorless.

Diaphaneity: transparent to translucent.

Cleavage: {010} perfect, and {110} good.

Fracture: conchoidal to uneven. Brittle.

SG: 1.65-1.96.

H: 2½.

Optics:  $\alpha$ :1.496,  $\beta$ :1.505,  $\gamma$ :1.519.

Birefringence: 0.023. ⊕.

Found in Russia, Argentina, Peru, USA, and Chile.

**ulexite cut**; takes a good polish. Frequently cut cabochon for cat's-eye effect, or into spheres.

**ulexite luminescence**; it becomes fluorescent green and blue under SWUV light, sometimes together with phosphorescence.

**ultimate lines in spectra**; those rays with the name *raies ultimes* that lie mostly in the UV part of the spectrum almost to vanishing point. Those raies, which are often found in the visible region of the spectrum are named *raies sensibles*.

**ultra**; a prefix for beyond.

**ultrabasic**; same as ultrabasic rock.

**ultrabasic**; a term applied to diaphorite, a gray-black  $\text{Pb}_2\text{Ag}_3\text{Sb}_3\text{S}_8$ . Orthorhombic crystal.

**ultrabasic rock**; a type of igneous rock characterized by very low or no silica (less than 45%) but rich in iron, magnesium, and frequently alumina. This term is occasionally used interchangeably with ultramafic but should be abandoned. Also spelled ultrabasic. → Ultramafic.

**ultra-fine grain**; finest grain.

**ultralite**; a commercial term for synthetic corundum of red-violet color.

**ultramafic**; a type of igneous rock characterized by a high content of mafic minerals, particularly olivine, pyroxenes, amphiboles, etc. The silica content is less than 45%. → Ultrabasic rock.

**ultramafic rock**; same as ultramafic.

**ultramafite**; a type of ultramafic rock.

**ultramarine**; a synonym for powdered lapis lazuli.

**ultramarine**; an artificial form of lazurite.

**ultramarine pigment**; a blue durable pigment obtained from powdered lapis lazuli.

**ultrametamorphic rock**; rock that has undergone ultrametamorphism.

**ultrametamorphism**; highest grade of metamorphism. Forming under extremely high temperatures and pressures resulting short of actually melting into magma.

**ultramicroscope**; a magnifying device for investigating particles, which are smaller than those resolved by



ordinary microscopes such as smoke.

**ultra short-waves;** electromagnetic wavelength less than 10 meter.

**ultrasonic agitation;** → ultrasonic cleaning.

**ultrasonic cleaning;** a device for cleaning dirt and other foreign particles from gemstones and jewelry articles by subjecting them to ultrasonic vibrations immersed in water or other solvent. The articles must be free of stress flaws. Glass lenses and other bodies can be polished by this method. An ultrasonic bath consisting of a piezoelectric transducer and a container for fluids, which works at frequencies in range of 50,000 to 100,000 Hz. Beyond the limits of hearing of the human ear.

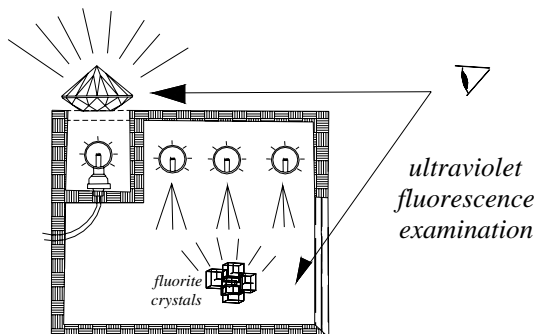
**ultraviolet;** → ultraviolet radiation.

**ultraviolet absorption;** when ultraviolet light transmit through a colored gemstone, due to colored sample certain wavelengths are absorbed more strongly than others. When the spectrum is passed through the medium into a testing spectroscope, the colors most strongly absorbed may show as dark bands or finer lines

**ultraviolet absorption of ruby;** corundum shows a chalky-yellow to bluish-white zonal pattern under LWUV light, under SWUV shows a chalky-red to orange fluorescence.

**ultraviolet absorption spectroscopy;** the absorption spectrum in ultraviolet light. → Absorption spectrum.

**ultraviolet fluorescence;** ultraviolet radiation can be visible to the eye by exciting fluorescence effect in gemstones under SWUV or LWUV light. In some gemstones or diamonds this may be blue, yellow, green



or orange colors. Ultraviolet fluorescence lamps or tubes are made with a medium pressure like normal working lighting in use. Ultraviolet fluorescence lamps with a low pressure and mercury vapor emit a bright visible SWUV light using an electrical discharge. The insides of such lamps are coated with a highly fluorescing powder, which glows but harmful radiation is not transmitted, because the tubes are made from a special glass. The range of emitted UV light is from

400 to 300 nm, SWUV light and mostly visible light is absorbed. In trade such lamps are known as long wave fluorescent ultraviolet lamp.

**ultraviolet fluorescence lamps;** → ultraviolet fluorescence.

**ultraviolet glass;** glasses with low iron oxide or titanium oxide and rich in boric oxide and silica, which permit the ultraviolet light to pass through.

**ultraviolet lamp;** a mercury discharged lamp in a quartz glass designed to produce ultraviolet light for exciting luminescence in gem minerals specially diamonds. The long-wave lamp is provided with wood's glass filter to emit wavelengths between 400 nm and 300 nm. To obtain short-wave wavelengths a low pressure mercury lamp, which emits lines at 253.7 nm by means of a suitable filter or a Chance OX7 filter. Mostly ultraviolet lamps are provided with combination of both SWUV and LWUV. Also spelled semi-abbreviation: UV lamp.

**ultraviolet lamps, combined;** → ultraviolet lamp.

**ultraviolet light;** electromagnetic radiation having wavelength between 380 and 4 nm nearly the beginning of X-rays. → Ultraviolet radiation, ultraviolet lamp.

**ultraviolet long-waves;** → ultraviolet lamp.

**ultraviolet microscope;** a special magnifying device for investigating the objects are illuminated by ultraviolet light in the range 180 to 400 nm. The resolving power is increased corresponding to the resolution of shorter wavelengths than visible light. It requires special quartz lenses and the image is recorded by photography.

**ultraviolet photofluorescence;** → photoluminescence.

**ultraviolet radiation;** the portion of the electromagnetic radiation beyond the visible spectrum at its violet end between 380 (it means end of visible violet or end of human vision) and 4 nm nearly the beginning of X-rays. For practical purpose wavelength between 400 to 200 nm are usable. It can be produced artificially by mercury vapor but naturally it is produced by solar emission from those rays only wavelength is shorter than 295 nm and reach the earth. To obtain ultraviolet rays suitable for gem testing the lamps are usually provided with a suitable filter to transmit those waves useful for gem testing. The filter used in ultraviolet lamp to cut out the visible light to produce long-wave ultraviolet ray using Wood's glass filter (window), for short-wave UV used Chance OX7 filter, etc. Ultraviolet rays for gem testing are classified as long-wave ultraviolet (LWUV) ranging from 410 to 300 nm and short-wave ultraviolet (SWUV) ranges from 300 to 200 nm mercury line, in certain cases the SWUV light may be more diagnostic. Some transparent gemstones absorb strongly ultraviolet light such as crown glass at 300 nm, quartz at 180 nm, fluorite at 120 nm. Also known as ultraviolet light. UV light is important in

gemology as a source of exciting luminescence and eventually stimulating photoluminescence. → Ultraviolet lamp.

**ultraviolet short-waves;** → ultraviolet lamp, short-wave UV filter.

**ultraviolet short-wave lamp;** → ultraviolet lamp.

**ultraviolet spectrometer;** a device like normal spectrometer, which is provided with a spectrum of ultraviolet light and calibrated scale for determination of wavelengths absorbed by a gemstone.

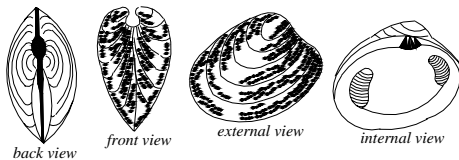
**ultraviolet transmitting glass;** → ultraviolet glass.

**ultraviolet transparency of true emerald;** the natural emerald has far less transparency to SWUV light than Chatham synthetic emerald.

**umbalite garnet;** a contraction of isomorphous intermediate group of orange to dark orange-brown garnet of pyrope-spessartine series. Some stones from Tanzania exhibit color changes to bluish in daylight and bright crimson under tungsten radiation, owing to the presence of vanadium impurity. RI:1.74-1.76.

**umbrella effect;** same as cloverleaf effect, cloverleaf.

**Umbo mussel;** a conical pearl-bearing mussel a top shell of genus Trochidae. They have pearly interior with



*umbo bivalve mussel*

horny operculum with several whorls. It exist over thousand species mainly in warm waters. Used to made buttons.

**Umbu agate;** a variety of agate found in the black vitreous rock near the town of Salto, Rio Grande do Sul, Brazil.

**Umiña;** a same as Umiña emerald.

**Umiña emerald;** a term used by Peru Incas for emerald or Emerald Goddess.

**unaided eye;** naked eye.

**unakite;** an altered igneous rock of granitic character composed of quartz, green epidote, pink orthoclase feldspars and minor oxide such as apatite, and zircon. RI:1.52-1.76. SG:2.85-3.20. Found in Unaka Range, North Carolina, USA, Zimbabwe, Africa, Ireland, and South Africa. Cut as cabochon and used as tumbled stones but prized by collectors. The cut stones from South Africa are sold as okkolite.

**unary system;** a chemical system, which consists of one component. Also called unicomponent system.

**Uncle Sam Diamond;** a very light brown rough

diamond of 40,23 cts, of gem quality found in 1924 in Crater of Diamond in Arkansas, USA. It was fashioned into an emerald cut of 12.42 cts. Present owner unknown.

**unctuous feel;** fatty, oily, slippery, greasy or soapy to the touch.

**unctuous sweat, amber;** a suggestion of occurring of amber by ancient philosophers regarded that a liquid formed by rays of the sun when it striking the surface of earth caused an enormous power that may formed unctuous sweat, which was carried to sea by river or water.

**uncut stone;** a rough diamond or other gemstone, which has not altered its original shape.

**undercutting;** a quarry technique between the open pit and underground mining.

**undercutting;** cutting away.

**underground chamber;** same as cavern.

**underground mineral working;** same as underground mining.

**underground mining;** usually a vertical passage leading from ground-level into an underground excavation for purpose of extraction of rocks in an ore deposit or diamond pipe. Also called underground mineral working.

**underlying;** same as ky-outing.

**undulated appearance of pressed amber;** a term used for undulating lines feature in pressed amber under microscope in transmitted light which is similar to flowing water and glycerin together. Also called roiled appearance of pressed amber.

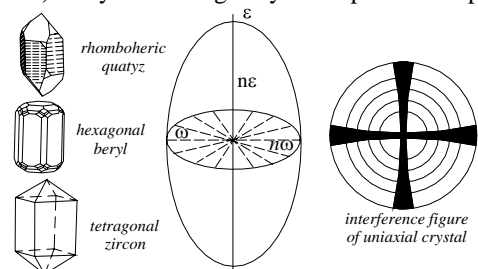
**undulation;** a characteristic wave like motion or wavy form outline.

**undulatory extinction;** the wavy extinction or dark areas, which occur when the microscope stage holding the sample is revolved. Also called oscillatory extinction, strain shadow, wavy extinction.

**uneven color;** another term for color zoning.

**uneven fracture;** a type of fracture, which has an irregular surface.

**uniaxial;** a crystal having only one optical axis parallel



*an ellipsoidal sketch of an uniaxial crystal with two different refractive indices,  $n_o$  and  $n_e$*

to the vertical crystal axis of single refraction (but of

two indices of refraction) such as tetragonal or hexagonal (trigonal) crystal. The ordinary ray of an uniaxial stone in a refractometer gives a shadow edge in invariable position. → Biaxial.

**uniaxial crystal;** → uniaxial.

**uniaxial stone;** → uniaxial.

**unicomponent system;** same as unary system.

**unicorn horn;** → narwhal ivory.

**uniform;** → uniform necklaces.

**uniform necklace strings of gemstone;** → graduated necklace strings of gemstone.

**uniform necklaces;** necklace made of round or nearly round beads, of same color, orient and size (3 mm in diameter) that is called *uniform*. → Pearl necklaces.

**Unio margaritifera;** the fresh-water pearl mussels of genus *Unionidae* found in Europe and north American rivers. Pearls produced from this shellfish have varying degrees of beauty and nacreous luster. Those from Scotland are known as *Scotch pearl*. Also found in north Wales, Ireland and Bavaria, Germany.

**Unio mussel;** → Unio margaritifera.

**Unio mussel, pearl from;** → Unio margaritifera.

**Unionidae;** a genus of large family of fresh-water bivalves mollusks some of them are pearl-bearing such as Unio margaritifera. The outer surface of shell is rough and brown or black with a pearly inner surface. Used as mother-of-pearl, button, etc.

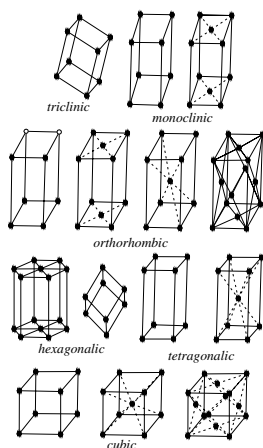
**unionite;** a local term for a rose pink variety of zoisite (thulite) owing its color to the presence of manganese. Found in Unionville, Pennsylvania, USA.

**Union Kopje;** location of alluvial diamond deposits on the Vaal River, South Africa.

**unique cut;** → fantasy cut.

**unit;** a quantity or dimension, which is adopted as a standard of measurement.

**unit;** in mining it means 1 %.



unit cell or 14  
Bravais crystal  
lattices

**unit cell;** the smallest unit, of which a three dimensional crystal lattice or parallelepiped is constructed and

possesses the whole symmetry of the entire periodic structure. Or repetition at regular intervals, in three dimensions, produces the lattice of a given chemical composition crystal. Frequently called primitive unit cell, cell unit, 14 Bavaria's crystal lattices, Bavaria's crystal lattices.

**unit of weight;** usual quantity used for gemstones, jewelry and noble metal is gram or carat (0.2 gram).

**univalent;** a chemical element having a valence of one, such as sodium. Also called monovalent.

**univalve;** pearl bearing gastropod mollusk having a shell consisting of a single piece, such as abalone, or Haliotidae.

**univalve mollusk;** → univalve.

**universal;** same as universal motion stage. → Stage.

**universal immersion stage;** → stage.

**universal motion stage;** → stage.

**universal stage;** → stage.

**unmixing;** another term for exsolution. Separation into two or possibly more phases of immiscible solutions.

**unmixing mineral;** separation of minerals by cooling such as perthite feldspar. Also called exsolution mineral.

**Unnamed Aquamarine;** a scissors step-cut aquamarine of 263.50 cts, from Russia. Now on display at National Museum of Natural History in Washington, D.C., USA.

**Unnamed Aquamarine;** a step-cut aquamarine of 1000.00 cts. Now on display at National Museum of Natural History in Washington, D.C., USA.

**Unnamed Aquamarine;** a step-cut aquamarine of 66.30 cts, from Brazil. Now on display at National Museum of Natural History in Washington, D.C., USA.

**Unnamed Aquamarine;** a pink clean aquamarine of 911.00 cts, from Brazil. Now on display at National Museum of Natural History in Washington, D.C., USA.

**Unnamed Brown Diamond;** a deep brown, cushion-shaped diamond with totally 148 facets of 545.67 cts, cut from a rough stone of 755.50 cts, It was found in 1986 in Premier Mine, South Africa. It has 55 facets on the crown, 69 facets on the pavilion, and 24 facets on the girdle. Present owner is De Beers Consolidated Mines.

**Unnamed Diamond;** an octahedron, yellow diamond of 616 cts, found in 1974 at the Dutoitspan Mine, South Africa. Now on display by De Beers Consolidated Mines at the Open Mine Museum in Kimberley.

**Unnamed Brown;** a brown, cushion-shaped diamond of 107.10 cts. Present owner unknown.

**Unnamed Colorless Diamond;** a colorless, pear-shaped diamond of 141.23 cts. Present owner unknown.

- Unnamed Colorless Diamond;** a colorless diamond of 118 cts. Present owner unknown.
- Unnamed Colorless Diamond;** a colorless, antique-cut diamond of 102.65 cts. Present owner unknown.
- Unnamed Colorless Diamond;** a colorless, cushion-cut diamond of 102.61 cts. Present owner unknown.
- Unnamed Colorless Diamond;** a colorless diamond of 101.25 cts, from India. Present owner unknown.
- Unnamed Emerald;** an oval brilliant-cut emerald of 175.50 cts. Now on display at National Museum of Natural History in Washington, D.C., USA.
- Unnamed Emerald;** an oval cabochon-cut emerald of 117.00 cts, from Colombian. Now on display at National Museum of Natural History in Washington, D.C., USA.
- Unnamed Light Brown Diamond;** a light brown, pear-shaped diamond of 102.42 cts. Present owner unknown.
- Unnamed Morganite;** a morganite of 235.50 cts, from Brazil. Now on display at National Museum of Natural History in Washington, D.C., USA.
- Unnamed Morganite;** a step-cut morganite of 122.20 cts, from California. Now on display at National Museum of Natural History in Washington, D.C., USA.
- Unnamed Morganite;** a step-cut morganite of 113.00 cts, from California. Now on display at National Museum of Natural History in Washington, D.C., USA.
- Unnamed Topaz;** a topaz of unknown origin and color of 2677kg in rough. Found 1981? Present whereabouts unknown.
- Unnamed Topaz;** a topaz of unknown origin and color of 1.1kg. Engraved by Cariello the figure of Christ breaking the Eucharist. Belonged to Pope Pius IX, 1910 sold to Brazilian Government.
- Unnamed Topaz;** a bluish-white topaz of unknown origin of 819 cts. Cut similar to Regent Diamond. Present whereabouts unknown.
- Unnamed Topaz;** a champagne topaz of 36853 cts. Found in 1989? And cut in USA. Present whereabouts unknown.
- Unnamed Topaz;** an irradiated and heated blue topaz of 12.000 cts, in rough. Present whereabouts unknown.
- Unnamed White;** a white, heart-shaped diamond of 111.82 cts. Present owner unknown.
- Unnamed White;** a white, pear-shaped diamond of 106 cts. Present owner unknown.
- Unnamed White;** a white, pear-shaped diamond of 101.84 cts. Present owner unknown.
- Unnamed White;** a white, kite-shaped diamond of 101.14 cts. Present owner unknown.
- Unnamed Yellow;** a yellow, pear-shaped diamond of 200.87 cts. Present owner unknown.
- Unnamed Yellow;** a yellow, briolette-shaped diamond of 180.95 cts. Present owner unknown.
- Unnamed Yellow;** a yellow, emerald-shaped diamond of 150.00 cts. Present owner unknown.
- Unnamed Yellow;** a yellow, briolette-shaped diamond of 114.28 cts, from India. Present owner unknown.
- Unnamed Yellow;** a yellow, cushion-shaped diamond of 114.03 cts, probably from South Africa. Present owner unknown.
- Unnamed Yellow;** a yellow, emerald-shaped diamond of 108.04 cts. Present owner unknown.
- Unnamed Yellow;** a treated yellow, cushion-shaped diamond of 104.52 cts. Present owner unknown.
- Unnamed Yellow;** a yellow, briolette-shaped diamond of 101.25 cts. Present owner unknown.
- unpolished culet;** an old misnomered term for colorless quartz crystal or colorless zircon crystal.
- unripe amber;** another term for gedanite.
- unripe diamond;** a misleading term for colorless zircon.
- unripe pearl;** a term applied to pearls of inferior luster or quality in contrast to *ripe pearl* with a good orient.
- unripe ruby;** a misleading term for red zircon.
- unsaturated;** minerals that cannot form in the presence of free or excess silica from magma such as feldspathoids, leucite, analcime, olivine, nepheline, etc.
- unsaturated;** a liquid, which is capable of dissolving more solution.
- unstable;** a condition of those minerals, which are readily decomposed, under influence from outside or without. Also called labile.
- unsymmetrical;** asymmetrical.
- unto vitriol;** a term used in past for a semi-transparent emerald, which may be was a yellow-green beryl or aquamarine from Brazil and Bohemia, which is known as American emerald with the reference to Brazil.
- untrue;** a term used by opal miners for opal color which not continuous in the vein.
- Unzue Heart Diamond;** a cornflower blue, heart-shaped diamond of 30.82 cts, erroneously known as Eugénie Blue, Eugénie blue diamond, believed to belonged to the Empress Eugénie, wife of Napoleon III of France. Now on show in the Smithsonian Institute, Washington, D.C., USA.
- upala;** a Sanskrit term that means precious stone. The word opal is lent from it.
- uparatnani;** those 4 lesser ceremonial gems used as an offering in a Hindu temple: jacinth, topaz, cat's-eye, and coral.
- upgrade;** to increase the commercial value of gems, precious metals, etc. → Mine salting.
- upper break facets;** → break facets.
- upper girdle facets;** the 16 triangular facets on the crown, which are adjacent to the girdle of a round

brilliant-cut gem. → Girdle facets, brilliant cut.

**upper mean facets;** → bezel facets.

**Ural amethyst;** another term for Siberian amethyst.

**Ural chrysoberyl;** alexandrite from Ural, Russia.

**Ural chrysolite;** a misleading term for green demantoid garnet from Ural. Also misnomered as Siberian chrysolite from Siberia, Russia.

**Ural emerald;** → Uralian emerald.

**Ural olivine;** → Uralian olivine.

**Uralian amethyst;** another term for Siberian amethyst.

**Uralian chrysoberyl;** alexandrite from Ural, Russia.

**Uralian chrysolite;** → Ural chrysolite.

**Uralian emerald;** emerald from Ural, Siberian, Russia. Also called Russian emerald.

**Uralian emerald;** a local misleading term for green demantoid garnet from Ural, Siberian, Russia. Also known as Bobrovska garnet.

**Uralian olivine;** a local misleading term for green demantoid garnet from Ural, Russia.

**Uralian sapphire;** a local misleading term for blue tourmaline from Ural, Russia.

**Uralian topaz;** fine yellow, pink, rose, colorless topaz from Sanarka, South Ural, Russia.

**uralite;** a green, fibrous variety of secondary hornblende or actinolite amphibole, which occurs in altered rock and pseudomorphous after pyroxene.

**uraninite;** a black, steel gray, velvet to brown, greenish to black, mighty radioactive mineral of UO<sub>2</sub> usually plus thorium oxide. Cubic system or amorphous. SG:6.50-10.00. H:5-6. Occurs in granite rocks. Massive variety is called pitchblende. Highly toxic. It is seen as an inclusions in some spinels.

**uranium;** a naturally, silvery white, hard, strongly radioactive metallic element in the group V of the Periodic System with the symbol U. Highly toxic.

**uranium glass;** a canary yellow glass containing uranium oxide, which exhibits a brilliant yellow-green fluorescence under UV light. Frequently used as a gem imitation. Also called canary glass.

**uranium spectrum;** the uranium as impurities in such minerals such as zircon shows fine absorption spectrum lines at 653.5 and 660.5 nm. Uranium in yellow glasses or canary glass to imitate the other yellow stones shows absorption spectrum bands in the blue and violet at 495, 460, and 430 nm. In some orange glasses an abrupt cutoff line at 590 nm can be seen.

**uranotantalite;** same as samarskite.

**urea formaldehyde resin;** same as urea resin.

**urea resin;** any translucent to opaque artificial thermosetting amino-plastic made by heating together urea and aldehyde, or formaldehyde. The color is pale to water white, take delicate dyes. Resinous luster. RI:1.54-1.60, SG:1.50. H:2½. Highly resistant to

weathering, pressure and shock and non-flammable. Used as an opaque imitation gemstone and frequently amber. Also called urea formaldehyde resin.

**ureyite;** same as kosmochlor.

**Urga;** → Kuen-Lun.

**urim and thummim;** two Hebrew terms (a) unidentified objects or materials, which are mentioned as assist the High Priest, (b) some authorities suggested as compares with Sanskrit terms nava-ratna or nao-ratan.

**Uri River valley;** important jadeite deposits of alluvial boulders found in this river valley.

**Uruguay agate;** a commercial term for an agate variety from the border of Uruguay and Rio Grande do Sul, Brazil.

**Uruguay amethyst;** a commercial term for transparent, irregular violet variety of amethyst from the border of Uruguay and Rio Grande do Sul, Brazil.

**Uruguayan agate;** same as Uruguay agate.

**Uruguayan amethyst;** same as Uruguay amethyst.

**useful mineral;** same as nonmetallic mineral.

**U-shaped inclusions in Kashan rubies;** a term used for U-shaped feature arrangement of small particles streaming as inclusions in Kashan synthetic rubies formed from large droplet flux particle which is known as comets-tail and *hairpins*. → Dash, dot inclusions in Kashan rubies.

**using X-ray for detection of pearls in oysters;** reportedly examination of cultured pearl oyster by means of X-ray whether the shell has produced the beads nucleus.

**U.S. National Museum;** same as Smithsonian Institution, Washington, D.C., USA.

**U.S. National Museum Topaz;** a light-blue Brazilian topaz of 3273 cts. Cut by Sinkankas 1960? Now on display at Smithsonian Institution, Washington, D.C., USA.

**U-stage;** same as universal stage. → Stage.

**Utah jet;** an inferior quality of jet from Wayne Co., Utah, USA.

**Utah onyx;** a misleading term for citron yellow variety of dripstone onyx marble (stalagmitic marble) from Salt Lake City, Utah, USA, which contain orange veins. It is similar to Mexican onyx and Yava onyx.

**Utah opal;** various colored common opals of no commercial value from Milford, Utah, USA.

**Utah turquoise;** a misnomer for a variety of variscite similar to turquoise from Utah, USA.

**Uubvley;** location of alluvial diamond deposits along the north shore of Namibia coast, Africa. Also called Area U.

**utahlite;** a compact, nodular variety of gem variscite, which resembles turquoise from Cedar Valley, Utah,

USA. Also called jarosite.

**utahlite matrix**; another term for amatrice.

**uvarovite garnet**; an end member of the garnet group with fine emerald green color due to chromium element. Also spelled uwarowite, ouvarovite. Also called chrome garnet, chromium garnet. Rarely cut as cabochon and faceted as gems, but prized by collectors.

System: cubic.

Formula:  $8[\text{Ca}_3\text{Cr}_2(\text{SiO}_4)_3]$ . Frequently contain aluminum.

Luster: vitreous.

Colors: bright green, emerald green, greenish,

Streak: white, colorless.

Diaphaneity: translucent to opaque.

Fracture: conchoidal to even. Brittle.

Cleavage: none.

SG: 3.40-3.80.

H: 7-7.

RI: 1.850-1.860, from Winchell 1.830-1.870.

Dispersion : 0.027.

Found in Finland, South Africa, Canada, Russia, Spain, Scotland, and California (USA).

**uvite**; a calcium-magnesium member of tourmaline group brown or green color or colorless. Unlike dravite. Found in Brazil, Myanmar, and Sri Lanka. Used as a gemstone.

**UV lamp**; same as ultraviolet lamp.

**uwarowite**; same as uvarovite.

# V v

**Va**; a chemical symbol for the element vanadium.

**Vaalpoort**; an alluvial diamond-bearing location in Schweizer Reneke area, Transvaal Province, South Africa.

**Vaal River**; location of diamond-bearing river flowing south west from Transvaal to the Orange River in South Africa. Many famous diamonds were found here.

**vaas**; another spelling for wass.

**vabanite**; a local term for red-brown, banded jasper with yellow flecks from California, USA. Also spelled wabanite.

**vacuole**; a French term for vesicle.

**vacuum**; ideally, a space entirely devoid of molecules, atoms or matters.

**vacuum coating**; a method of coating a solid surface with a thin uniform layer of another substance by evaporation at a high temperatures in a vacuum. Also called vacuum evaporation.

**vacuum evaporation**; same as vacuum coating.

**vacuum fluorescence display**; a miniature cathode ray tube (CRT), which is closet to cover glass and heated cathode made of tungsten wire emits electrons. The electrons are accelerated by positively charged by hexagonal steel and passing through the grid to anodes covered with blue fluorescent ZnO:Zn. The entire of apparatus is evacuated and sealed with name vacuum fluorescence display.

**vacuum separation**; vacuum extractor used for cleaning the bedrock or empty potholes of gravels.

**vacuum sputtered**; → vacuum sputtering.

**vacuum sputtering**; the process of evaporation of energetic ionized particles or metals for microscopically deposition as a thin uniform layer applied to a surface of gemstones or other material, usually pure gold or silver. This method is used for preparation of nonconductor samples for electron microscopy and for improving the color and appearance of some stones such as bluish-green to pale-blue iridescent colored natural quartz *aqua aura quartz*, which is a colorless stone but can be coated with pure gold, silver, or platinum.

**vacuum tube**; an evacuated electron tube. Such a tube is electrically unaffected by the presence of residual gas or vapor, used in X-ray technique. → Hittorf tube.

**vadivu**; a commercial term used in Sri Lanka (formerly Ceylon) for imperfections in the form of small pearls

but larger than seed pearls with a good luster.

**vadivu**; a commercial term used for medium grade of pearls. → Vadivu, mondogoe, madanku, chevvu.

**vaidhurya**; a Sanskrit or Hindu or Canarese term for beryl, frequently used for lapis lazuli or emerald. Also spelled vaidurya.

**vaidurya**; same as vaidhurya.

**Vainer-Briolette Diamond**; a fancy yellow, briolette-cut diamond of 116.60 cts, from South Africa with 192 facets, was cut from a rough stone of 202.85 cts, in 1985 in London by M. Vainer. It was purchased by Sultan of Brunei, Asia.

**vaihsya emerald**; a Hindustani term for yellowish-green emerald.

**Vajra**; an Indian term for diamond. It means thunderbolt.

**valence**; a unit of combination power of an element for other elements, which is measured by the number of hydrogen atoms, with which an atom will combine or be substituted with. Valence of oxygen is 2, carbon is 4, etc. Also called valency, chemical valency.

**valence bond**; the bond, which links two or more electrons from two or more different atoms of a crystal together.

**valence crystal**; → valence bond.

**valence electron**; the outer electron of an atom, which is involved in the gaining, losing, or sharing of chemical changes, which may combine with other atoms to form molecules.

**valence shell**; the outer electron shell of an atom.

**valencianite**; a local term for adularia from a silver mine at Guanajuato, Valencia, Mexico.

**valency**; a unit of bonding potential of an atom, expressed by the numbers of hydrogen atoms. This bonding is formed by gaining, donating or sharing electrons with each other to fulfill the outer shell of the atom with two or eight electrons. Therefore the outer electron shell of an atom is also called the *valence shell*. Same as valence.

**Valentina Tereshkova Diamond**; a diamond of 61.66 cts, from Sakha (Yakutia) formerly Mir Mine in the Russian Federation, CIS. Named after the first woman cosmonaut. Now on display in the Russian Diamond Fund, Moscow.

**Valery Bykovsky Diamond**; reportedly a large rough diamond of unknown weight. On display in the Russian Diamond Fund, Moscow.

**Valley of Amber**; a location of amber in Latvia on the northern Sakasosta, Russia.

**Valley of Diamonds**; a fictitious valley based on the legendary diamonds found in India.

**vallum diamond**; a local misleading term for quartz cut in vallum, Madras, India. Also called vellum diamond.

**valuation;** the value or estimate or assigned value of a gemstone. Same as appraisal.

**value;** estimated or assigned worth of a gemstone, not necessary in money.

**value;** quantity or percentage of precious metals in an ore body.

**value;** → color (definition).

**valve;** in conchology one of the two separate, equal or subequal valves, convex curved horny calcareous plates that open and shut, which compose the shell of a bivalve mollusk. The two valves are connected by the adductor muscle.

**vanadinite;** an isomorphous mineral with pyromorphite and mimetite of apatite group. Often occurs as a globular mass encrusting other minerals. Rarely cut as faceted gems, rarely cut into cabochon but prized by collectors. Also called endlicheite.

System: hexagonalic.

Formula:  $2[\text{Pb}_5(\text{VO}_4)_3\text{Cl}]$ . Commonly contains P or As.

Luster: resinous, subadamantine.

Colors: ruby-red, red, orange-red, yellow, brownish-red, rarely white to colorless.

Streak: yellowish-white.

Diaphaneity: transparent, translucent to opaque.

Cleavage: none.

Fracture: conchoidal to uneven. Brittle.

SG: 6.88-7.10.

H:  $2\frac{1}{2}$ -3.

Optics:  $\omega$ :2.416,  $\epsilon$ :2.35.

Birefringence: 0.066.  $\ominus$ .

Dispersion: 0.202.

Found in Arizona, New Mexico, Colorado, California, Utah, South Dakota (USA), Russia, Algeria, Tunisia, Morocco, Mexico, Scotland, Italy and Austria.

**vanadinite cut;** → vanadinite.

**vanadinite pleochroism;** weakly shades of yellow and orange.

**vanadium;** a very hard, light-gray, ductile, malleable, metallic element of the group V of the Periodic System with the symbol V. It is one of the 8 pigment metals responsible for color in gemstones such as beryl, sapphire (natural or synthetic). Used as a component of alloy steel, it is resistant to air and sea water.

**vanadium coloration;** attractive green color due to vanadium impurities in certain gemstones such as natural beryl or emerald, and synthetic corundum, which changes color like alexandrite.

**vanadium emerald;** a misleading term for a green variety of beryl from Brazil, which contains vanadium. The true emerald a variety of beryl owes its color to chromium. Synthetic grass-green beryl doped by vanadium is produced by the hydrothermal method.

**vanadium garnet;** a variety of grossular garnet, which sometimes contains up to 4.50%  $\text{V}_2\text{O}_5$ .

**vanadium in beryl;** vanadium ( $\text{V}^{+3}$ ) ions as impurities in beryl cause the green color.

**vanadium in tourmaline;** tourmaline owes its attractive green color to vanadium ( $\text{V}^{+3}$ ) and chromium ions as impurities.

**vanadium in emerald;** → vanadium in beryl, vanadium emerald.

**vanadium in synthetic corundum;** vanadium oxide as color agent in synthetic corundum or sapphire with color change made to imitate alexandrite. Once erroneously termed *scientific alexandrite*. The color change is reddish-green in daylight and much reddish in artificial light. → Alexandrine sapphire, synthetic alexandrite.

**vanadium in synthetic emerald;** → vanadium emerald, or synthetic beryl,-doped.

**vanadium spectrum;** vanadium as impurities in certain gemstones make it an attractive green color such as natural beryl or emerald, and synthetic corundum with color change like alexandrite shows absorption spectrum in the bright blue at 475 nm.

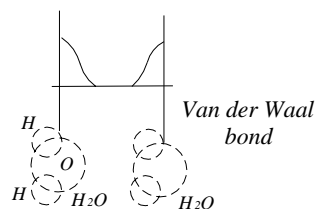
**van Bercken, Lodewyk;** → Berquen,-Louis de.

**van Berquen, L.;** → Berquen,-Louis de.

**Vanderbilt Diamond;** a pear-shaped diamond of 16.25 cts. It was presented from Reginald Vanderbilt to Gloria Morgan as an engagement finger ring in 1922. Later sold to Jack M. Werst in 1946. Present owner unknown.

**van de Graaff generator;** once a high voltage electrostatic generator used for cyclotron for production of fast charged particles from an atomic reactor used for artificial color change of diamonds. → Electroned diamond.

**van der Waals bonds;** in bonding of elements and compounds, a very weak electrostatic attractive forces between polar crystals or molecules or noble-gases. Also called van der Waals bonds.



**van Dyke brown;** a naturally brown occurring, bitumen-based pigment mixture of iron oxide and organic substance. Found in bog-earths, ochers, peat deposit. Used as dyes and anti-hardening of vehicle. Also called Cassel brown, Cologne earth, Ulmin brown. Cologne brown.

**van Dyke red;** a synthetic brownish red pigment consisting of copper ferrocyanide.

**van Niekerk Diamond;** in 1866 a South African farmer found a rough diamond of 21.25 cts, which was named



as Eureka.

**van Niekerk Diamond;** later in 1869 found a rough diamond of 83.50 cts, known as Star of South Africa. His full name is van Niekerk, Schalk.

**van Zyl Diamond;** a diamond of 229.25 cts, found in 1913 at Cawood's Hope, Pniel Estate, South Africa. Present owner unknown.

**vapor deposition;** → chemical vapor deposition.

**Vargas, President Diamond;** same as Presidente Vargas Diamond.

**variation in hardness;** hardness of minerals varies according to crystallographic direction in certain minerals for example, kyanite or disthene has three different hardness in three different crystallographic direction: 4.5, 6, and 7.

**varicose veins;** → subcutaneous markings of cultured pearl.

**variegated;** sedimentary rock showing variations of color or marked irregularly with flecks or strips of diverse color such as sandstone.

**variegated;** a stone composed of pieces of different colors.

**variegated copper ore;** same as bornite.

**variegated gold;** different colors of gold alloys used in jewelry as decoration.

**varietal mineral;** same as characterizing accessory mineral.

**Varieties of gems;** species of gems are divided into varieties. Varieties are based on color, color distribution, diaphaneity, and optical properties. Corundum is a mineral species of  $\text{Al}_2\text{O}_3$ , the red to purplish-red variety is called ruby, the blue variety is known as sapphire and all other colors are named as fancy sapphire.

**variety;** in mineralogy or gemology a stone showing differences in appearance, color or other optical properties. A minor variation in chemical constitution causes the color difference in a species, which is based on variety, for example ruby and sapphire are varieties of corundum. → Mineral species, species.

**variolite;** a variety of deep green orthoclase with pea-size spherical bodies as an inclusion but lighter in color.

**variolite;** a fine-grained igneous rock of diorite clan composed of pea-size globule bodies. Composed of plagioclase, augite, and ilmenite in a groundmass of augite and probably devitrified glass.

**variscite;** an isomorphous mineral with strengite and dimorphous with metavariscite. It occurs with brown veins and eyes of wardite. When mixed with reddish or brownish quartz from Nevada it is called amatrix a synonym for American matrix. It takes a good polish and resembles turquoise and chrysoprase. Colored by iron and chromium. Cut into cabochon of various kind

made into and carved objects. Used as an attractive curio stone and as a turquoise imitation. A banded variety of green variscite from Manhattan, Nevada, USA is named *sabalite* or *trainite* and a compact, nodular variety of gem quality is known as *utahlite*. An amorphous variety of variscite is called *uhligite*. Also called hercynides. → Amatrice.

System: orthorhombic.

Formula:  $8[\text{AlPO}_4 \cdot 2\text{H}_2\text{O}]$ . Contains chromium and iron.

Luster: vitreous to waxy to dull.

Colors: pale green, bluish green, bright green, emerald green.

Streak: colorless.

Diaphaneity: transparent to translucent to opaque.

Cleavage: {010} perfect, and {001} poor.

Fracture: conchoidal, uneven to splintery. Brittle.

SG: 2.52-2.60.

H:  $3\frac{1}{2}$ -4 $\frac{1}{2}$ .

Optics:  $\alpha$ :1.563,  $\beta$ :1.588,  $\gamma$ :1.593.

Birefringence: 0.030. ⊖.

Found in Brazil, Germany, Spain, Austria, the Czech Republic, Australia, Utah, California, Arizona, and Nevada (USA).

**variscite absorption spectrum;** strong line at 688 and a weak line at 650 nm.

**variscite luminescence;** dim green luminescence under SWUV and whitish-green under LWUV light from Utah, USA.

**variscite-matrix;** same as amatrice or amatrix.

**varnish;** a lustrous or glazed surface on porcelain or pottery.

**varnish;** same as desert varnish.

**varnish;** a colored or colorless protective coating layer of natural or synthetic substance spread on the surface of some stones.

**vaseline;** a purified mixture of jelly hydrocarbons of whitish or yellowish mass obtained from the distillation of petroleum. Used to protect the dense glass of refractometer, while it is not in use. RI1.50. Also called petrolatum, petroleum jelly.

**vashegyite;** a mineral like variscite in appearance used as gemstone, cut cabochon and prized by collectors. → Trainite, sabalite.

System: orthorhombic.

Formula:  $4[\text{Al}_6(\text{PO}_4)_5(\text{OH})_3 \cdot 23\text{H}_2\text{O}]$ .

Luster: resinous to dull.

Colors: white, pale yellowish to green, rust-brownish.

Streak: colorless.

Diaphaneity: translucent to opaque.

Cleavage: {001} perfect.

Fracture: not determined.

SG: 1.934-2.005.

H: 2-3.

Optics:  $\alpha$ :1.47,  $\beta$ :1.477,  $\gamma$ :1.48.

Birefringence: 0.010. ⊖.

Found in Nevada (USA), Minas Gerais (Brazil), Germany, Hungary, and the Czech Republic.

**vat blue, C.L.;** another term for indigo.

**vat;** a large vessel for holding liquids, which used for reduced vat dye.

**vat dye;** a class of dye that are not soluble in water but can easily reduced by alkaline such as sodium hydrosulfite ( $\text{Na}_2\text{S}_2\text{O}_4$ ), to water soluble leuco-compositions, which easily oxidized by exposure to the air or used perborate, dichromate. Used as dyes. Also called leucoindigo, leuco, vatting indigo.

**vateria indica;** → dammar,-white.

**vaterite;** a hexagonal mineral of chemical formula:  $12[\text{CaCO}_3]$ . Trimorphous with calcite and aragonite. It is relatively unstable. Optics;  $\omega$ :1.55,  $\epsilon$ :1.65. Birefringence: 0.010. ⊕. SG:2.55-2.65. H 3. Found in north Ireland and Israel.

**Vatican Museum, Roma;** a famous collection of gems and jewels of historical interest from ancient time to recent time. Also called Vatican Treasury.

**Vatican Treasury;** same as Vatican Museum.

**vatting indigo;** → vat dye.

**Vauxhall glass;** a type of black glass was made by Vauxhall Glass-House in London, used as a jet imitation. Also called French jet.

**vayrenenite;** same as väyrynenite.

**väyrynenite;** a rare gem mineral cut as faceted stone.

System: monoclinic.

Formula:  $4[\text{MnBePO}_4(\text{F},\text{OH})]$ .

Luster: vitreous.

Colors: rose red, light pink.

Streak: colorless.

Diaphaneity: transparent.

Cleavage: {001} distinct, and {100} distincts.

Fracture: Brittle.

SG: 3.18-3.22.

H: 5.

Optics;  $\alpha$ :1.639-1.667,  $\beta$ :1.661,  $\gamma$ :1.667.

Birefringence: 0.026-0.028. ⊖.

Found in Pakistan and Finland.

**Väyrynenite pleochroism;** varieties from Pakistan shows yellow-pinkish, deep pink and pale pink pleochroism.

**Vedas;** any collections of ancient sacred writings of Hinduism such as Rig-Veda, Sama-Veda, and Atharva-Veda. Veda in Sanskrit means knowledge, sacred lore.

**Vee cast;** same as herringbone texture.

**Vee mark;** same as herringbone texture.

**Vega Diamond;** a marquise-shaped diamond of 14 cts, named after blue star Vega in the heaven. Present owner unknown.

**vega gem;** a commercial term for man made corundum

used as a diamond imitation.

**vegetable ivory;** an imitation ivory made from the hard, white endosperm of the ivory nut of certain palm trees such as ivory palm or *Phytelephas macrocarpa* or *Homero pullipunta*, which resembles ivory and is used for beads. RI:1.54. SG:1.38-1.42. H:2½. Coral colored vegetable ivory used to imitate coral or buttons for decorative purposes. → Doum-palm ivory, corozo nut, ivory palm.

**vegetable beads as imitation pearl;** → vegetable ivory.

**vegetable for imitation coral;** → vegetable ivory.

**vehicle;** a term used in painting as hiding power, or binding mass, etc.

**veil;** white, cloud-like variety of quartz, which is caused by minute bubbles as inclusions.

**veil-like inclusions;** whitish wisp-like inclusions similar thin wind-blown clouds in synthetic ruby by flux-grown method. Not visible in true stones.

**vein;** any irregular, small crack or thin sheet-like, fracture or fissure, which is filled with minerals. When it is small called veinlet. If a thick, large vein or a group of them occur it is called lode, cloud.

**vein;** an irregular tabular form cutting of rock, which is assembled of different materials.

**vein;** → vein quartz.

**veinlet;** → vein.

**vein mineral;** same as veinstone.

**vein quartz;** quartz bodies, which occur in mineral veins such as joining quartz crystal of pegmatite or hydrothermal origin.

**veinstone;** any epigenetic, valueless minerals that formed together with value minerals in a lode. Also called vein mineral, veinstuff.

**veinstuff;** those minerals formed in veins of fractures or fissures.

**veinstuff;** same as veinstone.

**velardenite;** another term for gehlenite.

**valence band;** in solid state the highest electronic energy band in a semiconductor crystal or solid, which may be filled with electrons.

**vellum diamond;** same as vallum diamond.

**velocity of light;** another term for speed of light.

**veluriya;** a Singhalese term for beryl, frequently used for lapis lazuli or emerald. Also spelled weluriya.

**velvety blue;** a shades of blue color similar to velvet can be seen in Kashmir sapphire.

**velvety druses;** a term used for the vugs from the tungsten mine of Panaqueira, Portugal in which very little sharp crystal of tourmaline are found when the needles penetrate skin of the hands are like nettles.

**velvety luster;** a peculiar luster similar to velvet can be seen in Kashmir sapphire create due to presence of small exsolved inclusions.

**Venetia Mine;** locations for open cast kimberlite pipe mines, KI, and KII, in northern Transvaal Province, South Africa.

**Venetian blind effect;** a term used for uniform parallel growth plane inclusions in synthetic flux-grown emerald.

**Venetian glass;** a term used for imitation pearl made of hollow, iridescent glass, which filled with wax to increase the solid look of the beads.

**Venetian pearl;** a misleading term for imitation pearl. → Glass imitation pearls, Roman pearl.

**Venezuela;** a gem bearing country on northern coast of South America.

**Venezuela diamonds;** first diamond mine was discovered in 1901, alluvial deposits are found in the Guyana Highland.

**Venezuela pearl;** same as La Paz pearl.

**venturina;** Spanish term for aventurine.

**Venice;** a city and trading center of diamond in northern Italy.

**veniform;** another term for kidney-shaped.

**Venter Diamond;** an octahedron, pale yellow diamond of 511.25 cts, found in 1951 in Nootgedacht, Barkly West, Cape Province, South Africa. It was cut into 20 diamonds. Named after mine owner J. Venter.

**Ventersdorp;** location of alluvial diamond deposit in Transvaal Province, South Africa.

**ventifact;** same as glyptolith, wind-cut stone, wind-polish stone, wind-shaped stone, windkanter, wind-faceted pebble.

**Venus ear;** another term for abalone shell.

**Venus hair;** same as sagenitic quartz.

**Venus hairstone;** same as sagenitic quartz.

**Venus, pearl from;** a salt-water pearl mollusk of little commercial interest, which produces porcelaneous black and dark pink pearl.

**verde antico;** same as verde antique.

**verde antique;** an opaque green variety of serpentine veined with lighter colored calcite and other minerals. Found in Egypt, Italy, Greece. It was known in Roman times as *lapis atracius* and found near the ancient town Atrax Greece. Also called serpentine marble. Used in ornamental, decoration and building purposes. Also spelled verd antique, verde antico, and called serpentine marble, serpentinous calcite.

**verde antique;** a green patina or discoloration of basic copper carbonate formed naturally on copper and bronze. Also called patina.

**verde de Corsica;** same as Corsican green.

**verde de Corsica duro;** same as Corsican green.

**verdelite;** a misleading term for green variety of tourmaline. Sometimes called African tourmaline, Transvaal tourmaline.

**verde marble;** → serpentine breccia.

**verdigris dye for quartz;** dissolved verdigris in turpentine used as dye to produce a beryl or emerald colored quartz. → Acetate of copper.

**verdite;** an ornamental opaque green rock composed chiefly of green chromium muscovite-mica or fuchsite and compact clay. RI 1.58. SG:2.8-3.00. H:3. Found in Swaziland, and Transvaal (South Africa), Australia, India, Venezuela and USA. Frequently used as a jade imitation. Green marble of Shrewsbury is a verdite from Vermont, USA.

**verdite;** a commercial term for green serpentine marble or verde antique.

**verditer;** same as copper green.

**Vergenoeg;** location of an alluvial diamond deposit in Kimberley area, Cape Province, South Africa.

**Vereiniging Beurs voor den Diamanthandel;** a diamond bourse in Amsterdam, Holland, member of the World Federation of Diamond Bourses or WFDB.

**veridian;** → chrome green.

**Verilux;** → diamondlux

**Vermeam parasite;** a minute parasite worm, which may cause irritation in a mollusk and form a *blister pearl*, when introduced between the shell and mantle, or, a *pearl sac* which produces a *cyst pearl*, when introduced into the mantle. The trematode worm has the same effect.

**vermeil;** a misleading commercial term for orange-red, brownish-red, yellowish-red gem variety of garnet. Also called vermilion, vermeille, vermeille garnet. Also called vermeille garnet.

**vermeil;** a misleading commercial term for orange-red, reddish-brown gem variety of quality ruby. Also called vermeille ruby.

**vermeil;** a misleading commercial term for orange-red gem variety of spinel. Also called vermeille. Also called vermeille spinel.

**vermeil;** any varnish applied to a gilded surface of a gem or other material to give luster such as gilded copper, gold, silver, etc.

**vermeille;** same as vermeil.

**vermeil ruby;** → vermeil.

**vermeil spinel;** → vermeil.

**vermeille garnet;** same as vermeil.

**vermicular quartz;** worm-like quartz, which is intergrown with feldspar.

**vermiculated;** minerals or stones having appearance like a worm.

**vermiculite;** a group of platy micaceous clay minerals of phyllosilicates, which are able to expand 6 to 20 times their volume into long worm-like threads and exfoliate, when



*vermilite* – very slightly included

heated. Monoclinic system. Formed by weathering of mica minerals.

**vermilite**; a variety of opal or massive quartz with color of bright red or pink caused by inclusions of cinnabar.

Also known as myrickite.

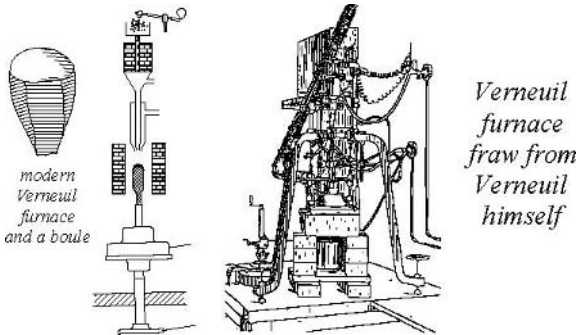
**vermilite opal**; → vermilite.

**vermillion**; same as vermilion.

**vermillion**; an orange-red, brownish-red, yellowish-red gem variety of garnet. Also spelled vermeil, vermillion.

**vermillion**; a scarlet red variety of cinnabar (mercuric sulfide), used as pigment. RI:3.00.

**Verneuil furnace**; a technique invented by the French mineralogist and chemist Verneuil Auguste Victor



Louis (1856-1913) in 1902, for the production of large amount of synthetic corundum and spinel. An inverted oxy-hydrogen blowpipe-type furnace, which fused pure alumina powder to which has been added predetermined oxide for coloring. The fused mass drops on the ceramic pedestal, which are known as *candle* start to grow as pear-shaped single crystal with the name *boule*. Synthetic Rutile, and synthetic strontium titanate are made in the same method. Also called Verneuil process. Sometimes referred to as flame fusion. → Chalumeau. an inverted oxy-hydrogen burner.

**Verneuil process**; same as Verneuil furnace.

**Verneuil synthetic corundum**; → Verneuil furnace, synthetic corundum.

**Verneuil synthetic rutile**; → Verneuil furnace, synthetic rutile.

**Verneuil synthetic sapphire, irradiated**; lightening color center seen in synthetic sapphire due to irradiated. → Sapphire color centers.

**Verneuil synthetic sapphire with impurity**; synthetic sapphire contain nickel impurity. → Sapphire color centers.

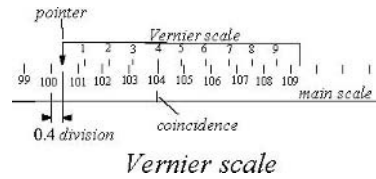
**Verneuil synthetic spinel**; → Verneuil furnace, synthetic spinel.

**Verneuil synthetic stones**; same as Verneuil furnace, synthetic.

**Verneuil synthetic strontium titanate**; → Verneuil

furnace, synthetic strontium titanate.

**vernier**; a small moveable auxiliary scale instrument for determining accurate fractional parts of the subdivision of a scale in centimeters and tenths. It consists of a length of nine-tenths of a centimeter, which is subdivided into 10 equal parts.



Used to measure apparent depth of gemstones in microscopical study. Also called vernier scale.

**vernier scale**; same as vernier.

**Verona earth**; a naturally green sedimentary soil generally containing iron silicate or glauconite and chlorite from Verona, Italy. Also called terra verde, terre verte, Veronese green, Verona green, veronite, celadonite, green earth.

**Verona green**; same as terre verte or green earth, Verona earth.

**Veronese green**; same as terre verte or green earth, Verona earth.

**Veronica Emerald, the**; same as Emerald Vernicle, the.

**Veronite**; same as terre verte or green earth.

**verre églomisée**; a term used for milky-glass etching-technique, which was applied in amber industry to produce engraved amber with color painting the designs on the reverse of the surface.

**verstel**; a term applied to full brilliandeered bezel in a brilliant cut diamond.

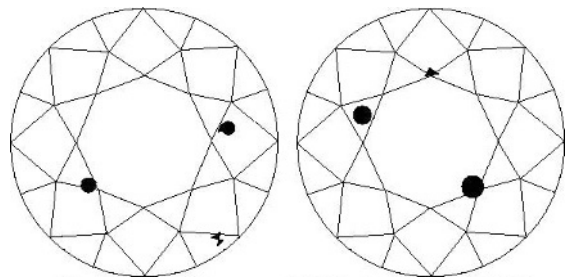
**vertex**; another term for crest.

**vertical**; a term used by opal miners for a feature of cracks and joints in sandstone running downwards vertical or subvertical from the roof, which is filled with opaline material.

**very light yellow**; → dark cape.

**very slightly imperfect**; → very slightly included.

**very slightly included**; a grade of relative imperfection on the GIA clarity-grading scale for diamonds with



diamond clarity very slightly included (VS-1), right (VS-2)

internally blemishes and on the surface, which are

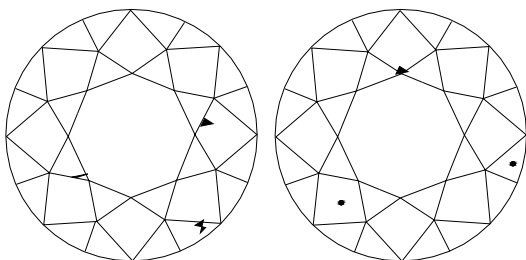
invisible to the unaided eye but under 10x magnification. Very slightly included are divided into two subgrades with abbreviation VS<sub>1</sub> and VS<sub>2</sub>, which are used by CIBJO, IDC, and Scan. D.N. v.s.i.

**very slightly inclusions;** → very slightly included. v.s.i.

**very small inclusions;** → very slightly included.

**very very slightly imperfect;** → very very slightly included.

**very very slightly included;** a grade of relative imperfection on the GIA clarity-grading scale for diamonds with internally blemishes and externally flaws, which are invisible to the unaided eye but visible



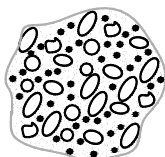
*diamond clarity very very slightly included (VVS-1), right (VVS-2)*

with 10x magnification. It is between flawless (F) or internally flawless and very slightly included (VS). Very very slightly included are divided into two subgrades with abbreviation VVS<sub>1</sub> and VVS<sub>2</sub>, which are used by CIBJO, IDC, and Scan. D.N. v.v.s.i.

**very very slightly inclusions;** → very very slightly included. v.v.s.i.

**very very small inclusions;** → very very slightly included. v.v.s.i.

**vesicle;** more or less spherical cavities formed in certain extrusive igneous rocks or lava by expansion of gas bubbles during solidification of lava. Also called vacuole, gas cavity.



*vesiculars or porous in a rock*

**vesicular;** extrusive igneous rocks or lava having a cellular structure similar to vesicle.

**vespa gem;** a commercial term for synthetic corundum used as a diamond imitation.

**vestellers;** mounting a diamond in a solder dop for polishing.

**vesuvian;** originally the same as vesuvianite.

**vesuvian;** once a term for leucite or vesuvian garnet.

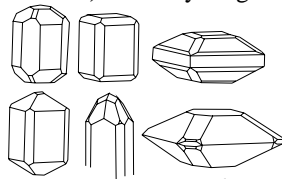
**vesuvian;** a synonym for idocrase.

**vesuvian;** a term applied to a composition of calcite and hydro-magnesite.

*very slightly inclusions – vicinal face*

**vesuvian garnet;** a misleading term for once a white leucite having an isometric crystal form like garnet. Prized by collectors.

**vesuvianite;** a variety of gem mineral in diverse colors,



*vesuvianite crystals*

which is prized by collectors. The transparent varieties of idocrase are named vesuvianite.

A compact green variety resembling jade is known as *californite*. A greenish-blue or sky-blue variety is named *cyprine* because it contains copper. A transparent yellowish-brown is known as *xanthite*. Also called vesuvian, genevite, wiluite, duparcite, laurelite, and pyramidal garnet.

System: tetragonal.

Formula:  $4[\text{Ca}_{10}(\text{Mg}, \text{Fe}^{+2}, \text{Fe}^{+3})\text{Al}_4(\text{SiO}_4)_5(\text{Si}_2\text{O}_7)_2(\text{OH})_4]$ .

Luster: vitreous to resinous.

Colors: colorless, pale yellowish to yellowish green, green, brown, white, red, pink, violet, blue to blue-green.

Streak: colorless.

Diaphaneity: transparent to translucent.

Cleavage: {110} indistinct, {100} very indistinct, and {001} very indistinct.

Fracture: conchoidal to uneven. Brittle.

SG: 3.33-3.45.

H:6-7.

Optics;  $\omega$ :1.703-1.752,  $\epsilon$ :1.700-1.746.

Birefringence: 0.008-0.018.  $\ominus$  or  $\oplus$ .

Dispersion: 0.019-0.025.

Found in Finland, Korea, Tanzania, Japan, Austria, Norway, Canada, Russia, Austria, Switzerland, Pakistan, Sri Lanka, and California, Maine, and New Jersey (USA).

**vesuvianite;** another term for idocrase.

**vesuvianite jade;** a misleading term for jade like californite a variety of vesuvianite known as idocrase. Also called vesuvian jade.

**vesuvian jade;** same as vesuvianite jade.

**vetro di berillo;** an Italian term for glass or green glass.

**vezel;** another term for fezel.

**viberite;** same as bassanite.

**vibrating pebble mill;** a size reducing mill similar to tumbler.

**vibrating quartz;** same as oscillating quartz.

**vibration;** the rapid and promotion of a continuing periodic frequency in a displacement with respect to fixed reference. → Lattice vibration.

**vibration quartz;** same as oscillation quartz.

**vibratory quartz;** same as oscillation quartz.

**vicinal face;** facets of a crystal that modified a normal crystal face, which is closely approximately in angle.

**vicinal hillocks on tourmaline;** a surface growth feature of tourmaline occur on basal or pedion face like a vicinal hillock such as Brazilian t tourmaline.

**Vickers diamond hardness test;** same as Vickers hardness test.

**Vickers hardness test;** an accurate test for determining the hardness of mineral (other than diamond), metals, alloys, and stones by indentation with a pyramid-shaped diamond into the surface of sample, and computing the area of the indentation under microscope. Also called Vickers diamond hardness test, diamond-pyramid hardness test. → Indentation test, knoop indentation hardness test.

**Victoria cat's-eye;** → cathay cat's-eye, cat's-eye imitation, Iimori glass, Iimori stone.

**Victoria Diamond;** (I) a rough diamond of 469 cts, probably from South Africa, found in 1884. It was cut into a cushion-shaped brilliant of 184.50 cts, in 1887 in Amsterdam, Holland and acquired by Nizam of Hyderabad, India in 1891, and a round cut brilliant of 20 cts. Present owner unknown. Also called Great White Diamond, Victoria White Diamond, Jacob Diamond, Imperial Diamond, Victoria Imperial Diamond, or Victoria II Diamond. (II) A rough diamond of 428.50 cts, found in 1880 in South Africa. It was cut into a brilliant of 228.50 or 288.50 cts. Whereabouts unknown. (III) A fine-quality, white, diamond of 770 cts, found in 1945 in Sierra Leone, Africa. Fashioned into 30 stones largest an emerald-cut of 31.35 cts. Also known as Woyie River. Whereabouts unknown.

**Victorian cut;** a modification of cutting diamond of small stones with large culet and smaller table during the Victorian era.

**Victoria II Diamond;** same as Victoria Diamond, Imperial Diamond.

**Victoria Imperial Diamond;** same as Victoria Diamond, Imperial Diamond.

**Victoria stone;** → cat's-eye imitation, Iimori stone.

**Victoria Transvaal Diamond;** a champagne yellow, pear-shaped brilliant cut diamond of 67.89 cts, was cut from a rough diamond of 240 cts, found in 1950 in the Premier Mine, Transvaal district, South Africa. It has 116 facets and was cut by Baumgold Bros. in New York in 1950, set in a yellow necklace with 108 other diamonds. It was presented by Victoria Wilkinson to the Smithsonian Institution in Washington, D.C., USA.

**Victoria White Diamond;** same as Victoria Diamond, Imperial Diamond.

**Victory Diamond;** another name for Woyie River Diamond.

**victron plastic;** a commercial term for a synthetic thermoplastic resin or plastic from polystyrene and

distrene used as a gem imitation.

**video in microscopy;** a video camera used as a microscope accessory to give enlarged image of the sample on a monitor.

**video in spectroscopy;** video camera combined with spectroscope to give enlarged spectral image on the monitor.

**vidrilhos;** same as vitrie.

**vidrio de berilo;** a Spanish term for glass or green glass.

**vidro de berilo;** a Portuguese term for glass or green glass.

**Vienna lime;** a pure calcined lime manufactured in Australia used for quick polishing together with alcohol on a wood lap.

**Vienna turquoise;** a misleading term for an amorphous blue mass used as a turquoise imitation, which is also misnomerly called synthetic turquoise. It has the same chemical composition, color, hardness, specific gravity and appearance as natural turquoise, it is a pressed and dyed massive aluminum phosphate colored by copper oleate or made of aluminum hydroxide, malachite and phosphoric acid heated to over 100° C. Was made in Vienna and other countries. Also spelled Viennese turquoise.

**Vienna turquoise;** a misleading term for turquoise colored glass used as a turquoise imitation.

**Viennese turquoise;** same as Vienna turquoise.

**vigorite;** a commercial term for bakelite a synthetic phenolic resin plastic.

**villiaumite;** rarely used as faceted gems, but prized by collectors.

System: cubic.

Formula: 4[NaF].

Luster: vitreous.

Colors: carmine red, violet, lavender pink, orange. By heat treatment to 300° C it becomes colorless.

Streak: colorless to white.

Diaphaneity: transparent to translucent.

Cleavage: {001} perfect.

Fracture: brittle.

SG: 2.79-2.80.

H: 2-2½.

RI: 1.327.

Found in Guinea (Africa), Quebec (Canada), and Kola Peninsula, Russia.

**villiaumite pleochroism;** strong: yellow, pink and dark red.

**wiluite;** another spelling for wiluite a variety of idocrase.

**Vilyui River;** location for alluvial diamond deposits, in Sakha (Yakutia), the Russian Federation, CIS.

**vindhara;** an Indian term for a workman who pierce and drill pearls in Bombay.

**vinegar spinel;** a reddish to yellow variety of spinel.

**vinyl plastics;** a commercial term for a transparent, colorless synthetic hard thermoplastic resin, which becomes temporarily softened, when heated, can be molded into a shape. After cooling the shape retains. → Polystyrene.

**violan;** a translucent to opaque, violet blue to deep blue variety of diopside. Containing MnO and Mn<sub>2</sub>O<sub>3</sub> responsible for color. Waxy luster. RI ≈ 1.69. SG:3.23. H:6. It takes a good polish, cut into cabochon, as beads and as inlay. Found in San Marcel, Piedmont, Italy. Also spelled violane.

**violane;** same as violan.

**violet coral;** a variety of akori from West African coast and in Samoa.

**violet diamond;** natural fancy color diamond with violet body color.

**violet quartz;** a term applied to amethyst.

**violet ruby;** a term applied to amethyst-violet corundum.

**violet sapphire;** a term applied to amethyst-violet corundum.

**violet stone;** same as cordierite or iolite.

**violet stone;** same as amethyst variety of quartz.

**violite;** a commercial term for man-made corundum.

**virgin sulfur;** a term applied to native sulfur.

**Virgin Valley opal;** black and white precious opal from Virgin Valley, Nevada, USA, which has more internal cracks than Australian opals. Roebbling Black Opal was obtained from Virgin Valley.

**viridine;** a translucent, green variety of andalusite containing nearly 7% Mn<sub>2</sub>O<sub>3</sub> with strong pleochroism from Vestana, Sweden. Rarely used as gems. RI: 1.66-1.69. Also called manganandalusite or manganandalusite.

**viridian;** → chrome green.

**virtual image;** an optical image at a point through, which the ray of light radiations appear to come to the observer's eye but not actually, such an image can not be projected by means of a screen or on a sensitive emulsion. The image can be seen in a plane mirror or through a diverging lens. This is the function of a convex lens.

**virtuous stone;** → toadstone, antidote to poison.

**viscoloid;** a misleading commercial term for celluloid.

**viscosity;** any internal resistance of substance to deformation or relative motion within itself, when it is subjected to shear stress by a liquid or gas. The ratio is called coefficient of viscosity, in units of poise. A poise = 0.1 Pa-sec. Also called flow resistance.

**vishnevite;** same as cancrinite.

**visible;** ability to be perceived or sensed by the eye. In view.

**visible light;** that part of electromagnetic radiation,

which ranges between 780 to 380 nm visible to man eye. Also called visible radiation. Also called visible radiation.

**visible radiation;** same as visible light.

**visible spectrum;** the part of continuous electromagnetic radiation having wavelengths in the visible region, which are visible to the eye.

**visibly crystalline;** same as phaneritic.

**vision of color;** to see and determine the color of an object 3 factors are needed: object, light and receiving instrument or eye.

**viss;** a unit of weight used in Myanmar, (Burma) equal to 880 carats.

**visual angle;** in optics equal with an angle that an object subtends at the nodal point of the observer's eye.

**visual colorimeter;** a device used for measuring or comparing the color of an unknown specimen with an image for comparison of hue and color saturation.

**visual feature of plastics;** orange peel feature. → Plastics properties.

**visual optics;** an optical effect observed by transparent faceted gemstones without using devices by so-called *stone to eyeball* method where dispersion of color fringes can be seen, produced in the image of the white light lamp.

**visual purple;** → Vitamin A<sub>1</sub>.

**vital stain;** a term applied in microscopy stain which used on living cells without killing them because the nontoxic compounds.

**Vitamin A<sub>1</sub>;** a purple-red, noncyclic, unsaturated alcohol, visual purple of the eye closely related to β-carotene with the compound (C<sub>14</sub>H<sub>23</sub>OH), obtained from carotenes. This is main agent in the eye for reception of light. Also called rhodopsin, visual purple. → Polyene.

**Vitória Diamond;** a diamond of 328.34 cts, found in Brazil in 1943. Sold to Harry Winston who cut it into 44 stones. Largest 30.39 cts.,

**vitrain;** an unconfirmed term for pure coal.

**vitre chinoisé;** another term for Placenta placenta due to transparency of the slightly domed shell. Cut into diamond-shaped rhombic used as glazing purposes.

**vitreo;** a Spanish term for vitreous.

**vitreous;** objects having the luster of broken glass such as quartz and most gemstones.

**vitreous;** another term for hyaline.

**vitreous;** a mass composed of glass.

**vitreous;** same as vitreous luster, glassy.

**vitreous copper;** same as chalcocite.

**vitreous enamel;** a glass mass spreading over the surface of metals or other materials and than fusing to the metal at high temperature between 600° to 1000° C. Used as decorative, art objects and jewelry.

**vitreous humor;** a gelatinous filling mass of the eyeball, which forms an sharp inverted but reduced image on the retina. → Eye.

**vitreous lava;** another term for glassy lava.

**vitreous luster;** in mineralogy a type of luster, which is seen in glass-like objects such as quartz and most gemstones, caused by reflection of light.

**vitreous obsidian;** another term for axinite.

**vitreous silica;** a transparent, vitreous or glass material made from silica. → Silica.

**vitreous silver;** another term for silver glance.

**vitreous Persian turquoise;** another term for agaphite.

**vitric;** a pyroclastic rock material that is characteristically glassy.

**vitriification;** the process of formation of a glassy or noncrystalline substance or converting a siliceous material into an amorphous glassy condition formed by melting at intense heat and rapid cooling such as quartz glass or fused quartz. → Volcanic glass.

**vitrie;** a term used in Brazilian for very small, light and vary colored diamond crystals. Also spelled vidrilhos.

**vitriers;** same as diamond-set glass cutters.

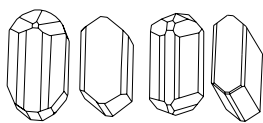
**vitriified;** in ceramics industry fusing of body (stoneware) and glaze under highly firing, which causes a non-porous, hard, glass-like material.

**vitriol;** an obsolete term for a number of sulfates such as iron, aluminum, atramental stone or ink stone, copper, lead, zinc, killow, etc., because of their glassy appearance.

**vitrolite;** a commercial term for an opaque glass, where surface is fire-finished.

**vitroclastic;** a term applied to a rock such as ignimbrite which is composed of welded glassy fragments.

**vivianite;** rarely faceted as gemstone because it is fragile and soft but prized by collectors. The mineral darkened on exposure to light. It is a coloring agent of odontolite or so-called bone turquoise. Also called blue



*vivianite crystals*

iron earth, blue ocher, blue iron ore, blue ochre.

System: monoclinic.

Formula:  $2[\text{Fe}^{+3}(\text{PO}_4)_2 \cdot 8\text{H}_2\text{O}]$ .

Luster: vitreous, pearly to dull.

Colors: colorless darkened after a time to blue or green, blue, dark greenish blue, bluish black, violet to dark purple.

Streak: colorless or bluish white, darkened after a time to brown or blue.

Diaphaneity: transparent to translucent.

Cleavage: {010} perfect, {106} trace, and {100} trace.

Fracture: fibrous. Flexible. Sectile.

SG: 2.64-2.70.

H: 1½-2.

Optics;  $\alpha$ :1.588-1.616,  $\beta$ :1.603-1.656,  $\gamma$ :1.630-1.675.

Birefringence: 0.040-0.059. ⊕.

Dispersion: 0.014.

Found in Cameroon, Bolivia, Australia, Canada, Germany, Japan, the Russian Federation, CIS, France, England, California, Idaho, New Jersey, and South Dakota (USA).

**vivianite pleochroism;** distinct: blue, light yellow-green and yellowish-green. Or yellowish-olive-green, yellow-green and indigo. Some other stones: dark blue, light yellowish-green and light bluish-green.

**Viviparus;** a fresh-water gastropod fossil of genus *Paludina carinifera* found in some limestones with peculiar pattern such as in Sussex south England, this is known as Sussex marble, shelly marble, or Purbeck marble.

**Vlakfontein;** location of alluvial diamond deposit in Transvaal Province, South Africa.

**Vogelfontein;** location of diamond pipe mine in Orange Free State, South Africa.

**void;** an interstice between spheres of opal or fragments. → Porous stones.

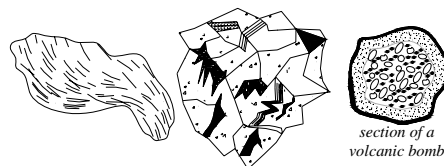
**volcanic;** pertaining to volcanic activities. Rock type pertaining to a volcano.

**volcanic;** eruptive.

**volcanic ash;** a typical product of the explosive volcanic eruption of fine, unconsolidated (may consolidated) pyroclastic fragments with the grain size less than 0.04 mm to 0.25 mm in diameter. Same as pumice dust. Also called volcanic dust, ash, pumicite.

**volcanic breccia;** an angular pyroclastic rock that has been naturally cemented from volcanic fragments larger than 64 mm in diameter. Also called alloclastic breccia, lava breccia. → Volcanic pipe.

**volcanic bomb;** a pyroclastic igneous rock, which was ejected while viscous and received its round shape



*volcaic bombs*

during the flight, the shape of rock varies greatly. It is larger than lapilli in diameter and may have hollow to vesicular inside. Also called rotation bomb, spindle bomb. Same eruptive breccia.

**volcanic breccia;** same eruptive breccia.

**volcanic chimney;** → volcanic pipe.

**volcanic chrysolite;** a misleading term for vesuvianite idocrase.



**volcanic dust;** same as pumice dust. → Volcanic ash.

**volcanic effusion;** same as effusion.

**volcanic eruption;** same as volcanic vent.

**volcanic glass;** a solid volcanic natural form of glass (rock) produced by sudden cooling and solidification of viscous lava before crystallization can take place, such as obsidian, pitchstone or other glassy masses. Obsidian is used for tumbled gems, ornamental objects, beads and cut cabochon, some pieces have been faceted.

**volcanic neck;** → volcanic pipe.

**volcanic igneous rock;** same as rock volcanic.

**volcanic opal;** a distinguish term used by Australian miners for a variety of opal which is a product of volcanic silica. Also called mountain opal.

**volcanic pipe;** a nearly vertical, cylindrical body or opening of igneous rock that solidified in the neck of a volcano through, which magmatic materials have passed, such as kimberlite. May or may not contain diamonds. Usually filled with volcanic breccia and fragments of older pre-existing rock. Also called pipe, breccia pipe, volcanic chimney, volcanic neck.

**volcanic plug;** a pipe-like body of magma, which is vertical and represented the conduit to an earlier volcanic vent. → Volcanic pipe.

**volcanic rock;** generally a fine crystalline or glassy igneous rock, which is formed by the solidification of molten magma or lava on the Earth's surface during volcanic action. Such as basalt, obsidian, etc. Also called volcanite, vulcanite, volcanic igneous rock. → Igneous rock.

**volcanics;** solidifying of igneous rocks on the earth's surface.

**volcanic tuff;** same as tuff.

**volcanite;** same as rock volcanic.

**volcanite;** an old term for pyroxene.

**volute;** a spiral scroll used as a decorative and ornamental on bowls, vessels, etc.

**Volyn Topaz;** an Ukraine topaz of 117kg in rough. Found in Russia, CIS. Present whereabouts unknown.

**Voorspoed;** location of kimberlitic diamond pipe near Kroonstad, Orange Free State, South Africa.

**Vooruitzicht farm;** the location of diamond deposits near Bulfontein, Kimberly District, South Africa.

**vorobievite;** another spelling for vorobyevite.

**vorobyevite;** a Russian term for sodium and cesium gem variety of rose-red, pinkish-red, purplish-red or colorless beryl, which is called roosterite or morganite.

Found in Malagasy, Africa, and Ural, Russia. Also spelled vorobievite, vorobyevite, vorobieffite. Also called pink beryl, rose beryl, roosterite.

**∇-shaped inclusions in corundum;** a term applied to flattened tiny twin crystals in corundum they are developed on the basal plane.

**Voshod-2 Diamond;** reportedly a large diamond of unknown weight in the Russian Diamond Fund in Moscow.

**VS;** an acronym for diamond clarity grading for very slightly included, very slightly imperfect, very slightly inclusions, very small inclusions. It is divided into two subgrades with abbreviation VS<sub>1</sub> and VS<sub>2</sub>.

**vug;** a mining term for a small irregular cavity in a rock often crystal-lined of different composition from that of surrounding rock, in which gem minerals are projecting towards the center. It is formed from trapped mineral-rich water. Also spelled vough, vugh, voog, vogle, vugg and called bug-hole. → Amygdale, geode, miarolitic rocks.

**vugh;** same as vug but relative larger.

**vulcanite;** a hard dark-colored sulfur vulcanized India rubber. It is vulcanized in high temperature (up to 115° c) and accepts high polish. Used sometimes in jewelry as an ornamental object, comb and as an imitation jet for mourning jewelry. Sulfur 30% and rubber 70%. SG: 1.15-1.20. → Ebonite.

**vulcanization;** a physicochemical change to modify properties of rubber such as elasticity, stretch, and strength by adding sulfur usually with the application of heat.

**vulpinite;** a scaly, granular, grayish-white, variety of anhydrite from Vulpino, Lombardy, Italy. Used as an ornamental purposes.

**Vuurfontein;** location of alluvial diamond deposit in Transvaal Province, South Africa.

**vvs;** an acronym for diamond clarity grading for very very slightly imperfect, very very slightly included, very very slightly inclusions, very very small inclusions. It is divided into two subgrades with abbreviation vvs<sub>1</sub> and vvs<sub>2</sub>. Also spelled v.v.s.i.

**v.v.s.i.;** an acronym for diamond clarity grading for very very slightly imperfect, very very slightly included, very very slightly inclusions, very very small inclusions. It is divided into two subgrades with abbreviation v.v.s.i.<sub>1</sub> and v.v.s.i.<sub>2</sub>.

# W w

**W**; a chemical symbol for the element tungsten.

**wa**; a Chinese term for pig carved jade. → Chinese ritual and symbol jades.

**Wabanite**; another spelling for vabanite.

**Wabra**; location in Saudi Arabia where enormous heat was generated by the impact of a meteorite upon the earth surface. The result was fused sand or silica materials. Such a glass crater found at Meteor Crater, Arizona, USA, and in central Australia.

**wackeler agate**; same as wegeler agate.

**wad**; black ocher, earthy manganese.

**Wady Maghareh**; it means Valley of Caverns. An old Egyptian turquoise mine was worked from 5300 B.C. In old Egyptian it was named as Bebit with meaning country of grottoes.

**Wafangdian Mine**; location of kimberlite pipe diamond in Fu Xian, Liaoning Province, China.

**Wairagah working**; the location of alluvial diamond deposits in north of Golconda area on the bank of the river Wairagah, India. Tavernier called Beiragahr.

**Wajra**; the term Wajra used in Sanskrit in India for diamond.

**Wajrakarur or Wajrahkarur working**; a diamond bearing area within the district of Kurnool and Anantapur, south of the city Hyderabad. Some kimberlitic and lamproitic pipes extended from the south to the north up to Kurnool.

**Waldeck's Plant**; the location of alluvial diamond deposits on the Vaal River, Cape Province, South Africa.

**walderite**; a man-made colorless sapphire or corundum used as a diamond imitation. Misleadingly called scientific brilliant.

**Walker balance**; a balance similar to steelyard scale used for measuring specific gravity of stones. Also called Walker's steelyard. → Steelyard.

**walker's earth**; another term for fuller's earth.

**Walker's steelyard**; same as Walker balance.

**wall**; a two dimensional crystal structural form that serve to hold the units with the bottom row of each higher row one unit less than the row below.

**wallet bead**; semi oval shaped bead with a light topped bottom.

**walnut potch**; same as angel stone.

**walnut stone**; a term used by Australian opal miners for small hard, rounded porcellanite pieces, which is

formed within the clay and sometimes holds potch. Also called angle stone.

**walrus ivory**; a yellowish cream variety of ivory obtained from the large outside portion of the tusks of marine amphibious mammals like the walrus or morse *Odoboenus nosmarus* of the family *Otariidae*. The ivory is coarser than elephant and hippopotamus ivory. RI:1.55-1.57. SG:1.9-2.0. H:2½-3½. Found in Arctic seas of the Atlantic and Pacific Oceans. Also called morse ivory. → Sperm-whale ivory, narwhal ivory, wart-hog ivory.

**Walska Briollette Diamond**; a diamond of 95 cts, once owned by Ganna Walska, opera star. It was auctioned in 1971. Later purchased by Van Cleef & Arpels of New York, USA. Present owner unknown.

**Walska Heart Diamond**; a heart-shaped diamond of 21 cts, once owned by Ganna Walska, opera star. It was auctioned in 1971. Present owner unknown.

**Walton filter**; a dark emerald green glass or beryloscope used for examination of emeralds. It is similar to a hand loupe. It looks deep blue in daylight and black in artificial light. When genuine emerald and some other genuine gems such as epidote, etc. and synthetic emerald are observed through the filter, they appear reddish to violetish. Glass imitation and some genuine gems such as Brazil emerald, diopase, and tourmaline appears green. → Chelsea filter, emerald filter, beryloscope.

**wardite**; a mineral resembling turquoise but softer. Rarely faceted as gems, cut cabochon together with variscite. Prized by collectors. Also called sousmansite.

System: tetragonalic.

Formula:  $4[\text{NaAl}_3(\text{PO}_4)_2(\text{OH})_4 \cdot 2\text{H}_2\text{O}]$ .

Luster: vitreous.

Colors: colorless, light green, light bluish green, white.

Streak: colorless.

Diaphaneity: transparent to translucent.

Cleavage: {001} perfect.

Fracture: conchoidal to uneven. Brittle.

SG: 2.81-2.87.

H: 5.

Optics;  $\omega$ :1.586-1.595,  $\epsilon$ :1.595-1.605.

Birefringence: 0.010. ⊕.

Found in Utah, California, South Dakota, USA, and Sousmans, Creuse, France.

**wardite cut**; → wardite.

**warm opal**; intense vivid natural colored opal. → Cool opal.

**warmth touch test**; → tongue test.

**Warrenton**; a small location of alluvial diamond deposit in the Kimberley area, Cape Province, South Africa.

**warrior**; a commercial term for stones cut as cameos or intaglios, which are carved with the figure of a warrior

of ancient Persia, Greece, Roman, etc.

**warringtonite**; a term applied to an emerald green variety of chalcantite.

**wart agate**; a variety of carnelian-agate having minute rounded growths on the surface.

**wart chalcedony**; exterior pattern of chalcedony geodes shows minute rounded, protuberances wart-like growths on the surface.

**wart-hog ivory**; a variety of ivory obtained from a large wild pig or wart-hog teeth a genus of *Phacochoerus aethiopicus* of the family Suidae. Resembles walrus ivory but is coarser than elephant ivory. RI:1.55-1.57. SG:1.90-2.00. H:2<sup>3</sup>/<sub>4</sub>. Found in warmer parts of oceans. Used for carving small objects. Also spelled warthog. → Sperm-whale ivory, walrus ivory, narwhal ivory, boar ivory.

**wart pearl**; another term for blister pearl or baroque pearl.

**warty**; having minute rounded growths on the surface like warts.

**warty-back pearl**; irregular, baroque freshwater pearl from Mississippi Valley, USA from warty back clam.

**wascoite**; a local and unofficial term used for a silica-rich substance from the bottom of Lake Wasco county, Oregon, USA, which resembled petrified wood.

**wash**; another term for gravel gold.

**wash**; another term alluvial placer.

**wash gold**; a term applied to placer gold.

**wash gravel**; alluvial sands washed to extract gold particles or other valuable minerals.

**wash pan**; → rotary washing pan.

**washing pan**; → rotary washing pan.

**Washington**; location of fine common opal from south central Washington, USA.

**washing toddies**; after fishing *Pinctada carchariarum* pearl-bearing oysters of shark Bay, the shells have been opened and the soft part of body is scooped out under the hot sun, repeatedly poured with water and stirred and after a few days disintegrated odorous mass leave the pearls at the bottom of vessel and the odor is similar to that of the washing toddies of Marichchicadde in Mannar.

**Washington Diamond**; two clear fine diamonds, one pear-shaped brilliant of 89.23 cts, and the other of 42.98 cts, was cut by Harry Winston in 1976 from a rough stone of 342 cts, found in South Africa. Named after formerly American President George Washington. Sold in 1977. Present owner unknown.

**Washington Sapphire**; a rough, dark blue star sapphire of 1,997 cts, found in Anakie, Queensland, Australia. It was carved into a bust of former US President George Washington, after carving weighed 1,056 cts. This stone, together with those of Presidents Lincoln,

Eisenhower and Jefferson and the Black Star of Queensland, were presented as a gift to the American people in 1957 by the Kazanjian Foundation of Pasadena, California, to the Smithsonian Institute, Washington, D.C., USA., where they are on display.

**Washita**; same as Washita stone.

**Washita diamond**; a misleading term for a variety of quartz crystal from Washita or Ouachita River, USA.

**Washita stone**; a porous, rather coarse-grained novaculite found from Washita or Ouachita River, USA. Used for sharpening tools.

**wash opal**; opal fragments found in alluvial stream beds, which have been washed down by rain.

**wass**; a Dutch term for triangular diamond cleavage of an octahedral diamond crystal cut with this face usually as the table. Also spelled vaas.

**wassie**; a large cleavage, which is produced by a cleaver.

**waste**; a term applied to weathering debris resulting from weathering by mechanical and chemical means, which are moved down sloping surface or carried down by a water course. Also called weathering debris.

**waste rock**; a term applied to a non-economic rock such as gangue, which must be removed during mining in order to gain valuable ore or materials.

**watchmaker's eyeglass**; any convex piece of glass used for magnifying a mounted object so that it can be held in the eye socket with shorter focus and less power, usually 4 times the enlargement of the object with a working distance of about 6.5 cm for using the tools.

**watches diamond**; a minute rose cut diamond used in watches and chronometers or as end stone of the end of the pivots of the balance wheels of watches.

**water**; once a popular term frequently used as a comparative for describing quality, transparency, or luster of a gemstone especially diamonds, rubies or pearls. It was qualified as first water, second water, etc. Typical quality classification of diamond in fine water, or water-white.

**water**; another term water opal.

**water agate**; another term for enhydros.

**water bands in infra-red spectrum**; in spectrum of some emeralds the green is due to chromium and iron. These bands near infra-red are caused by molecular vibration of water and carbon dioxide.

**water chrysolite**; a misleading term for moldavite a variety of tektite, occurring in Bohemia and Moldavia. Also called bottle stone, bouteillenstein and misnomered as obsidian.

**water clear amber**; a variety of transparent amber.

**water color**; → ice.

**water, concentration in**; → concentration in water.

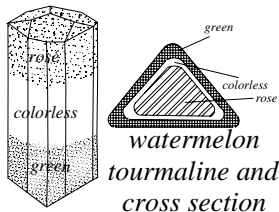
**water drop quartz**; quartz crystal containing movable water bubbles. Used as a curio stone.

**Waterford glass;** a variety of lead glass from Waterford, Ireland, which is hand-blown and hand-cut.

**water-green beryl;** a misleading term applied to a variety of light green glass similar to aquamarine, used as sphere in crystal gazing.

**watermark;** → cloverleaf effects.

**watermelon tourmaline;** a variety of parti-colored, bi-colored or tri-colored tourmaline. In bi-colored the core is colorless or green and outer segments are pink. In tri-colored tourmaline the color is separated in three zones; the core is frequently pink or red and the outer ends are white and green or any combination of these colors.



is colorless or green and outer segments are pink. In tri-colored tourmaline the color is separated in three zones; the core is frequently

pink or red and the outer ends are white and green or any combination of these colors.

**water of crystallization;** water molecules, which have been chemically combined in certain crystals or hydrated salts, which are given off when the crystals are heated.

**water of Ayr stone;** the roughly fashioned pieces of blue john, a variety of fluorite well surfaced by employing water of Ayr stone.

**water of the sea;** another term for aquamarine.

**water opal;** a term applied to any precious transparent opal with a light or white body color, which shows a well play of color. In Queensland, Australian called only water, Mexican water, glassy.

**water opal;** another term for hyalite.

**water opal;** a misleading term for moonstone.

**water sapphire;** pale blue natural colored sapphire.

**water sapphire;** a misleading term for pale blue cordierite or iolite.

**water sapphire;** a misleading term for water worn, colorless pebbles of topaz from Sri Lanka. Also called saphir d'eau.

**water stone;** a synonym for moonstone feldspar.

**water stone;** another term for hyalite.

**water stone;** same as water agate or enhydros.

**water stone;** in China a term for jade.

**waterworn stone;** stream-worn gem or diamond pebbles, which are smooth and round and polished by the action of water in a river, or ocean. Also called riverworn stone.

**Waukesha Diamond;** same s Eagle Diamond.

**wave form of light;** the pictorial graphical representation of the shape of a wave obtained by plotting the values of the periodic quantity against the time.

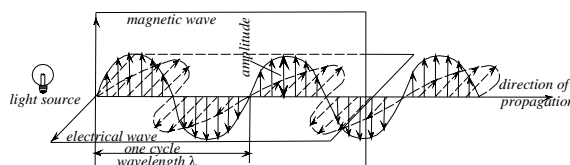
**wavefront;** a peculiar chevron-shaped (zigzag), color zones can be seen in some hydrothermal synthetic emeralds and amethyst.

**wavefront in synthetic cat's-eye alexandrite;** synthetic cat's-eye alexandrite may show an undulating pattern in which waves of light are in motion under magnifier.

**wavefront of light;** the surface, over which waves of light are in motion and possess the same phase.

**wavelength  $\lambda$ ;** the distance between two points having the same phase on the following or preceding wave.

The wavelength of electromagnetic radiation is equal to



electromagnetic vibration of light

the velocity of the wave divided by its frequency  $=c/v$ . It is measured in nanometers unit. Symbol:  $\lambda$ . In table below wavelengths in vacuum, air, and crown glass are compared:

table 19: wavelength in vacuum, air, and crown glass. After Nassau 1983

wavelength in vacuum in nm	wavelength in air in nm	difference in nm	wavelength in glass in nm	difference in nm
400.00	399.887	0.113	264.20	135.80
500.00	499.860	0.140	332.20	167.80
600.00	599.834	0.166	400.30	199.70
700.00	699.807	0.193	467.90	232.10

**wavelength number;** → wave number .

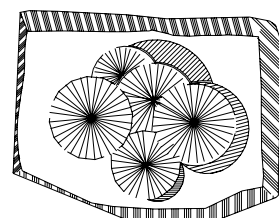
**wavelengths;** → wavelength.

**wavelength spectrometer;** → spectrometer.

**wavelength spectroscopy;** → spectroscopy.

**wavellite;** cut cabochon, while of internal radiating structure like sun-rays and cut into gems. Prized by collectors. The crystals are dichroic. Fischerite is a mineral similar to wavellite.

**wavellite;** an obsolete term for brazilianite.



radiated ball of wavellite

System: orthorhombic.

Formula:  $4[Al_3(PO_4)_2(OH,F)_3 \cdot 5H_2O]$ .

Luster: vitreous to resinous to pearly.

Colors: colorless, pale yellowish to yellowish green, greenish-white, yellowish-brown, brownish-black.

Streak: white.

Diaphaneity: transparent to translucent.

Cleavage: {110} perfect, {101} good, and {010} distincts.

Fracture: subconchoidal to uneven. Brittle.

SG: 2.36.

H: 3½-4.

Optics:  $\alpha$ :1.521-1.535,  $\beta$ :1.525-1.543,  $\gamma$ :1.545-1.561.

Birefringence: 0.025.  $\oplus$ .

Found in California, Alabama, Colorado, Pennsylvania, Arkansas (USA), the Czech Republic, Rumania, and Australia.

**wavellite cut;** → wavellite.

**wavellite luminescence;** may be bluish under LWSUV ray.

**wave meter;** a device for indicating and recording wave spectra of an electromagnetic radiation between a series of surfaces with the same phase.

**wave motion of light;** → light, theory of light, wave theory of light.

**wave number;**  $\sigma$  the reciprocal of the wavelength of electromagnetic radiation, means the number of waves per unit distance in centimeters. It is expressed in  $\text{cm}^{-1}$ . Symbol: $\sigma$ .

**wave theory of light;** the theory, which assumes that electromagnetic light is a wave motion may explain all the observed phenomenon as emission, interference, diffraction and absorption of light rather than a stream of photons. → Light, theory of light.

**wave velocity;** the velocity, with which a wave train moves at a constant phase through a medium. Also called phase velocity, group velocity.

**wave worn;** gravels with smooth or polished surfaces caused by water wave action.

**wavy girdle;** poorly fashioned diamond where the girdle is not parallel to a single plane.

**wax;** a solid, yellow, low melting, noncrystalline monohydric alcohol of hydrocarbons of higher homologues resembling beeswax in appearance. Mineral waxes included ozocerite, and paraffin. Used as filling, coating, polishing, impregnating, casting, shaping, etc. Beeswax has a chemical composition:  $\text{C}_{30}\text{H}_{61}\text{O}.\text{CO}.\text{C}_{15}\text{H}_{31}$ . → Wax-filled pearl.

**wax;** → wax opal.

**wax agate;** a yellowish to yellow red variety of agate or chalcedony with a waxy luster.

**waxed turquoise;** some porous turquoises are impregnated with wax, paraffin, colorless plastic, or colloidal aqueous silica liquid to deepen the color of pale stones. Sometimes colored impregnates are used to increase the color of pale turquoise and their value. Soft

friable American turquoise is impregnated with colloidal aqueous silica to harden it.

**wax-filled imitation pearls;** same as wax-filled pearls.

**wax-filled pearl;** hollow glass beads, which are coated with essence d'orient (fish essence) may be filled with wax to produce inexpensive imitation pearls. Glass beads filled with wax do not break easily. Also called wax-filled imitation pearls.

**wax opal;** a term used for a variety of white common opal with yellowish to yellow red waxy luster or feel waxy. Also spelled wax.

**wax pearl;** same as wax-filled pearl.

**waxy geuda;** a semitransparent to sub-translucent sapphire stone of waxy appearance and a slight diesel effect in transmitted ray. → Geuda.

**waxy luster;** a type of luster, which can be seen in some soft minerals such as turquoise, chalcedony, wax, jadeite, etc.

**weathering;** a natural geological description for disintegration and decomposition of rocks and minerals as consequent exposure to atmospheric agents at or near the Earth's surface such as chemical action of air, rainwater, frost, insolation, bacteria, plants, and mechanical actions. Also called clastation, demorphism.

**weathering;** in mining geology alterations in physical and chemical constituent and structure of ore or rocks by atmospheric or climatic attacks such as cold, heat, wind and chemical oxidation.

**weathering;** attacking surface of a glass or enamel by atmospheric action.

**weathering debris;** another term for waste.

**weathering floor;** same as floor.

**weathering of rocks;** → weathering.

**weatherstone;** rocks or stones with a high degree of resistance to the weather such as limestone used as building cladding.

**web;** a term used by opal miners for fine lines of fault occur with age, which run in different directions through opal. Also spelled webbing.

**webbing;** another spelling for web.

**Webster Kopje Diamond;** a diamond of 125 cts, found in 1907 in South Africa. No additional information is available.

**Webster Robert;** (1899-1976) British gemologist and author of several books such as *Gems, Their Source, Description and Identification*, fifth edition 1997, revised by Peter G Read.

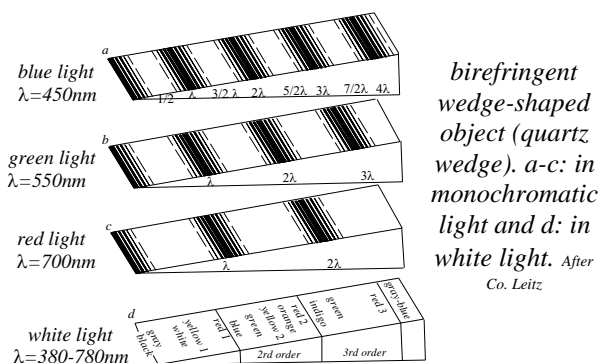
**Wedberg;** a small location of alluvial diamond deposit in the Kimberley area, Cape Province, South Africa.

**Wedding-anniversary list used in USA;** following list of materials was issued in 1948 by Jewelry Industry Council and approved by several other national

professional organization in the USA: 1-clocks, 2-china, 3-crystal and glass, 4-electrical application, 5-silverware, 6-wood, 7-desk sets, 8-lines and laces, 9-leather, 10- diamond jewelry, 11-fashion jewelry, 12-pearl or colored gems, 13-textiles or furs, 14-gold jewelry, 15-watches, 16-silver hollow-ware, 17-furniture, 18-porcelain, 19-bronze, 20-platinum, 25-sterling silver jubilee, 30-diamond, 35-jade, 40-ruby, 45-sapphire, 50-golden jubilee, 55-emerald, 60-diamond jubilee.

**Wedding ring;** a finger ring made of precious metal (gold, platinum, or silver) with or without gemstone given to the bride as a part of the wedding ceremony and occasionally to the groom by the bride. Usually placed on the left hand.

**wedges;** a very thin wedge-shaped piece of quartz cut parallel to an optical axis of a prism of quartz crystal. Used in optical mineralogy and petrography to



determine the sign of the birefringence of biaxial minerals. Also used for involving polarized light and its interference figure in convergent light. Also called quartz plate.

**wedgwood;** → wedgwood ware.

**wedgwood ware;** a commercial term for fine ceramic, fine hard-ware like porcelain consisting of tinted clay ground in various colors, which were cast as small white cameo relief to imitate classical designs. Also used as ornamental objects in jewelry such as brooches, pendants, etc. The varieties of wedgwood are: bamboo ware, cameo ware, basalt ware, pebble ware, jasper ware, and queen's ware.

**wegeler agate;** a German term used in twin towns Idar-Oberstein for thin slice of agate, which contain fine colorless needles, when cut cabochon the turned light seems to shimmer back and forth like a water bubble. Also called wackeler agate.

**weight calculation;** → weight estimation of polished gemstones.

**weight estimation of polished gemstones;** the weight of a round brilliant-cut diamond measured by average diameter or  $d_2 \times \text{depth} \times 0.0061 \times \text{weight correction}$

factor. → Caliper gauge.

**weight of gemstones and precious metals;** a standard mass. The unit of weight of gemstones since 1913, is the international metric carat or decimally of them in points.

**weight of gemstones and precious metals;** the unit of weight of precious metals is also the international gram or kilogram. The unit such as grain, troy ounce, etc. are more less in use.

**weight recovery;** the stones lost between 50 to 75% their weight during the cutting process therefore thick girdle or decreasing pavilion angles to retain more weight were chosen. Diamonds lost 50 to 60%, while colored gemstones up to 75%. Also called weight retention but during this process the proportion of cut stone is not considered.

**weight retention;** same as weight recovery.

**weight tolerances;** the maximum quality of weight is achieved, when ideal proportion are considered.

**weighing the rough diamonds;** in diamond trading small stones of the same categories may come from different sources and be mixed and weighed together, but those stones above about 15 cts, are sold separately.

**weights and measures of cultured pearls;** the cultured pearls from Japan are weighed in momme equivalent to 18.75 carats or 3.75 gr.

**Welcome Stranger;** a nugget of gold of 200-lb found in 1869 in Victoria, Australia.

**welded opal;** a term used by Australian opal miners for a matrix with a little color which may be occur alone or combined with potch or opal.

**welding;** to unite pieces of suitable metals or resin plastics by raising the temperature sufficiently or striking an electric electrode until fused together.

**welding glass;** highly colored glass to protect welder's eye from injuries during radiation.

**welding powder;** those flux agents, which are used in the welding of metals or plastics.

**Welgevonden;** small location of alluvial diamond deposit in Schweizer Reneke, Transvaal Province, South Africa.

**well;** a commercial term for dark non-reflecting area frequently seen in the center of a poorly fashioned gemstone, when viewed through the table.

**well made;** a popular term applied to a well-proportioned diamond cut.

**Wellington;** location of diamond deposits in New South Wales, Australia.

**Wellington;** a commercial term for synthetic strontium titanate used as a diamond imitation. Also called Wellington countrified diamond.

**Wellington countrified diamond;** same as Wellington.

**Wellsbach Mantle;** → lime light.

**weloganite**; rarely faceted as gemstones.

System: triclinic, pseudotrigonal.

Formula:  $ZrNa_2Sr_3(CO_3)_6 \cdot 3H_2O$ .

Luster: vitreous.

Colors: white, pale yellowish to amber.

Streak: white.

Diaphaneity: transparent to translucent.

Cleavage: {0001} perfect.

Fracture: conchoidal to uneven. Brittle.

SG: 3.22.

H: 3½.

Optics:  $\alpha$ :1.558,  $\beta$ :1.645,  $\gamma$ :1.665.

Birefringence: 0.090.  $\ominus$ .

Found in Quebec, Canada.

**Welsh diamond**; a misleading term for quartz crystal found in Welsh, England.

**weluriya**; same as veluriya.

**Wilverdiend**; small location of alluvial diamond deposit in Lichtenburg, Transvaal Province, South Africa.

**wernerite**; same as scapolite.

**Weskus Mine**; location of marine diamond deposits off the coast of Namaqualand, South Africa.

**wesselsite**; same as sugilite.

**wesselsite**; an igneous rock consisting of mica, nepheline, haüyne and barkevikite. It is light colored.

**Wesselton**; an obsolete term for color grading of diamond of white color, which has a very faint yellowish color from Wesselton Mine at Kimberley, South Africa. It is ranked just between top Wesselton and top crystal. Equivalent to H on the GIA color grading system. A color grade on the Scan. D.N. color grading scale. On the CIBJO and IDC for white. → Top Wesselton.

**Wesselton Diamond Mine**; important location of kimberlite diamond pipe deposits, in Kimberley area, South Africa. It was discovered in 1890.

**Wesselton Simulated Diamond**; a commercial term for man-made spinel used as a diamond imitation.

**Wessex crystal**; → reverse intaglio crystal.

**Wessex starred agate**; same as starred agate from Wessex.

**West Australia**; → Western Australia.

**West End Diamond Mine**; a small location of diamond pipe mine near Postmasburg in the Barkly West area, Cape Province, South Africa.

**West Indies pearl**; bright rose-red with wavy white lines from West Indies.

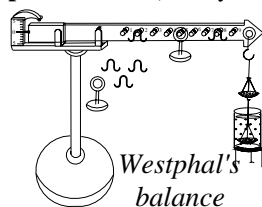
**West Oubangui**; region of diamond deposits within the Central African Republic.

**Western Australia shell**; → Macassar shell.

**Western Australia**; a part of Australia and location of several alluvial and pipe diamond deposits, where occur

beryls and pearls are fished along the coast.

**Westphal balance**; a hydrostatic weighing device of type steelyard for direct measurement of the relative specific gravity of small gemstones by weighing them first in air, then in



water. The specific gravity is obtained by dividing the weight in air by difference between the weights. Also used for measuring the specific gravity of heavy liquids.

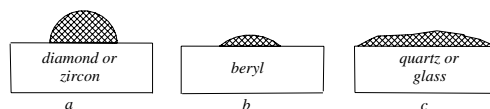
**West's solution**; a highly contact refractive liquid consisting of 8 parts of yellow phosphorus, one part sulfur, and one part of methylene iodide. P:S:CH<sub>2</sub>I<sub>2</sub>. RI:2.05. Care should be taken when using as it is highly combustible.

**West Sudan**; same as Mali Federation, Africa.

**wet digging**; same as alluvial diamond deposits, prospecting along the river valley rather than dry digging such as Barkly West on the Vaal River, South Africa. Also known as pipe deposits.

**wet puddling**; large dam, which used for churning of mixed opal-bearing dirt with water so the waste material run away and solids for searching left.

**wettability**; the ability of a solid or mineral surface to interact with a drop water that is spread over the surface of stone, by which the water form to a coherent film on



*wettability of a drop water on diamond or zircon, on beryl and on quartz or glass*

the surface due to molecular attraction between the water and the surface.

**wettability method**; a simple method for roughly distinguishing between diamond and other similar stones. See wettability.

**WFDB**; an acronym for World Federation of Diamond Bourses.

**whale ivory**; a coarse variety of ivory from long tusk (horn) of the large arctic marine mammal of the narwhal.

**wheel mark**; same as polishing mark, burn marks.

**whern**; an old English term once used for chert.

**whetstone**; any hard, light-colored, fine-grained, cryptocrystalline, siliceous sedimentary rock, similar to chert. Used as a sharpening edge tools. → Novaculite,

honestone.

**whewellite**; very rare gem mineral, which occurs as warty opaline incrustation in limestones. Rarely cut as faceted gems. Prized by collectors.

System: monoclinic.

Formula:  $8[\text{CaC}_2\text{O}_4 \cdot \text{H}_2\text{O}]$ .

Luster: vitreous to pearly.

Colors: colorless, pale yellowish to yellow, brown, white.

Streak: colorless.

Diaphaneity: transparent to translucent.

Cleavage: {101} very good, {001} distinct, {010} distinct, and {110} indistinct.

Fracture: conchoidal to uneven. Brittle.

SG: 2.20-2.25.

H: 2½-3.

Optics:  $\alpha$ :1.489,  $\beta$ :1.553,  $\gamma$ :1.65.

Birefringence: 0.160. ⊕.

Dispersion: 0.034.

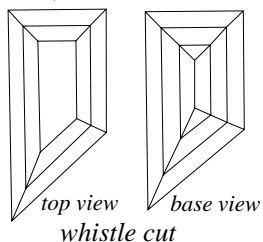
Found in Germany, Hungary, the Czech Republic, France, Russia, and USA.

**whims**; an old large horizontal drums driven by horses and later by steam engines, which was used in mines to lift the containers.

**whip coral**; same as golden coral

**whiskers group**; a term used for a mineral group of tourmaline with this peculiar appearance. Found near Portland, Connecticut, USA.

**whistle cut**; a fancy full cut consists of 4-sided step-cut with one tapered end, which has an outline similar to a



whistle.

**whitamite**; a yellow to reddish variety of epidote.

**Whitby jet**; fine-quality jet from coal mine near Whitby, Yorkshire, England. Used in carved and engraved articles such as seal, beads, buttons and finger rings or faceted gems.

**white**; a commercial term used for transparent colorless gemstones.

**white**; a color grade used on the CIBJO and IDC for polished diamonds equivalent on the GIA color grade system with H. On the Scan. D.N. color scale system equivalent to Wesselton.

**white agate**; white or whitish chalcedony.

**white beryl**; → white gemstone.

**white carnelian**; white or whitish chalcedony of faint carnelian color with perhaps some spots or splashes of

its relation to true carnelian.

**white chalk**; a commercial term for white powder of  $\text{CaCO}_3$ , which used as white coloring pigment, binding mass or vehicle, etc. RI:1.60.

**white chert**; a white or pale colored chert.

**white China**; a term used for Chinese silver.

**White Cliff opal**; location of opal bearing deposits near Wilcannia, New South Wales, Australia. The opals have a milky to white body color to colorless and often replace petrified wood, saurian bones, fossils, and other minerals. → Light opal.

**white cobalt**; a term used for cobalt glance.

**white color grade of diamond**; → white diamond.

**white coral**; white color variety of coral of *Oculinacea vaseuclosa* genus suitable for fashioning and ornamentation.

**white corundum**; same as white sapphire.

**white dammar**; → dammar,-white.

**white diamond**; usually described transparent colorless diamonds.

**white diamond**; color grading of diamonds used on the CIBJO and IDC for polished diamonds equivalent on the GIA color grade system with D to L. On the Scan. D.N. color scale system equivalent to river to top cape.

**white emerald**; a misleading term applied to goshenite a cesium variety of beryl.

**white feldspar**; another term for albite.

**white garnet**; a translucent variety of grossular garnet resembling white jade, found in Tanzania, Africa. Used as a gemstone.

**white garnet**; a misleading term for leucite because its crystal.

**white gemstone**; a term including any transparent colorless gemstone.

**white glass**; → opal glass.

**white gold**; a gold alloy resembling silver or platinum, which is alloyed with nickel, silver, zinc, platinum or palladium. The proportion of nickel and platinum is more than 50% to obtain a white alloy.

**white graphite**; another term for boron nitride or borazon.

**white hose**; a term rarely used by Australian opal miners for a hard cemented patch in the opal dirt at bottom of a vertical which is a good indication for opal.

**white hot**; → incandescence.

**white iron ore**; an obsolete term for siderite.

**white iron pyrites**; a misleading term for marcasite.

**white jade**; a white variety of jadeite.

**white jade**; a white variety of jade.

**white jade**; a misleading term for a translucent variety of grossular garnet found in California, USA.

**White Jade River**; a jade source in Khotan, eastern



Turkistan with the name Yurung-Kash (White Stone).

**white light**; a continuous spectrum of all visible wavelengths or colors such as daylight. Frequently called mixed light.

**white mica**; another term for muscovite.

**white moss agate**; agate, a white chalcedony with white opaque areas.

**white mundic**; another term for arsenopyrite.

**white nights**; → Aurora Borealis.

**white, nontransparent gemstones**; → nontransparent white stones.

**white olivine**; another term for forsterite.

**white opal**; a commercial term for iridescent precious opal with any light body color to distinguished from black opal. → Light opal, White Cliff opal, opal white, Hungarian opal.

**white opal**; same as Hungarian opal.

**white opal cut**; generally cut cabochon, rarely carved, faceted and engraved.

**white pearl**; a commercial term for any white body color pearl, which distinguishes it from other or part-colored natural pearl.

**white pyrite**; another term for arsenopyrite.

**white pyrite**; another term for marcasite.

**white pyromorphite**; another term for white lead ore.

**white quartz**; same as milky quartz.

**whiter**; lower saturation of color. Also called fade. → Color,-definition, saturation.

**white sapphire**; a misleading term for a very attractive clear or colorless variety of corundum. Also called white corundum.

**White Saxon Brilliant**; same as Dresden White Diamond.

**White Saxon Diamond**; same as Dresden White Diamond.

**white schorl**; a misleading term for albite.

**white silk stone**; another term for satin spar.

**white stone**; any various stimulant colorless stones used as an imitation.

**white stone diamond**; a misleading term for any various natural or stimulant colorless stones used as diamond imitations.

**White Tavernier Table Diamond**; same as Great Table Diamond.

**white topaz**; a misleading term for colorless topaz containing more fluorine and less hydroxyl, which is misnomered as Mogok diamond.

**white vitriol**; a term used for glosarite  $ZnSO_4 \cdot 7H_2O$ . Also called white copperas, zinc vitriol.

**white zircon**; → white gemstone.

**whiting**; pure white chalk powder used as a polishing material or as a pigment.

**whole cultured pearl**; a round bead nucleus of mother-of-pearl with a thin layers of nacre mostly not more than one mm in thickness, which is secreted by the mussel. The cross section shows parallel bands of mother-of-pearl nucleus and concentric layers around the nucleus.

**whole good**; same as whole stone.

**whole stone**; a manufacturer's term for whole diamond stone, which has not been sawn or cleaved. Also called whole good.

**whorl**; in conchology a single turn in a spiral shell.

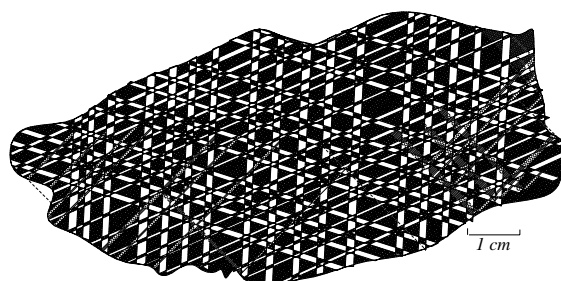
**Wichita diamond**; a misleading term for transparent quartz crystal from Lawton, Oklahoma, USA.

**Wicklow diamond**; a misleading term for transparent quartz crystal from Wicklow, Ireland.

**wide filter**; → color filter, Chelsea color filter, filtered light.

**Widmanstatten figure**; same as Widmanstatten structure.

**Widmanstatten structure**; a triangular geometrical figure can be seen on polished and etched surface of an



*iron meteorite or Widmannstatten pattern*

iron meteorite or so-called octahedrite. Also called Widmanstatten figure.

**wilconite**; a term applied to pinkish red variety of scapolite.

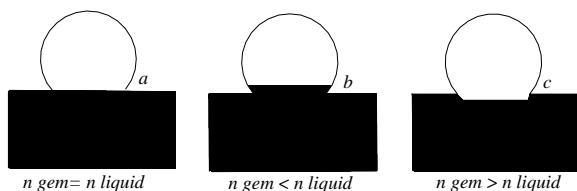
**wild pearl**; a pearl growth naturally as distinguished from cultured pearl.

**Wild method**; a method of determining the refractive index of minerals in a thin section, in which a narrow, bright line of light can be seen under a microscope, at the junction of two minerals of different refractive indices. → Beck line method.

**Wild method in Beck line**; a method of testing the relative refraction indices of stones. A bright line separates substances of different refractive indices. A faceted, transparent stone is immersed in a liquid of a known, refractive index and viewed above through the stone. The petri or dish placed over a white sheet of paper. While a black card passed slowly below the dish: when the stone and liquid having same RI by passing the card both edges of card seen through liquid and stone as a straight line (a). When the edged of the card

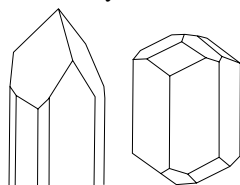
moves into stone with refractive, index lesser than that of the liquid (b). If the edges of the card travel into the liquid, hence the refractive index of the stone is higher than that of the liquid (c). Mainly suitable for small fragments.

**wild rock**; rocks not suitable for commercial proposes.



reading of Beck-line with Wild shadow method

**Wilhelmina Pearl**; a freshwater pearl of 22.8 grains and 9.3 mm in diameter, found in Scotland. Belonged to Abernethy Pearl, now on display at the establishment of Cairncross in Perth, Scotland.



willemite crystals

Also called little Willie. It was known as Bill's Pearl.

**wilkeite**; a rare mineral of apatite group, which contain silica and sulfate. Chemical composition:  $\text{Ca}_5(\text{F},\text{O})(\text{PO}_4,\text{SiO}_4,\text{SO}_4)_3$ . Hexagonal system. Rose red, pale rose, pinkish, yellow. Vitreous to sub-resinous luster. Transparent to translucent. Optics;  $\omega$ :1.640-1.650,  $\epsilon$ :1.636-1.646. Birefringence: 0.010.  $\ominus$ . SG:3.10. H:5. Found in Russia, USA, and Germany. Frequently cut as gems.

**willemite**; a nesosilicate mineral of zinc related to phenacite. Rarely seen as faceted gems, but cut cabochon and prized by collectors. *Troosite* is a massive brown colored manganese-bearing variety. Often associated with franklinite, calcite and zincite. It is synthetically made.

System: hexagonal (trigonal).

Formula:  $18[\text{Zn}_2\text{SiO}_4]$ .

Luster: vitreous inclined to resinous.

Colors: colorless, yellow, shades of green, reddish brown, brown, red, gray.

Streak: colorless.

Diaphaneity: transparent to translucent.

Cleavage: {0001} poor, and {1120} poor.

Fracture: conchoidal to uneven. Brittle.

SG: 3.89 rises with increasing of manganese to 4.20.

H: 5½.

Optics;  $\omega$ :1.601,  $\epsilon$ :1.719.

Birefringence: 0.028.  $\oplus$ .

Found in Quebec (Canada), Zaire, Algeria, Namibia, and Zambia (Africa), Belgium, Greenland, California, New Jersey, Utah, and Arizona (USA).

**willemite absorption spectrum**; a strong band at 421 nm and weak bands at 583, 540, 490, 442, and 432 nm.

**willemite cut**; a transparent crystal mostly of yellow color faceted as brilliant and also cut cabochon and beads sometimes with black franklinite.

**willemite luminescence**; strongly green or yellowish-green fluorescence under SWUV and LWUV light. Frequently strong phosphorescence.

**willemite pleochroism**; variable dichroism.

**William II of Holland Diamond**; a pear-shaped diamond of 10 cts, on which a portrait of William II of Holland is engraved. Now on display at the Chicago Museum of History, USA.

**williamsite**; a local term for massive, translucent, yellowish green, oily looking variety of finest antigorite serpentine, which resembles jade. Frequently with black patches. RI:1.57. SG:2.60-2.62. Found in Rock Spring, Maryland, USA. Weak white green glow under LWUV light. Used as decorative objects and carved. Frequently faceted. → Baltimoreite.

**williamsite cut**; used for ornamental purpose, decorative objects and carved, cut cabochon and frequently are faceted.

**Williamson Diamond**; same as Williamson Pink Diamond.

**Williamson Diamond Mine**; a kimberlite diamond pipe mine discovered in 1940 by Canadian geologist John. T. Williamson in Tanzania, Africa. After death of Williamson mined by De Beers Consolidation Mines, Ltd., and the State of Tanzania. Also called Mwadui Mine.

**Williamson Pink Diamond**; a fine light pink diamond of 54.50 cts, found in 1947 in Tanganyika mine, Tanzania, Africa. It was donated to Princess Elizabeth of England upon her marriage in 1947. Was cut in London into a round brilliant of 23.60 cts. It set in the center of a brooch made as a stylized Alpine rose. Frequently called Queen Elizabeth Pink Diamond. Also called Williamson Diamond.

**wilsonite**; a term applied to a pink-red variety of an altered scapolite. Vitreous luster. SG:2.80. H:3½. Found in New York (USA), and Canada.

**wilsonite**; an igneous volcanic rock consisting of fragments of pumice and andesite in glassy and granular matrix.

**wiluite**; a dark greenish variety of vesuvianite from Wilui River, Siberia, Russia.

**wiluite**; a greenish variety of grossular garnet from

Wilui River, Siberia, Russia.

**Wimbledon Mine;** location of small kimberlite diamond pipe mine in the Kimberley, Cape Province, South Africa.

**winchellite;** a green variety of thomsonite, which is known as lintonite.

**windblown;** same as eolian.

**windblown deposit;** same as eolian deposit.

**windborne;** same as eolian.

**wind-carried;** same as eolian.

**wind-cut stone;** same as glyptolith, ventifact.

**wind-deposited;** same as eolian.

**wind dirt;** a term used by opal miners for the process who hauls up opal dirt on the top from below.

**wind-drift;** same as eolian.

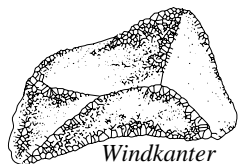
**wind erosion;** the process which wind driven particles abrade each other and deposited may be more or less uniform layers or dunes.

**wind faceted stone;** same as windkanter.

**wind grooved stone;** same as ventifact.

**windlaid;** same as eolian.

**windkanter;** a German term means wind faceted stone.



Windkanter

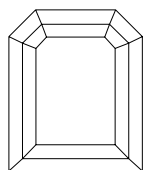
A rock or mineral, which is usually polished, and bounded, with smooth curved flat faces caused by abrasion wind-blown sand. Produced faces are

intersecting in more than one sharp edges or angles. Also called faceted pebble, glyptolith, ventifact.

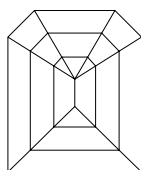
**window;** coated or rough diamonds, which are polished or *opened* by one or two small *windows* on opposite sides of the crystal to enable the designer to see the interior of the stone for inspecting the position of inclusions and color.

**window;** sometimes on a parti-colored native faceted stone such as sapphire an extra facet is cut on the side, this having the effect, when viewed through the table the stone appears uniform in color, but it is parti-colored if looked at from the side.

**window;** frequently on some step-cut, emerald-cut or



top view



base view

window cut

square-cut stones due to too-shallow pavilion angles, which permit to transmit the light. When viewed through the table can be seen the

objects. It is a see through effects.

**window;** some chalcedony geodes containing enclosed water, which are known as enhydros when polished a thin-walled window through which the water is visible.

**window area;** leaking out of light from the bottom of a stone with shallow pavilion in almandine garnet and other gemstone. Also called window in cut stone.

**window cut;** a modified step-cut of gemstones with a hexagon shape of varying length and angles, which has an outline resembling a window with two rectangle and two beveled corners.

**window in cut stone;** same as window area.

**window pan;** another term for Placenta placenta or Placenta shell.

**wind polish;** same as desert polish.

**wind-polished stone;** same as glyptolith, ventifact.

**windsel;** a term used by opal miners for to get air down in a shaft by ventilation. Also spelled winsel, windsock.

**wind-shaped stone;** another term for eolian, glyptolith, ventifact.

**windsock;** same as windsel.

**Windsorten Diamond;** a rough diamond of 140 cts, found in 1961 at the Windsorten Breakwater on the Vaal River, South Africa. It was sold by J.J. Steyn, who found it. Present owner unknown.

**wind transported;** same as eolian.

**wind worn;** wind-eroded.

**wind-worn stone;** same as glyptolith, ventifact.

**wine jade;** a Chinese descriptive term applied to wine colored jade.

**wine red;** an informal term used by Australian opal miners for rich red opal.

**wing;** a tapered area near both ends on a marquise cut stone between the belly and point. It can also be seen in heart-shaped and pear-shaped stones.

**wing pearl;** pearls having flat, elongated, irregular shape that slightly resemble a single insect wing in outline such as pearls from Pinna shell.

**wings;** small included zircon crystals in other stones with darkened halos consisting of brownish wings, caused by stress due to unequal thermal expansion in the host stone.

**wing-shell;** a genus of *Pteriidae* oyster from the Pacific Ocean resembling a single wing of an insects. Rarely produced pearl. Also called Pacific wing oyster.

**winking;** an optical effect, which can be seen in some twinned double refractive gemstones during examination; the doubling of facet edges, when each of the twin images is extinguished alternatively, such as in olivine or peridot, when viewed through the table facet immersed in a liquid.

**winsel;** same as windsel.

**Winston Diamond;** a colorless diamond of 154.50 cts, found in 1952 in the Jagersfontein Mine, Orange Free State, South Africa. It was cut into a pear-shaped brilliant of 62.05 cts, by Harry Winston in 1953. Sold

to the King of Saudi Arabia in 1959. Resold to Harry Winston and was recut into 61.80 cts. It was auctioned in 1981 in Switzerland. Formerly known as Jagersfontein Diamond.

**Winston, Harry;** (1896-1978) a New York gem and diamond merchant. He owned or resold 60 of 303 of the world's famous diamonds. He was involved in the design and fashioning of many famous jewels set with diamonds, rubies, sapphires, etc.

**Winston Heart-Shaped Diamond;** a heart-shaped diamond of 40.97 cts. It was recut by Harry Winston from an emerald cut stone of 59.25 cts, which was cut from a rough stone of 206 cts. He sold it in 1980 to a European client.

**Winston Pink Diamond;** a pink, flawless, marquise cut diamond of 22.84 cts, purchased by Harry Winston in 1975. Was later sold it in 1987.

**Winter's Rush;** location of a small alluvial diamond deposit in the Barkly West area, Cape Province, South Africa.

**Witklip;** location of a small alluvial diamond deposit in the Lichtenburg area, Transvaal Province, South Africa.

**wire drawing dies;** same as diamond wire-drawing dies.

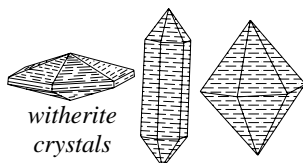
**Wisconsin pearl;** fine fresh-water pearls of *Unio* of purple, light red, light green, steel blue and reddish brown color fished from Mississippi Valley, Wisconsin, USA.

**wisp-like inclusions;** → veil-like inclusions.

**wisps;** → veil-like inclusions.

**wispy inclusions;** mesh or veillike group of inclusions in natural Thailand rubies, which are also seen in synthetic rubies and synthetic emerald produced by hydrothermal, flux-fusion or flux-melt method.

**witherite;** a mineral of aragonite group. Rarely cut as faceted gem and more rarely cut cabochon. Prized by collectors. Associated with barite and galena.



witherite crystals

System: orthorhombic.

Formula:  $4[\text{BaCO}_3]$ . Effervesces in acid.

Luster: vitreous inclined to resinous.

Colors: colorless, gray, white, yellowish, greenish-white, green, brown.

Streak: colorless to white.

Diaphaneity: transparent to translucent.

Cleavage: {010} distinct, and {110} imperfect.

Fracture: conchoidal to uneven.

SG: 4.27-4.35.

H: 3-3½.

Optics;  $\alpha$ :1.532,  $\beta$ :1.676,  $\gamma$ :1.680.

Birefringence: 0.148.  $\ominus$ .

Found in Canada, England, Japan, Russia, and USA.

**witherite luminescence;** greenish yellow luminescence under SWUV light with phosphorescence. Yellowish with phosphorescence under LWUV. Under X-rays fluoresces.

**Wittelsbach Diamond;** a fine-blue diamond of 35.56 cts, of Indian origin. It was a present from Philip IV of Spain to his daughter upon her marriage to Leopold I of Austria in 1664. Later it was part of the Bavarian Crown Jewels. In 1931 Bavaria State, Germany has offered it unsuccessfully for sale at Christie's London. It was offered a second time in 1961 in Belgium where it was acquired by a group of Antwerp dealers and was sold privately in 1964 in Germany.

**Wittelsbacher Treasury;** → Bavarian Imperial Treasury.

**Witwatersrand;** gold mine in South Africa.

**Woblapally Mine;** same as Ovalum Pally Mine.

**wolf's-eye;** a term applied to a variety of moonstone feldspar.

**wolf's-eye;** a misleading term for tiger eye or same as wolf's-eye stone.

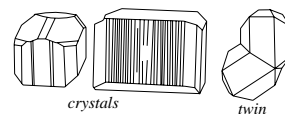
**wolf's-eye stone;** a misleading term for tiger eye but rarely used.

**wolfram;** same as tungsten.

**wolfram;** same as wolframite.

**wolframine;** same as tungsten.

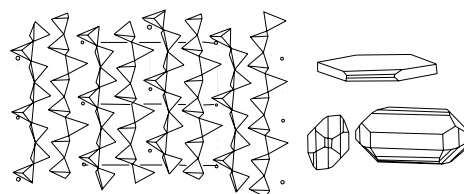
**wolframite;** an isomorphous mineral intermediate between huebnerite and ferberite with the formula  $2[\text{Mn}^{+2}\text{WO}_4]$ . Monoclinic crystal. Translucent. Reddish-brown, brownish-black to deep red. Streak: yellowish to reddish brown or greenish black. Cleavage: {010} perfect. Uneven



wolframite crystals and twin

fracture. Brittle. Optics;  $\alpha$ :2.18,  $\beta$ :2.22,  $\gamma$ :2.30-2.32. Birefringence: 0.014.  $\oplus$ . SG:7.25. H: 4-4½. Found in Peru, the Czech Republic, Nevada, Idaho, Arizona, USA. It is prized by collectors Also called wolfram, wolframine.

**wollastonite;** usually cut cabochon in any sizes, sometimes with weakly chatoyancy. It is Polymorphous



wollastonite structure and crystals

with parawollastonite, cyclowollastonite, and wollastonite-7T. Also called tabular spar, table spar,

System: triclinic.  
 Formula:  $6[\text{CaSiO}_3]$ .  
 Luster: vitreous inclined to pearly, silky on the fibrous.  
 Colors: white, colorless, pale green, red, greenish, gray.  
 Streak: colorless to white.  
 Diaphaneity: transparent to translucent.  
 Cleavage: {100} perfect, {001} good, and {102} good.  
 Fracture: splintery. Brittle.  
 SG: 2.80-3.08.  
 H: 4½-5.  
 Optics:  $\alpha$ :1.616-1.64,  $\beta$ :1.628-1.65,  $\gamma$ :1.631-1.653.  
 Birefringence: 0.014.  $\ominus$ .

Dispersion: 0.014.

Found in Mexico, Norway, Italy, Finland, Rumania, Canada, California, New York, New Mexico, Alaska, and Pennsylvania (USA).

**wollastonite cut**; → wollastonite.

**wollastonite luminescence**; frequently blue-green fluorescence under SWUV and LWUV lights and yellow phosphorescence under both rays. Stone from some sources is none luminescence seen.

**Wolmaransstad**; a trading center and location of small alluvial diamond deposits in Transvaal Province, South Africa.

**wonderstone**; a fine-grained, attractively banded, vary-colored variety of rhyolite. A pyrophyllite igneous rock, which take a good polish. It is a rockhound stone. RI1.58, SG2.72. It is used principally for ornamental objects and decorative stone and sometimes cut as cabochon and in synthetic diamond industry used as a container for the reaction constituent. Found in Nevada, New Mexico, California, USA, and elsewhere.

**wonderstone**; a misleading term for banded dolomite material in red, yellow, green brown, and white from USA and Brazil. → Nevada wonderstone, South African wonderstone, Ottosdal G stone, Koranna stone.

**Won't face**; an term used by opal miners for an apparently good quality opal when cut it shows from one angle color properly.

**wood agate**; another term for agatized wood, fossil wood, petrified wood.

**Wooden Spoon Seller's Sapphire**; same as Rospoli Sapphire.

**wooden stick**; the wooden holder made of branch of a tree about 20 cm long, to which the stones are jointed for cutting and polishing into gemstones. → Dop.



**wood grain structure**; those peculiar structures that can be seen in natural coral but not in Gilson-created coral.

**wood hematite**; a variety of hematite, which is finely radiated and shows alternate yellow and brown bands

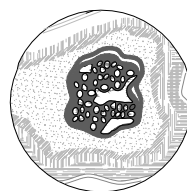
like wood.

**wood opal**; a variety of common opal that petrifies or replaces the organic substances by opal, agate, jasper, etc., which often preserve the structures of wood. Also called xylopal, lithoxyl, petrified opal, wood. → Opalized wood.

**Wood's glass**; → Wood's glass filter.

**Wood's glass filter**; a very dark special glass for very a low visible light spectrum, which transmits ultraviolet radiations between 400 nm and 300 nm suitable for ultraviolet lamps. Also known as Wood's glass. → Filter, long-wave ultraviolet, ultraviolet lamp.

**wood, petrified**; a colloquial term used in the southwestern USA for fossil wood or silicified wood. Also called agatized wood, woodstone, opalized wood, wood opal, shinarump,



*petrified wood from Lesbos, Greece with its cells*

chinarump, lapified wood. → Fossil wood.

**wood stone**; another term for silicified wood, petrified wood, wood opal. Also spelled woodstone.

**wood stone**; a variety of brown, banded jasper like a wood.

**woodstone**; same as wood stone.

**wood tin**; a massive, reniform or botryoidal reddish to brown variety of cassiterite with internal concentric structure with a radiating wood-like structure. Cut cabochon and faceted gems. Found in Mexico. Same as toad's-eye tin, tin ore.

**work hardening**; the increase in hardness, bending or stretching of a metal due to cold working that is caused by permanent distortion of its crystalline structure. It can be restored by heat treatment. Also called strain hardening.

**world eye**; another term for hydrophane or Oculus mundi.

**world's-eye**; another term for hydrophane or Oculus mundi.

**World Federation of Diamond Bourses**; a leading international federation of diamond dealer, clubs, exchanges, founded in 1907 with 20 bourses. Abbreviation: WFDB.

**worm-like inclusions**; → inclusion in synthetic spinel.

**worobieffite**; same as vorobyevite.

**wound**; another term for inclusions or cracks in a crystal developed due to rapid growth or other reasons which may healed after long time or growing as a crystal and the growth liquid penetrated into open wound of the stone.

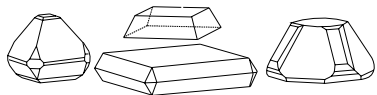
**Woyie River Diamond**; a colorless diamond of 770 cts, found in 1945 in the Woyie River, Sierra Leone, Africa.

It was cut into 30 stones, the largest, of which weighed 31.35 cts. Also called Victory Diamond.

**Wratten A. Filter;** a red gelatin filter producing a sharp readings spectrum.

**writing diamond;** penholder set with a cone shaped diamond used to etch on metal or glasses. Also called pencil diamond.

**wulfenite;** a mineral of scheelite group, isomorphous with stolzite.



wulfenite crystals

Highly dispersive cut as faceted gems of very pretty color with fine brilliance which prized by

collectors. Also called yellow lead ore.

System: tetragonal.

Formula:  $4[\text{PbMoO}_4]$ .

Luster: resinous to adamantine.

Colors: yellow-orange to yellow, red, orange, green, pinkish, gray, white, dark blue.

Streak: white.

Diaphaneity: transparent to translucent.

Cleavage: {011} distinct, {001} indistinct, and {013} indistincts.

Fracture: subconchoidal to uneven. Brittle.

SG: 6.5-7.0.

H: 2½-3.

Optics;  $\omega$ :2.405,  $\epsilon$ :2.282.

Birefringence: 0.123.  $\ominus$ .

Dispersion: 0.203.

Found in Mexico, the Czech Republic, South Africa, Germany, Australia, Algeria, Sardinia, Poland, Austria, and USA.

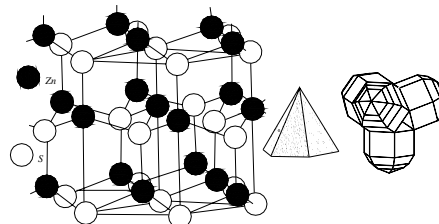
**wulfenite cut;** → wulfenite.

**wulfenite pleochroism;** weak pleochroism in orange to yellow.

**wulfenite synthetic;** synthetic wulfenite is made but not commercially.

**Württemberg jet;** a variety of jet from Württemberg in Swabian Alps, Germany.

**wurtzite;** a trimorphous mineral with sphalerite and



wurtzite structure, crystals and twin

matraite. It has a dispersion over three times more than diamond. → Sphalerite.

System: hexagonal.

Formula:  $2-10[\text{ZnS}]$ . Contain iron.

Luster: resinous to adamantine.

Colors: brownish black, orange-brown.

Streak: brown.

Diaphaneity: translucent.

Cleavage: {1120} distinct, and {0001} imperfect.

Fracture: conchoidal to uneven. Brittle.

SG: 3.90-4.09.

H: 3½-4.

Optics;  $\omega$ :2.356,  $\epsilon$ :2.378.

Birefringence: 0.022.  $\ominus$ .

Dispersion: 0.157.

Found in Italy, Bolivia, Rumania, Peru, England, the Czech Republic, Namibia, and USA.

**wurtzite luminescence;** often fluorescence under LWUV light.

**Wyoming jade;** pale nephrite associated with albite feldspar and tremolite a variety of amphibole found in Wyoming, USA. RI:1.56. SG:2.8-2.95. Also known as snowflake jade. → Jade matrix.

**Wyse ruby;** a misleading term for once an alternate name for Geneva ruby.

# X x

**xaga**; a term used in USA by Californian Indians for obsidian.

**xalostocite**; another term for landerite.

**X-cut quartz**; a special flat slice of a quartz crystal, in which the width of section is at right angles to the prism of the crystal. Piezoelectric effect is used for electrical oscillators.

**Xancus, pearl from**; a mollusk found in tropical waters which is used for making ornamental objects such as mother-of-pearl, buttons, and beads. Frequently obtained pearls.

**xanthite**; a local term for transparent yellow inclined to yellowish-brown variety of vesuvianite found in Amity, New York, USA.

**xanthochroite**; another term for greenockite.

**xanthosiderite**; another term for goethite.

**x-axis**; one of the 3 optic axes which travels with maximum speed of rays.

**x-axis**; an axis in biaxial crystal with lowest index of refraction.

**x-axis**; one of the 3 axes in a three dimensional rectangular space lattice.

**Xe**; a chemical symbol for the element xenon.

**xenocryst**; the crystal grains that are allothigenous in

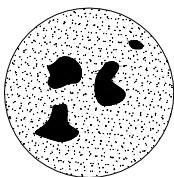


*xenocryst of quartz in rhyolite a quartz porphyre*

igneous rock which have been introduced into the magma from an external source and occur as inclusions such as kimberlite

or lamproite, in which diamonds are xenocryst. Also called cadacryst, chadacryst. → Xenogenetic inclusions.

**xenogenetic inclusions**; inclusions have been introduced into the stone from an external source within the same time of growth. These are foreign materials to the host. Also called xenocryst.



*xenoliths in eruptive rock are seen under microscope also by eye*

**xenolith**; an inclusion or fragment of a mineral having no genetic connection with the igneous rocks, in which

they occur. This is characteristic of kimberlite or lamproite or eclogite xenolith. Also called exogenous

inclusion, accidental inclusion.

**xenolith in kimberlite**; characteristic foreign fragment of rocks, which occur in kimberlite having no genetic connection with it.

**xenomorph**; when a crystal has not formed its own normal shape or habit, but takes the form of pre-existing crystals. Also called allotriomorphic, anhedral crystals, leptomorphic, anidiomorphic.

**xenomorph crystal**; → xenomorphic.

**xenon**; a very heavy, zerovalent, colorless, odorless, inert, noble gas in the group O (noble gas group) of the Periodic System, with the symbol Xe.

**xenothermal**; a mineral, rock or ore deposit formed at high temperature but shallow depth.

**xenotime**; a mineral isostructural with zircon and closely resembled them. Used as an ornamental stone and as a zircon imitation. It has flower like radiating crystal aggregates. *Kiku-ishi* is a Japanese name for flower-like radiating zircon, and xenotime crystals. Moderately radioactive.

System: tetragonal.

Formula:  $4[Y(PO_4)]$ . Often contains Ce, Er, U, Th, Zr, etc.

Luster: vitreous to resinous.

Colors: pale yellow, yellowish brown, reddish brown, pale gray, greenish, reddish brown.

Streak: colorless.

Diaphaneity: translucent to opaque.

Cleavage: {100} perfect.

Fracture: uneven splintery. Brittle.

SG: 4.40-5.10.

H: 4½-5.

Optics;  $\omega$ : 1.720,  $\epsilon$ : 1.816-1.827

Birefringence: 0.107. ⊕.

Dispersion: high.

Found in Malagasy, Japan, Canada, Brazil, Norway, South Africa, New Zealand, and India.

**xeuxite**; a term sometimes applied to a variety of zeuxite.

**xi**; a Chinese term for a pin-form piece carved of jade, or may be a knot unraveller. → Chinese ritual and symbol jades.

**xiao xi**; a Chinese term for a small knot loosener made of jade. → Chinese ritual and symbol jades.

**xibi**; a Chinese term for a pity disc made of jade used as girdle pendant. → Chinese ritual and symbol jades.

**xieshi**; a Chinese term for green sphene used as jade.

**xieweichang shi**; a Chinese term for green microcline used as jade.

**xilopalo**; a Spanish spelling of wood opal.

**Xin-jade**; a term used incorrectly for antigorite from Xinyan, China.

**Xinyi-jade**; a term used misleadingly to refer to antigorite from Guangdong, China.

**Xique-Xique Diamond;** same as Carbonado Xique-Xique Diamond.

**xiuitl;** a term used by Aztecs Mexican Indians for turquoise found near the city of Mexico.

**xiyu;** location of kimberlite diamond pipe north of the town of Mengyin, China.

**xonotlite;** very rare mineral that is rarely cut as faceted gemstone, prized by collectors. It takes a good polish. Also called calcium pectolite, jurupaite, xonaltite, and eaklriete.

System: monoclinic.

Formula:  $2[\text{Ca}_6(\text{OH})_2\text{Si}_6\text{O}_{17}]$ .

Luster: greasy, pearly to vitreous.

Colors: colorless, white, pale gray, pink.

Streak: colorless.

Diaphaneity: translucent to transparent.

Cleavage: one direction.

Fracture: not determined. Tough.

SG: 2.70.

H:  $6\frac{1}{2}$ .

Optics:  $\alpha: 1.583$ ,  $\beta: 1.583$ ,  $\gamma: 1.593$ .

Birefringence: 0.010.  $\oplus$ .

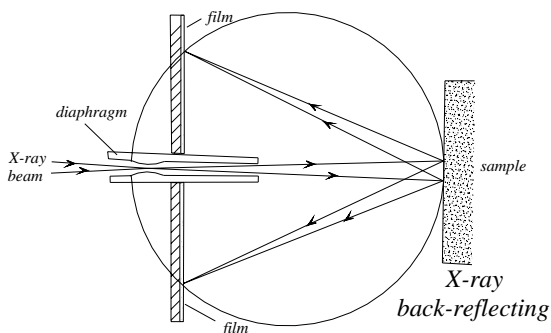
Found in Xonotla (Mexico), California, Michigan, Virginia (USA), Italy, Venezuela, and Canada.

**X-radiation;** same as X-rays.

**X-radiography;**  $\rightarrow$  shadowgraphs.

**X-ray analysis;** use of diffraction pattern by means of X-ray methods to study the structure, and atomic composition of crystalline materials, which have crystalline phases.

**X-ray back reflection method;** a method in X-ray



crystal analysis used for determination of single crystals like quartz or ruby and crystalline material such as chalcedony or turquoise. The plate of film is set in front of the specimen and a diffraction pattern is produced, this is known as a *back-reflected method*, or it can be set behind the crystal and that is called the *transmission method*.

**X-ray characteristic spectrum or radiation;**  $\rightarrow$  X-rays, characteristic spectrum or radiation.

**X-ray, color change by;**  $\rightarrow$  color change by X-ray.

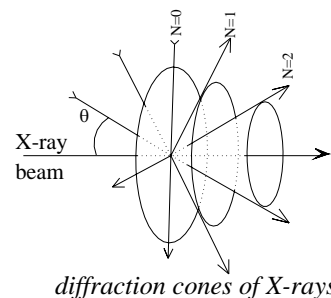
**X-ray, continuous radiation of;** the produced wavelengths of X-rays according to the electromagnetic theory of light consisting of continuous band of wavelengths, which are a mixture of all wavelengths. Depends on the used voltage of apparatus, which is known as *white X-ray radiation* or *general X-ray radiation*.

**X-ray crystal spectrometer;** a device to obtain an X-ray spectrum for determining the wavelength of its chemical constituent. Each element, when irradiated by electrons, emits X-ray of several characteristic frequencies the line spectrum depending on the atomic number.

**X-ray crystallography;** the principal analysis method of crystal structure, texture, identification and behavior of a crystal by examination of the diffraction of X-rays, which are directed through a crystal or on to a crystal specimen. The observed diffraction pattern is used for X-ray analysis.

**X-ray diamond tester;** a device for detecting true diamonds from diamond imitations. Due to transparency of diamond to X-rays and nontransparent or opaqueness of imitations. The bottom of the device is covered with a fluorescence plate by means of low energy X-rays, which are transparent or opaque stone observed as a shadow profile.  $\rightarrow$  X-ray photograph.

**X-ray diffraction;** a technique of analysis of diffraction pattern crystals (or pearls) by means of a X-ray beam of known wavelength, which is directed through a crystal or on to a crystal. The diffraction pattern depends on the three-dimensional arrangement of crystal structure of the material. The usually used diffraction methods are: Lauegrams technique gives, which a pattern of

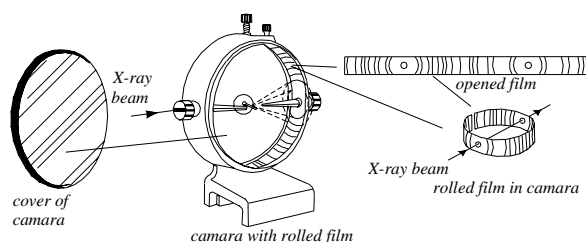


spots, X-ray powder photography, which gives a pattern of rings, and the X-ray back reflection method, which also produces a pattern of spots. Also used to distinguish between natural pearl and cultural pearl.

**X-ray diffraction analysis;** same as X-ray diffraction.

**X-ray diffraction pattern;** when X-ray beams of known wavelength are directed through a crystal or on to a crystal they produced a diffraction pattern, which depends on the crystal structure of the material. The diffraction methods are: Lauegrams technique, X-ray





X-ray powder camara

powder photography, and the X-ray back reflection method. → X-ray diffraction.

**X-ray emission;** another term for X-ray fluorescence.

**X-ray filters;** to generate monochromatic X-rays or line spectrums only one wavelength used is a suitable selective filter made of very thin layers of metal elements. There have one or two atomic numbers lower than the target metal such as nickel with atomic number 28 used as a filter for copper target with atomic number 29.

**X-ray fluorescence;** if a crystal is irradiated by an intense X-ray or gamma-ray beam, this induces the substance to emit its visible characteristic secondary X-ray line spectra of a longer wavelength, which is known as X-ray fluorescence. It is a nondestructive method. Used to separate diamonds from remaining materials. Also called X-ray emission. This effect may be seen in some stones and pearls a visible various glows in darkness. → Luminescence.

**X-ray fluorescence analysis;** → X-ray fluorescence.

**X-ray fluorescence pearl testing;** → X-ray fluorescence.

**X-ray fluorescence recovery of diamonds;** → diamond recovery by X-ray fluorescence.

**X-ray fluorescence spectroscopy;** a method used for qualitative analysis of a crystal by means of X-ray fluorescence.

**X-ray for detection pearls in oyster, using of;** → using X-ray for detection of pearls in oysters.

**X-ray Lauegrams;** → Laue method, Lauegrams.

**X-ray line spectrum;** → X-rays.

**X-ray luminescence;** → luminescence.

**X-ray microscope;** using of X-ray radiation in transmission microscopes in a state normal white light. → Electron microscope.

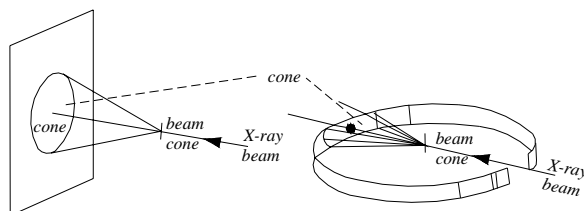
**X-ray pearl testing;** → X-ray diffraction.

**X-ray photograph;** production of shadow photographs from opaque substances by means of X-ray, which discover the internal structure, while they are opaque to normal light. Used to distinguished between natural pearls and cultured pearls and imitation materials in

Lauegrams or X-ray radiography. → X-ray diamond tester.

**X-ray photograph of pearls;** → shadowgraphs, X-ray diamond tester.

**X-ray powder diffraction;** a method to obtain diffraction pattern of gemstones, minerals, or other materials by passing an X-ray through a small sample



X-ray diffraction of powder

of very fine powder. The diagram or photograph exhibits a diffraction pattern of curves or lines, distribution and intensity of substance. Used in identification of gemstones and other materials. → X-ray diffraction, powder diffraction by X-ray analysis.

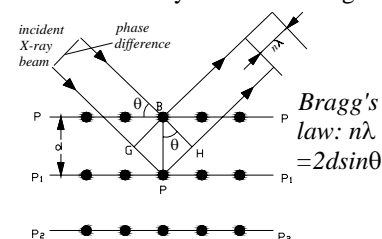
**X-ray powder pattern;** a characteristic interference pattern in the form of rings or spots produced on photographic film by means of X-ray beam, when it strikes fine powdered material.

**X-ray precaution;** → safety precaution.

**X-ray radiography;** → shadowgraphs.

**X-ray recovery of diamonds;** → diamond recovery by X-ray fluorescence.

**X-rays;** non-nuclear, high penetrating, electromagnetic radiation of very short-wavelength having the nature of



visible light ranging from gamma rays to

shortest ultraviolet rays or from 0.01

nm to 10 nm. It is produced by

accelerating electrons to high velocity in a vacuum tube and suddenly stopping on tungsten or other metallic element target. This produces wavelengths of the line spectrum, emission spectrum or line and is known as the *characteristic spectrum* or *characteristic radiation*, which are characteristic of the emitting element of the target. This produces wavelengths according to the electromagnetic theory of light has a continuous band of wavelengths, being a mixture of all wavelengths depends on the voltage of the apparatus, which is known as *white X-ray radiation* or *general X-ray radiation*. X-rays can be refracted, reflected, polarized

and penetrate opaque substances. They cause interference and diffraction hence they are used in the identification of materials, gemstones, and as a source of energy to expose photographic film after transmitting through pearls and revealing the fine structures of natural and cultured pearls. Cultured and fresh-water pearls usually shows fluorescence under X-ray radiations. Some synthetic stones exhibit fluorescence under X-rays such as synthetic red spinel (organ pipe), or synthetic corundum phosphoresces, while true corundum is inert. Also used in industry for separating diamonds and treatment with X-ray. It was discovered by Roentgen (Röntgen) in Germany in 1895. Also spelled x-rays or X rays, and called Roentgen ray, X-radiation. → Radiograph, autoradiography, Type of diamond.

**X-ray separation;** a device to separate diamonds from diamond-bearing gravel or crushed rocks, which is passed down a hopper where it passes through an X-ray beam. The beam makes the diamonds glitter so that they are seen by a photo-multiplier and an air jet ejects the diamonds from the remains. → Diamond recovery by X-ray fluorescence.

**X-ray skiagram;** → shadowgraphs, X-ray.

**X-ray spectrograph;** any X-ray crystal spectrometer equipped with a device to record or to make an X-ray diffraction pattern. Is useful in fluorescence analysis.

**X-ray spectroscopy;** → X-ray crystal spectrometer.

**X-ray spectrum;** several characteristic lines of the spectrum of X-ray (or other rays), which are emitted by a bombardment of material with electrons such as curved dark lines on the films produced by X-ray method of powder diffraction of stones or minerals.

**X-ray topography;** using X-rays for scanning

photograph, which reveals the internal flaws or structure defects of gemstones or diamonds and for distinguishing them from its imitations, while other stones other than diamond are less transparent. It is used in fingerprinting of gemstones, but not commercially. The photograph obtained from emerging X-ray from diamond is developed onto a photo sensitive plate.

**X-ray transmission method;** → X-ray back reflection method.

**X-ray, transparency to;** a degree of radiability of X-rays such as diamonds, which are transparent to X-ray. → Radiability, X-ray diamond tester, transparency to X-rays.

**X-ray tube;** a high-voltage, high-vacuum tube used in X-ray technique to produce X-rays.

**xuan;** a Chinese term for a piece of jade used as an astronomical instrument. → Chinese ritual and symbol jades.

**xuanji;** a Chinese term for a piece flat disc with serrated edge and hole made of jade. → Chinese ritual and symbol jades.

**xylene;** a hydrocarbon clear-liquid of chemical formula:  $C_6H_4(CH_3)_2$ . Insoluble in water but soluble in alcohol and ether. Is known as dimethyl-benzene. Used for refractive indices test RI:1.49. Also called xylo.

**xylo;** same as xylene.

**xyloid jasper;** same as jasper fossilized wood.

**xyloinite;** a commercial term for synthetic cellulose thermoplastic. Used in jewelry.

**xylopal;** a fancy term applied to an opalized fossilized wood.

# Y y

**Y**; a chemical symbol for the element yttrium.

**yachang**; a Chinese term for a half tablet with a tooth made of jade used for mobilizing troops and as a sign for administering military position. → Chinese ritual and symbol jades.

**yaduo**; a Chinese term for thick edges of specimen made of jade.

**YAG**; an acronym for yttrium aluminum garnet.

**YAG LASER**; → yttrium aluminum garnet.

**Yarkand jade**; a jade-bearing source of East Turkistan stones are found as river boulder.

**yahalom**; a biblical term for the sixth stone in the breastplate of the High Priest. It is believed to have probably been green jasper, rock crystal, jade or possibly onyx. It was engraved with the name Zebulom.

**yakhont**; an old Baktrian term now a part of the Russian Federation, CIS. Spelled in Farsi or Persian as yaghout, which means sapphire.

**yakhont**; may have be an amethyst, hyacinth, sapphire, ruby, etc.

**Yakut Diamond**; a rough diamond of 32 cts, found in 1953 in Sakha (Yakutia), the Russian Federation, CIS. Present owner unknown.

**Yakutalmaz**; a mining division of Almazy Rossii-Sakha in Sakha (Yakutia), the Russian Federation, CIS, which controlled the mining of diamond. → Almazy Rossii-Sakha.

**Yakutia**; location of numerous kimberlite diamond-bearing pipes in sub-arctic Sakha (Yakutia), Siberia, the Russian Federation, CIS. Also spelled Yakutiya.

**yakutite**; a local term for bort or dark-colored diamond, which owes its color to impurities. Found in Sakha (Yakutia), the Russian Federation, CIS. It is similar to carbonado.

**Yakutiya**; same as Yakutia.

**yamaskite**; a term applied to a hornblende-jacupirangite from Mount Yamaska in Quebec, Canada.

**yamatoite**; a variety of garnet. → Garnet.

**yangqi shiji**; a Chinese term for green actinolite used as jade.

**yanolite**; a term applied to a natural violet colored variety of axinite a borate silicate.

**yaqui onyx**; a local misleading term for marble from Baja, California, USA.

**Yarkand jade**; nephrite a variety of jade cut and

promoted in Yarkand, Turkestan, the Russian Federation, CIS.

**Yava onyx**; a misleading term for citron yellow variety of dripstone onyx marble (stalagmitic marble) from Yavapai County, Arizona, USA, which contain orange veins. It is similar to Mexican onyx.

**yashpeh**; same as yashpneh.

**yashpneh**; a biblical term for the twelfth stone in the breastplate of the High Priest. It was translated and generally believed to be green jasper. It was engraved with the name Assher. Also spelled yashpeh.

**yawya**; same as gaungsa.

**Y-axis**; one of the 3 optic axes and intermediate axis in biaxial crystal.

**Y-axis**; one of the 3 axes in a three dimensional space lattice.

**Yb**; a chemical symbol for the element ytterbium.

**Y-cut quartz**; a special flat slice of a quartz crystal, in which the width of the section is parallel to the prism face of the quartz crystal. Piezoelectric effect used for electrical oscillators.

**yebangwet**; a mining term used in Myanmar, (Burma) for a pear-shaped washing place for removing *byon*.

**yehuda treatment**; a colorless glass-like material used as an impregnation or filling agent to improve the appearance and reduce the visibility of inclusions in stones such as diamonds and emeralds.

**yellow**; another term for litharge a yellowish or reddish monoxide of PbO.

**yellow**; an alternate color on the Scan. D.N. color grade system for diamonds over 0.47 cts, beginning at the low end of light yellow, equivalent to GIA color grade system ranged from S to Z. → Yellow diamond.

**yellow**; the color sensation with the wavelength ranging from 577 to 597 nm.

**yellow anil dye**; a basic compound derived from an aromatic aniline amine that by heat changes its color from yellow to red or vice verse. The color change is reversible. Used as dyes. → Photochromism.

**yellow apatite**; a natural attractive yellow-colored apatite containing rare-earth elements didymium, which causes the color.

**yellow amber**; natural yellow-colored amber.

**yellow apatite, absorption spectrum of**; absorption spectrum lines are seen at 584 and 578 nm.

**yellow Ashover spar**; a local term for yellow fluorite from Derbyshire, England.

**yellow belly**; → blonde shell.

**yellow Cape diamonds**; → Cape series diamonds.

**yellow carnelian**; yellow to red chalcedony, the color caused by iron oxide.

**yellow chrysoberyl**; yellow-greenish to light yellow or brown chrysoberyl, which contains ferric iron as an

impurity. Has an absorption spectrum band at first part of the violet at 444 nm, which can be seen in some chrysoberyl cat's-eyes.

**yellow clear amber;** a variety of natural transparent, yellow-colored amber.

**yellow color grade;** a fancy color grading for polished diamonds ranging from yellowish to yellow.

**yellow copper ore;** another term for chalcopyrite.

**yellow corundum;** → oriental topaz.

**yellow diamond;** diamond with a yellow body color, fancy yellow, canary yellow, etc. → Color grade, Cape stone, Cape series diamonds, canary diamond, fancy color diamond.

**Yellow Goddess Diamond;** an emerald cut diamond of 29.50 cts, fashioned from a rough stone of 100 cts. Was exhibited by a jeweler in Beverly Hills in Los Angeles, USA. Whereabouts unknown.

**yellow gold;** same as gold color.

**yellow gold;** a gold alloy of yellow color.

**yellow-green apatite;** same as asparagus stone.

**yellow ground;** kimberlite rock that weathered and decomposed to blue ground. It weathers by oxidation at the surface to yellow ground, found above blue ground at the surface of diamond pipes. In these masses diamonds are found. Also known as diamondiferous formation.

**yellow hot;** → incandescence.

**yellowish;** an alternate color on the Scan. D.N. color grade system for diamonds over 0.47 cts, beginning with light yellow, equivalent to GIA color grade system ranged from O to R. → Yellow diamond.

**yellow lead ore;** another term for wulfenite.

**yellow metal;** another term for gold.

**yellow ochre;** a mixture consisting of iron oxide and silicates and clay, when yellow brown in color it contains limonite. Used in jewelry for solder work.

**yellow ochre;** another term for yellow variety of limonite.

**yellow orthoclase;** an attractive, transparent yellow variety of orthoclase feldspar from Malagasy, Africa, which contains ferric iron as an impurity and has two weak absorption spectrum bands at 448 and 420 nm, and a strong band in the ultraviolet at 375 nm. Weak red to orange glow under SWUV and X-rays. Some samples from Myanmar show cat's-eye effect and glow yellow under X-rays. Some glassy varieties of orthoclase from near Laacher See, Koblenz, Germany are called sanidine. Cut and faceted as gemstone.

**yellow pearl;** yellow pearl obtained from small species of *Margaritifera carcharium* fished along the coast of Shark Bay, Western Australia.

**yellow pyrite;** another term for chalcopyrite.

**yellow quartz;** a transparent quartz variety of yellow

color that is known as citrine, which ranges in color from pale yellow to yellow-orange. It exhibits a perceptible dichroism. Brown-yellow variety is obtained by heat treatment from certain types of amethyst. The color caused by ferric iron ( $\text{Fe}^{3+}$ ). Most yellow stones in trade were produced by heating amethyst or smoky quartz, which has been sold under such erroneous names as *topaz*, *Spanish topaz*, *Saxon topaz*, *Madeira topaz*, *Bohemian topaz*, *Brazilian topaz*, *Indian topaz*, and *Madagascar topaz*.

**yellow sapphire;** a yellow natural colored sapphire from Sri Lanka, Thailand, and Australia, which contains ferric iron ( $\text{Fe}^{3+}$ ) and nickel as impurity. It has three spectrum bands in the blue at 450, 450, and 471 nm. Those from Sri Lanka shows an apricot-yellow fluorescence. Synthetic yellow orange colored sapphire has red fluorescence due to nickel or chromium.

**yellow sapphire absorption spectrum;** → yellow sapphire.

**yellow sapphire fluorescence;** → yellow sapphire.

**yellow spessartite;** spessartite garnet of yellow color inclined to orange contains manganese as impurity has two strong bands in the blue at 462 and 432 nm, and two weak bands at 495, and 485 nm. Two narrow bands at 424 and 412 nm.

**yellow sinhalite;** an attractive yellow-colored sinhalite from Sri Lanka, Myanmar, Tanzania, or USA, which contains ferric iron ( $\text{Fe}^{3+}$ ) as an impurity and has a band in the blue at 463 nm, a weak band at 527 nm, and five bands at 493, 475, 463, 450, and 436 nm.

**Yellow Tiffany Diamond;** same as Tiffany Diamond.

**yellow spodumene;** attractive yellow-colored spodumene contains ferric iron ( $\text{Fe}^{3+}$ ) as impurity has two narrow bands in the violet at 438 and 432.5 nm.

**Yellowstone National Park;** location of obsidian in Obsidian Cliff in the Yellowstone National Park, USA.

**yellow topaz;** precious topaz of shades of yellow.

**yellow tourmaline;** yellow variety of tourmaline that resembles topaz.

**yellow zircon;** yellowish brown colored zircon from Sri Lanka containing uranium as an impurity has several spectrum bands at 691, 662.5, 659, 653.5, 589.5, 537.5, 515, 484, and 432.5 nm.

**yellow zoisite;** a transparent, yellow variety of zoisite, which changes its color to colorless on heating.

**yenite;** → ilvaite.

**Yengema;** a city and location of alluvial diamond deposits in Sierra Leone, Africa.

**yemerarudo;** a Japanese term for emerald.

**yeong-twe;** a Burmese term used for second class of best ruby named as yeong-twe or rabbit's-blood the color is more bluish red. → Corundum classification in Myanmar.

**yeshewenshi**; a Chinese term for green antigorite used as jade.

**yeso**; a Spanish term for gypsum.

**yi**; a Chinese term for a cooking vessel made of jade, which is originally made of bronze. → Chinese ritual and symbol jades.

**yield**; the weight of diamonds or valuable ores obtained per ton, for diamond using the unit carats.

**yield**; the weight of polished diamond or other gemstones given as a percentage against the weight of the rough stone.

**YIG**; an acronym for yttrium iron garnet.

**yin**; a Chinese term for an official seal made of jade. → Chinese ritual and symbol jades.

**Yincheng**; location of alluvial diamond deposits in Hubei Province, China.

**yingqing**; a Chinese term for a kind of shadow blue ceramic used as a jade imitation. Yingqing is meaning shadow blue.

**yin-yang**; a Chinese term used for a cosmology combines interacts with their opposites carved on jade to symbolize to produce everything, which comes into existence or principle of opposites (moon and sun), with the five elements. Also spelled *yang-yin*. → Chinese ritual and symbol jades.

**yi zao yu**; a Chinese term used for rough jade skin.

**Yogo Gulch**; location of fine dark-blue sapphire deposit from Yogo Gulch, Montana, USA.

**Yogo sapphire**; → Yogo Gulch.

**Yorkshire stone**; a variety of limestone from Yorkshire, England used for building cladding.

**young**; a term used by opal miners for potch and color, which is of inferior value.

**young amber**; a transparent, pale champagne color amber from Tanzania, which is softer than Baltic amber. It is older than copal resin and younger than amber. Another name for Tanzania amber.

**Young-Helmholtz theory of color vision**; the theory that the eye contains three different groups of retinal fibers (cones) with maximum response to three primary colors to red-yellow, green, and blue-violet, which are parts of the spectrum.

**Youssouppoff Diamond**; → Polar Star Diamond.

**Youssouppoff Pearl**; a pearl of 120 cts, (480 grain) from India was purchased in 1620 and later owned by Philip IV of Spain and after changing hands several times was bought by Youssouppoff a Russian Princess.

**youstone**; an old term in English language for jade or nephrite.

**youth**; → elevation.

**yowah**; location of opal deposits in center of Quilpie, Queensland, Australia.

**yowah nut**; a sub-variety of small boulder opal of size

near a walnut or almond composed of a center kernel of opal with a regular band some have siliceous colorful limonite (ironstone) center surrounded with opal or traversing the kernel. Found in Yowah, Quilpie, Queensland, Australia.

**yowah nut**; same as angel stone.

**yttralex**; a commercial term for transparent synthetic yttrium oxide (Y<sub>2</sub>O<sub>3</sub>). It is a ceramic produced by heat and high pressure. Crystallized cubic by adding 10% of thorium oxide (ThO<sub>2</sub>), which stabilize the compound. RI:1.92 with high dispersion. SG:4.84. H:6½. Used as a gem imitation.

**ytterbium**; a silvery luster, malleable, rare earth metallic element of yttrium subgroup of the Periodic System with the symbol Yb. Used as garnet doping.

**yttrium**; a dark gray, silvery luster, rare earth metallic element of the Periodic System with the symbol Y. Flammable when powder form. Used in alloys and as a metal deoxidizer.

**yttrium aluminate**; a transparent, synthetic product of YAlO<sub>3</sub>. Orthorhombic system. Colorless or can be doped in vary colors by transition elements. Optics; α:1.938, γ:1.955. Birefringence: 0.017. SG:5.35. H:6½. Used as a diamond imitation. Grown by Czochralski technique.

**yttrium aluminum garnet**; a transparent, highly refractive, synthetic product of Y<sub>3</sub>Al<sub>5</sub>O<sub>12</sub>, which has no counterpart in nature but similar structure as garnet. Cubic system. Vitreous luster. Colorless but can be doped in various colors by transition elements. Yttrium giving green color, dysprosium giving yellowish green color, terbium giving yellowish color, erbium giving lilac color, holmium giving golden yellow color, lutetium and ytterbium giving yellowish color. RI:1.833. Dispersion: 0.028. SG:4.55. H:8¼. Used as a diamond imitation and in LASER technique, when neodymium is doped to generate a continuous beam in infrared ray, this is known as Nd-YAG. Abbreviation: YAG. In trade has unnumbered commercial names. It is made by Czochralski process. Also called ytrogarnet, yttrium garnet. → Synthetic garnet.

**yttrium garnet**; another term for yttrium aluminum garnet.

**yttrium iron garnet**; a misleading term for an opaque, black, metallic luster, synthetic product of Y<sub>3</sub>Fe<sub>5</sub>O<sub>12</sub>. It has magnetic properties and is used in infra-red laser rays. Frequently used as gems like hematite but colorless streak. Abbreviation: YIG. → Garnet species and varieties.

**yttrium oxide**; a synthetic colorless to yellowish product of Y<sub>2</sub>O<sub>3</sub>. Cubic system. RI:1.92. SG:4.84. H:7½-8. Used as a diamond imitation. In trade it is called yttralex.

**yttrium, other compounds of** ; other transparent, synthetic product of yttrium are: (a) yttrium aluminate. (b) Yttrium oxide or with trade name yttralox. (c) A green product of  $Y_3(Al,Ga)_5O_{12}$ . Which under LWUV shows a strong red fluorescence. RI:1.88-1.9. SG:5.05-5.08. Mostly used as a grossular imitation.

**yttrium tantalite**; another term tantalite of yttrium.

**ytrogarnet**; an imitation garnet which has no counterpart in nature. Also called yttrium iron garnet. → Garnet, garnet species and varieties, yttrium iron garnet.

**ytrogarnet**; another term for yttrium aluminum garnet.

**yu**; or yü a Chinese term which confused the nature of jade and included green stones such as jadeite, nephrite, bowenite and frequently serpentine, agalmatolite or soapstone and marble. This name provided that the term jade remain as a legend and mystery.

**yu**; a Chinese term for a wine vessel with swing handle and cover made of jade, originally is made from bronze. → Chinese ritual and symbol jades.

**yu**; an old and historic Chinese term for jade. Also spelled Yuh, yü or Yü jade.

**yuan**; a Chinese term for a flat ring or disc with a big hole made of jade used for summoning statesmen. Frequently a ring made of jade with sides wider than central hole. → Chinese ritual and symbol jades.

**yuan**; a Chinese term for a disc with very large hole made of jade. → Chinese ritual and symbol jades.

**yuan**; a Chinese term for a disc with very large hole twice the diameter of the periphery radius, made of jade. → Chinese ritual and symbol jades.

**Yuan River**; location of alluvial diamond deposits along the Yuan River in Hunan Province, China.

**Yubileiny Diamond**; a rough diamond of 32.56 cts, found in 1956 in Sakha, the Russian Federation, CIS. Present owner unknown.

**yü**; same as yu.

**yué axe**; a Chinese term for a wide-bladed disc axe with a hole and symmetrical side notches made of jade. → Chinese ritual and symbol jades.

**yu fu**; a Chinese term for a fish tally made of jade, used by authorities in the mobilization of troops. Same use

as hu fu. → Chinese ritual and symbol jades.

**yugawaralite**; a rare mineral of zeolite group. Cut as faceted gems.

System: monoclinic.

Formula:  $2[CaAl_2Si_6O_{16} \cdot 4H_2O]$ .

Luster: vitreous.

Colors: colorless, white.

Streak: colorless.

Diaphaneity: transparent.

Cleavage: {010} imperfect.

Fracture: highly brittle.

SG: 2.23-2.25.

H: 4½.

Optics:  $\alpha$ :1.490-1.495,  $\beta$ :1.497-1.501,  $\gamma$ :1.501-1.509.

Birefringence: 0.011-0.014. ⊕.

Found in Yugawara (Japan), Bombay (India), Hot Spring (Alaska), Canada, China, Sardinia, Iceland, and Columbia.

**Yü jade**; same as Yü.

**Yuh**; same as Yü.

**yui ko lu jade**; a jade piece, which has been buried in a tomb and over time has altered its color to green, brown or reddish skin by bronze articles.

**yukon**; location of nephrite in the Upper Lewes River in Yukon, Colombia.

**yunlong**; a Chinese term for cloud and dragon carved of jade. → Chinese ritual and symbol jades.

**Yunnan**; location of ruby and sapphire of inferior quality from Yunnan Province of China.

**Yunnan jade**; imported dikes and alluvial jadeite pebbles from Myanmar, which are marketed through the Yunnan Province of China. Before being imported to China or other countries they are *mawed*. → Mawed jadeite.

**yu shao**; a Chinese term for a tip staff made of jade, used in ancient rituals. → Chinese ritual and symbol jades.

**yustone**; another term for jade.

**yu yen stone**; a Chinese term for massive, green variety of serpentine.

**yu zhi**; a Chinese term for an axe made of jade, used in military.

# Z z

**zabab**; → zobabi.

**zaba gem**; a commercial term for man-made rutile used as a diamond imitation.

**zabarjad**; same as zeberged.

**zabarjat**; same as zeberged.

**zabeltizer diamond**; a misleading term for quartz crystal from Zabeltitz, Saxony, Germany.

**zabunijj**; same as sabuni.

**zaffer blue**; another term for cobalt blue.

**zafirina**; a Spanish spelling of zarafina.

**zafiro**; a Spanish term for sapphire.

**zafiro**; frequently used misleading term for lapis lazuli.

**záhábí**; an Arabic term for gold-colored emerald.

**Zaire diamonds**; a west central African country formerly known as the Belgian Congo, which is the location of largest diamond deposits (alluvial and kimberlite pipe) since 1907.

**Zale Light of Peace Diamond**; → Light of Peace Diamond.

**Zamza River**; a river in Central African Republic and location of alluvial diamond deposits.

**Zandfontein Farm**; location of alluvial diamond deposits near the Vaal River, South Africa. → Star of South Africa.

**Zanzibar copal**; a term applied to semi-fossilized copal from Zanzibar, East Africa. By native is calling *chakasi*. Also called jackass copal.

**Zanzibar pearl**; pearls fished on the east coast of Zanzibar, East Africa.

**zarafina**; a misleading term for blue spinel.

**zarafina**; a misleading term for blue chalcedony.

**Zarafshan River jade**; a Farsi (Persian) term meaning gold-bearing (gold scattering), river in Yarkand, East Turkistan in which found boulder of jades.

**zaratite**; an emerald green mineral prized by collectors. Also called emerald nickel.

System: cubic.

Formula:  $2[\text{Ni}_3(\text{CO}_3)_2(\text{OH})_4 \cdot 4\text{H}_2\text{O}]$ .

Luster: vitreous to greasy.

Colors: emerald green.

Streak: greenish.

Diaphaneity: transparent to translucent.

Fracture: conchoidal to uneven. Brittle.

SG: 2.60-2.69.

H: 3-3½.

Optics:  $\alpha$ :1.602,  $\beta$ :1.609,  $\gamma$ :1.621.

Birefringence: 0.019. ⊕.

Found in Tyrol (Austria), Ortega (Spain), Greenland, the Czech Republic, Tasmania (Australia), California, and Pennsylvania (USA).

**zargoon**; a Farsi or Persian name, from which the name zircon have been derived. It means golden color.

**zarmuni**; a Farsi term used for turquoise contain golden spots of pyrite with less brilliance. → Turquoise classification in Nishabur, Iran.

**Zarnitza Mine**; location of diamond deposits at the Markha River, Sakha (Yakutia), the Russian Federation, CIS.

**zeasite**; a name applied to a variety of wood opal.

**zeasite**; an obsolete term for fire opal.

**Z-axis**; in mineralogy one of the 3 optic axes in biaxial crystal, which has the least ease of vibration with minimum of velocity.

**Z-axis**; one of the 3 axes in a three dimensional rectangular space lattice.

**zeberged**; a variety of peridot found in The Island Zeberged, Red Sea, Egypt. Also known as St. John's Island. Also spelled Sabarjad, zeberget, zebirged, Seberget, etc.

**zeberget**; same as zeberged.

**zebirged**; same as zeberged.

**zebra crocidolite**; a parti-colored golden-brown and blue silica pseudomorphous of crocidolite, which is known as *zebra crocidolite* or *zebra tiger-eye*. Without alteration of the blue color is known as *hawk's-eye* or *falcon's-eye*. → Quartz inclusions.

**zebra dolomite**; a parallel banded alternate light gray dolomite from Colorado, USA.

**zebra limestone**; a parallel banded alternate limestone, in which the cracks are filled with calcite.

**zebra jasper**; a variety of jasper with dark and light brown steaks found in India.

**zebra rock**; a banded quartzose rock from Western Australia.

**zebra stone**; a misleading term for a parallel banded brown stone with light brown fossilized shell material. Also called zebra jasper.

**zebra tiger-eye**; → zebra crocidolite, quartz inclusions.

**zektzerite**; very rare mineral, cut as faceted gems.

System: orthorhombic.

Formula:  $8[\text{LiNa}(\text{Zr,Hf,Ti})\text{Si}_6\text{O}_{15}]$ .

Luster: pearly, on cleavage vitreous.

Colors: colorless, pink-rose.

Streak: white.

Diaphaneity: transparent.

Cleavage: {100} perfect, and {010} perfect.

Fracture: not determined.

SG: 2.80.

H: 6.

Optics;  $\alpha$ :1.582,  $\beta$ :1.584,  $\gamma$ :1.584.

Birefringence: 0.002.  $\ominus$ .

Found in Okanogan County, and Washington, USA.

**zektzerite luminescence**; pale-yellow under SWUV.

**zenith**; the point on the celestial sphere that is vertically above the given position or observer's head and opposite to the nadir.

**zenithite**; a misleading commercial term for synthetic strontium titanate used as a diamond imitation.

**zeolites**; a general name for a group of framework hydrous aluminosilicate minerals related to feldspars with the basic formula:  $X[(Na_2, K_2, Ca, Ba)(Al, Si)_2O_7]_x \cdot nH_2O$ , characterized by ratio (Al+Si):O=1:2. Mostly colorless or white sometimes red or yellow. There are ca. 45 naturally zeolite of different structures. Commercially synthetic zeolites are made for use in industry. Optical properties ranges from  $\alpha$ :1.460-1.515,  $\gamma$ :1.475-1.542. Birefringence range from 0.00 to 0.0015. SG:2.00-2.30, only barium-rich zeolite has specific gravity between 2.40 to 2.80. The water of chemical formula can be removed by heating and restored by exposure to a moist environment. Some zeolite minerals are: chabazite, natrolite, analcite, heulandite, stilbite, mesolite, harmotome, thomsonite, phillipsite, etc.

**Zerfass emerald**; a synthetic emerald grown by the flux melt technique, produced by Zerfass of Idar-Oberstein, Germany. Optics;  $\alpha$ :1.560,  $\beta$ :1.609,  $\gamma$ :1.563. Birefringence:0.003.  $\ominus$ . SG:2.65.

**zeuxite**; a term applied to an acicular variety of green tourmaline found in Brazil. Also called taltalite, Brazilian emerald.

**Zevenfontein**; location of alluvial diamond deposit in the Bloemhof area, Transvaal Province, South Africa.

**zeylanite**; another spelling of ceylonite.

**zhang**; a Chinese term for a flat sword with slender hilt projections made of jade.  $\rightarrow$  Chinese ritual and symbol jades.

**zhenyu**; a Chinese term for noble jade and applied to nephrite.

**zhi**; a Chinese term meaning form or shape.

**zhizi pattern**; a Chinese term for repeated form, pattern or shape.

**zhongfa**; a Chinese term for a carved jade in form of social structure.  $\rightarrow$  Chinese ritual and symbol jades.

**zhuo**; a Chinese term for bracelet made of jade or other material.

**zigzag cast**; same as herringbone texture.

**zigzag cut**; a modified faceted square brilliant-cut consisting of 16 triangular facets in zigzag form in the crown and 4-sided relatively large table in the crown.



**zigzag mark**; same as herringbone texture.

**Zillertal**; a part of Tyrol, Austria and location of several gemstones.

**Zimapán**; a principal location of opal in the State of Hidalgo, Mexico.

**Zimbabwe**; a gems and diamonds bearing country in south central Africa. Once named Rhodesia.

**Zimbabwe Gem and Mineral Society**;  $\rightarrow$  Gem and Mineral Society of Zimbabwe.

**Zimmermann Topaz**; a blue Brazilian topaz of 2.744kg, cut as a chameleon on foliage by German engraver Zimmermann A., in Idar-Oberstein. Rough weighed  $\approx$  4kg. Present whereabouts unknown.

**zinc**; a lustrous, malleable, hard, bluish-white, metallic element in group II of the chemical Periodic System with the symbol Zn. It is resistant to dry atmospheric corrosion. Used as an alloys and for protecting steel. It occurs as a natural element.

**zinc aluminum**; an alloy of zinc and aluminum used for forming die castings.

**zinblende**; another term for sphalerite.

**zinblende refractometer**; the standard refractometers with glass hemisphere prism can measure the stone with refractive indices (RIs) below 1.70, to achieve higher ranges refractometers with hemicylinder of blende with refractive index of 2.371 are used. Also called sphalerite refractometer.

**zinc carbonate**; same as smithsonite or calamine.

**zincian elbaite**; zinc-rich elbaite tourmaline.

**zincian staurolite**; a red-brown, yellow-red, transparent, trichroic zinc-rich variety of staurolite. Optics;  $\alpha$ :1.721,  $\gamma$ :1.731. Birefringence: 0.010.  $\oplus$ . SG:3.79. H:7. Under fluorescent light is yellowish green. Inert under UV light and -rays. Green, Yellow or red pleochroism. Used as gemstone and prized by collectors.

**zincian tourmaline**; zinc-rich tourmaline.

**zincite**; very rare mineral, rarely cut as faceted gemstone and cabochon together with calcite, also cut into spheres. It resembles orangey pyrope. It is associated with willemite and franklinite. Also called red zinc ore, red oxide of zinc, ruby zinc, spartalite and sterlingite. Inert under UV light and X-rays. Various colored synthetic zincite are made with RI:2.00.

System: hexagonalic.

Formula:  $2[ZnO]$ . May contains manganese oxide (MnO), which caused the orange-yellow to red color.

Luster: sub-adamantine to adamantine.

Colors: dark yellow to orange, deep red, red, orange-yellow.

Streak: orange yellow.

Diaphaneity: translucent.

Cleavage:  $\{1010\}$  perfect.

Fracture: conchoidal to uneven. Brittle.

SG: 5.68-5.70.



H: 4-4½.

Optics;  $\omega$ :2.013,  $\epsilon$ :2.029.

Birefringence: 0.016.  $\oplus$ .

Dispersion: 0.127.

Found in Franklin, New Jersey, Colorado (USA), Poland, Spain, Namibia, Italy, and Australia.

**zincite cut;** → zincite.

**zinc bloom;** same as flowers of zinc.

**zinc oxide;** same as flowers of zinc.

**zinc white;** same as flowers of zinc.

**zinc crown glass;** an optical glass containing zinc oxide.

**zinc glass;** an optical glass containing zinc oxide.

**zinc-rich spinel;** same as gahnospinel.

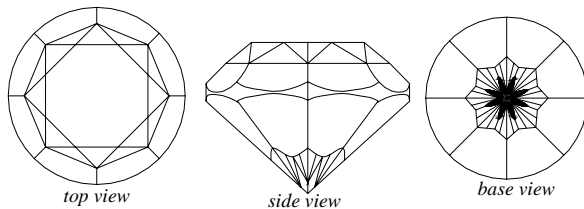
**zinc spar;** → smithsonite.

**zinc spinel;** another term for gahnite.

**zinc vitriol;** another term for goslarite.

**zinc white;** another term for zinc oxide.

**Zinnia Cut;** a registered name for one of 5 new Flower style cuts with an exceptional cut style. This was created for especial effects. The cut is only for round shaped brilliant with a faceted girdle and an increased



*Tolkowsky Zinna Flower cut. Courtesy of De Beers*

number of facets surrounding the culet, which creates brilliance, scintillation and color of the stone in movement. Designed by CSO consultant Gabi Tolkowsky in 1988. It has proportion: Table 52%, crown height 16%, pavilion depth 46% and girdle thickness very thick to thick. → Flower Cuts; Dahlia Cut, Marigold Cut, Sunflower Cut, Zinnia Cut.

**zinni pearl;** yellowish pearls of *Zinni mollusk* a variety of *Pinctada vulgaris* shell from Persian Gulf.

**zinnwaldite;** a mineral of mica group similar to lepidolite, which is often associated with emerald from Poona, Australia.

System: monoclinic.

Formula:  $4[\text{K}(\text{Li}, \text{Fe}^{+2}, \text{Al})_3(\text{AlSi}_3\text{O}_{10})(\text{F}, \text{OH})_2]$ .

Luster: vitreous, pearly on cleavage.

Color: brownish-gray, green to dark green, pale-violet.

Streak: colorless.

Diaphaneity: transparent.

Cleavage: {001} perfect.

SG: 2.90-3.30.

H: 2½-4.

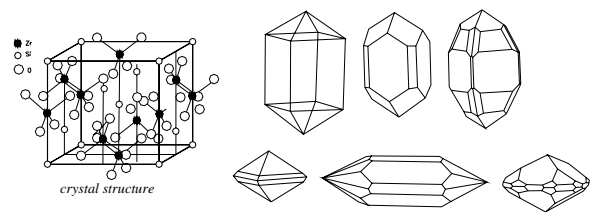
Optics;  $\alpha$ :1.550,  $\beta$ :1.580,  $\gamma$ :1.580.

Birefringence: 0.030.  $\ominus$ .

Found in Russia, Germany, Algeria, Greenland, California, Colorado, Arizona, and Virginia, USA.

**zircolite;** a commercial term for a man-made white corundum used as a diamond imitation.

**zircon;** very important gemstone, which has high brilliant and dispersion hence the cut stones have a good fire. It is isostructure with xenotime. They occur in several colors but often marketed stones have been subjected to heat treatment specially the brown stone. After heat treatment the stones are colorless, blue, dark red, bluish green, pink, golden yellow. The heated stone in a closed furnace turns blue or colorless. By passing air through the furnace the color changes to red or golden yellow, usually such color changed stones and



*crystal structure and crystals of zircon*

are stable rarely revert to their origin color. Highly refractive indices of zircon vary because of variation in the crystal lattice caused by breakdown of the crystal structure. Zircon usually contains radioactive elements such as uranium and thorium, which decay within the crystal and breakdown the structure of the crystal so that it is amorphous or nearly so, which named as *low zircon*. *Gamma zircon* has a singly refractive index and low optical properties, also called *metamicts*. *High zircon* is the same as crystalline or normal zircon that is not subject to decomposition, which has highly double refractive indices and was called *alpha zircon*. *Intermediate zircons* are partially decomposed hence they are easy to convert into high zircon, also called *beta zircon*. Synthetic zircon has been made but not for promotion. Certain colored stones are known as *hyacinth* a yellowish-red to orange-red, jargon, jacinth, cyrtolite, zirconite and Italian *gaicone*. Sometimes misnomered as *Siam aquamarine*, which is a blue to greenish-blue zircon from Thailand. *Matara diamond* is a smoky zircon and *Ceylon diamond* a colorless zircon both from Sri Lanka. Frequently a blue synthetic spinel is misnomered as *synthetic zircon*. Due to the large double refraction of zircon the stones are cut so that minimum fuzziness or reflection are achieved. Frequently called *war bride's diamond*, while during

the 1940 natural diamonds were scarce. *Zargoan* is a Farsi or Persian origin name for zircon. It means golden color. → Zircon cut.

System: tetragonal.

Formula:  $4[\text{ZrSiO}_4]$ . May contain Fe, Y, Hf, Th, U.

Luster: vitreous to adamantine, metamict variety vitreous to greasy.

Colors: colorless, shades of yellow, green, blue, brown, red.

Streak: colorless.

Diaphaneity: transparent, metamict variety transparent to opaque.

Cleavage: {110} imperfect, and {111} poor.

Fracture: conchoidal to uneven. Very brittle.

SG: 4.60-4.70, metamict variety 3.60-4.00.

H: 7-7½.

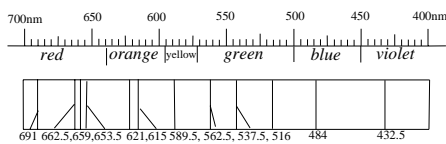
Optics;  $\omega$ : 1.922-1.96,  $\epsilon$ : 1.961-2.015.

Birefringence: 0.042-0.065. ⊕.

Dispersion: 0.039.

Found in Australia, Thailand, Sri Lanka, France, Myanmar, Norway, France, Cambodia, Brazil, Germany, Canada, Tanzania, Russia, Korea, and USA.

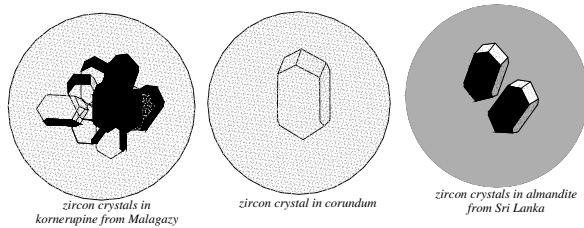
**zircon absorption spectrum;** some useful distinctive lines are at 690.5, 683, 662.5, 660.5, 654, 621, 615,



*zircon absorption spectrum*

589.5, 562.5, 537.5, 516, 484, 460, 432.7 nm.

**zircon as inclusions;** zircon as inclusions have been



*zircon as inclusions*

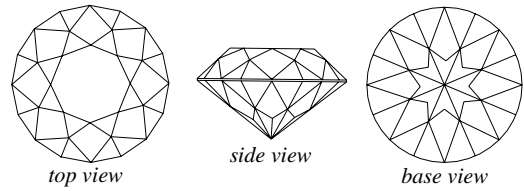
seen in sapphires, tourmalines, garnets, spinels, etc.

**zircon, blue;** mostly red-brown zircon from Cambodia and Thailand turns blue by means of heat-treatment.

**zircon brittleness;** zircon has a peculiar brittleness, which is shown when the edges on faceted stones are rubbed.

**zircon cat's-eye;** reportedly zircon with cat's-eye effect have been seen.

**zircon cut;** a modified style of cutting a brilliant or



*zircon cut with additional facets around the culet which release fuzziness*

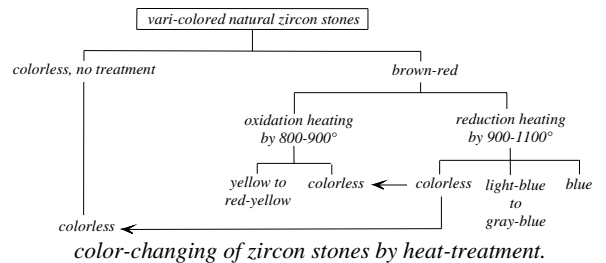
*zircon cut with 73 facets*

transparent stone with an extra row of sixteen (sometimes 8) triangular facets, which replace the culet on the pavilion.

**zircon double refraction;** zircon has high double refraction: 0.042-0.065.

**zircon fluorescence;** → zircon luminescence.

**zircon, heat treated;** usually the zircon occurs in several colors but often marketed stones have been

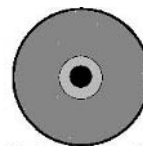


*color-changing of zircon stones by heat-treatment.*

*After W. F. Eppler*

subjected to heat treatment specially the brown stone, which after heating turns colorless, blue, dark red, bluish green, pink, golden yellow. The heated stone in a closed furnace turns blue or colorless. By passing air through the furnace their color changes to red or golden yellow, usually such color changed stones are stable and rarely revert to their origin color. Heat increases the specific gravity, which changes the low zircon to high type, when suitably heated to about 1450° C. → Heat treatment of zircon.

**zircon halo inclusions;** included zircon crystals with darkened surrounded halos consisting of brownish



*hallo (light gray) of zircon (black) under microscope*

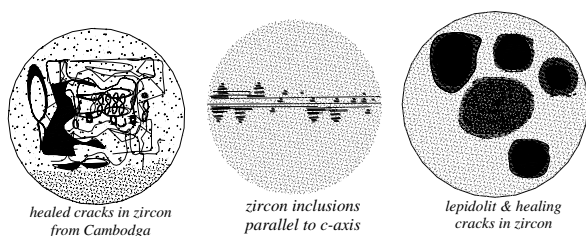
wings of fractures in other minerals such as sapphire, garnet, and spinel from Sri Lanka caused either by radioactive zircon particles or due to

unequal thermal expansion between zircon particles in the host mineral. Or sometimes may be caused by an increase of the guest crystal in the host mineral, which disintegrates to the metamict type.

**zirconia;** → synthetic cubic zirconia.

**zirconia, cubic;** → synthetic cubic zirconia.

**zircon inclusions;** inclusions in low zircon seen typical



*inclusions in zircon*

as angular zoning straight lines. In metamict zircon bright fissures or so-called *angles* may be seen.

**zirconite;** another term for brown or gray zircon.

**zircon intermediate type;** partially decomposed zircon is easy to restore to high zircon, which changes color to red and increases the specific gravity.

**zirconium;** a ductile, silvery gray to steel gray metallic element in group IV of the Periodic System with the symbol Zr. Used as abrasive and alloys.

**zirconium dioxide;** → synthetic cubic zirconia.

**zirconium oxide;** → synthetic cubic zirconia.

**zircon low type;** → zircon.

**zircon luminescence;** fluorescence of zircon is variable some sample glow yellow under SWUV light, and others are inert. Some material glows under LWUV light. Zircon glows under X-rays in various colors and intensity.

**zircon metamict;** → zircon.

**zircon normal;** → zircon.

**zircon pleochroism;** pleochroism can be seen distinctly in blue stones in dark blue, colorless to yellowish. In red stones, red to deep brown and in brown stones, reddish brown to yellowish brown.

**zircon rose;** same as rose cut zircon.

**zircon spinel;** a misleading term for a blue synthetic spinel, which is also misnomered as synthetic zircon.

**zircon, synthetic;** → synthetic zircon.

**zircon white;** white zircon, which is used as a diamond imitation.

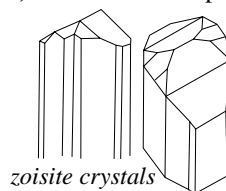
**zirtone;** a commercial term for bluish-green synthetic sapphire or corundum.

**Zlata Prata Diamond;** it means Golden Prague. A diamond of 38.72 cts, found in Sakha (Yakutia), the Russian Federation, CIS, reportedly after 1955. Now on display in the Russian Diamond Fund, Moscow.

**zobabi;** an Arabic term for iridescence, light vivid green emerald similar to insect zobab, meaning insect Cantharides or la mouche Cantharides. Also spelled zababi, zabab.

**zodiacal constellation;** 12 stones believed to be related to an imaginary belt of the celestial sphere that is divided into 12 constellation, which are called the signs of zodiac, within which the sun, moon and principal planets appear to move. These are named after 12 constellation with their related 12 stones: (I) Aries or Ram from Mar.21-Apr.19 stone, *bloodstone*. (II) Taurus or Bull from Apr.19-May 20 stone, *sapphire*. (III) Gemini or Twins from May 20-June 21 stone, *agate*. (IV) Cancer or Crab from June 21-July 22 stone, *emerald*. (V) Leo or Lion from July 22-Aug.22 stone, *onyx*. (VI) Virgo or Virgin from Aug.22-Sept.23 stone, *carnelian*. (VII) Libra or Balance from Sept.23-Octs.,23 stone, *chrysolite*. (VIII) Scorpio or Scorpion from Octs.,23-Nov.22 stone, *aquamarine*. (IX) Sagittarius or Archer from Nov.22-Dec.21 stone, *topaz*. (X) Capricorn or Goat from Dec.21-Jan.20 stone, *ruby*. (XI) Aquarius or Water Bearer from Jan.21-Feb.19 stone, *garnet*. (XII) Pisces or Fish from Feb.19-Mar.21 stone, *amethyst*.

**zoisite;** a member of epidote group, dimorphous with clinozoisite of related minerals. Strong pleochroism in blue zoisite. Cut cabochon and rarely as faceted gems. *Tanzanite* is a commercial term for cut zoisite. *Khaki* is brown shades of zoisite. Zoisite turned its color to blue by heat-treatment at 380° C. The blue color of the stone caused by vanadium. Precaution by cleaning in an ultrasonic bath. Also called anyolite, thulite (rosalite), saualpite.



System: orthorhombic.

Formula:  $4[\text{Ca}_2\text{Al}_3(\text{O}(\text{OH})\text{SiO}_4\text{Si}_2\text{O}_7)]$ .

Luster: vitreous somewhat pearly to resinous on cleavage.

Colors: yellowish green to brownish green, greenish brown, gray, pink (thulite), blue-violet.

Streak: colorless.

Diaphaneity: transparent to translucent.

Cleavage: {001} perfect and {010} imperfect.

Fracture: conchoidal to uneven. Brittle.

SG: 3.30-3.55.

H: 6-7.

Optics;  $\alpha$ :1.685-1.705,  $\beta$ :1.688-1.71,  $\gamma$ :1.698-1.725.

Birefringence: 0.003-0.008. ⊕.

Dispersion: 0.019.

Found in Italy, Norway, France, Tanzania, Austria, Russia, Japan, Australia, Malagasy, and Myanmar, (Burma).

**zoisite absorption spectrum;** a broad absorption band in orange at 595 nm, a weaker in the green at 528 nm and in the blue at 455 nm.

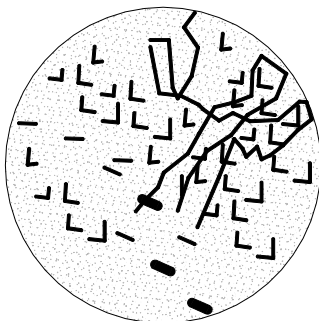
**zoisite associated with ruby;** zoisite is mostly found



*zoisite mixed with ruby like a matte*

associated with ruby crystals from Tanzania, and elsewhere.

**zoisite, blue;** a blue variety of zoisite from Tanzania



*healed cracks in blue zoisite*

with healed cracks as inclusion.

**zoisite cat's-eye;** zircon crystal contain inclusions of fibers or canals, which show cat's-eye effect, when cut cabochon.

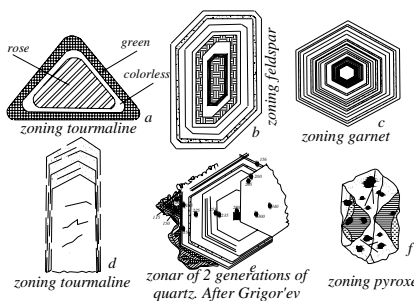
**zoisite cut;** thulite the opaque, massive variety of zoisite cut cabochon. Transparent varieties are rarely faceted as gems, which resemble Kashmir sapphire.

**zoisite, green;** same as green zoisite.

**zoisite, yellow;** same as yellow zoisite.

**zomorrod** → emerald, names of.

**zonary growth;** zonary growing of crystals bounded by plane crystal faces, which occur by slight variation in



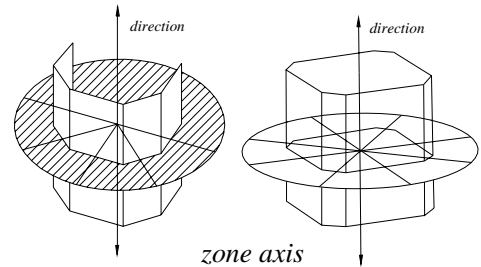
*cross section of zoning crystals. a: tourmaline b: feldspar c: garnet. d: tourmaline. e: quartz and f: pyroxene*

the composition of a crystal due to separation or interruptions of the crystal phases during growth. → Zoned bands in ruby.

**zonal mineral;** typomorphic mineral.

**zone;** a group of crystal faced intersection, which are parallel to a common line.

**zone axis;** a line runs through the center of a crystal, to



which all faces of a given zone are parallel.

**zoned;** same as zonal, zonar.

**zoned bands in ruby;** the straight, parallel growth-lines, the internal structure of the stone, which seen as lines between different colored sheets such as the hexagonal outline of natural sapphire. In synthetic sapphire they are parallel and curved. → Zonary growth.

**zoned bands in sapphire;** same as zoned bands in ruby.

**zoned bands in star sapphire;** hexagonal zoned bands in the form of silk in true star sapphire.

**zoned color in topaz;** nearly straight, parallel cleavage-plates seen very seldom in the internal structure of topaz, which occurs as lines between different colored layers. → Zonar growth.

**zoned tourmaline;** → watermelon tourmaline.

**zone of crystal faces;** in crystallography a characteristic feature of a serie faces of a crystal where those intersection lines with each other are all parallel.

**zoning;** the straight, parallel growth-lines in the internal structure of a gemstone with definite angles, usually seen in some stones, which occur by slightly variation in the chemical composition within the crystal due to separation or interruptions of the crystal phases during growth.

**zonite;** a local term for chert or jasper of various color from Arizona, USA.

**zonochlorite;** a light and dark-green variety of pumpellyite occurring in pebbles found in the Lake superior region, USA.

**zonochlorite;** once thought to be an impure prehnite.

**zon-si;** a Chinese term used for spinel stones and rejections of another classifications. → Corundum classification in Myanmar.

**zoom lens;** an optical lens system, in which the focal length can be moved with respect to each other to obtain continuous change of magnification without loss of focus.

**zoom microscope;** a microscope provided with zoom lens.

**zoophyte;** same as polyp, coral.

**Zoroastrian;** → azabache.

**Zr;** a chemical symbol for the element zirconium.

**zubabi;** same as zobabi.

**zuanshi mofangpin;** a Chinese term for green cubic zirconia used as jade.

**Zubara emerald;** location of an ancient emerald mine from Mount Zubara near Red Sea, Egypt.

**zumurrud** → emerald, names of.

**zun;** a Chinese term for a carved jade in form of a bronze vessel. → Chinese ritual and symbol jades.

**zunyite;** a rare mineral and rarely cut as gems from Japan.

System: cubic.

Formula:  $4[\text{Al}_{12}\text{Si}_5\text{O}_{16}(\text{AlO}_4)(\text{OH},\text{F})_{18}\text{Cl}]$ .

Luster: vitreous.

Colors: colorless, flesh red, pale brown, grayish white.

Streak: colorless.

Diaphaneity: transparent to translucent.

Cleavage: {111} easy.

Fracture: Brittle.

SG: 2.87.

H: 7.

RI: 1.600.

Found in Zuni Mine, San Juan County, Arizona, Utah (USA), Japan, South Africa, Algeria, England, and Karabash (Turkey).

**zunyite luminescence;** intense red.

**Zwartlaagte;** location of small alluvial diamond deposit in Bloemhof area, Transvaal Province, South Africa.

**Zwartplaat;** location of a small alluvial diamond deposit in Ventersdorp area, Transvaal Province, South Africa.

**zweikanter;** → windkanter.

**zylonite;** a commercial term for a synthetic cellulose thermoplastic. Used as gems in jewelry. Also called xylonite.

# Appendix

table 20: greek alphabet

A	$\alpha$	alpha	N	$\nu$	nu
B	$\beta$	beta	$\Xi$	$\xi$	xi
$\Gamma$	$\gamma$	gamma	O	o	omicron
$\Delta$	$\delta$	delta	$\Pi$	$\pi$	pi
E	$\epsilon$	epsilon	P	$\rho$	rho
Z	$\zeta$	zeta	$\Sigma$	$\sigma$	sigma
H	$\eta$	eta	T	$\tau$	tau
$\Theta$	$\theta$	theta	Y	$\upsilon$	upsilon
I	$\iota$	iota	$\Phi$	$\phi$	phi
K	$\kappa$	kappa	X	$\chi$	chi
$\Lambda$	$\lambda$	lambda	$\Psi$	$\psi$	psi
M	$\mu$	mu	$\Omega$	$\omega$	omega

table 22: the light spectrum

color	wavelength in nm	
ultraviolet	100–	390
violet	390–	430
blue	430–	490
blue-green	490–	510
green	510–	550
yellow-green	550–	575
yellow	575–	590
orange	590–	630
orange-red	630–	650
red	650–	700
dark-red	700–	780
infrared	780–	1 000 000

table 21: hardness, Mohs's scale

hardness	common	composition	equivalent
1	talc	$Mg_3Si_4O_{10}(OH)_2$	fingernail
2	gypsum	$CaSO_4 \cdot 2H_2O$	fingernail
3	calcite	$CaCO_3$	teeth, copper coin, brass pin
4	fluorite	$CaF_2$	teeth, copper coin, brass pin
5	apatite	$Ca_5(PO_4)_3(F,Cl,O,OH)_3$	teeth, copper coin, brass pin
6	orthoclase	$KAlSi_3O_8$	window glass
7	quartz	$SiO_2$	penknife
8	topaz	$Al(SiO_4)(F,OH)_2$	steel file
9	corundum	$Al_2O_3$	corundum and diamond
10	diamond	C	diamond

table 23: Fraunhofer lines

line	element	color	wavelength in nm	
A	oxygen	dark red	760.60	} terrestrial and atmosphere
B	oxygen	red	687.00	
C	hydrogen	orange	656.30	} sun and chromosphere elements
D1	sodium	yellow	589.63	
D2	sodium	yellow	589.02	
D3	helium	yellow	587.56	
E	calcium, iron	green	527.00	
F	hydrogen	blue-green	486.10	
G	iron, titanium	blue	430.80	
H	calcium	violet	396.90	
K	calcium	violet	393.37	

table 26: twelve apostles and related gemstones

Apostle	stone
Andrew	blue sapphire
Bartholomew	red carnelian
James	white chalcedony
James-the-Less	topaz
John	emerald
Matthew	amethyst
Matthias	chrysolite
Peter	Jasper
Philip	Sardonyx
Simeon	purple hyacinth
Thaddeus	chrysoprase
Thomas	beryl

table 24: heavy liquids

liquid	composition	SG
common salt solution	$\text{NaCl} + n\text{H}_2\text{O}$	1.12–1.14
bromoform pure	$\text{CHBr}_3$	2.90
acetylene tetrabromide	$\text{C}_2\text{H}_2\text{Br}_4$	2.95
Sonstadt's	potassium iodide and mercuric iodide	3.18
Klein's	cadmium boro-tungstate	3.28
methylene iodide	$\text{CH}_2\text{I}_2$	3.42
Rohrbach's	barium mercuric iodide	3.58
Clerici's	$\text{CH}_2(\text{COOI})_2 + \text{HCOOI}$	4.15
thallium malonite	thallium formate + organic thallium	4.25
Retger's salt	thallium silver nitrate	4.60 at 75 °C

table 25: birthstones

month	color	stone
January	deep red	garnet
February	purple	amethyst
March	light blue	aquamarine, bloodstone
April	white, transparent	diamond, rock crystal
May	bright green	emerald, chrysoprase
June	cream	pearl, moonstone
July	red	ruby, carnelian or onyx
August	light green	peridot, sardonyx
September	dark blue	sapphire, lapis lazuli
October	variegated	opal, tourmaline
November	yellow	topaz, citrine
December	sky-blue	turquoise or zircon

table 27: stones in the breastplate of the Jewish high priest

No	stone or guessed stone	Hebrew name
1	red jasper	Odem
2	citrine quartz (topaz)	Pitdah
3	emerald	Bareketh
4	ruby (carbuncle)	Nophek
5	lapis lazuli (sapphire)	Sappir
6	rock crystal (diamond)	Yahalom
7	golden sapphire (ligure)	Leshem
8	blue sapphire (agate)	Shebo
9	amethyst	Ahlahmah
10	yellow jasper (chrysolite)	tarshish
11	golden beryl (onyx)	Shalom
12	chrysoprase (jasper)	Yashpneh

table 28: periodic table of the elements (adapted from Chemical Engineering News, 27 pp., 1985)

Filled Shells	1 Group IA		2 IIA		3 IIIA IIIB		4 IVA IVB		5 VA VB		6 VIA VIB		7 VIIA VIIB		8 VIII VIII		9 VIIIA VIIIB		10 Noble Gases		11 IB		12 IIB		13 IIIB IIIA		14 IVB IVA		15 VB VA		16 VIB VIA		17 VIIB VIIA		18 Noble Gases																																																																																			
	1 H 1.00794	2 He 4.00260	3 Li 6.941	4 Be 9.01218	5 B 10.811	6 C 12.011	7 N 14.0067	8 O 15.9994	9 F 18.9984	10 Ne 20.1797	11 Na 22.9898	12 Mg 24.3050	13 Al 26.9815	14 Si 28.0855	15 P 30.9738	16 S 32.066	17 Cl 35.4527	18 Ar 39.948	19 K 39.0983	20 Ca 40.078	21 Sc 44.9559	22 Ti 47.880	23 V 50.9415	24 Cr 51.9961	25 Mn 54.9380	26 Fe 55.847	27 Co 58.9332	28 Ni 58.690	29 Cu 63.546	30 Zn 65.390	31 Ga 69.723	32 Ge 72.610	33 As 74.9216	34 Se 78.960	35 Br 79.904	36 Kr 83.800	37 Rb 85.4678	38 Sr 87.620	39 Y 88.9059	40 Zr 91.224	41 Nb 92.9064	42 Mo 95.940	43 Tc (98)	44 Ru 101.070	45 Rh 102.906	46 Pd 106.420	47 Ag 107.868	48 Cd 112.411	49 In 114.820	50 Sn 118.710	51 Sb 121.750	52 Te 127.600	53 I 126.905	54 Xe 131.290	55 Cs 132.905	56 Ba 137.327	57 La 138.906	58 Ce 140.115	59 Pr 140.908	60 Nd 144.240	61 Pm (145)	62 Sm 150.360	63 Eu 151.965	64 Gd 157.250	65 Tb 158.925	66 Dy 162.500	67 Ho 164.930	68 Er 167.260	69 Tm 168.934	70 Yb 173.040	71 Lu 174.967	72 Hf 178.490	73 Ta 180.948	74 W 183.850	75 Re 186.207	76 Os 190.200	77 Ir 192.220	78 Pt 195.080	79 Au 196.967	80 Hg 200.590	81 Tl 204.383	82 Pb 207.200	83 Bi 208.980	84 Po (209)	85 At (210)	86 Rn (222)	87 Fr (223)	88 Ra 226.025	89 Ac 227.028	90 Th 232.038	91 Pa 231.036	92 U 238.029	93 Np 237.048	94 Pu (244)	95 Am (243)	96 Cm (247)	97 Bk (247)	98 Cf (251)	99 Es (252)	100 Fm (257)	101 Md (258)	102 No (259)	103 Lr (260)	104 Rf (261)	105 Db (262)	106 Sg (263)	107 Bh (262)	108 Hs (265)	109 Mt (267)	110 Ds (271)	111 Rg (272)	112 Cn (285)	113 Nh (286)	114 Fl (289)	115 Mc (290)	116 Lv (293)	117 Ts (294)	118 Og (294)

● : Lanthanide series

● : Actinide series

The values in ( ) represent the mass number of the isotope of longest known half-life of an element. Atomic masses are adapted from the IUPAC values, 1985 and JCPDS.



table 29: atomic weights (adapted from the JUPAC values, 1985 and JCPDS)

element	symbol	atomic number	atomic weight	element	symbol	atomic number	atomic weight	element	symbol	atomic number	atomic weight
Actinium	Ac	89	227.0278	Gadolinium	Gd	64	157.250	Potassium	K	19	39.0983
Aluminium	Al	13	26.981539	Gallium	Ga	31	69.723	Praseodymium	Pr	59	140.90765
Americium	Am	95	(243)	Germanium	Ge	32	72.610	Promethium	Pm	61	(145)
Antimony	Sb	51	121.750	Gold	Au	79	196.96654	Protactinium	Pa	91	231.03588
Argon	Ar	18	39.948	Hafnium	Hf	72	178.490	Radium	Ra	88	226.0254
Arsenic	As	33	74.92159	Helium	He	2	4.002602	Radon	Rn	86	(222)
Astatine	At	85	(210)	Holmium	Ho	67	164.93032	Rhenium	Re	75	186.207
Barium	Ba	56	137.327	Hydrogen	H	1	1.00794	Rhodium	Rh	45	102.90550
Berkelium	Bk	97	(247)	Indium	In	49	114.820	Rubidium	Rb	37	85.4678
Beryllium	Be	4	9.012182	Iodine	I	53	126.90447	Ruthenium	Ru	44	101.070
Bismuth	Bi	83	208.98037	Iridium	Ir	77	192.220	Samarium	Sm	62	150.360
Boron	B	5	10.811	Iron	Fe	26	55.847	Scandium	Sc	21	44.95591
Bromine	Br	35	79.904	Krypton	Kr	36	83.800	Selenium	Se	34	78.960
Cadmium	Cd	48	112.411	Lanthanum	La	57	138.9055	Silicon	Si	14	28.0855
Calcium	Ca	20	40.078	Lawrencium	Lr	103	(262)	Silver	Ag	47	107.8682
Californium	Cf	98	(251)	Lead	Pb	82	207.200	Sodium	Na	11	22.989768
Carbon	C	6	12.011	Lithium	Li	3	6.941	Strontium	Sr	38	87.620
Cerium	Ce	58	140.115	Lutetium	Lu	71	174.967	Sulfur	S	16	32.066
Cesium	Cs	55	132.90543	Magnesium	Mg	12	24.305	Tantalum	Ta	73	180.9479
Chlorine	Cl	17	35.4527	Manganese	Mn	25	54.93805	Technetium	Tc	43	(98)
Chromium	Cr	24	51.9961	Mendelevium	Md	101	(258)	Tellurium	Te	52	127.600
Cobalt	Co	27	58.9332	Mercury	Hg	80	200.590	terbium	Tb	65	158.92534
Copper	Cu	29	63.546	Molybdenum	Mo	42	95.940	Thallium	Tl	81	204.3833
Curium	Cm	96	(247)	Neodymium	Nd	60	144.240	Thorium	Th	90	232.0381
Dysprosium	Dy	66	162.500	Neon	Ne	10	20.1797	Thulium	Tm	69	168.93421
Einsteinium	Es	99	(252)	Neptunium	Np	93	237.0482	Tin	Sn	50	118.710
Element 104 <sup>a</sup>	?	104	(261)	Nickel	Ni	28	58.690	Titanium	Ti	22	47.880
Element 105 <sup>a</sup>	?	105	(262)	Niobium	Nb	41	92.90638	Tungsten	W	74	183.850
Element 106 <sup>a</sup>	?	106	(263)	Nitrogen	N	7	14.00674	Uranium	U	22	238.0289
Element 107 <sup>a</sup>	?	107	(262)	Nobelium	No	102	(259)	Vanadium	V	23	50.9415
Element 108 <sup>a</sup>	?	108	(265)	Osmium	Os	76	190.200	Xenon	Xe	54	131.290
Element 109 <sup>a</sup>	?	109	(267)	Oxygen	O	8	15.9994	Ytterbium	Yb	70	173.040
Erbium	Er	68	167.260	Palladium	Pd	46	106.420	Yttrium	Y	39	88.90585
Europium	Eu	63	151.965	Phosphorus	P	15	30.973762	Zinc	Zn	30	65.390
Fermium	Fm	100	(257)	Platinum	Pt	78	195.080	Zirconium	Zr	40	91.224
Fluorine	F	9	18.9984032	Plutonium	Pu	94	(244)				
Francium	Fr	87	(223)	Polonium	Po	84	(209)				

The values in ( ) represent the mass number of the isotope of longest known half-life of an element.

<sup>a</sup> Unnilquadium or provisional term for transuranic element.

table 30: geological timetable

era	period	epoch	million years ago	principal geological and biological events	
Cenozoic	Quaternary	Recent	0.01	abnormally big provincialism and few epicontinental seas high ice age; glacial and interglacial periods	
		Pleistocene	2.00		
	Tertiary	Pliocene		5.10	modern humans
			Miocene	24.60	
		Oligocene	38.00	principal uplift of Himalayan Mountains as India collides with Asia	
		Eocene	55.00		
		Paleocene	65.00		
Mesozoic	Cretaceous		144.00	terrestrial and marine mass extinction principal uplift of Rocky Mountains	
		Jurassic	213.00		
		Triassic	248.00		
Palaeozoic	Permian		286.00	break-up and beginning of Pangea; marine mass extinction uplift of Appalachian Mountains; glaciation	
		Carboniferous	360.00		
	Devonian		408.00	extensive coal swamps	
		Silurian	438.00		
	Ordovician		505.00	glaciation second marine diversification; major marine diversification	
		Cambrian	590.00		
	Proterozoic (Precambrian)			2 500.00	glaciation; widespread appearance of free oxygen in the atmosphere oldest known fossils
			4 000.00		
Archaean (Precambrian)			4 000.00	oldest terrestrial rocks	
			4 600.00		
Priscoan (Precambrian)			4 600.00	oldest lunar rocks (age of solar system?)	

table 31: major clarity-grading scales for polished diamonds

description of clarity grade of each system	GIA <sup>a</sup>	SCAN. D.N. <sup>b</sup>		CIBJO <sup>c</sup> /IDC <sup>d</sup>	AGS <sup>e</sup>
		less than 1/2 carat	1/2 carat and above		
free from external or internal inclusions visible under 10× loupe	flawless, FI	flawless, FI	flawless, FI	loupe clean (LC)	0
small blemishes on the surface visible under 10× loupe	internally flawless, IF	internally flawless, IF	internally flawless, IF		1
very minor inclusions and/or finish flaws, hard to see under 10× magnification	very, very slightly included <sub>1</sub> (VVS <sub>1</sub> )	very, very small inclusions (VVS)	very, very small inclusions <sub>1</sub> (VVS <sub>1</sub> )	VVS <sub>1</sub>	2
	very, very slightly included <sub>2</sub> (VVS <sub>2</sub> )		very, very small inclusions <sub>2</sub> (VVS <sub>2</sub> )	VVS <sub>2</sub>	
very small inclusions and/or finish flaws, just be found under 10× loupe	very, very slightly included <sub>1</sub> (VS <sub>1</sub> )	very small inclusions (VS)	very small inclusions <sub>1</sub> (VS <sub>1</sub> )	VS <sub>1</sub>	3
	very, very slightly included <sub>2</sub> (VS <sub>2</sub> )		very small inclusions <sub>2</sub> (VS <sub>2</sub> )	VS <sub>2</sub>	
small inclusions and/or surface fault marks readily seen under 10× loupe, but not with naked eye through the crown facets	slightly included <sub>1</sub> (SI <sub>1</sub> )	small inclusions (SI)	small included <sub>1</sub> (SI <sub>1</sub> )	SI <sub>1</sub>	4
	slightly included <sub>2</sub> (SI <sub>2</sub> )		small included <sub>2</sub> (SI <sub>2</sub> )	SI <sub>2</sub>	
inclusions and/or surface fault marks seen immediately under 10× loupe but not without, minute effect on brilliancy	imperfect <sub>1</sub> (I <sub>1</sub> )	piqué inclusions (P)	1 <sup>st</sup> piqué (P <sub>1</sub> )	piqué <sub>1</sub> (P <sub>1</sub> )	7
	imperfect <sub>2</sub> (I <sub>2</sub> )		2 <sup>nd</sup> piqué (P <sub>1</sub> )	piqué <sub>2</sub> (P <sub>2</sub> )	
few and/or larger inclusions and surface marks readily seen with naked eye, and slightly reducing of brilliancy	imperfect <sub>3</sub> (I <sub>3</sub> )		3 <sup>rd</sup> piqué (P <sub>3</sub> )	piqué <sub>3</sub> (P <sub>3</sub> )	9
numerous and/or very larger inclusions and surface blemishes, visible with naked eye, reducing of brilliancy					10

<sup>a</sup> System used by the Gemological Institute of America with the acronym: GIA.

<sup>b</sup> System used by the Scandinavian Nomenclature Committee with the acronym: SCAN. D.N.

<sup>c</sup> System used by the International Confederation of Jewelry, Silverware, Diamonds, Pearls and stones with the acronym: CIBJO.

<sup>d</sup> System used by the American Gem Society with the acronym: AGS.

<sup>e</sup> International Diamond Council.

table 32: major color-grading scales for polished diamonds

description of clarity grade of each system	GIA <sup>a</sup>	SCAN. D.N. <sup>b</sup>		CIBJO <sup>c</sup> /IDC <sup>d</sup>	AGS <sup>e</sup>
		0.5 carats upwards	under 0.5 carats		
colorless	D	river	rarest white	exceptional white <sup>+</sup>	0
	E			exceptional white	1
near colorless	F	top wesselton	rare white	rare white <sup>+</sup>	2
	G			rare white	3
	H	wesselton	white	white	4
	I	top crystal	slightly tinted white	slightly tinted white	5
faint yellow	J	crystal			
	K	top cape	tinted white	tinted white	6
very light yellow	L				
	M	cape	slightly yellowish	tinted color	7
	N				
	O	light yellow	yellowish		8
	P				
	Q				
	R				
	S	yellow	yellow		9
light yellow	T				
	U				
	V				
	W				
	X				
	Y				
	Z				10

<sup>a</sup> System used by the Gemological Institute of America with the acronym: GIA.  
<sup>b</sup> System used by the Scandinavian Nomenclature Committee with the acronym: SCAN. D.N.  
<sup>c</sup> System used by the International Confederation of Jewelry, Silverware, Diamonds, Pearls and stones with the acronym: CIBJO.  
<sup>d</sup> International Diamond Council.  
<sup>e</sup> System used by the American Gem Society with the acronym: AGS.

table 33: notable famous diamonds

name	origin	color	weight rough	weight cut	cut form	found in	disposition
Abadia do Duorados	Brazil	pale-brown	104		rough	1938/39	Its ultimate disposition unknown
Abadia do Duorados Lilac	Brazil	pink	63		rough	1936	Present owner unknown
Abadia do Duorados Rose	Brazil	rose	33		rough		Its ultimate disposition unknown
Abaeté	Brazil	pink	238		rough	1926	Present owner unknown
Abaeté Brilliant	Brazil		144		rough	1791	Its ultimate disposition unknown
Abaeté Rose	Brazil	rose	118		rough	1929	Present owner unknown
Abbas-Mirza	India	rose	130		table	1832	Set on Abbas-Mirza Crown-Prince of Iran. Now in National Jewel Treasury of Iran?
African Yellow	Africa	yellow	112				Reported by a historian in 1882. Present owner unknown
Aga Khan III			38				Was recut into a 33.13 cts. stone, sold in 1988
Agra	India	rose	46		cushion		Reportedly owned by the Baber first Mogul Shah of India. Recut into 31.50 cts. Was sold in 1904 to the CIBA Corporation of Hong Kong
Ahmed-Abad	India		157.25				Bought by Tavernier who recut it in Paris into 94.50 cts. Sold in Persia
Akbar Shah	India		116		drop	1739	Was recut into a drop-shape of 73.60 cts. Also called the Shepherd Stone
Algeiba Star	South Africa?	yellow	133.03		cushion		Recut from a stone of 139.38 cts., which was known as Mahjal
Al-Nadir			115.83		pear		Its ultimate disposition unknown
Amarillo Starlight	USA		16.37		rough	1975	Named after Amarillo town in Texas
Amsterdam Black		black	55.85	33.74	pear		Was exhibit at 700 <sup>th</sup> anniversary of the city Amsterdam in 1975
Anniversary	South-Africa		200	65	pear		Cut in 1951 for 75 <sup>th</sup> anniversary of the Baumgold company, USA
Antique Cushion		yellow	57		cushion		Sold in 1972
Arc, The	South Africa		381		rough	1921	Present owner unknown
Archduke Joseph		fine-colored		78.54	cushion		Owned by Archduke Joseph of Austria, sold in 1961. Present owner unknown
Arcot two stones	India			together 57.35			One of 33.70 and second of 23.65 cts. In 1959 sold to Harry Winston
ARETOR	Guinea		181.77			1988	Its ultimate disposition unknown
Arkansas	USA	light-yellow	17		octahedron		On display in Smithsonian Institution, Washington, D.C.
Auckland	India?			36	cone		The description is identical to the Holland Diamond

table 33: *continued*

<b>name</b>	<b>origin</b>	<b>color</b>	<b>weight rough</b>	<b>weight cut</b>	<b>cut form</b>	<b>found in</b>	<b>disposition</b>
Asberg	South Africa?	amber		102.50	cushion		Belonged to the Russian Tsar Crown of Russia. Sold in 1981
A. Steyn	South Africa		141.25		rough	1912	Present owner unknown
Austrian Yellow Brilliant		yellow			oval	about 1600	See Florentine. Present owner unknown
Baden Solitaire				30			Owned by Austrian Royal Family. Was mounted in the clasp of a 114 pear-shaped diamond necklace
Banjarmasin	Indonesia		70	40	square	about 1836	Was taken to Holland in 1859. Now in the Rijksmuseum in Amsterdam
Banian	India			48.50			Tavernier bought in India in 17 <sup>th</sup> century, sold to a Dutch sea captain
Barkly Breakwater	South Africa		109.25		rough	1905	Present owner unknown
Battershill				65			Was named after the governor of Tanzania in 1945. Present owner unknown
Baungold Brilliant	South Africa	white	167.25	55			Recut into 52 cts. Present owner unknown
Baungold Pears	South Africa	bluish-white	609.25	14 stones	pears	1922	Largest 2 stones of 50 cts. each. Present owner unknown
Bazu	India			104			Sold by Tavernier to a Dutch merchant. Also called Little Nancy
Beaumont	South Africa		273				Present owner unknown
Beau Sancy	India			34.50	pear		In a pendant in Bremen, Germany
Benedito Valadares	Brazil		108.25	3 stones	emerald	1940	Cut into 30, 20, and 8 cts., totally 58 cts
Berglen	South Africa	brown	416.25		rough	1924	Present owner unknown
Bicker-Carteen		white	56				Believed in 1958 bought by Aga Khan. Present owner unknown
Black Diamond of Bahia	Brazil	black	350				Present owner unknown
Black Orloff	India	black	195	67.50	cushion		Known as Eye of Brahman Diamond. Sold in 1997 privately
Black Star of Africa	Zaire	black		202			Was exhibited in 1971 in Tokyo
Blue Heart	India	deep-blue	112.50	31	heart		Tavernier sold to Louise XIV of France. Was stolen in 1792. Was sold to Cartier in 1911. Last sold in 1960
Blue Lili		dark-blue		30.06	trap cushion		Named after the wife of Goldberg, New York. Present owner unknown
Bob Craig	South Africa		100.50		rough	1917	Its ultimate disposition unknown
Bob Grove	South Africa		337		rough	1908	Present owner unknown
Brady	South Africa		330		rough	1902	Its ultimate disposition unknown

table 33: *continued*

<b>name</b>	<b>origin</b>	<b>color</b>	<b>weight rough</b>	<b>weight cut</b>	<b>cut form</b>	<b>found in</b>	<b>disposition</b>
Braganza	Brazil		144			1791	Also a misnomer for Braganza Topaz
Brazilia	Brazil	light-blue	176.20		rough	1944	Present owner unknown
Brazilian	Brazil		90	31.75	brilliant	1825	Present owner unknown
Briolette of India	India			90.38	briolette		Harry Winston sold it for last time in 1971. Present owner is European
Broderick	South Africa		412.50		rough	1928	Present owner unknown
Brunswick Blue		dark-blue		13.75	pear		Last sold in 1784
Brunswick Yellow	India	yellow		30			Sold to Duke Brunswick of Frane. Was sold to Tiffany & Co. in 1874
Burgess	South Africa		220		rough	1907	Its ultimate disposition unknown
Byfield				54.74			Was set in a ring, and belonged to the late Vala Byfield. Present owner unknown
Cambridge				20	pear		Owned by Catherine the Great of Russia. Was named after Lady May Cambridge
Cape	South Africa	canary	297		rough		Belonged to CSO and displayed at its London headquarters
Canary							See Tiffany
Carbonado Casco do Burro	Brazil	bort	2 000		rough		Present owner unknown
Carbonado do Sergio	Brazil	bort	3167		rough	1905	Its ultimate disposition unknown
Carbonado Pontesinha	Brazil	bort			rough	1938	First report 1938
Carbonado Xique-Xique	Brazil	bort	931.60		rough	1905	Present owner unknown
Carlotta	South Africa	light-pink		40.30	pear		Named after wife of Lazare Kaplan
Carmo do Paraneiba	Brazil	brown	245		rough	1937	Present owner unknown
Carns	South Africa		107		macle	1891	Its ultimate disposition unknown
Cartier	South Africa			107.70	pear		Present owner unknown
Cartier-Kenmore	India	canary yellow		38.31	cushion		Named after Rosemarie Kenmore, wife of Cartier. Sold to an undisclosed buyer
Cartier-Taylor-Burton	South Africa		240.80	69.42	pear		Present owner unknown
Cedro do Abaeté	Brazil	lilac	194		rough	1967	Its ultimate disposition unknown
Centenary	South Africa		599	273.85	fancy heart		100 <sup>th</sup> anniversary of De Beers Company
Cent Six			106		rough		Present owner unknown
Changlin	China	yellow	158.79		rough	1977	Its ultimate disposition unknown
Chapada	Brazil		87.50		rough	1851	Present owner unknown

table 33: *continued*

<b>name</b>	<b>origin</b>	<b>color</b>	<b>weight rough</b>	<b>weight cut</b>	<b>cut form</b>	<b>found in</b>	<b>disposition</b>
Charlemont	South Africa	yellow	20				Bought by an officer of Royal Artillery in 1854 in South Africa
Chief of Carlisle	USA		13.50	58.10	octahedron	1966	Found at Murfreesboro, Arkansas
Christopher Black		black			cushion		Last sold by Harry Winston in 1969
Cinnamon Century		walnut-brown		32.16	pear		Present owner unknown
Cissie Patterson			22		cushion		Set in the center of a diamond necklace owned by Mrs. Patterson, former owner of the Washington Times Herald
Cleveland	South Africa		100	50	cushion		Present owner unknown
Coeur			12.33		heart		Auctioned at Paris in 1933. Also spelled Diamant Coeur
Cognac Over Ice		cognac		34	pear		Belonged to Elizabeth Taylor
Colenso	South Africa	yellowish	133.145		rough		Present owner unknown
Constantine			46.05		emerald		Was sold in 1970 in Geneva
Copenhagen Blue	South Africa	blue	45.85		emerald		Named after exhibition in Copenhagen in 1960. Present owner unknown
Cornflower Blue		blue	158	31.92	pear		Present owner unknown
Coromandel I	Brazil		180			1934	Stone was cut in 1934
Coromandel II	Brazil		141			1935	Present owner unknown
Coromandel III	Brazil		226 or 228			1936	Its ultimate disposition unknown
Coromandel IV	Brazil		400.65			1940	Present owner unknown
Cotton Belt Star	USA		11.92		rough	1963	Found by a 14-month old baby, at Pine Bluff, Arkansas
Countess Széchenyi				62.05	pear		Named after the wife of Laszlo Széchenyi
Cross of Asia		champagne		109.26			A Maltese cross can be seen through table
Cross of the South							Same as Abaetié Rose
Crown of Charlemagne		blue		37.05			Was recut from a 42.50 cts. stone by Harry Winston in 1949
Crown		honey-yellow	84		cushion		Owned by Russian Tsar. Disappeared between 1917–1935. After third round brilliant cut in 1963 it weighs 50 cts. Present owner unknown
Cruzeiro Ou Vitória	Brazil		261		rough	1942	Present owner unknown
Cuban Capitol	South Africa	yellow	23		rough		Was sold for Cuban Capitol in Paris in 1928
Cuiaba	Brazil	pale-rose	60.75		rough		Its ultimate disposition unknown



table 33: continued

name	origin	color	weight rough	weight cut	cut form	found in	disposition
Cullinan	South Africa		3106		rough	1905	Was cut into 9 principal and 96 smaller stones
Cullinan I	South Africa		530.20		pendeloque	1905	Also called Great Star of Africa. Mounted in the Royal Scepter of the British Regalia
Cullinan II	South Africa		317.40		cushion	1905	Mounted in the Royal State Crown
Cullinan III	South Africa		94.40		pear	1905	Known as Lesser Star of Africa. Mounted in the Royal State Crown or in a pendant brooch
Cullinan IV	South Africa		63.60		square	1905	Known as Lesser Star of Africa. Mounted in the Royal State Crown or in a pendant brooch
Cullinan V	South Africa		18.80		heart	1905	Known as Lesser Star of Africa. Mounted in a brooch
Cullinan VI	South Africa		11.50		marquise	1905	Set in a diamond and emerald necklace
Cullinan VII	South Africa		8.80		marquise	1905	Mounted with the Cullinan VIII as a pendant on a diamond brooch
Cullinan VIII	South Africa		6.80		oblong	1905	Mounted with the Cullinan VII as a pendant on a diamond brooch
Cullinan IX	South Africa		4.39		pear	1905	Mounted in a finger ring
Cumberland	India			32.82	triangular		Present owner unknown
Czarina Blue		blue		30			Sold in 1953 in Rome present owner unknown
Dan Campbell	South Africa		192.50	32		1916	Present owner unknown
Darcy Vargas	Brazil	brown	460			1939	Its ultimate disposition unknown
Dayarai							Princess Fatima of Afghanistan brought it in 1921 to the USA. No additional information
Darya-i-Nûr	India	pale-pink		175–195	rectangular step cut		Now on display in the Treasury Jewels of Iran. Believed to be a major part of the Great Table. See Nawab of Dacca
De Beers	South Africa	pale-yellow	428.50	234.50	cushion	1888	Sold to an Indian in 1889. Last sold by Cartier in 1982
Deeptide		golden-yellow		104.88	cushion		Named after the estate of Mrs. Book's Family. Last sold in 1955. Not to be confused with 104.52 cts. treated stone
Derrea-i-Nur	India			66	square		Belonged to the Nawab of Dacca. Sold in 1959. Present owner unknown
Dewey	USA		23.75	11.15		1884/1885	Present owner unknown
Diamant Coeur							Same as Diamant Coeur
Diário De Minas-Gerais	Brazil		375.10		rough	1941	Cut into several stones by Harry Winston
Doubledipity	USA	medium yellow	32.99		rough	1987	Consists of 7 intergrown cubes. Present owner unknown
Dowagiac	USA		10.87		rounded hexagonal	1895	Found in 1895 near Dowagiac, Michigan. Present owner unknown

table 33: *continued*

name	origin	color	weight rough	weight cut	cut form	found in	disposition
Dresden Diamonds		green, white and yellow		29.25, 23.10 and 13.48			3 stones smaller than other three mentioned below. On display at the Museum in the Green Vault at Dresden, Germany
Dresden Green	India	apple-green		40.07	pear		On display at the Museum in the Green Vault at Dresden, Germany
Dresden White	India		49.71		square		On display at the Museum in the Green Vault at Dresden, Germany. Also called Saxon White or White Saxon Brilliant
Dresden Yellow	India	yellow		38	brilliant		On display at the Museum in the Green Vault at Dresden, Germany
Dudley							See Star of South Africa, van Niekerk
Du Toit I	South Africa	yellow	250		rough	1871	Also called Oppenheimer Diamond
Du Toit II	South Africa	yellow	127		rough	1871	Present owner unknown
Dutoitspan	South Africa	pale-yellow	616		rough	1974	Exhibit at Kimberly Museum
Eagle	USA	pale-yellow	15.37		rough	1867	Found near Eagle, Wisconsin, USA. Also called Wauke-sha. Stolen in 1964
Earth Star	South Africa	coffee-brown	248.90	111.59	pear	1967	In 1979 sold to Baumgold Bros., New York City, USA
Emperor Justinian				25			May have dropped out of the crown of the Byzantine emperor Justinian during his triumphal procession in Constantinople
Edna Star				115	emerald cut	about 548	Last sold in 1957
Emperor Rose	South America	pink		72.97			Present owner unknown
Emperor Maximillian	Brazil			41.94	cushion		Belonged to the Emperor of Mexico Ferdinand Maximilian Joseph
English Dresden	Brazil		119.50	78.53	pear	1857	Present owner is Cursetjee Fardoonji of Bombay, India
Enigma	USA	brown	17.83			1987	Opaque-brown. Whereabouts is unknown
Eugénie	Brazil		about 100	52.35	oval	1760	Belonged to the Empress Eugénie, wife of Napoleon III of France
Eugénie Blue		cornflower-blue		30.82	heart		Believed to have belonged to the Empress Eugénie. Also called Unzue Heart. Now on display in Smithsonian Institution in Washington, D.C., USA
Eureka	South Africa		21.25	10.73	oval	1866	Now on display at the Open Mine Museum in Kimberly
Excelsior	South Africa	bluish-white	995.20	largest 69.68		1893	Cut into 21 stones, total: 373.79 cts. Present owner unknown
Eye of Brahman							See Black Orloff
Faith	South Africa					1871	A stone of exceptional size

table 33: *continued*

<b>name</b>	<b>origin</b>	<b>color</b>	<b>weight rough</b>	<b>weight cut</b>	<b>cut form</b>	<b>found in</b>	<b>disposition</b>
Fifty Years of Aeroflot	Russia, CIS		232			1973	Named in commemoration of Soviet Aviation Day
Fineberg Jones	South Africa		206.50		rough	1911	Present owner unknown
Flaming Star	South Africa		88	21.90	pear		Cut by Baumgold Bros. And last sold in 1979
Flame of Gold		canary yellow		29	pear		Its ultimate disposition unknown
Fleischman Star		canary yellow		74.44	emerald		Was recut into 71.07 cts. and mounted in a clip-pendant. Present owner unknown
Florentine	India	citron-yellow		137.27	irregular double rose		Also called Grand Duke of Tuscany, Austrian, Yellow, and Austrian Yellow. Present owner unknown
Fly	South Africa		60		rough octahedron	1872	An inclusion is centered in this stone resembling a fly
Frankfurt Solitaire				44.62	brilliant		Belonged to Francis I, Grand Duke of Tuscany. Present owner unknown
French Blue		blue	112.50	67.50	heart		Was among the French Royal Treasury. Believed to have been recut into 45.52 cts. than renamed as the Hope
Gaby Delys		yellow		28.25	heart		Its ultimate disposition unknown
Goiás	Brazil		600	one 80	brilliant	1906	And other cut stones. Also spelled Goyaz
Golconda	India			30	emerald		Last sold in 1960
Golconda "D"	India			47.29			Present owner unknown
Golconda d'Or	India	yellow	130	95.40	emerald		Its ultimate disposition unknown
Golden Dawn	South Africa	white	133	61.50		1913	Sold to Aga Khan
Golden Door		golden-yellow		104.95	shield		Present owner unknown
Golden Hue	South Africa?	yellow		132.42	cushion		Its ultimate disposition unknown
Golden Maharaja		golden-yellow		65.60	pear		Last sold in New York, USA in 1991
Golden Pelican		golden-yellow		64	emerald		Named after Pelican Street (Pelikaanstraat), Antwerp, Belgium. Present owner unknown
Golden Triolette							Same as Incomparable
Gordon	South Africa	pale yellow	30		rough	1862–1866	Present owner unknown
Gordon Orr	India		62	24.85	brilliant	1883	Present owner unknown
Gornyak	Russia, CIS		44		rough		Now in the Russian Diamond Fund, Moscow
Governador Valadares							Same as Benedito Valadares
Goyaz							Same as Goiás Diamond
Graff Imperial Blue	Guinea	blue	101.50	39.81	pear		Its ultimate disposition unknown
Grand Coeur d'Afrique	Guinea	white	278	3 stones one 70.03	heart		The other a heart of 25.22 cts. and the smaller is a marquise of 14.25 cts.

table 33: *continued*

<b>name</b>	<b>origin</b>	<b>color</b>	<b>weight rough</b>	<b>weight cut</b>	<b>cut form</b>	<b>found in</b>	<b>disposition</b>
Grand Mazarin		yellow	≈ 19.10		square		A French crown jewel. Now on display at the Museum Louvre in Paris, France
Grande Condé		light-pink	9.01		pear		Was awarded to Prince Condé, when he became national hero during Thirty Years' War. Also called Chantilly Pink
Great Beginning	Russia, CIS		135.12		rough		Now on display in Museum in Moscow
Great Brazilian	Brazil		130				Belonged to Crown Jewels of Portugal. Present owner unknown
Great Chrysanthemum	South Africa	gold-brown	198.28	104.15	pear	1963	Sold to Julius Cohen New York, USA. Present owner unknown
Great Harry			15.27		lozenge		Belonged to James I of England, 1605
Great Mogul	India		787.50?	280	rose		Present owner unknown
Great Star of Africa							Same as Cullinan I
Great Table	India	pale-pink		242–250?	table	last seen in 1642	Reportedly seen by Tavernier. See Darya-i-Nûr, and Nur-ul-Ain
Great White	South Africa		469	185 and 20	oval and round	1884	Sold to Nizam of Hyderabad, India about 1900. Known as Imperial White, Victoria White, or Victoria, Imperial, and Jacob
Greater Bear	Russia, CIS		114.37		rough		On display at the Museum in Moscow
Grima		fine white		55.91	pear		Last sold to Andrew Grima in 1972, in Geneva, Switzerland
Guinea Star	Guinea	white	255.10	89.01	shield	1986	Other two stones are 8.23 and 5.03 cts.
Guisse		fiery white		33.25	rectangular		Was recut into 29.10 cts. Stolen in 1792 from the French Royal treasury, but recovered
Halphen		rose-red	22.50				No additional information is available
Hanger	South Africa	pale-yellow	123				Sold to Hanger
Harlequin				22	pear		Set in a pendant in a three-row of 97 diamonds necklace
Harry Young	South Africa	pale-yellow	269.50		rough	1913	Present owner unknown
Harvard		yellow	82	rough	perfect octahedron		Owned by Harvard University Museum, Massachusetts, USA. Stolen in 1962
Hastings	India?		101				Was presented to King George III in 1786 by Warren Hastings, Government General of India, from the Nizam of Deccan
Heart	India			35	heart	about 1600	Reportedly Tavernier saw this in the treasure of Mogul Emperor Aurangzib of India
Heart of Antwerp				38.40	heart		Exhibited in 1979 in Antwerp, Belgium

table 33: *continued*

<b>name</b>	<b>origin</b>	<b>color</b>	<b>weight rough</b>	<b>weight cut</b>	<b>cut form</b>	<b>found in</b>	<b>disposition</b>
Holland							See Auckland
Hope	India	sapphire blue	112.25?	45.52	cushion		Believed to have been a part of the Tavernier Blue. Now on display at Smithsonian Institution in Washington, D.C., USA. Also known as Hope Blue
Hope of Africa	South Africa	yellow		151.91			Present owner unknown
Hornby	India?			36	trapezoid?		Believed to be in the Iranian Treasure, Tehran
Hortensia	India	peach		20.53	five-sided		A French royal treasury. Now on display in the Louver Museum, Paris, France
Howeson		sapphire blue		24			Belonged to John Howeson of London
Ice Queen	South Africa		426.50	128.25	pear		After cutting was named as Niarchos. Also called Pre-toria
Idol's Eye	India?	fine light-blue		70.21	pear		Belonged to Sultan Hamid II of Turkey, which sacrificed it as the eye of a sacred idol in the temple of Benghazi. Sold in 1980
Imperial or Imperial White							Same as Great White
Incomparable	West Africa	fancy-brown	890	407.48	triolette		With 14 other diamonds. Also known as the Golden Triolette
Independencia	Brazil		106.82		rough	1941	Its ultimate disposition unknown
Indian	India			250	pear		Its ultimate disposition unknown
Iranian I	South Africa	cape yellow		152.16	rectangular old cut stone		From collection of the National Jewel Treasury of Iran, Tehran
Iranian II	South Africa	silver cape yellow		135.45	old cushion brilliant		From collection of the National Jewel Treasury of Iran, Tehran
Iranian III	South Africa	like II		123.93	old cushion		From collection of the National Jewel Treasury of Iran, Tehran
Iranian IV	South Africa	cape yellow		121.90	multifaceted octahedron		From collection of the National Jewel Treasury of Iran, Tehran
Iranian V	South Africa	cape silver yellow		114.28	old cushion brilliant		From collection of the National Jewel Treasury of Iran, Tehran
Iranian VI	South Africa	cape yellow		86.61	rounded triangular		From collection of the National Jewel Treasury of Iran, Tehran
Iranian VII	South Africa	cape yellow		86.28	irregular Mogul cut		From collection of the National Jewel Treasury of Iran, Tehran
Iranian VIII	South Africa	cape yellow		78.96	old cushion brilliant		From collection of the National Jewel Treasury of Iran, Tehran
Iranian IX	South Africa	cape yellow		75.29	old cushion brilliant		From collection of the National Jewel Treasury of Iran, Tehran

table 33: *continued*

<b>name</b>	<b>origin</b>	<b>color</b>	<b>weight rough</b>	<b>weight cut</b>	<b>cut form</b>	<b>found in</b>	<b>disposition</b>
Iranian X	South Africa	silver cape yellow	75.00	75.00	pendeloque	From collection of the National Jewel Treasury of Iran, Tehran	From collection of the National Jewel Treasury of Iran, Tehran
Iranian XI	South Africa	silver cape yellow	75.00	75.00	pendeloque	From collection of the National Jewel Treasury of Iran, Tehran	From collection of the National Jewel Treasury of Iran, Tehran
Iranian XII	South Africa	champagne yellow	72.84	72.84	irregular pear cut	From collection of the National Jewel Treasury of Iran, Tehran	From collection of the National Jewel Treasury of Iran, Tehran
Iranian XIII	South Africa	cape yellow	65.65	65.65	rectangular old cut stone	From collection of the National Jewel Treasury of Iran, Tehran	From collection of the National Jewel Treasury of Iran, Tehran
Iranian XIV	South Africa	cape yellow	60.00	60.00	cushion cut brilliant	From collection of the National Jewel Treasury of Iran, Tehran	From collection of the National Jewel Treasury of Iran, Tehran
Iranian XV	South Africa	silver cape yellow	57.85	57.85	round brilliant	From collection of the National Jewel Treasury of Iran, Tehran	From collection of the National Jewel Treasury of Iran, Tehran
Iranian XVI	South Africa	silver cape yellow	57.15	57.15	cushion cut brilliant	From collection of the National Jewel Treasury of Iran, Tehran	From collection of the National Jewel Treasury of Iran, Tehran
Iranian XVII	South Africa	silver cape yellow	56.19	56.19	cushion cut brilliant	From collection of the National Jewel Treasury of Iran, Tehran	From collection of the National Jewel Treasury of Iran, Tehran
Iranian XVIII	South Africa	cape yellow	55.67	55.67	cushion cut brilliant	From collection of the National Jewel Treasury of Iran, Tehran	From collection of the National Jewel Treasury of Iran, Tehran
Iranian XIX	India?	colorless	54.58	54.58	rectangular oval cut	From collection of the National Jewel Treasury of Iran, Tehran	From collection of the National Jewel Treasury of Iran, Tehran
Iranian XX	India	peach	54.35	54.35	old cushion brilliant cut	From collection of the National Jewel Treasury of Iran, Tehran	From collection of the National Jewel Treasury of Iran, Tehran
Iranian XXI	India	silver cape	53.50	53.50	old cushion brilliant cut	From collection of the National Jewel Treasury of Iran, Tehran	From collection of the National Jewel Treasury of Iran, Tehran
Iranian XXII	India?	colorless	51.90	51.90	elliptical Mogul cut	From collection of the National Jewel Treasury of Iran, Tehran	From collection of the National Jewel Treasury of Iran, Tehran
Iranian XXIII	India?	colorless	38.18	38.18	multi faceted trapezoid	From collection of the National Jewel Treasury of Iran, Tehran	From collection of the National Jewel Treasury of Iran, Tehran
Itutuaba	Brazil		105	105		1940	Present owner unknown
Jacob I							Same as Great White
Jacob II	India	white	100	100			Reportedly cut, appears white not blue
Jagersfontein							Same as Winston
Jagersfontein Rough	South Africa		215	215	rough	1881	Its ultimate disposition unknown
Jahan Akbar Shah							Same as Akbar Shah
Jahangir	India	India	83.03	83.03	pear-shaped, engraved		Belong to the Jahangir Shah, Emperor of Mogul Dynasty, India. Last sold in 1957 to an Indian businessman

table 33: *continued*

<b>name</b>	<b>origin</b>	<b>color</b>	<b>weight rough</b>	<b>weight cut</b>	<b>cut form</b>	<b>found in</b>	<b>disposition</b>
Jalmeida	Brazil	pale-yellow	109.50	45.50		1924	Present owner unknown
João Neto de Compos	Brazil		201		rough	1947	Its ultimate disposition unknown
Jonker	South Africa	fine color	726	1 of 125.65 recut into 125.35	marquise		The other 11 stones are cut as emeralds. Sold in Hong Kong in 1977. Jonker II weight 40.46 and Jonker IV 30.70 cts.
Jubilee	South Africa		650.80	245.35	cushion	1895	Owned by Paul-Louis Weiller who loaned it to Smithsonian Institution, Washington, D.C., where it is on display. Also called Reitz
Julius Pam	South Africa	yellow	246	123		1889	Not to be confused with the Pam
June Briollette		greenish-yellow		48.42	briolette		Mounted in an oval, round pin. Present owner unknown
Juscelino Kubitschak	Brazil		174		rough	1954	Present owner unknown
Kasikçi	India			84	pear, rose-cut		Belonged to the Sultan of Turkey. Now on display at the Topkapi Museum in Istanbul. Also called Spoon-maker's, or Turkey II
Khedive		champagne		36.61	emerald		Recut from a stone of 43 cts. Present owner and location unknown
Kimberley	South Africa	champagne	490	55.09	emerald		Recut a number of times. Present owner unknown
Kimberley Octahedron (1)	South Africa	yellow	616		well-formed octahedron	1974	The largest octahedron and the ninth largest rough diamond ever found. It is exhibited in the Old Mines Museum, South Africa
Kimberley Octahedron (2)	South Africa	yellow	253.70		octahedron	1964	Harry Winston presented it to the Smithsonian Institution, Washington, D.C., USA in memory of Ernest Oppenheimer
Kirti Noor	India	pink		15	pear		Last sold in 1990
Koh-i-Nûr	India		said to be 800	108.93	oval		Belonged to Mogul emperors Baber. Nadir Shah brought it to Persia in 1739. Now in the British Crown Jewels in the Tower of London
Krandall		yellow		40	cushion		Belonged to Sidney Krandall
Kollur	India?			63			Said to have been bought by Tavernier in 1653 at Kollur Mines, Golconda
Koslow I & II			2 stones	one 20	one pear		2 diamonds were cut from a rough stone of unknown weight. No further information about Koslow I, but reportedly Koslow II may be pear cut of 20 cts. Sold in 1961
Kruger	South Africa		200		rough		Present owner unknown
Krupp				33.19	emerald		Owned by ex-wife of a German industrialist. Sold to Richard Burton in 1968 for his wife Elizabeth Taylor

table 33: *continued*

<b>name</b>	<b>origin</b>	<b>color</b>	<b>weight rough</b>	<b>weight cut</b>	<b>cut form</b>	<b>found in</b>	<b>disposition</b>
La Belle Helene	South Africa		160			1951	Owned by Romi Goldmuntz who named it after his wife. Cut into two pear shapes of 30.38, and 29.71 cts. and a marquise of 10.50 cts.
La Favorite			50.28				Said to be owned by a Persian. Present whereabouts unknown
Lal Qila		green	72.26		brilliant		Recut into 70.10 cts. Purchased by King Farouk of Egypt in 1951. Present owner unknown
La Reine des Belges			50		cushion		Recut into an emerald of 40 cts. The present owner may be the Belgium Royal Family
Leopold			10		brilliant		Now owned by a private collector
La Rose Pink	pink		7.07		marquise		Whereabouts unknown
Lesotho	South Africa	brown	601.25	totally 242.50	18 stones, 2 emeralds and one marquise	1967	Cut by Harry Winston. Two of emeralds weight 71.73 and 60.67 cts. one marquise of 40.42 cts. Also called Lesotho Brown
Lesotho B	South Africa		527		rough	1965	Present owner unknown
Lesotho Brown							Same as Lesotho Diamond
Lesotho C	South Africa	brown	383		rough	1983	Reportedly cut into 10 stones, the largest of them a 24 cts.
Letny	Russia, CIS		46.36		rough	1955	Now exhibited at the Kremlin, Moscow
Lewis and Clark	USA	light-yellow	14		rough	1990	In Montana. Present owner unknown
Libertador or Liberator	Venezuela		155	totally 68.29	3 emeralds, and 1 marquise	1942	Harry Winston cut it into four stones: 3 emeralds of 39.80, 18.12, and 8.93 cts. and a marquise cut of 1.44 cts.
Light of India			2 of 25.50 and 12.38				Not specified, which one is the Light of India, or the other being the Rajah. Sold in 1886
Light of Peace	Sierra Leone		434.60	one of 130.27	pear	1960	The other 12 weighing from 9.11 cts. to 0.37 cts. Also called Zale Light of Peace
Lisa Blue		sky blue	37.21		brilliant		Recut into 37.05 cts. Sold in 1967 by Harry Winston
Litkie	South Africa		205.50			1891	Present owner unknown
Little Sancy							See Bazu
Luis Cartier							Same as Cartier
Luis XIV			62.05		pear		Bought by Harry Winston in 1958, who recut it into 58.60 cts.
Mable Bolls			44.76		emerald		Owned by Mable Bolls. Sold in 1950 by Harry Winston. Resold in 1966
Mahjal							Same as Algeiba Star
Mahomet IV			24				Added to the Imperial Treasure, Turkey about 1600. May be apocryphal



table 33: *continued*

<b>name</b>	<b>origin</b>	<b>color</b>	<b>weight rough</b>	<b>weight cut</b>	<b>cut form</b>	<b>found in</b>	<b>disposition</b>
Major Bowes		yellow		44.50			Stolen in 1958 and never found
Maria	Russia, CIS		106		rough	1966	Now on display at Russian Diamond Fund in Moscow
Marie Antoinette		grayish-blue		5.46	pear		Now privately owned
Marie Antoinette Earrings			2 stones	36 each			Set in platinum, presented by Mrs. Eleanor Close Brazin to the Smithsonian Institution, Washington, D.C., USA
Marlborough				48.01	cushion		Owned by Gladys Marie Spencer-Churchill, wife of the 9 <sup>th</sup> Duke of Marlborough. Recut in the form of a sunburst weighing 45 cts.
Martin Pink		pink		12.03	round brilliant		Sold to Harry Winston in 1975, who called it the Martin Pink. Sold to an unknown client
Mascarenhas I and II	India			67.50 and 57			Seen by Tavernier in India in 1648, believed to belong to the Portuguese Viceroy, Dom Philip Mascarenhas. Present owner unknown
Matan or Mattam	Kalimantan	blue	367		pear	19 <sup>th</sup>	Believed to actually be quartz
Mato Grosso	Brazil	brown-rose-purple	227			1963	Present whereabouts unknown
Maximilian	Brazil	greenish-yellow	50	33	cushion		Owned by Archduke Maximilian of Austria. Was sold to Morris Nelkin in 1946 in New York. During a robbery it was lost and never recovered. Also called Carlotta of Belgium
McFarlin		canary yellow		49.40	emerald		McFarlin Family presented it to the White Memorial Museum in San Antonio, Texas, in 1961. In 1968 it was stolen and never recovered
McLean		white		31.26	cushion		Now owned by a Japanese buyer
Mendelsohn	South Africa						Set in a men's ring with the initials S. M. Abbreviation for its owner Sidney Mendelsohn
Meister	South Africa	yellow		118.05	cushion		Owned by Walter Meister, Switzerland
Merrweather Post							Same as Rovensky
Milford	USA		6			1879	Found near Milford, Claremont County, Ohio
Minas Gerais	Brazil		172.50	80	brilliant	1937	Present owner unknown
Miner	Russia, CIS		44.62		rough	1960	Believed to be among the Russian Diamond Fund in Moscow
Mirror of Portugal				20.30	rectangular table		Belonged to Portuguese Crown Jewels. Sold to Cardinal Mazarin. Bequeathed together with other diamonds to the French Crown. Was stolen in 1792
Moon	India	yellow		183	brilliant		Believed to have been once a part of the Russian crown jewels. Also known as Moon of the Mountain?

table 33: *continued*

name	origin	color	weight rough	weight cut	cut form	found in	disposition
Moon of Baroda	India	canary yellow	24	pear	pear	Was auctioned by Christie's in 1991 in New York, USA	Present owner unknown
Moon of the Mountain	India		121				Was owned by Robert Mouawad in 1976
Mouawad Lilac Pink		pink	24.44	pear mixed			Was owned by Robert Mouawad in 1990
Mouawad Splendour		white	101.84	marquise			Was owned by Robert Mouawad in 1990
Mouawad White		white	48.28	marquise			Was purchased by Mounce a jeweler who cut it into three stones
Mounce	USA	light-brown	18.20	3.47, 2.75, and 2.27	oval, heart, marquise	1969	Believed to have belonged to the National Jewels of Iran, which was not recorded by Meen
Mountain of Splendor	India?		135				Same as McFarlin
Myrle McFarlin							Owned by Napoleon I Emperor of France, which was mounted in the hilt of his sword
Napoleon			34	brilliant			It was set as an eye in the statue of an idol of god Shiva in a Hindu temple near the city Nasik, India. Present owner is the King of Saudi Arabia since 1977
Nassak	India		repolished into 80.50 then recut into 43.38	last recut into an emerald			Belonging to the Nawab of Dacca. Also called Darya-i-Nür, but has no connection with the true Darya-i-Nür (Iran)
Nawab of Dacca	India		150	square			Purchased by Maharani Gulabkumbarba of Nawanagar, India
Nawanagar	Russia?		148	brilliant			Was owned by Badahur Rana of Nepal. Sold to Winston in 1957, repolished into 79.41 cts. Present owner is a European since 1961
Nepal	India	white	79.50	pear			Its ultimate disposition unknown
Nepal Pink	India	pink	72				Its ultimate disposition unknown
New Star of the South	Brazil		140				Harry Winston cut it into 3 stones totalling 196.12 cts. All three were bought in 1957 by Stavros S. Niarchos, from Greece. Also called the Ice Queen and Pretoria
Niarchos	South Africa	white	426.50	128.50, 40.00 and 27.62	pear, emerald, and marquise	1945	May be owned by the Nizams of Hyderabad, India. Present owner unknown
Nizam	India?		340	≈277	partially cut	1835	Present whereabouts unknown
Nooitgedacht	South Africa	yellow	325		rough	1953	Sold to Baumgold Bros. in 1969
North Star	South Africa	blue	97	32.41	pear		Present owner unknown
Nova Estrêla do Sul	Brazil	greenish	140		rough	1937	Surviving pieces of the Great Table (Meen). Now on display in National Jewel Treasury of Iran, Tehran
Nür-ul-Ain	India	pink	60		pear		Mounted in a cross with other diamonds, owned by Alexander Tzary of Russia. It was sold in London in 1898. Present owner unknown
Nür-ul-Deen		pink					

table 33: *continued*

<b>name</b>	<b>origin</b>	<b>color</b>	<b>weight rough</b>	<b>weight cut</b>	<b>cut form</b>	<b>found in</b>	<b>disposition</b>
Oppenheimer	South Africa	yellow	253.70		octahedral rough	1964	Harry Winston presented it to the Smithsonian Institution, Washington, D.C. USA, in memory of Ernest Oppenheimer. Also called Dutoitspan
Orchid		pink-lavender	30.45	9.93	emerald		Cut by Lazare Kaplan in 1935 New York City, USA
Orloff or Orlov	India	light bluish-green		189.62	rose		Now in Russian Diamond Fund in the Kremlin, Moscow
Orpin-Palmer	South Africa	dull-white	117.50		rough	1902	Present owner unknown
Ortlepp	South Africa				rough triangular	1869	Was found by Mrs. Sarah Ortlepp. Now on display at the African Museum in Johannesburg
Otto Borgstrom	South Africa	yellowish	121.50		rough	1907	Its ultimate disposition unknown
Pam	South Africa		112–115	56.60	brilliant	1891	Also called Pam Brilliant Diamond, and Jagersfontein Brilliant
Paolo de Frontin	Brazil	greenish-yellow	49.50		rough		Was merchandised in 1930 in London. Present owner unknown
Paragon	Brazil	white	320	137.82	shield		Sold in Antwerp and mounted in a necklace by Graff Diamonds of London
Pasha of Egypt	India			40	octagonal		Owned by Ibrahim Pasha of Egypt. It was twice recut at least into a 36.22 cts. Believed to be in Italy
Patos	Brazil	brown	324		rough	1937	Its ultimate disposition unknown
Patrocinio	Brazil		120.36		rough	1851	Whereabouts unknown
Paul I	India	pink-red		13.35	cushion		Now on display in the Russian Diamond Fund in Moscow
Paulo de Frontin	Brazil		49.50				Whereabouts unknown
Peace	India			12.25			Whereabouts unknown
Peace Uncut	Russia, CIS		56.20		rough	1962	Its ultimate disposition unknown
Peach-Blossom		pink		24.78	pear		Purchased by Louis XIV of France. Now on display at Louvre Museum in Paris
Penthièvre		yellow		12	oval		Belonged to Duc de Penthièvre
Philip II				48			Owned by Philip II of Spain in 1559. Present owner unknown
Pink Mouawad		pink		21.06	cushion		Was owned by Robert Mouawad in 1989
Pigot or Pigott	India			48.63	oval		Named after George Pigot British Colonial Governor of Madras, India. Also called Lottery
Pitt							See Regent Diamond
Platberg	South Africa			5		1859	Discovered 7 years before Eureka Diamond

table 33: *continued*

<b>name</b>	<b>origin</b>	<b>color</b>	<b>weight rough</b>	<b>weight cut</b>	<b>cut form</b>	<b>found in</b>	<b>disposition</b>
Pohl	South Africa		287	the largest 38.19	emerald	1934	Cut into 15 stones. The largest an emerald cut weighing 38.19 cts. Purchased in 1943 by Bernice Chrysler Garbisch
Polar Star	India?			41.29	cushion		Owned by Joseph Bonaparte of France? Now in Bombay, India. Also called Youssouppoff
Porgés		champagne		78.53	emerald		Sold to Harry Winston in 1962. Set in a clip-pendant. Last sold in 1968
Porter-Rhodes	South Africa		153.50	56.50	emerald	1880	First cut into a 73 cts., then recut into an emerald of 56.50 cts. Harry Winston bought it in 1946 and recut it into 54.99 cts.
Portuguese	South Africa	white		127.02	octagonal emerald		Sold in 1951 to Harry Winston who presented it to the Smithsonian Institution, Washington, D.C., USA in 1963
Premier				86.40	emerald		Harry Winston mounted it in a pendant-clip with several diamonds. Sold in 1958
Premier Rose	South Africa	blue-white	353.90	137.02, 31.48 and 2.11	pear, rose and round brilliant	1977	Was cut into three stones totally of 270.61 cts. The other two are Little Rose Pear and a circular brilliant known as Baby Rose
Presidente Dutra	Brazil		409		36 stones	1949	36 fashioned diamonds were cut totaling 136 cts. Also called Dutra
Presidente Vargas	Brazil		726.60		the largest was cut as emerald	1938	Harry Winston fashioned it into 29 stones, the largest of 48.26 cts. Was recut into 44.17 cts. and was sold in 1961. Present owners are unknown
Prince Edward of York	Africa			60.25	pear	about end of 1800	In 1901 sold in New York, USA. Its ultimate disposition unknown
Princess Mathilde				16.25	hexagon		Whereabouts unknown
Prince		pink		34.64	cushion		Named after Prince son of Baroda, India
Progress	Russia, CIS		80.66		rough		Now on display at the Russian Diamond Fund in Moscow
Punch Jones	USA	greenish-gray	34.46		rough	1928	Now on display at the Smithsonian Institution, Washington, D.C., USA
Queen Frederica		colorless		2	table		Engraved with a portrait of Queen Wilhelmina of Holland
Queen of Albania	South Africa?			49.03	pear		Sold in London in 1960. Believed that it is the same as Pigott Diamond
Queen of Holland	India	whitish-blue		136.25	cushion		Recut into 135.92 cts. Present owner unknown
Raj Red	India?	orange	2.33				Real color is brownish-orange
Raulconda	India			103			Reportedly seen by Tavernier at the Raulconda Mine in India

table 33: *continued*

<b>name</b>	<b>origin</b>	<b>color</b>	<b>weight rough</b>	<b>weight cut</b>	<b>cut form</b>	<b>found in</b>	<b>disposition</b>
Red	South Africa	red	35	5.05	emerald	1927	Sold in 1970
Red Cross	South Africa	canary-yellow	375	205.07	square	1900	After cutting had a curious feature like a Maltese Cross, visible when looking through the table. Sold by Christie's in 1977
Regale of France					like bird's egg		Belonged to Louis IX of France, who exchanged it for a lead figure of St. Thomas à Becket
Regent	India	whitish-blue	410	140.50	cushion	1701	Named after Philippe II Duc d'Orleans, Regent of France. Now on display in the Louvre Museum, Paris. Sometimes called Millionaire, and Pitt
Regent of Portugal	Brazil			215	brilliant	1775	Thought to be probably a topaz
Reitz							Same as Jubilee
Rembrandt		black	125	42			Named after Dutch painter Rembrandt van Rijn. Present owner unknown
Riccica		rose		15			Belonged to Princee de la Riccia of Italy
Richelieu				19	heart, rose		Belonged to Cardinal Richelieu Chief of France, who presented the stone to the French Crown. Was stolen in 1792
Riggs		colorless		28.30			Reportedly now in the Smithsonian Institution, Washington, D.C., USA
River Styx	South Africa	black		28.50	brilliant		And a marquise stone of 7.00 cts.
Rojtman	South Africa	yellow		107.60	cushion		Repolished into 107.46 cts. in 1957 by Harry Winston who set it in a clip-pendant. Sold in 1963 to Rojzman in USA
Rosa de Abaeté	Brazil		80.30		rough	1935	Whereabouts unknown
Rose d'Angleterre					circular		Was bequeathed to Anne of Austria by Cardinal Mazarin in 1661
Rovensky				31.40	cushion		Harry Winston recut it into 31.20 cts. in 1957 with the name of Merrivether Post
Rovensky Necklace		colorless		46.50	pendant		Sold in 1957. Present owner unknown
Royal Gold Canary		canary yellow					Was offered in 1951 in a rosette brooch at Palm Beach, Florida, USA
Russian Table				68			Reportedly seen among the Russian Crown Jewels in Moscow
Russian Table Portrait	India			25	flat pear		Now on display in the Russian Diamond Fund in Moscow
Samantha Smith	Russia, CIS						On display in the Russian Diamond Fund
Sancy				60.40	pear		Owned by Maharajah of Patiala, India



table 33: *continued*

<b>name</b>	<b>origin</b>	<b>color</b>	<b>weight rough</b>	<b>weight cut</b>	<b>cut form</b>	<b>found in</b>	<b>disposition</b>
Stalingrad							Same as Siberian
Star of Abdul Aziz			59		pear		Named for the King of Saudi Arabia. It was sold in 1988. Present owner unknown
Star of Africa							Same as Cullinan I
Star of Arkansas	USA		15.33	8.27	marquise	1955	Sold it to a private collector
Star of Asia							A diamond of unknown weight worn by Princess Barbe Maria Romanovsky-Tirtoff at her marriage in 1951
Star of Beaufort	South Africa		100?				Whereabouts unknown
Star of Bombay		yellow	47.39		cushion		Whereabouts unknown
Star of David	South Africa					1955	A diamond crystal shaped like a Star of David
Star of Denmark	South Africa	yellow	105	34.29	brilliant	1885	Also called Kapiolani. Present owner unknown
Star of Diamonds	South Africa		107.50		brilliant	about 1870	Assumed to be the same as Rojftman
Star of Egypt	India?			recut into 105.19	octagonal step		Owned by Khedive of Egypt around 1850. At the time it weighed 250 cts. in oval shape
Star of Este	India		26.16		cushion		Present owner unknown
Star of Independent	Sierra Leone		294.10	75.52	pear	1976	Was named in honor of the American Bicentennial celebration. Owned by a Middle Eastern Client in 1976
Star of Minas	Brazil		179.30		rough	1910 or 1911	Also known as Estrêla de Minas and Estrêla do Sul. Whereabouts unknown
Star of Murfreesboro	USA	blue	32.25		rough	1964	Present owner unknown
Star of Peace	Central Africa		500	170.49	brilliant	1976	Sold in 1981
Star of Persia		light-yellow		88	round brilliant		Also called Spirit of Hope, Turkestan, and Good Hope
Star of Sarawak	Borneo		70				In 1870 was Bought by Rajah of Sarawak, India. Present owner unknown
Star of Sierra Leone	Sierra Leone		968.90	totally 238.48	cut into 17 stones	1972	Harry Winston bought it in 1972 and cut, the largest of 53.96 cts. into an emerald
Star of South Africa	South Africa		83.50	47.69	pear	1869	Also called Dudley Diamond, Van Niekerk. Present owner unknown
Star of Süleyman			149	93.86	oval		Owned by Süleyman Sultan of Turkey. Was sold in 1957. Present owner unknown
Star of Texas	Africa	sherry		48.19	brilliant		Was cut in Belgium. Present owner unknown
Star of the East	India?			94.80	pear		Owned by Sultan Abdul Hamid II of Turkey. In 1949 sold to Harry Winston
Star of the Sky	India	blue		40.68	pear		Now owned by a European

table 33: *continued*

name	origin	color	weight rough	weight cut	cut form	found in	disposition
Star of the South I	Brazil		261.24	128.80	oval	1853	Owned by Mulhar Rao, Gaekwar of Baroda, India
Star of the South II				15.28	kite		Repolished by Harry Winston into 14.37 cts. Was sold in 1981 privately
Star of Yakutia	Russia, CIS		332		rough	1973	Now on display in the Russian Diamond Fund in Moscow
Star of Zion	South Africa		85		rough	1917	Present owner unknown
Stephanie				67.55	brilliant		Bought by Harry Winston in 1957. Privately sold in 1965 to a Saudi Arabian
Sterns	South Africa	yellow	223.60	85.93, 21.04 and 6.08	brilliant, emerald and marquise		Cut into 3 stones a brilliant of 85.93 an emerald cut of 21.04 and a marquise of 6.08 cts. Sold to Sterns Company, New York
Stewart	South Africa	light-yellow	296	123	brilliant	1872	Sold to Stewart from Port Elizabeth who cut it. Also called Star of Spaulding
Stonewin			232	78.54	emerald		Bought by Harry Winston in 1958. Sold in 1962
Sultan Abdul-Hamid II		yellow		70.54			Belonged to Ottoman Empire of Turkey. Was sold in 1983, together with the Idol's Eye and Emperor Maximilian
Sultan of Morocco		blue-gray		35.27	cushion		Sold to Cartier in 1922 in New York. Was resold in 1972. Present owner unknown
Summit				21.60			Sold in 1960 to a Monnickendam director of a diamond company in Hove, England
Sunrise		yellow		100.52	emerald		Whereabouts unknown
Swan				36	hexagonal		Worn by the Queens of Spain, Portugal, Bavaria, Belgium, France, Holland and Austria. Present whereabouts unknown
Tablet of Islam		black		160.18	emerald		Whereabouts unknown
Tablet Stone				23 or 25	pear		Was mounted in the Russian Grand Imperial Crown. Now on display in the Russian Diamond Fund in Moscow
Tai Hang Star	South Africa		120	60	?		No additional information is available
Taj-e-Mah	India			115.06	Mogul rose cut		May be a sister stone of the Darya-i-Nür. Now on display at National Jewel Treasury of Iran, Tehran
Talisman				24	emerald		Was seen by Brock and Company in Los Angeles. Present whereabouts unknown
Tavernier A	India			51	oval		Tavernier bought among other stones in India, brought back to France
Tavernier B	India			32			Tavernier bought among other stones in India, brought back to France



table 33: *continued*

<b>name</b>	<b>origin</b>	<b>color</b>	<b>weight rough</b>	<b>weight cut</b>	<b>cut form</b>	<b>found in</b>	<b>disposition</b>
Tavernier Blue	India	blue	112.50	112.50	Mogul		Tavernier bought it in India, brought it back to France. Said to be cut into a heart-shaped stone of 67.50 cts. Believed to have been recut into 45.52 cts., then re-named as Hope
Tavernier C	India		31		brilliant		Tavernier among other stones from India, brought back to France
Tavernier Pear			54.75		pear		Seen by Tavernier in 1658 in India, probably was taken by Nadir Shah to Persian
Taylor-Burton-Cartier							See Cartier-Taylor-Burton Diamond
Taylor Heart	India		?		heart		Engraved with the name Queen Momtaz, the wife of Mogul Emperor Shah Jahan, who built the Taj Mahal, India
Tennant		yellow	112	68	brilliant		Owned by James Tennant a London mineralogist. Present owner unknown
Tereshchenko	India?	blue	42.92				Was purchased by Tereshchenko family of Russia. In 1984 sold to a Saudi Arabian
The Arc							See Arc
Theresa	USA		21.25	9.27	brilliant	1886	Present owner unknown
Three Tables	India?			3 stone 48 to 4 old			Tavernier saw it in 1665 in India. Believed they were carried to Persia after sack of Dehli in 1739. Present owner unknown
Throne	India			90			Reportedly seen in India by Tavernier, it was one of the principal ornaments in the Peacock Throne
Tiffany	South Africa	yellow	287.42	128.51	cushion	1878	Bought by Tiffany and Co. in USA in 1879. Also called Canary Diamond
Tiger-eye	South Africa	amber	178.50	61.50	brilliant	1913	Whereabouts is unknown
Tiros I	Brazil	brown	354		rough	1938	Present owner unknown
Tiros II	Brazil	pink	198		rough	1936	Whereabouts is unknown
Tiros III	Brazil		182		rough	1936	Present owner unknown
Tiros IV	Brazil	brown	173		rough	1938	Whereabouts is unknown
Tiros Lilac	Brazil	lilac	12.25		rough	1938	Present owner unknown
Titan Oval	South Africa		98.31	51.31	oval		Whereabouts is unknown
Toktogul	Russia, CIS		37.56		rough	1955	Now on display in the Russian Diamond Fund in Moscow
Transvaal	South Africa	champagne yellow	240	67.89	pear		Presented to the Smithsonian Institution in Washington, D.C., USA
Transvaal Blue	South Africa	blue		25	pear		Present owner unknown

table 33: *continued*

<b>name</b>	<b>origin</b>	<b>color</b>	<b>weight rough</b>	<b>weight cut</b>	<b>cut form</b>	<b>found in</b>	<b>disposition</b>
Tri-Sakti	Borneo	blue-white	166.85	50.53	emerald		Sold to a European. Tri-Sakti is an Indonesian term it means 3 principles
Turkey I				140 to 147			Belonged to Turkish Regalia. Also known as Ottoman Diamond. Present owner unknown
Turkey II							Same as Spoon Maker Diamond
Uncle Sam	USA	light brown	40.23	12.42	emerald	1924	Present owner unknown
Unnamed	South Africa	yellow	616				On display by De Beers Consolidated Mines in Kimberley, South Africa
Unnamed Brown	South Africa	brown	755.50	545.67	cushion	1986	Present owner is De Beers Consolidated Mines
Unnamed Brown				107.10	cushion		Present owner unknown
Unnamed Colorless				141.23	pear		Present owner unknown
Unnamed Colorless				118			Present owner unknown
Unnamed Colorless				102.65	antique		Present owner unknown
Unnamed Colorless				102.61	cushion		Present owner unknown
Unnamed Colorless	India			101.25			Present owner unknown
Unnamed Light-Brown				102.42	pear		Present owner unknown
Unnamed White				111.82	heart		Present owner unknown
Unnamed White				106	pear		Present owner unknown
Unnamed White				101.84	pear		Present owner unknown
Unnamed White				101.14	kite		Present owner unknown
Unnamed Yellow				200.87	pear		Present owner unknown
Unnamed Yellow				180.95	brilliant		Present owner unknown
Unnamed Yellow				150.00	emerald		Present owner unknown
Unnamed Yellow	India			114.28	brilliant		Present owner unknown
Unnamed Yellow	South Africa?			114.03	cushion		Present owner unknown
Unnamed Yellow		treated		108.04	emerald		Present owner unknown
Unnamed Yellow				104.52	cushion		Present owner unknown
Unnamed Yellow				101.25	brilliant		Present owner unknown
Unzue Heart		cornflower blue		30.82	heart		Erroneously known as Eugénie Blue. Now on show in the Smithsonian Institute, Washington, D.C., USA
Vainer-Briolette	South Africa	fancy yellow	202.85	116.60	brilliant		Cut in 1985 in London by M. Vainer. Sold to Sultan of Brunei, Asia

table 33: *continued*

<b>name</b>	<b>origin</b>	<b>color</b>	<b>weight rough</b>	<b>weight cut</b>	<b>cut form</b>	<b>found in</b>	<b>disposition</b>
Valentina Tereshkova	Russia, CIS		61.66		rough		Named after first women cosmonaut. Now on display in the Russian Diamond Fund, Moscow
Vanderbilt			16.25		pear		Present owner unknown
van Niekerk I	South African		21.25			1866	Which was named as Eureka
van Niekerk II	South Africa		83.50	47.69	pear	1869	First found a stone of 21.25 cts., which is known as Eureka. Second one is named as van Niekerk or Star of South Africa, Dudley
van Zyl	South Africa		229.25			1913	Present owner unknown
Vargas							Same as President Vargas
Véga			14		marquise		Named after blue star Vega in the heaven
Venter	South Africa	pale-yellow	511.25			1951	Was cut into 20 diamonds. Named after mine owner J. Venter
Victoria I	South Africa		469	184.50	cushion	1884	A round brilliant of 20 cts. Also called Great White, Victoria White, Imperial, Victoria Imperial, Jacob, or Victoria II
Victoria II	South Africa		428.50	228.50 and 288.50	brilliant	1880	Whereabouts unknown
Victoria III							Same as Woyie River
Victoria Transvaal	South Africa	champagne	240	67.89	pear	1950	Set in a yellow necklace with 108 other diamonds. Now on display in the Smithsonian Institution in Washington, D.C., USA
Victory							Same as Vitória
Vitória	Brazil		328.34	largest 30.39	into 44 stones	1943	Sold to Harry Winston who cut it into 44 stones. Largest of 30.39 cts.
Voshod-2	Russia, CIS						A large diamond of unknown weight in the Russian Diamond Fund in Moscow
Walska Briquette				95	briolette		Owned by Ganna Walska, opera star. It was auctioned in 1971. Present owner unknown
Walska Heart				21	heart		Owned by Ganna Walska, opera star. It was auctioned in 1971. Present owner unknown
Washington	South Africa		342	89.23 and 42.98	pear		Cut by Harry Winston. Named after former American President George Washington. Present owner unknown
Webster Kopje	South Africa		125			1907	Whereabouts unknown
William II of Holland				10	pear		On, which a portrait of William II of Holland is engraved. Now on display at the Chicago Museum of History, USA
Williamson Pink	Tanzania	pink	54.50	23.60	brilliant	1947	Frequently called Queen Elizabeth Pink

table 33: *continued*

<b>name</b>	<b>origin</b>	<b>color</b>	<b>weight rough</b>	<b>weight cut</b>	<b>cut form</b>	<b>found in</b>	<b>disposition</b>
Windsorten	South Africa		140		rough	1961	Sold by J. J. Steyn, who found it. Present owner unknown
Winston	South Africa		154.50	62.05	pear	1952	Harry Winston cut and then recut into 61.80 cts. It was auctioned in 1981. Formerly known as Jagersfontein
Winston Heart			206	59.25	heart		Was recut by Harry Winston into an emerald of 40.97 cts.
Winston Pink		pink		22.84	marquise		Purchased by Harry Winston in 1975. Later was sold it in 1987
Wittelsbach	India	blue		35.56	oval		Sold privately in 1964 in Germany
Woyie River	Sierra Leone		770	largest 31.35	emerald	1945	Cut into 30 stones largest an emerald of 31.35 cts. Also known as Victoria
Yakut	Russia, CIS			32	rough	1953	Present owner unknown
Yellow Goddess			100	29.50	emerald		Was exhibit by a jeweler at Beverly Hills in Los Angeles, USA. Whereabouts unknown
Yubileiny	Russia, CIS		32.56		rough	1956	Whereabouts unknown
Zale Light of Peace							See Light of Peace
Zlata Prata	Russia, CIS		38.72		rough	1955	It means Golden Prague. On display in the Russian Diamond Fund, Moscow

table 34: notable rubies

<b>name</b>	<b>origin</b>	<b>color</b>	<b>weight rough</b>	<b>weight cut</b>	<b>cut form</b>	<b>found in</b>	<b>disposition</b>
Anne of Brittany's Black Prince			105		irregular		On display at the Museum in Louvre, Paris, France See Black Prince Spinel
De Long Star	Myanmar	red star ruby	100.32			1930	Named after George Bowen de Long who donated it to the American Museum of Natural History, New York City
Edith Haggin de Long	Myanmar	red	100				In the collection of the American Museum of Natural History, New York. Also called Edith Haggin de Long Star Ruby
Edward's		red	167				Now on display in the British Museum, Natural History Section. Was presented by John Ruskin in 1887
Gnaga Boh	Myanmar	fine red	44	20			Also known as Dragon Lord Ruby
Khiraj-i-Alam	India	fine red spinel					A misnomer for red spinel. Owned by Mogul dynasty. Also called Timur ruby. Now among the British Crown Jewels
Peace	Myanmar	fine red	43		rough	1919	
Pigeon Blood	Myanmar	red	20	7.50		1933	
Rosser Reeves Star	Sri Lanka	fine red		138.70	6-rayed star		Needle-like inclusions arranged at 60° angles

table 35: notable sapphires

name	origin	color	weight rough	weight cut	cut form	found in	disposition
Black Star of Queensland	Australia	asteriated	1 165	733	oval	1948	This stone, together with those of Presidents Lincoln, Washington, Eisenhower and Jefferson, were presented as a gift to the American people in 1957 by the Kazanjian Foundation of Pasadena, California, to the Smithsonian Institute, Washington, D.C.
Blue Giant of the Orient	Sri Lanka	blue	486				Owned by Catherine the Great of Russia which was last purchased by Harry Winston
Catherine the Great's		blue					Same as Stuart Sapphire
Charles II							
Duke of Devonshire		blue	100				Reportedly belonged to the Duke of Devonshire
Eisenhower	Australia	dark blue	2 097	1 444	carved bust	1948	Was carved into the bust of former US President Dwight D. Eisenhower. → Black Star Sapphire of Queensland
Félicité-Saphir of Burghe- se	India	blue	99.35				Set with other stones in a necklace
Gem of the Jungle	Myanmar	cornflower-blue	958		9 stones	1929	Purchased by Albert Ramsay cut it into nine gems weighing 66.5 to 4.33 cts.
Golden Willows	Australia	golden-yellow	322				After cutting the largest weighted 91.35 cts., known as the Golden Queen
Lincoln	Australia	dark blue	2 302	1 318	carved bust		Was carved into the bust of former US President Abraham Lincoln. See Black Star Sapphire of Queensland
Logan	Sri Lanka	dark blue	423				Set in a finger ring. Presented by John Logan to the Smithsonian Institution, Washington, D.C., USA
Madonna of the Star	Australia	black star	1 100	545	engraved Madonna		Presented to the American people as a gift by the Kazanjian Bros. Foundation, Los Angeles, California
Midnight Star		black star	116				Now on display at Morgan Collection, America Museum of Natural History, New York City
Royal Blue Star Sapphire of Venus	Sri Lanka	blue star	540				
Saint Edward's		blue			rose		Mounted with other stones in the Cross Formée on the British Imperial State Crown
Sloane		blue	31.50		rose		Hans Sloane willed it to the British Museum
Star of Artaban		blue star	316				At the Smithsonian Institution, Washington, D.C. USA
Star of Asia	Myanmar	blue star	330		6-rayed		On display at the Smithsonian Institution, Washington
Star of India	Sri Lanka	blue star	563.35				Now in the J. P. Morgan collection of the American Museum of Natural History, New York City
Stuart		blue	104				Set in the back of the British Imperial State Crown
Washington	Australia	dark blue	1 997	1 056	carved bust		Was carved into the bust of former US President George Washington. See Black Star Sapphire of Queensland

table 36: notable emeralds, aquamarines andmorganite

<b>name</b>	<b>origin</b>	<b>color</b>	<b>weight rough</b>	<b>weight cut</b>	<b>cut form</b>	<b>found in</b>	<b>disposition</b>
Anacreon Emerald		emerald	16 × 14 mm		engraved		Among Hope Collection was an of engraved an owl with a human face. Now on display at Townshed Collection of the Victorian Albert Museum, London
Atahualpa Emerald	South Africa			45 cts.	emerald		Whereabouts unknown
Alto Ligonha Beryl	Mozambique	pink and blue	200 tons				Whereabouts unknown
Benedictine Abbey	?	green	12.90 kg		rough		A present by Charlemagne, allegedly it is a fluorite, not emerald
Black Hill Beryl	USA	beryl	60 tons				Quarried from Ingersoll quarry, Black Hill, USA
Blue Aquamarine		dark blue	6 kg		rough		Now on display at American Museum of Natural History in New York, USA
Blue Aquamarine		aquamarine	737.00 cts.		?		Now on display at American Museum of Natural History in New York, USA
Blue Aquamarine		aquamarine	400.00 cts.		?		Now on display at American Museum of Natural History in New York, USA
Blue Aquamarine		aquamarine	144.51 cts.		step-cut		Now on display at American Museum of Natural History in New York, USA
British Museum	Russia	aquamarine	879.50 cts.		oval step		On display, British Museum Natural History, London
British Museum	Malagasy	morganite	598.70 cts.		antique brilliant		Now on display at British Museum Natural History, London
Buddha Emerald	?	green	?		carved		Exhibit in Chapel of the emerald Buda in the Grand Palace in Bangkok, Thailand
Bumpus Maine Beryl	USA	beryl	120 cm				Found in 1953, USA
Caplan Emerald		green	217.80 cts.				An Arabic engraved emerald of fine quality. Belong to Allan Caplan Collection, New York City, USA
Catherine the Great's	Columbian	green	136.50 cts.		rectangular		Surrounded with numerous of small diamonds in a stud. Now on display at Diamond Fund Museum in Moscow, Russia
Catherine the Great's	?	green	70–80 cts.		hexagon-cut emeralds		Surrounded with numerous of diamonds in a stud, a wedding gift from Catherine the Great of Russia to a Prussian family. Present owner is S. S. De Young of Boston, USA
Chicago Aquamarine	USA	aquamarine	137.00 cts.		cut		Now on display at Chicago field Museum of Natural History
Cortez Emerald:							Hernando Cortez, one of the Spanish Government in 16 <sup>th</sup> century in Mexico who reported in 1552 from an enormous pyramidal shaped emerald was mounted on a skull in the Hall of Justice in Texcoco used by Aztec judges. It was adorned by many gems and known as the Tribunal of God. At least possessed by Francis I, King of France

table 36: *continued*

<b>name</b>	<b>origin</b>	<b>color</b>	<b>weight rough</b>	<b>weight cut</b>	<b>cut form</b>	<b>found in</b>	<b>disposition</b>
Devonshire Emerald	Columbia	deep green	1 383.95 cts.				Presented by Dom Pedro emperor of Brazil in 1831 to the Duke of Devonshire lately Emperor of Brazil. Now in the Devonshire Collection in London
Egg-Size Emerald			?		hexagonal		A single hexagonal emerald crystal, hollowed out in form of a container and set as a pendant with gold, which is on now on display at Topkapi Museum in Istanbul, Turkey
Emerald of Texcoco							A legendary pyramidal emerald crystal from Colombia adorned with an aigrette of plumes on the top of it
Evyvan Aquamarine		greenish blue		1 999 cts.	scissors		Was presented by Evyan Perfumes, Inc. in 1963 to the Smithsonian Institution, Washington, D.C., USA
Gachala Emerald	Colombia		858 cts.				From Gachala mine, Chivor area. It was presented from Harry Winston to National Museum of Natural History in Washington, USA. Also called Harry Winston Emerald
Geological Museum Aquamarine		aquamarine	114 cts.		cabochon		An excellent cut cabochon chatoyant aquamarine of. Now on display at the Geological of London
Goddess of Emeralds							A fabulous pyramidal emerald crystal from Peru, as large as an ostrich egg, which were worshipped by American Indian natives of Manka valley. Whereabouts is unknown
Gospel Emerald	Russia				stud		Numerous green emeralds worked as stud on the enameled gold which covers a gospel. Now on display at Moscow Museum in Russia
Great Mogul Emerald		emerald	362.45 cts.				Mounted in a diamond pendant. Once belonged to an Indian Family
Holy Grail							A shallow, circular Grail or dish made of green glass (emerald?) preserved in the sacristy of the Cathedral of San Giovanni in Genoa, Italy. Also called Sacra Catina
Hooker Emerald		green		75 cts.	square step		Once set in a belt buckle of Abdul-Hamid II of Turkey. It was presented from Mrs. Stewart Hooker to National Museum of Natural History in Washington, D.C., USA
Hope Aquamarine?	Russia		341.00 cts.				Allegedly an aquamarine of Hope Collection. On display at Chicago field Museum of Natural History, USA
Hope Emerald	East Indies		172 cts.				Between Hope Collection it was a square cushion-cut emerald of light green
Hope-Persian Emerald			22 × 18 mm				Among Hope Collection. Now on display at Townshend Collection of the Victorian Albert Museum, London
Jacob's Well Emerald							A fine altarpiece in which part of scene is made from a large emerald crystal, now on display at the Kunsthistorisches Museum, Vienna, Austria
Julia Emerald			50 × 35 mm				Portrait of Julia the daughter of Roman Emperor Titus (AD 40?–81) engraved on an aquamarine of 50 × 35 mm. On display in the Cabinet des Médailles, Paris, France



table 36: continued

<b>name</b>	<b>origin</b>	<b>color</b>	<b>weight rough</b>	<b>weight cut</b>	<b>cut form</b>	<b>found in</b>	<b>disposition</b>
Laranjeiras Aquamarine			12 kg				Was exhibited in National Museum in Rio, stolen 1915, sold in 1935. Whereabouts is unknown
Laranjeiras Aquamarine	Brazil		7.87 kg				Sold in 1935. Whereabouts is unknown
Laranjeiras Aquamarine			1 285 cts.		cut		Was cut by Oscar Machado. Whereabouts is unknown
Laranjeiras Aquamarine			910 cts.				Was cut by Oscar Machado. Whereabouts is unknown
Laranjeiras Aquamarine			293 cts.				Was cut by Oscar Machado. Whereabouts is unknown
Los Angeles Aquamarine	Brazil		6 021.00 cts.		step-cut		Now on display at Los Angeles County Museum, USA
Los Angeles Aquamarine			2 594.00 cts.		cut		Now on display at Los Angeles County Museum, USA
Lucia Emerald	Brazil		61 kg				Whereabouts is unknown
Malakialina Quarry Beryl	Malagasy						A giant size beryl of 23 meters long and 1.5–2 meters in diameter, found in pegmatite of Malakialina field
Morganite	Brazil		235.00 cts.		step-cut		Now on display at American Museum of Natural History in New York, USA
Morganite	Malagasy		123.58 cts.		step-cut		Now on display at American Museum of Natural History in New York, USA
Muiane Quarry Beryl	Mozambique		2.4 meters				Beryl of 2.4 meters in diameter, found at Alto Ligonha
Maximilian Emerald			21.04 cts.		step-cut		Worn Ferdinand Maximilian Joseph, Emperor of Mexico (1864–1867). Later purchased by Mrs. Merrivether Post who presented it to National Museum of Natural History in Washington, D.C., USA
Oval Faceted Aquamarine			492 cts.		oval carved		An oval carved aquamarine bowl. Now on display at Kunsthistorisches Museum, Vienna, Austria
Patricia Emerald	Colombia	green	632		rough		Now on display in the American Museum of Natural History, New York City
Queen Jeanne d'Evreux Emerald							Queen of France, who leaved after her death 1372 crown and coronel decorated with emeralds
Roosevelt, Alice Aquamarine					heart-shaped		Was presented to daughter of President Roosevelt 1906 upon her Marriage from Vice President Taft
Roosevelt Aquamarine	Brazil		1 847.00 cts.				Was a present Government of Brazil to Franklin Roosevelt. Now on display at Roosevelt Museum, New York, USA
Russian Emerald		dark green	2 800.00 cts.				Now on display at American Museum of Natural History in New York, USA
Scepter of Harun-al-Rashid							Allegedly an emerald or beryl regal scepter belonged to Harun-al-Rashid calif of Baghdad (AD 746–809). It was carved from a single piece of emerald and was capped with a carved ruby bird
Schettler Emerald	India	green	87.64				Now on display at American Museum of Natural History, New York City

table 36: *continued*

<b>name</b>	<b>origin</b>	<b>color</b>	<b>weight rough</b>	<b>weight cut</b>	<b>cut form</b>	<b>found in</b>	<b>disposition</b>
Shah Shojia Finger-ring Emerald							In the middle of 19 <sup>th</sup> century Shah Shojia or Shuja (1780?–1842) of India presented a beautiful finger ring carved from a single emerald to the East India Company, which had the shape of a ring and the of Jahangir the Mogul Emperor of India is carved
Sinkankas Golden Beryl		golden	2 054.00 cts.		step-cut		Cut by Sinkankas. Now on display at National Museum of Natural History in Washington, D.C., USA
Sinkankas Cat's-Eye Golden Beryl	Malagasy	golden	43.50 cts.		cabochon		Cut by Sinkankas. Now on display at National Museum of Natural History in Washington, D.C., USA
Spanish Inquisition Necklace Emerald			60 cts.		Necklace		Set in a diamond necklace, now on display at National Museum of Natural History in Washington, D.C., USA
Swan-Egg Emerald							A pictorial masterpiece made by Fabergé, shows a lake made of pale aquamarine on which float a platinum swan, which are fits into an egg. Now on display at Diamond Fund Museum in Moscow, Russia. Also called Fabergé's Egg
Topkapi Cabochon Emerald		dark green to black		16300.00 cts.	flattish cabochon		Now on display at Topkapi Museum in Istanbul, Turkey
Topkapi Hemisphere Emerald	Columbia	green		6550.00 cts.			A dark emerald (it appeared black), carved as a hemisphere of. Now on display at Topkapi Museum in Istanbul, Turkey
Tribunal of God Emerald							At least possessed by Francis I, King of France
Tsar Alexander II Emerald		dark green		107.00 cts.			Allegedly belonged to Tsar Alexander II of Russia. Recently sold to Cartier of New York
Unnamed Aquamarine				1 000.00 cts.	step-cut		Now on display at National Museum of Natural History in Washington, D.C., USA
Unnamed Aquamarine	Brazil	pink		911.00 cts.			Now on display at National Museum of Natural History in Washington, D.C., USA
Unnamed Aquamarine	Russia			263.50 cts.	scissors step-cut		Now on display at National Museum of Natural History in Washington, D.C., USA
Unnamed Morganite	Brazil			235.50 cts.			Now on display at National Museum of Natural History in Washington, D.C., USA
Unnamed Emerald				175.50 cts.	oval brilliant		Now on display at National Museum of Natural History in Washington, D.C., USA
Unnamed Morganite	California			122.20 cts.	step-cut		Now on display at National Museum of Natural History in Washington, D.C., USA
Unnamed Emerald	Colombia			117.00 cts.	oval cabochon		Now on display at National Museum of Natural History in Washington, D.C., USA
Unnamed Morganite	California			113.00 cts.	step-cut		Now on display at National Museum of Natural History in Washington, D.C., USA

table 37: notable opals

name	origin	color	weight rough	weight cut	cut form	found in	disposition
Andamooka	Australia	fine fire	850	203	oval cabochon	1949	Presented to Queen Elizabeth II of England in 1954. Mounted in a necklet
Aztec Eagle							Same as El Aguila Aztec Opal
Butterfly							Same as Red Admiral Opal
El Aguila Azteca		fine fire	32		carved		Carved with the head of Mexican sun god. Once in Hope collection and now in Museum of Natural History, New York, USA
Flame Queen	Australia	black	253			1918	Black with red center. Owned by Milwaukee chemist
Grubstake		fine					An opal pseudomorphous after wood. Exhibited in American Museum of Natural History in New York
Harlequin, Prince		fine black	215.85				An opal of harlequin clan. Exhibits by American Museum of Natural History, New York City
Hope							Same as El Aguila Azteca opal
Hungarian Opal, the	Hungary		2409.75		pear		Was mounted in a gold pendant. Now on display in the Schatzkammer of the Hofburg, Vienna, Austria
King Midas	Australia	fine quality					Owned by Czar Nicholas II of Russia believed to be now at the St. Petersburg (Leningrad) Museum
Light of the World	Australia	black	2268	252	convex topped	1928	Play of color of stone is red with less of gold and green
Noolinga Nera	Australia			205	oval		
Olympic	Australia		18002.25		rough		
Pandora Star	Australia	white	711	590			A fossilized bone of a plesiosaurs. Was sold in the USA. Also called Pandora Opal
Pride of Australia	Australia	black	225.75			1915	With green play of color and lesser amounts of orange. Also called Red Emperor
Red Admiral	Australia	black	40 to 50			1920	The red color resembles that of the wing of a British butterfly. Present whereabouts unknown
Roebling	USA		2610				Owned by Roebling who later presented it to the Smithsonian Institution, Washington, D.C., USA
Roebling Black	USA	black	355.19		rough		Owned by Roebling who later presented it to the Smithsonian Institution, Washington, D.C., USA
Southern Cross	Australia						Was owned by Khedive of Egypt
Star of Australia	Australia						Purchased by Percy Marks of Sydney, USA

table 38: notable pearls

<b>name</b>	<b>origin</b>	<b>color</b>	<b>weight</b>	<b>form</b>	<b>found in</b>	<b>disposition</b>
Abermethy Pearl	freshwater	hint of lilac	43.6		Scotland	Now on display at the establishment of Cairncross in Perth, Scotland. It was known as Bill's Pearl
Charles II	America?				1691	Presented to Charles II, of Spain. Were worn as earrings by the Queen of Spain
Cleopatra						Reportedly two pearls worn as earrings by Cleopatra
Great Southern Cross	Australia				1886	Consists of nine large pearls, naturally united in the form of a cross. Now in the possession of the Vatican
Hope		white green	450	cylindrical		Once in the Hope collection. It is believed that it may have been one of the French Crown jewels
La Peregrina	Panama Gulf		134	pear-shaped	ca. 1560	Presented to Philip II of Spain in 1560. Bought by Richard Burton for his wife Elizabeth Taylor in 1969
La Pellegrina	India	silvery	111.5	rounded		Brought 18 <sup>th</sup> century by Zozima, Moscow, Russia
La Régente			27.50	round		Was stolen in the robbery among other French Crown Jewels in 1792
La Reins de	India		28	round		Was stolen in the robbery among other French Crown Jewels in 1792
Mancini			100	2 drop-shape		Presented by Charles I, to Queen Henrietta Maria of England. She sold it to Louis XIV, and he donated to Maria Mancini, the niece of Cardinal Mazarin. Was merchandised by Christie's of New York in 1979
Orange Pearls, The				3 strings		Inherited by King Frederick I of Prussia in 1703
Oviedo	Panama Gulf		26			Believed to be the same as the Morales or Pizarro pearl and to have been among the Austrian Crown Jewels
Pearl of Asia			605	baroque		Belonged to the Emperor of China in the 16 <sup>th</sup> century. Was bought by the Foreign Missions of Paris in 1918
Queen Elizabeth				4 drop-shape		Belonged to Queen Elizabeth of England
Queen		pinkish	23.25		1857	Sold to Tiffany & Co. Later sold to Empress Eugénie. Now on display at the University of Pennsylvania
Southern Cross Pearls						Same as Great Southern Cross Pearls
Thiers Pearl Necklace			22.8	Three row		A necklace of 145 pearls owned by the wife of President of France, was bequeathed to the Louvre Museum, Paris
Wilhelmina Pearl, also called Little Willie	freshwater		22.8		Scotland	Now on display at the establishment of Cairncross in Perth, Scotland. It was known as Bill's
Yousoupoff	India		120		ca. 1620?	Sold in 1620. Was later owned by Philip IV of Spain. Last bought by Yousoupoff, a Russian Princess

table 39: other notable stones

name	origin	color	weight rough	weight cut	cut form	found in	disposition
Black Prince Spinel			polished 170?				Erroneously known as Black Prince Ruby. Set in the front of the British Imperial State Crown
Eacret Benitoite		flawless	7.6				First purchaser was named Godfrey Eacret. Now exhibits in US National Museum, Washington, USA
Kandy Chrysoberyl Cat's-eye				313.50			Belonged to King of Kandy of Sri Lanka (Ceylon). When conquered by the British in 1815 was presented to Queen Victoria in 1886
Lilas Amethyst	Brazil	violet	470				Named after first lady of the town Governador Valadares
Maharani Chrysoberyl Cat's-eye	Sri Lanka?	green	58				Now on display at the Smithsonian Institution, Washington, D.C., USA
Midnight Blue Tanzanite		blue	122.70				Now on display at the Smithsonian Institution, Washington, D.C., USA

table 40: notable topaz, rough and cut

name	origin	color	weight	form	found in	disposition
Adiel	Brazil	dark-blue, irradial	4 kg	7.8 kg	1987	Sold to an unknown Japanese
American Golden		Light-yellow	4.58 kg	11.8 kg	1970?	Now on display at Smithsonian Museum, USA
Aurangzib	India?	?	157.25 cts.	cut	1631–68	Shah-Jahan, India. Present whereabouts unknown
Balboa	Brazil	medium-blue	4 500 cts., pear-shaped	10 725 cts	1978	Now on display at Sa Diego Museum, USA
Braganza	Brazil	colorless	1 640 cts.	drilled for suspend	1740–1797?	Regent of Portugal Diamond. Erroneously was called Braganza diamond. Present whereabouts unknown
Brazilian Princess	Brazil	light-blue	4.20 kg	35 kg	?	Now on display in American Museum of Natural History, New York, USA
Brazilian Princess	Brazil	light-blue	6.93 kg	carved	?	Cut from remaining of Brazilian Princess
Brown Derby	USA	?	300 kg	rough	1972	Unknown
Champagne Topaz	?	champagne	7.37kg	?	?	Now on display at Los Angeles County Museum, USA
Deleff Collection	Brazil	pale blue	250 kg	rough	1987	Natural History Museum, Paris, France
Deleff Collection	Brazil	pale blue	200 kg	rough	1987	Natural History Museum, Paris, France
Deleff Collection, from	Brazil	?	117 kg	rough	1987	Natural History Museum, Vienna, Austria
Denver, Dali topaz	Brazil	champagne	2.12 kg	brilliant		It was owned by Salvador Dali. Now on display at Denver Museum, USA, since 1978
Idar-Oberstein	Brazil	champagne	5 kg	navette, 9 600 ct.		Unknown
imperial topaz	Brazil	cherry	129 cts.	?	?	Now on display at Smithsonian Museum, USA
imperial topaz	Brazil	cherry	2 kg	?	?	Now on display at National Museum, Rio Janeiro
imperial topaz	Brazil	cherry	218 g	?	1832	Now on display at National History Museum, London
imperial topaz	Brazil	cherry	93.6 cts.	?	?	Now on display at Smithsonian Museum, USA
imperial topaz	Brazil	orange	41.4 cts.	?	?	Now on display at Smithsonian Museum, USA
Londonderry	Australia	light blue	3 700 kg	rough	1902?	Unknown
Maxwell Stuart	Sri Lanka	bluish-white	368.98 cts.	cut	1870?	Present whereabouts unknown
Minas Gerais	Brazil	light green?	271 kg	rough	1943	American Museum of Natural History, New York, USA
Morgentau	Brazil	blue	1 463 cts.	egg-shaped	1920?	American Museum of Natural History, New York, USA obtained 1920
pink topaz	Russia, CIS	crimson	79 cts.	rough	?	Belonged to a private collection
pink topaz	Russia?	dark-pink to red	200 cts.	32 facets	?	Unknown
pink topaz	Brazil	pink	71 cts.	?	?	Now on display at Smithsonian Museum, USA
pink topaz	Brazil	pink	46 cts.	?	?	Now on display at Smithsonian Museum, USA
pink topaz	Brazil	pink	43 cts.	?	?	Now on display at Smithsonian Museum, USA

table 40: *continued*

name	origin	color	weight	form	found in	disposition
pink topaz	Brazil	pink	43 cts.	?	?	Now on display at Smithsonian Museum, USA
pink topaz	Brazil	deep pink	34 cts.	?	?	Now on display at Smithsonian Museum, USA
pink topaz	Brazil	pink	33,46 cts.	?	?	Now on display at Geological Museum, London
Pope Leo	Brazil		1.8 kg	cut	1902	It was a present to Pope Leo
Ribaute-Alto Ligonía	Mozambique	?	100 kg	rough	1951–53	Unknown
Royal Ontario Museum	?	?	3 000 cts.	cut	?	Now on display at Royal Ontario Museum, Canada
Sao Domingos	Brazil	blue	350.000 kg	rough	1944–48	Reference, non-gem quality
Smithsonian	Brazil	green	2.4 kg	cut		Now on display at Smithsonian Museum, USA
Smithsonian	Brazil	yellow	7 725 cts.	step-cut oval		Now on display at Smithsonian Museum, USA, since 1974
Smithsonian	?	yellow-green	1 469 cts.	oval-cushi.	?	Now on display at Smithsonian Museum, USA
unnamed	?	?	2 677 kg	rough	1981?	Unknown
unnamed	?	?	151 kg	rough	?	Museo di Mineralogia e Litologia of Uni. of Florence
unnamed	?	?	1.1 kg	cut?	?	Belonged to Pope Pius IX, 1910 sold to Brazilian Government. Present whereabouts unknown
unnamed	?	bluish-white	819 cts.	cut	1870?	Cut similar to Regent Diamond.
unnamed	USA	champagne	36 853 cts.	cut	1989?	Unknown
US National Museum	Brazil	light-blue	3 273 cts.	cut 1960?	?	Cut by Sinkankas. In US National Museum
Volyn, Ukraine	Russia, GIs		117 kg	rough		Unknown
Zimmermann, engraver	Brazil	blue	2.75 kg	chameleon		Rough 4 kg. Cut in Idar-Oberstein, Germany

table 41: notable tourmaline, rough and cut

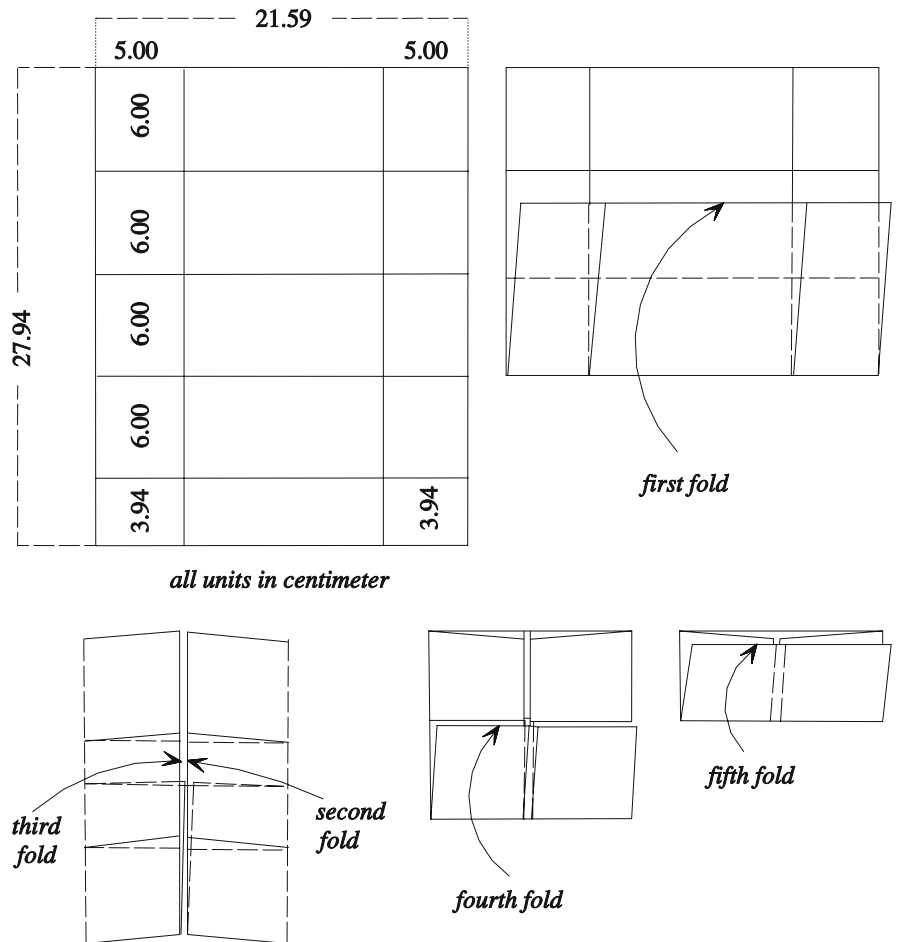
<b>name</b>	<b>origin</b>	<b>color</b>	<b>weight</b>	<b>form</b>	<b>found in</b>	<b>disposition</b>
Candelabra	USA	red, white and blue	25×23×15 cm	rough	?	Color-zoned elbaite together with albite, quartz and lepidolite
Carving-Engraved	USA	blue	6.5 cm	carved	?	Gerhard Becker, Idar-Oberstein, Germany
Color-Zoned	USA	color-zoned	20×12.7×12.7 cm	rough	?	Color-zoned elbaite together with albite and quartz
cross-section	Afghanistan	pale-red	30 cm long	rough	1979?	Present whereabouts unknown. Afghanistan?
Cross-Shaped	?	different colors	6.3 cm pendant	cut stones	?	Alexander Blythe Collection, California, USA
doubly terminated elbaite floaters	Brazil	pale-red	1 m long	rough	1982?	Present whereabouts unknown
dravite	Australia	brown	11.5 kg	rough	1977?	Present whereabouts unknown
Fogete (rocket)	Brazil	pale-red	320 kg	rough	1978?	Present whereabouts unknown
Grape-Shaped	?	red	255 cts.	pendant		A present by Gustav III of Sweden to Catherine II of Russia in 1777
Crude Rosette	USA	black	2.2 m diameter	rough	?	San Diego County, California
Crude Rosette	USA	black	1.5 m × 7.5 cm	rough	1951–1953?	San Diego County, California
Hamlin Necklace	?	green, yellow, black, blue, red	?		<	A necklace of 17 large color tourmalines. Now on display at the Harvard Museum, USA
Huge Tourmaline Crystal	USA	black	ca. 8 kg	rough	1942?	Present whereabouts unknown
Jolly Green Giant, the	USA	green	27 × 10 cm	rough	1975?	Present whereabouts unknown
Joninha	Brazil	cranberry-purple	ca. 45 cm	rough	?	Sold to an American
Mount Mica crystal	?	blue-green	50.59	heart		Heart-shaped, fashioned in Mount Mica crystal
Rozek		rose	25 cts.	step-cut		Octagon step-cut, , fashioned in Mount Mica crystal
State of Maine Necklace	Newry, USA				1971	Presented by Maine Retail Jewelers Assoc to State 1972
Steamboat	USA	red and green				Color-zoned elbaite together with albite and quartz
Termier	Malagasy	pale-red	20 × 13 cm	rough	1908	Present whereabouts unknown
Termier	Malagasy	pale-red	38 × 9 cm	rough	1983?	Present whereabouts unknown
?	USA	dark pink	509 cts.	cut	?	?
?	Brazil	green elbaite	ca. 15 cm		?	Keith Proctor Collection, Springs, Colorado, USA
?	Brazil	blue elbaite	ca. 10 cm		?	Keith Proctor Collection, Springs, Colorado, USA
?	Brazil	orange, golden yellow and green	ca. 12.5 cm long	rough	?	Keith Proctor Collection, Springs, Colorado, USA
?	USA	pink elbaite	20 × 21.5 × 16.5 cm	rough	?	May be in American Museum of Natural History, New York, USA

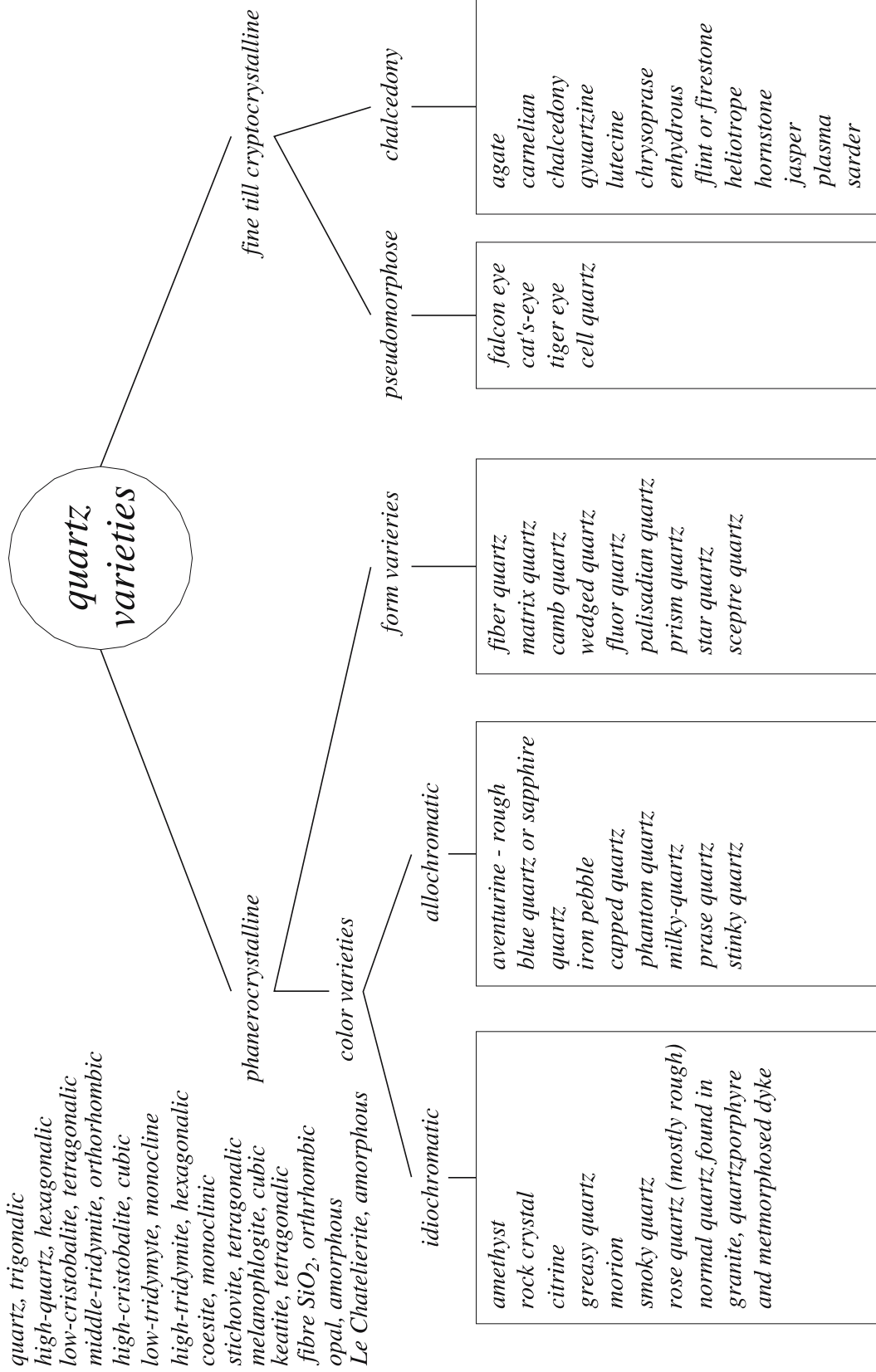


table 42: an alternate birthstones

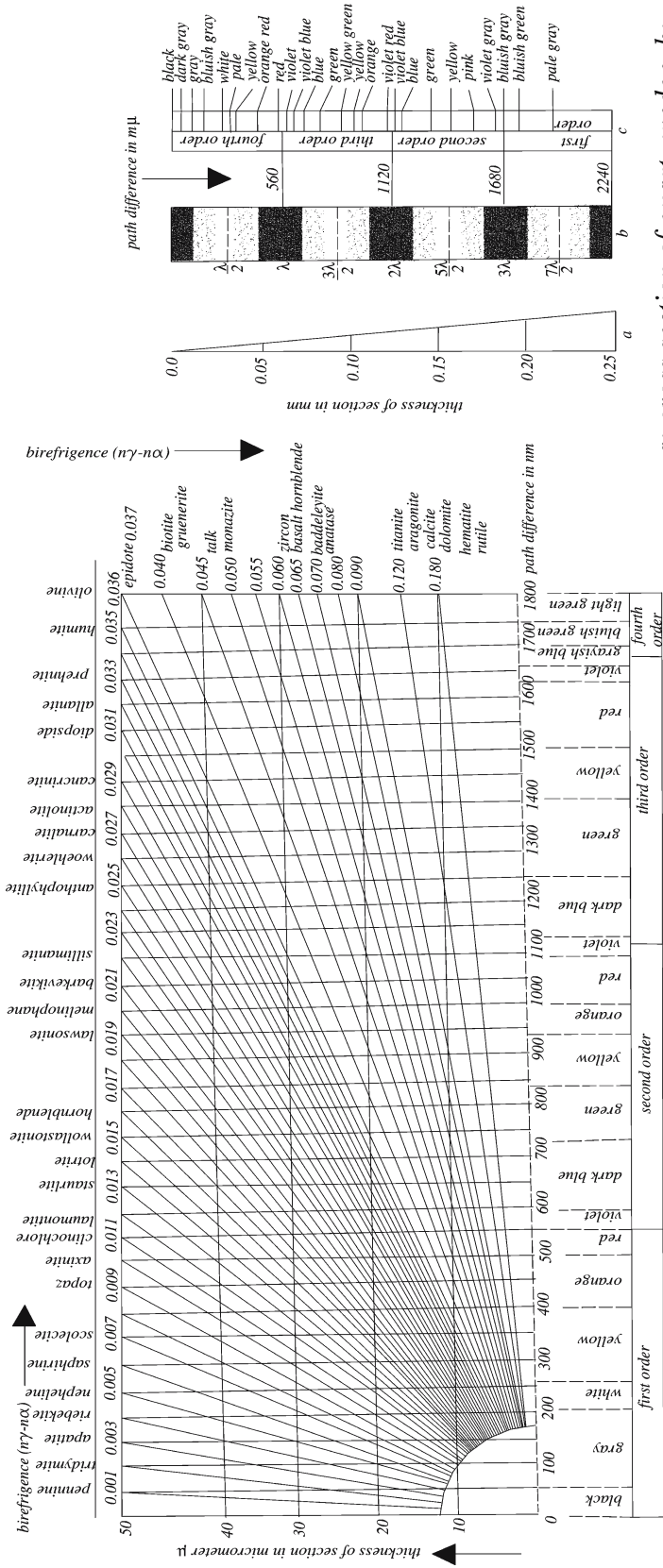
month	color	stone
January	deep red	garnet
February	purple	amethyst
March	light blue	aquamarine, bloodstone
April	white, transparent	diamond, rock crystal
May	bright green	emerald, chrysoprase
June	cream	pearl, moonstone
July	red	ruby, carnelian or onyx
August	light green	peridot, sardonyx
September	dark blue	sapphire, lapis lazuli
October	variegated	opal, tourmaline
November	yellow	topaz, citrine
December	sky-blue	turquoise or zircon

*folding sequence for making stone paper. After Road 1997*





SiO<sub>2</sub> modification and quartz varieties. After Rösler 1981



a: cross section of quartz wedge, b: monochromatic light  $\lambda=560$  nm and c: colors in four orders of white light

Michel-Lévy chart showing the relation of interference colors to thickness and birefringence of other minerals

Michel-Lévy chart and quartz wedge showing the relation of interference colors to thickness of quartz and birefringence colors

# Bibliography

- Agricola D (1955) *De Natura fossilium*. Translation by Bandy MC, Band JA, Geological Society of America
- Allaby A, Allaby M (1991) *Concise Oxford dictionary of Earth sciences*. Oxford University, Oxford
- American Civil Engineers (1958) *Glossary of terms and definitions in soil mechanics*. Proceedings, Vol. 84. October 1958
- American Institute of Mining, Metallurgical, and Petroleum Engineers (1960) *Industrial minerals and rocks*, 3<sup>rd</sup> ed. New York
- Amstutz GG (1971) *Glossary of mining geology*. Enke Verlag, Stuttgart
- Anderson BW (1990) *Gem testing*, 10<sup>th</sup> ed. Butterworth-Heinemann, Oxford
- Arem JE (1992) *Color encyclopedia of gemstones*, 2<sup>nd</sup> ed. Geoscience Press, Tuscon
- Arem JE (1992) *Gems and jewelry*, 2<sup>nd</sup> ed. Geoscience Press, Tuscon
- Balfour I (1992) *Famous diamonds*, 2<sup>nd</sup> ed. N.A.G. Press, Colchester
- Ball SH (1922) The geologic and geographic occurrence of precious stones. *Economic Geology* 17:575–601
- Ball SH (1931) Historical notes on gem mining. *Economic Geology* 26:681–738
- Ball SH (1935) A historical study of precious stone valuation. *Economic Geology* 30:630–642
- Ball SH (1950) A roman book on precious stones. Gemological Institute of America, Los Angeles
- Bank H (1973) *From the world of gemstones*. Pinguin, Innsbruck
- Barth TFW (1969) *Feldspars*. Wiley-Interscience, New York
- Bauer M (1968) *Edelsteinkunde*. Tauchnitz Verlag, Leipzig, 1909. Tranlated in English by Spencer LJ: *Precious Stones*. Dover Publ., New York, 1968
- Bayliss P (2000) *Glossary of obsolete mineral names*. The Mineralogical Record Inc, Tuuson
- Bennett H (1962) *Concise chemical and technical dictionary*, 2<sup>nd</sup> ed. Chemical Publ., New York
- Betekhtin AG (1956) *A course of mineralogy*. Peace Publ., Moscow
- Biruni Al (1989) *The book most comprehensive in knowledge on precious stones*. Islamabad, Pakistan
- Blankenburg HJ (1973) *Der Rohstoff Asbest und seine Verwendung*. VEB Dt. Verlag, Leipzig
- Boot, Anselmus de (1636) *Gemmarum et lapidum historia*. Lug. Bat.
- Brantly JE (1961) *A general glossary of mud drilling terms*, 6<sup>th</sup> ed. From Rotary Handbook, Palmer Publications New York
- Bruton E (1978) *Diamonds*. Chilton Book, Pennsylvania
- Budge EAW (1978) *Amulet and superstitions*. Dover Publ., New York
- Caley ER, Richards JFC (1956) *Theophrastus on stones*. Columbus, Ohio State University
- Challinor J (1967) *A dictionary of geology*. Cardiff University of Wales Press
- Chamber's Geological Dictionary. Chamber's, London
- Chamber's Mineralogical Dictionary (1966) Chamber's, London
- Chamber's Technical Dictionary, 3<sup>rd</sup> ed. (1958) Macmillan, New York
- Chudoba KF, Gübelin CG (1974) *Edelsteinkundliches Handbuch*, 3<sup>rd</sup> ed. Stollfuss Verlag, Bonn
- Clark AM (1993) *Hey's mineral index*, 3<sup>rd</sup> ed. Chapman & Hall, London
- Cody A (1991) *Australian precious opal; A guide book for professionals*. Cody, Melbourne
- Coes L (1971) *Abrasive; Aplied mineralogy*. Springer-Verlag, New York
- Collins English Dictionary (1979) Collins, London
- Considine GD (ed) (1984) *Van Nostrand's encyclopedia of chemistry*. Wiley, New York
- Cunningham S (1996) *Encyclopedia of crystal, gem and metal magic*. Llewellyn Publ., St. Paul, Minnesota
- Dake HC, Fleener FL, Wilson BH (1938) *Quartz family minerals*. Whittlesey, New York
- David JH, van Hulle (1990) *Michael's gemstone dictionary*. J. P. Michael's Education Foundation, Orinda, CA
- Davies G (1984) *Diamond*. Hilger, Bristol
- Deer W A, Howie RA, Zussman J (1992) *An introduction to rock forming minerals*. Longmans, London
- Deeson AFL (1973) *The collector's encyclopedia of rock and minerals*. David & Charles, Newton Abbot
- Desautels PE (1971) *The gem kingdom*. Ridge Press, New York
- Desautels PE (1986) *The jade kingdom*. Van Nostrand Reinhold, New York
- Dickinson JY (1965) *The book of diamonds*. Avenel Books, New York
- Dietrich R (1985) *The tourmaline group*. Van Nostrand Reinhold, New York
- Dodd AE (1964) *Dictionary of ceramics; Pottery, glass, vitreous enamels, refractors, clay building materials, cement and concrete, electro-ceramics, special ceramics*. Philosophical Library, New York
- Downing PB (1992) *Opal identification and value*. Majestic Press, Tallahassee

- Dubin LS (1987) The history of beads. Abrams Press, New York
- Elwell D (1979) Man-made gemstones. Horwood Press, New York
- Embrey PG, Fuller JP (1987) A manual of new mineral names. 1892–1978. British Museum, Natural History, Oxford University Press, New York
- English GL (1939) Descriptive list of the new minerals, 1892–1938. Mac-Graw-Hill, New York
- Eppler WF (1984) Praktische Gemmologie, 2<sup>nd</sup> Aufl. Rühle-Diebener Verlag, Stuttgart
- Evans JA (1989) A history of jewellery, 2<sup>nd</sup> ed. Faber & Faber, London
- Eyles WC (1964) The book of opals. Charles Tuttle, Rutland
- Farn AE (1986) Pearls; Natural, cultured and imitation. Butterworths, London
- Farrington OC (1923) Amber; Its physical properties and geological occurrence. Mumford, Chicago
- Farrington OC (1929) Famous diamonds. Field Museum of Natural History, Chicago
- Farrington OC, Laufer E (1927) Agate; Physical properties and origin. Field Museum of Natural History, Chicago
- Fay AH (1920) A glossary of the mining and mineral industry. Bureau of Mines Bull. 95, Washington
- Federman D, Hammid T (1989) Modern jewelry consumer guide to colored gemstones. Van Nostrand Reinhold, New York
- Firsoff VA (1974) Working with gemstones. David & Charles, Newton Abbot
- Fischer W (1953) Praktische Edelsteinkunde. Feller-Nottuln Verlag, Kettwig
- Fischer K (1989) Edelsteinbearbeitung, 2<sup>nd</sup> Aufl. Rühle-Diebener Verlag, Stuttgart
- Fleischer M, Mandarino J (1991) Glossary of mineral species. The Mineralogical Record, Tuscon
- Frank-Kameneckij VA (1987) Perioda strukturnych primesej v mineralach
- Fraquet H (1987) Amber. Butterworths, London
- Frye K (1981) Encyclopedia of mineralogy. Hutchinson Ross Publ., Stroudsburg, Pennsylvania
- Gary M, McAfee R, Wolf CL (eds) (1972) Glossary of geology. American Geological Institute, Washington, D.C.
- Geerts AJC (1878/1883) Les Produits de la Nature Japonaise et Chinoise, 2 Vols. Yokohama; Lévy, C. 1878; Levy L, Salabelle S 1883
- Gemological Institute of America (1989) The GIA jewellers' manual, 3<sup>rd</sup> ed. Santa Monica
- Gienger M (1997) Lexikon der Heilsteine, 2<sup>nd</sup> ed. Osterholz Verlag, Tübingen
- Goldschmidt V (1919) Atlas der Krystallformen. Heiderberg
- Goldschmidt VM (1954) Geochemistry. Clarendon Press, Oxford
- Gribble CD, Hall AJ (1992) Optical mineralogy. Chapman & Hall, New York
- Grim RE (1962) Applied clay mineralogy. McGraw Hill, London
- Grim RE (1968) Clay mineralogy. McGraw Hill, London
- Gübelin E (1968) Die Edelsteine der Insel Ceylon. Gübelin, Luzern
- Gübelin E (1979) Internal world of gemstones. Butterworth-Heinemann, Oxford
- Gunn J (1971) An opal terminology. University of Sydney
- Günter B (1981) Tables of gemstone identification. Lenzen Verlag, Kirchweiler
- Hall NCE (1963) Dictionary of metal finishing chemicals. Metals and Plastics Publ., New York
- Halway GG (1981) The condensed chemical dictionary. Van Nostrand Reinhold, New York
- Ham HR (1965) Dictionary of civil engineering. George Newness, London
- Hey MH, Clark AM (1993) Hey's mineral index, minerals species, varieties and synonym, 3<sup>rd</sup> ed. Chapman & Hall, London
- Hochleitner R (1981) Fotoatlas der Mineralien und Gesteine. Graefe und Unzer, Muenchen
- Holden A, Morrison P (1982) Crystals and crystal growing. The MIT Press, Cambridge
- Holmes A (1971) The nomenclature of petrology, 2<sup>nd</sup> ed. Hafner Publ., New York
- Hoover RW (1992) Topaz. Butterworth-Heinemann, London
- Hughes RW (1990) Corundum. Butterworth-Heinemann, Oxford
- Hurlbut CS, Kammerling RC (1991) Gemology, 2<sup>nd</sup> ed. Wiley, New York
- Johannsen A (1939) A descriptive petrography of the igneous rocks, 2<sup>nd</sup> ed. University Press of Chicago
- Keferstein C (1849) Mineralogia polyglotta. Eduard Anton, Halle
- Keller P (1990) Gemstones and their origin. Van Nostrand Reinhold, New York
- Keverne R (1991) Jade. Butterworths, London
- Khazini, -Al (1968) Mizan-al hakama (precise balance). Translated in Farsi, Boniad-Farhang, Tehran
- King CW (1865) The natural history, ancient and modern, of precious stones and gems, and of the precious metals. Bell and Daldy, London
- King CW (1866) Antique gems. Their origin, uses, and value. Murray, London
- King CW (1885) Handbook of engraved gems. Bell, London
- Kirk-Othmer (1985) Concise encyclopedia of chemical technology. Wiley, New York
- Kittel C (1971) Introduction to solid state physics, 4<sup>th</sup> ed. Wiley, New York
- Kleine C, Hurlbut CS (1985) Manual of mineralogy, 20<sup>th</sup> ed. Wiley, New York
- Klockmann F, Ramdohr P, Strunz H (1980) Lehrbuch der Mineralogie, 16<sup>th</sup> ed. Enke Verlag, Stuttgart
- Knerr R (1999) Goldmann Lexikon Physik. Bertelsmann Lexikographisches Institut, Gütersloh
- Koivula J, Gübelin E (1992) Photoatlas of inclusions in gemstones, 2<sup>nd</sup> ed. ABC Edition, Zurich
- Krause PD (1987) Introduction to lapidary. Chilton, Randor, Pennsylvania
- Krause EHF, Slawson CB (1947) Gems and gem materials, 5<sup>th</sup> ed. Mc-Graw-Hill, New York
- Kukal Z, Malina J, Maliniva R, Tesarova H (1989) Man and stone. Geological Survey, Prague
- Kunz GF (1913) The curious lore of precious stones. Lippincott, Philadelphia, PA
- Kunz GF (1968) Gems and precious stones of North America. Dover Publ., New York
- Kunz GF (1989) Gems lore of precious stones. Reprint by Dover Publ., New York
- Kunz GF, Stevenson CH (1993) The book of the pearl. Reprint by Dover Publ., New York
- Kunze G (1956) Z Krist 108:82–107

- Lamprecht H-O, Kind-Barkaukas F, Wolf H (1990) Beton-Lexikon. Beton-Verlag, Duesseldorf
- Laufer B (1907) Historical jottings on amber in Asia. *Memories of the American Anthropological Association* 1, 3, Lancaster
- Laufer B (1912) Jade. A study in Chinese archaeology and religion. *Field Museum of Natural History, Anthropological Publication* 154, Series vol. 10. Chicago
- Laufer B (1919) Sino-Iranica, Chinese contributions in the history of civilization in ancient Iran. *Field Museum of Natural History, Anthropological Publication* 201, Series vol. 15, no. 3. pp 185–630, Chicago
- Laufer B (1927) Archaic Chinese jades collection in China by Bahr, A.W. Now in *Field Museum of Natural History Chicago*. Lakeside Press, Chicago
- Lenzen G (1970) The history of diamond production and the diamond trade. Barrie & Jenkins, London
- Lenzen G (1983) Diamonds and diamond grading. Butterworth-Heinemann, London
- Leutwein F, Sommer-Kulaszewski C (1960) *Allgemeine Mineralogie*. Bergakademie Freiberg, Freiberg
- Liban F, Mitchel L (1980) Cloisonné enameling and jewelry making. Dover Publ., New York
- Liddicoat RT (ed) (1977) *Diamond dictionary*, 3<sup>rd</sup> ed. Gemological Institute of America, Santa Monica
- Liddicoat RT (1989) *Handbook of gem identification*, 12<sup>th</sup> ed. Gemological Institute of America, Santa Monica
- Long AE (1960) A glossary of the diamond-drilling industry. *Bureau of Mines Bull.* 583
- MacKenzie WS, Guilford C (1980) *Atlas of rock-forming minerals in thin section*. Longman Publ., Essex
- Magnus A (1967) *Book of minerals*. Translation by Wyckoff D, Oxford University Press, Oxford
- Manutchehr-Danai M (1973) *Mineralogy, Vol. 1, Non-silicates in Persian and English*. University Press, Meshed
- Manutchehr-Danai M (1974) *Mineralogy, Vol. 2, Silicates in Persian and English*. University Press, Meshed
- Manutchehr-Danai M (1975) *An introduction to crystal chemistry in Persian and English*. University Press, Meshed
- Manutchehr-Danai M (1976) Zur Geologie und Mineralogie der Türkislagerstätte Baghu (Nord Iran). *Z Dt Gemmol Ges* 25:15–22
- Manutchehr-Danai M (1977) On the turquoise deposits of Nishabur (NE Iran). *Gems Gemology* 15(10):315–317
- Manutchehr-Danai M (1981) Faustite in der Lagerstätten von Neyschabour (Iran) im Zusammenhang mit der Frage der Türkisbildung. *Z Dt Gemmol Ges* 30:95–97
- Manutchehr-Danai M (1997) *Dictionary of gems and gemmology. English-Persian-English*, Tehran
- Manutchehr-Danai M, Philipsborn H v. (1982) Röntgenographische Untersuchungen von Chromiterzen. Poster in Marburg, 5–10 Sept., *Z Dt Min Ges, Seminar*
- Manutchehr-Danai M, Langheinrich G, Lammerer B (1981a) Structural section through the Binalud-Mountain (Iran). A Preliminary Report, Bonn
- Manutchehr-Danai M, Langheinrich G, Lammerer B (1981b) Zur Geologie des Binalud Gebirges (NE Iran). Report in Neustadt Wstr. (DFG Report)
- Manutchehr-Danai M, Langheinrich G, Lammerer B (1982) Zur Geologie des Binalud Gebirges (NE Iran). Report in Würzburg Feb., Report der Geologischen Vereinigung
- Manutchehr-Danai M, Langheinrich G, Lammerer B (1983) The tectonic evolution in the Binalud Mountain (NE Iran), geodynamic project (Geotraverse) in Iran. *Geol. Surv. of Iran, Tehran, Report no. 51*, pp 91–102
- Manutchehr-Danai M, Langheinrich G, Lammerer B (1984) *Geological Investigation in the Binalud Mountain (NE Iran)*. N Jb Geol Paläont Abh 168(2/3):269–277
- Maryon H (1971) *Metalwork and enamelling*, 5<sup>th</sup> ed. Dover Publ., New York
- Matlins AL (1996) *The pearl book; The definitive buying guide*. Woodstock, Vermont
- Matlins AL, Bonanno AC (1989) *Gem identification made easy*. Gemstone Press, Woodstock
- McGraw-Hill (1978a) *Concise encyclopedia of geological sciences*. McGraw-Hill, New York
- McGraw-Hill (1978b) *Encyclopedia of geological sciences*. Edited by Lapedes ND, McGraw-Hill, New York
- McGraw-Hill (1985) *Dictionary of physics*. McGraw-Hill, New York
- McGraw-Hill (1986a) *Dictionary of biology*. McGraw-Hill, New York
- McGraw-Hill (1986b) *Dictionary of chemical terms*. McGraw-Hill, New York
- McGraw-Hill (1986c) *Dictionary of earth sciences*. By Parker SP, McGraw-Hill, New York
- McGraw-Hill (2005) *Concise encyclopedia of science and Technology*, 5<sup>th</sup> ed. McGraw-Hill, New York
- McNeil M (1991) *Earth sciences reference*. Flamingo Press, Lake San Marco
- McNeil DS (1976) *Jewelers' dictionary*, 3<sup>rd</sup> ed. Randor, Pennsylvania
- Meen VB, Tushingam AD (1968) *Crown jewels of Iran*. University of Toronto Press, Toronto
- Miller AM (1991) *Cameos old and new*. Chapman & Hall, New York
- Miller AM (1993) *Gems and jewelry appraising; Techniques of professional practice*. Chapman & Hall, New York
- Miller AM, Sinkankas J (1993) *Standard catalog of gem values*, 2<sup>nd</sup> ed. Geoscience Press, Tuscon
- Mitchel RS (1979) *Mineral names; What do they Mean?* Van Nostrand Reinhold, New York
- Moldes R (1993) *Diccionario de Minerales, Gemas y Gemología*. International Press, Miami
- Morris C (ed) (1992) *Dictionary of science and technology*. Academic Press, San Diego
- Muller H (1987) *Jet*. Butterworths, London
- Nassau K (1980) *Gems made by man*. Randor, Chilton, Pennsylvania
- Nassau K (1983) *The physics and chemistry of color*. Wiley, New York
- Nassau K (1984) *Gemstone enhancement*. Butterworths, London
- New Standard Dictionary of the English Language* (1964) New York
- New Webster Dictionary of the English Language* (1965) New Jersey
- Newman H (1977) *An illustrated dictionary of glass*. Thames & Hudson, London
- Newman H (1981) *An illustrated dictionary of jewelry*. Thames & Hudson, London

- Novák M, Pfeiferová A (1991) World of minerals. The mineral wealth of Moravia and Silesia. The Moravian Museum Discovery Series Vol. 2
- O'Donoghue M (1987a) Quartz. Butterworths, London
- O'Donoghue M (1987b) The literature of mineralogy. The British Library, London
- O'Donoghue M (1988) Gemstones. Chapman & Hall, London
- Oelschagel H (1939) Dictionaire technique des Métaux Précieux des Pierres Fines. Mouton & Co., The Hague
- Osborne AK (1957) An encyclopedia of iron and steel industry. Philosophical Library, New York
- Pagel-Thiesen V (1993) Handbook for diamond grading, 11<sup>th</sup> ed. Pagel-Thiesen Verlag, Frankfurt
- Pagel-Thiesen V (2000) Diamant-Fibel, 9. Aufl. Pagel-Thiesen Verlag, Hirschberg
- Palache C, Berman H, Frondel C (1944) Dana's system of mineralogy, Vol. 1. Wiley, New York
- Palache C, Berman H, Frondel C (1951) Dana's system of mineralogy, Vol. 2. Wiley, New York
- Palache C, Berman H, Frondel C (1962) Dana's system of mineralogy, Vol. 3. Wiley, New York
- Palmer JP (1967) Jade. Spring Book, London
- Pearl PG (1961a) Popular gemology. Wiley, New York
- Pearl PG (1961b) Successful mineral collecting and prospecting. Mc-Graw-Hill, New York
- Petránek J (1993) Mala encyklopedie geologie. Vydalo Nakladatelství JIH Ceske Budejovice
- Pfannkuch HO (1969) Elsevier's dictionary of hydrogeology. Elsevier, Amsterdam
- Pierrot RM (1979) Chemical and determinative tables of mineralogy. Masson Publ., New York
- Pitt VH (ed) (1976) Dictionary of physics. Penguin Books, London, New York
- Plate W (1957) Wörterbuch der Perlenkunde. Rühle-Biebner Verlag, Stuttgart
- Pliny Gaius Plinius (1971) Natural History. Translation by Eichholz DE, Loeb Classical Library
- Pogue JE (1915) The turquoise, Vol. XII. National Academic of Sciences, Washington
- Pogue FH, Rogers TH (1947) Experiments in X-ray irradiation of gem stones. American Mineralogist 32:31–34
- Poirot J-P (1980) Éléments de Gemmologie. Paris Institut, Nationale de Gemmologie
- Pryor EJ (1963) Dictionary of mineral technology. Mining Publications, London
- Quick LH, Leiper H (1963) The book of agates. Pitman, London
- Read PG (1983) Gemmological instruments, 2<sup>nd</sup> ed. Butterworths, London
- Read PG (1988) Dictionary of gemmology, 2<sup>nd</sup> ed. Butterworths Scientific, London
- Read PG (1997) Gemmology. Butterworth-Heinemann, University Press, Cambridge
- Reece NC (1958) The cultured pearl. Jewel of Japan. Charles Tuttle, Rutland, Vermont
- Rice PC (1987) Amber; The golden gem of the ages. Van Nostrand, New York
- Richardson W, Richardson J, Huett L (1988) Spiritual value of gem stones. DeVorss Publ., Marina del Rey
- Richter GMA (1968) Engraved gems of the Greeks, Etruscans and Romans. Phaidon, London
- Riha J, Uhrova J (1990) The extinct life in Moravia. The Moravian Museum, Brno
- Roberts WL, Campbell TJ, Rapp GR (1990) Encyclopedia of minerals, 2<sup>nd</sup> ed. Van Nostrand Reinhold, New York
- Rösler HJ (1981) Lehrbuch der Mineralogie. VEB Verlag, Leipzig
- Rosue JD (1986) Garnet. Butterworths, London
- Rykart R (1995) Bergkristall – Form und Schönheit alpiner Quarze. Ott Verlag, Thun
- Safranovskii II (1968) Lekcii kristallomorfologii mineralov. Lvov 1960 and Moskva 1968
- Sands DE (1993) Introduction to crystallography. Dover Publ., New York
- Savage G, Newmann H (1985) An illustrated dictionary of ceramics. Thames & Hudson, London
- Schaller WT (1920) Gems and precious stones. Mineral resources of the United States. U.S. Geol. Survey, Washington
- Schieferdecker AAG (1956) Geological nomenclature. Gorinchem, Royal Geological and Mining Society of Netherlands
- Schröcke H, Weiner KL (1981) Mineralogie. de Gruyter Verlag, Berlin
- Schumann W (1977) Gemstones of the world. Sterling Press, New York
- Shipley RM (1971) Dictionary of gems and gemology, 6<sup>th</sup> ed. Gemological Institute of America, Los Angeles
- Sinkankas J (1968) Van Nostrand's standard catalog of gems. New York
- Sinkankas J (1976) Practical gemmology, 6<sup>th</sup> ed. N.A.G. Press, London
- Sinkankas J (1984) Gem cutting. A lapidary's manual, 3<sup>rd</sup> ed. Chapman & Hall, New York
- Sinkankas J (1989) Emerald and other beryls. Geoscience Press, Tucson
- Sinkankas J, Read PG (1986) Beryl. Butterworths, London
- Sitwell HDW (1953) The crown jewels. Dropmore Press, London
- Slivko MM (1962) Characteristic features of the chemical composition of tourmaline from the schorl-dravite series. L'vov's'kogo Drezhvanogo Universitetu Vestnik. Seriza Geologichna 1:134–138
- Smith JV (1974) Feldspar minerals, Vol. 1 and 2. Springer-Verlag, New York
- Smith GF, Phillips FC (1972) Gemstones. Chapman & Hall, London
- Solinus CJ (1864) Collectanea Rerum Memorabilium. Mommsen, Th., Berolini
- Spencer LJ (1943) Sixteenth list of new mineral names. Min Mag 26
- Spencer LJ (1946) A key to precious stones, 2<sup>nd</sup> ed. Blackie, Glasgow
- Strack E (1982) Perlenfibel. Rühle-Diebner Verlag, Stuttgart
- Strübel G (1977) Mineralogie. Enke Verlag, Stuttgart
- Strunz H (1977) Mineralogische Tabellen. Akademischer Verlag, Leipzig
- Sutton JR (1928) Diamonds – A descriptive treatise. Murby, London
- Tagore SM (1879) Mani Mala, or a treatise on gems, 2 vols. Stanhope Press, Calcuta

- Tassarow L (1980) *Etot Udivitelno Symmetricny mir*. Moscow
- Tatsch JH (1973) *Mineral deposits*. Tatsch Associates, Sudbury
- Tavernier JB (1889) *Les Six Voyages dans India*. Translated in English by Valentine Ball, *Tavernier Travels in India*, 2 Vols.
- Theophrastus (1956a) *De Lapidibus*. Translation by Eichholz DE, Oxford
- Theophrastus (1956b) *On stones*. Translation by Caley ER, Richards JFC, Columbus, Ohio
- Tolanski S (1962) *The history and use of diamond*. Methuen Press, London
- Tomkeieff SI (1954) *Coals and bitumens and related fossil carbonaceous substances; Nomenclature and classification*. Pergamon Press, London
- Tomkeieff SI (1983) *Dictionary of petrology*. Wiley, New York
- Twining EF (1960) *A history of the crown jewels of Europe*. Batsford, London
- Uvarov ED, Chapman DR, Isaacs A (eds) (1984) *Dictionary of science*. Penguin Books, London, New York
- Vargas G, Vargas M (1979) *Faceting for amateurs*, 2<sup>nd</sup> ed. Thermal, CA
- Vargas G, Vargas M (1985) *Description of gem materials*, 3<sup>rd</sup> ed. Chapman & Hall, New York
- Visser WA (1980) *Geological nomenclature*. Martinus Nijhoff, The Hague, Boston
- Voskuil WH (1958) *Minerals in world industry*. New York
- Waag A (1993) *Das Schmuckbuch, 1901*. Reprint by Weltbild Verlag, Augsburg
- Walton J (1954) *The pocket chart of ornamental and gemstones*. Pitman, London
- Watermeyer B (1980) *Diamond cutting*. Purnell Press, Cape Town
- Webster R (1973) *Practical gemmology*, 5<sup>th</sup> ed. N.A.G. Press, London
- Webster R (1975a) *Gems: Their sources, description and identification*, 3<sup>rd</sup> ed. Newnes-Butterworths, London
- Webster R (1975b) *The gemmologists' compendium*. N.A.G. Press, London
- Webster R, Read PG (1997) *Gems: Their sources, description and identification*, 5<sup>th</sup> ed. Butterworth-Heinemann, Cornwall
- Weed WH (1922) *The mines handbook*. Tuckahoe, New York
- Weiss G (1991) *Keramik lexicon*, 2<sup>nd</sup> ed. Ullstein, Frankfurt
- Whitlock HP (1936) *The story of the gems*. Putnam Publ., London
- Winchel AN, Winchel H (1951) *Elements of optical mineralogy*, Vol. II, 4<sup>th</sup> ed. New York
- Winkler HG (1974) *Petrogenesis of metamorphic rocks*, 4<sup>th</sup> ed. Springer-Verlag, New York
- Wood EA (1977) *Crystals and light*, 2<sup>nd</sup> ed. Dover Publ., New York
- Wooster WA (1976) *Etch figures and crystal structures*. *Kristall & Technik* 11, 6, 17
- Wright RV, Chadbourne RL (1970) *Gems and minerals of the Bible*. Harper & Row Publ., New York
- Wykoff GL (1994) *The techniques of master faceting*. Adams Publishers, Washington D.C.
- Yaverbaum LH (1990) *Synthetic gems – Production techniques*. Noyes Data Corporation, New York
- Yule CH (1888) *The history of the pitt diamond*. London

### Periodicals or Journals

- Australian Gemmologist*. Gemmological Association of Australia, PO Box 35, South Yarra, Victoria, Australia
- Boletín del Instituto Gemológico Español*. Instituto Gemológico Español, Victor Hugo 1, 28004 Madrid, Spain
- Gems and Gemology*. Quarterly since 1934, Gemological Institute of America, 5355 Armada Drive, Suite 300, Carlsbad, CA 92008 USA
- Journal of Gemmology*. Quarterly, Gemmological Association and Gem Testing Laboratory of Great Britain, 27 Greville St., London, EC1N 8SU, UK
- La Gemmologico Italiano*. Viale Gramsci 228, 20099 Sesto S. Giovanni, Milan, Italy
- Mineralogical Abstracts*. Quarterly, Mineralogical Society, 41 Queen's Gate, London SW7 5HR, UK
- Mineralogical Record*. Mineralogical Record, Inc., 7413 N. Mowry Place, Tucson, AZ 85741, USA
- Revue de Gemmologie*. Association Française de Gemmologie, 14 Rue Cadet, Paris 75009, France
- The American Mineralogist*. Mineralogical Society of America, U.S. Natl. Museum, Washington, D.C., USA
- Zeitschrift der Deutschen Gemmologischen Gesellschaft*. Deutsche Gemmologische Gesellschaft, Schlossmacher Str. 1, 55743 Idar-Oberstein, Germany



