Principles of Food Chemistry

Third Edition

John M. deMan, PhD

Professor Emeritus
Department of Food Science
University of Guelph
Guelph, Ontario

A Chapman & Hall Food Science Book



AN ASPEN PUBLICATION[®]

Aspen Publishers, Inc.
Gaithersburg, Maryland
1999

The author has made every effort to ensure the accuracy of the information herein. However, appropriate information sources should be consulted, especially for new or unfamiliar procedures. It is the responsibility of every practitioner to evaluate the appropriateness of a particular opinion in the context of actual clinical situations and with due considerations to new developments. The author, editors, and the publisher cannot be held responsible for any typographical or other errors found in this book.

Aspen Publishers, Inc., is not affiliated with the American Society of Parenteral and Enteral Nutrition.

Library of Congress Cataloging-in-Publication Data

deMan, John M.
Principles of food chemistry/
John M. deMan.—3rd ed.
p. cm.
Includes bibliographical references and index.
ISBN 0-8342-1234-X
1. Food—Composition. I. Title.
TX531.D43 1999
664—dc21
98-31467
CIP

Copyright © 1999 by Aspen Publishers, Inc.
All rights reserved.

Aspen Publishers, Inc., grants permission for photocopying for limited personal or internal use. This consent does not extend to other kinds of copying, such as copying for general distribution, for advertising or promotional purposes, for creating new collective works, or for resale. For information, address Aspen Publishers, Inc., Permissions Department, 200 Orchard Ridge Drive, Suite 200, Gaithersburg, Maryland 20878.

Orders: (800) 638-8437
Customer Service: (800) 234-1660

About Aspen Publishers • For more than 35 years, Aspen has been a leading professional publisher in a variety of disciplines. Aspen's vast information resources are available in both print and electronic formats. We are committed to providing the highest quality information available in the most appropriate format for our customers. Visit Aspen's Internet site for more information resources, directories, articles, and a searchable version of Aspen's full catalog, including the most recent publications: <http://www.aspenpublishers.com>

Aspen Publishers, Inc. • The hallmark of quality in publishing
Member of the worldwide Wolters Kluwer group.

Editorial Services: Jane Colilla
Library of Congress Catalog Card Number: 98-31467
ISBN: 0-8342-1234-X
Printed in the United States of America

Preface

This book was designed to serve as a text for courses in food chemistry in food science programs following the Institute of Food Technologists minimum standards. The original idea in the preparation of this book was to present basic information on the composition of foods and the chemical and physical characteristics they undergo during processing, storage, and handling. The basic principles of food chemistry remain the same, but much additional research carried out in recent years has extended and deepened our knowledge. This required inclusion of new material in all chapters. The last chapter in the second edition, Food Additives, has been replaced by the chapter Additives and Contaminants, and an additional chapter, Regulatory Control of Food Composition, Quality, and Safety, has been included. This last chapter is an attempt to give students some understanding of the scientific basis of the formulation of laws and regulations on food and on the increasing trend toward international harmonization of these laws. A number of important food safety issues have arisen recently, and these have emphasized the need for comprehensive and effective legal controls.

In the area of water as a food component, the issue of the glass transition has received much attention. This demonstrates the important role of water in food properties. Lipids have received much attention lately mainly because of publicity related to nutritional problems. Saturated

lipids, low caloric fats, and biotechnology have received a good deal of attention. Our understanding of the functionality of proteins expands with increasing knowledge about their composition and structure. Carbohydrates serve many functions in foods, and the noncaloric dietary fiber has assumed an important role.

Color, flavor, and texture are important attributes of food quality, and in these areas, especially those of flavor and texture, great advances have been made in recent years. Enzymes are playing an ever increasing part in the production and transformation of foods. Modern methods of biotechnology have produced a gamut of enzymes with new and improved properties.

In the literature, information is found using different systems of units: metric, SI, and the English system. Quotations from the literature are presented in their original form. It would be difficult to change all these units in the book to one system. To assist the reader in converting these units, an appendix is provided with conversion factors for all units found in the text.

It is hoped that this new edition will continue to fulfill the need for a concise and relevant text for the teaching of food chemistry. I express gratitude to those who have provided comments and suggestions for improvement, and especially to my wife, Leny, who has provided a great deal of support and encouragement during the preparation of the third edition.

Contents

<i>Preface</i>	vii
1. Water	1
Physical Properties of Water and Ice	1
Structure of the Water Molecule	2
Sorption Phenomena	4
Types of Water	11
Freezing and Ice Structure	14
Water Activity and Food Spoilage	23
Water Activity and Packaging	26
Water Binding of Meat	28
Water Activity and Food Processing	30
2. Lipids	33
Introduction	33
Shorthand Description of Fatty Acids and Glycerides	35
Component Fatty Acids	36
Component Glycerides	45
Phospholipids	50
Unsaponifiables	51
Autoxidation	54
Photooxidation	63
Heated Fats – Frying	65
Flavor Reversion	70
Hydrogenation	71
Interesterification	77
Physical Properties	81
Fractionation	94

Cocoa Butter and Confectionery Fats	95
Emulsions and Emulsifiers	101
Novel Oils and Fats	106
Fat Replacers	107
3. Proteins	111
Introduction	111
Amino Acid Composition	111
Protein Classification	113
Protein Structure	115
Denaturation	118
Nonenzymic Browning	120
Chemical Changes	131
Functional Properties	134
Animal Proteins	138
Plant Proteins	152
4. Carbohydrates	163
Introduction	163
Monosaccharides	163
Related Compounds	167
Oligosaccharides	169
Polysaccharides	183
Dietary Fiber	203
5. Minerals	209
Introduction	209
Major Minerals	209
Trace Elements	217
Metal Uptake in Canned Foods	223
6. Color	229
Introduction	229
CIE System	229
Munsell System	236
Hunter System	237

Lovibond System	238
Gloss	239
Food Colorants	239
7. Flavor	263
Introduction	263
Taste	263
Odor	282
Description of Food Flavors	291
Astringency	294
Flavor and Off-Flavor	296
Flavor of Some Foods	297
8. Texture	311
Introduction	311
Texture Profile	313
Objective Measurement of Texture	316
Different Types of Bodies	320
Application to Foods	328
Textural Properties of Some Foods	334
Microstructure	341
Water Activity and Texture	347
9. Vitamins	355
Introduction	355
Fat-Soluble Vitamins	355
Water-Soluble Vitamins	366
Vitamins as Food Ingredients	385
10. Enzymes	389
Introduction	389
Nature and Function	389
Hydrolases	395
Oxidoreductases	413
Immobilized Enzymes	423

11. Additives and Contaminants	429
Introduction	429
Intentional Additives	431
Incidental Additives or Contaminants	449
12. Regulatory Control of Food Composition, Quality, and Safety	475
Historical Overview	475
Safety	477
U.S. Food Laws	479
Canadian Food Laws	481
European Union (EU) Food Laws	482
International Food Law: Codex Alimentarius	484
Harmonization	488
Appendices	491
Appendix A. Units and Conversion Factors	491
Appendix B. Greek Alphabet	495
Index	497

Water

Water is an essential constituent of many foods. It may occur as an intracellular or extracellular component in vegetable and animal products, as a dispersing medium or solvent in a variety of products, as the dispersed phase in some emulsified products such as butter and margarine, and as a minor constituent in other foods. Table 1-1 indicates the wide range of water content in foods.

Because of the importance of water as a food constituent, an understanding of its properties and behavior is necessary. The presence of water influences the chemical and microbiological deterioration of foods. Also, removal (drying) or freezing of water is essential to some methods of food preservation. Fundamental changes in the product may take place in both instances.

PHYSICAL PROPERTIES OF WATER AND ICE

Some of the physical properties of water and ice are exceptional, and a list of these is presented in Table 1-2. Much of this information was obtained from Perry (1963) and Landolt-Boernstein (1923). The exceptionally high values of the caloric properties of water are of importance for food processing

Table 1-1 Typical Water Contents of Some Selected Foods

<i>Product</i>	<i>Water (%)</i>
Tomato	95
Lettuce	95
Cabbage	92
Beer	90
Orange	87
Apple juice	87
Milk	87
Potato	78
Banana	75
Chicken	70
Salmon, canned	67
Meat	65
Cheese	37
Bread, white	35
Jam	28
Honey	20
Butter and margarine	16
Wheat flour	12
Rice	12
Coffee beans, roasted	5
Milk powder	4
Shortening	0

operations such as freezing and drying. The considerable difference in density of water

Table 1-2 Some Physical Properties of Water and Ice

<i>Water</i>	<i>Temperature (°C)</i>					
	<i>0</i>	<i>20</i>	<i>40</i>	<i>60</i>	<i>80</i>	<i>100</i>
Vapor pressure (mm Hg)	4.58	17.53	55.32	149.4	355.2	760.0
Density (g/cm ³)	0.9998	0.9982	0.9922	0.9832	0.9718	0.9583
Specific heat (cal/g°C)	1.0074	0.9988	0.9980	0.9994	1.0023	1.0070
Heat of vaporization (cal/g)	597.2	586.0	574.7	563.3	551.3	538.9
Thermal conductivity (kcal/m ² h°C)	0.486	0.515	0.540	0.561	0.576	0.585
Surface tension (dynes/cm)	75.62	72.75	69.55	66.17	62.60	58.84
Viscosity (centipoises)	1.792	1.002	0.653	0.466	0.355	0.282
Refractive index	1.3338	1.3330	1.3306	1.3272	1.3230	1.3180
Dielectric constant	88.0	80.4	73.3	66.7	60.8	55.3
Coefficient of thermal expansion × 10 ⁻⁴	—	2.07	3.87	5.38	6.57	—

<i>Ice</i>	<i>Temperature (°C)</i>						
	<i>0</i>	<i>-5</i>	<i>-10</i>	<i>-15</i>	<i>-20</i>	<i>-25</i>	<i>-30</i>
Vapor pressure (mm Hg)	4.58	3.01	1.95	1.24	0.77	0.47	0.28
Heat of fusion (cal/g)	79.8	—	—	—	—	—	—
Heat of sublimation (cal/g)	677.8	—	672.3	—	666.7	—	662.3
Density (g/cm ³)	0.9168	0.9171	0.9175	0.9178	0.9182	0.9185	0.9188
Specific heat (cal/g°C)	0.4873	—	0.4770	—	0.4647	—	0.4504
Coefficient of thermal expansion × 10 ⁻⁵	9.2	7.1	5.5	4.4	3.9	3.6	3.5
Heat capacity (joule/g)	2.06	—	—	—	1.94	—	—

and ice may result in structural damage to foods when they are frozen. The density of ice changes with changes in temperature, resulting in stresses in frozen foods. Since solids are much less elastic than semisolids, structural damage may result from fluctuating temperatures, even if the fluctuations remain below the freezing point.

STRUCTURE OF THE WATER MOLECULE

The reason for the unusual behavior of water lies in the structure of the water molecule (Figure 1-1) and in the molecule's ability to form hydrogen bonds. In the water molecule the atoms are arranged at an angle

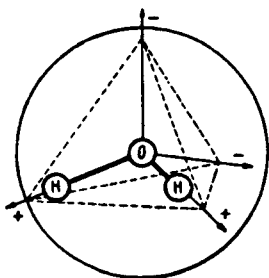
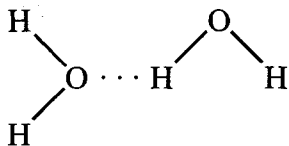

Figure 1-1 Structure of the Water Molecule

of 105 degrees, and the distance between the nuclei of hydrogen and oxygen is 0.0957 nm. The water molecule can be considered a spherical quadrupole with a diameter of 0.276 nm, where the oxygen nucleus forms the center of the quadrupole. The two negative and two positive charges form the angles of a regular tetrahedron. Because of the separation of charges in a water molecule, the attraction between neighboring molecules is higher than is normal with van der Waals' forces.



In ice, every H_2O molecule is bound by four such bridges to each neighbor. The binding energy of the hydrogen bond in ice amounts to 5 kcal per mole (Pauling 1960). Similar strong interactions occur between OH and NH and between small, strongly electronegative atoms such as O and N. This is the reason for the strong association in alcohols, fatty acids, and amines and their great affinity to water. A comparison of the properties of water with those of the hydrides of elements near oxygen in the Periodic Table (CH_4 , NH_3 , HF, DH_3 , H_2S , HCl) indicates

that water has unusually high values for certain physical constants, such as melting point, boiling point, heat capacity, latent heat of fusion, latent heat of vaporization, surface tension, and dielectric constant. Some of these values are listed in Table 1-3.

Water may influence the conformation of macromolecules if it has an effect on any of the noncovalent bonds that stabilize the conformation of the large molecule (Klotz 1965). These noncovalent bonds may be one of three kinds: hydrogen bonds, ionic bonds, or apolar bonds. In proteins, competition exists between interamide hydrogen bonds and water-amide hydrogen bonds. According to Klotz (1965), the binding energy of such bonds can be measured by changes in the near-infrared spectra of solutions in *N*-methylacetamide. The greater the hydrogen bonding ability of the solvent, the weaker the $\text{C}=\text{O}\cdots\text{H}-\text{N}$ bond. In aqueous solvents the heat of formation or disruption of this bond is zero. This means that a $\text{C}=\text{O}\cdots\text{H}-\text{N}$ hydrogen bond cannot provide stabilization in aqueous solutions. The competitive hydrogen bonding by H_2O lessens the thermodynamic tendency toward the formation of interamide hydrogen bonds.

The water molecules around an apolar solute become more ordered, leading to a loss in entropy. As a result, separated apolar groups in an aqueous environment tend to

Table 1-3 Physical Properties of Some Hydrides

Sub-stance	Melting Point (°C)	Boiling Point (°C)	Molar Heat of Vaporization (cal/mole)
CH_4	-184	-161	2,200
NH_3	-78	-33	5,550
HF	-92	+19	7,220
H_2O	0	+100	9,750

associate with each other rather than with the water molecules. This concept of a hydrophobic bond has been schematically represented by Klotz (1965), as shown in Figure 1-2. Under appropriate conditions apolar molecules can form crystalline hydrates, in which the compound is enclosed within the space formed by a polyhedron made up of water molecules. Such polyhedrons can form a large lattice, as indicated in Figure 1-3. The polyhedrons may enclose apolar guest molecules to form apolar hydrates (Speedy 1984). These pentagonal polyhedra of water molecules are unstable and normally change to liquid water above 0°C and to normal hexagonal ice below 0°C. In some cases, the hydrates melt well above 30°C. There is a remarkable similarity between the small apolar molecules that form these clathrate-like hydrates and the apolar side chains of proteins. Some of these are shown in Figure 1-4. Because small molecules such as the ones shown in Figure 1-4 can form stable water cages, it may be assumed that some of

the apolar amino acid side chains in a polypeptide can do the same. The concentration of such side chains in proteins is high, and the combined effect of all these groups can be expected to result in the formation of a stabilized and ordered water region around the protein molecule. Klotz (1965) has suggested the term *hydrotactoids* for these structures (Figure 1-5).

SORPTION PHENOMENA

Water activity, which is a property of aqueous solutions, is defined as the ratio of the vapor pressures of pure water and a solution:

$$a_w = \frac{p}{p_o}$$

where

a_w = water activity

p = partial pressure of water in a food

p_o = vapor pressure of water at the same temperature

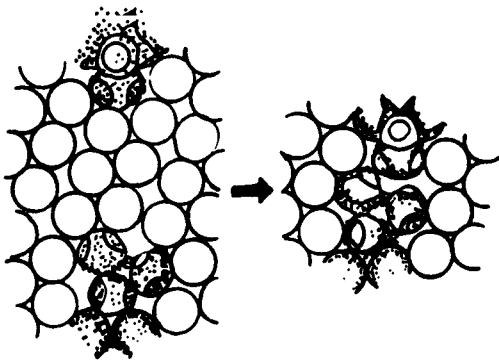

Figure 1-2 Schematic Representation of the Formation of a Hydrophobic Bond by Apolar Group in an Aqueous Environment. Open circles represent water. *Source:* From I.M. Klotz, Role of Water Structure in Macromolecules, *Federation Proceedings*, Vol. 24, Suppl. 15, pp. S24-S33, 1965.

According to Raoult's law, the lowering of the vapor pressure of a solution is proportional to the mole fraction of the solute: a_w can then be related to the molar concentrations of solute (n_1) and solvent (n_2):

$$a_w = \frac{p}{p_o} = \frac{n_1}{n_1 + n_2}$$

The extent to which a solute reduces a_w is a function of the chemical nature of the solute. The equilibrium relative humidity (ERH) in percentage is ERH/100. ERH is defined as:

$$ERH = \frac{p^{equ}}{p^{sat}}$$

where

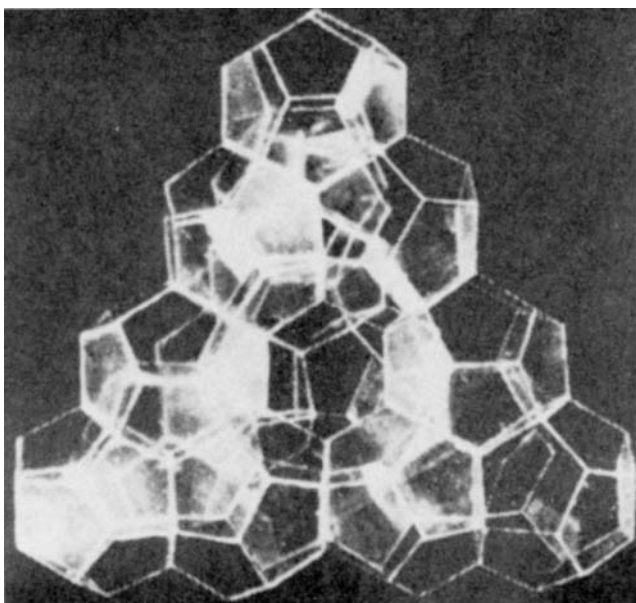

Figure 1-3 Crystalline Apolar Polyhedrons Forming a Large Lattice. The space within the polyhedrons may enclose apolar molecules. *Source:* From I.M. Klotz, Role of Water Structure in Macromolecules, *Federation Proceedings*, Vol. 24, Suppl. 15, pp. S24-S33, 1965.



Crystal Hydrate Formers	Amino Acid Side Chains	
CH_4	$-\text{CH}_3$	(Ala)
$\begin{array}{c} \text{CH}_3 \\ \diagup \quad \diagdown \\ \text{CH}_2 \\ \diagdown \quad \diagup \\ \text{CH}_3 \end{array}$	$\begin{array}{c} \text{CH}_3 \\ \diagup \quad \diagdown \\ -\text{CH} \\ \diagdown \quad \diagup \\ \text{CH}_3 \end{array}$	(Val)
$\begin{array}{c} \text{CH}_3 \\ \diagup \quad \diagdown \\ \text{CH}_3-\text{CH} \\ \diagdown \quad \diagup \\ \text{CH}_3 \end{array}$	$\begin{array}{c} \text{CH}_3 \\ \diagup \quad \diagdown \\ -\text{CH}_2-\text{CH} \\ \diagdown \quad \diagup \\ \text{CH}_3 \end{array}$	(Leu)
CH_3-SH	$-\text{CH}_2-\text{SH}$	(Cys)
$\text{CH}_3-\text{S}-\text{CH}_3$	$-\text{CH}_2-\text{CH}_2-\text{S}-\text{CH}_3$	(Met)
	$-\text{CH}_2-$ 	(Phe)

Figure 1-4 Comparison of Hydrate-Forming Molecules and Amino Acid Apolar Side Chains. *Source:* From I.M. Klotz, Role of Water Structure in Macromolecules, *Federation Proceedings*, Vol. 24, Suppl. 15, pp. S24-S33, 1965.

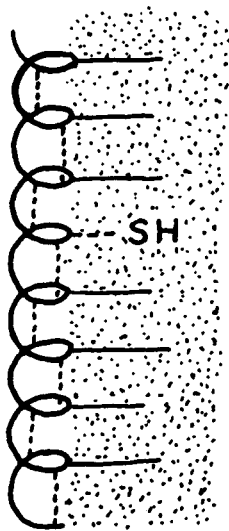

Figure 1-5 Hydrotactoid Formation Around Apolar Groups of a Protein. *Source:* From I.M. Klotz, Role of Water Structure in Macromolecules, *Federation Proceedings*, Vol. 24, Suppl. 15, pp. S24-S33, 1965.

p^{equ} = partial pressure of water vapor in equilibrium with the food at temperature T and 1 atmosphere total pressure

p^{sat} = the saturation partial pressure of water in air at the same temperature and pressure

At high moisture contents, when the amount of moisture exceeds that of solids, the activity of water is close to or equal to 1.0. When the moisture content is lower than that of solids, water activity is lower than 1.0, as indicated in Figure 1-6. Below moisture content of about 50 percent the water activity decreases rapidly and the relationship between water content and relative humidity is represented by the sorption isotherms. The adsorption and desorption processes are not fully reversible; therefore, a

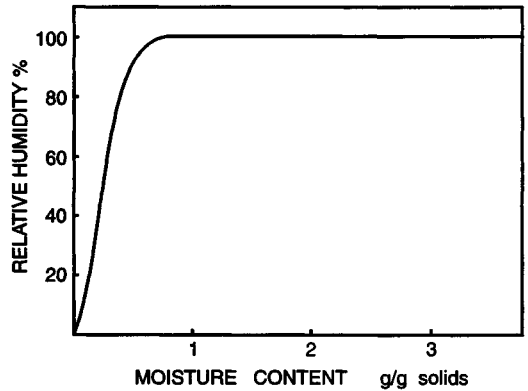

Figure 1-6 Water Activity in Foods at Different Moisture Contents

distinction can be made between the adsorption and desorption isotherms by determining whether a dry product's moisture levels are increasing, or whether the product's moisture is gradually lowering to reach equilibrium with its surroundings, implying that the product is being dried (Figure 1-7). Generally, the adsorption isotherms are required for the observation of hygroscopic products,

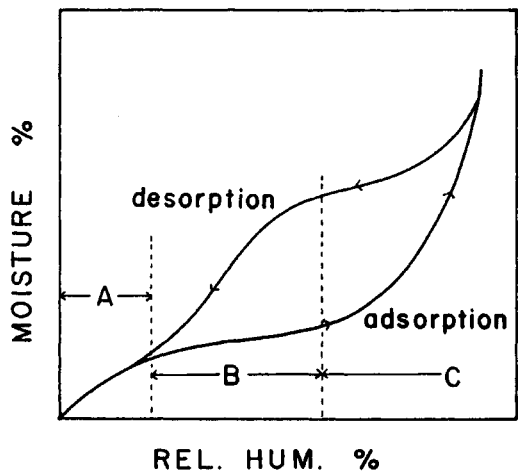

Figure 1-7 Adsorption and Desorption Isotherms

and the desorption isotherms are useful for investigation of the process of drying. A steeply sloping curve indicates that the material is hygroscopic (curve A, Figure 1-8); a flat curve indicates a product that is not very sensitive to moisture (curve B, Figure 1-8). Many foods show the type of curves given in Figure 1-9, where the first part of the curve is quite flat, indicating a low hygroscopicity, and the end of the curve is quite steep, indicating highly hygroscopic conditions. Such curves are typical for foods with high sugar or salt contents and low capillary adsorption. Such foods are hygroscopic. The reverse of this type of curve is rarely encountered. These curves show that a hygroscopic product or hygroscopic conditions can be defined as the case where a small increase in relative humidity causes a large increase in product moisture content.

Sorption isotherms usually have a sigmoid shape and can be divided into three areas that correspond to different conditions of the water present in the food (Figure 1-7). The

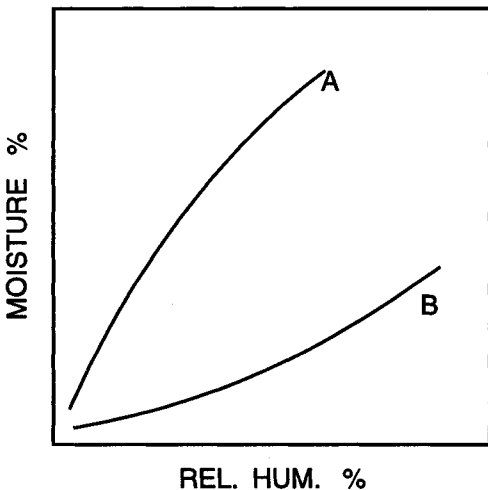

Figure 1-8 Sorption Isotherms of Hygroscopic Product (A) and Nonhygroscopic Product (B)

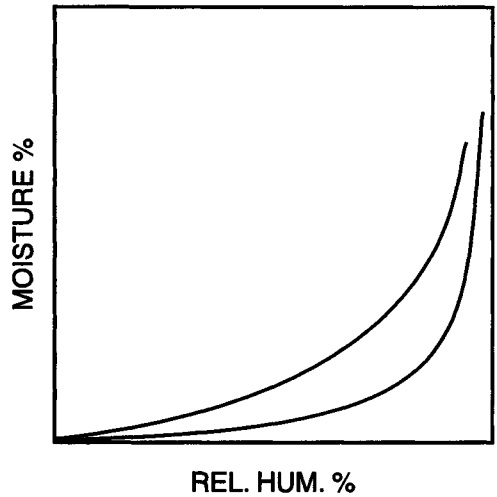

Figure 1-9 Sorption Isotherms for Foods with High Sugar or Salt Content; Low Capillary Adsorption

first part (A) of the isotherm, which is usually steep, corresponds to the adsorption of a monomolecular layer of water; the second, flatter part (B) corresponds to adsorption of additional layers of water; and the third part (C) relates to condensation of water in capillaries and pores of the material. There are no sharp divisions between these three regions, and no definite values of relative humidity exist to delineate these parts. Labuza (1968) has reviewed the various ways in which the isotherms can be explained. The kinetic approach is based on the Langmuir equation, which was initially developed for adsorption of gases and solids. This can be expressed in the following form:

$$\frac{a}{\bar{V}} = \left[\frac{K}{bV_m} \right] + \frac{a}{V_m}$$

where

- a = water activity
- b = a constant

$K = 1/p_o$ and p_o = vapor pressure of water at T_o

V = volume adsorbed

V_m = monolayer value

When a/V is plotted versus a , the result is a straight line with a slope equal to $1/V_m$ and the monolayer value can be calculated. In this form, the equation has not been satisfactory for foods, because the heat of adsorption that enters into the constant b is not constant over the whole surface, because of interaction between adsorbed molecules, and because maximum adsorption is greater than only a monolayer.

A form of isotherm widely used for foods is the one described by Brunauer et al. (1938) and known as the BET isotherm or equation. A form of the BET equation given by Labuza (1968) is

$$\frac{a}{(1-a)V} = \frac{1}{V_m C} + \left[\frac{a(C-1)}{V_m C} \right]$$

where

C = constant related to the heat of adsorption

A plot of $a/(1-a)V$ versus a gives a straight line, as indicated in Figure 1-10. The monolayer coverage value can be calculated from the slope and the intercept of the line. The BET isotherm is only applicable for values of a from 0.1 to 0.5. In addition to monolayer coverage, the water surface area can be calculated by means of the following equation:

$$\begin{aligned} S_o &= V_m \cdot \frac{1}{M_{H_2O}} \cdot N_o \cdot A_{H_2O} \\ &= 3.5 \times 10^3 V_m \end{aligned}$$

where

S_o = surface area, m^2/g solid

M_{H_2O} = molecular weight of water, 18

N_o = Avogadro's number, 6×10^{23}

A_{H_2O} = area of water molecule, $10.6 \times 10^{20} m^2$

The BET equation has been used in many cases to describe the sorption behavior of foods. For example, note the work of Saravacos (1967) on the sorption of dehydrated apple and potato. The form of BET equation used for calculation of the monolayer value was

$$\frac{p}{W(p_o - p)} = \frac{1}{W_1 C} + \frac{C-1}{W_1 C} \cdot \frac{P_o}{P}$$

where

W = water content (in percent)

p = vapor pressure of sample

p_o = vapor pressure of water at same temperature

C = heat of adsorption constant

W_1 = moisture content corresponding to monolayer

The BET plots obtained by Saravacos for dehydrated potato are presented in Figure 1-11.

Other approaches have been used to analyze the sorption isotherms, and these are described by Labuza (1968). However, the Langmuir isotherm as modified by Brunauer et al. (1938) has been most widely used with food products. Another method to analyze the sorption isotherms is the GAB sorption model described by van den Berg and Bruin (1981) and used by Roos (1993) and Joupila and Roos (1994).

As is shown in Figure 1-7, the adsorption and desorption curves are not identical. The hysteresis effect is commonly observed; note,

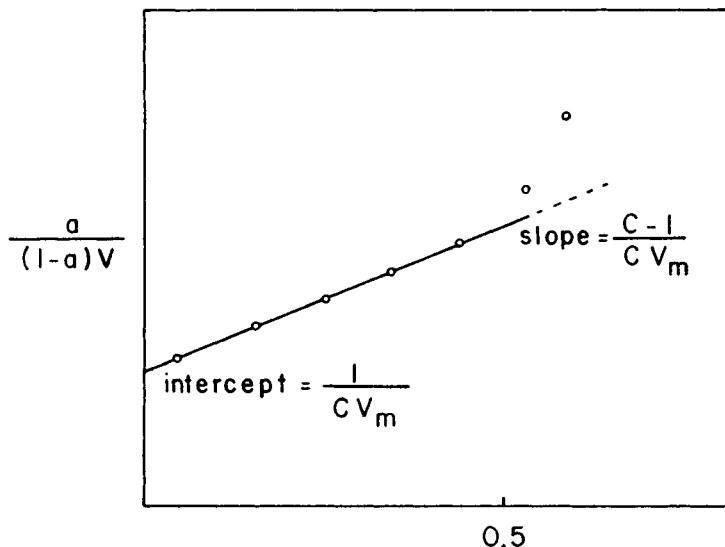

Figure 1-10 BET Monolayer Plot. *Source:* From T.P. Labuza, Sorption Phenomena in Foods, *Food Technol.*, Vol. 22, pp. 263-272, 1968.

for example, the sorption isotherms of wheat flour as determined by Bushuk and Winkler (1957) (Figure 1-12). The hysteresis effect is explained by water condensing in the capil-

laries, and the effect occurs not only in region C of Figure 1-7 but also in a large part of region B. The best explanation for this phenomenon appears to be the so-called ink bot-

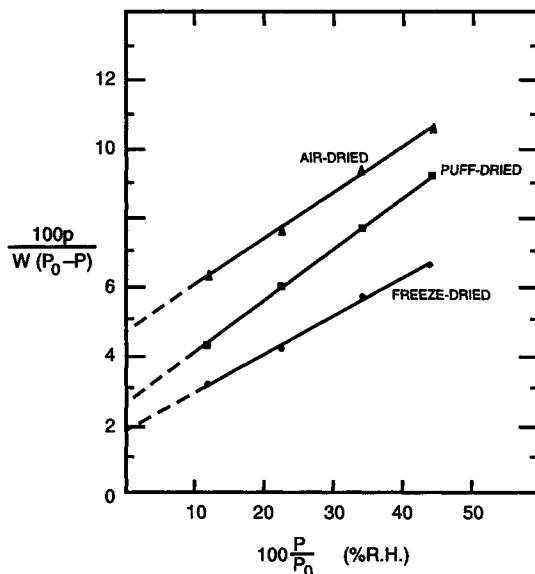

Figure 1-11 BET Plots for Dehydrated Potato. *Source:* From G.D. Saravacos, Effect of the Drying Method on the Water Sorption of Dehydrated Apple and Potato, *J. Food Sci.*, Vol. 32, pp. 81-84, 1967.

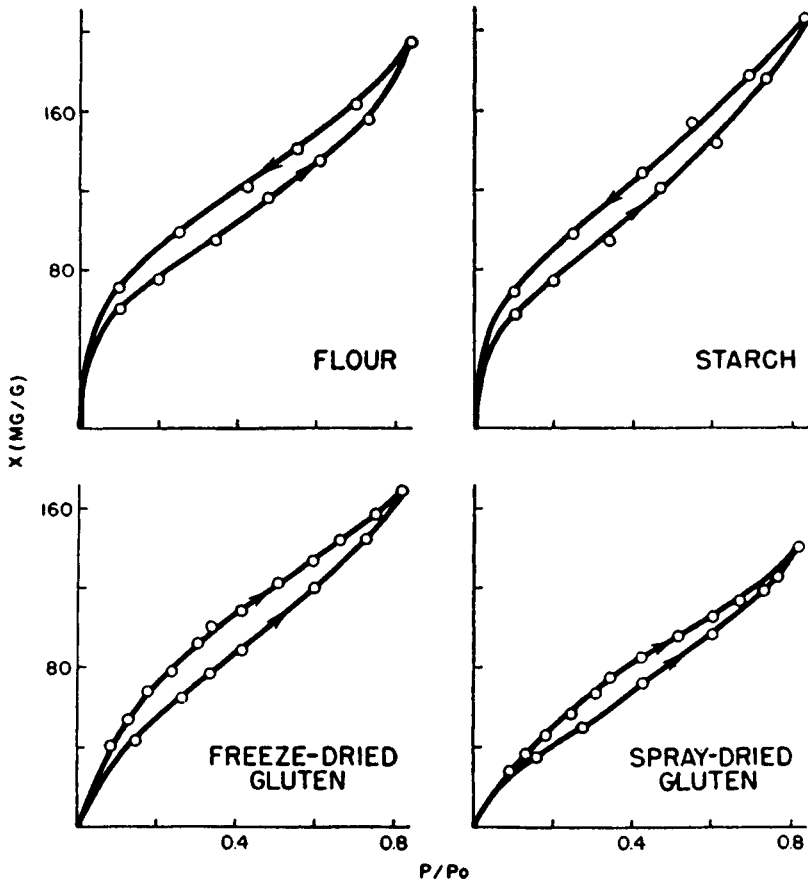

Figure 1-12 Sorption Isotherms of Wheat Flour, Starch, and Gluten. *Source:* From W. Bushuk and C.A. Winkler, Sorption of Water Vapor on Wheat Flour, Starch and Gluten, *Cereal Chem.*, Vol. 34, pp. 73-86, 1957.

the theory (Labuza 1968). It is assumed that the capillaries have narrow necks and large bodies, as represented schematically in Figure 1-13. During adsorption the capillary does not fill completely until an activity is reached that corresponds to the large radius R . During desorption, the unfilling is controlled by the smaller radius r , thus lowering the water activity. Several other theories have been advanced to account for the hysteresis in sorption. These have been summarized by Kapsalis (1987).

The position of the sorption isotherms depends on temperature: the higher the temperature, the lower the position on the graph.

This decrease in the amount adsorbed at higher temperatures follows the Clausius Clapeyron relationship,

$$\frac{d(\ln a)}{d(1/T)} = -\frac{Q_s}{R}$$

where

Q_s = heat of adsorption

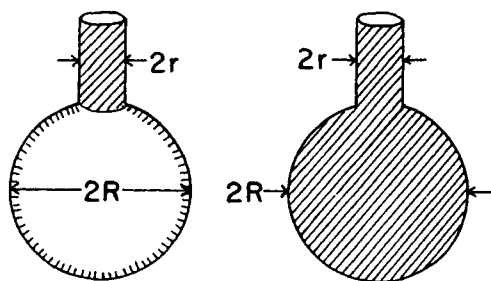

Figure 1-13 Ink Bottle Theory of Hysteresis in Sorption. *Source:* From T.P. Labuza, Sorption Phenomena in Foods, *Food Technol.*, Vol. 22, pp. 263-272, 1968.

R = gas constant

T = absolute temperature

By plotting the natural logarithm of activity versus the reciprocal of absolute temperature at constant moisture values, straight lines are obtained with a slope of $-Q_s/R$ (Figure 1-14). The values of Q_s obtained in this way for foods having less than full monolayer coverage are between about

2,000 and 10,000 cal per mole, demonstrating the strong binding of this water.

According to the principle of BET isotherm, the heat of sorption Q_s should be constant up to monolayer coverage and then should suddenly decrease. Labuza (1968) has pointed out that the latent heat of vaporization ΔH_v , about 10.4 kcal per mole, should be added to obtain the total heat value. The plot representing BET conditions as well as actual findings are given in Figure 1-15. The observed heat of sorption at low moisture contents is higher than theory indicates and falls off gradually, indicating the gradual change from Langmuir to capillary water.

TYPES OF WATER

The sorption isotherm indicates that different forms of water may be present in foods. It is convenient to divide the water into three types: Langmuir or monolayer water, capillary water, and loosely bound water. The bound water can be attracted strongly and held in a rigid and orderly state. In this form

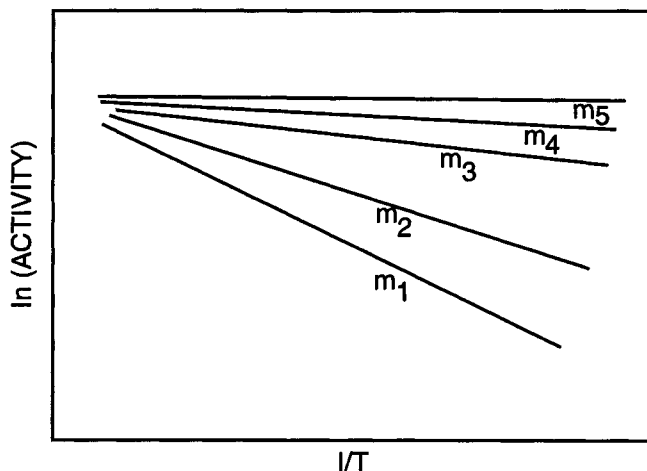

Figure 1-14 Method for Determination of Heat of Adsorption. Moisture content increases from M_1 to M_5 . *Source:* From T.P. Labuza, Sorption Phenomena in Foods, *Food Technol.*, Vol. 22, pp. 263-272, 1968.

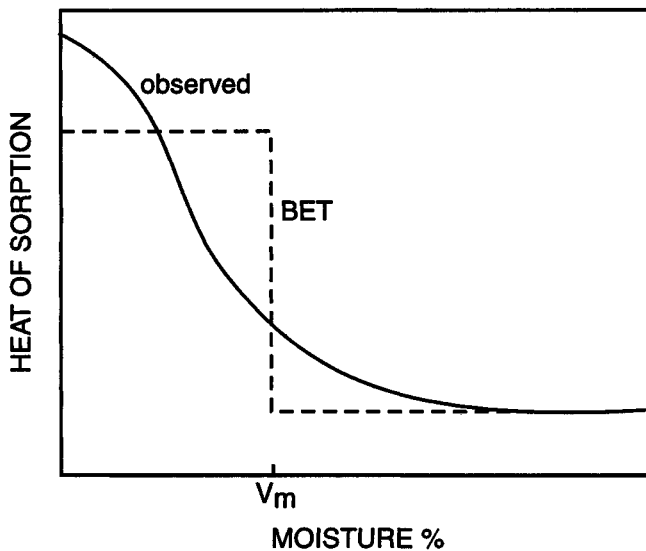

Figure 1-15 Relationship of Heat of Sorption and Moisture Content as Actually Observed and According to BET Theory. *Source:* From T.P. Labuza, Sorption Phenomena in Foods, *Food Technol.*, Vol. 22, pp. 263-272, 1968.

the water is unavailable as a solvent and does not freeze. It is difficult to provide a rigid definition of bound water because much depends on the technique used for its measurement. Two commonly used definitions are as follows:

1. Bound water is the water that remains unfrozen at some prescribed temperature below 0°C, usually -20°C.
2. Bound water is the amount of water in a system that is unavailable as a solvent.

The amount of unfreezable water, based on protein content, appears to vary only slightly from one food to another. About 8 to 10 percent of the total water in animal tissue is unavailable for ice formation (Meryman 1966). Egg white, egg yolk, meat, and fish all contain approximately 0.4 g of unfreezable water per g of dry protein. This corre-

sponds to 11.4 percent of total water in lean meat. Most fruits and vegetables contain less than 6 percent unfreezable water; whole grain corn, 34 percent.

The free water is sometimes determined by pressing a food sample between filter paper, by diluting with an added colored substance, or by centrifugation. None of these methods permits a distinct division between free and bound water, and results obtained are not necessarily identical between methods. This is not surprising since the adsorption isotherm indicates that the division between the different forms of water is gradual rather than sharp. A promising new method is the use of nuclear magnetic resonance, which can be expected to give results based on the freedom of movement of the hydrogen nuclei.

The main reason for the increased water content at high values of water activity must be capillary condensation. A liquid with sur-

face tension σ in a capillary with radius r is subject to a pressure loss, the capillary pressure $p_o = 2\sigma/r$, as evidenced by the rising of the liquid in the capillary. As a result, there is a reduction in vapor pressure in the capillary, which can be expressed by the Thomson equation,

$$\ln \frac{p}{p_o} = - \frac{2\sigma}{r} \cdot \frac{V}{RT}$$

where

p = vapor pressure of liquid

p_o = capillary vapor pressure

σ = surface tension

V = mole volume of liquid

R = gas constant

T = absolute temperature

This permits the calculation of water activity in capillaries of different radii, as indicated in Table 1-4. In water-rich organic foods, such as meat and potatoes, the water is present in part in capillaries with a radius of 1 μm or more. The pressure necessary to remove this water is small. Calculated values of this pressure are given in Table 1-5 for water contained in capillaries ranging from 0.1 μm to 1 mm radius. It is evident that water from capillaries of 0.1 μm or larger can easily drip out. Structural damage caused, for instance, by freezing can easily result in drip loss in these products. The fact that water serves as a solvent for many solutes such as salts and sugars is an additional factor in reducing the vapor pressure.

The caloric behavior of water has been studied by Riedel (1959), who found that water in bread did not freeze at all when moisture content was below 18 percent (Figure 1-16). With this method it was possible to determine the nonfreezable water. For bread, the value was 0.30 g per g dry matter,

Table 1-4 Capillary Radius and Water Activity

Radius (nm)	Activity (a)
0.5	0.116
1	0.340
2	0.583
5	0.806
10	0.898
20	0.948
50	0.979
100	0.989
1000	0.999

and for fish and meat, 0.40 g per g protein. The nonfreezable and Langmuir water are probably not exactly the same. Wierbicki and Deatherage (1958) used a pressure method to determine free water in meat. The amount of free water in beef, pork, veal, and lamb varies from 30 to 50 percent of total moisture, depending on the kind of meat and the period of aging. A sharp drop in bound water occurs during the first day after slaughter, and is followed by a gradual, slight increase. Hamm and Deatherage (1960b) determined the changes in hydration during the heating of meat. At the normal pH of meat there is a considerable reduction of bound water.

Table 1-5 Pressure Required To Press Water from Tissue at 20°C

Radius	Pressure (kg/cm ²)
0.1 μm	14.84
1 μm	1.484
10 μm	0.148
0.1 mm	0.0148
1 mm	0.0015

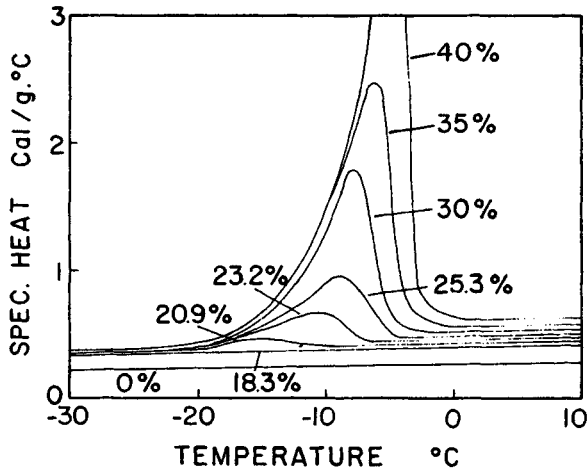

Figure 1-16 Specific Heat of Bread of Different Water Contents (Indicated as %) as a Function of Temperature. *Source:* From L. Riedel, *Calorimetric Studies of the Freezing of White Bread and Other Flour Products*, *Kältetechn.*, Vol. 11, pp. 41-46, 1959.

FREEZING AND ICE STRUCTURE

A water molecule may bind four others in a tetrahedral arrangement. This results in a hexagonal crystal lattice in ice, as shown in Figure 1-17. The lattice is loosely built and has relatively large hollow spaces; this results in a high specific volume. In the hydrogen bonds, the hydrogen atom is 0.1 nm from one oxygen atom and 0.176 nm

from another hydrogen atom. When ice melts, some of the hydrogen bonds are broken and the water molecules pack together more compactly in a liquid state (the average ligancy of a water molecule in water is about 5 and in ice, 4). There is some structural disorder in the ice crystal. For each hydrogen bond, there are two positions for the hydrogen atom: O-H-O and O+H-O. Without restrictions on the disorder, there would be 4^N ways of arranging the hydrogen atoms in an ice crystal containing N water molecules ($2N$ hydrogen atoms). There is one restriction, though: there must be two hydrogen atoms near each oxygen atom. As a result there are only $(3/2)^N$ ways of arranging the hydrogen atoms in the crystal.

The phase diagram (Figure 1-18) indicates the existence of three phases: solid, liquid, and gas. The conditions under which they exist are separated by three equilibrium lines: the vapor pressure line TA, the melting pressure line TC, and the sublimation pressure line BT. The three lines meet at point T,

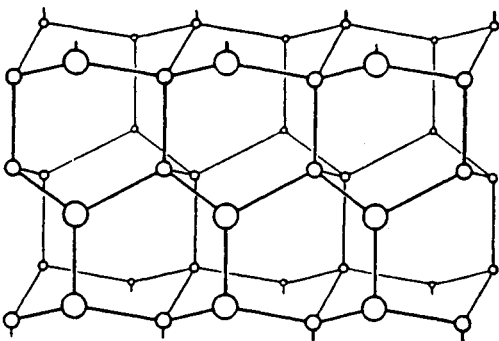

Figure 1-17 Hexagonal Pattern of the Lattice Structure in Ice

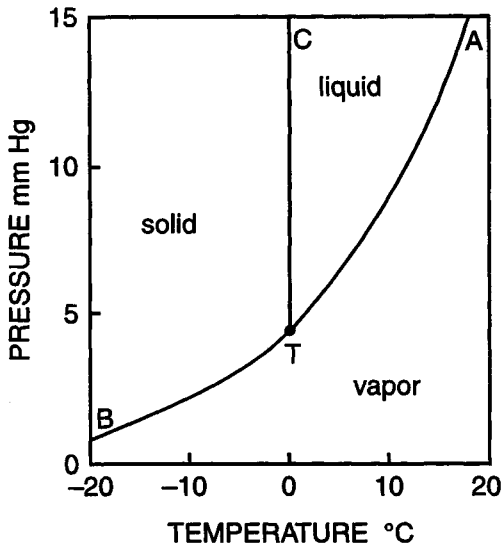

Figure 1-18 Phase Diagram of Water

where all three phases are in equilibrium. Figure 1-18 shows that when ice is heated at pressures below 4.58 mm Hg, it changes directly into the vapor form. This is the basis of freeze drying.

It is possible to supercool water. When a small ice crystal is introduced, the supercooling is immediately terminated and the temperature rises to 0°C. Normally the presence of a nucleus is required. Generally, nuclei form around foreign particles (heterogeneous nucleation). It is difficult to study homogeneous nucleation. This has been studied in the case of fat crystallization, by emulsifying the fat so that it is divided into a large number of small volumes, with the chance of a globule containing a heterogeneous nucleus being very small (Vanden-Tempel 1958). A homogeneous nucleus forms from the chance agglomeration of water molecules in the ice configuration. Usually, such nuclei disintegrate above a critical temperature. The probability of such nuclei forming depends on the volume of water; they are more likely to

form at higher temperature and in larger volumes. In ultrapure water, 1 mL can be supercooled to -32°C; droplets of 0.1 mm diameter to -35°C; and droplets of 1 μm to -41°C before solidification occurs.

The speed of crystallization—that is, the progress of the ice front in centimeters per second—is determined by the removal of the heat of fusion from the area of crystallization. The speed of crystallization is low at a high degree of supercooling (Meryman 1966). This is important because it affects the size of crystals in the ice. When large water masses are cooled slowly, there is sufficient time for heterogeneous nucleation in the area of the ice point. At that point the crystallization speed is very large so that a few nuclei grow to a large size, resulting in a coarse crystalline structure. At greater cooling speed, high supercooling occurs; this results in high nuclei formation and smaller growth rate and, therefore, a fine crystal structure.

Upon freezing, HOH molecules associate in an orderly manner to form a rigid structure that is more open (less dense) than the liquid form. There still remains considerable movement of individual atoms and molecules in ice, particularly just below the freezing point. At 10°C an HOH molecule vibrates with an amplitude of approximately 0.044 nm, nearly one-sixth the distance between adjacent HOH molecules. Hydrogen atoms may wander from one oxygen atom to another.

Each HOH molecule has four tetrahedrally spaced attractive forces and is potentially able to associate by means of hydrogen bonding with four other HOH molecules. In this arrangement each oxygen atom is bonded covalently with two hydrogen atoms, each at a distance of 0.096 nm, and each hydrogen atom is bonded with two other

hydrogen atoms, each at a distance of 0.18 nm. This results in an open tetrahedral structure with adjacent oxygen atoms spaced about 0.276 nm apart and separated by single hydrogen atoms. All bond angles are approximately 109 degrees (Figure 1-19).

Extension of the model in Figure 1-19 leads to the hexagonal pattern of ice established when several tetrahedrons are assembled (Figure 1-17).

Upon change of state from ice to water, rigidity is lost, but water still retains a large number of ice-like clusters. The term *ice-like cluster* does not imply an arrangement identical to that of crystallized ice. The HOH bond angle of water is several degrees less than that of ice, and the average distance between oxygen atoms is 0.31 nm in water and 0.276 nm in ice. Research has not yet determined whether the ice-like clusters of water exist in a tetrahedral arrangement, as they do in ice. Since the average intermolecular distance is greater than in ice, it follows

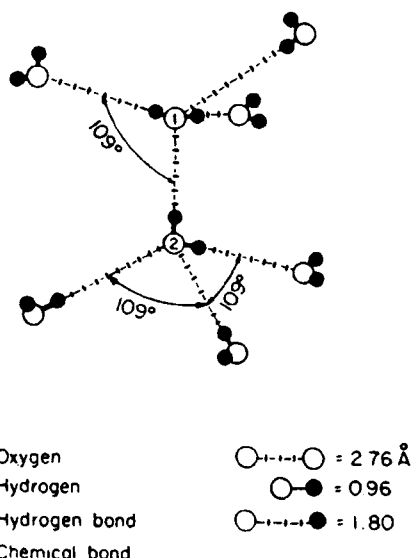

Figure 1-19 Hydrogen Bonded Arrangement of Water Molecules in Ice

that the greater density of water must be achieved by each molecule having some neighbors. A cubic structure with each HOH molecule surrounded by six others has been suggested.

At 0°C, water contains ice-like clusters averaging 90 molecules per cluster. With increasing temperature, clusters become smaller and more numerous. At 0°C, approximately half of the hydrogen bonds present at -183°C remain unbroken, and even at 100°C approximately one-third are still present. All hydrogen bonds are broken when water changes into vapor at 100°C. This explains the large heat of vaporization of water.

Crystal Growth and Nucleation

Crystal growth, in contrast to nucleation, occurs readily at temperatures close to the freezing point. It is more difficult to initiate crystallization than to continue it. The rate of ice crystal growth decreases with decreasing temperature. A schematic graphical representation of nucleation and crystal growth rates is given in Figure 1-20. Solutes of many types and in quite small amounts will greatly slow ice crystal growth. The mechanism of this action is not known. Membranes may be impermeable to ice crystal growth and thus limit crystal size. The effect of membranes on ice crystal propagation was studied by Lusena and Cook (1953), who found that membranes freely permeable to liquids may be either permeable, partly permeable, or impermeable to growing ice crystals. In a given material, permeability to ice crystal growth increases with porosity, but is also affected by rate of cooling, membrane composition and properties, and concentration of the solute(s) present in the aqueous phase. When ice crystal growth is retarded by solutes, the ice phase may become dis-

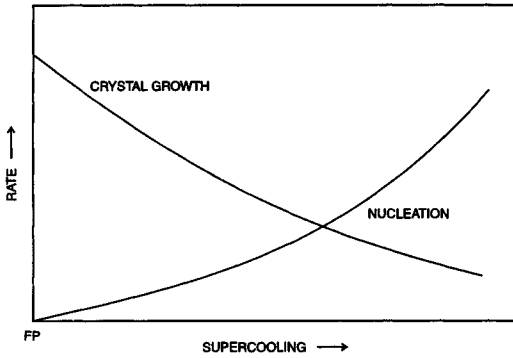

FP = temperature at which crystals start to form.

Figure 1-20 Schematic Representation of the Rate of Nucleation and Crystal Growth

continuous either by the presence of a membrane or spontaneously.

Ice crystal size at the completion of freezing is related directly to the number of nuclei. The greater the number of nuclei, the smaller the size of the crystals. In liquid systems nuclei can be added. This process is known as *seeding*. Practical applications of seeding include adding finely ground lactose to evaporated milk in the evaporator, and recirculating some portion of crystallized fat in a heat exchanger during manufacture of margarine. If the system is maintained at a temperature close to the freezing point (FP), where crystallization starts (Figure 1-20), only a few nuclei form and each crystal grows extensively. The slow removal of heat energy produces an analogous situation, since the heat of crystallization released by the few growing crystals causes the temperature to remain near the melting point, where nucleation is unlikely. In tissue or unagitated fluid systems, slow removal of heat results in a continuous ice phase that slowly moves inward, with little if any nucleation. The effect of

temperature on the linear crystallization velocity of water is given in Table 1-6.

If the temperature is lowered to below the FP (Figure 1-20), crystal growth is the predominant factor at first but, at increasing rate of supercooling, nucleation takes over. Therefore, at low supercooling large crystals are formed; as supercooling increases, many small crystals are formed. Control of crystal size is much more difficult in tissues than in agitated liquids. Agitation may promote nucleation and, therefore, reduced crystal size. Lusena and Cook (1954) suggested that large ice crystals are formed when freezing takes place above the critical nucleation temperature (close to FP in Figure 1-20). When freezing occurs at the critical nucleation temperature, small ice crystals form. The effect of solutes on nucleation and rate of ice crystal growth is a major factor controlling the pattern of propagation of the ice front. Lusena and Cook (1955) also found that solutes depress the nucleation temperature to the same extent that they depress the freezing point. Solute retard ice growth at 10°C supercooling, with organic compounds having a greater effect than inorganic ones. At low concentrations,

Table 1-6 Effect of Temperature on Linear Crystallization Velocity of Water

Temperature at Onset of Crystallization (°C)	Linear Crystallization Velocity (mm/min)
-0.9	230
-1.9	520
-2.0	580
-2.2	680
-3.5	1,220
-5.0	1,750
-7.0	2,800

proteins are as effective as alcohols and sugars in retarding crystal growth.

Once formed, crystals do not remain unchanged during frozen storage; they have a tendency to enlarge. Recrystallization is particularly evident when storage temperatures are allowed to fluctuate widely. There is a tendency for large crystals to grow at the expense of small ones.

Slow freezing results in large ice crystals located exclusively in extracellular areas. Rapid freezing results in tiny ice crystals located both extra- and intracellularly. Not too much is known about the relation between ice crystal location and frozen food quality. During the freezing of food, water is transformed to ice with a high degree of purity, and solute concentration in the unfrozen liquid is gradually increased. This is accompanied by changes in pH, ionic strength, viscosity, osmotic pressure, vapor pressure, and other properties.

When water freezes, it expands nearly 9 percent. The volume change of a food that is frozen will be determined by its water content and by solute concentration. Highly concentrated sucrose solutions do not show expansion (Table 1-7). Air spaces may partially accommodate expanding ice crystals. Volume changes in some fruit products upon freezing are shown in Table 1-8. The effect of air space is obvious. The expansion of water on freezing results in local stresses that undoubtedly produce mechanical damage in cellular materials. Freezing may cause changes in frozen foods that make the product unacceptable. Such changes may include destabilization of emulsions, flocculation of proteins, increase in toughness of fish flesh, loss of textural integrity, and increase in drip loss of meat. Ice formation can be influenced by the presence of carbohydrates. The effect of sucrose on the ice formation process

Table 1-7 Volume Change of Water and Sucrose Solutions on Freezing

Sucrose (%)	Volume Increase During Temperature Change from 70°F to 0°F (%)
0	8.6
10	8.7
20	8.2
30	6.2
40	5.1
50	3.9
60	None
70	-1.0 (decrease)

has been described by Roos and Karel (1991a,b,c).

The Glass Transition

In aqueous systems containing polymeric substances or some low molecular weight materials including sugars and other carbohydrates, lowering of the temperature may result in formation of a glass. A glass is an amorphous solid material rather than a crystalline solid. A glass is an undercooled liquid

Table 1-8 Expansion of Fruit Products During Freezing

Product	Volume Increase During Temperature Change from 70°F to 0°F (%)
Apple juice	8.3
Orange juice	8.0
Whole raspberries	4.0
Crushed raspberries	6.3
Whole strawberries	3.0
Crushed strawberries	8.2

of high viscosity that exists in a metastable solid state (Levine and Slade 1992). A glass is formed when a liquid or an aqueous solution is cooled to a temperature that is considerably lower than its melting temperature. This is usually achieved at high cooling rates. The normal process of crystallization involves the conversion of a disordered liquid molecular structure to a highly ordered crystal formation. In a crystal, atoms or ions are arranged in a regular, three-dimensional array. In the formation of a glass, the disordered liquid state is immobilized into a disordered glassy solid, which has the rheological properties of a solid but no ordered crystalline structure.

The relationships among melting point (T_m), glass transition temperature (T_g), and crystallization are schematically represented in Figure 1–21. At low degree of supercooling (just below T_m), nucleation is at a minimum and crystal growth predominates. As the degree of supercooling increases, nucleation becomes the dominating effect. The maximum overall crystallization rate is at a

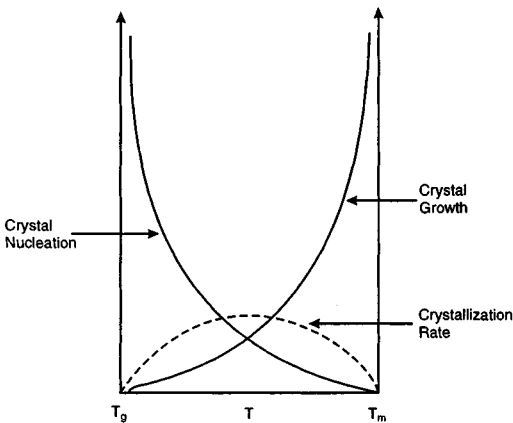

Figure 1–21 Relationships Among Crystal Growth, Nucleation, and Crystallization Rate between Melting Temperature (T_m) and Glass Temperature (T_g)

point about halfway between T_m and T_g . At high cooling rates and a degree of supercooling that moves the temperature to below T_g , no crystals are formed and a glassy solid results. During the transition from the molten state to the glassy state, the moisture content plays an important role. This is illustrated by the phase diagram of Figure 1–22. When the temperature is lowered at sufficiently high moisture content, the system goes through a rubbery state before becoming glassy (Chirife and Buera 1996). The glass transition temperature is characterized by very high apparent viscosities of more than 10^5 Ns/m² (Aguilera and Stanley 1990). The rate of diffusion limited processes is more rapid in the rubbery state than in the glassy state, and this may be important in the storage stability of certain foods. The effect of water activity on the glass transition temperature of a number of plant products (carrots, strawberries, and potatoes) as well as some biopolymers (gelatin, wheat gluten, and wheat starch) is shown in Figure 1–23 (Chirife and Buera 1996). In the rubbery state the rates of chemical reac-

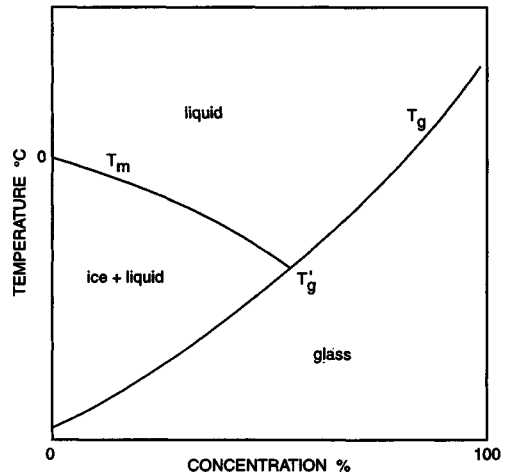

Figure 1–22 Phase Diagram Showing the Effect of Moisture Content on Melting Temperature (T_m) and Glass Transition Temperature (T_g)

tion appear to be higher than in the glassy state (Roos and Karel 1991e).

When water-containing foods are cooled below the freezing point of water, ice may be formed and the remaining water is increasingly high in dissolved solids. When the glass transition temperature is reached, the remaining water is transformed into a glass. Ice formation during freezing may destabilize sensitive products by rupturing cell walls and breaking emulsions. The presence of glass-forming substances may help prevent this from occurring. Such stabilization of frozen products is known as *cryoprotection*, and the agents are known as *cryoprotectants*.

When water is rapidly removed from foods during processes such as extrusion, drying, or freezing, a glassy state may be produced (Roos 1995). The T_g values of high molecu-

lar weight food polymers, proteins, and polysaccharides are high and cannot be determined experimentally, because of thermal decomposition. An example of measured T_g values for low molecular weight carbohydrates is given in Figure 1-24. The value of T_g for starch is obtained by extrapolation.

The water present in foods may act as a plasticizer. Plasticizers increase plasticity and flexibility of food polymers as a result of weakening of the intermolecular forces existing between molecules. Increasing water content decreases T_g . Roos and Karel (1991a) studied the plasticizing effect of water on thermal behavior and crystallization of amorphous food models. They found that dried foods containing sugars behave like amorphous materials, and that small amounts of water decrease T_g to room temperature with

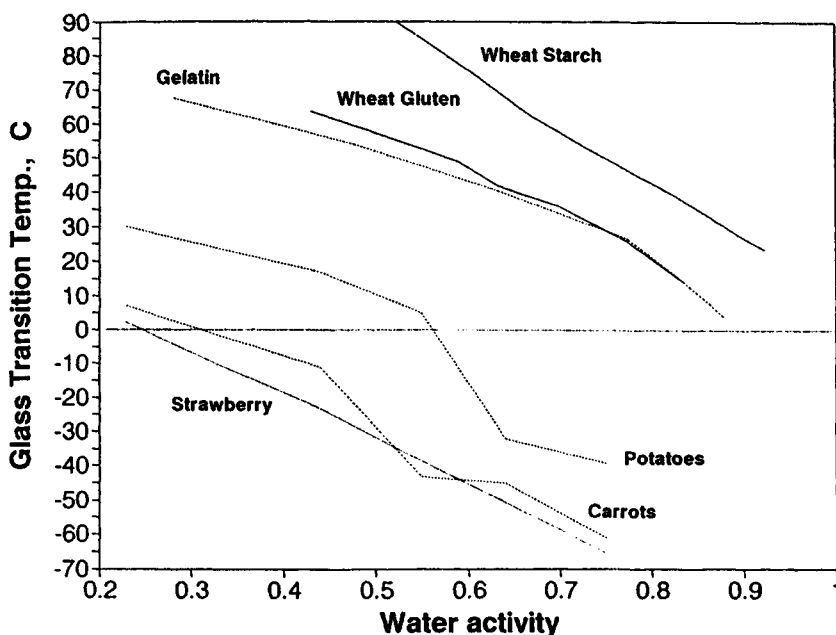

Figure 1-23 Relationship Between Water Activity (a_w) and Glass Transition Temperature (T_g) of Some Plant Materials and Biopolymers. *Source:* Reprinted with permission from J. Cherife and M. del Pinar Buera, Water Activity, Water Glass Dynamics and the Control of Microbiological Growth in Foods, *Critical Review Food Sci. Nutr.*, Vol. 36, No. 5, p. 490, © 1996. Copyright CRC Press, Boca Raton, Florida.

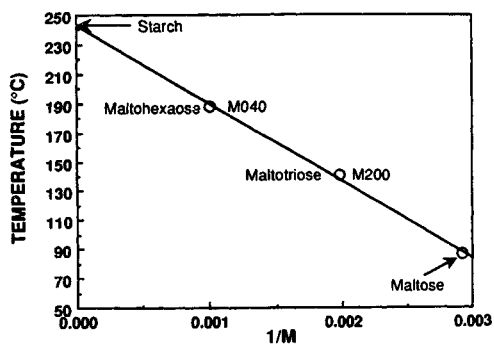

Figure 1-24 Glass Transition Temperature (T_g) for Maltose, Maltose Polymers, and Extrapolated Value for Starch. M indicates molecular weight. *Source:* Reprinted with permission from Y.H. Roos, Glass Transition-Related Physico-Chemical Changes in Foods, *Food Technology*, Vol. 49, No. 10, p. 98, © 1995, Institute of Food Technologists.

the result of structural collapse and formation of stickiness. Roos and Karel (1991e) report a linearity between water activity (a_w) and T_g in the a_w range of 0.1 to 0.8. This allows prediction of T_g at the a_w range typical of dehydrated and intermediate moisture foods.

Roos (1995) has used a combined sorption isotherm and state diagram to obtain critical water activity and water content values that result in depressing T_g to below ambient temperature (Figure 1-25). This type of plot can be used to evaluate the stability of low-moisture foods under different storage conditions. When the T_g is decreased to below ambient temperature, molecules are mobilized because of plasticization and reaction rates increase because of increased diffusion, which in turn may lead to deterioration. Roos and Himberg (1994) and Roos et al. (1996) have described how glass transition temperatures influence nonenzymatic browning in model systems. This deteriorative reaction

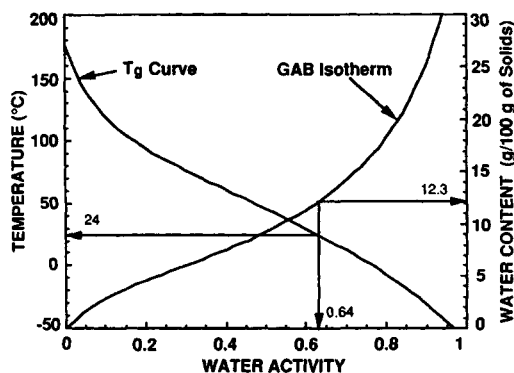

Figure 1-25 Modified State Diagram Showing Relationship Between Glass Transition Temperature (T_g), Water Activity (GAB isotherm), and Water Content for an Extruded Snack Food Model. Crispness is lost as water plasticization depresses T_g to below 24°C. Plasticization is indicated with critical values for water activity and water content. *Source:* Reprinted with permission from Y.H. Roos, Glass Transition-Related Physico-Chemical Changes in Foods, *Food Technology*, Vol. 49, No. 10, p. 99, © 1995, Institute of Food Technologists.

showed an increased reaction rate as water content increased.

Water Activity and Reaction Rate

Water activity has a profound effect on the rate of many chemical reactions in foods and on the rate of microbial growth (Labuza 1980). This information is summarized in Table 1-9. Enzyme activity is virtually nonexistent in the monolayer water (a_w between 0 and 0.2). Not surprisingly, growth of microorganisms at this level of a_w is also virtually zero. Molds and yeasts start to grow at a_w between 0.7 and 0.8, the upper limit of capillary water. Bacterial growth takes place when a_w reaches 0.8, the limit of loosely

Table 1-9 Reaction Rates in Foods as Determined by Water Activity

Reaction	Monolayer Water	Capillary Water	Loosely Bound Water
Enzyme activity	Zero	Low	High
Mold growth	Zero	Low	High
Yeast growth	Zero	Low	High
Bacterial growth	Zero	Zero	High
Hydrolysis	Zero	Rapid increase	High
Nonenzymic browning	Zero	Rapid increase	High
Lipid oxidation	High	Rapid increase	High

*Growth starts at a_w of 0.7 to 0.8.

bound water. Enzyme activity increases gradually between a_w of 0.3 and 0.8, then increases rapidly in the loosely bound water area (a_w 0.8 to 1.0). Hydrolytic reactions and nonenzymic browning do not proceed in the monolayer water range of a_w (0.0 to 0.25). However, lipid oxidation rates are high in this area, passing from a minimum at a_w 0.3 to 0.4, to a maximum at a_w 0.8. The influ-

ence of a_w on chemical reactivity has been reviewed by Leung (1987). The relationship between water activity and rates of several reactions and enzyme activity is presented graphically in Figure 1-26 (Bone 1987).

Water activity has a major effect on the texture of some foods, as Bourne (1986) has shown in the case of apples.

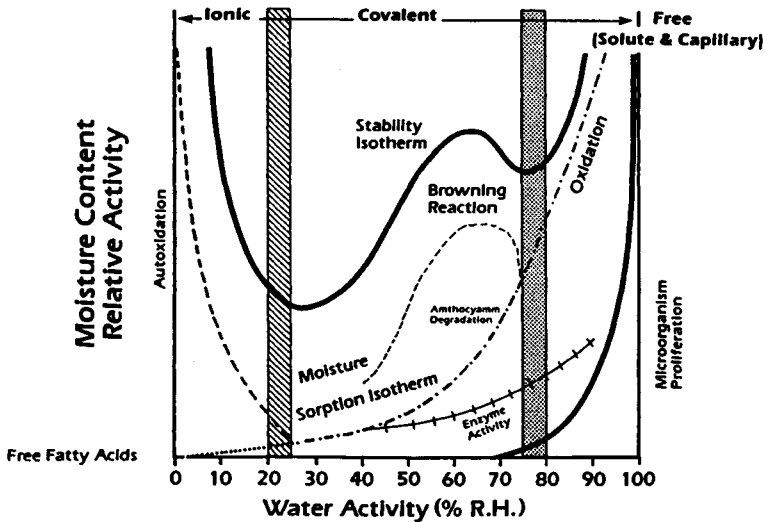

Figure 1-26 Relationship Between Water Activity and a Number of Reaction Rates. *Source:* Reprinted with permission from D.P. Bone, Practical Applications of Water Activity and Moisture Relations in Foods, in *Water Activity: Theory and Application to Food*, L.B. Rockland and L.R. Beuchat, eds., p. 387, 1987, by courtesy of Marcel Dekker, Inc.

WATER ACTIVITY AND FOOD SPOILAGE

The influence of water activity on food quality and spoilage is increasingly being recognized as an important factor (Rockland and Nishi 1980). Moisture content and water activity affect the progress of chemical and microbiological spoilage reactions in foods. Dried or freeze-dried foods, which have great storage stability, usually have water contents in the range of about 5 to 15 percent. The group of intermediate-moisture foods, such as dates and cakes, may have moisture contents in the range of about 20 to 40 percent. The dried foods correspond to the lower part of the sorption isotherms. This includes water in the monolayer and multi-layer category. Intermediate-moisture foods have water activities generally above 0.5, including the capillary water. Reduction of

water activity can be obtained by drying or by adding water-soluble substances, such as sugar to jams or salt to pickled preserves. Bacterial growth is virtually impossible below a water activity of 0.90. Molds and yeasts are usually inhibited between 0.88 and 0.80, although some osmophile yeast strains grow at water activities down to 0.65.

Most enzymes are inactive when the water activity falls below 0.85. Such enzymes include amylases, phenoloxidases, and peroxidases. However, lipases may remain active at values as low as 0.3 or even 0.1 (Loncin et al. 1968). Acker (1969) provided examples of the effect of water activity on some enzymic reactions. A mixture of ground barley and lecithin was stored at different water activities, and the rates of hydrolysis were greatly influenced by the value of a (Figure 1-27). When the lower a values were changed to 0.70 after 48 days of

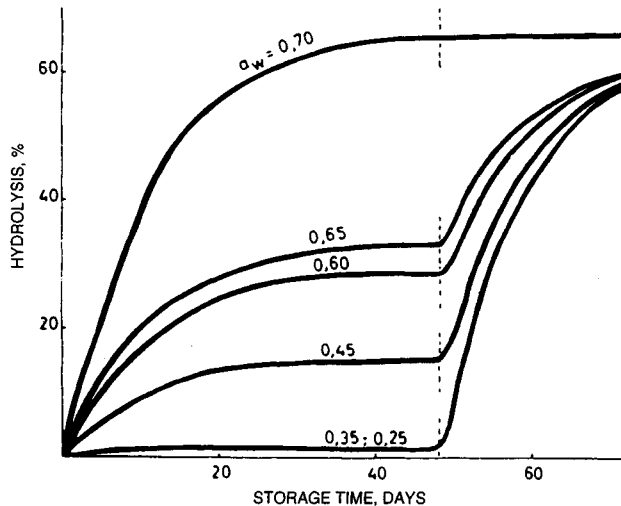

Figure 1-27 Enzymic Splitting of Lecithin in a Mixture of Barley Malt and Lecithin Stored at 30°C and Different Water Activities. Lower a_w values were changed to 0.70 after 48 days. *Source:* From L. Acker, Water Activity and Enzyme Activity, *Food Technol.*, Vol. 23, pp. 1257-1270, 1969.

storage the rates rapidly went up. In the region of monomolecular adsorption, enzymic reactions either did not proceed at all or proceeded at a greatly reduced rate, whereas in the region of capillary condensation the reaction rates increased greatly. Acker found that for reactions in which lipolytic enzyme activity was measured, the manner in which components of the food system were put into contact significantly influenced the enzyme activity. Separation of substrate and enzyme could greatly retard the reaction. Also, the substrate has to be in liquid form; for example, liquid oil could be hydrolyzed at water activity as low as 0.15, but solid fat was only slightly hydrolyzed. Oxidizing enzymes were affected by water activity in about the same way as hydrolytic enzymes, as was shown by the example of phenoloxidase from potato (Figure 1-28). When the lower a_w values were increased to 0.70 after 9 days of storage, the final values were lower than with

the sample kept at 0.70 all through the experiment, because the enzyme was partially inactive during storage.

Nonenzymic browning or Maillard reactions are one of the most important factors causing spoilage in foods. These reactions are strongly dependent on water activity and reach a maximum rate at a_w values of 0.6 to 0.7 (Loncin et al. 1968). This is illustrated by the browning of milk powder kept at 40°C for 10 days as a function of water activity (Figure 1-29). The loss in lysine resulting from the browning reaction parallels the color change, as is shown in Figure 1-30.

Labuza et al. (1970) have shown that, even at low water activities, sucrose may be hydrolyzed to form reducing sugars that may take part in browning reactions. Browning reactions are usually slow at low humidities and increase to a maximum in the range of intermediate-moisture foods. Beyond this range the rate again decreases. This behavior

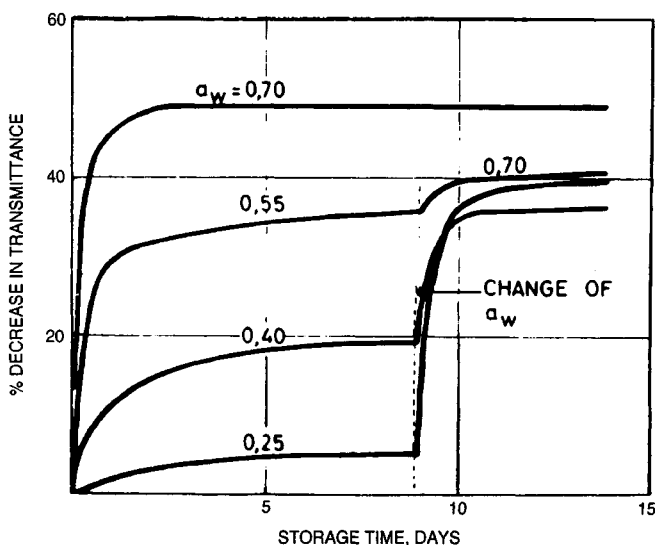

Figure 1-28 Enzymic Browning in the System Polyphenoloxidase-Cellulose-Catechol at 25°C and Different Water Activities. Lower a_w values were changed to 0.70 after 9 days. *Source:* From L. Acker, Water Activity and Enzyme Activity, *Food Technol.*, Vol. 23, pp. 1257-1270, 1969.

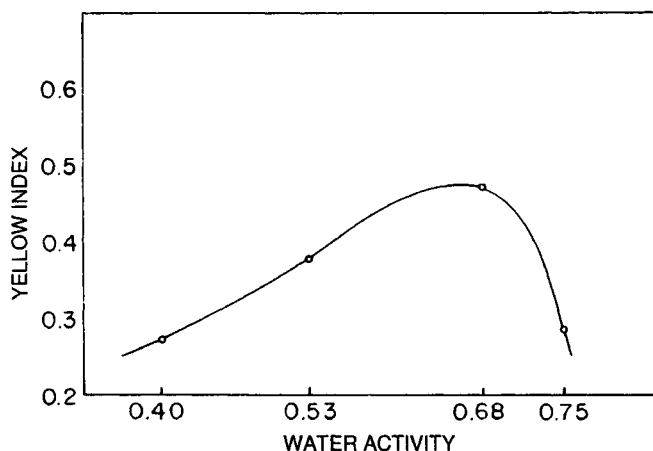

Figure 1-29 Color Change of Milk Powder Kept at 40°C for 10 Days as a Function of Water Activity

can be explained by the fact that, in the intermediate range, the reactants are all dissolved, and that further increase in moisture content leads to dilution of the reactants.

The effect of water activity on oxidation of fats is complex. Storage of freeze-dried and dehydrated foods at moisture levels above

those giving monolayer coverage appears to give maximum protection against oxidation. This has been demonstrated by Martinez and Labuza (1968) with the oxidation of lipids in freeze-dried salmon (Figure 1-31). Oxidation of the lipids was reduced as water content increased. Thus, conditions that are

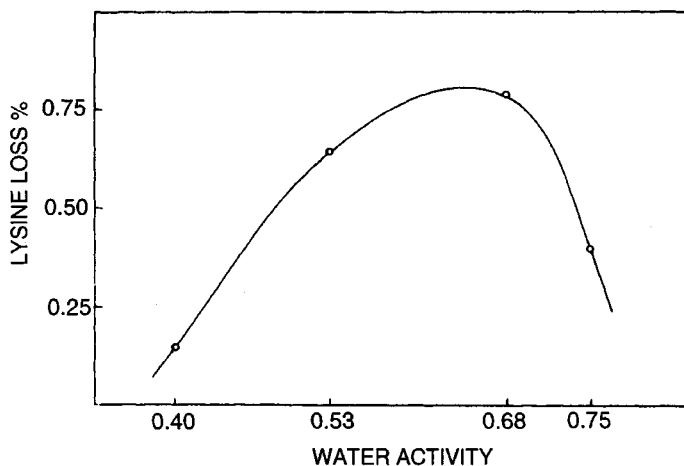

Figure 1-30 Loss of Free Lysine in Milk Powder Kept at 40°C for 10 Days as a Function of Water Activity. *Source:* From M. Loncin, J.J. Bimbenet, and J. Lenges, Influence of the Activity of Water on the Spoilage of Foodstuffs, *J. Food Technol.*, Vol. 3, pp. 131-142, 1968.

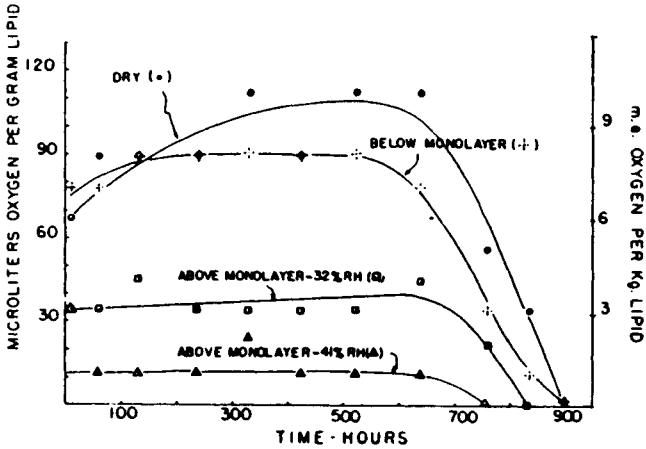

Figure 1-31 Peroxide Production in Freeze-Dried Salmon Stored at Different Relative Humidities. *Source:* From F. Martinez and T.P. Labuza, Effect of Moisture Content on Rate of Deterioration of Freeze-Dried Salmon, *J. Food Sci.*, Vol. 33, pp. 241-247, 1968.

optimal for protection against oxidation may be conducive to other spoilage reactions, such as browning.

Water activity may affect the properties of powdered dried product. Berlin et al. (1968) studied the effect of water vapor sorption on the porosity of milk powders. When the powders were equilibrated at 50 percent relative humidity (RH), the microporous structure was destroyed. The free fat content was considerably increased, which also indicates structural changes.

Other reactions that may be influenced by water activity are hydrolysis of protopectin, splitting and demethylation of pectin, autocatalytic hydrolysis of fats, and the transformation of chlorophyll into pheophytin (Loncin et al. 1968).

Rockland (1969) has introduced the concept of *local isotherm* to provide a closer relationship between sorption isotherms and stability than is possible with other methods. He suggested that the differential coefficient

of moisture with respect to relative humidity ($\Delta M/\Delta RH$), calculated from sorption isotherms, is related to product stability.

The interaction between water and polymer molecules in gel formation has been reviewed by Busk (1984).

WATER ACTIVITY AND PACKAGING

Because water activity is a major factor influencing the keeping quality of a number of foods, it is obvious that packaging can do much to maintain optimal conditions for long storage life. Sorption isotherms play an important role in the selection of packaging materials. Hygroscopic products always have a steep sorption isotherm and reach the critical area of moisture content before reaching external climatic conditions. Such foods have to be packaged in glass containers with moistureproof seals or in watertight plastic (thick polyvinylchloride). For example, consider instant coffee, where the critical area is

at about 50 percent RH. Under these conditions the product cakes and loses its flowability. Other products might not be hygroscopic and no unfavorable reactions occur at normal conditions of storage. Such products can be packaged in polyethylene containers.

There are some foods where the equilibrium relative humidity is above that of the external climatic conditions. The packaging material then serves the purpose of protecting the product from moisture loss. This is the case with processed cheese and baked goods.

Different problems may arise in composite foods, such as soup mixes, where several distinct ingredients are packaged together. In Figure 1-32, for example, substance B with the steep isotherm is more sensitive to moisture, and is mixed in equal quantities with substance A in an impermeable package.*

*The initial relative humidity of A is 65 percent and of B, 15 percent.

The initial moisture content of B is X_1 , and after equilibration with A, the moisture content is X_2 . The substances A and B will reach a mean relative humidity of about 40 percent, but not a mean moisture content. If this were a dry soup mix and the sensitive component was a freeze-dried vegetable with a moisture content of 2 percent and the other component, a starch or flour with a moisture content of 13 percent, the vegetable would be moistened to up to 9 percent. This would result in rapid quality deterioration due to nonenzymic browning reactions. In this case, the starch would have to be postdried.

Salwin and Slawson (1959) found that stability in dehydrated foods was impaired if several products were packaged together. A transfer of water could take place from items of higher moisture-vapor pressure to those of lower moisture-vapor pressure. These authors determined packaging compatibility by examining the respective sorption isotherms. They suggested a formula for calculation of the final equilibrium moisture content of each component from the iso-

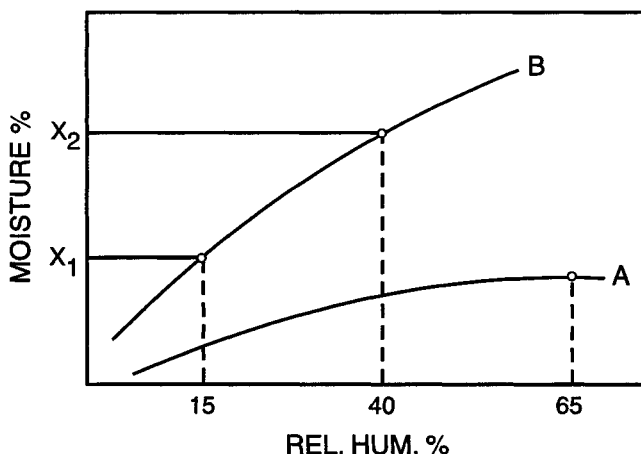

Figure 1-32 Sorption Isotherms of Materials A and B

terms of the mixed food and its equilibrium relative humidity:

$$a_w = \frac{(W_1 \cdot S_1 \cdot a_{w1}') + (W_2 \cdot S_2 \cdot a_{w2}')}{(W_1 \cdot S_1) + (W_2 \cdot S_2)}$$

where

W_1 = gram solids of ingredient 1

S_1 = linear slope of ingredient 1

a_{w1}' = initial a_w of ingredient 1

WATER BINDING OF MEAT

According to Hamm (1962), the water-binding capacity of meat is caused by the muscle proteins. Some 34 percent of these proteins are water-soluble. The main portion of meat proteins is structural material. Only about 3 percent of the total water-binding capacity of muscle can be attributed to water-soluble (plasma) proteins. The main water-binding capacity of muscle can be attributed to actomyosin, the main component of the myofibrils. The adsorption isotherm of freeze-dried meat has the shape shown in Figure 1-33. The curve is similar to the sorption isotherms of other foods and consists of three parts. The first part corresponds to the tightly bound water, about 4 percent, which is given off at very low vapor pressures. This quantity is only about one-fifth the total quantity required to cover the whole protein with a monomolecular layer. This water is bound under simultaneous liberation of a considerable amount of energy, 3 to 6 kcal per mole of water. The binding of this water results in a volume contraction of 0.05 mL per g of protein. The binding is localized at hydrophilic groups on proteins such as polar side chains having carboxyl, amino, hydroxyl, and sulphydryl groups and

also on the nondissociable carboxyl and imino groups of the peptide bonds. The binding of water is strongly influenced by the pH of meat. The effect of pH on the swelling or unswelling (that is, water-binding capacity of proteins) is schematically represented in Figure 1-34 (Honkel 1989). The second portion of the curve corresponds to multilayer adsorption, which amounts to another 4 to 6 percent of water. Hamm (1962) considered these two quantities of water to represent the real water of hydration and found them to amount to between 50 and 60 g per 100 g of protein. Muscle binds much more than this amount of water. Meat with a protein content of 20 to 22 percent contains 74 to 76 percent water, so that 100 g of protein binds about 350 to 360 g of water. This ratio is even higher in fish muscle. Most of this water is merely immobilized—retained by the net-

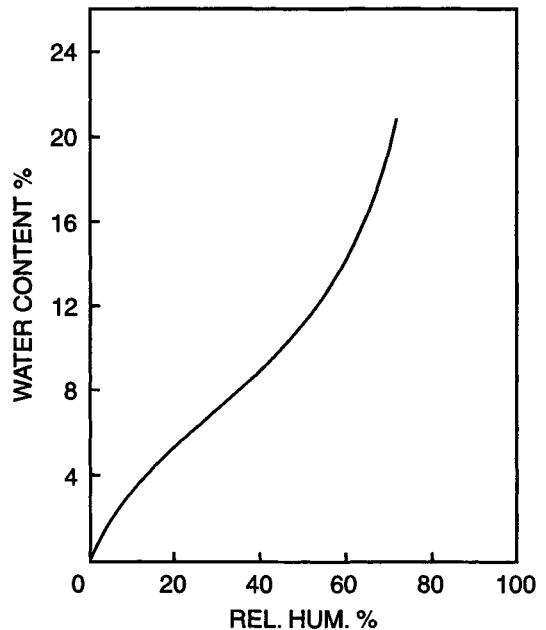

Figure 1-33 Adsorption Isotherm of Freeze-Dried Meat

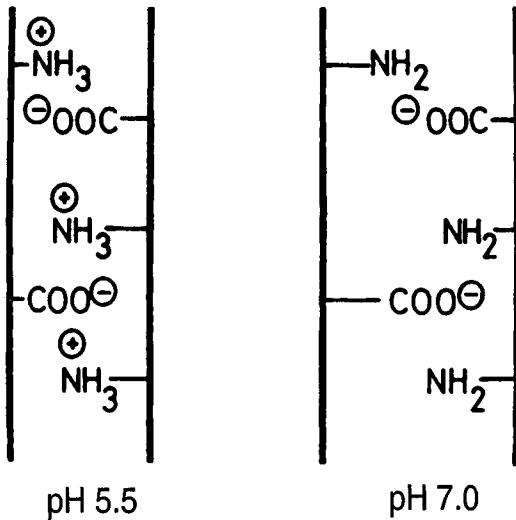

Figure 1-34 Water Binding in Meat as Influenced by pH

work of membranes and filaments of the structural proteins as well as by cross-linkages and electrostatic attractions between peptide chains. It is assumed that changes in water-binding capacity of meat during aging, storage, and processing relate to the free water and not the real water of hydration. The free water is held by a three-dimensional structure of the tissue, and shrinkage in this network leads to a decrease in immobilized water; this water is lost even by application of slight pressure. The reverse is also possible. Cut-up muscle can take up as much as 700 to 800 g of water per 100 g of protein at certain pH values and in the presence of certain ions. Immediately after slaughter there is a drop in hydration and an increase in rigidity of muscle with time. The decrease in hydration was attributed at about two-thirds to decomposition of ATP and at about one-third to lowering of the pH.

Hamm (1959a, 1959b) has proposed that during the first hour after slaughter, bivalent metal ions of muscle are incorporated into the muscle proteins at pH 6, causing a contraction of the fiber network and a dehydration of the tissue. Further changes in hydration during aging for up to seven days can be explained by an increase in the number of available carboxyl and basic groups. These result from proteolysis. Hamm and Deatherage (1960a) found that freeze-drying of beef results in a decrease in water-binding capacity in the isoelectric pH range of the muscle. The proteins form a tighter network, which is stabilized by the formation of new salt and/or hydrogen bonds. Heating beef at temperatures over 40°C leads to strong denaturation and changes in hydration (Hamm and Deatherage 1960b). Quick freezing of beef results in a significant but small increase in the water-holding capacity, whereas slow freezing results in a significant but small decrease in water binding. These effects were thought to result from the mechanical action of ice crystals (Deatherage and Hamm 1960). The influence of heating on water binding of pork was studied by Sherman (1961b), who also investigated the effect of the addition of salts on water binding (Sherman 1961a). Water binding can be greatly affected by addition of certain salts, especially phosphates (Hellendoorn 1962). Such salt additions are used to diminish cooking losses by expulsion of water in canning hams and to obtain a better structure and consistency in manufacturing sausages. Recently, the subject of water binding has been greatly extended in scope (Katz 1997). Water binding is related to the use of water as a plasticizer and the interaction of water with the components of mixed food systems. Retaining water in mixed food systems throughout their shelf life is becoming an important

requirement in foods of low fat content. Such foods often have fat replacer ingredients based on proteins or carbohydrates, and their interaction with water is of great importance.

WATER ACTIVITY AND FOOD PROCESSING

Water activity is one of the criteria for establishing good manufacturing practice (GMP) regulations governing processing requirements and classification of foods (Johnston and Lin 1987). As indicated in Figure 1-35, the process requirements for

foods are governed by a_w and pH; a_w controlled foods are those with pH greater than 4.6 and a_w less than 0.85. At pH less than 4.6 and a_w greater than 0.85, foods fall into the category of low-acid foods; when packaged in hermetically sealed containers, these foods must be processed to achieve commercially sterile conditions.

Intermediate moisture foods are in the a_w range of 0.90 to 0.60. They can achieve stability by a combination of a_w with other factors, such as pH, heat, preservatives, and E_h (equilibrium relative humidity).

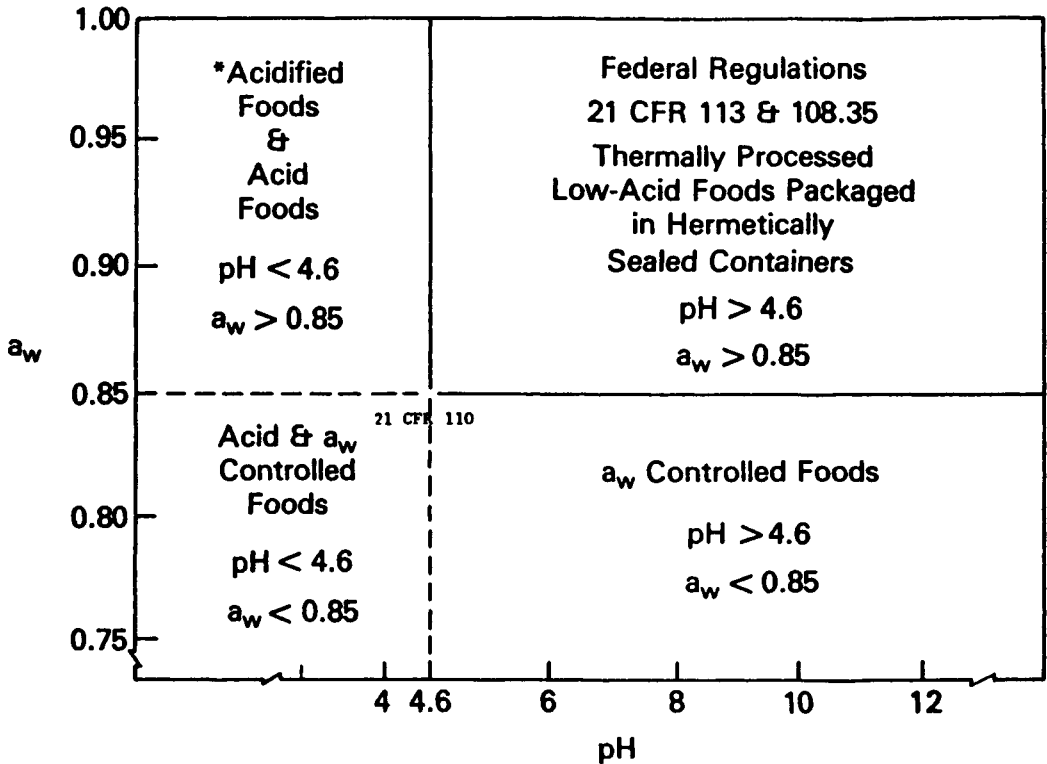

*Acidified Foods – 21 CFR 114 & 108.25

Figure 1-35 The Importance of pH and a_w on Processing Requirements for Foods. *Source:* Reprinted with permission from M.R. Johnston and R.C. Lin, FDA Views on the Importance of a_w in Good Manufacturing Practice, *Water Activity: Theory and Application to Food*, L.B. Rockland and L.R. Beuchat, eds., p. 288, 1987, by courtesy of Marcel Dekker, Inc.

REFERENCES

- Acker, L. 1969. Water activity and enzyme activity. *Food Technol.* 23: 1257-1270.
- Aguilera, J.M., and D.W. Stanley. 1990. *Microstructural principles of food processing and engineering*. London: Elsevier Applied Science.
- Berlin, E., B.A. Anderson, and M.J. Pallansch. 1968. Effect of water vapor sorption on porosity of dehydrated dairy products. *J. Dairy Sci.* 51: 668-672.
- Bone, D.P. 1987. Practical applications of water activity and moisture relations in foods. In *Water activity: Theory and application to food*, ed. L.B. Rockland and L.R. Beuchat. New York: Marcel Dekker, Inc.
- Bourne, M.C. 1986. Effect of water activity on texture profile parameters of apple flesh. *J. Texture Studies* 17: 331-340.
- Brunauer, S., P.J. Emmett, and E. Teller. 1938. Absorption of gasses in multimolecular layers. *J. Am. Chem. Soc.* 60: 309-319.
- Bushuk, W., and C.A. Winkler. 1957. Sorption of water vapor on wheat flour, starch and gluten. *Cereal Chem.* 34: 73-86.
- Busk Jr., G.C. 1984. Polymer-water interactions in gelation. *Food Technol.* 38: 59-64.
- Chirife, J., and M.P. Buera. 1996. A critical review of the effect of some non-equilibrium situations and glass transitions on water activity values of food in the microbiological growth range. *J. Food Eng.* 25: 531-552.
- Deatherage, F.E., and R. Hamm. 1960. Influence of freezing and thawing on hydration and charges of the muscle proteins. *Food Res.* 25: 623-629.
- Hamm, R. 1959a. The biochemistry of meat aging. I. Hydration and rigidity of beef muscle (In German). *Z. Lebensm. Unters. Forsch.* 109: 113-121.
- Hamm, R. 1959b. The biochemistry of meat aging. II. Protein charge and muscle hydration (In German). *Z. Lebensm. Unters. Forsch.* 109: 227-234.
- Hamm, R. 1962. The water binding capacity of mammalian muscle. VII. The theory of water binding (In German). *Z. Lebensm. Unters. Forsch.* 116: 120-126.
- Hamm, R., and F.E. Deatherage. 1960a. Changes in hydration and charges of muscle proteins during heating of meat. *Food Res.* 25: 573-586.
- Hamm, R., and F.E. Deatherage. 1960b. Changes in hydration, solubility and charges of muscle proteins during heating of meat. *Food Res.* 25: 587-610.
- Hellendoorn, E.W. 1962. Water binding capacity of meat as affected by phosphates. *Food Technol.* 16: 119-124.
- Honkel, K.G. 1989. The meat aspects of water and food quality. In *Water and food quality*, ed. T.M. Hardman. New York: Elsevier Applied Science.
- Johnston, M.R., and R.C. Lin. 1987. FDA views on the importance of a_w in good manufacturing practice. In *Water activity: Theory and application to food*, ed. L.B. Rockland and L.R. Beuchat. New York: Marcel Dekker, Inc.
- Jouppila, K., and Y.H. Roos. 1994. The physical state of amorphous corn starch and its impact on crystallization. *Carbohydrate Polymers.* 32: 95-104.
- Kapsalis, J.G. 1987. Influences of hysteresis and temperature on moisture sorption isotherms. In *Water activity: Theory and application to food*, ed. L.B. Rockland and L.R. Beuchat. New York: Marcel Dekker, Inc.
- Katz, F. 1997. The changing role of water binding. *Food Technol.* 51, no. 10: 64.
- Klotz, I.M. 1965. Role of water structure in macromolecules. *Federation Proc.* 24: S24-S33.
- Labuza, T.P. 1968. Sorption phenomena in foods. *Food Technol.* 22: 263-272.
- Labuza, T.P. 1980. The effect of water activity on reaction kinetics of food deterioration. *Food Technol.* 34, no. 4: 36-41, 59.
- Labuza, T.P., S.R. Tannenbaum, and M. Karel. 1970. Water content and stability of low-moisture and intermediate-moisture foods. *Food Technol.* 24: 543-550.
- Landolt-Boernstein. 1923. In *Physical-chemical tables* (In German), ed. W.A. Roth and K. Sheel. Berlin: Springer Verlag.
- Leung, H.K. 1987. Influence of water activity on chemical reactivity. In *Water activity: Theory and application to food*, ed. L.B. Rockland and L.R. Beuchat. New York: Marcel Dekker, Inc.
- Levine, H., and L. Slade. 1992. Glass transitions in foods. In *Physical chemistry of foods*. New York: Marcel Dekker, Inc.
- Loncin, M., J.J. Bimbenet, and J. Lenges. 1968. Influence of the activity of water on the spoilage of food-stuffs. *J. Food Technol.* 3: 131-142.
- Lusena, C.V., and W.H. Cook. 1953. Ice propagation in systems of biological interest. I. Effect of mem-

- branes and solutes in a model cell system. *Arch. Biochem. Biophys.* 46: 232–240.
- Lusena, C.V., and W.H. Cook. 1954. Ice propagation in systems of biological interest. II. Effect of solutes at rapid cooling rates. *Arch. Biochem. Biophys.* 50: 243–251.
- Lusena, C.V., and W.H. Cook. 1955. Ice propagation in systems of biological interest. III. Effect of solutes on nucleation and growth of ice crystals. *Arch. Biochem. Biophys.* 57: 277–284.
- Martinez, F., and T.P. Labuza. 1968. Effect of moisture content on rate of deterioration of freeze-dried salmon. *J. Food Sci.* 33: 241–247.
- Meryman, H.T. 1966. *Cryobiology*. New York: Academic Press.
- Pauling, L. 1960. *The nature of the chemical bond*. Ithaca, NY: Cornell University Press.
- Perry, J.H. 1963. *Chemical engineers' handbook*. New York: McGraw Hill.
- Riedel, L. 1959. Calorimetric studies of the freezing of white bread and other flour products. *Kältetechn.* 11: 41–46.
- Rockland, L.B. 1969. Water activity and storage stability. *Food Technol.* 23: 1241–1251.
- Rockland, L.B., and S.K. Nishi. 1980. Influence of water activity on food product quality and stability. *Food Technol.* 34, no. 4: 42–51, 59.
- Roos, Y.H. 1993. Water activity and physical state effects on amorphous food stability. *J. Food Process Preserv.* 16: 433–447
- Roos, Y.H. 1995. Glass transition-related physicochemical changes in foods. *Food Technol.* 49, no. 10: 97–102.
- Roos, Y.H., and M.J. Himberg. 1994. Nonenzymatic browning behavior, as related to glass transition of a food model at chilling temperatures. *J. Agr. Food Chem.* 42: 893–898.
- Roos, Y.H., K. Jouppila, and B. Zielasko. 1996. Nonenzymatic browning-induced water plasticization. *J. Thermal. Anal.* 47: 1437–1450.
- Roos, Y.H., and M. Karel. 1991a. Amorphous state and delayed ice formation in sucrose solutions. *Int. J. Food Sci. Technol.* 26: 553–566.
- Roos, Y.H., and M. Karel. 1991b. Non equilibrium ice formation in carbohydrate solutions. *Cryo-Letters.* 12: 367–376.
- Roos, Y.H., and M. Karel. 1991c. Phase transition of amorphous sucrose and frozen sucrose solutions. *J. Food Sci.* 56: 266–267.
- Roos, Y., and M. Karel. 1991d. Plasticizing effect of water on thermal behaviour and crystallization of amorphous food models. *J. Food Sci.* 56: 38–43.
- Roos, Y., and M. Karel. 1991e. Water and molecular weight effects on glass transitions in amorphous carbohydrates and carbohydrate solutions. *J. Food Sci.* 56: 1676–1681.
- Salwin, H., and V. Slawson. 1959. Moisture transfer in combinations of dehydrated foods. *Food Technol.* 13: 715–718.
- Saravacos, G.D. 1967. Effect of the drying method on the water sorption of dehydrated apple and potato. *J. Food Sci.* 32: 81–84.
- Sherman, P. 1961a. The water binding capacity of fresh pork. I. The influence of sodium chloride, pyrophosphate and polyphosphate on water absorption. *Food Technol.* 15: 79–87.
- Sherman, P. 1961b. The water binding capacity of fresh pork. III. The influence of cooking temperature on the water binding capacity of lean pork. *Food Technol.* 15: 90–94.
- Speedy, R.J. 1984. Self-replicating structures in water. *J. Phys. Chem.* 88: 3364–3373.
- van den Berg, C., and S. Bruin. 1981. Water activity and its estimation in food systems: Theoretical aspects. In *Water activity—Influences on food quality*, ed. L.B. Rockland and G.F. Steward. New York: Academic Press.
- VandenTempel, M. 1958. Rheology of plastic fats. *Rheol. Acta* 1: 115–118.
- Wierbicki, E., and F.E. Deatherage. 1958. Determination of water-holding capacity of fresh meats. *J. Agr. Food Chem.* 6: 387–392.

Lipids

INTRODUCTION

It has been difficult to provide a definition for the class of substances called lipids. Early definitions were mainly based on whether the substance is soluble in organic solvents like ether, benzene, or chloroform and is not soluble in water. In addition, definitions usually emphasize the central character of the fatty acids—that is, whether lipids are actual or potential derivatives of fatty acids. Every definition proposed so far has some limitations. For example, monoglycerides of the short-chain fatty acids are undoubtedly lipids, but they would not fit the definition on the basis of solubility because they are more soluble in water than in organic solvents. Instead of trying to find a definition that would include all lipids, it is better to provide a scheme describing the lipids and their components, as Figure 2–1 shows. The basic components of lipids (also called *derived lipids*) are listed in the central column with the fatty acids occupying the prominent position. The left column lists the lipids known as phospholipids. The right column of the diagram includes the compounds most important from a quantitative standpoint in foods. These are mostly esters of fatty acids and glycerol. Up to 99 percent of the lipids in plant and animal

material consist of such esters, known as fats and oils. Fats are solid at room temperature, and oils are liquid.

The fat content of foods can range from very low to very high in both vegetable and animal products, as indicated in Table 2–1. In nonmodified foods, such as meat, milk, cereals, and fish, the lipids are mixtures of many of the compounds listed in Figure 2–1, with triglycerides making up the major portion. The fats and oils used for making fabricated foods, such as margarine and shortening, are almost pure triglyceride mixtures. Fats are sometimes divided into visible and invisible fats. In the United States, about 60 percent of total fat and oil consumed consists of invisible fats—that is, those contained in dairy products (excluding butter), eggs, meat, poultry, fish, fruits, vegetables, and grain products. The visible fats, including lard, butter, margarine, shortening, and cooking oils, account for 40 percent of total fat intake. The interrelationship of most of the lipids is represented in Figure 2–1. A number of minor components, such as hydrocarbons, fat-soluble vitamins, and pigments are not included in this scheme.

Fats and oils may differ considerably in composition, depending on their origin. Both fatty acid and glyceride composition may

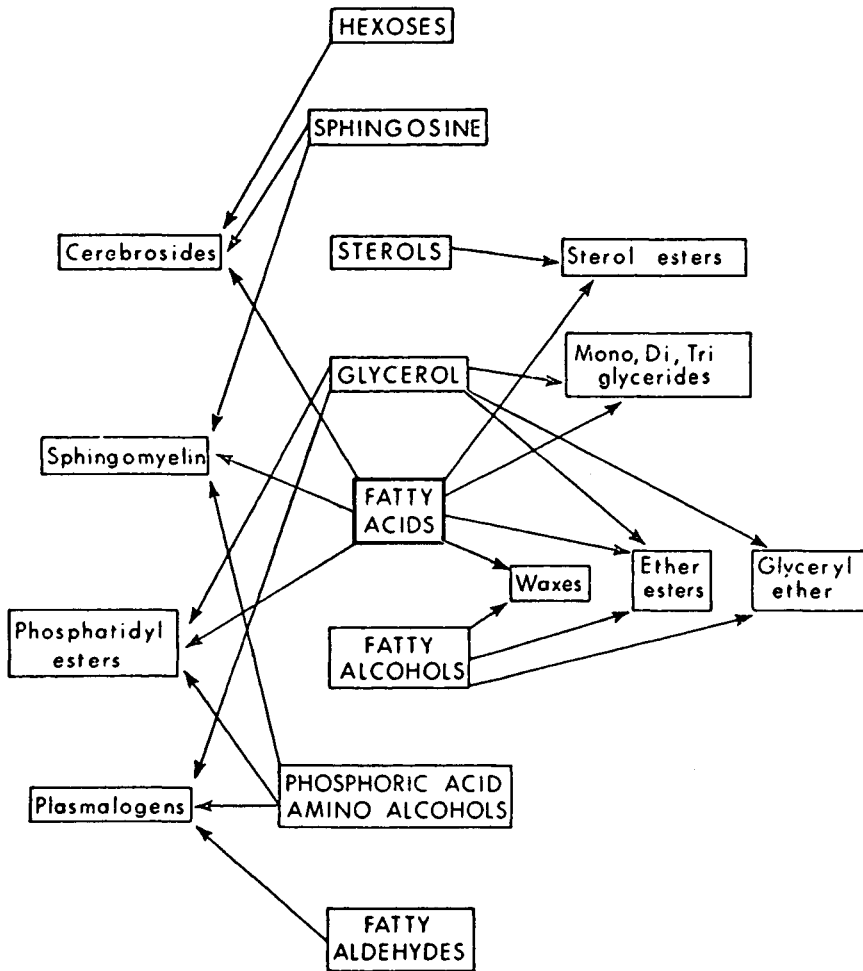

Figure 2-1 Interrelationship of the Lipids

result in different properties. Fats and oils can be classified broadly as of animal or vegetable origin. Animal fats can be further subdivided into mammal depot fat (lard and tallow) and milk fat (mostly ruminant) and marine oils (fish and whale oil). Vegetable oils and fats can be divided into seed oils (such as soybean, canola), fruit coat fats (palm and olive oils), and kernel oils (coco-nut and palm kernel).

The scientific name for esters of glycerol and fatty acids is acylglycerols. Triacylglycerols, diacylglycerols, and monoacylglycerols have three, two, or one fatty acid ester linkages. The common names for these compounds are glycerides, triglycerides, diglycerides, and monoglycerides. The scientific and common names are used interchangeably in the literature, and this practice is followed in this book.

Table 2-1 Fat Contents of Some Foods

<i>Product</i>	<i>Fat (%)</i>
Asparagus	0.25
Oats	4.4
Barley	1.9
Rice	1.4
Walnut	58
Coconut	34
Peanut	49
Soybean	17
Sunflower	28
Milk	3.5
Butter	80
Cheese	34
Hamburger	30
Beef cuts	10-30
Chicken	7
Ham	31
Cod	0.4
Haddock	0.1
Herring	12.5

SHORTHAND DESCRIPTION OF FATTY ACIDS AND GLYCERIDES

To describe the composition of fatty acids it is sometimes useful to use a shorthand designation. In this convention the composition of a fatty acid can be described by two numbers separated by a colon. The first number indicates the number of carbon atoms in the fatty acid chain, the second number indicates the number of double bonds. Thus, 4:0 is short for butyric acid, 16:0 for palmitic acid, 18:1 for oleic acid, etc. The two numbers provide a complete description of a saturated fatty acid. For unsaturated fatty acids, information about the location of double bonds and their stereo isomers can be given as follows: oleic acid (the *cis* isomer) is 18:1*c*9; elaidic acid (the

trans isomer) is 18:1*t*9. The numbering of carbon atoms in fatty acids starts normally with the carboxyl carbon as number one. In some cases polyunsaturated fatty acids are numbered starting at the methyl end; for instance, linoleic acid is represented as 18:2*n*-6 and linolenic acid 18:3*n*-3. These symbols indicate straight-chain, 18-carbon fatty acids with two and three methylene interrupted *cis* double bonds that start at the sixth and third carbon from the methyl end, respectively. These have also been described as ω 6 and ω 3. The reason for this type of description is that the members of each group *n*-6 or *n*-3 are related biosynthetically through processes involving desaturation, chain elongation, and chain shortening (Gunstone 1986) (Figure 2-2).

Triglycerides can be abbreviated by using the first letters of the common names of the component fatty acids. SSS indicates tristearin, PPP tripalmitin, and SOS a triglyceride with two palmitic acid residues in the 1 and 3 positions and oleic acid in the 2 position. In some cases, glyceride compositions are discussed in terms of saturated and unsaturated component fatty acids. In this case, S and U are used and glycerides would be indicated as SSS for trisaturated glyceride and SUS for a glyceride with an unsaturated fatty acid in the 2 position. In other cases, the total number of carbon atoms in a glyceride is important, and this can be shortened to glycerides with carbon numbers 54, 52, and so on. A glyceride with carbon number 54 could be made up of three fatty acids with 18 carbons, most likely to happen if the glyceride originated from one of the seed oils. A glyceride with carbon number 52 could have two component fatty acids with 18 carbons and one with 16 carbons. The carbon number does not give any information about saturation and unsaturation.

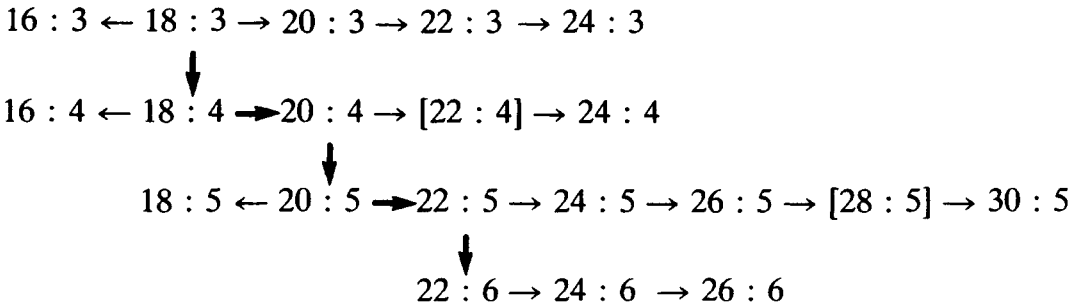

Figure 2-2 The *n*-3 Family Polyunsaturated Fatty Acids Based on Linolenic Acid. The heavy arrows show the relationship between the most important *n*-3 acids through desaturation (vertical arrows) and chain elongation (horizontal arrows)

COMPONENT FATTY ACIDS

Even-numbered, straight-chain saturated and unsaturated fatty acids make up the greatest proportion of the fatty acids of natural fats. However, it is now known that many other fatty acids may be present in small amounts. Some of these include odd carbon number acids, branched-chain acids, and hydroxy acids. These may occur in natural fats (products that occur in nature), as well as in processed fats. The latter category may, in addition, contain a variety of isomeric fatty acids not normally found in natural fats. It is customary to divide the fatty acids into different groups, for example, into saturated and unsaturated ones. This particular division is useful in food technology because saturated fatty acids have a much higher melting point than unsaturated ones, so the ratio of saturated fatty acids to unsaturated ones significantly affects the physical properties of a fat or oil. Another common division is into short-chain, medium-chain, and long-chain fatty acids. Unfortunately, there is no generally accepted division of these groups. Gen-

erally, short-chain fatty acids have from 4 to 10 carbon atoms; medium-chain fatty acids, 12 or 14 carbon atoms; and long-chain fatty acids, 16 or more carbon atoms. However, some authors use the terms long- and short-chain fatty acid in a strictly relative sense. In a fat containing fatty acids with 16 and 18 carbon atoms, the 16 carbon acid could be called the *short-chain* fatty acid. Yet another division differentiates between essential and nonessential fatty acids.

Some of the more important saturated fatty acids are listed with their systematic and common names in Table 2-2, and some of the unsaturated fatty acids are listed in Table 2-3. The naturally occurring unsaturated fatty acids in fats are almost exclusively in the *cis*-form (Figure 2-3), although *trans*-acids are present in ruminant milk fats and in catalytically hydrogenated fats. In general, the following outline of fatty acid composition can be given:

- *Depot fats* of higher land animals consist mainly of palmitic, oleic, and stearic acid and are high in saturated fatty acids.

Table 2-2 Saturated Even- and Odd-Carbon Numbered Fatty Acids

<i>Systematic Name</i>	<i>Common Name</i>	<i>Formula</i>	<i>Shorthand Description</i>
<i>n</i> -Butanoic	Butyric	CH ₃ ·(CH ₂) ₂ ·COOH	4:0
<i>n</i> -Hexanoic	Caproic	CH ₃ ·(CH ₂) ₄ ·COOH	6:0
<i>n</i> -Octanoic	Caprylic	CH ₃ ·(CH ₂) ₆ ·COOH	8:0
<i>n</i> -Decanoic	Capric	CH ₃ ·(CH ₂) ₈ ·COOH	10:0
<i>n</i> -Dodecanoic	Lauric	CH ₃ ·(CH ₂) ₁₀ ·COOH	12:0
<i>n</i> -Tetradecanoic	Myristic	CH ₃ ·(CH ₂) ₁₂ ·COOH	14:0
<i>n</i> -Hexadecanoic	Palmitic	CH ₃ ·(CH ₂) ₁₄ ·COOH	16:0
<i>n</i> -Octadecanoic	Stearic	CH ₃ ·(CH ₂) ₁₆ ·COOH	18:0
<i>n</i> -Eicosanoic	Arachidic	CH ₃ ·(CH ₂) ₁₈ ·COOH	20:0
<i>n</i> -Docosanoic	Behenic	CH ₃ ·(CH ₂) ₂₀ ·COOH	22:0
<i>n</i> -Pentanoic	Valeric	CH ₃ ·(CH ₂) ₃ ·COOH	5:0
<i>n</i> -Heptanoic	Enanthic	CH ₃ ·(CH ₂) ₅ ·COOH	7:0
<i>n</i> -Nonanoic	Pelargonic	CH ₃ ·(CH ₂) ₇ ·COOH	9:0
<i>n</i> -Undecanoic	—	CH ₃ ·(CH ₂) ₉ ·COOH	11:0
<i>n</i> -Tridecanoic	—	CH ₃ ·(CH ₂) ₁₁ ·COOH	13:0
<i>n</i> -Pentadecanoic	—	CH ₃ ·(CH ₂) ₁₃ ·COOH	15:0
<i>n</i> -Heptadecanoic	Margaric	CH ₃ ·(CH ₂) ₁₅ ·COOH	17:0

The total content of acids with 18 carbon atoms is about 70 percent.

- *Ruminant milk fats* are characterized by a much greater variety of component fatty acids. Lower saturated acids with 4 to 10 carbon atoms are present in relatively large amounts. The major fatty acids are palmitic, oleic, and stearic.
- *Marine oils* also contain a wide variety of fatty acids. They are high in unsaturated fatty acids, especially those unsaturated acids with long chains containing 20 or 22 carbons or more. Several of these fatty acids, including eicosapentaenoic acid (EPA) and docosahexaenoic acid (DHA), have recently re-

ceived a good deal of attention because of biomedical interest (Ackman 1988b).

- *Fruit coat fats* contain mainly palmitic, oleic, and sometimes linoleic acids.
- *Seedfats* are characterized by low contents of saturated fatty acids. They contain palmitic, oleic, linoleic, and linolenic acids. Sometimes unusual fatty acids may be present, such as erucic acid in rapeseed oil. Recent developments in plant breeding have made it possible to change the fatty acid composition of seed oils dramatically. Rapeseed oil in which the erucic acid has been replaced by oleic acid is known as canola oil. Low linolenic acid soybean oil can be obtained, as

Table 2-3 Unsaturated Fatty Acids

Systematic Name	Common Name	Formula	Shorthand Description
Dec-9-enoic		$\text{CH}_2=\text{CH}\cdot(\text{CH}_2)_7\cdot\text{COOH}$	10:1
Dodec-9-enoic		$\text{CH}_3\cdot\text{CH}_2\cdot\text{CH}=\text{CH}\cdot(\text{CH}_2)_7\cdot\text{COOH}$	12:1
Tetradec-9-enoic	Myristoleic	$\text{CH}_3\cdot(\text{CH}_2)_3\cdot\text{CH}=\text{CH}\cdot(\text{CH}_2)_7\cdot\text{COOH}$	14:1
Hexadec-9-enoic	Palmitoleic	$\text{CH}_3\cdot(\text{CH}_2)_5\cdot\text{CH}=\text{CH}\cdot(\text{CH}_2)_7\cdot\text{COOH}$	16:1
Octadec-6-enoic	Petroselinic	$\text{CH}_3\cdot(\text{CH}_2)_{10}\cdot\text{CH}=\text{CH}\cdot(\text{CH}_2)_4\cdot\text{COOH}$	18:1
Octadec-9-enoic	Oleic	$\text{CH}_3\cdot(\text{CH}_2)_7\cdot\text{CH}=\text{CH}\cdot(\text{CH}_2)_7\cdot\text{COOH}$	18:1
Octadec-11-enoic	Vaccenic	$\text{CH}_3\cdot(\text{CH}_2)_5\cdot\text{CH}=\text{CH}\cdot(\text{CH}_2)_9\cdot\text{COOH}$	18:1
Octadeca-9:12-dienoic	Linoleic	$\text{CH}_3\cdot(\text{CH}_2)_4\cdot(\text{CH}=\text{CH}\cdot\text{CH}_2)_2\cdot(\text{CH}_2)_6\cdot\text{COOH}$	18:2 ω 6
Octadeca-9:12:15-trienoic	Linolenic	$\text{CH}_3\cdot\text{CH}_2\cdot(\text{CH}=\text{CH}\cdot\text{CH}_2)_3\cdot(\text{CH}_2)_6\cdot\text{COOH}$	18:3 ω 3
Octadeca-6:9:12-trienoic	γ -Linolenic	$\text{CH}_3\cdot(\text{CH}_2)_4\cdot(\text{CH}=\text{CH}\cdot\text{CH}_2)_3\cdot(\text{CH}_2)_3\cdot\text{COOH}$	18:3 ω 6
Octadeca-9:11:13-trienoic	Elaeostearic	$\text{CH}_3\cdot(\text{CH}_2)_3\cdot(\text{CH}=\text{CH})_3\cdot(\text{CH}_2)_7\cdot\text{COOH}$	20:3
Eicos-9-enoic	Gadoleic	$\text{CH}_3\cdot(\text{CH}_2)_9\cdot\text{CH}=\text{CH}\cdot(\text{CH}_2)_7\cdot\text{COOH}$	20:1
Eicosa-5:8:11:14-tetraenoic	Arachidonic	$\text{CH}_3\cdot(\text{CH}_2)_4\cdot(\text{CH}=\text{CH}\cdot\text{CH}_2)_4\cdot(\text{CH}_2)_2\cdot\text{COOH}$	20:4 ω 6
Eicosa-5:8:11:14:17-pentaenoic acid	EPA	$\text{CH}_3\cdot\text{CH}_2\cdot(\text{CH}=\text{CH}\cdot\text{CH}_2)_5\cdot(\text{CH}_2)_2\cdot\text{COOH}$	20:5 ω 3
Docos-13-enoic	Erucic	$\text{CH}_3\cdot(\text{CH}_2)_7\cdot\text{CH}=\text{CH}\cdot(\text{CH}_2)_{11}\cdot\text{COOH}$	22:1
Docosa-4:7:10:13:16:19-hexaenoic acid	DHA	$\text{CH}_3\cdot\text{CH}_2(\text{CH}=\text{CH}\cdot\text{CH}_2)_6\cdot(\text{CH}_2)\cdot\text{COOH}$	22:6 ω 3

can sunflower and linseed oils with more desirable fatty acid composition.

The depot fats of higher land animals, especially mammals, have relatively simple fatty acid composition. The fats of birds are somewhat more complex. The fatty acid compositions of the major food fats of this

group are listed in Table 2-4. The kind of feed consumed by the animals may greatly influence the composition of the depot fats. Animal depot fats are characterized by the presence of 20 to 30 percent palmitic acid, a property shared by human depot fat. Many of the seed oils, in contrast, are very low in palmitic acid. The influence of food con-

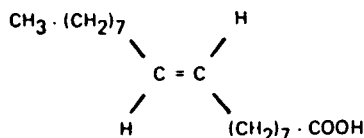
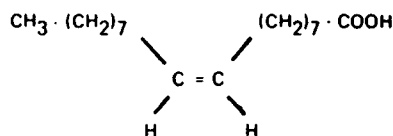

Figure 2-3 Structures of Octadec-*cis*-9-Enoic Acid (Oleic Acid) and Octadec-*trans*-9-Enoic Acid (Elaidic Acid)

Table 2-4 Component Fatty Acids of Animal Depot Fats

Animal	Fatty Acids Wt %						
	14:0	16:0	16:1	18:0	18:1	18:2	18:3
Pig	1	24	3	13	41	10	1
Beef	4	25	5	19	36	4	Trace
Sheep	3	21	2	25	34	5	3
Chicken	1	24	6	6	40	17	1
Turkey	1	20	6	6	38	24	2

sumption applies equally for the depot fat of chicken and turkey (Marion et al. 1970; Jen et al. 1971). The animal depot fats are generally low in polyunsaturated fatty acids. The iodine value of beef fat is about 50 and of lard about 60. Iodine value is generally used in the food industry as a measure of total unsaturation in a fat.

Ruminant milk fat is extremely complex in fatty acid composition. By using gas chromatography in combination with fractional distillation of the methyl esters and adsorption chromatography, Magidman et al. (1962) and Herb et al. (1962) identified at least 60 fatty acids in cow's milk fat. Several additional minor fatty acid components have been found in other recent studies. About 12 fatty acids occur in amounts greater than 1 percent (Jensen and Newburg 1995). Among these, the short-chain fatty acids from butyric to capric are characteristic of ruminant milk fat. Data provided by Hilditch and Williams (1964) on the component fatty acids of some milk fats are listed in Table 2-5. Fatty acid compositions are usually reported in percentage by weight, but in the case of fats containing short-chain fatty acids (or very long-chain fatty acids) this method may not give a good impression of the molecular proportions of fatty acids present. Therefore, in many instances, the fatty acid composi-

tion is reported in mole percent, as is the case with the data in Table 2-5. According to Jensen (1973) the following fatty acids are present in cow's milk fat: even and odd saturated acids from 2:0 to 28:0; even and odd monoenoic acids from 10:1 to 26:1, with the exception of 11:1, and including positional and geometric isomers; even unsaturated fatty acids from 14:2 to 26:2 with some conjugated geometric isomers; polyenoic even acids from 18:3 to 22:6 including some conjugated *trans* isomers; monobranch fatty acids 9:0 and 11:0 to 25:0—some *iso* and some *ante-iso* (*iso* acids have a methyl branch on the penultimate carbon, *ante-iso* on the next to penultimate carbon [Figure 2-4]); multibranch acids from 16:0 to 28:0, both odd and even with three to five methyl branches; and a number of keto, hydroxy, and cyclic acids.

It is impossible to determine all of the constituents of milk fatty acids by a normal chromatographic technique, because many of the minor component fatty acids are either not resolved or are covered by peaks of other major fatty acids. A milk fat chromatogram of fatty acid composition is shown in Figure 2-5. Such fatty acid compositions as reported are therefore only to be considered as approximations of the major component fatty acids; these are listed in Table 2-6. This

Table 2-5 The Component Fatty Acids of Some Milk Fats in Mole %

Fatty Acid	Cow	Goat	Sheep
4:0	9.5	7.5	7.5
6:0	4.1	4.7	5.3
8:0	0.8	4.3	3.5
10:0	3.2	12.8	6.4
Total short chain	17.6	29.3	22.7
12:0	2.9	6.6	4.5
14:0	11.5	11.8	9.9
16:0	26.7	24.1	21.6
18:0	7.6	4.7	10.3
20:0	1.8	0.4	0.8
10-12 unsaturated	1.1	1.4	1.0
16:1	4.3	2.2	2.0
18:1	22.4	16.5	21.6
18:2	3.1	2.8	4.3
20-22 unsaturated	1.0	0.2	1.3

Source: From T.P. Hilditch and P.N. Williams, *The Chemical Constitution of Natural Fats*, 4th ed., 1964, John Wiley & Sons.

table reports the most recent results of the major component fatty acids in bovine milk fat as well as their distribution among the sn-1, sn-2, and sn-3 positions in the triacylglycerols (Jensen and Newburg 1995).

In most natural fats the double bonds of unsaturated fatty acids occur in the *cis* configuration. In milk fat a considerable proportion is in the *trans* configuration. These *trans* bonds result from microbial action in the rumen where polyunsaturated fatty acids of the feed are partially hydrogenated. Catalytic hydrogenation of oils in the fat industry

also results in *trans* isomer formation. The level of *trans* isomers in milk fat has been reported as 2 to 4 percent (deMan and deMan 1983). Since the total content of unsaturated fatty acids in milk fat is about 34 percent, *trans* isomers may constitute about 10 percent of total unsaturation. The complexity of the mixture of different isomers is demonstrated by the distribution of positional and geometric isomers in the monoenoic fatty acids of milk fat (Table 2-7) and in the unconjugated 18:2 fatty acids (Table 2-8). The iodine value of milk fat is

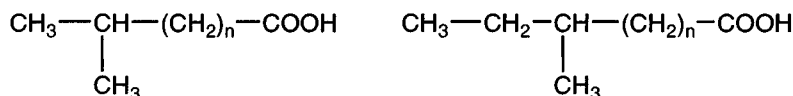
**Figure 2-4** Examples of Iso- and Ante-Iso-Branched-Chain Fatty Acids

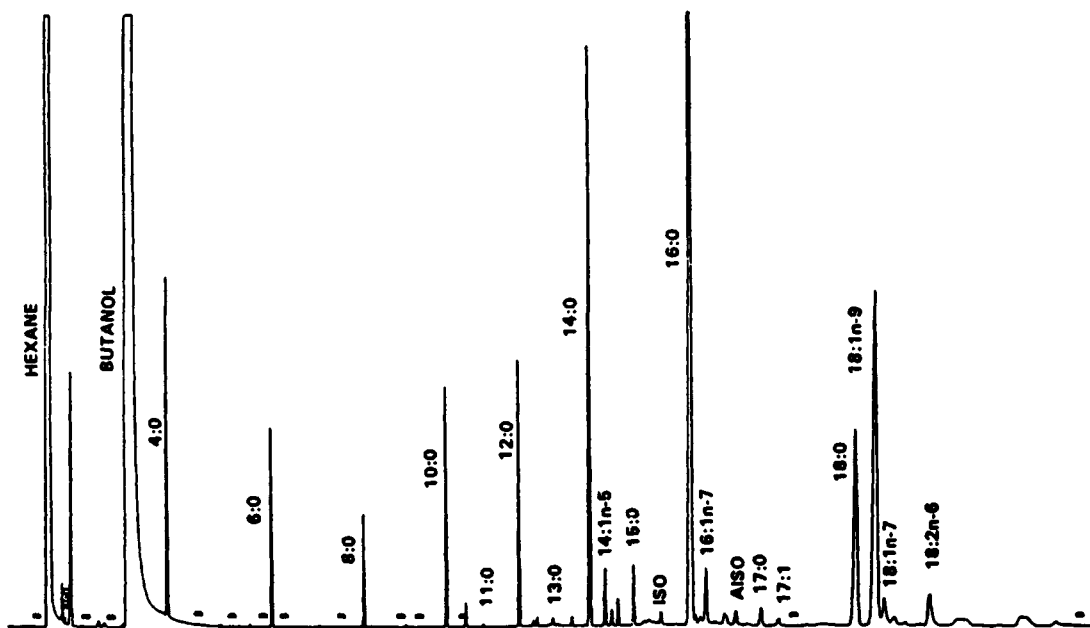

Figure 2-5 Chromatogram of Milk Fat Fatty Acid Composition Analyzed as Butyl Esters on a 30-m Capillary Column. *Source:* Reprinted from R.G. Ackman, *Animal and Marine Lipids*, in *Improved and Technological Advances in Alternative Sources of Lipids*, B. Kamel and Y. Kakuda, eds., p. 298, © 1994, Aspen Publishers, Inc.

in the range of 30 to 35, much lower than that of lard, shortening, or margarine, which have similar consistencies.

Marine oils have also been found to contain a large number of component fatty acids. Ackman (1972) has reported as many as 50 or 60 components. Only about 14 of these are of importance in terms of weight percent of the total. These consist of relatively few saturated fatty acids (14:0, 16:0, and 18:0) and a larger number of unsaturated fatty acids with 16 to 22 carbon atoms and up to 6 double bonds. This provides the possibility for many positional isomers.

The complexity of the fatty acid composition of marine oils is evident from the chromatogram shown in Figure 2-6 (Ackman 1994). The end structure of the polyunsatu-

rated fatty acids is of nutritional importance, especially eicosapentaenoic acid (EPA), 20:5 ω 3 or 20:5 *n*-3, and docosahexaenoic acid (DHA), 22:6 ω 3 or 22:6 *n*-3. The double bonds in marine oils occur exclusively in the *cis* configuration. EPA and DHA can be produced slowly from linolenic acid by herbivore animals, but not by humans. EPA and DHA occur in major amounts in fish from cold, deep waters, such as cod, mackerel, tuna, swordfish, sardines, and herring (Ackman 1988a; Simopoulos 1988). Arachidonic acid is the precursor in the human system of prostanooids and leukotrienes.

Ackman (1988b) has drawn attention to the view that the fatty acid compositions of marine oils are all much the same and vary

Table 2-6 Major Fatty Acids of Bovine Milk Fat and Their Distribution in the Triacylglycerols

Fatty Acids (mol%)	Bovine Milk Fat			
	TG	sn-1	sn-2	sn-3
4:0	11.8	—	—	35.4
6:0	4.6	—	0.9	12.9
8:0	1.9	1.4	0.7	3.6
10:0	37	1.9	3.0	6.2
12:0	3.9	4.9	6.2	0.6
14:0	11.2	9.7	17.5	6.4
15:0	2.1	2.0	2.9	1.4
16:0	23.9	34.0	32.3	5.4
16:1	2.6	2.8	3.6	1.4
17:0	0.8	1.3	1.0	0.1
18:0	7.0	10.3	9.5	1.2
18:1	24.0	30.0	18.9	23.1
18:2	2.5	1.7	3.5	2.3
18:3	Trace	—	—	—

Source: Reprinted with permission from R.G. Jensen and D.S. Newburg, Milk Lipids, in *Handbook of Milk Composition*, R.G. Jensen, ed., p. 546, © 1995, Academic Press.

only in the proportions of fatty acids. The previously held view was that marine oils were species-specific. The major fatty acids of marine oils from high-, medium-, and low-fat fish are listed in Table 2-9 (Ackman 1994).

The fatty acid composition of egg yolk is given in Table 2-10. The main fatty acids are palmitic, oleic, and linoleic. The yolk constitutes about one-third of the weight of the edible egg portion. The relative amounts of egg yolk and white vary with the size of the egg. Small eggs have relatively higher amounts of yolk. The egg white is virtually devoid of fat.

The vegetable oils and fats can be divided into three groups on the basis of fatty acid composition. The first group comprises oils containing mainly fatty acids with 16 or 18

carbon atoms and includes most of the seed oils; in this group are cottonseed oil, peanut oil, sunflower oil, corn oil, sesame oil, olive oil, palm oil, soybean oil, and safflower oil. The second group comprises seed oils containing erucic (docos-13-enoic) acid. These include rapeseed and mustard seed oil. The third group is the vegetable fats, comprising coconut oil and palm kernel oil, which are highly saturated (iodine value about 15), and cocoa butter, the fat obtained from cocoa beans, which is hard and brittle at room temperature (iodine value 38). The component fatty acids of some of the most common vegetable oils are listed in Table 2-11. Palmitic is the most common saturated fatty acid in vegetable oils, and only very small amounts of stearic acid are present. Oils containing linolenic acid, such

Table 2-7 Positional and Geometric Isomers of Bovine Milk Lipid Monoenoic Fatty Acids (Wt%)

Position of Double Bond	<i>cis</i> Isomers				<i>trans</i> Isomers	
	14:1	16:1	17:1	18:1	16:1	18:1
5	1.0	Tr			2.2	
6	0.8	1.3	3.4		7.8	1.0
7	0.9	5.6	2.1		6.7	0.8
8	0.6	Tr	20.1	1.7	5.0	3.2
9	96.6	88.7	71.3	95.8	32.8	10.2
10	—	Tr	Tr	Tr	1.7	10.5
11	—	2.6	2.9	2.5	10.6	35.7
12	—	Tr	Tr	—	12.9	4.1
13	—	—	—	—	10.6	10.5
14	—	—	—	—	—	9.0
15	—	—	—	—	—	6.8
16	—	—	—	—	—	7.5

Source: From R.G. Jensen, Composition of Bovine Milk Lipids, *J. Am. Oil Chem. Soc.*, Vol. 50, pp. 186-192, 1973.

as soybean oil, are unstable. Such oils can be slightly hydrogenated to reduce the linolenic acid content before use in foods. Another fatty acid that has received attention for its possible beneficial effect on health is the n-6 essential fatty acid,

gamma-linolenic acid (18:3 n-6), which occurs at a level of 8 to 10 percent in evening primrose oil (Carter 1988).

The *Crucifera* seed oils, including rapeseed and mustard oil, are characterized by the presence of large amounts of erucic acid

Table 2-8 Location of Double Bonds in Unconjugated 18:2 Isomers of Milk Lipids

<i>cis, cis</i>	<i>cis, trans</i> or <i>trans, cis</i>	<i>trans, trans</i>
11, 15	11, 16 and/or 11, 15	12, 16
10, 15	10, 16 and/or 10, 15	11, 16 and/or 11, 15
9, 15	9, 15 and/or 9, 16	10, 16 and/or 10, 15
8, 15 and/or 8, 12	8, 16 and/or 8, 15	9, 16 and/or 9, 15
7, 15 and/or 7, 12	and/or 8, 12	and/or 9, 13
6, 15 and/or 6, 12		

Source: From R.G. Jensen, Composition of Bovine Milk Lipids, *J. Am. Oil Chem. Soc.*, Vol. 50, pp. 186-192, 1973.

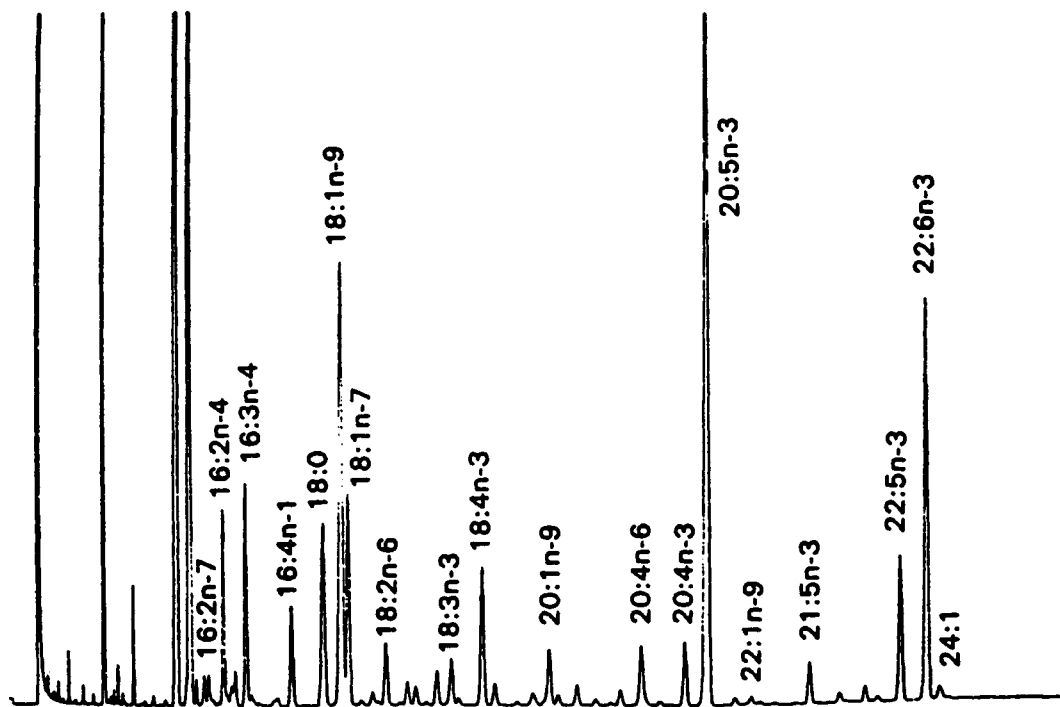

Figure 2-6 Chromatogram of the Fatty Acid Composition of Fish Oil (Menhaden). Analysis of methyl esters on a 30-m capillary column. *Source:* Reprinted from R.G. Ackman, *Animal and Marine Lipids*, in *Improved and Technological Advances in Alternative Sources of Lipids*, B. Kamel and Y. Kakuda, eds., p. 308, 1994, Aspen Publishers, Inc.

(docos-13-enoic) and smaller amounts of eicos-11-enoic acid. Rapeseed oil of the variety *Brassica napus* may have over 40 percent of erucic acid (Table 2-12), whereas *Brassica campestris* oil usually has a much lower erucic acid content, about 22 percent. Because of possible health problems resulting from ingestion of erucic acid, new varieties of rapeseed have been introduced in recent years; these are the so-called low-erucic acid rapeseed (LEAR) varieties, which produce LEAR oil. When the seed is also low in glucosinolates, the oil is known as canola oil. Plant breeders have succeeded in reducing the erucic acid level to less than 1 percent and as a result canola oil has a very

high level of oleic acid (Table 2-12). The breeding of these varieties has in effect resulted in the creation of a completely new oil. Removal of the erucic and eicosenoic acids results in a proportional increase in the oleic acid content. The low erucic acid oil is a linolenic acid-containing oil and is therefore similar in this respect to soybean oil. The fatty acid composition of mustard oil is given in Table 2-12. It is similar to that of *B. campestris* oil.

Vegetable fats, in contrast to the oils, are highly saturated, have low iodine values, and have high melting points. Coconut oil and palm kernel oil belong to the lauric acid fats. They contain large amounts of medium- and

Table 2–9 Total Fat Content and Major Fatty Acids in High-, Medium-, and Low-Fat Fish

	<i>High Fat</i>		<i>Medium Fat</i>		<i>Low Fat</i>	
	<i>Capelin</i>	<i>Sprat</i>	<i>Blue Whiting</i>	<i>Capelin</i>	<i>Dogfish</i>	<i>Saith, Guttled</i>
Total fat	14.1	12.9	7.4	4.0	1.7	0.4
Fatty acid						
14:0	7.1	5.5	3.9	7.3	1.6	1.7
16:0	9.9	17.5	11.5	9.7	15.3	12.4
16:1	11.0	5.8	6.1	8.3	4.9	2.7
18:1	13.4	18.0	14.8	14.5	20.8	13.1
20:1	16.3	7.4	10.7	13.6	11.2	5.9
22:1	12.6	12.8	12.4	10.4	7.9	3.5
20:5 n -3	8.6	7.4	10.4	9.2	6.0	12.7
22:6 n -3	6.7	11.7	12.6	11.0	15.5	30.6
Total	85.6	86.1	82.4	84.0	84.8	82.6

Source: Reprinted from R.G. Ackman, *Animal and Marine Lipids*, in *Improved and Technological Advances in Alternative Sources of Lipids*, B. Kamel and Y. Kakuda, eds., p. 302, 1994, Aspen Publishers, Inc.

short-chain fatty acids, especially lauric acid (Table 2–13). Cocoa butter is unusual in that it contains only three major fatty acids—palmitic, stearic, and oleic—in approximately equal proportions.

COMPONENT GLYCERIDES

Natural fats can be defined as mixtures of mixed triglycerides. Simple triglycerides are virtually absent in natural fats, and the distribution of fatty acids both between and within glycerides is selective rather than random. When asymmetric substitution in a glycerol molecule occurs, enantiomeric forms are produced (Kuksis 1972; Villeneuve and Foglia 1997). This is illustrated in Figure 2–7. Glycerol has a plane of symmetry or mirror plane, because two of the four substituents on the central carbon atom are identical. When one of the carbon atoms is esterified with a fatty acid, a monoglyceride results and two nonsuperimposable structures exist. These are called enantiomers and are also referred to as chiral. A racemic mixture is a mixture of equal amounts of enantiomers. Asymmetric or chiral compounds are formed in 1-monoglycerides; all 1, 2-diglycerides; 1,

Table 2–10 Fatty Acid Composition of Egg Yolk

<i>Fatty Acid</i>	<i>%</i>
Total saturated	36.2
14:0	0.3
16:0	26.6
18:0	9.3
Total monounsaturated	48.2
16:1	4.0
18:1	44.1
Total polyunsaturated	14.7
18:2	13.4
18:3	0.3
20:4	1.0

Table 2-11 Component Fatty Acids of Some Vegetable Oils

Oil	Fatty Acid Wt%					Total C18
	16:0	18:0	18:1	18:2	18:3	
Canola	4	2	56	26	10	96
Cottonseed	27	2	18	51	Trace	73
Peanut*	13	3	38	41	Trace	83
Olive	10	2	78	7	—	90
Rice bran	16	2	42	37	1	84
Soybean	11	4	22	53	8	89
Sunflower	5	5	20	69	—	95
Sunflower high oleic	4	5	81	8	—	96
Palm	44	4	39	11	—	54
Cocoa butter	26	34	35	3	—	74

*Peanut oil also contains about 3% of 22:0 and 1% of 22:1.

3-diglycerides containing unlike substituents; and all triglycerides in which the 1- and 3- positions carry different acyl groups.

The glyceride molecule can be represented in the wedge and slash form (Figure 2-8). In this spatial representation, the wedge indicates a substituent coming out of the plane toward the observer, and the slash indicates a substituent going away from the observer. The three carbon atoms of the glycerol are

then described by the stereospecific numbering (*sn*) with the three carbon atoms designated *sn*-1 from the top to *sn*-3 at the bottom.

When a fat or oil is characterized by determination of its component fatty acids, there still remains the question as to how these acids are distributed among and within the glycerides. Originally theories of glyceride distribution were attempts by means of mathematical schemes to explain the occurrence

Table 2-12 Component Fatty Acids of Some Crucifera Seed Oils (Wt%)

Seed Oil	Fatty Acid							Total C18
	16:0	18:0	18:1	18:2	18:3	20:1	22:1	
Rapeseed (<i>B. campestris</i>)	4	2	33	18	9	12	22	62
Rapeseed (<i>B. napus</i>)	3	1	17	14	9	11	45	41
Canola (LEAR)	4	2	55	26	10	2	<1	96
Mustard (<i>B. juncea</i>)	4	—	22	24	14	12	20	60

Source: Data from B.M. Craig et al., Influence of Genetics, Environment, and Admixtures on Low Erucic Acid Rapeseed in Canada, *J. Am. Oil Chem. Soc.*, Vol. 50, pp. 395-399, 1973; and M. Vaisey-Genser and N.A.M. Eskin, *Canola Oil: Properties and Performance*, 1987, Canola Council.

Table 2-13 Component Fatty Acids of Some Vegetable Fats (Wt %)

Vegetable Fat	Fatty Acid								
	6:0	8:0	10:0	12:0	14:0	16:0	18:0	18:1	18:2
Coconut	0.5	9.0	6.8	46.4	18.0	9.0	1.0	7.6	1.6
Palm kernel	—	2.7	7.0	46.9	14.1	8.8	1.3	18.5	0.7
Cocoa butter	—	—	—	—	—	26.2	34.4	37.3	2.1

of particular kinds and amounts of glycerides in natural fats. Subsequent theories have been refinements attempting to relate to the biochemical mechanisms of glyceride syn-

thesis. Hilditch proposed the concept of even distribution (Gunstone 1967). In the rule of even (or widest) distribution, each fatty acid in a fat is distributed as widely as possible among glyceride molecules. This means that when a given fatty acid A constitutes about 35 mole percent or more of the total fatty acids (A + X), it will occur at least once in all triglyceride molecules, as represented by GAX_2 . If A occurs at levels of 35 to 70 mole percent, it will occur twice in an increasing number of triglycerides GA_2X . At levels over 70 percent, simple triglycerides GA_3 are formed. In strictly random distribution the amount of GA_3 in a fat would be proportional to the cube of the percentage of A present. For example, at 30 percent A there would be 2.7 percent of GA_3 , which under rules of even distribution would occur only at levels of A over 70 percent (Figure 2-9).

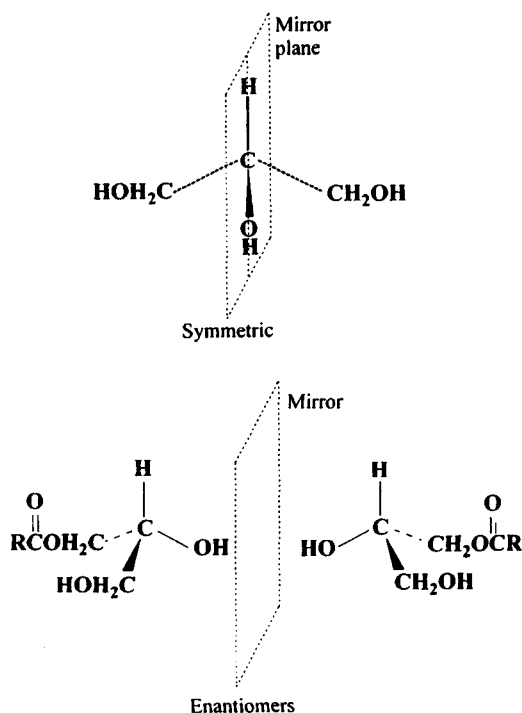

Figure 2-7 Plane of Symmetry of a Glycerol Molecule (Top) and Mirror Image of Two Enantiomers of a Mono-Acylglycerol (bottom). *Source:* Reprinted with permission from P. Villeneuve and T.A. Foglia, *Lipase Specificities: Potential Application in Bioconversions*, *Inform*, 8, pp. 640-650, © 1997, AOCS Press.

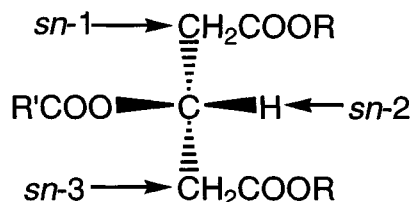

Figure 2-8 Stereospecific Numbering of the Carbons in a Triacylglycerol

The theory of restricted random distribution was proposed by Kartha (1953). In this theory the fatty acids are distributed at random, but the content of fully saturated glycerides is limited to the amount that can remain fluid *in vivo*. This theory is followed by the 1,3 random, 2 random distribution hypothesis of Vander Wal (1964). According to this theory, all acyl groups at the 2-positions of the glycerol moieties of a fat are distributed therein at random. Equally, all acyl groups at the 1- and 3-positions are distributed at random and these positions are identical. Application of this theory to the results obtained with a number of fats gave good agreement (Vander Wal 1964), as Table 2-14 shows.

In vegetable fats and oils, the saturated fatty acyl groups have a tendency to occupy the 1- and 3- positions in the glycerides and the unsaturated acyl groups occupy the 2-

position (Figure 2-10). Since these fats contain a limited number of fatty acids, it is customary to show the glyceride composition in terms of saturated (S) and unsaturated (U) acids. The predominant glyceride types in these fats and oils are S-U-S and S-U-U. Lard is an exception—saturated acyl groups predominate in the 2-position. The glyceride distribution of cocoa butter results in a fat with a sharp melting point of about 30 to 34°C. It is hard and brittle below the melting point, which makes the fat useful for chocolate and confectionery manufacture. Other fats with similar fatty acid composition, such as sheep depot fat (see Table 2-4), have a greater variety of glycerides, giving the fat a higher melting point (about 45°C) and a wider melting range, and a greasy and soft appearance.

Brockerhoff et al. (1966) studied the fatty acid distribution in the 1-, 2-, and 3-positions of the triglycerides of animal depot fats by stereospecific analysis. The distribution among the three positions was nonrandom. The distribution of fatty acids seems to be governed by chain length and unsaturation. In most fats a short chain and unsaturation direct a fatty acid toward position 2. The depot fat of pigs is an exception, palmitic acid being predominant in position 2. In the fats of marine animals, chain length is the directing factor, with polyunsaturated and short-chain fatty acids accumulated in the 2-position and long chains in the 1- and 3-positions. In the fats of birds, unsaturation seems to be the only directing factor and these acids accumulate in the 2-position.

The positional distribution of fatty acids in pig fat (lard) and cocoa butter is shown in Table 2-15. Most of the unsaturation in lard is located in the 1- and 3-positions, whereas in cocoa butter the major portion of the unsaturation is located in the 2-position. This

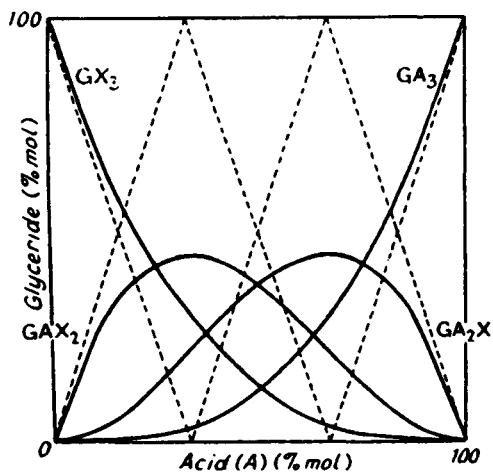

Figure 2-9 Calculated Values for Glyceride Types in Random Distribution (Solid Lines) and Even Distribution (Dotted Lines). *Source:* From F.D. Gunstone, *An Introduction to the Chemistry of Fats and Fatty Acids*, 1967, Chapman and Hall.

Table 2-14 Comparison of the Glyceride Composition of Some Natural Fats as Determined Experimentally and as Calculated by 1,3 Random, 2 Random Hypothesis

Fat	Method	Molecular Species					
		SSS (Mole %)	SUS (Mole %)	SSU (Mole %)	USU (Mole %)	UUS (Mole %)	UUU (Mole %)
Lard	Experiment	8	0	29	36	15	12
Lard	Calculated	6	2	29	36	12	15
Chicken fat	Experiment	3	10	9	12	38	28
Chicken fat	Calculated	3	10	10	9	36	32
Cocoa butter	Experiment	5	66	7	3	20	1
Cocoa butter	Calculated	5	69	2	0	22	2

Source: From R.J. Vander Wal, Triglyceride Structure, *Adv. Lipid Res.*, Vol. 2, pp. 1-16, 1964.

difference accounts for the difference in physical properties of the two fats (deMan et al. 1987).

Milk fat, with its great variety of fatty acids, also has a very large number of glycerides. It is possible, by, for example, fractional crystallization from solvents, to separate milk fat in a number of fractions with different melting points (Chen and deMan 1966). Milk fat is peculiar in some respects. Its short-chain fatty acids are classified chemically as saturated compounds but

behave physically like unsaturated fatty acids. One of the unsaturated fatty acids, the so-called oleic acid, is partly *trans* and has a much higher melting point than the *cis* isomers. In the highest melting fraction from milk fat, there is very little short-chain fatty acid and little unsaturation, mostly in the *trans* configuration (Woodrow and deMan 1968). The low melting fractions are high in short-chain fatty acids and unsaturation (*cis*). The general distribution of major fatty acids in whole milk fat is as follows (Morrison

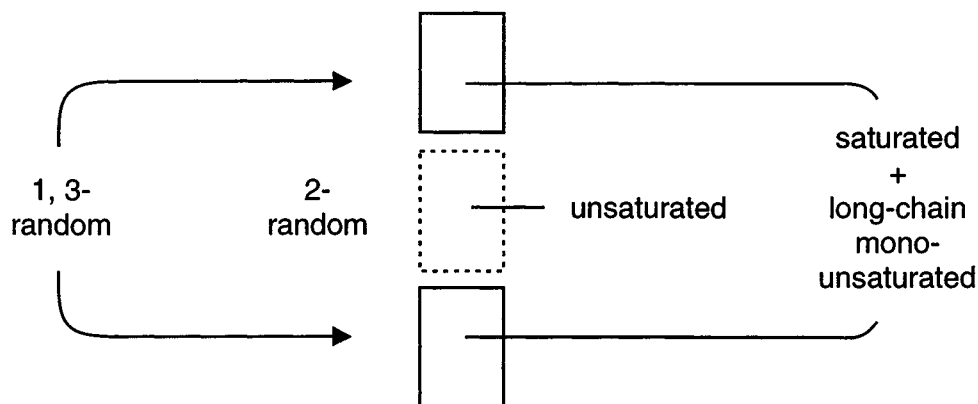

Figure 2-10 Fatty Acid Distribution in the Triacylglycerols of Vegetable Oils

Table 2-15 Positional Distribution Fatty Acids in Pig Fat and Cocoa Butter

Fat	Position	Fatty Acid (Mole %)					
		14:0	16:0	16:1	18:0	18:1	18:2
Pig fat	1	0.9	9.5	2.4	29.5	51.3	6.4
	2	4.1	72.3	4.8	2.1	13.4	3.3
	3	0	0.4	1.5	7.4	72.7	18.2
Cocoa butter	1	—	34.0	0.6	50.4	12.3	1.3
	2	—	1.7	0.2	2.1	87.4	8.6
	3	—	36.5	0.3	52.8	8.6	0.4

Source: From W.C. Breckenridge, *Stereospecific Analysis of Triacylglycerols*, in *Fatty Acids and Glycerides*, A. Kuksis, ed., 1978, Plenum Press.

1970): 4:0 and 6:0 are located largely in primary positions; 18:0 and 18:1 are preferentially in primary positions; 10:0, 12:0, and 16:0 are distributed randomly or with a slight preference for the secondary position; and 14:0 is predominantly in the secondary position. The distribution of milk fat triacylglycerols according to carbon number and unsaturation has been reported by Jensen and Newburg (1995) and is presented in Table 2-16.

PHOSPHOLIPIDS

All fats and oils and fat-containing foods contain a number of phospholipids. The lowest amounts of phospholipid are present in pure animal fats such as lard and beef tallow. In some crude vegetable oils, such as cottonseed, corn, and soybean oils, phospholipids may be present at levels of 2 to 3 percent. Fish, crustacea, and mollusks contain approximately 0.7 percent of phospholipids in the muscle tissue. Phospholipids are surface active, because they contain a lipophilic and hydrophilic portion. Since they can easily be hydrated, they can be removed from fats and oils during the refin-

ing process. In some cases they may be removed by separation of two phases; for example, if butter is melted and filtered, the pure oil thus obtained is free from phospholipids. The structure of the most important phospholipids is given in Figure 2-11. After refining of oils, neutralization, bleaching, and deodorization, the phospholipid content is reduced to virtually zero. The phospholipids removed from soybean oil are used as emulsifiers in certain foods, such as chocolate. Soybean phospholipids contain about 35 percent lecithin and 65 percent cephalin. The fatty acid composition of phospholipids is usually different from that of the oil in which they are present. The acyl groups are usually more unsaturated than those of the triglycerides. Phospholipids of many vegetable oils contain two oleic acid residues. The phospholipids of milk do not contain the short-chain fatty acids found in milk fat triglycerides, and they contain more long-chain polyunsaturated fatty acids than the triglycerides. The composition of cow's milk phospholipids has been reported by Jensen (1973), as shown in Table 2-17. The difference in composition of triglycerides and phospholipids in mackerel is demon-

Table 2-16 Distribution (wt %) of Milk Fat Triacylglycerols According to Carbon Number and Unsaturation

Carbon Number	Number of Double Bonds			
	0	1	2	3
34	4.8	1.4	—	—
36	5.0	4.9	2.6	—
38	4.6	6.9	2.9	3.1
40	2.0	4.6	3.1	1.2
42	1.5	2.4	2.1	1.2
44	1.0	2.8	2.9	1.0
46	1.3	2.1	2.2	1.0
48	1.6	2.2	2.2	1.0
50	2.6	3.4	2.7	0.8
52	2.7	5.7	1.9	0.4
54	2.2	1.4	0.3	—
Total	29.3	37.8	22.9	9.7

Source: Reprinted with permission from R.G. Jensen and D.S. Newburg, Milk Lipids, in *Handbook of Milk Composition*, R.G. Jensen, ed., p. 550, © 1995, Academic Press.

strated by the data reported by Ackman and Eaton (1971), as shown in Table 2-18. The phospholipids of flesh and liver in mackerel are considerably more unsaturated than the triglycerides.

The distribution of fatty acids in phospholipids is not random, with saturated fatty acids preferentially occupying position 1 and unsaturated fatty acids position 2.

UNSAPONIFIABLES

The unsaponifiable fraction of fats consists of sterols, terpenic alcohols, aliphatic alcohols, squalene, and hydrocarbons. The distribution of the various components of the unsaponifiable fraction in some fats and oils is given in Table 2-19. In most fats the major components of the unsaponifiable fraction are sterols. Animal fats contain cholesterol

and, in some cases, minor amounts of other sterols such as lanosterol. Plant fats and oils contain phytosterols, usually at least three, and sometimes four (Fedeli and Jacini 1971). They contain no or only trace amounts of cholesterol. The predominant phytosterol is β -sitosterol; the others are campesterol and stigmasterol. In rapeseed oil, brassicasterol takes the place of stigmasterol. Sterols are compounds containing the perhydrocyclopenteno-phenanthrene nucleus, which they have in common with many other natural compounds, including bile acids, hormones, and vitamin D. The nucleus and the description of the four rings, as well as the system of numbering of the carbon atoms, are shown in Figure 2-12A. The sterols are solids with high melting points. Stereochemically they are relatively flat molecules, usually with all *trans* linkages, as shown in

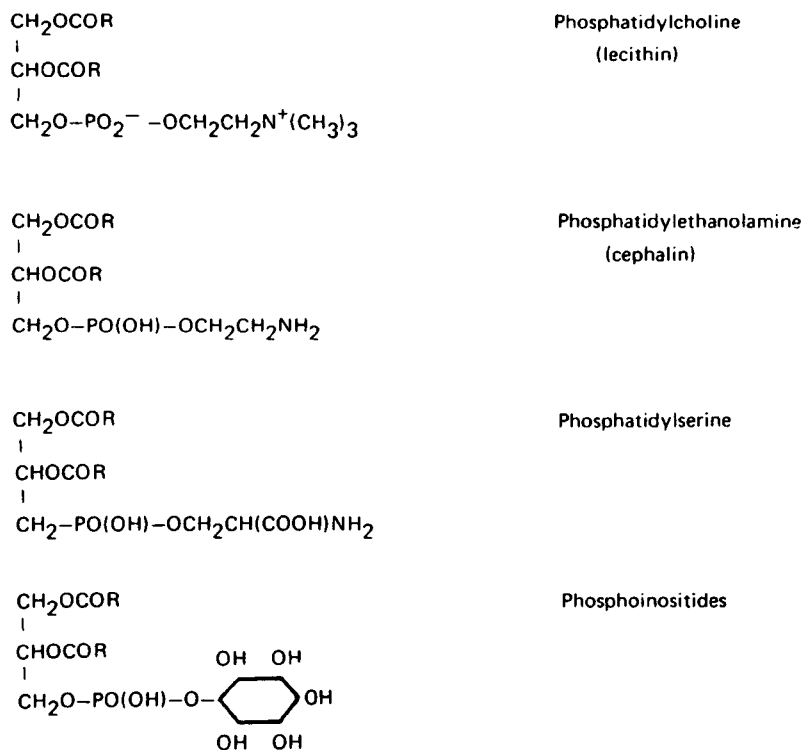

Figure 2–11 Structure of the Major Phospholipids

Table 2–17 Composition of the Phospholipids of Cow's Milk

<i>Phospholipid</i>	<i>Mole (%)</i>
Phosphatidylcholine	34.5
Phosphatidylethanolamine	31.8
Phosphatidylserine	3.1
Phosphatidylinositol	4.7
Sphingomyelin	25.2
Lysophosphatidylcholine	Trace
Lysophosphatidylethanolamine	Trace
Total choline phospholipids	59.7
Plasmalogens	3
Diphosphatidyl glycerol	Trace
Ceramides	Trace
Cerebrosides	Trace

Source: From R.G. Jensen, Composition of Bovine Milk Lipids, *J. Am. Oil Chem. Soc.*, Vol. 50, pp. 186–192, 1973.

Table 2-18 Triglycerides and Phospholipids of Mackerel Lipids and Calculated Iodine Values for Methyl Esters of Fatty Acid from Lipids

	Triglycerides			Phospholipids		
	In Lipid (%)	In Tissue (%)	Ester Iodine Value	In Lipid (%)	In Tissue (%)	Ester Iodine Value
Light flesh	89.5	9.1	152.3	4.7	0.5	242.9
Dark flesh	74.2	10.7	144.3	11.3	1.6	208.1
Liver	79.5	14.4	130.9	9.3	1.7	242.1

Source: From R.G. Ackman and C.A. Eaton, Mackerel Lipids and Fatty Acids, *Can. Inst. Food Sci. Technol. J.*, Vol. 4, pp. 169-174, 1971.

Figure 2-12B. The ring junction between rings A and B is *trans* in some steroids, *cis* in others. The junctions between B and C and C and D are normally *trans*. Substituents that lie above the plane, as drawn in Figure 2-12C, are named β , those below the plane, α . The 3-OH group in cholesterol (Figure 2-12C) is the β -configuration, and it is this group that may form ester linkages. The composition of the plant sterols is given in Figure 2-13. Part of the sterols in natural

fats are present as esters of fatty acids; for example, in milk fat, about 10 percent of the cholesterol occurs in the form of cholesterol esters.

The sterols provide a method of distinguishing between animal and vegetable fats by means of their acetates. Cholesterol acetate has a melting point of 114°C, whereas phytosterol acetates melt in the range of 126 to 137°C. This provides a way to detect adulteration of animal fats with vegetable fats.

Table 2-19 Composition of the Unsaponifiable Fraction of Some Fats and Oils

Oils	Hydrocarbons	Squalene	Aliphatic Alcohols	Terpenic Alcohols	Sterols
Olive	2.8-3.5	32-50	0.5	20-26	20-30
Linseed	3.7-14.0	1.0-3.9	2.5-5.9	29-30	34.5-52
Teaseed	3.4	2.6	—	—	22.7
Soybean	3.8	2.5	4.9	23.2	58.4
Rapeseed	8.7	4.3	7.2	9.2	63.6
Corn	1.4	2.2	5.0	6.7	81.3
Lard	23.8	4.6	2.1	7.1	47.0
Tallow	11.8	1.2	2.4	5.5	64.0

Source: From G. Jacini, E. Fedeli, and A. Lanzani, Research in the Nonglyceride Substances of Vegetable Oils, *J. Assoc. Off. Anal. Chem.*, Vol. 50, pp. 84-90, 1967.

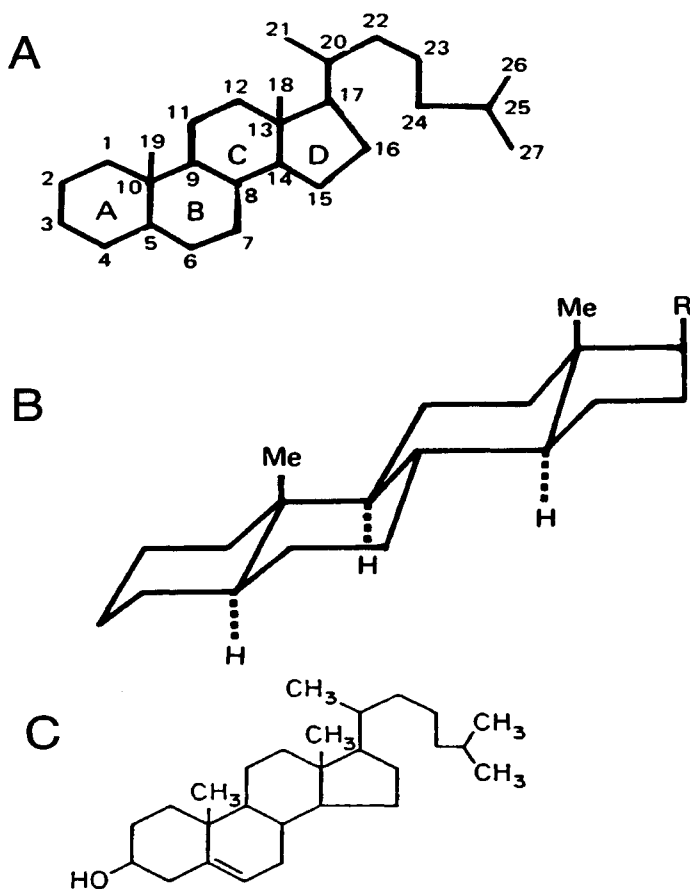

Figure 2-12 Sterols. (A) Structure of the Steroid Nucleus, (B) Stereochemical Representation, and (C) Cholesterol

The sterol content of some fats and oils is given in Table 2-20. Cholesterol is the main sterol of animal, fish, and marine fats and oils.

The hydrocarbons of the unsaponifiable oils are members of the *n*-paraffins as well as of the branched-chain paraffins of the *iso* and *ante-iso* configuration. The composition of hydrocarbon constituents of some vegetable oils has been reported by Jacini et al. (1967) and is listed in Table 2-21.

The structure of squalene is presented in Figure 2-14, which also gives the structure of one of the terpenic alcohols, geranyl

geraniol; this alcohol has been reported to be a component of the nonglyceride fraction of vegetable oils (Fedeli et al. 1966).

AUTOXIDATION

The unsaturated bonds present in all fats and oils represent active centers that, among other things, may react with oxygen. This reaction leads to the formation of primary, secondary, and tertiary oxidation products that may make the fat or fat-containing foods unsuitable for consumption.

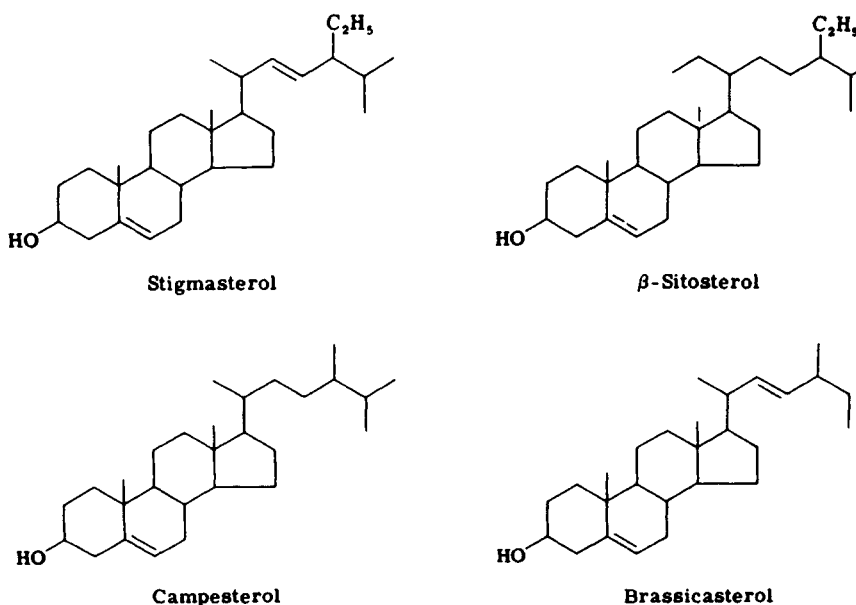

Figure 2-13 Structures of the Plant Sterols

The process of autoxidation and the resulting deterioration in flavor of fats and fatty foods are often described by the term *rancidity*. Usually rancidity refers to oxidative deterioration but, in the field of dairy science, rancidity refers usually to hydrolytic changes resulting from enzyme activity. Lundberg (1961) distinguishes several types of rancidity. In fats such as lard, common oxidative rancidity results from exposure to oxygen; this is characterized by a sweet but undesirable odor and flavor that become progressively more intense and unpleasant as oxidation progresses. Flavor reversion is the term used for the objectionable flavors that develop in oils containing linolenic acid. This type of oxidation is produced with considerably less oxygen than with common oxidation. A type of oxidation similar to reversion may take place in dairy products, where a very small amount of oxygen may

result in intense oxidation off-flavors. It is interesting to note that the linolenic acid content of milk fat is quite low.

Among the many factors that affect the rate of oxidation are the following:

Table 2-20 Sterol Content of Fats and Oils

<i>Fat</i>	<i>Sterol (%)</i>
Lard	0.12
Beef tallow	0.08
Milk fat	0.3
Herring	0.2-0.6
Cottonseed	1.4
Soybean	0.7
Corn	1.0
Rapeseed	0.4
Coconut	0.08
Cocoa butter	0.2

Table 2-21 Hydrocarbon Composition of Some Vegetable Oils

Oils	<i>n</i> -Paraffins	<i>iso</i> - and/or <i>ante</i> - <i>iso</i> Paraffins	Unidentified	Total Hydrocarbons
Corn	C ₁₁₋₃₁	C ₁₁₋₂₁	8	40
Peanut	C ₁₁₋₃₀	C ₁₁₋₂₃	7	40
Rapeseed	C ₁₁₋₃₁	C ₁₁₋₁₇ , C ₁₉₋₂₁	6	36
Linseed	C ₁₁₋₃₅	C ₁₁₋₂₁	7	43-45
Olive	C ₁₁ , C ₁₃₋₃₀	—	6	29

Source: From G. Jacini, E. Fedeli, and A. Lanzani, Research in the Nonglyceride Substances of Vegetable Oils, *J. Assoc. Off. Anal. Chem.*, Vol. 50, pp. 84-90, 1967.

- amount of oxygen present
- degree of unsaturation of the lipids
- presence of antioxidants
- presence of prooxidants, especially copper, and some organic compounds such as heme-containing molecules and lipoxidase
- nature of packaging material
- light exposure
- temperature of storage

The autoxidation reaction can be divided into the following three parts: initiation, propagation, and termination. In the initiation part, hydrogen is abstracted from an olefinic compound to yield a free radical.

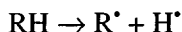

The removal of hydrogen takes place at the carbon atom next to the double bond and can

be brought about by the action of, for instance, light or metals. The dissociation energy of hydrogen in various olefinic compounds has been listed by Ohloff (1973) and is shown in Table 2-22. Once a free radical has been formed, it will combine with oxygen to form a peroxy-free radical, which can in turn abstract hydrogen from another unsaturated molecule to yield a peroxide and a new free radical, thus starting the propagation reaction. This reaction may be repeated up to several thousand times and has the nature of a chain reaction.

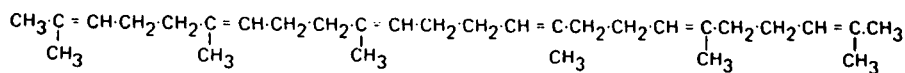
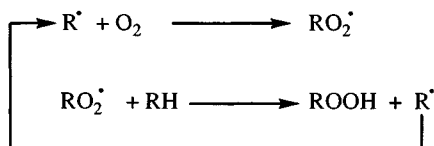

Squalene

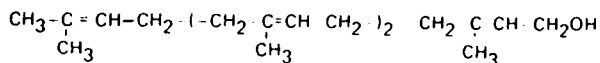

Geranyl geraniol

Figure 2-14 Structure of Squalene and Geranyl Geraniol

Table 2-22 Dissociation Energy for the Abstraction of Hydrogen from Olefinic Compounds and Peroxides

Compound	ΔE (kcal/mole)
H—CH=CH ₂	103
H—CH ₂ —CH ₂ —CH ₃	100
H—CH ₂ —CH=CH ₂	85
H—CH—CH=CH—CH ₂ — CH ₃	77
—CH=CH—CH—CH=CH— H	65
H—OO—R	90

Source: From G. Ohloff, Fats as Precursors, in *Functional Properties of Fats in Foods*, J. Solms, ed., 1973, Forster Publishing.

The propagation can be followed by termination if the free radicals react with themselves to yield nonactive products, as shown here:

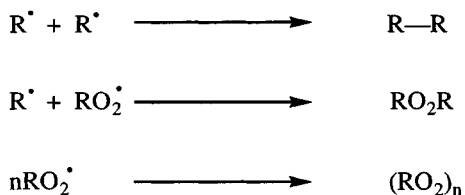

The hydroperoxides formed in the propagation part of the reaction are the primary oxidation products. The hydroperoxide mechanism of autoxidation was first proposed by Farmer (1946). These oxidation products are generally unstable and decompose into the secondary oxidation products, which include a variety of compounds, including

carbonyls, which are the most important. The peroxides have no importance to flavor deterioration, which is wholly caused by the secondary oxidation products. The nature of the process can be represented by the curves of Figure 2-15 (Pokorny 1971). In the initial stages of the reaction, the amount of hydroperoxides increases slowly; this stage is termed the induction period. At the end of the induction period, there is a sudden increase in peroxide content. Because peroxides are easily determined in fats, the peroxide value is frequently used to measure the progress of oxidation. Organoleptic changes are more closely related to the secondary oxidation products, which can be measured by various procedures, including the benzdine value, which is related to aldehyde decomposition products. As the aldehydes are themselves oxidized, fatty acids are formed; these free fatty acids may be considered tertiary oxidation products. The length of the induction period, therefore, depends

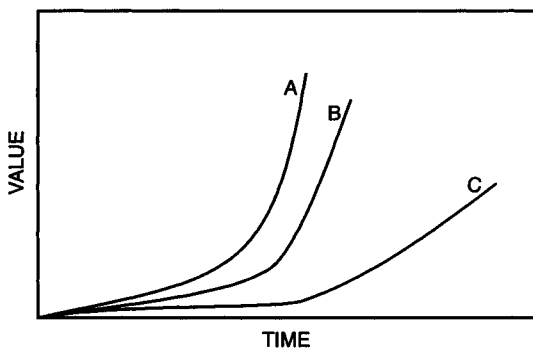
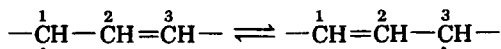

Figure 2-15 Autoxidation of Lard. (A) peroxide value, (B) benzdine value, (C) acid value. Source: From J. Pokorny, Stabilization of Fats by Phenolic Antioxidants, *Can. Inst. Food Sci. Technol. J.*, Vol. 4, pp. 68-74, 1971.

on the method used to determine oxidation products.

Although even saturated fatty acids may be oxidized, the rate of oxidation greatly depends on the degree of unsaturation. In the series of 18-carbon-atom fatty acids 18:0, 18:1, 18:2, 18:3, the relative rate of oxidation has been reported to be in the ratio of 1:100:1200:2500. The reaction of unsaturated compounds proceeds by the abstraction of hydrogen from the α carbon, and the

resulting free radical is stabilized by resonance as follows:



If oleic acid is taken as example of a monoethenoid compound (*cis*-9-octadecenoic acid), the reaction will proceed by abstraction of hydrogen from carbons 8 or 11, resulting in two pairs of resonance hybrids.

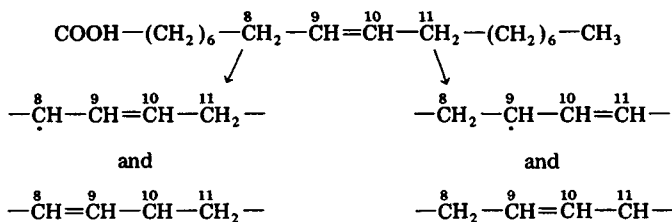

This leads to the formation of the following four isomeric hydroperoxides:

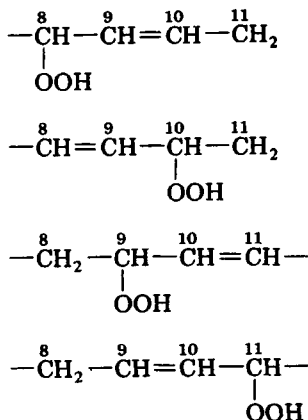

In addition to the changes in double bond position, there is isomerization from *cis* to *trans*, and 90 percent of the peroxides formed may be in the *trans* configuration (Lundberg 1961).

From linoleic acid (*cis-cis*-9,12-octadecadienoic acid), three isomeric hydroperoxides can be formed as shown in the next formula. In this mixture of 9, 11, and 13 hydroperoxides, the conjugated ones occur in greatest

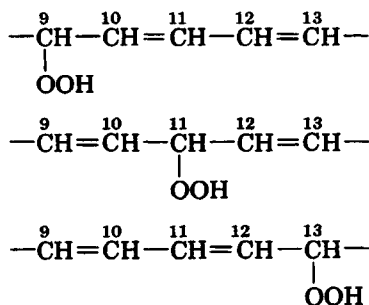

quantity because they are the more stable forms. The hydroperoxides occur in the *cis-trans* and *trans-trans* configurations, the content of the latter being greater with higher temperature and greater extent of oxidation. From the oxidation of linolenic acid (*cis, cis, cis*-9,12,15-octadecatrienoic acid), six isomeric hydroperoxides can be expected according to theory, as shown:

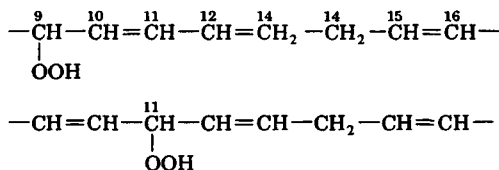

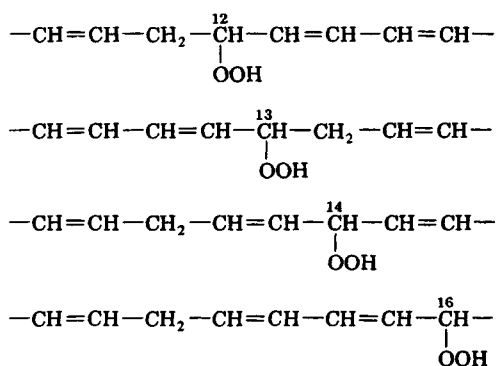

Hydroperoxides of linolenate decompose more readily than those of oleate and linoleate because active methylene groups are present. The active methylene groups are the ones located between a single double bond and a conjugated diene group. The hydrogen at this methylene group could readily be abstracted to form dihydroperoxides. The possibilities here for decomposition products are obviously more abundant than with oleate oxidation.

The decomposition of hydroperoxides has been outlined by Keeney (1962). The first step involves decomposition to the alkoxy and hydroxy free radicals.

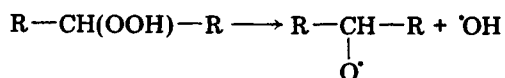

The alkoxy radical can react to form aldehydes.

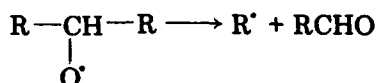

This reaction involves fission of the chain and can occur on either side of the free radical. The aldehyde that is formed can be a short-chain volatile compound, or it can be attached to the glyceride part of the molecule; in this case, the compound is nonvola-

tile. The volatile aldehydes are in great part responsible for the oxidized flavor of fats.

The alkoxy radical may also abstract a hydrogen atom from another molecule to yield an alcohol and a new free radical, as shown:

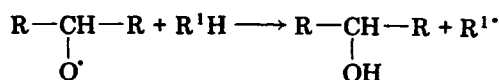

The new free radicals formed may participate in propagation of the chain reaction. Some of the free radicals may interact with themselves to terminate the chain, and this could lead to the formation of ketones as follows:

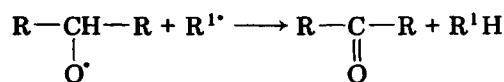

As indicated, a variety of aldehydes have been demonstrated in oxidized fats. Alcohols have also been identified, but the presence of ketones is not as certain. Keeney (1962) has listed the aldehydes that may be formed from breakdown of hydroperoxides of oxidized oleic, linoleic, linolenic, and arachidonic acids (Table 2-23). The aldehydes are powerful flavor compounds and have very low flavor thresholds; for example, 2,4-decadienal has a flavor threshold of less than one part per billion. The presence of a double bond in an aldehyde generally lowers the flavor threshold considerably. The aldehydes can be further oxidized to carboxylic acids or other tertiary oxidation products.

When chain fission of the alkoxy radical occurs on the other side of the free radical group, the reaction will not yield volatile aldehydes but will instead form nonvolatile aldehydo-glycerides. Volatile oxidation products can be removed in the refining process

Table 2-23 Hydroperoxides and Aldehydes (with Single Oxygen Function) That May Be Formed in Autoxidation of Some Unsaturated Fatty Acids

<i>Fatty Acid</i>	<i>Methylene Group Involved*</i>	<i>Isomeric Hydroperoxides Formed from the Structures Contributing to the Intermediate Free Radical Resonance Hybrid</i>	<i>Aldehydes Formed by Decomposition of the Hydroperoxides</i>
Oleic	11	11-hydroperoxy-9-ene	octanal
		9-hydroperoxy-10-ene	2-decenal
	8	8-hydroperoxy-9-ene	2-undecenal
Linoleic	11	10-hydroperoxy-8-ene	nonanal
		13-hydroperoxy-9,11-diene	hexanal
		11-hydroperoxy-9,12-diene	2-octenal
Linolenic	14	9-hydroperoxy-10,12-diene	2,4-decadienal
		16-hydroperoxy-9,12,14-triene	propanal
		14-hydroperoxy-9,12,15-triene	2-pentenal
	11	12-hydroperoxy-9,13,15-triene	2,4-heptadienal
		13-hydroperoxy-9,11,15-triene	3-hexenal
		11-hydroperoxy-9,12,15-triene	2,5-octadienal
Arachidonic	13	9-hydroperoxy-10,12,15-triene	2,4,7-decatrienal
		15-hydroperoxy-5,8,11,13-tetraene	hexanal
		13-hydroperoxy-5,8,11,14-tetraene	2-octenal
		11-hydroperoxy-5,8,12,14-tetraene	2,4-decadienal
	10	12-hydroperoxy-5,8,10,14-tetraene	3-nonenal
		10-hydroperoxy-5,8,11,14-tetraene	2,5-undecadienal
		8-hydroperoxy-5,9,11,14-tetraene	2,4,7-tridecatrienal
		7	9-hydroperoxy-5,7,11,14-tetraene
7	7-hydroperoxy-5,8,11,14-tetraene	2,5,8-tetradecatrienal	
	5-hydroperoxy-6,8,11,14-tetraene	2,4,7,10-hexadecatetraenal	

*Only the most active methylene groups in each acid are considered.

Source: From M. Keeney, Secondary Degradation Products, in *Lipids and Their Oxidation*, H.W. Schultz et al., eds., 1962, AVI Publishing Co.

during deodorization, but the nonvolatile products remain; this can result in a lower oxidative stability of oils that have already oxidized before refining.

The rate and course of autoxidation depend primarily on the composition of the fat—its degree of unsaturation and the types of unsaturated fatty acids present. The absence, or at least a low value, of peroxides does not

necessarily indicate that an oil is not oxidized. As Figure 2-16 indicates, peroxides are labile and may be transformed into secondary oxidation products. A combined index of primary and secondary oxidation products gives a better evaluation of the state of oxidation of an oil. This is expressed as Totox value: Totox value = $2 \times$ peroxide value + anisidine value. (Anisidine value is a

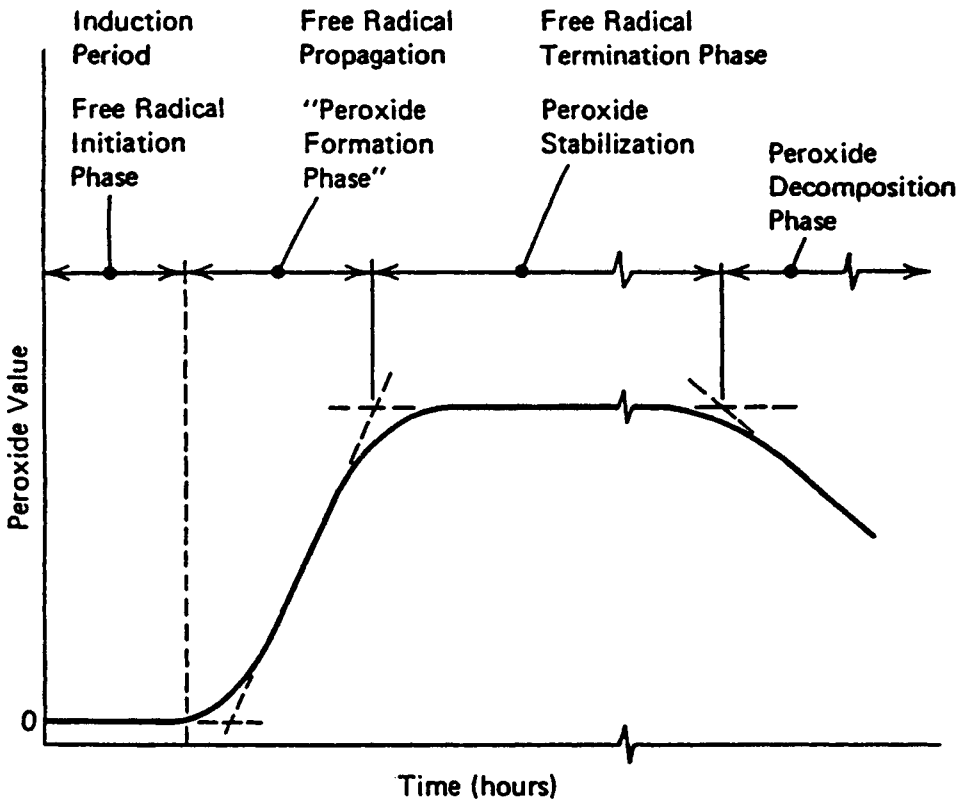
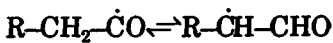
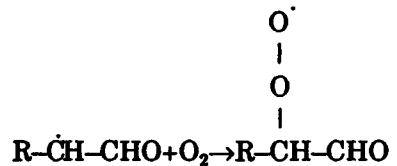

Figure 2-16 Peroxide Formation and Decomposition as a Function of Time

measure of secondary oxidation products.) Removal of oxygen from foods will prevent oxidation, but, in practice, this is not easy to accomplish in many cases. At high temperatures (100 to 140°C) such as those used in the accelerated tests for oil stability (active oxygen method), formic acid is produced, which can be used to indicate the end of the induction period. The formation of formic acid results from aldehyde decomposition. Peroxidation of aldehydes establishes a resonance equilibrium between two limiting forms.



The second hybrid ties up oxygen at the α carbon to yield the α -hydroperoxy aldehyde as follows:



Breakdown of oxygen and carbon bonds yields formic acid and a new aldehyde.

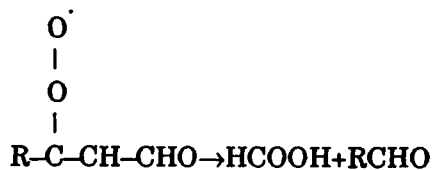

deMan et al. (1987) investigated this reaction with a variety of oils and found that although formic acid was the main reaction product, other short-chain acids from acetic to caproic were also formed. Trace metals, especially copper, and to a lesser extent iron, will catalyze fat oxidation; metal deactivators such as citric acid can be used to reduce the effect. Lipoygenase (lipoxidase) and heme compounds act as catalysts of lipid oxidation. Antioxidants can be very effective in slowing down oxidation and increasing the induction period. Many foods contain natural antioxidants; the tocopherols are the most important of these. They are present in greater amounts in vegetable oils than in animal fats, which may explain the former's greater stability.

Antioxidants such as tocopherols may be naturally present; they may be induced by processes such as smoking or roasting, or added as synthetic antioxidants. Antioxidants act by reacting with free radicals, thus terminating the chain. The antioxidant AH may react with the fatty acid free radical or with the peroxy free radical,

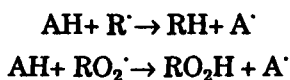

The antioxidant free radical deactivated by further oxidation to quinones, thus terminating the chain. Only phenolic compounds that can easily produce quinones are active as antioxidants (Pokorny 1971). At high concentrations antioxidants may have a prooxidant effect and one of the reactions may be as follows:

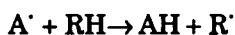

Tocopherols in natural fats are usually present at optimum levels. Addition of anti-

oxidant beyond optimum amounts may result in increasing the extent of prooxidant action. Lard is an example of a fat with very low natural antioxidant activity and antioxidant must be added to it, to provide protection. The effect of antioxidants can be expressed in terms of protection factor, as shown in Figure 2-17 (Pokorny 1971). The highly active antioxidants that are used in the food industry are active at about 10 to 50 parts per million (ppm). Chemical structure of the antioxidants is the most important factor affecting their activity. The number of synthetic antioxidants permitted in foods is limited, and the structure of the most widely used compounds is shown in Figure 2-18. Propyl gallate is more soluble in water than in fats. The octyl and dodecyl esters are more fat soluble. They are heat resistant and nonvolatile with steam, making them useful for frying oils and in baked products. These are considered to have *carry-through properties*. Butylated hydroxyanisole (BHA) has carry-through properties but butylated hydroxy toluene (BHT) does not, because it is volatile with steam. The compound *tert*-butyl hydroquinone (TBHQ) is used for its effectiveness in increasing oxidative stability of polyunsaturated oils and fats. It also provides carry-through protection for fried foods. Antioxidants are frequently used in combination or together with synergists. The latter are frequently metal deactivators that have the ability to chelate metal ions. An example of the combined effect of antioxidants is shown in Figure 2-19. It has been pointed out (Zambiasi and Przybylski 1998) that fatty acid composition can explain only about half of the oxidative stability of a vegetable oil. The other half can be contributed to minor components including tocopherols, metals, pigments, free fatty acids, phenols, phospholipids, and sterols.

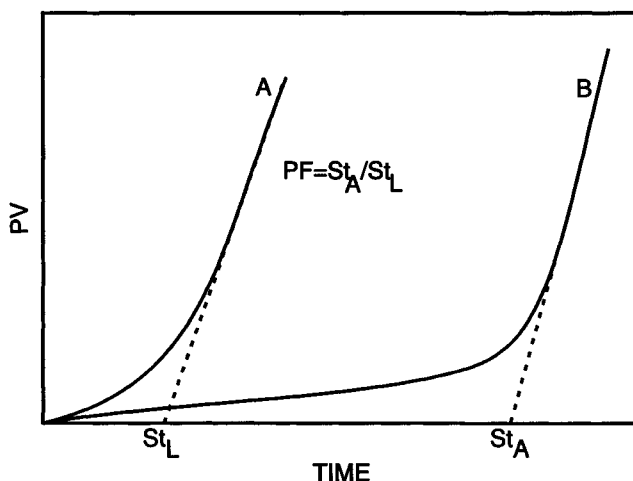

Figure 2-17 Determination of Protection Factor. (A) lard, (B) lard + antioxidant. *Source:* From J. Pokorny, Stabilization of Fats by Phenolic Antioxidants, *Can. Inst. Food Sci. Technol. J.*, Vol. 4, pp. 68-74, 1971.

PHOTOOXIDATION

Oxidation of lipids, in addition to the free radical process, can be brought about by at least two other mechanisms—photooxidation and enzymic oxidation by lipoxygenase. The latter is dealt with in Chapter 10. Light-

induced oxidation or photooxidation results from the reactivity of an excited state of oxygen, known as singlet oxygen (1O_2). Ground-state or normal oxygen is triplet oxygen (3O_2). The activation energy for the reaction of normal oxygen with an unsaturated fatty acid is very high, of the order of 146 to 273

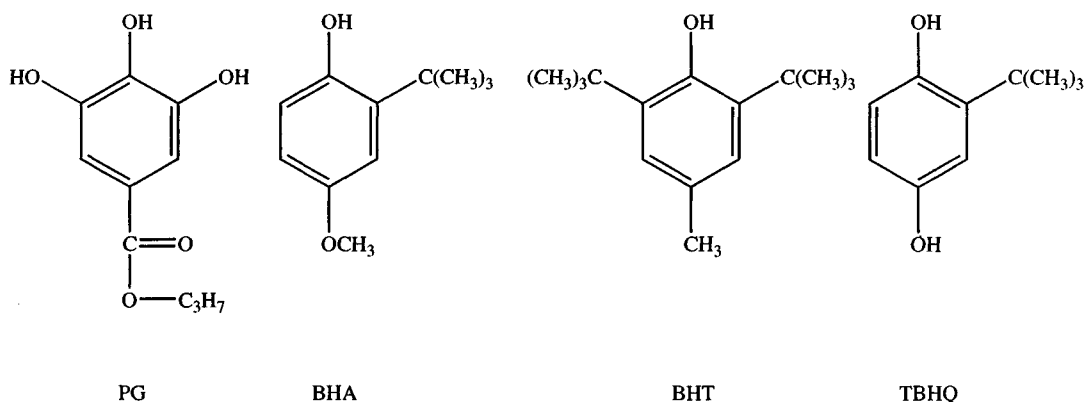

Figure 2-18 Structure of Propyl Gallate (PG), Butylated Hydroxyanisole (BHA), Butylated Hydroxytoluene (BHT), and Tert-Butyl Hydroquinone (TBHQ)

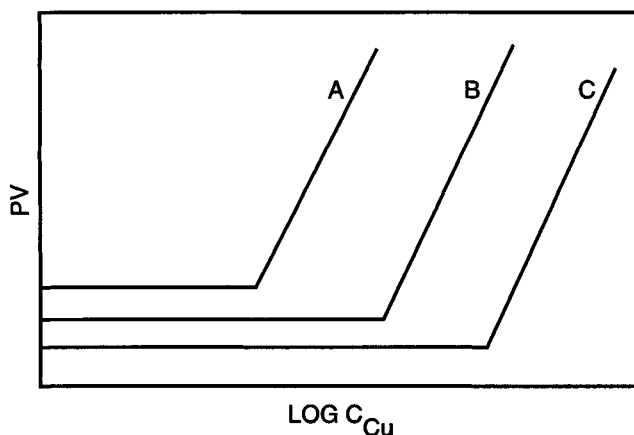
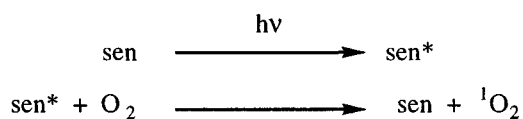

Figure 2-19 Effect of Copper Concentration on Protective Effect of Antioxidants in Lard. (A) lard + 0.01% BHT, (B) lard + 0.01% ascorbyl palmitate, (C) lard + 0.005% BHT and 0.05% ascorbyl palmitate. *Source:* From J. Pokorny, Stabilization of Fats by Phenolic Antioxidants, *Can. Inst. Food Sci. Technol. J.*, Vol. 4, pp. 68-74, 1971.

kJ/mole. When oxygen is converted from the ground state to the singlet state, energy is taken up amounting to 92 kJ/mole, and in this state the oxygen is much more reactive. Singlet-state oxygen production requires the presence of a sensitizer. The sensitizer is activated by light, and can then either react directly with the substrate (type I sensitizer) or activate oxygen to the singlet state (type II sensitizer). In both cases unsaturated fatty acid residues are converted into hydroperoxides. The light can be from the visible or ultraviolet region of the spectrum.

Singlet oxygen is short-lived and reverts back to the ground state with the emission of light. This light is fluorescent, which means that the wavelength of the emitted light is higher than that of the light that was absorbed for the excitation. The reactivity of singlet oxygen is 1,500 greater than that of ground-state oxygen. Compounds that can act as sensitizers are widely occurring food components, including chlorophyll, myoglobin, riboflavin, and heavy metals. Most of

these compounds promote type II oxidation reactions. In these reactions the sensitizer is transformed into the activated state by light. The activated sensitizer then reacts with oxygen to produce singlet oxygen.



The singlet oxygen can react directly with unsaturated fatty acids.

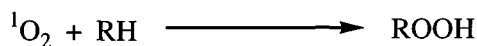

The singlet oxygen reacts directly with the double bond by addition, and shifts the double bond one carbon away. The singlet oxygen attack on linoleate produces four hydroperoxides as shown in Figure 2-20. Photooxidation has no induction period, but the reaction can be quenched by carotenoids

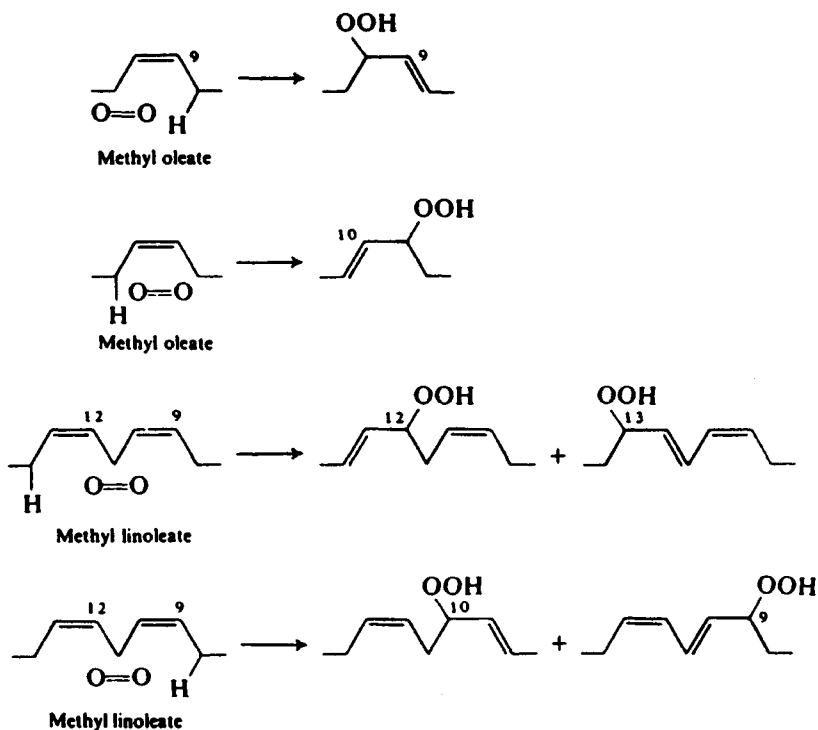

Figure 2–20 Photooxidation. Singlet-oxygen attack on oleate produces two hydroperoxides; linoleate yields four hydroperoxides

that effectively compete for the singlet oxygen and bring it back to the ground state.

Phenolic antioxidants do not protect fats from oxidation by singlet oxidation (Yasaei et al. 1996). However, the antioxidant ascorbyl palmitate is an effective singlet oxygen quencher (Lee et al. 1997). Carotenoids are widely used as quenchers. Rahmani and Csallany (1998) reported that in the photooxidation of virgin olive oil, pheophytin A functioned as sensitizer, while β -carotene acted as a quencher.

The combination of light and sensitizers is present in many foods displayed in transparent containers in brightly lit supermarkets. The light-induced deterioration of milk has been studied extensively. Sattar et al. (1976)

reported on the light-induced flavor deterioration of several oils and fats. Of the five fats examined, milk fat and soybean oil were most susceptible and corn oil least susceptible to singlet oxygen attack. The effect of temperature on the rate of oxidation of illuminated corn oil was reported by Chahine and deMan (1971) (Figure 2–21). They found that temperature has an important effect on photooxidation rates, but even freezing does not completely prevent oxidation.

HEATED FATS—FRYING

Fats and oils are heated during commercial processing and during frying. Heating during

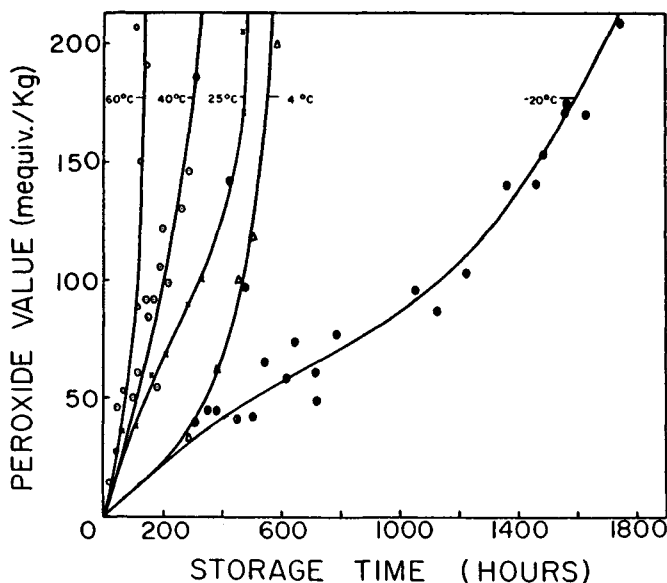

Figure 2-21 Effect of Temperature on Rate of Oxidation of Illuminated Corn Oil. *Source:* From M.H. Chahine and J.M. deMan, *Autoxidation of Corn Oil under the Influence of Fluorescent Light*, *Can. Inst. Food Sci. Technol. J.*, Vol. 4, pp. 24-28, 1971.

processing mainly involves hydrogenation, physical refining, and deodorization. Temperature used in these processes may range from 120°C to 270°C. The oil is not in contact with air, which eliminates the possibility of oxidation. At the high temperatures used in physical refining and deodorization, several chemical changes may take place. These include randomization of the glyceride structure, dimer formation, *cis-trans* isomerization, and formation of conjugated fatty acids (positional isomerization) of polyunsaturated fatty acids (Hoffmann 1989). The *trans* isomer formation in sunflower oil as a result of high temperature deodorization is shown in Figure 2-22 (Ackman 1994).

Conditions prevailing during frying are less favorable than those encountered in the above-mentioned processes. Deep frying, where the food is heated by immersion in hot

oil, is practiced in commercial frying as well as in food service operations. The temperatures used are in the range of 160°C to 195°C. At lower temperatures frying takes longer, and at higher temperatures deterioration of the oil is the limiting factor. Deep frying is a complex process involving both the oil and the food to be fried. The reactions taking place are schematically presented in Figure 2-23. Steam is given off during the frying, which removes volatile antioxidants, free fatty acids, and other volatiles. Contact with the air leads to autoxidation and the formation of a large number of degradation products. The presence of steam results in hydrolysis, with the production of free fatty acids and partial glycerides. At lower frying temperatures the food has to be fried longer to reach the desirable color, and this results in higher oil uptake. Oil absorption by fried

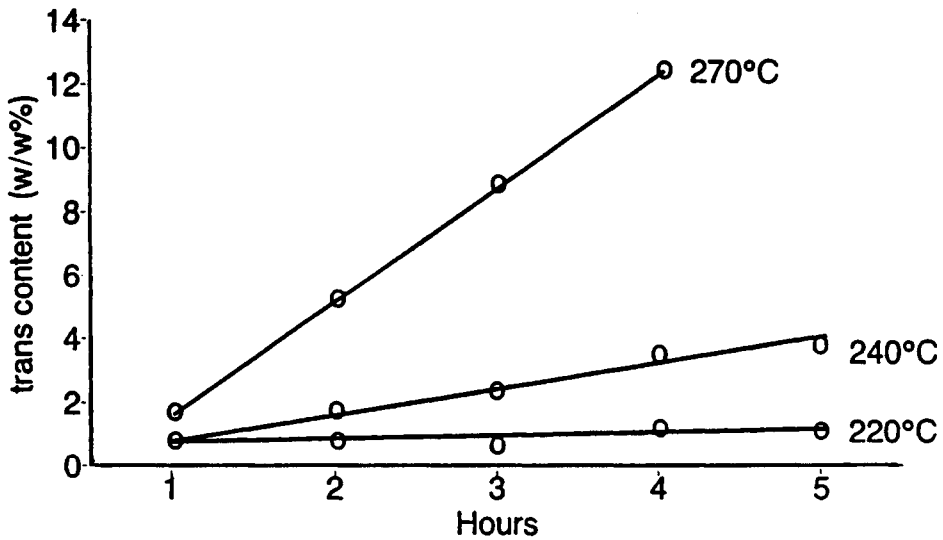

Figure 2-22 *Trans* Isomer Formation in Sunflower Oil as a Function of Deodorization Temperature. Source: Reprinted from R.G. Ackman, Animal and Marine Lipids, in *Improved and Technological Advances in Alternative Sources of Lipids*, B. Kamel and Y. Kakuda, eds., p. 301, 1994, Aspen Publishers, Inc.

foods may range from 10 to 40 percent, depending on conditions of frying and the nature and size of the food.

Oils used in deep frying must be of high quality because of the harsh conditions during deep frying and to provide satisfactory shelf life in fried foods. The suitability of an oil for frying is directly related to its content of unsaturated fatty acids, especially linolenic acid. This has been described by Erickson (1996) as “inherent stability” calculated from the level of each of the unsaturated fatty acids (oleic, linoleic, and linolenic) and their relative reaction rate with oxygen. The inherent stability calculated for a number of oils is given in Table 2-24. The higher the inherent stability, the less suitable the oil is for frying. The liquid seed oils, such as soybean and sunflower oil, are not suitable for deep frying and are usually partially hydrogenated for this purpose. Such hydrogenated oils can take the form of shortenings, which

may be plastic solids or pourable suspensions. Through plant breeding and genetic engineering, oils with higher inherent stability can be obtained, such as high-oleic sunflower oil, low-linolenic canola oil, and low-linolenic soybean oil.

The stability of frying oils and fats is usually measured by an accelerated test known as the active oxygen method (AOM). In this test, air is bubbled through an oil sample maintained at 95°C and the peroxide value is measured at intervals. At the end point the peroxide value shows a sharp increase, and this represents the AOM value in hours. Typical AOM values for liquid seed oils range from 10 to 30 hours; heavy-duty frying shortenings range from 200 to 300 hours. AOM values of some oils and fats determined by measuring the peroxide value and using an automatic recording of volatile acids produced during the test are given in Table 2-25 (deMan et al. 1987).

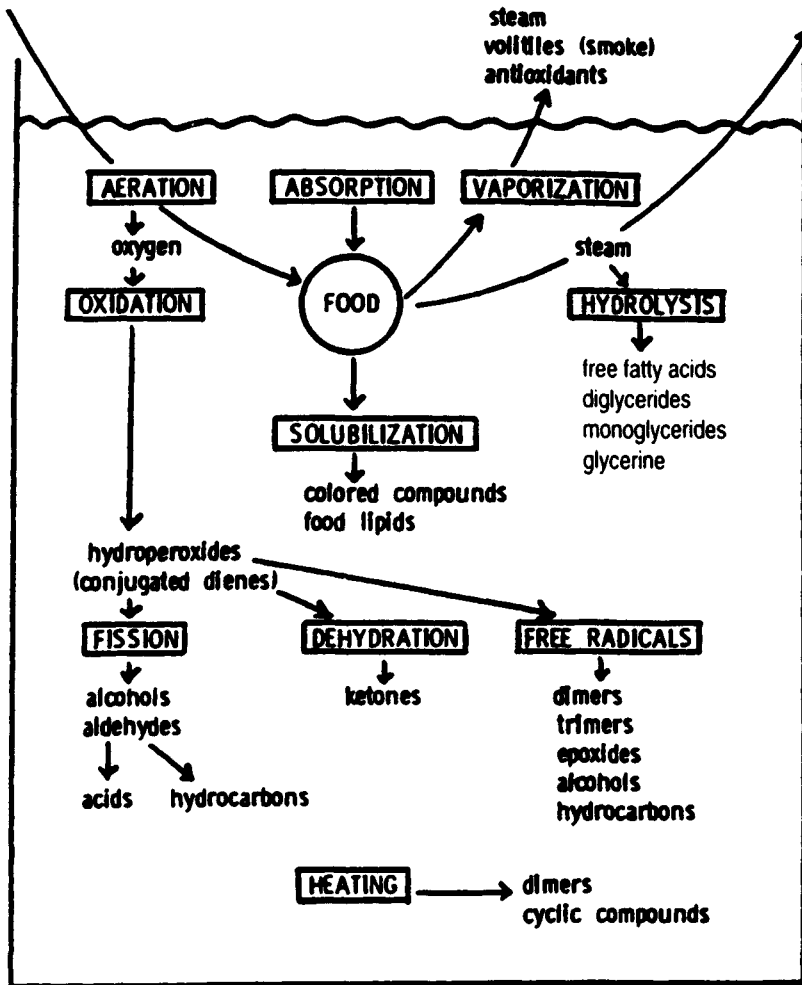

Figure 2-23 Summary of Chemical Reactions Occurring During Deep Frying. *Source:* Reprinted with permission from F.T. Orthoefer, S. Gurkin, and K. Lui, Dynamics of Frying in Deep Frying, in *Chemistry, Nutrition and Practical Applications*, E.G. Perkins and M.D. Erickson, eds., p. 224. © 1996, AOCS Press.

As shown in Figure 2-23, oil breakdown during frying can be caused by oxidation and thermal alteration. Oxidation can result in the formation of oxidized monomeric, dimeric, and oligomeric triglycerides as well as volatile compounds including aldehydes, ketones, alcohols, and hydrocarbons. In addition, oxidized sterols may be formed. Thermal degra-

dation can result in cyclic monomeric triglycerides and nonpolar dimeric and oligomeric triglycerides. The polymerization reaction may take place by conversion of part of the *cis-cis*-1,4 diene system of linoleates to the *trans-trans* conjugated diene. The 1,4 and 1,3 dienes can combine in a Diels-Alder type addition reaction to produce a dimer as

Table 2-24 Inherent Stability of Oils for Use in Frying

<i>Oil</i>	<i>Iodine Value</i>	<i>Inherent Stability*</i>
Soybean	130	7.4
Sunflower	120	7.7
High-oleic sunflower	90	2.0
Corn	110	6.2
Cottonseed	98	5.2
Canola	110	5.4
Peanut	92	4.5
Lard	60	1.4
Olive	88	1.8
Palm	55	1.4
Palm olein	58	1.6
Palm stearin	35	1.0
Tallow	50	0.7
Palm kernel	17	0.5
Coconut	9	0.4

*Inherent stability calculated from decimal fraction of fatty acids multiplied by relative reaction rates with oxygen, assuming rate for oleic acid = 1, linoleic acid = 10, and linolenic acid = 25.

Table 2-25 Active Oxygen Method (AOM) Time of Several Oils and Fats as Determined by Peroxide Value and Conductivity Measurements

<i>Oil</i>	<i>AOM Time (POV)^a</i>	<i>AOM Time (Conductivity)^b</i>
Sunflower	6.2	7.1
Canola	14.0	15.8
Olive	17.8	17.8
Corn	12.4	13.8
Peanut	21.1	21.5
Soybean	11.0	10.4
Triolein	8.1	7.4
Lard	42.7	43.2
Butterfat	2.8	2.0

^aAt peroxide value 100.

^bAt intercept of conductivity curve and time axis.

Source: Reprinted with permission from J.M. deMan, et al., Formation of Short Chain Volatile Organic Acids in the Automated AOM Method, *J.A.O.C.S.*, Vol. 64, p. 996, © 1987, American Oil Chemists' Society.

shown in Figure 2-24. Other possible routes for dimer formation are through free radical reactions. As shown in Figure 2-25, this may involve combination of radicals, intermolecular addition, and intramolecular addition. From dimers, higher oligomers can be produced; the structure of these is still relatively unknown.

Another class of compounds formed during frying is cyclic monomers of fatty acids. Linoleic acid can react at either the C9 or C12 double bonds to give rings between carbons 5 and 9, 5 and 10, 8 and 12, 12 and 17, and 13 and 17. Cyclic monomers with a cyclopentenyl ring have been isolated from heated sunflower oil, and their structure is illustrated in Figure 2-26 (Le Quéré and Sébédio 1996).

Some countries such as France require that frying oils contain less than 2 percent linolenic acid. Several European countries have set maximum limits for the level of polar

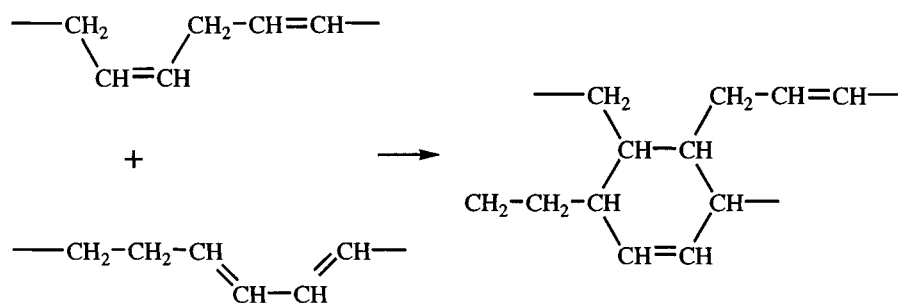

Figure 2-24 Polymerization of Diene Systems To Form Dimers

compounds or for the level of free fatty acids beyond which the fat is considered unfit for human consumption. In continuous industrial frying, oil is constantly being removed from the fryer with the fried food and replenished with fresh oil so that the quality of the oil can remain satisfactory. This is more difficult in intermittent frying operations.

FLAVOR REVERSION

Soybean oil and other fats and oils containing linolenic acid show the reversion phenomenon when exposed to air. Reversion flavor is a particular type of oxidized flavor that develops at comparatively low levels of oxidation. The off-flavors may develop in oils

a) Combination of radicals:

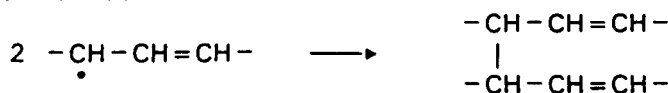

b) Intermolecular addition:

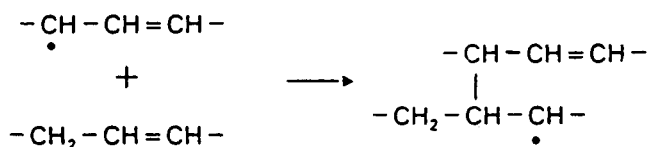

c) Intramolecular addition:

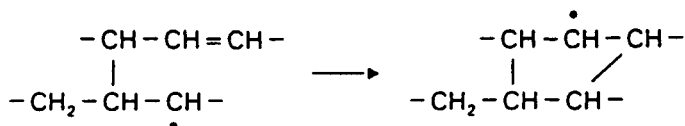

Figure 2-25 Nonpolar Dimer Formation Through Free Radical Reactions

Proteins

INTRODUCTION

Proteins are polymers of some 21 different amino acids joined together by peptide bonds. Because of the variety of side chains that occur when these amino acids are linked together, the different proteins may have different chemical properties and widely different secondary and tertiary structures. The various amino acids joined in a peptide chain are shown in Figure 3-1. The amino acids are grouped on the basis of the chemical nature of the side chains (Krull and Wall 1969). The side chains may be polar or non-polar. High levels of polar amino acid residues in a protein increase water solubility. The most polar side chains are those of the basic and acidic amino acids. These amino acids are present at high levels in the soluble albumins and globulins. In contrast, the wheat proteins, gliadin and glutenin, have low levels of polar side chains and are quite insoluble in water. The acidic amino acids may also be present in proteins in the form of their amides, glutamine and asparagine. This increases the nitrogen content of the protein. Hydroxyl groups in the side chains may become involved in ester linkages with phosphoric acid and phosphates. Sulfur amino acids may form disulfide cross-links between neighboring peptide chains or between dif-

ferent parts of the same chain. Proline and hydroxyproline impose significant structural limitations on the geometry of the peptide chain.

Proteins occur in animal as well as vegetable products in important quantities. In the developed countries, people obtain much of their protein from animal products. In other parts of the world, the major portion of dietary protein is derived from plant products. Many plant proteins are deficient in one or more of the essential amino acids. The protein content of some selected foods is listed in Table 3-1.

AMINO ACID COMPOSITION

Amino acids joined together by peptide bonds form the primary structure of proteins. The amino acid composition establishes the nature of secondary and tertiary structures. These, in turn, significantly influence the functional properties of food proteins and their behavior during processing. Of the 20 amino acids, only about half are essential for human nutrition. The amounts of these essential amino acids present in a protein and their availability determine the nutritional quality of the protein. In general, animal proteins are of higher quality than plant proteins. Plant

Structure	Name	Character of side chain
	Glutamic acid	Acidic
	Aspartic acid	
	Lysine	Basic
	Histidine	
	Arginine	
	Tyrosine	Hydroxyl
	Serine	
	Threonine	Amides
	Glutamine	
	Asparagine	
	Cysteine	Sulfur
	Cystine	
	Methionine	Hydrocarbon
	Glycine	
	Alanine	Hydrocarbon
	Valine	
	iso-Leucine	Hydrocarbon
	Leucine	
	Phenylalanine	Aromatic
	Tryptophan	
	Proline	Cyclic

Figure 3-1 Component Amino Acids of Proteins Joined by Peptide Bonds and Character of Side Chains. *Source:* From Northern Regional Research Laboratory, U.S. Department of Agriculture.

proteins can be upgraded nutritionally by judicious blending or by genetic modification through plant breeding. The amino acid composition of some selected animal and vegetable proteins is given in Table 3-2.

Egg protein is one of the best quality proteins and is considered to have a biological value of 100. It is widely used as a standard, and protein efficiency ratio (PER) values sometimes use egg white as a standard. Cereal proteins are generally deficient in lysine and threonine, as indicated in Table

Table 3-1 Protein Content of Some Selected Foods

Product	Protein (g/100 g)
Meat: beef	16.5
pork	10.2
Chicken (light meat)	23.4
Fish: haddock	18.3
cod	17.6
Milk	3.6
Egg	12.9
Wheat	13.3
Bread	8.7
Soybeans: dry, raw	34.1
cooked	11.0
Peas	6.3
Beans: dry, raw	22.3
cooked	7.8
Rice: white, raw	6.7
cooked	2.0
Cassava	1.6
Potato	2.0
Corn	10.0

Table 3-2 Amino Acid Content of Some Selected Foods (mg/g Total Nitrogen)

<i>Amino Acid</i>	<i>Meat (Beef)</i>	<i>Milk</i>	<i>Egg</i>	<i>Wheat</i>	<i>Peas</i>	<i>Corn</i>
Isoleucine	301	399	393	204	267	230
Leucine	507	782	551	417	425	783
Lysine	556	450	436	179	470	167
Methionine	169	156	210	94	57	120
Cystine	80	—	152	159	70	97
Phenylalanine	275	434	358	282	287	305
Tyrosine	225	396	260	187	171	239
Threonine	287	278	320	183	254	225
Valine	313	463	428	276	294	303
Arginine	395	160	381	288	595	262
Histidine	213	214	152	143	143	170
Alanine	365	255	370	226	255	471
Aspartic acid	562	424	601	308	685	392
Glutamic acid	955	1151	796	1866	1009	1184
Glycine	304	144	207	245	253	231
Proline	236	514	260	621	244	559
Serine	252	342	478	281	271	311

3-3. Soybean is a good source of lysine but is deficient in methionine. Cottonseed protein is deficient in lysine and peanut protein in methionine and lysine. The protein of potato although present in small quantity (Table 3-1) is of excellent quality and is equivalent to that of whole egg.

Table 3-3 Limiting Essential Amino Acids of Some Grain Proteins

<i>Grain</i>	<i>First Limiting Amino Acid</i>	<i>Second Limiting Amino Acid</i>
Wheat	Lysine	Threonine
Corn	Lysine	Tryptophan
Rice	Lysine	Threonine
Sorghum	Lysine	Threonine
Millet	Lysine	Threonine

PROTEIN CLASSIFICATION

Proteins are complex molecules, and classification has been based mostly on solubility in different solvents. Increasingly, however, as more knowledge about molecular composition and structure is obtained, other criteria are being used for classification. These include behavior in the ultracentrifuge and electrophoretic properties. Proteins are divided into the following main groups: simple, conjugated, and derived proteins.

Simple Proteins

Simple proteins yield only amino acids on hydrolysis and include the following classes:

- *Albumins*. Soluble in neutral, salt-free water. Usually these are proteins of relatively low molecular weight. Examples

are egg albumin, lactalbumin, and serum albumin in the whey proteins of milk, leucosin of cereals, and legumelin in legume seeds.

- *Globulins*. Soluble in neutral salt solutions and almost insoluble in water. Examples are serum globulins and β -lactoglobulin in milk, myosin and actin in meat, and glycinin in soybeans.
- *Glutelins*. Soluble in very dilute acid or base and insoluble in neutral solvents. These proteins occur in cereals, such as glutenin in wheat and oryzenin in rice.
- *Prolamins*. Soluble in 50 to 90 percent ethanol and insoluble in water. These proteins have large amounts of proline and glutamic acid and occur in cereals. Examples are zein in corn, gliadin in wheat, and hordein in barley.
- *Scleroproteins*. Insoluble in water and neutral solvents and resistant to enzymic hydrolysis. These are fibrous proteins serving structural and binding purposes. Collagen of muscle tissue is included in this group, as is gelatin, which is derived from it. Other examples include elastin, a component of tendons, and keratin, a component of hair and hoofs.
- *Histones*. Basic proteins, as defined by their high content of lysine and arginine. Soluble in water and precipitated by ammonia.
- *Protamines*. Strongly basic proteins of low molecular weight (4,000 to 8,000). They are rich in arginine. Examples are clupein from herring and scombrin from mackerel.

Conjugated Proteins

Conjugated proteins contain an amino acid part combined with a nonprotein material such as a lipid, nucleic acid, or carbohy-

drate. Some of the major conjugated proteins are as follows:

- *Phosphoproteins*. An important group that includes many major food proteins. Phosphate groups are linked to the hydroxyl groups of serine and threonine. This group includes casein of milk and the phosphoproteins of egg yolk.
- *Lipoproteins*. These are combinations of lipids with protein and have excellent emulsifying capacity. Lipoproteins occur in milk and egg yolk.
- *Nucleoproteins*. These are combinations of nucleic acids with protein. These compounds are found in cell nuclei.
- *Glycoproteins*. These are combinations of carbohydrates with protein. Usually the amount of carbohydrate is small, but some glycoproteins have carbohydrate contents of 8 to 20 percent. An example of such a mucoprotein is ovomucin of egg white.
- *Chromoproteins*. These are proteins with a colored prosthetic group. There are many compounds of this type, including hemoglobin and myoglobin, chlorophyll, and flavoproteins.

Derived Proteins

These are compounds obtained by chemical or enzymatic methods and are divided into primary and secondary derivatives, depending on the extent of change that has taken place. Primary derivatives are slightly modified and are insoluble in water; rennet-coagulated casein is an example of a primary derivative. Secondary derivatives are more extensively changed and include proteoses, peptones, and peptides. The difference between these breakdown products is in size and solubility. All are soluble in water and

not coagulated by heat, but proteoses can be precipitated with saturated ammonium sulfate solution. Peptides contain two or more amino acid residues. These breakdown products are formed during the processing of many foods, for example, during ripening of cheese.

PROTEIN STRUCTURE

Proteins are macromolecules with different levels of structural organization. The primary structure of proteins relates to the peptide bonds between component amino acids and also to the amino acid sequence in the molecule. Researchers have elucidated the amino acid sequence in many proteins. For example, the amino acid composition and sequence for several milk proteins is now well established (Swaigood 1982).

Some proteolytic enzymes have quite specific actions; they attack only a limited number of bonds, involving only particular amino acid residues in a particular sequence. This may lead to the accumulation of well-defined peptides during some enzymic proteolytic reactions in foods.

The secondary structure of proteins involves folding the primary structure. Hydrogen bonds between amide nitrogen and carbonyl oxygen are the major stabilizing force. These bonds may be formed between different areas of the same polypeptide chain or between adjacent chains. In aqueous media, the hydrogen bonds may be less significant, and van der Waals forces and hydrophobic interaction between apolar side chains may contribute to the stability of the secondary structure. The secondary structure may be either the α -helix or the sheet structure, as shown in Figure 3-2. The helical structures are stabilized by intramolecular hydrogen bonds, the sheet structures by intermolecular

hydrogen bonds. The requirements for maximum stability of the helix structure were established by Pauling et al. (1951). The helix model involves a translation of 0.54 nm per turn along the central axis. A complete turn is made for every 3.6 amino acid residues. Proteins do not necessarily have to occur in a complete α -helix configuration; rather, only parts of the peptide chains may be helical, with other areas of the chain in a more or less unordered configuration. Proteins with α -helix structure may be either globular or fibrous. In the parallel sheet structure, the polypeptide chains are almost fully extended and can form hydrogen bonds between adjacent chains. Such structures are generally insoluble in aqueous solvents and are fibrous in nature.

The tertiary structure of proteins involves a pattern of folding of the chains into a compact unit that is stabilized by hydrogen bonds, van der Waals forces, disulfide bridges, and hydrophobic interactions. The tertiary structure results in the formation of a tightly packed unit with most of the polar amino acid residues located on the outside and hydrated. This leaves the internal part with most of the apolar side chains and virtually no hydration. Certain amino acids, such as proline, disrupt the α -helix, and this causes fold regions with random structure (Kinsella 1982). The nature of the tertiary structure varies among proteins as does the ratio of α -helix and random coil. Insulin is loosely folded, and its tertiary structure is stabilized by disulfide bridges. Lysozyme and glycinin have disulfide bridges but are compactly folded.

Large molecules of molecular weights above about 50,000 may form quaternary structures by association of subunits. These structures may be stabilized by hydrogen bonds, disulfide bridges, and hydrophobic interactions. The bond energies involved in

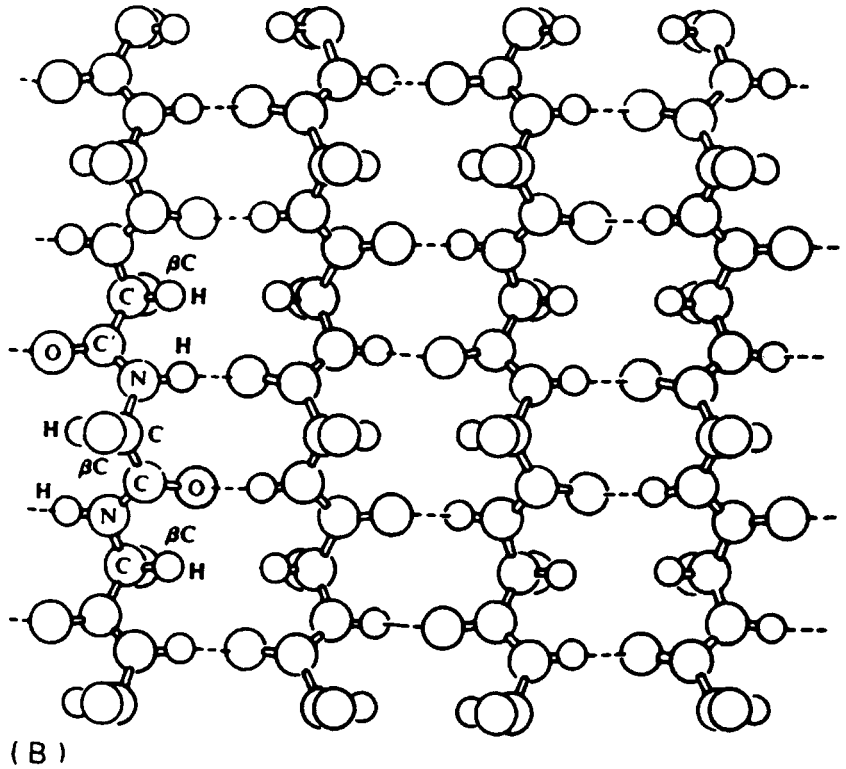
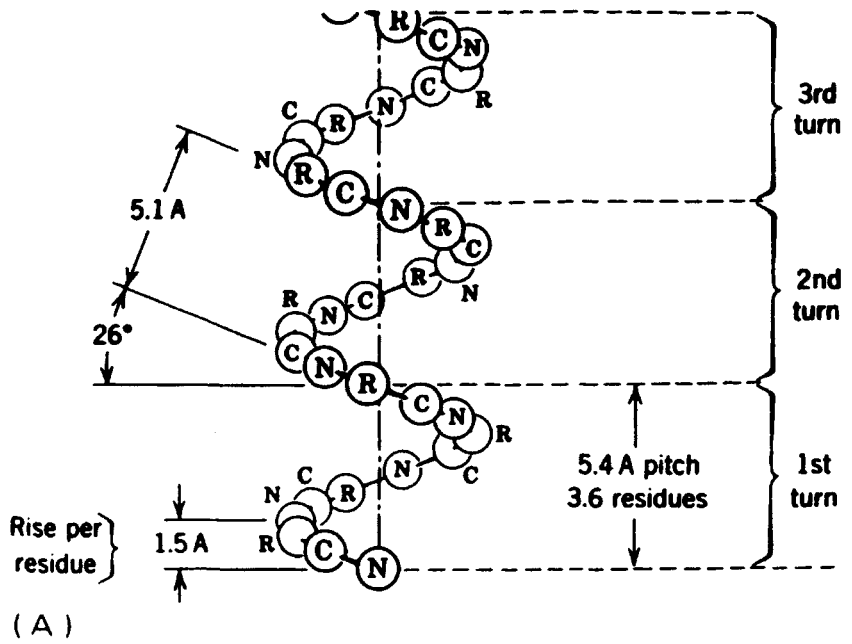

Figure 3-2 Secondary Structures of Proteins, (A) Alpha Helix, (B) Antiparallel Sheet

forming these structures are listed in Table 3-4.

The term *subunit* denotes a protein chain possessing an internal covalent and noncovalent structure that is capable of joining with other similar subunits through noncovalent forces or disulfide bonds to form an oligomeric macromolecule (Stanley and Yada 1992). Many food proteins are oligomeric and consist of a number of subunits, usually 2 or 4, but occasionally as many as 24. A listing of some oligomeric food proteins is given in Table 3-5. The subunits of proteins are held together by various types of bonds: electrostatic bonds involving carboxyl, amino, imidazole, and guanido groups; hydrogen bonds involving hydroxyl, amide, and phenol groups; hydrophobic bonds involving long-chain aliphatic residues or aromatic groups; and covalent disulfide bonds involving cystine residues. Hydrophobic bonds are not true bonds but have been described as interactions of nonpolar groups. These nonpolar groups or areas have a tendency to orient themselves to the interior of the protein molecule. This tendency depends on the relative number of nonpolar amino

Table 3-4 Bond Energies of the Bonds Involved in Protein Structure

<i>Bond</i>	<i>Bond Energy*</i> (kcal/mole)
Covalent C-C	83
Covalent S-S	50
Hydrogen bond	3-7
Ionic electrostatic bond	3-7
Hydrophobic bond	3-5
Van der Waals bond	1-2

*These refer to free energy required to break the bonds: in the case of a hydrophobic bond, the free energy required to unfold a nonpolar side chain from the interior of the molecule into the aqueous medium.

acid residues and their location in the peptide chain. Many food proteins, especially plant storage proteins, are highly hydrophobic—so much so that not all of the hydrophobic areas can be oriented toward the inside and have to be located on the surface. This is a possible factor in subunits association and in some cases may result in aggregation. The hydrophobicity values of some food proteins as reported by Stanley and Yada (1992) are listed in Table 3-6.

The well-defined secondary, tertiary, and quaternary structures are thought to arise directly from the primary structure. This means that a given combination of amino acids will automatically assume the type of structure that is most stable and possible given the considerations described by Pauling et al. (1951).

Table 3-5 Oligomeric Food Proteins

<i>Protein</i>	<i>Molecular Weight (d)</i>	<i>Subunits</i>
Lactoglobulin	35,000	2
Hemoglobin	64,500	4
Avidin	68,300	4
Lipoxygenase	108,000	2
Tyrosinase	128,000	4
Lactate dehydrogenase	140,000	4
7S soy protein	200,000	9
Invertase	210,000	4
Catalase	232,000	4
Collagen	300,000	3
11S soy protein	350,000	12
Legumin	360,000	6
Myosin	475,000	6

Source: Reprinted with permission from D.W. Stanley and R.Y. Yada, Thermal Reactions in Food Protein Systems, *Physical Chemistry of Foods*, H.G. Schwartzberg and R.H. Hartel, eds., p. 676, 1992, by courtesy of Marcel Dekker, Inc.

DENATURATION

Denaturation is a process that changes the molecular structure without breaking any of the peptide bonds of a protein. The process is peculiar to proteins and affects different proteins to different degrees, depending on the structure of a protein. Denaturation can be brought about by a variety of agents, of which the most important are heat, pH, salts, and surface effects. Considering the complexity of many food systems, it is not surprising that denaturation is a complex process that cannot easily be described in simple terms. Denaturation usually involves loss of biological activity and significant changes in some physical or functional properties such as solubility. The destruction of enzyme activity by heat is an important operation in food processing. In most cases, denaturation is nonreversible; however, there are some

exceptions, such as the recovery of some types of enzyme activity after heating. Heat denaturation is sometimes desirable—for example, the denaturation of whey proteins for the production of milk powder used in baking. The relationship among temperature, heating time, and the extent of whey protein denaturation in skim milk is demonstrated in Figure 3–3 (Harland et al. 1952).

The proteins of egg white are readily denatured by heat and by surface forces when egg white is whipped to a foam. Meat proteins are denatured in the temperature range 57 to 75°C, which has a profound effect on texture, water holding capacity, and shrinkage.

Denaturation may sometimes result in the flocculation of globular proteins but may also lead to the formation of gels. Foods may be denatured, and their proteins destabilized, during freezing and frozen storage. Fish proteins are particularly susceptible to destabilization. After freezing, fish may become tough and rubbery and lose moisture. The caseinate micelles of milk, which are quite stable to heat, may be destabilized by freezing. On frozen storage of milk, the stability of the caseinate progressively decreases, and this may lead to complete coagulation.

Protein denaturation and coagulation are aspects of heat stability that can be related to the amino acid composition and sequence of the protein. Denaturation can be defined as *a major change in the native structure that does not involve alteration of the amino acid sequence*. The effect of heat usually involves a change in the tertiary structure, leading to a less ordered arrangement of the polypeptide chains. The temperature range in which denaturation and coagulation of most proteins take place is about 55 to 75°C, as indicated in Table 3–7. There are some notable exceptions to this general pattern. Casein and gelatin are examples of proteins that can be

Table 3–6 Hydrophobicity Values of Some Food Proteins

<i>Protein</i>	<i>Hydrophobicity cal/residue</i>
Gliadin	1300
Bovine serum albumin	1120–1000
α-Lactalbumin	1050
β-Lactoglobulin	1050
Actin	1000
Ovalbumin	980
Collagen	880
Myosin	880
Casein	725
Whey protein	387
Gluten	349

Source: Reprinted with permission from D.W. Stanley and R.Y. Yada, Thermal Reactions in Food Protein Systems, *Physical Chemistry of Foods*, H.G. Schwartzberg and R.H. Hartel, eds., p. 677, 1992, by courtesy of Marcel Dekker, Inc.

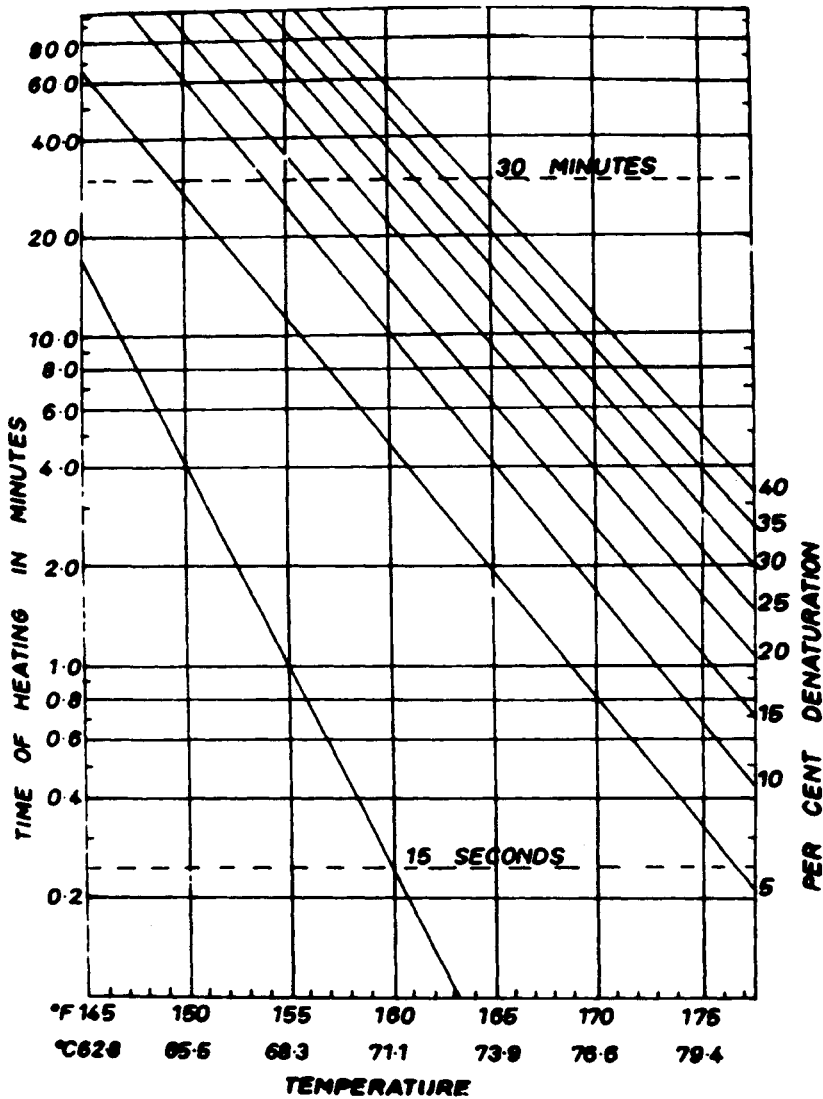

Figure 3-3 Time-Temperature Relationships for the Heat Denaturation of Whey Proteins in Skim Milk. *Source:* From H.A. Harland, S.T. Coulter, and R. Jenness, The Effects of Various Steps in the Manufacture on the Extent of Serum Protein Denaturation in Nonfat Dry Milk Solids. *J. Dairy Sci.* 35: 363-368, 1952.

boiled without apparent change in stability. The exceptional stability of casein makes it possible to boil, sterilize, and concentrate milk, without coagulation. The reasons for this exceptional stability have been discussed

by Kirchmeier (1962). In the first place, restricted formation of disulfide bonds due to low content of cystine and cysteine results in increased stability. The relationship between coagulation temperature as a measure of sta-

bility and sulfur amino acid content is shown in Tables 3-7 and 3-8. Peptides, which are low in these particular amino acids, are less likely to become involved in the type of sulfhydryl agglomeration shown in Figure 3-4. Casein, with its extremely low content of sulfur amino acids, exemplifies this behavior. The heat stability of casein is also explained by the restraints against forming a folded tertiary structure. These restraints are due to the relatively high content of proline and hydroxyproline in the heat stable proteins (Table 3-9). In a peptide chain free of proline, the possibility of forming inter- and intramolecular hydrogen bonds is better than in a chain containing many proline residues (Figure 3-5). These considerations show how amino acid composition directly relates to secondary and tertiary structure of proteins; these structures are, in turn, responsible for some of the physical properties of the protein and the food of which it is a part.

NONENZYMIC BROWNING

The nonenzymic browning or *Maillard reaction* is of great importance in food manufacturing and its results can be either desir-

able or undesirable. For example, the brown crust formation on bread is desirable; the brown discoloration of evaporated and sterilized milk is undesirable. For products in which the browning reaction is favorable, the resulting color and flavor characteristics are generally experienced as pleasant. In other products, color and flavor may become quite unpleasant.

The browning reaction can be defined as the sequence of events that begins with the reaction of the amino group of amino acids, peptides, or proteins with a glycosidic hydroxyl group of sugars; the sequence terminates with the formation of brown nitrogenous polymers or melanoidins (Ellis 1959).

The reaction velocity and pattern are influenced by the nature of the reacting amino acid or protein and the carbohydrate. This means that each kind of food may show a different browning pattern. Generally, lysine is the most reactive amino acid because of the free ϵ -amino group. Since lysine is the limiting essential amino acid in many food proteins, its destruction can substantially reduce the nutritional value of the protein. Foods that are rich in reducing sugars are very reactive, and this explains why lysine in milk is destroyed more easily than in other

Table 3-7 Heat Coagulation Temperatures of Some Albumins and Globulins and Casein

<i>Protein</i>	<i>Coagulation Temp. (°C)</i>
Egg albumin	56
Serum albumin (bovine)	67
Milk albumin (bovine)	72
Legumelin (pea)	60
Serum globulin (human)	75
β -Lactoglobulin (bovine)	70-75
Fibrinogen (human)	56-64
Myosin (rabbit)	47-56
Casein (bovine)	160-200

Table 3-8 Cysteine and Cystine Content of Some Proteins (g Amino Acid/100 g Protein)

<i>Protein</i>	<i>Cysteine (%)</i>	<i>Cystine (%)</i>
Egg albumin	1.4	0.5
Serum albumin (bovine)	0.3	5.7
Milk albumin	6.4	—
β -Lactoglobulin	1.1	2.3
Fibrinogen	0.4	2.3
Casein	—	0.3

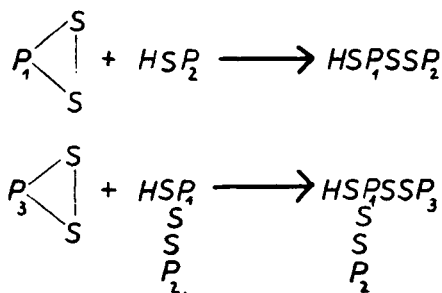

Figure 3-4 Reactions Involved in Sulfhydryl Polymerization of Proteins. *Source:* From O. Kirchmeier, *The Physical-Chemical Causes of the Heat Stability of Milk Proteins*, *Milchwissenschaft* (German), Vol. 17, pp. 408-412, 1962.

foods (Figure 3-6). Other factors that influence the browning reaction are temperature, pH, moisture level, oxygen, metals, phosphates, sulfur dioxide, and other inhibitors.

The browning reaction involves a number of steps. An outline of the total pathway of melanoidin formation has been given by Hodge (1953) and is shown in Figure 3-7. According to Hurst (1972), the following five steps are involved in the process:

1. The production of an *N*-substituted glycosylamine from an aldoose or ketose reacting with a primary amino group of an amino acid, peptide, or protein.
2. Rearrangement of the glycosylamine by an Amadori rearrangement type of reaction to yield an aldoseamine or ketoseamine.
3. A second rearrangement of the ketoseamine with a second mole of aldoose to form a diketoseamine, or the reaction

Table 3-9 Amino Acid Composition of Serum Albumin, Casein, and Gelatin (g Amino Acid/100 g Protein)

Amino Acid	Serum Albumin	Casein	Gelatin
Glycine	1.8	1.9	27.5
Alanine	6.3	3.1	11.0
Valine	5.9	6.8	2.6
Leucine	12.3	9.2	3.3
Isoleucine	2.6	5.6	1.7
Serine	4.2	5.3	4.2
Threonine	5.8	4.4	2.2
Cystine 1/2	6.0	0.3	0.0
Methionine	0.8	1.8	0.9
Phenylalanine	6.6	5.3	2.2
Tyrosine	5.1	5.7	0.3
Proline	4.8	13.5	16.4
Hydroxyproline	—	—	14.1
Aspartic acid	10.9	7.6	6.7
Glutamic acid	16.5	24.5	11.4
Lysine	12.8	8.9	4.5
Arginine	5.9	3.3	8.8
Histidine	4.0	3.8	0.8

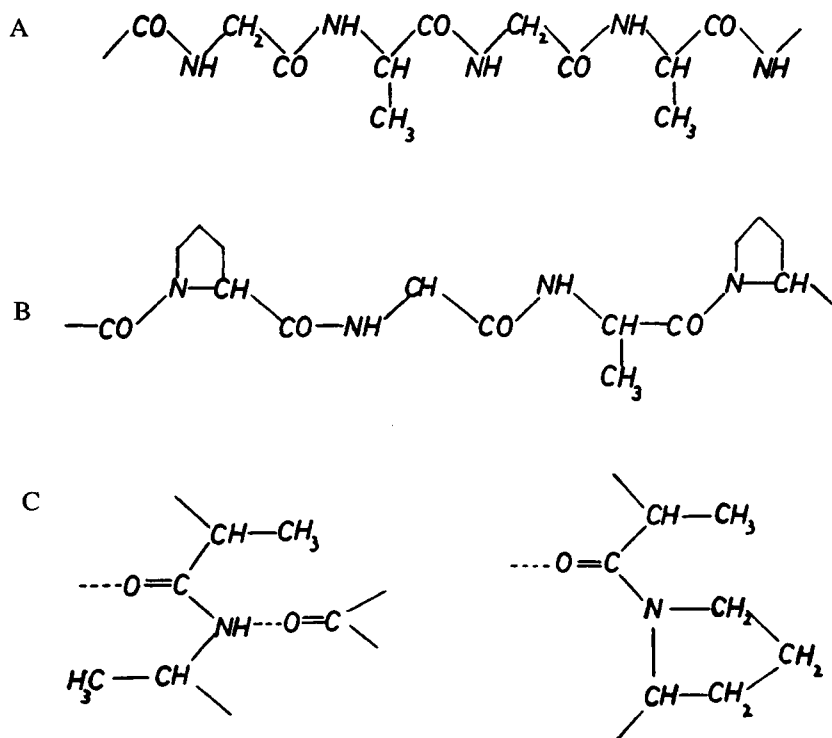

Figure 3-5 Effect of Proline Residues on Possible Hydrogen Bond Formation in Peptide Chains. (A) Proline-free chain; (B) proline-containing chain; (C) hydrogen bond formation in proline-free and proline-containing chains. *Source:* From O. Kirchner, *The Physical-Chemical Causes of the Heat Stability of Milk Proteins*, *Milchwissenschaft* (German), Vol. 17, pp. 408–412, 1962.

of an aldoseamine with a second mole of amino acid to yield a diamino sugar.

4. Degradation of the amino sugars with loss of one or more molecules of water to give amino or nonamino compounds.
5. Condensation of the compounds formed in Step 4 with each other or with amino compounds to form brown pigments and polymers.

The formation of glycosylamines from the reaction of amino groups and sugars is

reversible (Figure 3-8) and the equilibrium is highly dependent on the moisture level. The mechanism as shown is thought to involve addition of the amine to the carbonyl group of the open-chain form of the sugar, elimination of a molecule of water, and closure of the ring. The rate is high at low water content; this explains the ease of browning in dried and concentrated foods.

The Amadori rearrangement of the glycosylamines involves the presence of an acid catalyst and leads to the formation of ketose-amine or 1-amino-1-deoxyketose according

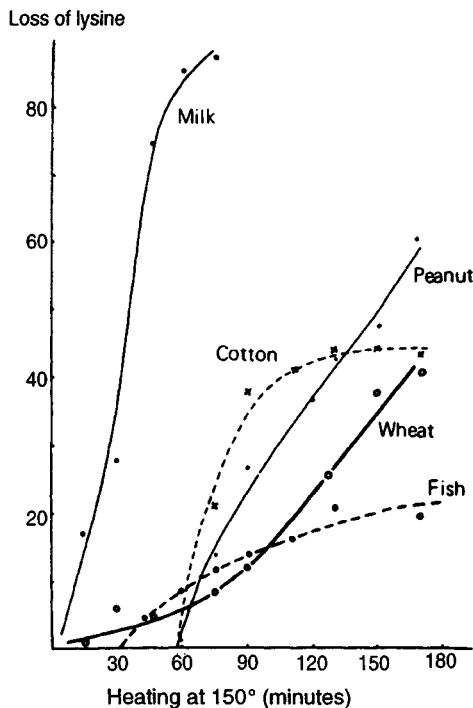

Figure 3-6 Loss of Lysine Occurring as a Result of Heating of Several Foods. *Source:* From J. Adrian, The Maillard Reaction. IV. Study on the Behavior of Some Amino Acids During Roasting of Proteinaceous Foods, *Ann. Nutr. Aliment.* (French), Vol. 21, pp. 129-147, 1967.

to the scheme shown in Figure 3-9. In the reaction of D-glucose with glycine, the amino acid reacts as the catalyst and the compound produced is 1-deoxy-1-glycino- β -D-fructose (Figure 3-10). The ketoseamines are relatively stable compounds, which are formed in maximum yield in systems with 18 percent water content. A second type of rearrangement reaction is the Heyns rearrangement, which is an alternative to the Amadori rearrangement and leads to the same type of transformation. The mechanism of the Amadori rearrangement (Figure 3-9) involves protonation of the nitrogen atom at carbon 1. The Heyns rearrangement (Figure 3-11) involves protonation of the oxygen at carbon 6.

Secondary reactions lead to the formation of diketoseamines and diamino sugars. The formation of these compounds involves complex reactions and, in contrast to the formation of the primary products, does not occur on a mole-for-mole basis.

In Step 4, the ketoseamines are decomposed by 1,2-enolization or 2,3-enolization. The former pathway appears to be the more important one for the formation of brown color, whereas the latter results in the formation of flavor products. According to Hurst (1972), the 1,2-enolization pathway appears mainly to lead to browning but also contributes to formation of off-flavors through hydroxymethylfurfural, which may be a fac-

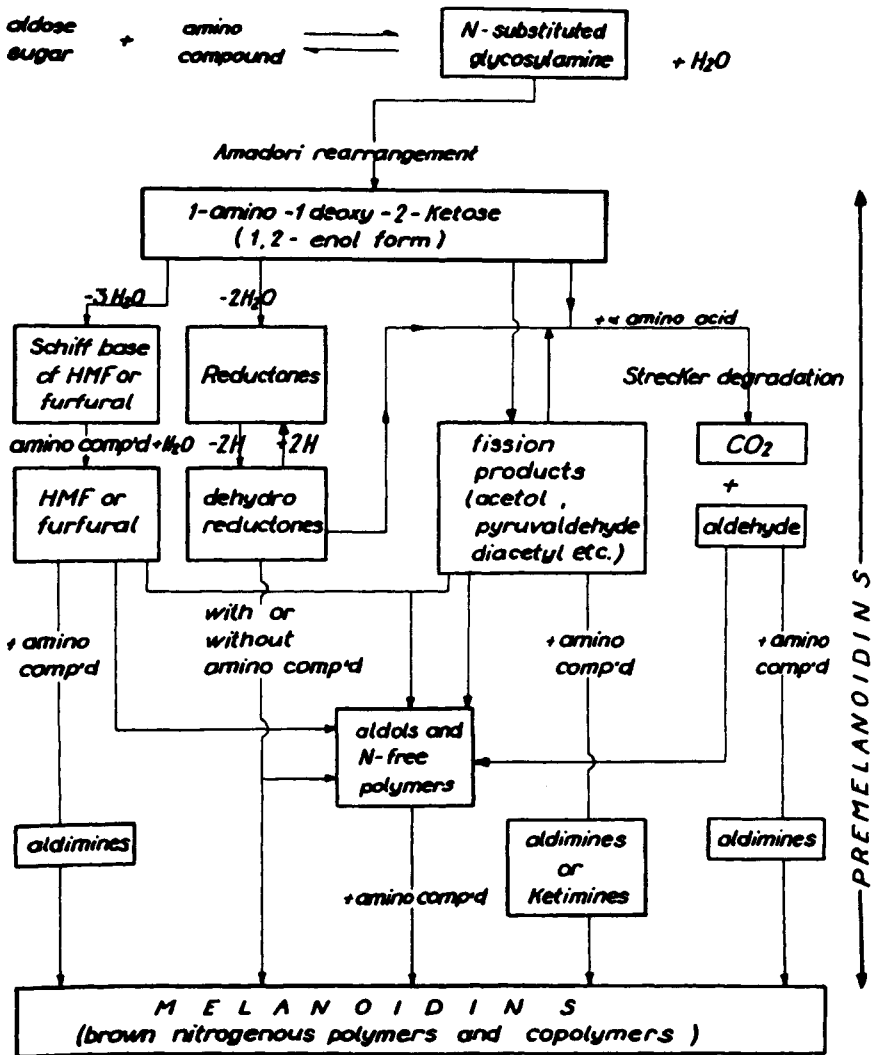

Figure 3-7 Reaction Pattern of the Formation of Melanoidins from Aldose Sugars and Amino Compounds. *Source:* From J.E. Hodge, *Chemistry of Browning Reactions in Model Systems, Agr. Food Chem.*, Vol. 1, pp. 928-943, 1953.

tor in causing off-flavors in stored, overheated, or dehydrated food products. The mechanism of this reaction is shown in Figure 3-12 (Hurst 1972). The ketoseamine (1) is protonated in acid medium to yield (2). This is changed in a reversible reaction into

the 1,2-enolamine (3) and this is assisted by the *N* substituent on carbon 1. The following steps involve the β -elimination of the hydroxyl group on carbon 3. In (4) the enolamine is in the free base form and converts to the Schiff base (5). The Schiff base may

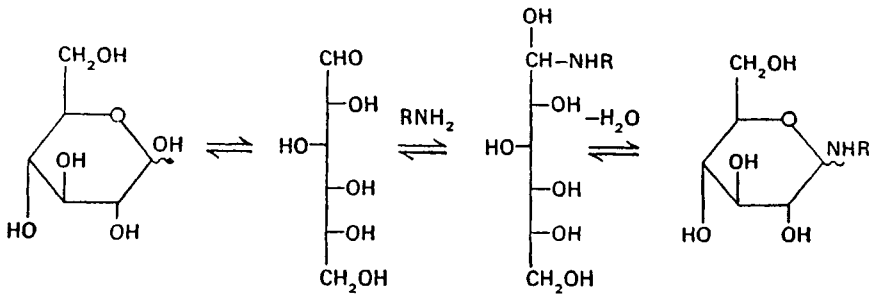

Figure 3-8 Reversible Formation of Glycosylamines in the Browning Reaction. *Source:* From D.T. Hurst, *Recent Development in the Study of Nonenzymic Browning and Its Inhibition by Sulphur Dioxide*, BFMIRA Scientific and Technical Surveys, No. 75, Leatherhead, England, 1972.

Amadori Rearrangement

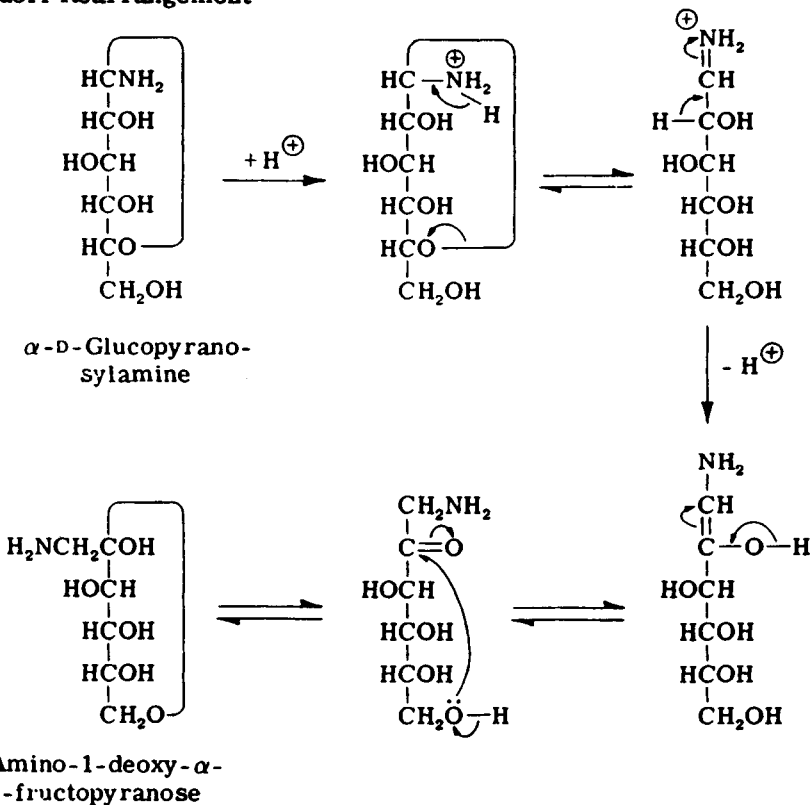

Figure 3-9 Amadori Rearrangement. *Source:* From M.J. Kort, *Reactions of Free Sugars with Aqueous Ammonia*, *Adv. Carbohydrate Chem. Biochem.*, Vol. 25, pp 311-349, 1970.

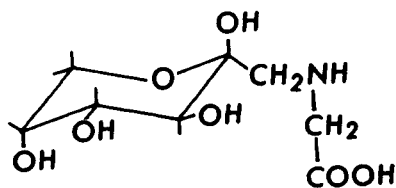

Figure 3-10 Structure of 1-Deoxy-1-Glycino- β -D-Fructose

undergo hydrolysis and form the enolform (7) of 3-deoxyosulose (8). In another step the Schiff base (5) may lose a proton and the hydroxyl from carbon 4 to yield a new Schiff base (6). Both this compound and the 3-deox-

osulose may be transformed into an unsaturated osulose (9), and by elimination of a proton and a hydroxyl group, hydroxymethylfurfural (10) is formed.

Following the production of 1,2-enol forms of aldose and ketose amines, a series of degradations and condensations results in the formation of melanoidins. The α - β -dicarbonyl compounds enter into aldol type condensations, which lead to the formation of polymers, initially of small size, highly hydrated, and in colloidal form. These initial products of condensation are fluorescent, and continuation of the reaction results in the formation of the brown melanoidins. These polymers are of nondistinct composition and contain

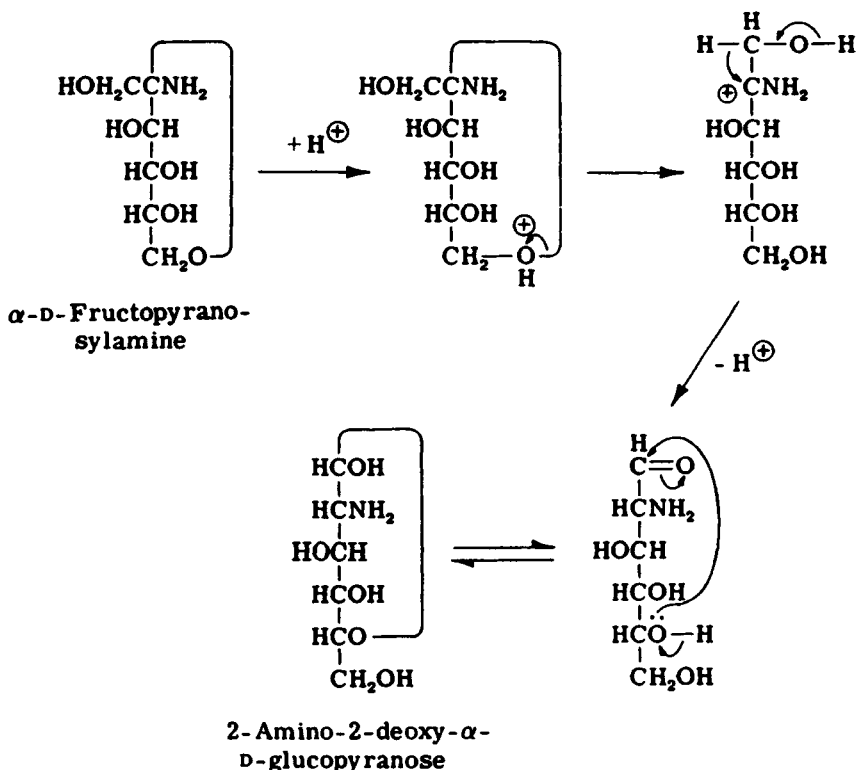

Figure 3-11 Heyns Rearrangement. *Source:* From M.J. Kort, Reactions of Free Sugars with Aqueous Ammonia, *Adv. Carbohydrate Chem. Biochem.*, Vol. 25, pp. 311-349, 1970.

varying levels of nitrogen. The composition varies with the nature of the reaction partners, pH, temperature, and other conditions.

The flavors produced by the Maillard reaction also vary widely. In some cases, the flavor is reminiscent of caramelization. The Strecker degradation of α -amino acids is a reaction that also significantly contributes to the formation of flavor compounds. The

dicarbonyl compounds formed in the previously described schemes react in the following manner with α -amino acids:

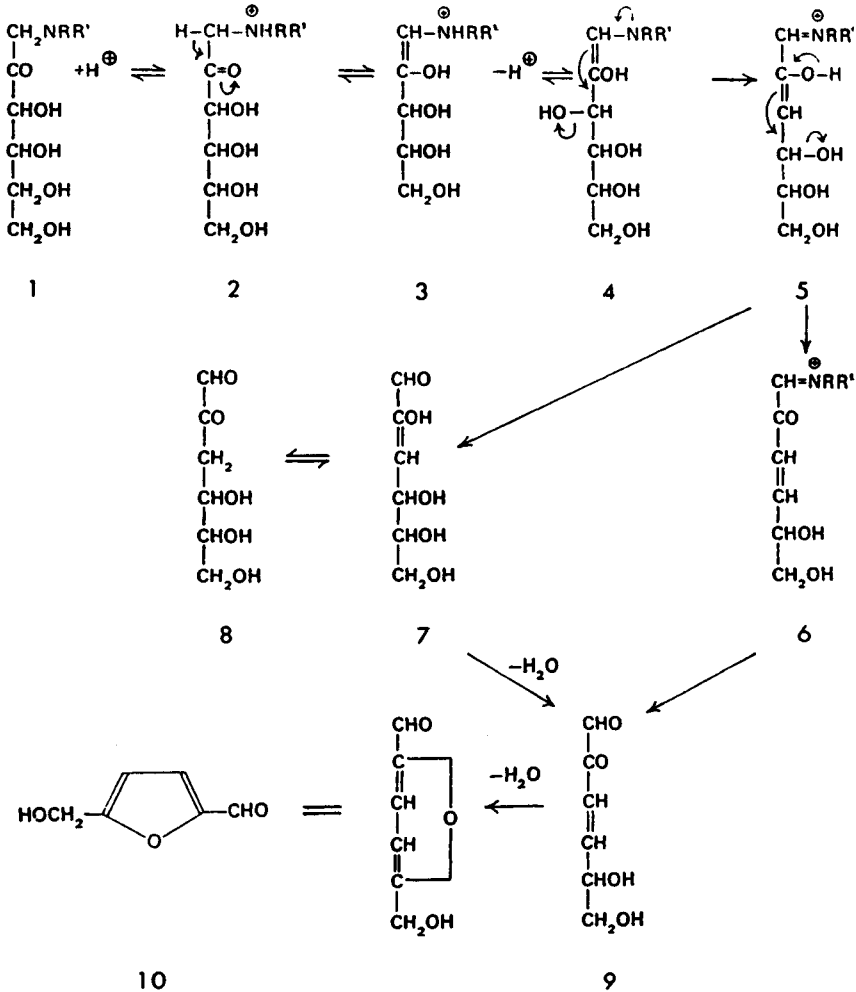
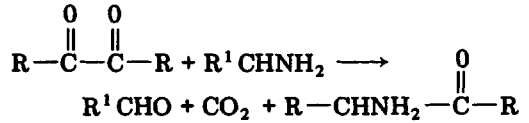

Figure 3-12 1,2-Enolization Mechanism of the Browning Reaction. *Source:* From D.T. Hurst, Recent Developments in the Study of Nonenzymic Browning and Its Inhibition by Sulphur Dioxide, BFMIRA Scientific and Technical Surveys, No. 75, Leatherhead, England, 1972.

The amino acid is converted into an aldehyde with one less carbon atom (Schönberg and Moubacher 1952). Some of the compounds of browning flavor have been described by Hodge et al. (1972). Corny, nutty, bready, and crackery aroma compounds consist of planar unsaturated heterocyclic compounds with one or two nitrogen atoms in the ring. Other important members of this group are partially saturated *N*-heterocyclics with alkyl or acetyl group substituents. Compounds that contribute to pungent, burnt aromas are listed in Table 3–10. These are mostly vicinal polycarbonyl compounds and α,β -unsaturated aldehydes. They condense rapidly to form melanoidins. The Strecker degradation aldehydes contribute to the aroma of bread, peanuts, cocoa, and other roasted foods. Although acetic, phenylacetic, isobutyric, and isovaleric aldehydes are prominent in the aromas of bread, malt, peanuts, and cocoa, they are not really characteristic of these foods (Hodge et al. 1972).

A somewhat different mechanism for the browning reaction has been proposed by Burton and McWeeney (1964) and is shown in Figure 3–13. After formation of the ald-sylamine, dehydration reactions result in the production of 4- to 6-membered ring compounds. When the reaction proceeds under conditions of moderate heating, fluorescent nitrogenous compounds are formed. These react rapidly with glycine to yield melanoidins.

The influence of reaction components and reaction conditions results in a wide variety of reaction patterns. Many of these conditions are interdependent. Increasing temperature results in a rapidly increasing rate of browning; not only reaction rate, but also the pattern of the reaction may change with temperature. In model systems, the rate of browning increases two to three times for

each 10° rise in temperature. In foods containing fructose, the increase may be 5 to 10 times for each 10° rise. At high sugar contents, the rate may be even more rapid. Temperature also affects the composition of the pigment formed. At higher temperatures, the carbon content of the pigment increases and more pigment is formed per mole of carbon dioxide released. Color intensity of the pigment increases with increasing temperature. The effect of temperature on the reaction rate of D-glucose with DL-leucine is illustrated in Figure 3–14.

In the Maillard reaction, the basic amino group disappears; therefore, the initial pH or the presence of a buffer has an important effect on the reaction. The browning reaction is slowed down by decreasing pH, and the browning reaction can be said to be self-inhibitory since the pH decreases with the loss of the basic amino group. The effect of pH on the reaction rate of D-glucose with DL-leucine is demonstrated in Figure 3–15. The effect of pH on the browning reaction is highly dependent on moisture content. When a large amount of water is present, most of the browning is caused by caramelization, but at low water levels and at pH greater than 6, the Maillard reaction is predominant.

The nature of the sugars in a nonenzymic browning reaction determines their reactivity. Reactivity is related to their conformational stability or to the amount of open-chain structure present in solution. Pentoses are more reactive than hexoses, and hexoses more than reducing disaccharides. Nonreducing disaccharides only react after hydrolysis has taken place. The order of reactivity of some of the aldohexoses is: mannose is more reactive than galactose, which is more reactive than glucose.

The effect of the type of amino acid can be summarized as follows. In the α -amino acid

Table 3-10 Aroma and Structure Classification of Browning Flavor Compounds

Aromas:	Burnt (pungent, empyreumatic)	Variable (aldehydic, ketonic)
Structure:	Polycarbonyls(α,β -Unsat'd aldehydes-C:O-C:O-,=C-CHO)	Monocarbonyls (R-CHO, R-C:O-CH ₃)
Examples of compounds:	Glyoxal Pyruvaldehyde Diacetyl Mesoxalic dialdehyde Acrolein Crotonaldehyde	Strecker aldehydes Isobutyric Isovaleric Methional 2-Furaldehydes 2-Pyrrole aldehydes C ₃ -C ₆ Methyl ketones

Source: From J.E. Hodge, F.D. Mills, and B.E. Fisher, Compounds of Browning Flavor from Sugar-Amine Reactions, *Cereal Sci. Today*, Vol. 17, pp. 34-40, 1972.

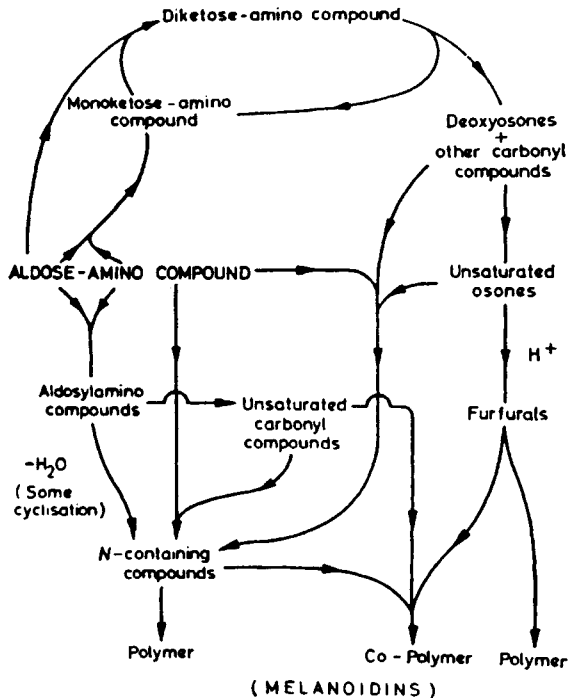

Figure 3-13 Proposed Browning Reaction Mechanism According to Burton and McWeeney. Source: From H.S. Burton and D.J. McWeeney, Non-Enzymatic Browning: Routes to the Production of Melanoidins from Aldoses and Amino Compounds, *Chem. Ind.*, Vol. 11, pp. 462-463, 1964.

series, glycine is the most reactive. Longer and more complex substituent groups reduce the rate of browning. In the ω -amino acid series, browning rate increases with increasing chain length. Ornithine browns more rapidly than lysine. When the reactant is a protein, particular sites in the molecule may react faster than others. In proteins, the ϵ -amino group of lysine is particularly vulnerable to attack by aldoses and ketoses.

Moisture content is an important factor in influencing the rate of the browning reaction. Browning occurs at low temperatures and intermediate moisture content; the rate increases with increasing water content. The rate is extremely low below the glass transi-

tion temperature, probably because of limited diffusion (Roos and Himberg 1994; Roos et al. 1996a, b).

Methods of preventing browning could consist of measures intended to slow reaction rates, such as control of moisture, temperature, or pH, or removal of an active intermediate. Generally, it is easier to use an inhibitor. One of the most effective inhibitors of browning is sulfur dioxide. The action of sulfur dioxide is unique and no other suitable inhibitor has been found. It is known that sulfite can combine with the carbonyl group of an aldose to give an addition compound:

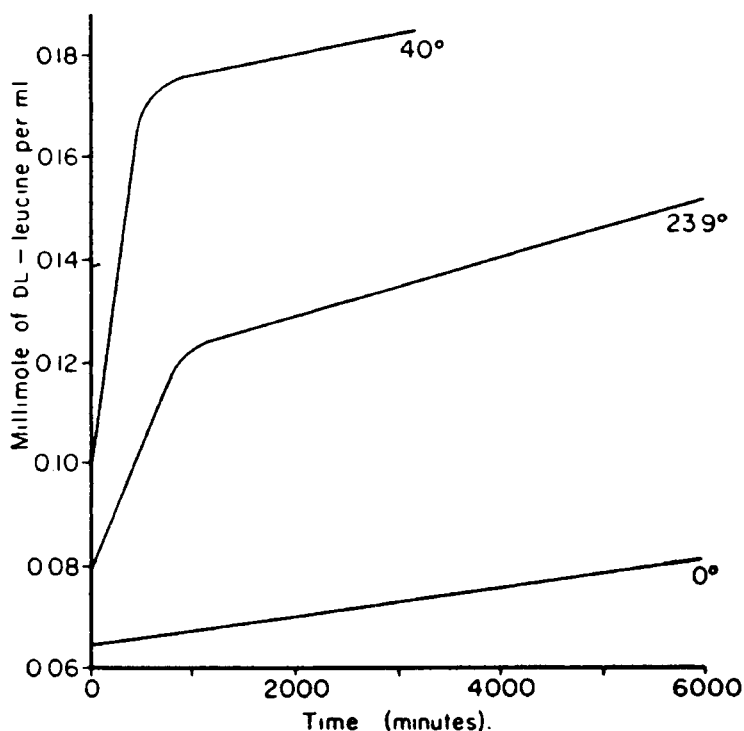
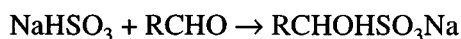

Figure 3-14 Effect of Temperature on the Reaction Rate of D-Glucose with DL-Leucine. *Source:* From G. Haugard, L. Tumerman, and A. Sylvestri, A Study on the Reaction of Aldoses and Amino Acids, *J. Am. Chem. Soc.*, Vol. 73, pp. 4594-4600, 1951.

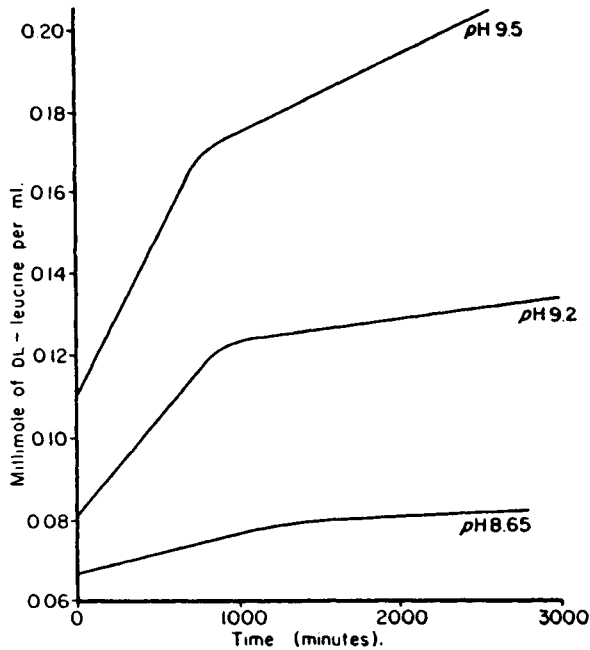

Figure 3-15 Effect of pH on the Reaction Rate of D-Glucose with DL-Leucine. *Source:* From G. Haugard, L. Tumerman, and A. Sylvestri, A Study on the Reaction of Aldoses and Amino Acids, *J. Am. Chem. Soc.*, Vol. 73, pp. 4594-4600, 1951.

However, this reaction cannot possibly account for the inhibitory effect of sulfite. It is thought that sulfur dioxide reacts with the degradation products of the amino sugars, thus preventing these compounds from condensing into melanoidins. A serious drawback of the use of sulfur dioxide is that it reacts with thiamine and proteins, thereby reducing the nutritional value of foods. Sulfur dioxide destroys thiamine and is therefore not permitted for use in foods containing this vitamin.

CHEMICAL CHANGES

During processing and storage of foods, a number of chemical changes involving proteins may occur (Hurrell 1984). Some of these may be desirable, others undesirable.

Such chemical changes may lead to compounds that are not hydrolyzable by intestinal enzymes or to modifications of the peptide side chains that render certain amino acids unavailable. Mild heat treatments in the presence of water can significantly improve the protein's nutritional value in some cases. Sulfur-containing amino acids may become more available and certain antinutritional factors such as the trypsin inhibitors of soybeans may be deactivated. Excessive heat in the absence of water can be detrimental to protein quality; for example, in fish proteins, tryptophan, arginine, methionine, and lysine may be damaged. A number of chemical reactions may take place during heat treatment including decomposition, dehydration of serine and threonine, loss of sulfur from cysteine, oxidation of cysteine and methio-

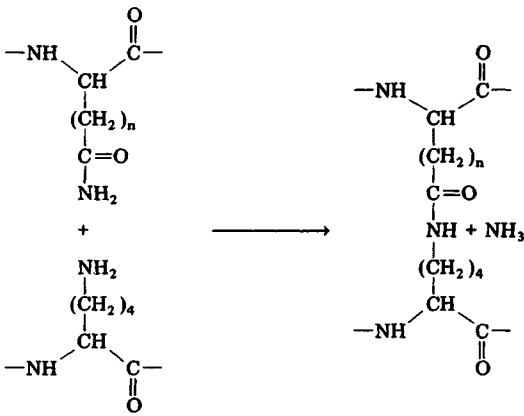
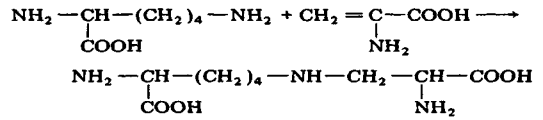

Figure 3-16 Formation of Amide-Type Bonds from the Reaction Between ε-amine Groups of Lysine and Amide Groups of Asparagine ($n = 1$) Glutamine ($n = 2$). Source: From J. Bjarnason and K. J. Carpenter, Mechanisms of Heat Damage in Proteins. 2 Chemical Changes in Pure Proteins, Brit. J. Nutr., Vol. 24, pp. 313-329, 1970.

group of lysine to yield lysinoalanine (Ziegler 1964) as shown:



Lysinoalanine formation is not restricted to alkaline conditions—it can also be formed by prolonged heat treatment. Any factor favoring lower pH and less drastic heat treatment will reduce the formation of lysinoalanine. Hurrell (1984) found that dried whole milk and UHT milk contained no lysinoalanine and that evaporated and sterilized milk contained 1,000 ppm. More severe treatment with alkali can decompose arginine into ornithine and urea. Ornithine can combine with dehydroalanine in a reaction similar to the one giving lysinoalanine and, in this case, ornithinoalanine is formed.

acrylic acid and thiocysteine by a β-elimination mechanism, as follows:

Treatment of proteins with ammonia can result in addition of ammonia to dehydroalanine to yield β-amino-alanine as follows:

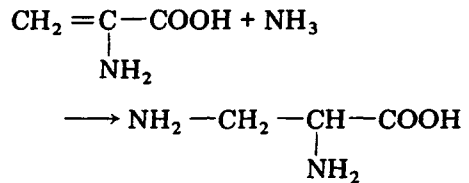
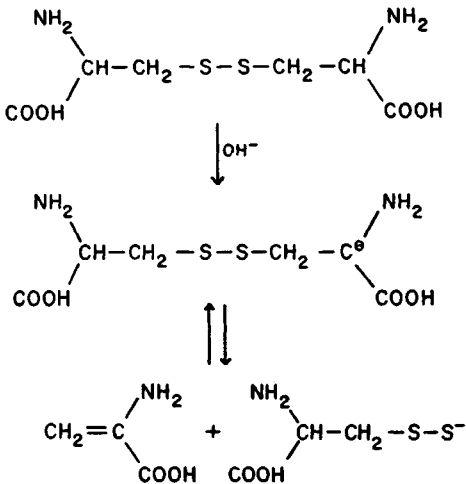

Amino-acrylic acid (dehydroalanine) is very reactive and can combine with the ε-amino

Light-induced oxidation of proteins has been shown to lead to off-flavors and destruction of essential amino acids in milk. Patton (1954) demonstrated that sunlight attacks methionine and converts it into methional (β-methylmercaptpropionaldehyde), which can cause a typical sunlight off-flavor at a level of 0.1 ppm. It was later demonstrated by Finley and Shipe (1971) that the source of the light-induced off-flavor in milk resides in a low-density lipoprotein fraction.

Table 3-11 Oxidation Products of the Sulfur-Containing Amino Acids

<i>Name</i>	<i>Formula</i>
Methionine	R-S-CH ₃
Sulfoxide	R-SO-CH ₃
Sulfone	R-SO ₂ -CH ₃
Cystine	R-S-S-R
Disulfoxide	R-SO-SO-R
Disulfone	R-SO ₂ -SO ₂ -R
Cysteine	R-SH
Sulfenic	R-SOH
Sulfinic	R-SO ₂ H
Sulfonic (or cysteic acid)	R-SO ₃ H

Proteins react with polyphenols such as phenolic acids, flavonoids, and tannins, which occur widely in plant products. These reactions may result in the lowering of available lysine, protein digestibility, and biological value (Hurrell 1984).

Racemization is the result of heat and alkaline treatment of food proteins. The amino acids present in proteins are of the L-series. The racemization reaction starts with the abstraction of an α -proton from an amino acid residue to give a negatively charged planar carbanion. When a proton is added back to this optically inactive intermediate, either a D- or L-enantiomer may be formed (Masters and Friedman 1980). Racemization leads to reduced digestibility and protein quality.

FUNCTIONAL PROPERTIES

Increasing emphasis is being placed on isolating proteins from various sources and using them as food ingredients. In many applications functional properties are of

great importance. Functional properties have been defined as those physical and chemical properties that affect the behavior of proteins in food systems during processing, storage, preparation, and consumption (Kinsella 1982). A summary of these properties is given in Table 3-12.

Even when protein ingredients are added to food in relatively small amounts, they may significantly influence some of the physical properties of the food. Hermansson (1973) found that addition of 4 percent of a soybean protein isolate to processed meat significantly affected firmness, as measured by extrusion force, compression work, and sensory evaluation.

The emulsifying and foaming properties of proteins relate to their adsorption at interfaces and to the structure of the protein film formed there (Mitchell 1986). The emulsifying and emulsion stabilizing capacity of protein meat additives is important to the production of sausages. The emulsifying properties of proteins are also involved in the production of whipped toppings and coffee whiteners. The whipping properties of proteins are essential in the production of whipped toppings. Paulsen and Horan (1965) determined the functional characteristics of edible soya flours, especially in relation to their use in bakery products. They evaluated the measurable parameters of functional properties such as water dispersibility, wettability, solubility, and foaming characteristics as those properties affected the quality of baked products containing added soya flour.

Some typical functional properties of food proteins are listed in Table 3-13.

Surface Activity of Proteins

Proteins can act as surfactants in stabilizing emulsions and foams. To perform this function proteins must be amphiphilic just

Carbohydrates

INTRODUCTION

Carbohydrates occur in plant and animal tissues as well as in microorganisms in many different forms and levels. In animal organisms, the main sugar is glucose and the storage carbohydrate is glycogen; in milk, the main sugar is almost exclusively the disaccharide lactose. In plant organisms, a wide variety of monosaccharides and oligosaccharides occur, and the storage carbohydrate is starch. The structural polysaccharide of plants is cellulose. The gums are a varied group of polysaccharides obtained from plants, seaweeds, and microorganisms. Because of their useful physical properties, the gums have found widespread application in food processing. The carbohydrates that occur in a number of food products are listed in Table 4-1.

MONOSACCHARIDES

D-glucose is the most important monosaccharide and is derived from the simplest sugar, D-glyceraldehyde, which is classed as an aldotriose. The designation of aldose and ketose sugars indicates the chemical character of the reducing form of a sugar and can be indicated by the simple or open-chain formula of Fischer, as shown in Figure 4-1. This

type of formula shows the free aldehyde group and four optically active secondary hydroxyls. Since the chemical reactions of the sugars do not correspond to this structure, a ring configuration involving a hemiacetal between carbons 1 and 5 more accurately represents the structure of the monosaccharides. The five-membered ring structure is called furanose; the six-membered ring, pyranose. Such rings are heterocyclic because one member is an oxygen atom. When the reducing group becomes involved in a hemiacetal ring structure, carbon 1 becomes asymmetric and two isomers are possible; these are called anomers.

Most natural sugars are members of the D series. The designation D or L refers to two series of sugars. In the D series, the highest numbered asymmetric carbon has the OH group directed to the right, in the Fischer projection formula. In the L series, this hydroxyl points to the left. This originates from the simplest sugars, D- and L-glyceraldehyde (Figure 4-2).

After the introduction of the Fischer formulas came the use of the Haworth representation, which was an attempt to give a more accurate spatial view of the molecule. Because the Haworth formula does not account for the actual bond angles, the modern con-

Table 4-1 Carbohydrates in Some Foods and Food Products

<i>Product</i>	<i>Total Sugar (%)</i>	<i>Mono- and Disaccharides (%)</i>	<i>Polysaccharides (%)</i>
Fruits			
Apple	14.5	glucose 1.17; fructose 6.04; sucrose 3.78; mannose trace	starch 1.5; cellulose 1.0
Grape	17.3	glucose 5.35; fructose 5.33; sucrose 1.32; mannose 2.19	cellulose 0.6
Strawberry	8.4	glucose 2.09; fructose 2.40; sucrose 1.03; mannose 0.07	cellulose 1.3
Vegetables			
Carrot	9.7	glucose 0.85; fructose 0.85; sucrose 4.25	starch 7.8; cellulose 1.0
Onion	8.7	glucose 2.07; fructose 1.09; sucrose 0.89	cellulose 0.71
Peanuts	18.6	sucrose 4-12	cellulose 2.4
Potato	17.1		starch 14; cellulose 0.5
Sweet corn	22.1	sucrose 12-17	cellulose 0.7; cellulose 60
Sweet potato	26.3	glucose 0.87; sucrose 2-3	starch 14.65; cellulose 0.7
Turnip	6.6	glucose 1.5; fructose 1.18; sucrose 0.42	cellulose 0.9
Others			
Honey	82.3	glucose 28-35; fructose 34-41; sucrose 1-5	
Maple syrup	65.5	sucrose 58.2-65.5; hexoses 0.0-7.9	
Meat		glucose 0.01	glycogen 0.10
Milk	4.9	lactose 4.9	
Sugarbeet	18-20	sucrose 18-20	
Sugar cane juice	14-28	glucose + fructose 4-8; sucrose 10-20	

formational formulas (Figure 4-1) more accurately represent the sugar molecule. A number of chair conformations of pyranose sugars are possible (Shallenberger and Birch 1975) and the two most important ones for

glucose are shown in Figure 4-1. These are named the *CI D* and the *IC D* forms (also described as *O-outside* and *O-inside*, respectively). In the *CI D* form of β -D-gluco-pyranose, all hydroxyls are in the equatorial

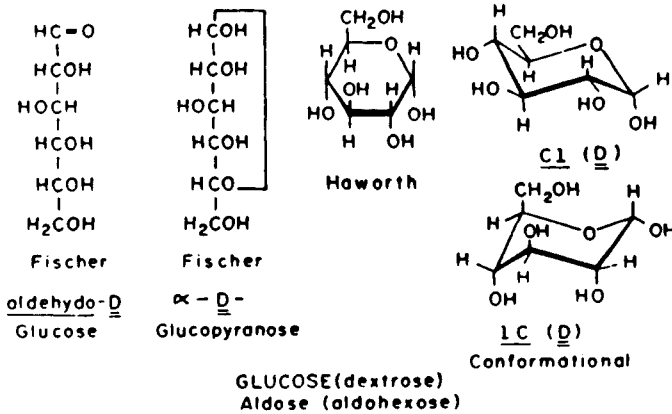

Figure 4-1 Methods of Representation of D-Glucose. *Source:* From M.L. Wolfrom, Physical and Chemical Structures of Carbohydrates, in *Symposium on Foods: Carbohydrates and Their Roles*, H.W. Schultz, R.F. Cain, and R.W. Wrolstad, eds., 1969, AVI Publishing Co.

position, which represents the highest thermodynamic stability.

The two possible anomeric forms of monosaccharides are designated by Greek letter prefix α or β . In the α -anomer the hydroxyl group points to the right, according to the Fischer projection formula; the hydroxyl group points to the left in the β -anomer. In Figure 4-1 the structure marked C1 D represents the α -anomer, and 1C D represents the β -anomer. The anomeric forms of the sugars are in tautomeric equilibrium in solution; and this causes the change in optical rotation when a sugar is placed in

solution. Under normal conditions, it may take several hours or longer before the equilibrium is established and the optical rotation reaches its equilibrium value. At room temperature an aqueous solution of glucose can exist in four tautomeric forms (Angyal 1984): β -furanoside—0.14 percent, acyclic aldehyde—0.0026 percent, β -pyranoside—62 percent, and α -pyranoside—38 percent (Figure 4-3). Fructose under the same conditions also exists in four tautomeric forms as follows: α -pyranoside—trace, β -pyranoside—75 percent, α -furanoside—4 percent, and β -furanoside—21 percent (Figure 4-4) (Angyal 1976).

When the monosaccharides become involved in condensation into di-, oligo-, and polysaccharides, the conformation of the bond on the number 1 carbon becomes fixed and the different compounds have either an all- α or all- β structure at this position.

Naturally occurring sugars are mostly hexoses, but sugars with different numbers of carbons are also present in many products. There are also sugars with different func-

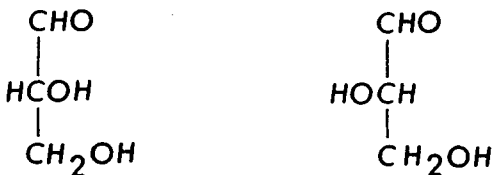

Figure 4-2 Structure of D- and L-Glyceraldehyde. *Source:* From R.S. Shallenberger and G.G. Birch, *Sugar Chemistry*, 1975, AVI Publishing Co.

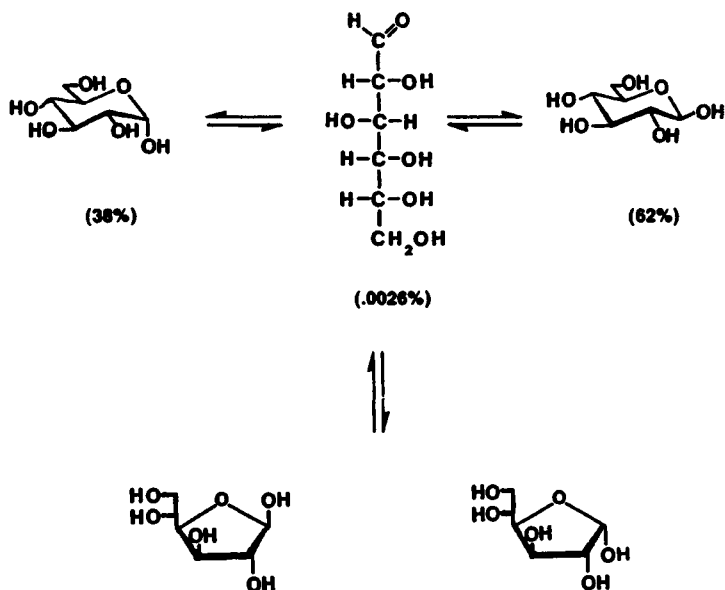

Figure 4-3 Tautomeric Forms of Glucose in Aqueous Solution at Room Temperature

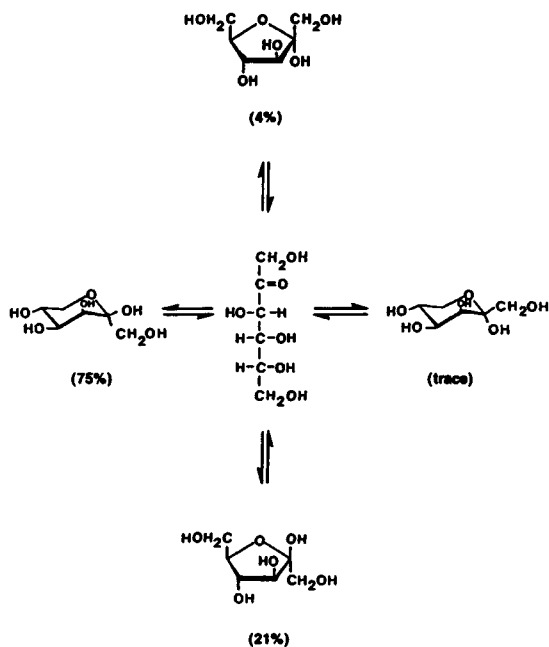

Figure 4-4 Tautomeric Forms of Fructose in Aqueous Solution at Room Temperature

tional groups or substituents; these lead to such diverse compounds as aldoses, ketoses, amino sugars, deoxy sugars, sugar acids, sugar alcohols, acetylated or methylated sugars, anhydro sugars, oligo- and polysaccharides, and glycosides. Fructose is the most widely occurring ketose and is shown in its various representations in Figure 4-5. It is the sweetest known sugar and occurs bound to glucose in sucrose or common sugar. Of all the other possible hexoses only two occur widely—D-mannose and D-galactose. Their formulas and relationship to D-glucose are given in Figure 4-6.

RELATED COMPOUNDS

Amino sugars usually contain D-glucosamine (2-deoxy-2-amino glucose). They occur as components of high molecular weight compounds such as the chitin of crustaceans and mollusks, as well as in certain mushrooms and in combination with the ovomucin of egg white.

Glycosides are sugars in which the hydrogen of an anomeric hydroxy group has been replaced by an alkyl or aryl group to form a mixed acetal. Glycosides are hydrolyzed by acid or enzymes but are stable to alkali. Formation of the full acetal means that glycosides have no reducing power. Hydrolysis of glycosides yields sugar and the aglycone. Amygdalin is an example of one of the cyanogenic glycosides and is a component of bitter almonds. The glycone moiety of this compound is gentiobiose, and complete hydrolysis yields benzaldehyde, hydrocyanic acid, and glucose (Figure 4-7). Other important glycosides are the flavonone glycosides of citrus rind, which include hesperidin and naringin, and the mustard oil glycosides, such as sinigrin, which is a component of mustard and horseradish. Deoxy sugars occur as components of nucleotides; for example, 2-deoxyribose constitutes part of deoxyribonucleic acid.

Sugar alcohols occur in some fruits and are produced industrially as food ingredients.

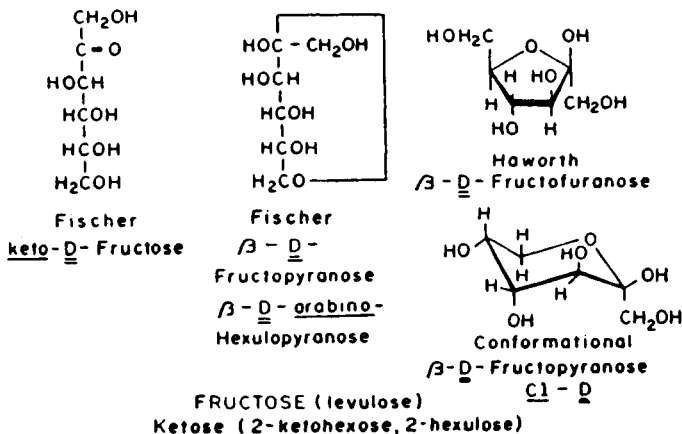

Figure 4-5 Methods of Representation of D-Fructose. *Source:* From M.L. Wolfrom, Physical and Chemical Structures of Carbohydrates, in *Symposium on Foods: Carbohydrates and Their Roles*, H.W. Schultz, R.F. Cain, and R.W. Wrolstad, eds., 1969, AVI Publishing Co.

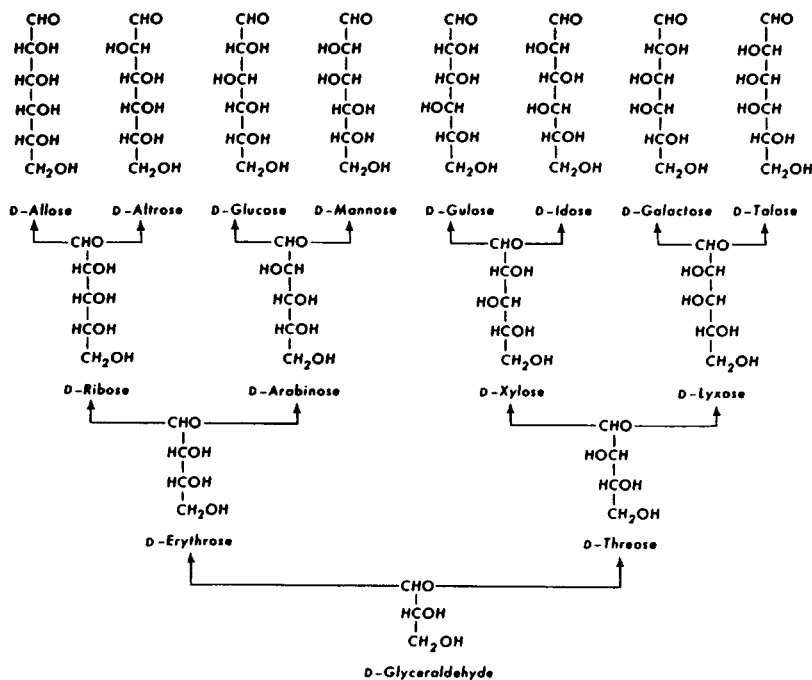

Figure 4-6 Relationship of D-Aldehyde Sugars. *Source:* From M.L. Wolfrom, Physical and Chemical Structures of Carbohydrates, in *Symposium on Foods: Carbohydrates and Their Roles*, H.W. Schultz, R.F. Cain, and R.W. Wrolstad, eds., 1969, AVI Publishing Co.

They can be made by reduction of free sugars with sodium amalgam and lithium aluminum hydride or by catalytic hydrogenation. The resulting compounds are sweet as sugars, but are only slowly absorbed and can, therefore, be used as sweeteners in diabetic foods. Reduction of glucose yields glucitol (Figure 4-8), which has the trivial name sorbitol. Another commercially produced sugar

alcohol is xylitol, a five-carbon compound, which is also used for diabetic foods (Figure 4-8). Pentitols and hexitols are widely distributed in many foods, especially fruits and vegetables (Washüttl et al. 1973), as is indicated in Table 4-2.

Anhydro sugars occur as components of seaweed polysaccharides such as alginate and agar. Sugar acids occur in the pectic sub-

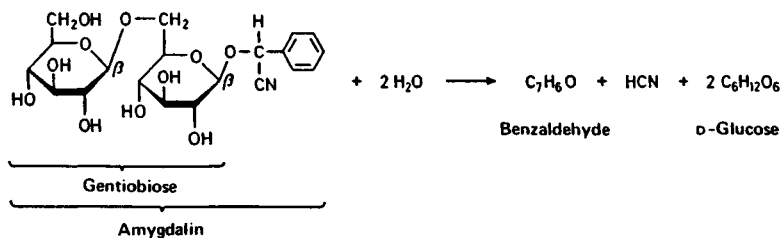

Figure 4-7 Hydrolysis of the Glycoside Amygdalin

Table 4-2 Occurrence of Sugar-Alcohols in Some Foods (Expressed as mg/100g of Dry Food)

<i>Product</i>	<i>Arabitol</i>	<i>Xylitol</i>	<i>Mannitol</i>	<i>Sorbitol</i>	<i>Galactitol</i>
Bananas	—	21	—	—	—
Pears	—	—	—	4600	—
Raspberries	—	268	—	—	—
Strawberries	—	362	—	—	—
Peaches	—	—	—	960	—
Celery	—	—	4050	—	—
Cauliflower	—	300	—	—	—
White mushrooms	340	128	476	—	48

Source: From J. Washüttl, P. Reiderer, and E. Bancher, A Qualitative and Quantitative Study of Sugar-Alcohols in Several Foods: A Research Role, *J. Food Sci.*, Vol. 38, pp. 1262–1263, 1973.

stances. When some of the carboxyl groups are esterified with methanol, the compounds are known as pectins. By far the largest group of saccharides occurs as oligo- and polysaccharides.

OLIGOSACCHARIDES

Polymers of monosaccharides may be either of the homo- or hetero-type. When the number of units in a glycosidic chain is in the range of 2 to 10, the resulting compound is an oligosaccharide. More than 10 units are usually considered to constitute a polysac-

charide. The number of possible oligosaccharides is very large, but only a few are found in large quantities in foods; these are listed in Table 4-3. They are composed of the monosaccharides D-glucose, D-galactose, and D-fructose, and they are closely related to one another, as shown in Figure 4-9.

Sucrose or ordinary sugar occurs in abundant quantities in many plants and is commercially obtained from sugar cane or sugar beets. Since the reducing groups of the monosaccharides are linked in the glycosidic bond, this constitutes one of the few nonreducing disaccharides. Sucrose, therefore, does not reduce Fehling solution or form osazones and it does not undergo mutarotation in solution. Because of the unique carbonyl-to-carbonyl linkage, sucrose is highly labile in acid medium, and acid hydrolysis is more rapid than with other oligosaccharides. The structure of sucrose is shown in Figure 4-10. When sucrose is heated to 210°C, partial decomposition takes place and caramel is formed. An important reaction of sucrose,

**Figure 4-8** Structure of Sorbitol and Xylitol

Table 4-3 Common Oligosaccharides Occurring in Foods

Sucrose	(α -D-glucopyranosyl β -D-fructofuranoside)
Lactose	(4-O- β -D-galactopyranosyl-D-glucopyranose)
Maltose	(4-O- α -D-glucopyranosyl-D-glucopyranose)
α, α -Trehalose	(α -D-glucopyranosyl- α -D-glucopyranoside)
Raffinose	[O- α -D-galactopyranosyl-(1 \rightarrow 6)-O- α -D-glucopyranosyl-(1 \rightarrow 2)- β -D-fructofuranoside]
Stachyose	[O- α -D-galactopyranosyl-(1 \rightarrow 6)-O- α -D-galactopyranosyl-(1 \rightarrow 6)-O- α -D-glucopyranosyl-(1 \rightarrow 2)- β -D-fructofuranoside]
Verbascose	[O- α -D-galactopyranosyl-(1 \rightarrow 6)-O- α -D-galactopyranosyl-(1 \rightarrow 6)-O- α -D-glucopyranosyl-(1 \rightarrow 2)- β -D-fructofuranoside]

Source: From R.S. Shallenberger and G.G. Birch, *Sugar Chemistry*, 1975, AVI Publishing Co.

which it has in common with other sugars, is the formation of insoluble compounds with calcium hydroxide. This reaction results in the formation of tricalcium compounds $C_{12}H_{22}O_{11} \cdot 3 Ca(OH)_2$ and is useful for

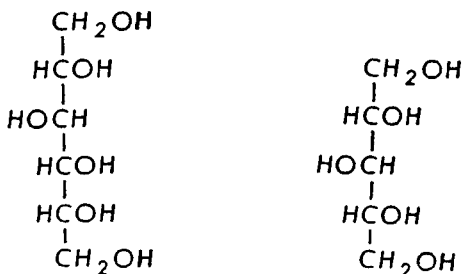
recovering sucrose from molasses. When the calcium saccharate is treated with CO_2 , the sugar is liberated.

Hydrolysis of sucrose results in the formation of equal quantities of D-glucose and D-

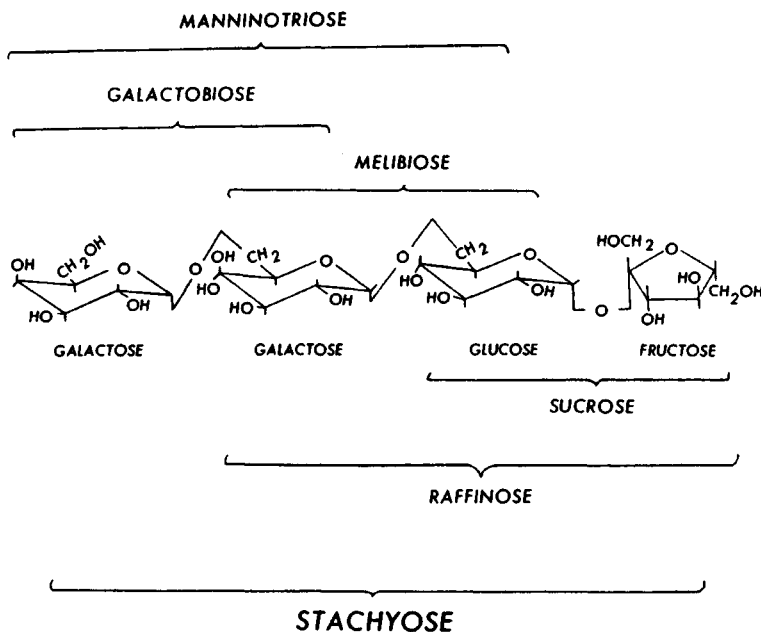

Figure 4-9 Composition of Some Major Oligosaccharides Occurring in Foods. Source: From R.S. Shallenberger and G.G. Birch, *Sugar Chemistry*, 1975, AVI Publishing Co.

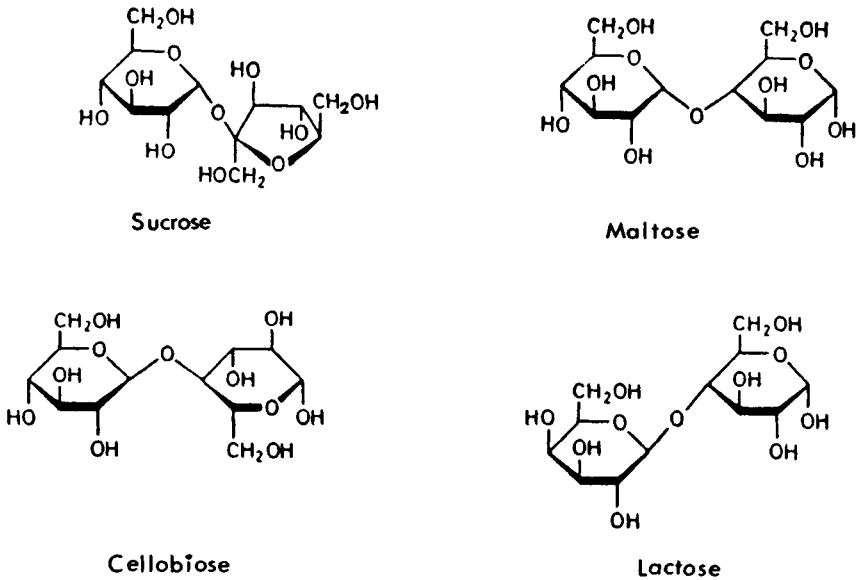

Figure 4-10 Structure of Some Important Disaccharides

fructose. Since the specific rotation of sucrose is $+66.5^\circ$, of D-glucose $+52.2^\circ$, and of D-fructose -93° , the resulting invert sugar has a specific rotation of -20.4° . The name invert sugar refers to the inversion of the direction of rotation.

Sucrose is highly soluble over a wide temperature range, as is indicated in Figure 4-11. This property makes sucrose an excellent ingredient for syrups and other sugar-containing foods.

The characteristic carbohydrate of milk is lactose or milk sugar. With a few minor exceptions, lactose is the only sugar in the milk of all species and does not occur elsewhere. Lactose is the major constituent of the dry matter of cow's milk, as it represents close to 50 percent of the total solids. The lactose content of cow's milk ranges from 4.4 to 5.2 percent, with an average of 4.8

percent expressed as anhydrous lactose. The lactose content of human milk is higher, about 7.0 percent.

Lactose is a disaccharide of D-glucose and D-galactose and is designated as 4-O- β -D-galactopyranosyl-D-glucopyranose (Figure 4-10). It is hydrolyzed by the enzyme β -D-galactosidase (lactase) and by dilute solutions of strong acids. Organic acids such as citric acid, which easily hydrolyze sucrose, are unable to hydrolyze lactose. This difference is the basis of the determination of the two sugars in mixtures.

Maltose is 4- α -D-glucopyranosyl- β -D-glucopyranose. It is the major end product of the enzymic degradation of starch and glycogen by β -amylase and has a characteristic flavor of malt. Maltose is a reducing disaccharide, shows mutarotation, is fermentable, and is easily soluble in water.

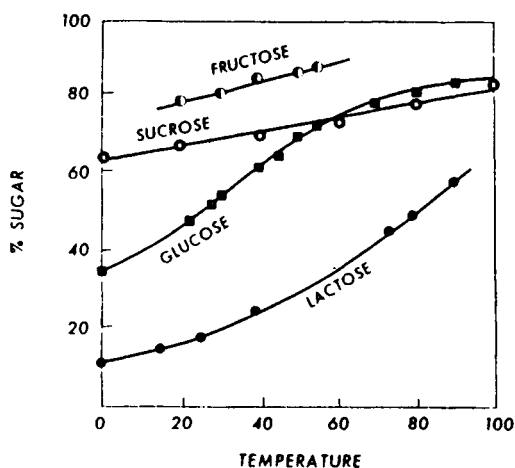

Figure 4-11 Approximate Solubility of Some Sugars at Different Temperatures. *Source:* From R.S. Shallenberger and G.G. Birch, *Sugar Chemistry*, 1975, AVI Publishing Co.

Cellobiose is 4- β -D-glucopyranosyl- β -D-glucopyranose, a reducing disaccharide resulting from partial hydrolysis of cellulose.

Legumes contain several oligosaccharides, including raffinose and stachyose. These sugars are poorly absorbed when ingested, which results in their fermentation in the large intestine. This leads to gas production and flatulence, which present a barrier to wider food use of such legumes. deMan et al. (1975 and 1987) analyzed a large number of soybean varieties and found an average content of 1.21 percent stachyose, 0.38 percent raffinose, 3.47 percent sucrose, and very small amounts of melibiose. In soy milk, total reducing sugars after inversion amounted to 11.1 percent calculated on dry basis.

Cow's milk contains traces of oligosaccharides other than lactose. They are made up of two, three, or four units of lactose, glucose, galactose, neuraminic acid, mannose, and acetyl glucosamine. Human milk contains

about 1 g/L of these oligosaccharides, which are referred to as the bifidus factor. The oligosaccharides have a beneficial effect on the intestinal flora of infants.

Fructooligosaccharides (FOSs) are oligomers of sucrose where an additional one, two, or three fructose units have been added by a β -(2-1)-glucosidic linkage to the fructose unit of sucrose. The resulting FOSs, therefore, contain two, three, or four fructose units. The FOSs occur naturally as components of edible plants including banana, tomato, and onion (Spiegel et al. 1994). FOSs are also manufactured commercially by the action of a fungal enzyme from *Aspergillus niger*, β -fructofuranosidase, on sucrose. The three possible FOSs are 1^F -(1- β -fructofuranosyl) $_{n-1}$ sucrose oligomers with abbreviated and common names as follows: GF₂ (1-kestose), GF₃ (nystose), and GF₄ (1^F - β -fructofuranosyl-nystose). The commercially manufactured product is a mixture of all three FOSs with sucrose, glucose, and fructose. FOSs are nondigestible by humans and are suggested to have some dietary fiber-like function.

Chemical Reactions

Mutarotation

When a crystalline reducing sugar is placed in water, an equilibrium is established between isomers, as is evidenced by a relatively slow change in specific rotation that eventually reaches the final equilibrium value. The working hypothesis for the occurrence of mutarotation has been described by Shallenberger and Birch (1975). It is assumed that five structural isomers are possible for any given reducing sugar (Figure 4-12), with pyranose and furanose ring structures being generated from a central straight-chain inter-

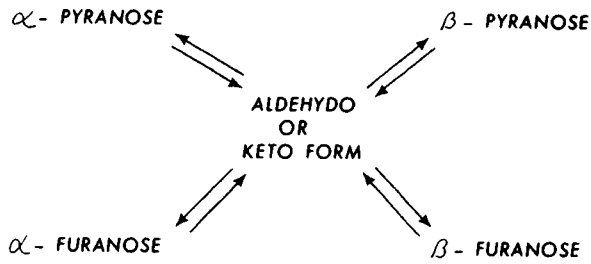
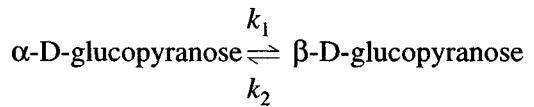

Figure 4-12 Equilibria Involved in Mutarotation. *Source:* From R.S. Shallenberger and G.G. Birch, *Sugar Chemistry*, 1975, AVI Publishing Co.

mediate. When all of these forms are present, the mutarotation is complex. When only the pyranose forms are present, the mutarotation is simple. Aldoses that have the *gluco*, *manno*, *gulo*, and *allo* configurations (Figure 4-6) exhibit simple mutarotation. D-glucose, for example, shows simple mutarotation and in aqueous solution only two forms are present, 36 percent α -D-glucopyranose and 64 percent β -D-glucopyranose. The amount of aldehyde form of glucose in solution has been estimated at 0.003 percent. The distribution of isomers in some mutarotated monosaccharides at 20°C is shown in Table 4-4. The distribution of α - and β -anomers in solutions of lactose and maltose is nearly the same as in glucose, about 32 percent α - and 64 percent β -anomer. Simple mutarotation is

a first-order reaction characterized by uniform values of the reaction constants k_1 and k_2 in the equation



The velocity of the reaction is greatly accelerated by acid or base. The rate is at a minimum for pyranose-pyranose interconversions in the pH range 2.5 to 6.5. Both acids and bases accelerate mutarotation rate, with bases being more effective. This was expressed by Hudson (1907) in the following equation:

$$K_{25}^{\circ} = 0.0096 + 0.258 [\text{H}^+] + 9.750 [\text{OH}^-]$$

Table 4-4 Percentage Distribution of Isomers of Mutarotated Sugars at 20°C

Sugar	α -Pyranose	β -Pyranose	α -Furanose	β -Furanose
D-Glucose	31.1-37.4	64.0-67.9	—	—
D-Galactose	29.6-35.0	63.9-70.4	1.0	3.1
D-Mannose	64.0-68.9	31.1-36.0	—	—
D-Fructose	4.0?	68.4-76.0	—	28.0-31.6

Source: From R.S. Shallenberger and G.G. Birch, *Sugar Chemistry*, AVI Publishing Co.

This indicates that the effect of the hydroxyl ion is about 40,000 times greater than that of the hydrogen ion. The rate of mutarotation is also temperature dependent; increases from 1.5 to 3 times occur for every 10°C rise in temperature.

Other Reactions

Sugars in solution are unstable and undergo a number of reactions. In addition to mutarotation, which is the first reaction to occur when a sugar is dissolved, enolization and isomerization, dehydration and fragmentation, anhydride formation and polymerization may all take place. These reactions are outlined in Figure 4-13, using glucose as an example. Compounds (1) and (2) are the α and β forms in equilibrium during mutarotation with the aldehyde form (5). Heating results in dehydration of the *1C* conformation of β -D glucopyranose (3) and formation of levoglucosan (4), followed by the

sequence of reactions described under caramelization. Enolization is the formation of an enediol (6). These enediols are unstable and can rearrange in several ways. Since the reactions are reversible, the starting material can be regenerated. Other possibilities include formation of keto-D-fructose (10) and β -D-fructopyranose (11), and aldehyde-D-mannose (8) and α -D-mannopyranose (9). Another possibility is for the double bond to move down the carbon chain to form another enediol (7). This compound can give rise to saccharinic acids (containing one carboxyl group) and to 5-(hydroxy)-methylfurfural (13). All these reactions are greatly influenced by pH. Mutarotation, enolization, and formation of saccharic acid (containing two carboxyl groups) are favored by alkaline pH, formation of anhydrides, and furaldehydes by acid pH.

It appears from the aforementioned reactions that on holding a glucose solution at alkaline pH, a mixture of glucose, mannose,

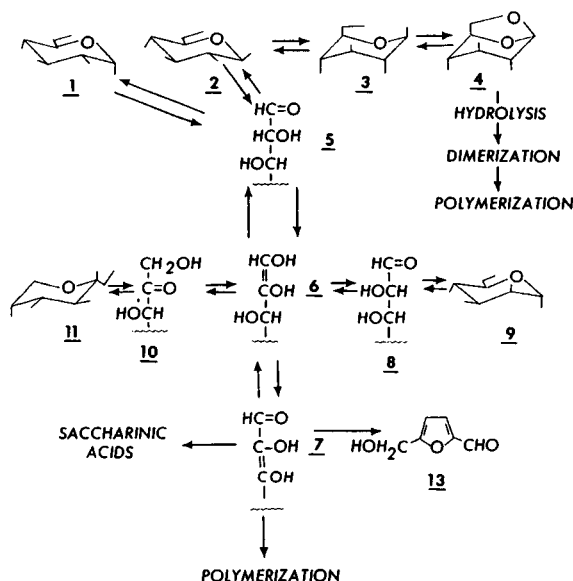

Figure 4-13 Reactions of Reducing Sugars in Solution. *Source:* From R.S. Shallenberger and G.G. Birch, *Sugar Chemistry*, 1975, AVI Publishing Co.

and fructose will be formed and, in general, any one sugar will yield a mixture of sugars. When an acid solution of sugar of high concentration is left at ambient temperature, reversion takes place. This is the formation of disaccharides. The predominant linkages in the newly formed disaccharides are α -D-1 \rightarrow 6, and β -D-1 \rightarrow 6. A list of reversion disaccharides observed by Thompson et al. (1954) in a 0.082N hydrochloric acid solution or in D-glucose is shown in Table 4-5.

Caramelization

The formation of the caramel pigment can be considered a nonenzymatic browning reaction in the absence of nitrogenous compounds. When sugars are subjected to heat in the absence of water or are heated in concentrated solution, a series of reactions occurs that finally leads to caramel formation. The initial stage is the formation of anhydro sugars (Shallenberger and Birch 1975). Glucose yields glucosan (1,2-anhydro- α -D-glucose) and levoglucosan (1,6-anhydro- β -D-glucose); these have widely differing specific rotation, $+69^\circ$ and -67° , respectively. These compounds may dimerize to form a number of reversion disaccharides, including gentio-

biose and sophorose, which are also formed when glucose is melted.

Caramelization of sucrose requires a temperature of about 200°C . At 160°C , sucrose melts and forms glucose and fructose anhydride (levulosan). At 200°C , the reaction sequence consists of three distinct stages well separated in time. The first step requires 35 minutes of heating and involves a weight loss of 4.5 percent, corresponding to a loss of one molecule of water per molecule of sucrose. This could involve formation of compounds such as isosacchrosan. Pictet and Stricker (1924) showed that the composition of this compound is 1,3'; 2,2'-dianhydro- α -D-glucopyranosyl- β -D-glucopyranosyl- β -D-fructofuranose (Figure 4-14). After an additional 55 minutes of heating, the weight loss amounts to 9 percent and the pigment formed is named caramelan. This corresponds approximately to the following equation:

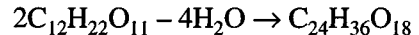

The pigment caramelan is soluble in water and ethanol and has a bitter taste. Its melting point is 138°C . A further 55 minutes of heating leads to the formation of caramelen. This compound corresponds to a weight loss of

Table 4-5 Reversion Disaccharides of Glucose in 0.082N HCl

β , β -trehalose (β -D-glucopyranosyl β -D-glucopyranoside)	0.1%
β -sophorose (2-O- β -D-glucopyranosyl- β -D-glucopyranose)	0.2%
β -maltose (4-O- α -D-glycopyranosyl- β -D-glycopyranose)	0.4%
α -cellobiose (4-O- β -D-glucopyranosyl- α -D-glucopyranose)	0.1%
β -cellobiose (4-O- β -D-glucopyranosyl- β -D-glucopyranose)	0.3%
β -isomaltose (6-O- α -D-glucopyranosyl- β -D-glucopyranose)	4.2%
α -gentiobiose (6-O- β -D-glucopyranosyl- α -D-glucopyranose)	0.1%
β -gentiobiose (6-O- β -D-glucopyranosyl- β -D-glucopyranose)	3.4%

Source: From A. Thompson et al., Acid Reversion Products from D-Glucose, *J. Am. Chem. Soc.*, Vol. 76, pp. 1309-1311, 1954.

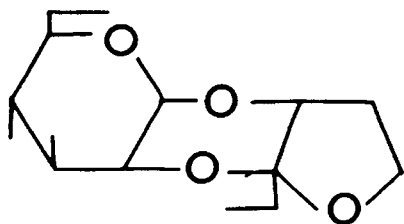
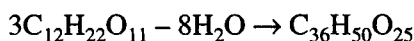

Figure 4-14 Structure of Isosacchrosan. *Source:* From R.S. Shallenberger and G.G. Birch, *Sugar Chemistry*, 1975, AVI Publishing Co.

about 14 percent, which is about eight molecules of water from three molecules of sucrose, as follows:



Caramelen is soluble in water only and melts at 154°C. Additional heating results in the formation of a very dark, nearly insoluble pigment of average molecular composition $C_{125}H_{188}O_{80}$. This material is called humin or caramelin.

The typical caramel flavor is the result of a number of sugar fragmentation and dehydration products, including diacetyl, acetic acid, formic acid, and two degradation products reported to have typical caramel flavor by Jurch and Tatum (1970), namely, acetylformoin (4-hydroxy-2,3,5-hexane-trione) and 4-hydroxy-2,5-dimethyl-3(2H)-furanone.

Crystallization

An important characteristic of sugars is their ability to form crystals. In the commercial production of sugars, crystallization is an important step in the purification of sugar. The purer a solution of a sugar, the easier it will crystallize. Nonreducing oligosaccharides crystallize relatively easily. The fact

that certain reducing sugars crystallize with more difficulty has been ascribed to the presence of anomers and ring isomers in solution, which makes these sugars intrinsically "impure" (Shallenberger and Birch 1975). Mixtures of sugars crystallize less easily than single sugars. In certain foods, crystallization is undesirable, such as the crystallization of lactose in sweetened condensed milk or ice cream.

Factors that influence growth of sucrose crystals have been listed by Smythe (1971). They include supersaturation of the solution, temperature, relative velocity of crystal and solution, nature and concentration of impurities, and nature of the crystal surface. Crystal growth of sucrose consists of two steps: (1) the mass transfer of sucrose molecules to the surface of the crystal, which is a first-order process; and (2) the incorporation of the molecules in the crystal surface, a second-order process. Under usual conditions, overall growth rate is a function of the rate of both processes, with neither being rate-controlling. The effect of impurities can be of two kinds. Viscosity can increase, thus reducing the rate of mass transfer, or impurities can involve adsorption on specific surfaces of the crystal, thereby reducing the rate of surface incorporation.

The crystal structure of sucrose has been established by X-ray diffraction and neutron diffraction studies. The packing of sucrose molecules in the crystal lattice is determined mainly by hydrogen bond formation between hydroxyl groups of the fructose moiety. As an example of the type of packing of molecules in a sucrose crystal, a projection of the crystal structure along the *a* axis is shown in Figure 4-15. The dotted square represents one unit cell. The crystal faces indicated in this figure follow planes between adjacent sucrose molecules in such a way that the

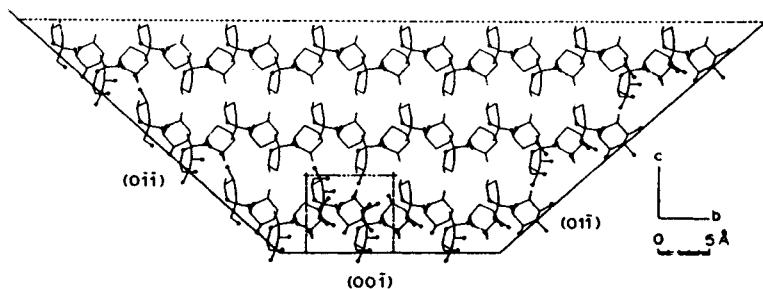

Figure 4-15 Projection of a Sucrose Crystal Along the *a* Axis. *Source:* From B.M. Smythe, *Sucrose Crystal Growth*, *Sugar Technol. Rev.*, Vol. 1, pp. 191-231, 1971.

furanose and pyranose rings are not intersected.

Lactose can occur in two crystalline forms, the α -hydrate and the β -anhydrous forms and can occur in an amorphous or glassy state. The most common form is the α -hydrate ($C_{12}H_{22}O_{11} \cdot H_2O$), which can be obtained by crystallization from a supersaturated solution below 93.5°C . When crystallization is carried out above 93.5°C , the crystals formed are of β -anhydrous type. Some properties of these forms have been listed by Jenness and Patton (1959) (Table 4-6). Under normal conditions the α -

hydrate form is the stable one, and other solid forms spontaneously change to that form provided sufficient water is present. At equilibrium and at room temperature, the β -form is much more soluble and the amount of α -form is small. However, because of its lower solubility, the α -hydrate crystallizes out and the equilibrium shifts to convert β -into α -hydrate. The solubility of the two forms and the equilibrium mixture is represented in Figure 4-16.

The solubility of lactose is less than that of most other sugars, which may present problems in a number of foods containing lac-

Table 4-6 Some Physical Properties of the Two Common Forms of Lactose

<i>Property</i>	<i>α-Hydrate</i>	<i>β-Anhydride</i>
Melting point ¹	202°C (dec.)	252°C (dec.)
Specific rotation ² $[\alpha]_D^{20}$	$+89.4^\circ$	$+35^\circ$
Solubility (g/100 mL) Water at 20°C	8	55
Water at 100°C	70	95
Specific gravity (20°C)	1.54	1.59
Specific heat	0.299	0.285
Heat of combustion (cal/g^{-1})	3761.6	3932.7

¹ Values vary with rate of heating, α -hydrate losses H_2O (120°C).

² Values on anhydrous basis, both forms mutarotate to $+55.4^\circ$.

Source: From R. Jenness and S. Patton, *Principles of Dairy Chemistry*, 1959, John Wiley and Sons.

tose. When milk is concentrated 3:1, the concentration of lactose approaches its final solubility. When this product is cooled or when sucrose is added, crystals of α -hydrate may develop. Such lactose crystals are very hard and sharp; when left undisturbed they may develop to a large size, causing a sensation of grittiness or sandiness in the mouth. This same phenomenon limits the amount of milk solids that can be incorporated into ice cream.

The crystals of α -hydrate lactose usually occur in a prism or tomahawk shape. The latter is the basic shape and all other shapes are derived from it by different relative growth rates of the various faces. The shape of an α -hydrate lactose crystal is shown in Figure 4-17. The crystal has been character-

ized by X-ray diffraction, and the following constants for the dimensions of the unit cell and one of the axial angles have been established: $a = 0.798$ nm, $b = 2.168$ nm, $c = 0.4836$ nm, and $\beta = 109^\circ 47'$. The crystallographic description of the crystal faces is indicated in Figure 4-17. These faces grow at different rates; the more a face is oriented toward the β direction, the slower it grows and the (0 $\bar{1}$ 0) face does not grow at all.

Amorphous or glassy lactose is formed when lactose-containing solutions are dried quickly. The dry lactose is noncrystalline and contains the same ratio of alpha/beta as the

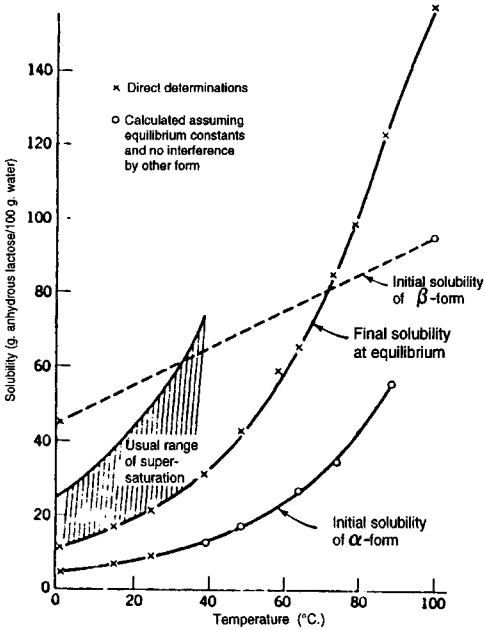

Figure 4-16 Solubility of Lactose in Water. *Source:* From E.O. Whittier, Lactose and Its Utilization: A Review, *J. Dairy Sci.*, Vol. 27, p. 505, 1944.

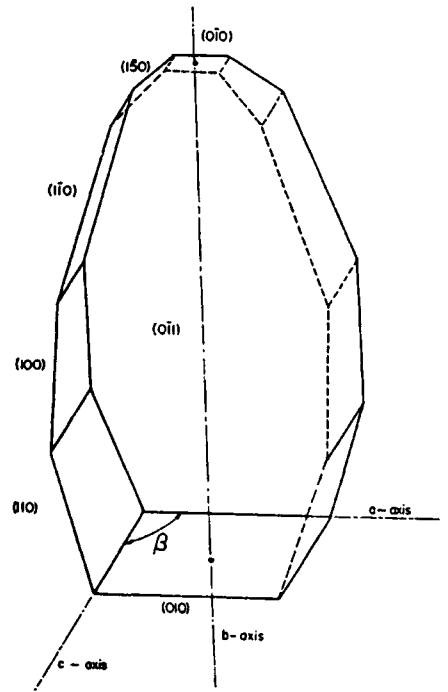

Figure 4-17 Crystallographic Representation of a Tomahawk Crystal of α -Lactose Monohydrate. *Source:* From A. Van Kreveld and A.S. Michaels, Measurement of Crystal Growth of α -Lactose, *J. Dairy Sci.*, Vol. 48, pp. 259-265, 1965.

original product. This holds true for spray or roller drying of milk products and also during drying for moisture determination. The glassy lactose is extremely hygroscopic and takes up moisture from the atmosphere. When the moisture content reaches about 8 percent, the lactose molecules recrystallize and form α -hydrate crystals. As these crystals grow, powdered products may cake and become lumpy.

Both lactose and sucrose have been shown to crystallize in an amorphous form at moisture contents close to the glass transition temperature (Roos and Karel 1991a,b; Roos and Karel 1992). When amorphous lactose is held at constant water content, crystallization releases water to the remaining amorphous material, which depresses the glass transition temperature and accelerates crystallization. These authors have done extensive studies on the glass transition of amorphous carbohydrate solutions (Roos 1993; Roos and Karel 1991d).

Seeding is a commonly used procedure to prevent the slow crystallization of lactose and the resulting sandiness in some dairy products. Finely ground lactose crystals are introduced into the concentrated product, and these provide numerous crystal nuclei. Many small crystals are formed rapidly; therefore, there is no opportunity for crystals to slowly grow in the supersaturated solution until they would become noticeable in the mouth.

Starch Hydrolyzates—Corn Sweeteners

Starch can be hydrolyzed by acid or enzymes or by a combination of acid and enzyme treatments. A large variety of products can be obtained from starch hydrolysis

using various starches such as corn, wheat, potato, and cassava (tapioca) starch. Glucose syrups, known in the United States as corn syrup, are hydrolysis products of starch with varying amounts of glucose monomer, dimer, oligosaccharides, and polysaccharides. Depending on the method of hydrolysis used, different compositions with a broad range of functional properties can be obtained. The degree of hydrolysis is expressed as dextrose equivalent (DE), defined as the amount of reducing sugars present as dextrose and calculated as a percentage of the total dry matter. Glucose syrups have a DE greater than 20 and less than 80. Below DE 20 the products are referred to as maltodextrins and above DE 80 as hydrolyzates. The properties of maltodextrins are influenced by the nature of the starch used; those of hydrolyzates are not affected by the type of starch.

The initial step in starch hydrolysis involves the use of a heat-stable endo- α -amylase. This enzyme randomly attacks α -1,4 glycosidic bonds resulting in rapid decrease in viscosity. These enzymes can be used at temperatures as high as 105°C. This reaction produces maltodextrins (Figure 4–18), which can be used as important functional food ingredients—fillers, stabilizers, and thickeners. The next step is saccharification by using a series of enzymes that hydrolyze either the α -1,4 linkages of amylose or the α -1,6 linkages of the branched amylopectin. The action of the various starch-degrading enzymes is shown in Figure 4–19 (Olsen 1995). In addition to products containing high levels of glucose (95 to 97 percent), sweeteners with DE of 40 to 45 (maltose), 50 to 55 (high maltose), and 55 to 70 (high conversion syrup) can be produced. High dextrose syrups can be obtained by saccharification with amyloglucosidase. At the beginning of the reaction

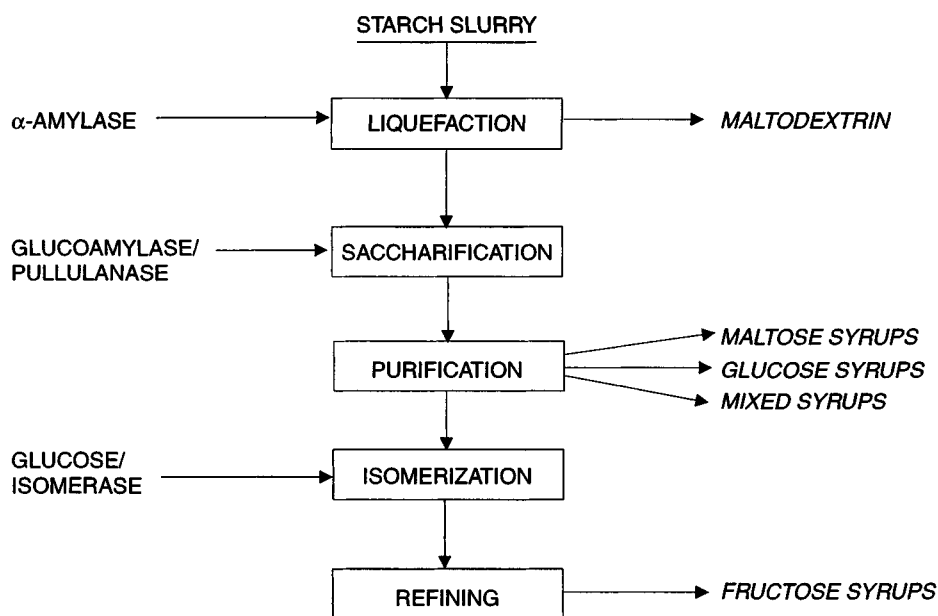

Figure 4-18 Major Steps in Enzymic Starch Conversion. *Source:* Reprinted from H.S. Olsen, *Enzymic Production of Glucose Syrups*, in *Handbook of Starch Hydrolysis Products and Their Derivatives*, M.W. Kearsley and S.Z. Dziedzic, eds., p. 30, © 1995, Aspen Publishers, Inc.

dextrose formation is rapid but gradually slows down. This slowdown is caused by formation of branched dextrans and because at high dextrose level the repolymerization of dextrose into isomaltose occurs.

The isomerization of glucose to fructose opened the way for starch hydrolyzates to replace cane or beet sugar (Dziezak 1987). This process is done with glucose isomerase in immobilized enzyme reactors. The conversion is reversible and the equilibrium is at 50 percent conversion. High-fructose corn syrups are produced with 42 or 55 percent fructose. These sweeteners have taken over one-third of the sugar market in the United States (Olsen 1995).

The acid conversion process has a practical limit of 55 DE; above this value, dark color and bitter taste become prominent. Depending on the process used and the reaction con-

ditions employed, a variety of products can be obtained as shown in Table 4-7 (Commerford 1974). There is a fairly constant relationship between the composition of acid-converted corn syrup and its DE. The composition of syrups made by acid-enzyme or dual-enzyme processes cannot be as easily predicted from DE.

Maltodextrins (DE below 20) have compositions that reflect the nature of the starch used. This depends on the amylose/amylopectin ratio of the starch. A maltodextrin with DE 12 shows retrogradation in solution, producing cloudiness. A maltodextrin from waxy corn at the same DE does not show retrogradation because of the higher level of α -1, 6 branches. As the DE decreases, the differences become more pronounced. A variety of maltodextrins with different functional properties, such as gel formation, can be

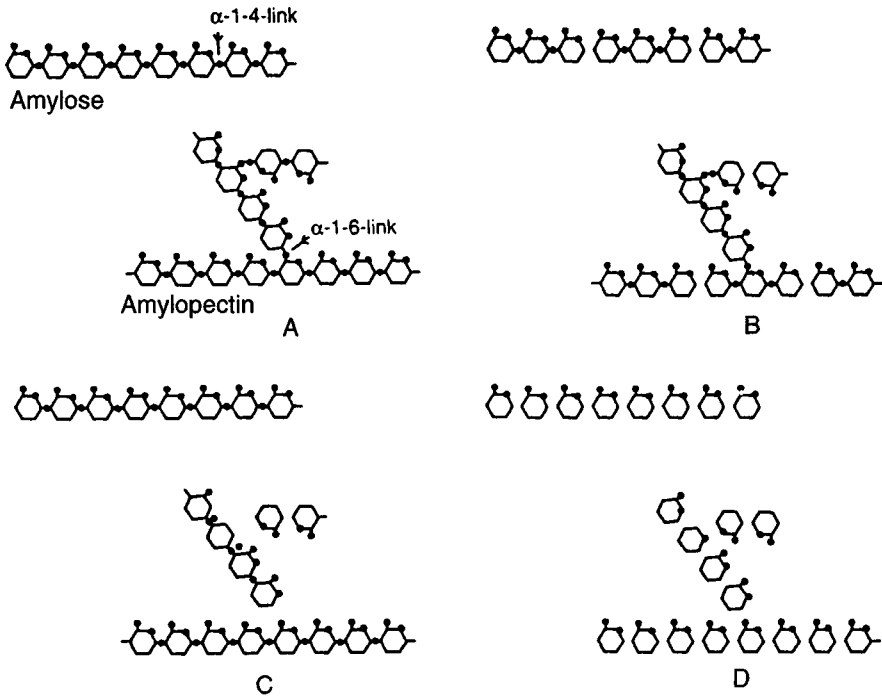

Figure 4-19 Schematic Representation of the Action of Starch-Degrading Enzymes. (A) Amylose and amylopectin, (B) action of α -amylase on amylose and amylopectin, (C) action of a debranching enzyme on amylose and amylopectin, (D) action of amyloglucosidase and debranching enzyme on amylose and amylopectin. *Source:* Reprinted from H.S. Olsen, *Enzymic Production of Glucose Syrups*, in *Handbook of Starch Hydrolysis Products and Their Derivatives*, M.W. Kearsley and S.Z. Dziedzic, eds., p. 36, © 1995, Aspen Publishers, Inc.

obtained by using different starch raw materials.

Maltodextrins of varying molecular weights are plasticized by water and decrease the glass transition temperature. Maltodextrins retard the crystallization of amorphous sucrose and at high concentrations totally inhibit sucrose crystallization (Roos and Karel 1991c).

Maltodextrins with low DE and with little or no remaining polysaccharide can be produced by using two enzymes. Alpha-amylase randomly hydrolyzes 1 \rightarrow 4 linkages to reduce the viscosity of the suspension. Pullu-

lanase is specific for 1 \rightarrow 6 linkages and acts as a debranching enzyme. The application of these two enzymes makes it possible to produce maltodextrins in high yield (Kennedy et al. 1985).

Polyols

Polyols or sugar alcohols occur in nature and are produced industrially from the corresponding saccharides by catalytic hydrogenation. Sorbitol, the most widely distributed natural polyol, is found in many fruits such

Table 4-7 Composition of Representative Corn Syrups

Type of Conversion	Saccharides (%)								
	Dextrose Equivalent	Mono-	Di-	Tri-	Tetra-	Penta-	Hexa-	Hepta-	Higher
Acid	30	10.4	9.3	8.6	8.2	7.2	6.0	5.2	45.1
Acid	42	18.5	13.9	11.6	9.9	8.4	6.6	5.7	25.4
Acid-enzyme	43	5.5	46.2	12.3	3.2	1.8	1.5	—	29.5 ¹
Acid	54	29.7	17.8	13.2	9.6	7.3	5.3	4.3	12.8
Acid	60	36.2	19.5	13.2	8.7	6.3	4.4	3.2	8.5
Acid-enzyme	63	38.8	28.1	13.7	4.1	4.5	2.6	—	8.2 ¹
Acid-enzyme	71	43.7	36.7	3.7	3.2	0.8	4.3	—	7.6 ¹

¹ Includes heptasaccharides.

Source: From J.D. Commerford, Corn Sweetener Industry, in *Symposium: Sweeteners*, I.E. Inglett, ed., 1974, AVI Publishing Co.

as plums, berries, cherries, apples, and pears. It is a component of fruit juices, fruit wines, and other fruit products. It is commercially produced by catalytic hydrogenation of D-glucose. Mannitol, the reduced form of D-mannose, is found as a component of mushrooms, celery, and olives. Xylitol is obtained from saccharification of xylan-containing plant materials; it is a pentitol, being the reduced form of xylose. Sorbitol, mannitol, and xylitol are monosaccharide-derived polyols with properties that make them valuable for specific applications in foods: they are suitable for diabetics, they are noncariogenic, they possess reduced physiological caloric value, and they are useful as sweeteners that are nonfermentable by yeasts.

In recent years disaccharide alcohols have become important. These include isomalt, maltitol, lactitol, and hydrogenated starch hydrolyzates (HSH). Maltitol is hydrogenated maltose with the structure shown in Figure 4-20. It has the highest sweetness of the disaccharidepolyols compared to sugar

(Table 4-8) (Heume and Rapaille 1996). It has a low negative heat of solution and, therefore, gives no cooling effect in contrast to sorbitol and xylitol. It also has a very high viscosity in solution. Sorbitol and maltitol are derived from starch by the production process illustrated in Figure 4-21. Lactitol is a disaccharide alcohol, 1,4-galactosylglucitol, produced by hydrogenation of lactose. It has low sweetness and a lower energy value than other polyols. It has a caloric value of 2 kcal/g and is noncariogenic (Blankers 1995). It can be used in combination with intense sweeteners like aspartame or acesulfame-K to produce sweetening

**Figure 4-20** Structure of Maltitol

Table 4-8 Relative Sweetness of Polyols and Sucrose Solutions at 20°C

Compound	Relative Sweetness
Xylitol	80-100
Sorbitol	50-60
Mannitol	50-60
Maltitol	80-90
Lactitol	30-40
Isomalt	50-60
Sucrose	100

Source: Reprinted from H. Schiweck and S.C. Ziesenitz, *Physiological Properties of Polyols in Comparison with Easily Metabolizable Saccharides*, in *Advances in Sweeteners*, T.H. Grenby, ed., p. 87, © 1996, Aspen Publishers, Inc.

power similar to sucrose. These combinations provide a milky, sweet taste that allows good perception of other flavors. Isomalt, also known as hydrogenated isomaltulose or hydrogenated palatinose, is manufactured in a two-step process: (1) the enzymatic transglycosylation of the nonreducing sucrose to the reducing sugar isomaltulose; and (2) hydrogenation, which produces isomalt—an equimolar mixture of D-glucopyranosyl- α -(1-1)-D-mannitol and D-glucopyranosyl- α -(1-6)-D-sorbitol. Isomalt is extremely stable and has a pure, sweet taste. Because it is only half as sweet as sucrose, it can be used as a versatile bulk sweetener (Ziesenitz 1996).

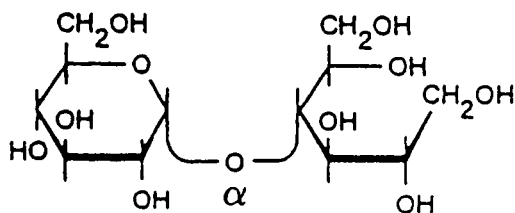
POLYSACCHARIDES

Starch

Starch is a polymer of D-glucose and is found as a storage carbohydrate in plants. It occurs as small granules with the size range and appearance characteristic to each plant species. The granules can be shown by ordi-

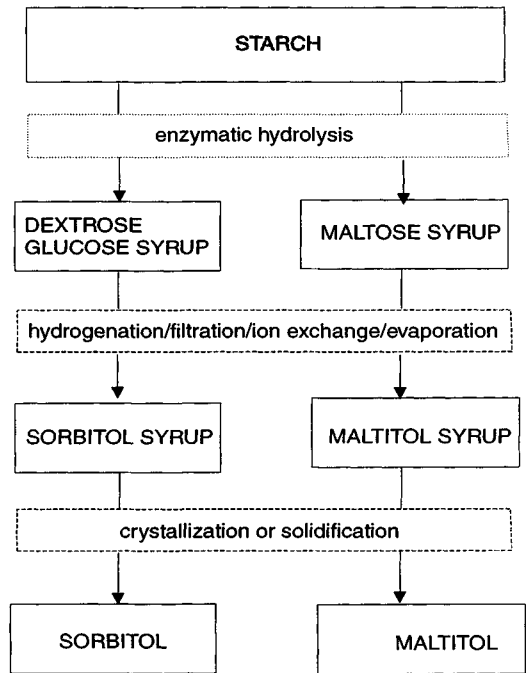

Figure 4-21 Production Process for the Conversion of Starch to Sorbitol and Maltitol. Source: Reprinted from H. Schiweck and S.C. Ziesenitz, *Physiological Properties of Polyols in Comparison with Easily Metabolizable Saccharides*, *Advances in Sweeteners*, T.H. Grenby, ed., p. 90, © 1996, Aspen Publishers, Inc.

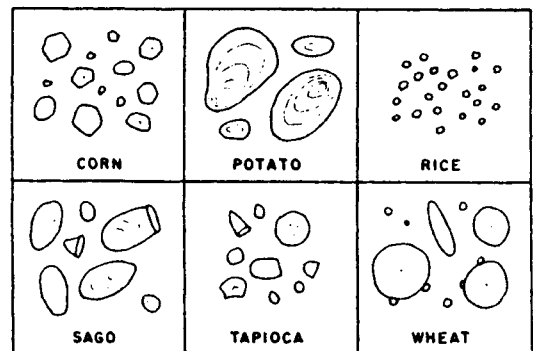

Figure 4-22 Appearance of Starch Granules as Seen in the Microscope

Minerals

INTRODUCTION

In addition to the major components, all foods contain varying amounts of minerals. The mineral material may be present as inorganic or organic salts or may be combined with organic material, as the phosphorus is combined with phosphoproteins and metals are combined with enzymes. More than 60 elements may be present in foods. It is customary to divide the minerals into two groups, the major salt components and the trace elements. The major salt components include potassium, sodium, calcium, magnesium, chloride, sulfate, phosphate, and bicarbonate. Trace elements are all others and are usually present in amounts below 50 parts per million (ppm). The trace elements can be divided into the following three groups:

1. essential nutritive elements, which include Fe, Cu, I, Co, Mn, Zn, Cr, Ni, Si, F, Mo, and Se.
2. nonnutritive, nontoxic elements, including Al, B, and Sn
3. nonnutritive, toxic elements, including Hg, Pb, As, Cd, and Sb

The minerals in foods are usually determined by ashing or incineration. This destroys the organic compounds and leaves the minerals behind. However, determined in

this way, the ash does not include the nitrogen contained in proteins and is in several other respects different from the real mineral content. Organic anions disappear during incineration, and metals are changed to their oxides. Carbonates in ash may be the result of decomposition of organic material. The phosphorus and sulfur of proteins and the phosphorus of lipids are also part of ash. Some of the trace elements and some salts may be lost by volatilization during the ashing. Sodium chloride will be lost from the ash if the incineration temperature is over 600°C. Clearly, when we compare data on mineral composition of foods, we must pay great attention to the methods of analysis used.

Some elements appear in plant and animal products at relatively constant levels, but in a number of cases an abundance of a certain element in the environment may result in a greatly increased level of that mineral in plant or animal products. Enrichment of elements in a biological chain may occur; note, for instance, the high mercury levels reported in some large predatory fish species such as swordfish and tuna.

MAJOR MINERALS

Some of the major mineral constituents, especially monovalent species, are present in

foods as soluble salts and mostly in ionized form. This applies, for example, to the cations sodium and potassium and the anions chloride and sulfate. Some of the polyvalent ions, however, are usually present in the form of an equilibrium between ionic, dissolved nonionic, and colloidal species. Such equilibria exist, for instance, in milk and in meat. Metals are often present in the form of *chelates*. Chelates are metal complexes formed by coordinate covalent bonds between a ligand and a metal cation; the ligand in a chelate has two or more coordinate covalent bonds to the metal. The name *chelate* is derived from the claw-like manner in which the metal is held by the coordinate covalent bonds of the ligand. In the formation of a chelate, the ligand functions as a Lewis base, and the metal ion acts as a Lewis acid. The stability constant of a chelate is influenced by a number of factors. The chelate is more stable when the ligand is relatively more basic. The chelate's stability depends on the nature of the metal ion and is related to the electronegative character of the metal. The stability of a chelate normally decreases with decreasing pH. In a chelate the donor atoms can be N, O, P, S, and Cl; some common donor groups are $-\text{NH}_2$, $=\text{C}=\text{O}$, $=\text{NH}$, $-\text{COOH}$, and $-\text{OH}-\text{O}-\text{PO}(\text{OH})_2$. Many metal ions, especially the transition metals, can serve as acceptors to form chelates with these donor groups. Formation of chelates can involve ring systems with four, five, or six members. Some examples of four- and five-membered ring structures are given in Figure 5-1. An example of a six-membered chelate ring system is chlorophyll. Other examples of food components that can be considered metal chelates are hemoglobin and myoglobin, vitamin B₁₂, and calcium caseinate (Pfeilsticker 1970). It has also been proposed that the gelation of certain polysaccharides, such as alginates and pec-

tates, with metal ions occurs through chelation involving both hydroxyl and carboxyl groups (Schweiger 1966). A requirement for the formation of chelates by these polysaccharides is that the OH groups be present in vicinal pairs.

Concerns about the role of sodium in human hypertension have drawn attention to the levels of sodium and potassium in foods and to measures intended to lower our sodium intake. The total daily intake by Americans of salt is 10 to 12 g, or 4 to 5 g of sodium. This is distributed as 3 g occurring naturally in food, 3 g added during food preparation and at the table, and 4 to 6 g added during commercial processing. This amount is far greater than the daily requirement, estimated at 0.5 g (Marsh 1983). Salt has an important effect on the flavor and acceptability of a variety of foods. In addition to lowering the level of added salt in food, researchers have suggested replacing salt with a mixture of sodium chloride and potassium chloride (Maurer 1983; Dunaif and Khoo 1986). It has been suggested that calcium also plays an important role in regulating blood pressure.

Interactions with Other Food Components

The behavior of minerals is often influenced by the presence of other food constituents. The recent interest in the beneficial effect of dietary fiber has led to studies of the role fiber plays in the absorption of minerals. It has been shown (Toma and Curtis 1986) that mineral absorption is decreased by fiber. A study of the behavior of iron, zinc, and calcium showed that interactions occur with phytate, which is present in fiber. Phytates can form insoluble complexes with iron and zinc and may interfere with the

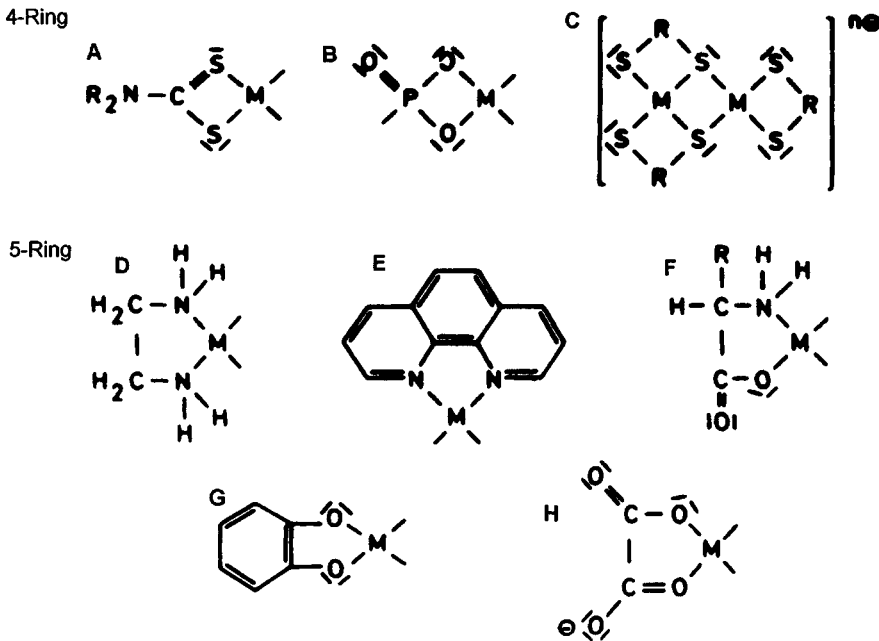

Figure 5-1 Examples of Metal Chelates. Only the relevant portions of the molecules are shown. The chelate formers are: (A) thiocarbamate, (B) phosphate, (C) thioacid, (D) diamine, (E) *o*-phenantroline, (F) α -aminoacid, (G) *o*-diphenol, (H) oxalic acid. *Source:* From K. Pfeilsticker, Food Components as Metal Chelates, *Food Sci. Technol.*, Vol. 3, pp. 45-51, 1970.

absorption of calcium by causing formation of fiber-bound calcium in the intestines.

Iron bioavailability may be increased in the presence of meat (Politz and Clydesdale 1988). This is the so-called meat factor. The exact mechanism of this effect is not known, but it has been suggested that amino acids or polypeptides that result from digestion are able to chelate nonheme iron. These complexes would facilitate the absorption of iron. In nitrite-cured meats some factors promote iron bioavailability (the meat factor), particularly heme iron and ascorbic acid or erythorbic acid. Negative factors may include nitrite and nitrosated heme (Lee and Greger 1983).

Minerals in Milk

The normal levels of the major mineral constituents of cow's milk are listed in Table 5-1. These are average values; there is a considerable natural variation in the levels of these constituents. A number of factors influence the variations in salt composition, such as feed, season, breed and individuality of the cow, stage of lactation, and udder infections. In all but the last case, the variations in individual mineral constituents do not affect the milk's osmotic pressure. The ash content of milk is relatively constant at about 0.7 percent. An important difference between milk and blood plasma is the rela-

Table 5-1 Average Values for Major Mineral Content of Cow's Milk (Skim Milk)

<i>Constituent</i>	<i>Normal Level (mg/100 mL)</i>
Sodium	50
Potassium	145
Calcium	120
Magnesium	13
Phosphorus (total)	95
Phosphorus (inorganic)	75
Chloride	100
Sulfate	10
Carbonate (as CO ₂)	20
Citrate (as citric acid)	175

tive levels of sodium and potassium. Blood plasma contains 330 mg/100 mL of sodium and only 20 mg/100 mL of potassium. In contrast, the potassium level in milk is about three times as high as that of sodium. Some of the mineral salts of milk are present at levels exceeding their solubility and therefore occur in the colloidal form. Colloidal particles in milk contain calcium, magnesium, phosphate, and citrate. These colloidal particles precipitate with the curd when milk is coagulated with rennin. Dialysis and ultrafiltration are other methods used to obtain a serum free from these colloidal particles. In milk the salts of the weak acids (phosphates, citrates, and carbonates) are distributed among the various possible ionic forms. As indicated by Jenness and Patton (1959), the ratios of the ionic species can be calculated by using the Henderson-Hasselbach equation,

$$\text{pH} = \text{p}K_{\alpha} + \log \frac{[\text{salt}]}{[\text{acid}]}$$

The values for the dissociation constants of the three acids are listed in Table 5-2. When these values are substituted in the Henderson-Hasselbach equation for a sample of milk at pH 6.6, the following ratios will be obtained:

$$\frac{\text{Citrate}^{-}}{\text{Citric acid}} = 3,000 \quad \frac{\text{Citrate}^{\equiv}}{\text{Citrate}^{-}} = 72$$

$$\frac{\text{Citrate}^{\equiv}}{\text{Citrate}^{\equiv}} = 16$$

From these ratios we can conclude that in milk at pH 6.6 no appreciable free citric acid or monocitrate ion is present and that tricitrate and dicitrate are the predominant ions, present in a ratio of about 16 to 1. For phosphates, the following ratios are obtained:

$$\frac{\text{H}_2\text{PO}_4^{-}}{\text{H}_3\text{PO}_4} = 43,600 \quad \frac{\text{HPO}_4^{\equiv}}{\text{H}_2\text{PO}_4^{-}} = 0.30$$

$$\frac{\text{PO}_4^{\equiv}}{\text{HPO}_4^{\equiv}} = 0.000002$$

This indicates that mono- and diphosphate ions are the predominant species. For carbonates the ratios are as follows:

$$\frac{\text{HCO}_3^{-}}{\text{H}_2\text{CO}_3} = 1.7$$

$$\frac{\text{CO}_3^{\equiv}}{\text{HCO}_3^{-}} = 0.0002$$

Table 5-2 Dissociation Constants of Weak Acids

Acid	pK_1	pK_2	pK_3
Citric	3.08	4.74	5.40
Phosphoric	1.96	7.12	10.32
Carbonic	6.37	10.25	—

The predominant forms are bicarbonates and the free acid.

Note that milk contains considerably more cations than anions; Jenness and Patton (1959) have suggested that this can be explained by assuming the formation of complex ions of calcium and magnesium with the weak acids. In the case of citrate (symbol C^-) the following equilibria exist:

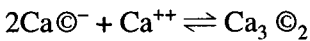
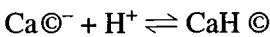
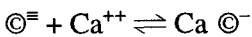
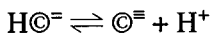

Soluble complex ions such as Ca C^- can account for a considerable portion of the calcium and magnesium in milk, and analogous complex ions can be formed with phosphate and possibly with bicarbonate.

The equilibria described here are represented schematically in Figure 5-2, and the levels of total and soluble calcium and phosphorus are listed in Table 5-3. The mineral equilibria in milk have been extensively studied because the ratio of ionic and total calcium exerts a profound effect on the stability of the caseinate particles in milk. Pro-

cessing conditions such as heating and evaporation change the salt equilibria and therefore the protein stability. When milk is heated, calcium and phosphate change from the soluble to the colloidal phase. Changes in pH result in profound changes of all of the salt equilibria in milk. Decreasing the pH results in changing calcium and phosphate from the colloidal to the soluble form. At pH 5.2, all of the calcium and phosphate of milk becomes soluble. An equilibrium change results from the removal of CO_2 as milk leaves the cow's udder. This loss of CO_2 by stirring or heating results in an increased pH. Concentration of milk results in a dual effect. The reduction in volume leads to a change of calcium and phosphate to the colloidal phase, but this also liberates hydrogen ions, which tend to dissolve some of the colloidal calcium phosphate. The net result depends on initial salt balance of the milk and the nature of the heat treatment.

The stability of the caseinate particles in milk can be measured by a test such as the heat stability test, rennet coagulation test, or alcohol stability test. Addition of various phosphates—especially polyphosphates, which are effective calcium complexing agents—can increase the caseinate stability of milk. Addition of calcium ions has the opposite effect and decreases the stability of milk. Calcium is bound by polyphosphates in the form of a chelate, as shown in Figure 5-3.

Minerals in Meat

The major mineral constituents of meat are listed in Table 5-4. Sodium, potassium, and phosphorus are present in relatively high amounts. Muscle tissue contains much more potassium than sodium. Meat also contains considerably more magnesium than calcium. Table 5-4 also provides information

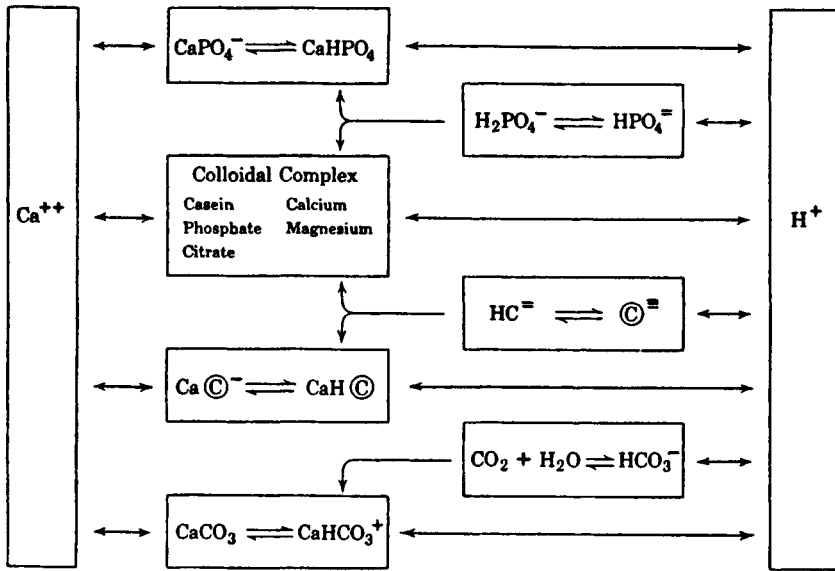

Figure 5-2 Equilibrium Among Milk Salts. *Source:* Reprinted with permission from R. Jenness and S. Patton, *Principles of Dairy Chemistry*, © 1959, John Wiley & Sons.

about the distribution of these minerals between the soluble and nonsoluble forms. The nonsoluble minerals are associated with the proteins. Since the minerals are mainly associated with the nonfatty portion of meat, the leaner meats usually have a higher mineral or ash content. When liquid is lost from meat (drip loss), the major element lost is sodium and, to a lesser extent, calcium,

phosphorus, and potassium. Muscle tissue consists of about 40 percent intracellular fluid, 20 percent extracellular fluid, and 40 percent solids. The potassium is found almost entirely in the intracellular fluid, as are magnesium, phosphate, and sulfate. Sodium is mainly present in the extracellular

Table 5-3 Total and Soluble Calcium and Phosphorus Content of Milk

Constituent	mg/100 mL
Total calcium	112.5
Soluble calcium	35.2
Ionic calcium	27.0
Total phosphorus	69.6
Soluble phosphorus	33.3

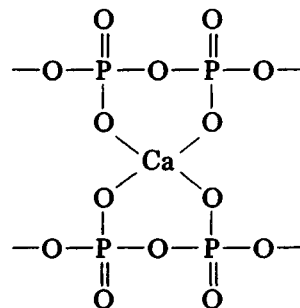

Figure 5-3 Calcium Chelate of a Polyphosphate

Table 5-4 Mineral Constituents in Meat (Beef)

Constituent	mg/100 g
Total calcium	8.6
Soluble calcium	3.8
Total magnesium	24.4
Soluble magnesium	17.7
Total citrate	8.2
Soluble citrate	6.6
Total inorganic phosphorus	233.0
Soluble inorganic phosphorus	95.2
Sodium	168
Potassium	244
Chloride	48

fluid in association with chloride and bicarbonate. During cooking, sodium may be lost, but the other minerals are well retained. Processing does not usually reduce the mineral content of meat. Many processed meats are cured in a brine that contains mostly sodium

chloride. As a result, the sodium content of cured meats may be increased.

Ionic equilibria play an important role in the water-binding capacity of meat (Hamm 1971). The normal pH of rigor or post-rigor muscle (pH 5.5) is close to the isoelectric point of actomyosin. At this point the net charge on the protein is at a minimum. By addition of an acid or base, a cleavage of salt cross-linkages occurs, which increases the electrostatic repulsion (Figure 5-4), loosens the protein network, and thus permits more water to be taken up. Addition of neutral salts such as sodium chloride to meat increases water-holding capacity and swelling. The swelling effect has been attributed mainly to the chloride ion. The existence of intra- and extracellular fluid components has been described by Merkel (1971) and may explain the effect of salts such as sodium chloride. The proteins inside the cell membrane are nondiffusible, whereas the inorganic ions may move across this semipermeable membrane. If a solution of the sodium salt of a

Acid:**Base:**

Figure 5-4 Schematic Representation of the Addition of Acid (HA) or Base (B^-) to an Isoelectric Protein. The isoelectric protein has equal numbers of positive and negative charges. The acid HA donates protons, the base B^- accepts protons. *Source:* Reprinted with permission from R. Hamm, *Colloid Chemistry of Meat*, © 1972, Paul Parey (in German).

protein is on one side of the membrane and sodium chloride on the other side, diffusion will occur until equilibrium has been reached. This can be represented as follows:

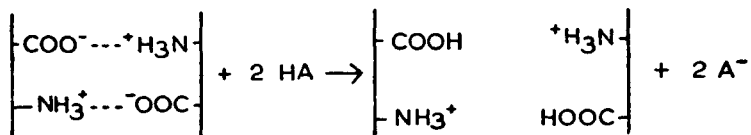
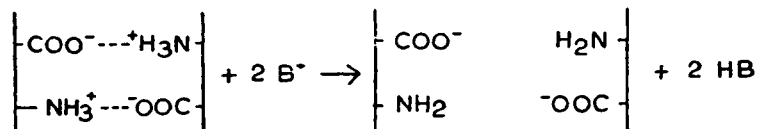
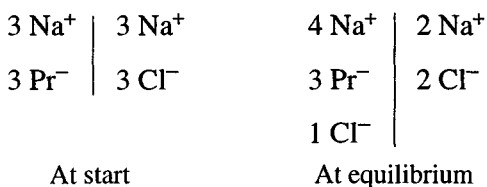

At equilibrium the product of the concentrations of diffusible ions on the left side of the membrane must be equal to the product on the right side, shown as follows:

$$[\text{Na}^+]_L [\text{Cl}^-]_L = [\text{Na}^+]_R [\text{Cl}^-]_R$$

In addition, the sum of the cations on one side must equal the sum of anions on the other side and vice versa:

$$[\text{Na}^+]_L = [\text{Pr}^-]_L + [\text{Cl}^-]_L \text{ and } [\text{Na}^+]_R = [\text{Cl}^-]_R$$

This is called the Gibbs-Donnan equilibrium and provides an insight into the reasons for the higher concentration of sodium ions in the intracellular fluid.

Struvite

Occasionally, phosphates can form undesirable crystals in foods. The most common example is struvite, a magnesium-ammonium phosphate of the composition $\text{Mg} \cdot (\text{NH}_4)\text{PO}_4 \cdot 6\text{H}_2\text{O}$. Struvite crystals are easily mistaken by consumers for broken pieces of glass. Most reports of struvite formation have been related to canned seafood, but occasionally the presence of struvite in other foods has been reported. It is assumed that in canned seafood, the struvite is formed from the magnesium of sea water and ammo-

nia generated by the effect of heat on the fish or shellfish muscle protein.

Minerals in Plant Products

Plants generally have a higher content of potassium than of sodium. The major minerals in wheat are listed in Table 5-5 and include potassium, phosphorus, calcium, magnesium, and sulfur (Schrenk 1964). Sodium in wheat is present at a level of only about 80 ppm and is considered a trace element in this case. The minerals in a wheat kernel are not uniformly distributed; rather, they are concentrated in the areas close to the bran coat and in the bran itself. The various fractions resulting from the milling process have quite different ash contents. The ash content of flour is considered to be related to quality, and the degree of extraction of wheat in milling can be judged from the ash content of the flour. Wheat flour with high ash content is darker in color; generally, the lower the ash content, the whiter the flour. This general principle applies, but the ash content of wheat may vary within wide limits and is influenced by rainfall, soil conditions, fertilizers, and other factors. The distribution of mineral components in the various parts of the wheat kernel is shown in Table 5-6.

Table 5-5 Major Mineral Element Components in Wheat Grain

Element	Average (%)	Range (%)
Potassium	0.40	0.20-0.60
Phosphorus	0.40	0.15-0.55
Calcium	0.05	0.03-0.12
Magnesium	0.15	0.08-0.30
Sulfur	0.20	0.12-0.30

Source: Reprinted with permission from W.G. Schrenk, *Minerals in Wheat Grain*, Technical Bulletin 136, © 1964, Kansas State University Agricultural Experimental Station.

High-grade patent flour, which is pure endosperm, has an ash content of 0.30 to 0.35 percent, whereas whole wheat meal may have an ash content from 1.35 to 1.80 percent.

The ash content of soybeans is relatively high, close to 5 percent. The ash and major mineral levels in soybeans are listed in Table 5-7. Potassium and phosphorus are the elements present in greatest abundance. About 70 to 80 percent of the phosphorus in soybeans is present in the form of phytic acid, the phosphoric acid ester of inositol (Figure 5-5). Phytin is the calcium-magnesium-potassium salt of inositol hexaphosphoric acid or phytic acid. The phytates are important because of their effect on protein solubility and because they may interfere with absorption of calcium from the diet. Phytic acid is present in many foods of plant origin.

A major study of the mineral composition of fruits was conducted by Zook and Lehmann (1968). Some of their findings for the major minerals in fruits are listed in Table 5-8. Fruits are generally not as rich in minerals as vegetables are. Apples have the low-

est mineral content of the fruits analyzed. The mineral levels of all fruits show great variation depending on growing region.

The rate of senescence of fruits and vegetables is influenced by the calcium content of the tissue (Poovaiah 1986.) When fruits and vegetables are treated with calcium solutions, the quality and storage life of the products can be extended.

TRACE ELEMENTS

Because trace metals are ubiquitous in our environment, they are found in all of the foods we eat. In general, the abundance of trace elements in foods is related to their abundance in the environment, although this relationship is not absolute, as has been indicated by Warren (1972b). Table 5-9 presents the order of abundance of some trace elements in soil, sea water, vegetables, and humans and the order of our intake. Trace elements may be present in foods as a result of uptake from soil or feeds or from contamination during and subsequent to processing

Table 5-6 Mineral Components in Endosperm and Bran Fractions of Red Winter Wheat

	<i>P</i> (%)	<i>K</i> (%)	<i>Na</i> (%)	<i>Ca</i> (%)	<i>Mg</i> (%)	<i>Mn</i> (ppm)	<i>Fe</i> (ppm)	<i>Cu</i> (ppm)
Total endosperm	0.10	0.13	0.0029	0.017	0.016	2.4	13	8
Total bran	0.38	0.35	0.0067	0.032	0.11	32	31	11
Wheat kernel								
Center section	0.35	0.34	0.0051	0.025	0.086	29	40	7
Germ end	0.55	0.52	0.0036	0.051	0.13	77	81	8
Brush end	0.41	0.41	0.0057	0.036	0.13	44	46	12
Entire kernel	0.44	0.42	0.0064	0.037	0.11	49	54	8

Source: From V.H. Morris et al., Studies on the Composition of the Wheat Kernel. II. Distribution of Certain Inorganic Elements in Center Sections, *Cereal Chem.*, Vol. 22, pp. 361-372, 1945.

Table 5-7 Mineral Content of Soybeans (Dry Basis)

Mineral	No. of Analyses	Range (%)	Mean (%)
Ash	—	3.30–6.35	4.60
Potassium	29	0.81–2.39	1.83
Calcium	9	0.19–0.30	0.24
Magnesium	7	0.24–0.34	0.31
Phosphorus	37	0.50–1.08	0.78
Sulfur	6	0.10–0.45	0.24
Chlorine	2	0.03–0.04	0.03
Sodium	6	0.14–0.61	0.24

Source: Reprinted with permission from A.K. Smith and S.J. Circle, *Soybeans: Chemistry and Technology*, © 1972, AVI Publishing Co.

of foods. For example, the level of some trace elements in milk depends on the level in the feed; for other trace elements, increases in levels in the feed are not reflected in increased levels in the milk. Crustacea and mollusks accumulate metal ions from the ambient sea water. As a result,

concentrations of 8,000 ppm of copper and 28,000 ppm of zinc have been recorded (Meranger and Somers 1968). Contamination of food products with metal can occur as a result of pickup of metals from equipment or from packaging materials, especially tin cans. The nickel found in milk comes almost

**Figure 5-5** Inositol and Phytic Acid

Table 5-8 Mineral Content of Some Fruits

Fruit	Minerals (mg/100 g)				
	N	Ca	Mg	P	K
Orange (California navel)	162	23.7	10.2	15.8	175
Apple (McIntosh)	30	2.4	3.6	5.4	96
Grape (Thompson)	121	6.2	5.8	12.8	200
Cherry (Bing)	194	9.6	16.2	13.3	250
Pear (Bartlett)	63	4.8	6.5	9.3	129
Banana (Ecuador)	168	2.7	25.4	16.4	373
Pineapple (Puerto Rico)	71	2.2	3.9	3.0	142

Source: From E.G. Zook and J. Lehmann, Mineral Composition of Fruits, *J. Am. Dietetic Assoc.*, Vol. 52, pp. 225-231, 1968.

exclusively from stainless steel in processing equipment. Milk coming from the udder has no detectable nickel content. On the other hand, nutritionists are concerned about the low iron intake levels for large numbers of the population; this low intake can in part be explained by the disappearance of iron equipment and utensils from processing and food preparation.

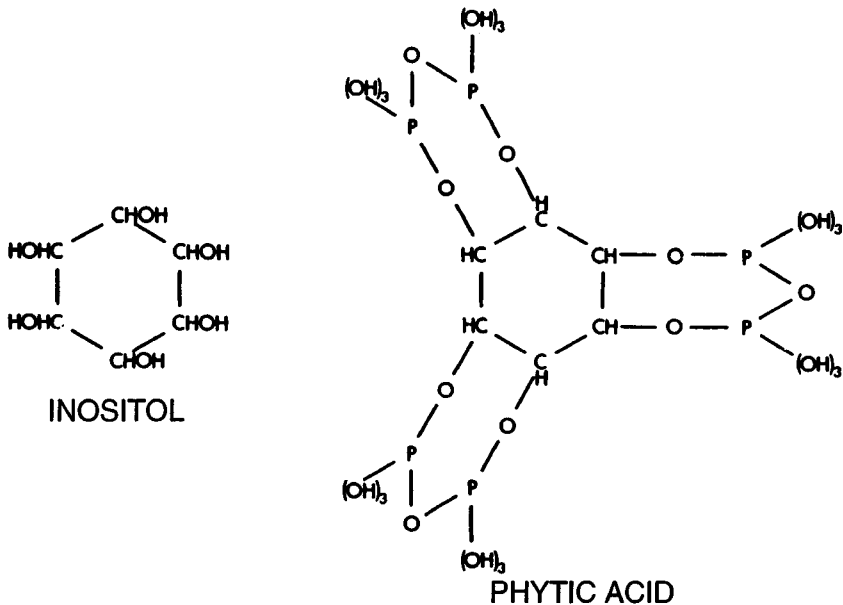
Originally, nine of the trace elements were considered to be essential to humans: cobalt, copper, fluorine, iodine, iron, manganese, molybdenum, selenium, and zinc. Recently, chromium, silicon, and nickel have been added to this list (Reilly 1996). These are mostly metals; some are metalloids. In addition to essential trace elements, several trace elements have no known essentiality and

Table 5-9 Order of Abundance of Some Trace Elements in Various Media

Element	Soil	Sea Water	Vegetables	Man	Man's Intake
Iron	1	1	1	1	1
Manganese	2	4	3	5	3
Nickel	4	7	6	6	5
Zinc	3	2	2	2	2
Copper	5	3	4	3	4
Cobalt	7	8	8	8	8
Lead	6	5	5	4	6
Molybdenum	8	6	7	7	7
Cadmium	9	?	9	9	9
Mercury	?	9	?	10	?

Source: From H.V. Warren, Geology and Medicine, *Western Miner*, pp. 34-37, 1972.

some are toxic (such as lead, mercury, and cadmium). These toxic trace elements, which are classified as contaminants, are dealt with in Chapter 11.

Trace elements get into foods by different pathways. The most important source is from the soil, by absorption of elements in aqueous solution through the roots. Another, minor, source is foliar penetration. This is usually associated with industrial air pollution and vehicle emissions. Other possible sources are fertilizers, agricultural chemicals, and sewage sludge. Sewage sludge is a good source of nitrogen and phosphate but may contain high levels of trace minerals, many of these originating from industrial activities such as electroplating. Trace minerals may also originate from food processing and handling equipment, food packaging materials, and food additives.

Cobalt

Cobalt is an integral part of the only metal containing vitamin B₁₂. The level of cobalt in foods varies widely, from as little as 0.01 ppm in corn and cereals to 1 ppm in some legumes. The human requirement is very small and deficiencies do not occur.

Copper

Copper is present in foods as part of several copper-containing enzymes, including the polyphenolases. Copper is a very powerful prooxidant and catalyzes the oxidation of unsaturated fats and oils as well as ascorbic acid. The normal daily diet contains from 2 to 5 mg of copper, more than ample to cover the daily requirement of 0.6 to 2 mg.

Iron

Iron is a component of the heme pigments and of some enzymes. In spite of the fact that some foods have high iron levels, much of the population has frequently been found to be deficient in this element. Animal food products may have high levels that are well absorbed; liver may contain several thousand ppm of iron. The iron from other foods such as vegetables and eggs is more poorly absorbed. In the case of eggs the uptake is poor because the ferric iron is closely bound to the phosphate of the yolk phosphoproteins. Iron is used as a food additive to enrich flour and cereal products. The form of iron used significantly determines how well it will be taken up by the body. Ferrous sulfate is very well absorbed, but will easily discolor or oxidize the food to which it is added. Elemental iron is also well absorbed and is less likely to change the food. For these reasons, it is the preferred form of iron for the enrichment of flour.

Zinc

Zinc is the second most important of the essential trace elements for humans. It is a constituent of some enzymes, such as carbonic anhydrase. Zinc is sufficiently abundant that deficiencies of zinc are unknown. The highest levels of zinc are found in shellfish, which may contain 400 ppm. The level of zinc in cereal grains is 30 to 40 ppm. When acid foods such as fruit juices are stored in galvanized containers, sufficient zinc may be dissolved to cause zinc poisoning. The zinc in meat is tightly bound to the myofibrils and has been speculated to influence meat's water-binding capacity (Hamm 1972).

Manganese

Manganese is present in a wide range of foods but is not easily absorbed. This metal is associated with the activation of a number of enzymes. In wheat, a manganese content of 49 ppm has been reported (Schrenk 1964). This is mostly concentrated in the germ and bran; the level in the endosperm is only 2.4 ppm. Information on the manganese content of seafoods has been supplied by Meranger and Somers (1968). Values range from a low of 1.1 ppm in salmon to a high of 42 ppm in oyster.

Molybdenum

Molybdenum plays a role in several enzyme reactions. Some of the molybdenum-containing enzymes are aldehyde oxidase, sulfite oxidase, xanthine dehydrogenase, and xanthine oxidase. This metal is found in cereal grains and legumes; leafy vegetables, especially those rich in chlorophyll; animal organs; and in relatively small amounts, less than 0.1 ppm, in fruits. The molybdenum content of foods is subject to large variations.

Selenium

Selenium has recently been found to protect against liver necrosis. It usually occurs bound to organic molecules. Different selenium compounds have greater or lesser protective effect. The most active form of selenium is selenite, which is also the least stable chemically. Many selenium compounds are volatile and can be lost by cooking or processing. Kiermeier and Wigand (1969) found about a 5 percent loss of selenium as a result of drying of skim milk. The variation in selenium content of milk is wide

and undoubtedly associated with the selenium content of the soil. The same authors report figures for selenium in milk in various parts of the world ranging from 5 to 1,270 $\mu\text{g}/\text{kg}$. The selenium in milk is virtually all bound to the proteins. Morris and Levander (1970) determined the selenium content of a wide variety of foods. Most fruits and vegetables contain less than 0.01 $\mu\text{g}/\text{g}$. Grain products range from 0.025 to 0.66 $\mu\text{g}/\text{g}$, dried skim milk from 0.095 to 0.24 $\mu\text{g}/\text{g}$, meat from 0.1 to 1.9 $\mu\text{g}/\text{g}$, and seafood from 0.4 to 0.7 $\mu\text{g}/\text{g}$.

Fluorine

Fluorine is a constituent of skeletal bone and helps reduce the incidence of dental caries. The fluorine content of drinking water is usually below 0.2 mg/L but in some locations may be as high as 5 mg/L. The optimal concentration for dental health is 1 mg/L. The fluoride content of vegetables is low, with the exception of spinach, which contains 280 $\mu\text{g}/100\text{ g}$. Milk contains 20 $\mu\text{g}/100\text{ g}$ and beef about 100 $\mu\text{g}/100\text{ g}$. Fish foods may contain up to 700 $\mu\text{g}/100\text{ g}$ and tea about 100 $\mu\text{g}/\text{g}$.

Iodine

Iodine is not present in sufficient amounts in the diet in several areas of the world; an iodine deficiency results in goiter. The addition of iodine to table salt has been extremely effective in reducing the incidence of goiter. The iodine content of most foods is in the area of a few mg/100 g and is subject to great local variations. Fish and shellfish have higher levels. Saltwater fish have levels of about 50 to 150 mg/100 g and shellfish may have levels as high as 400 mg/100 g.

Nickel

Foods with a relatively high nickel content include nuts, legumes, cocoa products, shellfish, and hydrogenated fats. The source of nickel in the latter results from the use of nickel catalyst in the hydrogenation process. Animal products are generally low in nickel, plant products high (Table 5–10). The intake of nickel from the diet depends, therefore, on the origin and amounts of various foods consumed. Dietary nickel intake has been estimated to be in the range of 150 to 700 $\mu\text{g}/\text{day}$ (Nielsen 1988), and the suggested dietary nickel requirement is about 35 $\mu\text{g}/\text{day}$.

Finished hydrogenated vegetable oils contain less than 1 mg/kg nickel. Treatment of the finished oil with citric or phosphoric acid followed by bleaching should result in nickel levels of less than 0.2 mg/kg.

Chromium

Recent well-controlled studies (Anderson 1988) have found that dietary intake of chro-

mium is in the order of 50 $\mu\text{g}/\text{day}$. Refining and processing of foods may lead to loss of chromium. As an example, in the milling of flour, recovery of chromium in white flour is only 35 to 44 percent of that of the parent wheat (Zook et al. 1970). On the other hand, the widespread use of stainless steel equipment in food processing results in leaching of chromium into the food products (Offenbacher and Pi-Sunyer 1983). No foods are known to contain higher-than-average levels of chromium. The average daily intake of chromium from various food groups is shown in Table 5–11. It has been suggested that the dietary intake of chromium in most normal individuals is suboptimal and can lead to nutritional problems (Anderson 1988).

Silicon

Silicon is ubiquitous in the environment and present in many foods. Foods of animal origin are relatively low in silicon; foods of plant origin are relatively high. Good plant sources are unrefined grains, cereal products, and root crops. The dietary intake of silicon is poorly known but appears to be in the range of 20 to 50 $\mu\text{g}/\text{day}$. Although silicon is now regarded as an essential mineral for humans, a minimum requirement has not been established.

Additional Information on Trace Elements

The variations in trace elements in vegetables may be considerable (Warren 1972a) and may depend to a large extent on the nature of the soil in which the vegetables are grown. Table 5–12 illustrates the extent of the variability in the content of copper, zinc, lead, and molybdenum of a number of vege-

Table 5–10 Nickel Content of Some Foods

<i>Food</i>	<i>Nickel Content ($\mu\text{g}/\text{g}$ Fresh Weight)</i>
Cashew nuts	5.1
Peanuts	1.6
Cocoa powder	9.8
Bittersweet chocolate	2.6
Milk chocolate	1.2
Red kidney beans	0.45
Peas, frozen	0.35
Spinach	0.39
Shortening	0.59–2.78

Source: Reprinted with permission from F.H. Nielsen, The Ultratrace Elements, in *Trace Minerals in Foods*, K.T. Smith, ed., p. 385, 1988, by courtesy of Marcel Dekker, Inc.

Table 5-11 Chromium Intake from Various Food Groups

<i>Food Group</i>	<i>Average Daily Intake (μg)</i>	<i>Comments</i>
Cereal products	3.7	55% from wheat
Meat	5.2	55% from pork 25% from beef
Fish and seafood	0.6	
Fruits, vegetables, nuts	6.8	70% from fruits and berries
Dairy products, eggs, margarine	6.2	85% from milk
Beverages, confectionery, sugar, and condiments	6.6	45% from beer, wine, and soft drinks
Total	29.1	

Source: Reprinted with permission from R.A. Anderson, Chromium, in *Trace Minerals in Foods*, K.T. Smith, ed., p. 238, 1988, by courtesy of Marcel Dekker, Inc.

tables. The range of concentrations of these metals frequently covers one order of magnitude and occasionally as much as two orders of magnitude. Unusually high concentrations of certain metals may be associated with the incidence of diseases such as multiple sclerosis and cancer in humans.

Aluminum, which has been assumed to be nonnutritious and nontoxic, has come under increasing scrutiny. Its presence has been suggested to be involved in several serious conditions, including Alzheimer's disease (Greger 1985). Since aluminum is widely used in utensils and packaging materials, there is great interest in the aluminum content of foods. Several aluminum salts are used as food additives, for example, sodium aluminum phosphate as a leavening agent and aluminum sulfate for pH control. The estimated average daily intake of aluminum is 26.5 mg, with 70 percent coming from grain products (Greger 1985).

Fruits contain relatively high levels of organic acids, which may combine with metal ions. It is now generally agreed that

these compounds may form chelates of the general formula $M_yH_pL_m(OH)_x$, where M and L represent the metal and the ligand, respectively. According to Pollard and Timberlake (1971), cupric ions form strong complexes with acids containing α -hydroxyl groups. The major fruit acids, citric, malic, and tartaric, are multidendate ligands capable of forming polynuclear chelates. Cupric and ferric ions form stronger complexes than ferrous ions. The strongest complexes are formed by citrate, followed by malate and then tartrate.

METAL UPTAKE IN CANNED FOODS

Canned foods may take up metals from the container, tin and iron from the tin plate, and tin and lead from the solder. There are several types of internal can corrosion. *Rapid detinning* is one of the most serious problems of can corrosion. With most acid foods, when canned in the absence of oxygen, tin forms the anode of the tin-iron couple. The tin under these conditions goes into solution

Table 5-12 Extreme Variation in the Content of Copper, Zinc, Lead, and Molybdenum in Some Vegetables

	"Normal" Content in ppm Wet Weight	Minimum as Fraction of "Normal"	Maximum as Multiple of "Normal"	Extreme Range
Copper				
Lettuce	0.74	$\frac{1}{15}$	8	1-120
Cabbage	0.26	$\frac{1}{6}$	2.5	1-15
Potato	0.92	$\frac{1}{9}$	4	1-36
Bean (except broad)	0.56	$\frac{2}{5}$	2.5	1-22
Carrot	0.52	$\frac{1}{6}$	2.5	1-22
Beet	0.78	$\frac{1}{6}$	2.5	1-20
Zinc				
Lettuce	4.9	$\frac{1}{6}$	15	1-90
Cabbage	1.9	$\frac{1}{2}$	6	1-12
Potato	2.9	$\frac{1}{2}$	5	1-10
Bean (except broad)	3.6	$\frac{1}{2}$	2	1-4
Carrot	3.4	$\frac{1}{2}$	8	1-48
Beet	4.1	$\frac{1}{4}$	12	1-16
Lead				
Lettuce	0.25	$\frac{1}{10}$	30	1-300
Cabbage	0.10	$\frac{1}{8}$	2.5	1-20
Potato	0.40	$\frac{1}{10}$	15	1-150
Bean (except broad)	0.24	$\frac{1}{5}$	4	1-20
Carrot	0.22	$\frac{1}{3}$	9	1-27
Beet	0.20	$\frac{1}{6}$	11	1-66
Molybdenum				
Lettuce	0.06	$\frac{1}{8}$	12	1-96
Cabbage	0.20	$\frac{1}{30}$	8	1-240
Potato	0.15	$\frac{1}{16}$	7.5	1-120
Bean (except broad)	0.48	$\frac{1}{30}$	7	1-210
Carrot	0.22	$\frac{1}{4}$	3.5	1-14
Beet	0.04	$\frac{1}{30}$	10	1-300

Source: From H.V. Warren, Variations in the Trace Element Contents of Some Vegetables, *J. Roy. Coll. Gen. Practit.*, Vol. 22, pp. 56-60, 1972.

at an extremely slow rate and can provide product protection for two years or longer. There are, however, conditions where iron forms the anode, and in the presence of depolarizing or oxidizing agents the dissolution of tin is greatly accelerated. The food is

protected until most of the tin is dissolved; thereafter, hydrogen is produced and the can swells and becomes a *springer*. Some foods are more likely to involve rapid detinning, including spinach, green beans, tomato products, potatoes, carrots, vegetable soups, and

certain fruit juices such as prune and grapefruit juice.

Another corrosion problem of cans is sulfide staining. This may happen when the food contains the sulfur-containing amino acids cysteine, cystine, or methionine. When the food is heated or aged, reduction may result in the formation of sulfide ions, which can then react with tin and iron to form SnS and FeS. The compound SnS is the major component of the sulfide stain. This type of corrosion may occur with foods such as pork, fish, and peas (Seiler 1968). Corrosion of tin cans depends on the nature of the canned food as well as on the type of tin plate used. Formerly, hot dipped tin plate was used, but this has been mostly replaced by electrolytically coated plate. It has been shown (McKirahan et al. 1959) that the size of the crystals in the tin coating has an important effect on corrosion resistance. Tin plate with small tin crystals easily develops hydrogen swell, whereas tin plate containing large crystals is quite resistant. Seiler (1968) found that the orientation of the different crystal planes also significantly affected the ease of forming sulfide stains.

The influence of processing techniques for grapefruit juice on the rate of can corrosion was studied by Bakal and Mannheim (1966). They found that the dissolved tin content can serve as a corrosion indicator. In Israel the maximum prescribed limit for tin content of canned food is 250 ppm. Deaeration of the juice significantly lowers tin dissolution. In a study of the in-can shelf life of tomato paste, Vander Merwe and Knock (1968) found that, depending on maturity and variety, 1 g of tomato paste stored at 22°C could corrode tin at rates ranging from 9×10^{-6} g/month to 68×10^{-6} g/month. The useful shelf life could vary from 24 months to as few as 3 months. Up to 95 percent of the variation could be

related to effects of maturity and variety and the associated differences in contents of water-insoluble solids and nitrate.

Severe detinning has often been observed with applesauce packed in plain cans with enameled ends. This is usually characterized by detinning at the headspace interface. Stevenson and Wilson (1968) found that steam flow closure reduced the detinning problem, but the best results were obtained by complete removal of oxygen through nitrogen closure. Detinning by canned spinach was studied by Lambeth et al. (1969) and was found to be significantly related to the oxalic acid content of the fresh leaves and the pH of the canned product. High-oxalate spinach caused detinning in excess of 60 percent after 9 months' storage.

In some cases the dissolution of tin into a food may have a beneficial effect on food

Table 5-13 Iron and Tin Content of Fruit Juices

<i>Product</i>	<i>Iron (ppm)</i>	<i>Tin (ppm)</i>
Fresh orange juice	0.5	7.5
Bottled orange juice	2.5	25
Bottled orange juice	2.0	50
Bottled pineapple juice	15.0	50
Canned orange juice	2.5	60
Canned orange juice	0.5	115
Canned orange juice	2.5	120
Canned pineapple juice	17.5	135

Source: From W.J. Price and J.T.H. Roos, Analysis of Fruit Juice by Atomic Absorption Spectrophotometry. I. The Determination of Iron and Tin in Canned Juice, *J. Sci. Food Agric.*, Vol. 20, pp. 427-439, 1969.

color, with iron having the opposite effect. This is the case for canned wax beans (Van Buren and Downing 1969). Stannous ions were effective in preserving the light color of the beans, whereas small amounts of iron resulted in considerable darkening. A black discoloration has sometimes been observed in canned all-green asparagus after opening of the can. This has been attributed (Lueck 1970) to the formation of a black, water-insoluble coordination compound of iron and rutin. The iron is dissolved from the can,

and the rutin is extracted from the asparagus during the sterilization. Rutin is a flavonol, the 3-rutinoside of quercetin. The black discoloration occurs only after the iron has been oxidized to the ferric state. Tin forms a yellow, water-soluble complex with rutin, which does not present a color problem. The uptake of iron and tin from canned foods is a common occurrence, as is demonstrated by Price and Roos (1969), who studied the presence of iron and tin in fruit juice (Table 5-13).

REFERENCES

- Anderson, R.A. 1988. Chromium. In *Trace minerals in foods*, ed. K.T. Smith. New York: Marcel Dekker.
- Bakal, A., and H.C. Mannheim. 1966. The influence of processing variants of grapefruit juice on the rate of can corrosion and product quality. *Israel J. Technol.* 4: 262-267.
- Dunaif, G.D., and C.-S. Khoo. 1986. Developing low and reduced-sodium products: An industrial perspective. *Food Technol.* 40, no. 12: 105-107.
- Greger, J.L. 1985. Aluminum content of the American diet. *Food Technol.* 39, no. 5: 73-80.
- Hamm, R. 1971. Interactions between phosphates and meat proteins. In *Phosphates in food processing*, ed. J.M. deMan and P. Melnychyn. Westport, CT: AVI Publishing Co.
- Hamm, R. 1972. *Colloid chemistry of meat* (in German). Berlin: Paul Parey.
- Jenness, R., and S. Patton. 1959. *Principles of dairy chemistry*. New York: John Wiley & Sons.
- Kiermeier, F., and W. Wigand. 1969. Selenium content of milk and milk powder (in German). *Z. Lebensm. Unters. Forsch.* 139: 205-211.
- Lambeth, V.N., et al. 1969. Detinning by canned spinach as related to oxalic acid, nitrates and mineral composition. *Food Technol.* 23, no. 6: 132-134.
- Lee, K., and J.L. Greger. 1983. Bioavailability and chemistry of iron from nitrite-cured meats. *Food Technol.* 37, no. 10: 139-144.
- Lueck, R.H. 1970. Black discoloration in canned asparagus. Interrelations of iron, tin, oxygen, and rutin. *Food Chem.* 18: 607-612.
- Marsh, A.C. 1983. Processes and formulations that affect the sodium content of foods. *Food Technol.* 37, no. 7: 45-49.
- Maurer, A.J. 1983. Reduced sodium usage in poultry muscle foods. *Food Technol.* 37, no. 7: 60-65.
- McKirahan, R.D., et al. 1959. Application of differentially coated tin plate for food containers. *Food Technol.* 13: 228-232.
- Meranger, J.C., and E. Somers. 1968. Determination of the heavy metal content of seafoods by atomic absorption spectrophotometry. *Bull. Environ. Contamination Toxicol.* 3: 360-365.
- Merkel, R.A. 1971. Inorganic constituents. In *The science of meat and meat products*, ed. J.F. Price and B.S. Schweigert. San Francisco: W.H. Freeman and Co.
- Morris, V.C., and O.A. Levander. 1970. Selenium content of foods. *J. Nutr.* 100: 1383-1388.
- Nielsen, F.H. 1988. The ultratrace elements. In *Trace minerals in foods*, ed. K.T. Smith. New York: Marcel Dekker.
- Offenbacher, E.G., and F.X. Pi-Sunyer. 1983. Temperature and pH effects on the release of chromium from stainless steel into water and fruit juices. *J. Agr. Food Chem.* 31: 89-92.
- Pfeilsticker, K. 1970. Food components as metal chelates. *Food Sci. Technol.* 3: 45-51.
- Politz, M.L., and F.M. Clydesdale. 1988. Effect of enzymatic digestion, pH and molecular weight on the iron solubilizing properties of chicken muscle. *J. Food Sci.* 52: 1081-1085, 1090.

- Pollard, A., and C.F. Timberlake. 1971. Fruit juices. In *The biochemistry of fruits and their products*, Vol. 2, ed. A.C. Hulme. New York: Academic Press.
- Poovaliah, B.W. 1986. Role of calcium in prolonging storage life of fruits and vegetables. *Food Technol.* 40, no. 5: 86–89.
- Price, W.J., and J.T.H. Roos. 1969. Analysis of fruit juice by atomic absorption spectrophotometry I. The determination of iron and tin in canned juice. *J. Sci. Food Agric.* 20: 427–439.
- Reilly, C. 1996. *Selenium in food and health*. London: Blackie Academic and Professional.
- Schrenk, W.G. 1964. *Minerals in wheat grain*. Technical Bulletin 136. Manhattan, KS: Kansas State University Agricultural Experimental Station.
- Schweiger, R.G. 1966. Metal chelates of pectate and comparison with alginate. *Kolloid Z.* 208: 28–31.
- Seiler, B.C. 1968. The mechanism of sulfide staining of tin foodpacks. *Food Technol.* 22: 1425–1429.
- Stevenson, C.A., and C.H. Wilson. 1968. Nitrogen enclosure of canned applesauce. *Food Technol.* 33: 1143–1145.
- Toma, R.B., and D.J. Curtis. 1986. Dietary fiber: Effect on mineral bioavailability. *Food Technol.* 40, no. 2: 111–116.
- Van Buren, J.P., and D.L. Downing. 1969. Can characteristics, metal additives, and chelating agents: Effect on the color of canned wax beans. *Food Technol.* 23: 800–802.
- Vander Merwe, H.B., and G.G. Knock. 1968. In-can shelf life of tomato paste as affected by tomato variety and maturity. *J. Food Technol.* 3: 249–262.
- Warren, H.V. 1972a. Variations in the trace element contents of some vegetables. *J. Roy. Coll. Gen. Practit.* 22: 56–60.
- Warren, H.V. 1972b. Geology and medicine. *Western Miner*, Sept., 34–37.
- Zook, E.G. et al. 1970. Nutrient composition of selected wheat and wheat products. *Cereal Chem.* 47: 720–727.
- Zook, E.G., and J. Lehmann. 1968. Mineral composition of fruits. *J. Am. Dietetic Assoc.* 52: 225–231.

Color

INTRODUCTION

Color is important to many foods, both those that are unprocessed and those that are manufactured. Together with flavor and texture, color plays an important role in food acceptability. In addition, color may provide an indication of chemical changes in a food, such as browning and caramelization. For a few clear liquid foods, such as oils and beverages, color is mainly a matter of transmission of light. Other foods are opaque—they derive their color mostly from reflection.

Color is the general name for all sensations arising from the activity of the retina of the eye. When light reaches the retina, the eye's neural mechanism responds, signaling color among other things. Light is the radiant energy in the wavelength range of about 400 to 800 nm. According to this definition, color (like flavor and texture) cannot be studied without considering the human sensory system. The color perceived when the eye views an illuminated object is related to the following three factors: the spectral composition of the light source, the chemical and physical characteristics of the object, and the spectral sensitivity properties of the eye. To evaluate the properties of the object, we must standardize the other two factors. Fortunately, the characteristics of different people's eyes

for viewing colors are fairly uniform; it is not too difficult to replace the eye by some instrumental sensor or photocell that can provide consistent results. There are several systems of color classification; the most important is the CIE system (Commission International de l'Eclairage—International Commission on Illumination). Other systems used to describe food color are the Munsell, Hunter, and Lovibond systems.

When the reflectance of different colored objects is determined by means of spectrophotometry, curves of the type shown in Figure 6-1 are obtained. White materials reflect equally over the whole visible wavelength range, at a high level. Gray and black materials also reflect equally over this range but to a lower degree. Red materials reflect in the higher wavelength range and absorb the other wavelengths. Blue materials reflect in the low-wavelength range and absorb the high-wavelength light.

CIE SYSTEM

The spectral energy distribution of CIE light sources *A* and *C* is shown in Figure 6-2. CIE illuminant *A* is an incandescent light operated at 2854°K, and illuminant *C* is the same light modified by filters to result in a

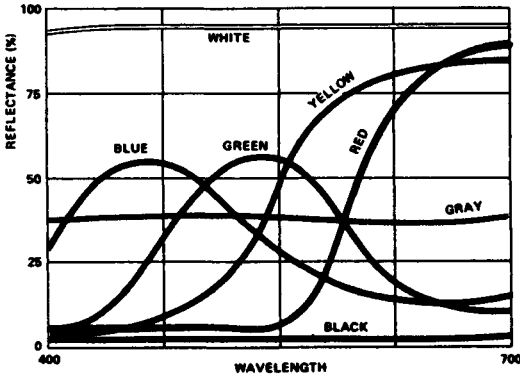

Figure 6-1 Spectrophotometric Curves of Colored Objects. *Source:* From Hunter Associates Lab., Inc.

spectral composition that approximates that of normal daylight. Figure 6-2 also shows the luminosity curve of the standard observer as specified by CIE. This curve indicates

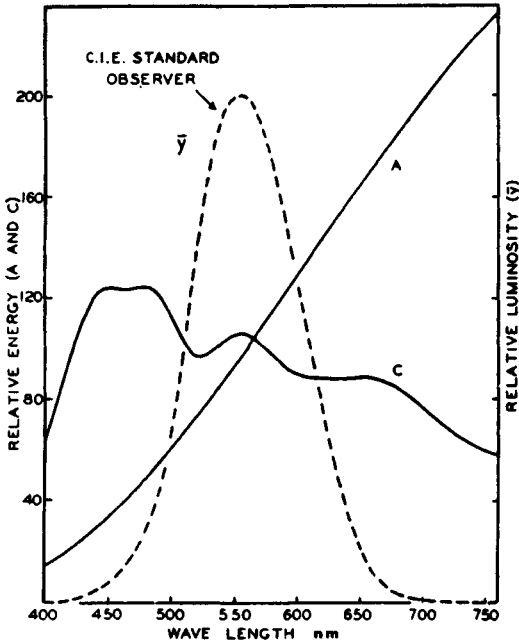

Figure 6-2 Spectral Energy Distribution of Light Sources A and C, the CIE, and Relative Luminosity Function γ for the CIE Standard Observer

how the eyes of normal observers respond to the various spectral light types in the visible portion of the spectrum. By breaking down the spectrum, complex light types are reduced to their component spectral light types. Each spectral light type is completely determined by its wavelength. In some light sources, a great deal of radiant energy is concentrated in a single spectral light type. An example of this is the sodium lamp shown in Figure 6-3, which produces monochromatic light. Other light sources, such as incandescent lamps, give off a continuous spectrum. A fluorescent lamp gives off a continuous spectrum on which is superimposed a line spectrum of the primary radiation produced by the gas discharge (Figure 6-3).

In the description of light sources, reference is sometimes made to the *black body*. This is a radiating surface inside a hollow space, and the light source's radiation comes out through a small opening. The radiation is independent of the type of material the light source is made of. When the temperature is very high, about 6000°K the maximum of the energy distribution will fall about in the middle of the visible spectrum. Such energy distribution corresponds with that of daylight on a cloudy day. At lower temperatures, the maximum of the energy distribution shifts to longer wavelengths. At 3000° K, the spectral energy distribution is similar to that of an incandescent lamp; at this temperature the energy at 380 nm is only one-sixteenth of that at 780 nm, and most of the energy is concentrated at higher wavelengths (Figure 6-3). The uneven spectral distribution of incandescent light makes red objects look attractive and blue ones unattractive. This is called color rendition. The human eye has the ability to adjust for this effect.

The CIE system is a trichromatic system; its basis is the fact that any color can be

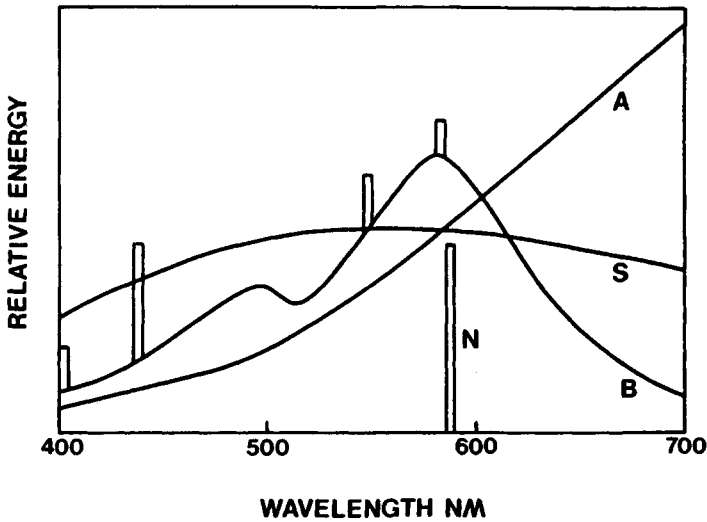

Figure 6-3 Spectral Energy Distribution of Sunlight (S), CIE Illuminant (A), Cool White Fluorescent Lamp (B), and Sodium Light (N)

matched by a suitable mixture of three primary colors. The three primary colors, or *primaries*, are red, green, and blue. Any possible color can be represented as a point in a triangle. The triangle in Figure 6-4 shows how colors can be designated as a ratio of the three primaries. If the red, green, and blue values of a given light type are represented by a , b , and c , then the ratios of each to the total light are given by $a/(a + b + c)$, $b/(a + b + c)$, and $c/(a + b + c)$, respectively. Since the sum of these is one, then only two have to be known to know all three. Color, therefore, is determined by two, not three, of these mutually dependent quantities. In Figure 6-4, a color point is represented by P . By determining the distance of P from the right angle, the quantities $a/(a + b + c)$ and $b/(a + b + c)$ are found. The quantity $c/(a + b + c)$ is then found, by first extending the horizontal dotted line through P until it crosses the hypotenuse at Q and by then constructing another right angle triangle with Q at the top. All combinations

of a , b , and c will be points inside the triangle.

The relative amounts of the three primaries required to match a given color are called the

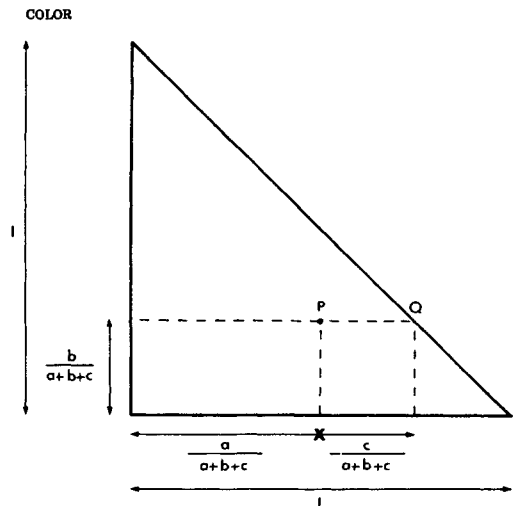

Figure 6-4 Representation of a Color as a Point in a Color Triangle

tristimulus values of the color. The CIE primaries are imaginary, because there are no real primaries that can be combined to match the highly saturated hues of the spectrum.

In the CIE system the red, green, and blue primaries are indicated by X , Y , and Z . The amount of each primary at any particular wavelength is given by the values \bar{x} , \bar{y} , and \bar{z} . These are called the *distribution coefficients* or the red, green, and blue factors. They represent the tristimulus values for each chosen wavelength. The distribution coefficients for the visible spectrum are presented in Figure 6-5. The values of \bar{y} correspond with the luminosity curve of the standard observer (Figure 6-2). The distribution coefficients are dimensionless because they are the numbers by which radiation energy at each wavelength must be multiplied to arrive at the X ,

Y , and Z content. The amounts of X , Y , and Z primaries required to produce a given color are calculated as follows:

$$X = \int_{380}^{780} \bar{x} IRdh$$

$$Y = \int_{380}^{780} \bar{y} IRdh$$

$$Z = \int_{380}^{780} \bar{z} IRdh$$

where

I = spectral energy distribution of illuminant

R = spectral reflectance of sample

dh = small wavelength interval

\bar{x} , \bar{y} , \bar{z} = red, green, and blue factors

The ratios of the primaries can be expressed as

$$x = \frac{X}{X+Y+Z}$$

$$y = \frac{Y}{X+Y+Z}$$

$$z = \frac{Z}{X+Y+Z}$$

The quantities x and y are called the chromaticity coordinates and can be calculated for each wavelength from

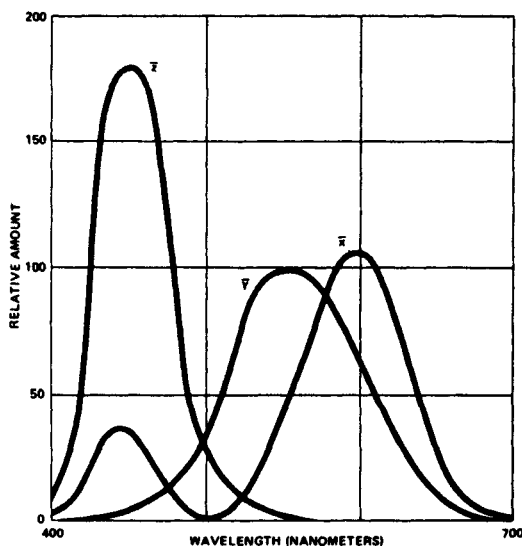

Figure 6-5 Distribution Coefficients \bar{x} , \bar{y} , and \bar{z} for the Visible Spectrum. *Source:* From Hunter Associates Lab., Inc.

$$x = \bar{x}/(\bar{x} + \bar{y} + \bar{z})$$

$$y = \bar{y}/(\bar{x} + \bar{y} + \bar{z})$$

$$z = 1 - (x + y)$$

A plot of x versus y results in the CIE chromaticity diagram (Figure 6-6). When the chromaticities of all of the spectral colors are placed in this graph, they form a line called the locus. Within this locus and the line connecting the ends, represented by 400 and 700 nm, every point represents a color that can be made by mixing the three primaries. The point at which exactly equal amounts of each

of the primaries are present is called the equal point and is white. This white point represents the chromaticity coordinates of illuminant C. The red primary is located at $x = 1$ and $y = 0$; the green primary at $x = 0$ and $y = 1$; and the blue primary at $x = 0$ and $y = 0$. The line connecting the ends of the locus represents purples, which are nonspectral colors resulting from mixing various amounts of red and blue. All points within the locus represent real colors. All points outside the locus are unreal, including the imaginary primaries X, Y, and Z. At the red end of the locus, there is only one point to represent the wavelength interval of 700 to 780 nm. This

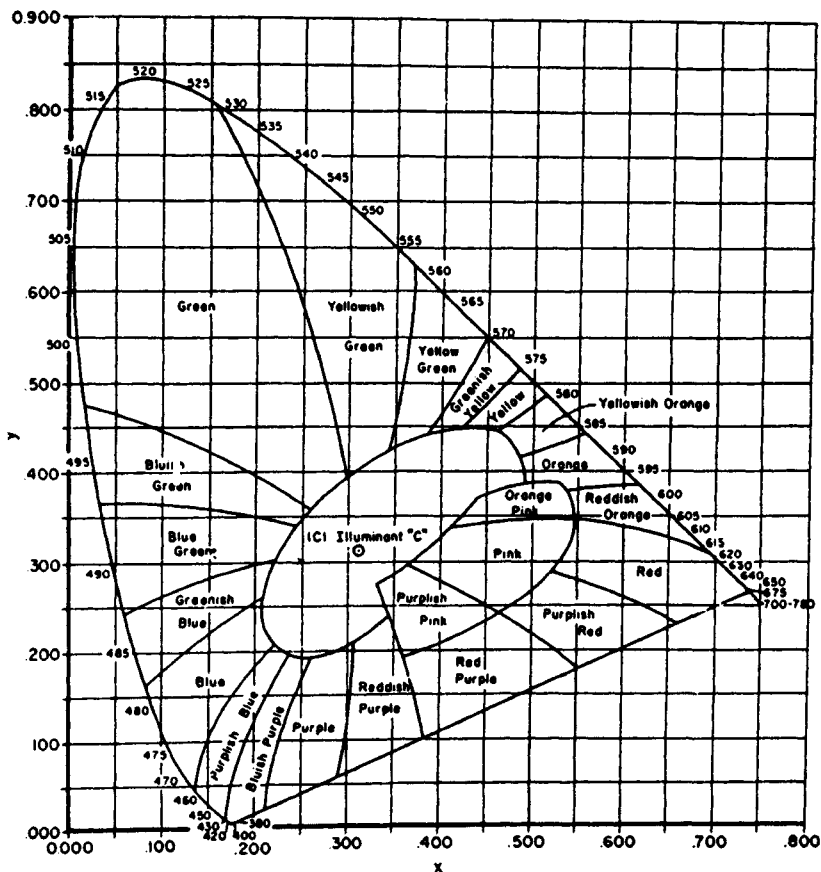

Figure 6-6 CIE Chromaticity Diagram

means that all colors in this range can be simply matched by adjustment of luminosity. In the range of 540 to 700 nm, the spectrum locus is almost straight; mixtures of two spectral light types along this line segment will closely match intervening colors with little loss of purity. In contrast, the spectrum locus below 540 nm is curved, indicating that a combination of two spectral lights along this portion of the locus results in colors of decreased purity.

A pure spectral color is gradually diluted with white when moving from a point on the spectrum locus to the white point *P*. Such a straight line with purity decreasing from 100 to 0 percent is known as a line of constant dominant wavelength. Each color, except the purples, has a dominant wavelength. The position of a color on the line connecting the locus and *P* is called excitation purity (p_e) and is calculated as follows:

$$P_e = \frac{x - x_w}{x_p - x_w} = \frac{y - y_w}{y_p - y_w}$$

where

x and y are the chromaticity coordinates of a color

x_w and y_w are the chromaticity coordinates of the achromatic source

x_p and y_p are the chromaticity coordinates of the pure spectral color

Achromatic colors are white, black, and gray. Black and gray differ from white only in their relative reflection of incident light. The purples are nonspectral chromatic colors. All other colors are chromatic; for example, brown is a yellow of low lightness and low saturation. It has a dominant wavelength in the yellow or orange range.

A color can be specified in terms of the tristimulus value Y and the chromaticity coor-

dinate x and y . The Y value is a measure of luminous reflectance or transmittance and is expressed in percent simply as $Y/1000$.

Another method of expressing color is in terms of luminance, dominant wavelength, and excitation purity. These latter are roughly equivalent to the three recognizable attributes of color: lightness, hue, and saturation. Lightness is associated with the relative luminous flux, reflected or transmitted. Hue is associated with the sense of redness, yellowness, blueness, and so forth. Saturation is associated with the strength of hue or the relative admixture with white. The combination of hue and saturation can be described as chromaticity.

Complementary colors (Table 6-1) are obtained when a straight line is drawn through the equal energy point *P*. When this is done for the ends of the spectrum locus, the wavelength complementary to the 700 to 780 point is at 492.5 nm, and for the 380 to 410 point is at 567 nm. All of the wavelengths between 492.5 and 567 nm are complementary to purple. The purples can be described in terms of dominant wavelength by using the wavelength complementary to each purple, and purity can be expressed in a manner similar to that of spectral colors.

Table 6-1 Complementary Colors

Wavelength (nm)	Color	Complementary Color
400	Violet	Yellow
450	Blue	Orange
500	Green	Red
550	Yellow	Violet
600	Orange	Blue
650	Red	Green
700		

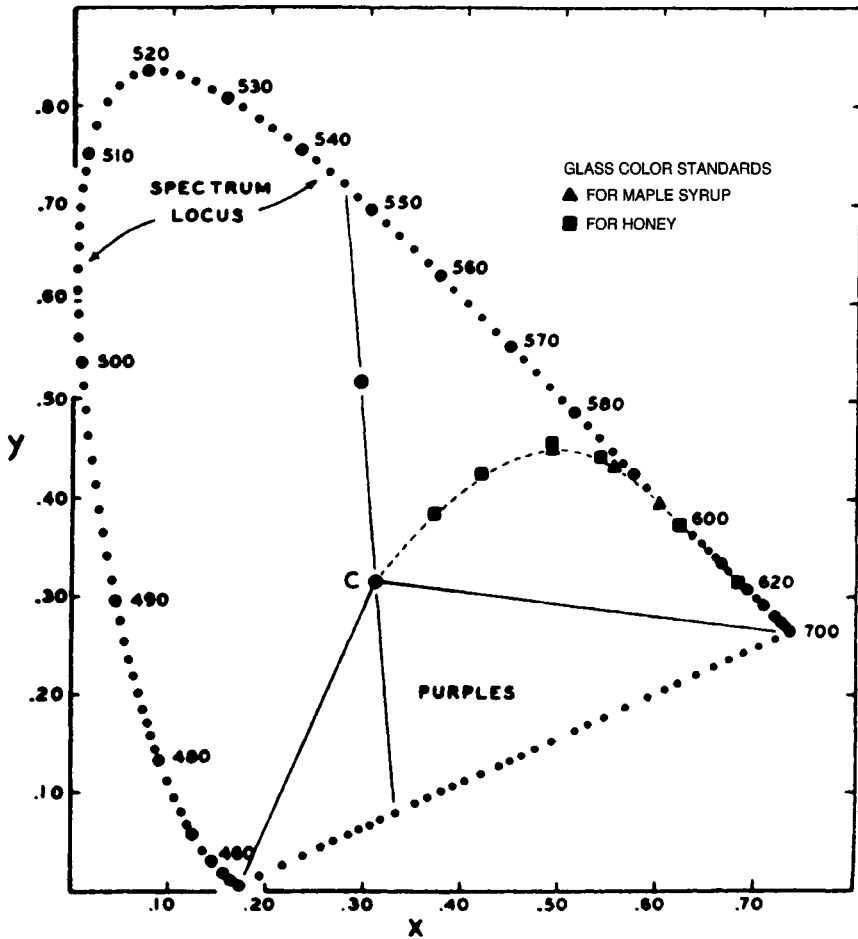

Figure 6-7 CIE Chromaticity Diagram with Color Points for Maple Syrup and Honey Glass Color Standards

An example of the application of the CIE system for color description is shown in Figure 6-7. The curved, dotted line originating from C represents the locus of the chromaticity coordinates of caramel and glycerol solutions. The chromaticity coordinates of maple syrup and honey follow the same locus. Three triangles on this curve represent the chromaticity coordinates of U.S. Department of Agriculture (USDA) glass color standards for

maple syrup. These are described as light amber, medium amber, and dark amber. The six squares are chromaticity coordinates of honey, designated by USDA as water white, extra white, white, extra light amber, light amber, and amber. Such specifications are useful in describing color standards for a variety of products. In the case of the light amber standard for maple syrup, the following values apply: $x = 0.486$, $y = 0.447$, and $T = 38.9$ per-

cent. In this way, x and y provide a specification for chromaticity and T for luminous transmittance or lightness. This is easily expressed as the mixture of primaries under illuminant C as follows: 48.6 percent of red primary, 44.7 percent of green primary, and 6.7 percent of blue primary. The light transmittance is 38.9 percent.

The importance of the light source and other conditions that affect viewing of samples cannot be overemphasized. Many substances are metameric; that is, they may have equal transmittance or reflectance at a certain wavelength but possess noticeably different colors when viewed under illuminant C .

MUNSELL SYSTEM

In the Munsell system of color classification, all colors are described by the three attributes of hue, value, and chroma. This can be envisaged as a three-dimensional system (Figure 6-8). The hue scale is based on ten hues which are distributed on the circumference of the hue circle. There are five hues: red, yellow, green, blue, and purple; they are written as R, Y, G, B, and P. There are also five intermediate hues, YR, GY, BG, PB, and RP. Each of the ten hues is at the midpoint of a scale from 1 to 10. The value scale is a lightness scale ranging from 0 (black) to 10 (white). This scale is distributed on a line perpendicular to the plane of the hue circle and intersecting its center. Chroma is a measure of the difference of a color from a gray of same lightness. It is a measure of purity. The chroma scale is of irregular length, and begins with 0 for the central gray. The scale extends outward in steps to the limit of purity obtainable by available pigments. The shape of the complete Munsell color space is indicated in Figure 6-9. The description of a color in the Munsell system is given as $H, V/C$. For example, a color indicated as 5R

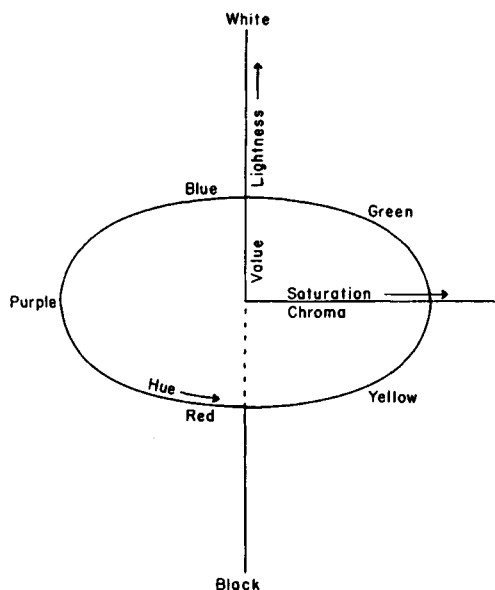

Figure 6-8 The Munsell System of Color Classification

2.8/3.7 means a color with a red hue of 5R, a value of 2.8, and a chroma of 3.7. All colors that can be made with available pigments are laid down as color chips in the Munsell book of color.

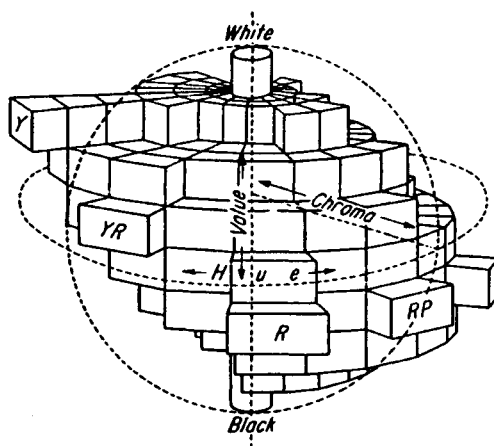

Figure 6-9 The Munsell Color Space

HUNTER SYSTEM

The CIE system of color measurement is based on the principle of color sensing by the human eye. This accepts that the eyes contain three light-sensitive receptors—the red, green, and blue receptors. One problem with this system is that the X , Y , and Z values have no relationship to color as perceived, though a color is completely defined. To overcome this problem, other color systems have been suggested. One of these, widely used for food colorimetry, is the Hunter L , a , b , system. The so-called uniform-color, opponent-colors color scales are based on the opponent-colors theory of color vision. In this theory, it is assumed that there is an intermediate signal-switching stage between the light receptors in the retina and the optic nerve, which transmits color signals to the brain. In this switching mechanism, red responses are compared with green and result in a red-to-green color dimension. The green response is compared with blue to give a yellow-to-blue color dimension. These two color dimensions are

represented by the symbols a and b . The third color dimension is lightness L , which is non-linear and usually indicated as the square or cube root of Y . This system can be represented by the color space shown in Figure 6–10. The L , a , b , color solid is similar to the Munsell color space. The lightness scale is common to both. The chromatic spacing is different. In the Munsell system, there are the polar hue and chroma coordinates, whereas in the L , a , b , color space, chromaticity is defined by rectangular a and b coordinates. CIE values can be converted to color values by the equations shown in Table 6–2 into L , a , b , values and vice versa (MacKinney and Little 1962; Clydesdale and Francis 1970). This is not the case with Munsell values. These are obtained from visual comparison with color chips (called Munsell rennotations) or from instrumental measurements (called Munsell rennotations), and conversion is difficult and tedious.

The Hunter tristimulus data, L (value), a (redness or greenness), and b (yellowness or blueness), can be converted to a single color

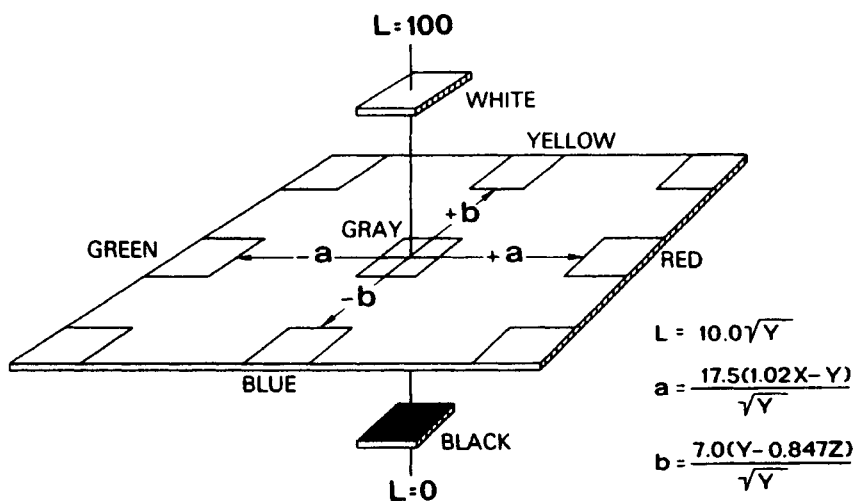

Figure 6–10 The Hunter L , a , b Color Space. Source: From Hunter Associates Lab., Inc.

Table 6-2 Mathematical Relationship Between Color Scales

To Convert	To L, a, b	To X%, Y, Z%	To Y, x, y
From X%, Y, Z%	$L = 10\sqrt{Y}$ $a = \frac{17.5(X\% - Y)}{\sqrt{Y}}$ $b = \frac{7.0(Y - Z\%)}{\sqrt{Y}}$		$Y = Y\%$ $x = \frac{X}{X + Y + Z}$ $y = \frac{Y}{X + Y + Z}$
From L, a, b		$Y = 0.01L^2$ $X\% = 0.01L^2 + \frac{aL}{175}$ $Z\% = 0.01L^2 - \frac{bL}{70}$	$Y = 0.01L^2$ $x = \frac{a + 1.75L}{5.645L + a - 3.012b}$ $y = \frac{1.786L}{5.645L + a - 3.012b}$
From Y, x, y	$L = 10\sqrt{Y}$ $a = 17.5\sqrt{Y} \frac{1.02x}{y} - 1$ $b = 5.929\sqrt{Y} \frac{2.181y + x - 1}{y}$	$X\% = 1.02 \times \frac{Y}{y}$ $Z\% = .847 [1 - (x + y)] \frac{Y}{y}$	

Source: From Hunter Associates Lab., Inc.

function called color difference (ΔE) by using the following relationship:

$$\Delta E = (\Delta L)^2 + (\Delta a)^2 + (\Delta b)^2$$

The color difference is a measure of the distance in color space between two colors. It does not indicate the direction in which the colors differ.

LOVIBOND SYSTEM

The Lovibond system is widely used for the determination of the color of vegetable oils. The method involves the visual comparison of light transmitted through a glass

cuvette filled with oil at one side of an inspection field; at the other side, colored glass filters are placed between the light source and the observer. When the colors on each side of the field are matched, the nominal value of the filters is used to define the color of the oil. Four series of filters are used—red, yellow, blue, and gray filters. The gray filters are used to compensate for intensity when measuring samples with intense chroma (color purity) and are used in the light path going through the sample. The red, yellow, and blue filters of increasing intensity are placed in the light path until a match with the sample is obtained. Vegetable oil colors are usually expressed in terms of red

and yellow; a typical example of the Lovibond color of an oil would be R1.7 Y17. The visual determination of oil color by the Lovibond method is widely used in industry and is an official method of the American Oil Chemists' Society. Visual methods of this type are subject to a number of errors, and the results obtained are highly variable. A study has been reported (Maes et al., 1997) to calculate CIE and Lovibond color values of oils based on their visible light transmission spectra as measured by a spectrophotometer. A computer software has been developed that can easily convert light transmission spectra into CIE and Lovibond color indexes.

GLOSS

In addition to color, there is another important aspect of appearance, namely gloss. Gloss can be characterized as the reflecting property of a material. Reflection of light can be diffused or undiffused (specular). In specular reflection, the surface of the object acts as a mirror, and the light is reflected in a highly directional manner. Surfaces can range from a perfect mirror with completely specular reflection to a surface reflecting in a completely diffuse manner. In the latter, the light from an incident beam is scattered in all directions and the surface is called matte.

FOOD COLORANTS

The colors of foods are the result of natural pigments or of added colorants. The natural pigments are a group of substances present in animal and vegetable products. The added colorants are regulated as food additives, but some of the synthetic colors, especially carotenoids, are considered "nature identical"

and therefore are not subject to stringent toxicological evaluation as are other additives (Dziezak 1987).

The naturally occurring pigments embrace those already present in foods as well as those that are formed on heating, storage, or processing. With few exceptions, these pigments can be divided into the following four groups:

1. tetrapyrrole compounds: chlorophylls, hemes, and bilins
2. isoprenoid derivatives: carotenoids
3. benzopyran derivatives: anthocyanins and flavonoids
4. artefacts: melanoidins, caramels

The chlorophylls are characteristic of green vegetables and leaves. The heme pigments are found in meat and fish. The carotenoids are a large group of compounds that are widely distributed in animal and vegetable products; they are found in fish and crustaceans, vegetables and fruits, eggs, dairy products, and cereals. Anthocyanins and flavonoids are found in root vegetables and fruits such as berries and grapes. Caramels and melanoidins are found in syrups and cereal products, especially if these products have been subjected to heat treatment.

Tetrapyrrole Pigments

The basic unit from which the tetrapyrrole pigments are derived is pyrrole.

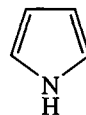

The basic structure of the heme pigments consists of four pyrrole units joined together into a porphyrin ring as shown in Figure 6-11.

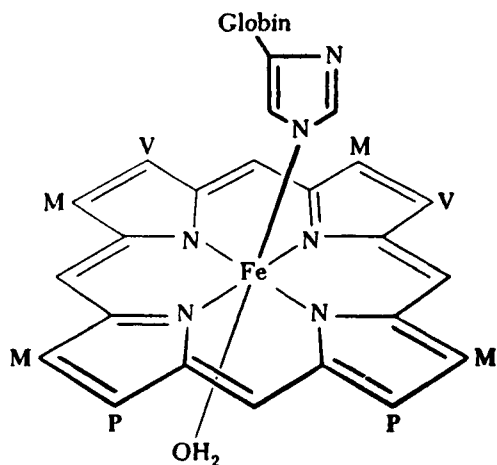
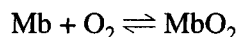

Figure 6-11 Schematic Representation of the Heme Complex of Myoglobin. M = methyl, P = propyl, V = vinyl. *Source:* From C.E. Bodwell and P.E. McClain, *Proteins, in The Sciences of Meat Products*, 2nd ed., J.E. Price and B.S. Schweigert, eds., 1971, W.H. Freeman & Co.

In the heme pigments, the nitrogen atoms are linked to a central iron atom. The color of meat is the result of the presence of two pigments, myoglobin and hemoglobin. Both pigments have globin as the protein portion, and the heme group is composed of the porphyrin ring system and the central iron atom. In myoglobin, the protein portion has a molecular weight of about 17,000. In hemoglobin, this is about 67,000—equivalent to four times the size of the myoglobin protein. The central iron in Figure 6-11 has six coordination bonds; each bond represents an electron pair accepted by the iron from five nitrogen atoms, four from the porphyrin ring and one from a histidyl residue of the globin. The sixth bond is available for joining with any atom that has an electron pair to donate. The ease with which an electron pair is donated determines the nature of the bond formed and the color of the complex. Other

factors playing a role in color formation are the oxidation state of the iron atom and the physical state of the globin.

In fresh meat and in the presence of oxygen, there is a dynamic system of three pigments, oxymyoglobin, myoglobin, and metmyoglobin. The reversible reaction with oxygen is



In both pigments, the iron is in the ferrous form; upon oxidation to the ferric state, the compound becomes metmyoglobin. The bright red color of fresh meat is due to the presence of oxymyoglobin; discoloration to brown occurs in two stages, as follows:

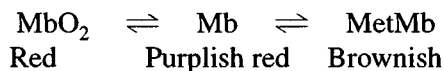

Oxymyoglobin represents a ferrous covalent complex of myoglobin and oxygen. The absorption spectra of the three pigments are shown in Figure 6-12 (Bodwell and McClain 1971). Myoglobin forms an ionic complex with water in the absence of strong electron pair donors that can form covalent complexes. It shows a diffuse absorption band in the green area of the spectrum at about 555 nm and has a purple color. In metmyoglobin, the major absorption peak is shifted toward the blue portion of the spectrum at about 505 nm with a smaller peak at 627 nm. The compound appears brown.

As indicated above, oxymyoglobin and myoglobin exist in a state of equilibrium with oxygen; therefore, the ratio of the pigments is dependent on oxygen pressure. The oxidized form of myoglobin, the metmyoglobin, cannot bind oxygen. In meat, there is a slow and continuous oxidation of the heme

pigments to the metmyoglobin state. Reducing substances in the tissue reduce the metmyoglobin to the ferrous form. The oxygen pressure, which is so important for the state of the equilibrium, is greatly affected by packaging materials used for meats. The maximum rate of conversion to metmyoglobin occurs at partial pressures of 1 to 20 nm of mercury, depending on pigment, pH, and temperature (Fox 1966). When a packaging film with low oxygen permeability is used, the oxygen pressure drops to the point where oxidation is favored. To prevent this, Landrock and Wallace (1955) established that oxygen permeability of the packaging film must be at least 5 liters of oxygen/square meter/day/atm.

Fresh meat open to the air displays the bright red color of oxymyoglobin on the surface. In the interior, the myoglobin is in the reduced state and the meat has a dark purple color. As long as reducing substances are present in the meat, the myoglobin will remain in the reduced form; when they are used up, the brown color of metmyoglobin will predominate. According to Solberg (1970), there is a thin layer a few nanometers below the bright red surface and just before the myoglobin region, where a definite brown color is visible. This is the area where the oxygen partial pressure is about 1.4 nm and the brown pigment dominates. The growth of bacteria at the meat surface may reduce the partial oxygen pressure to

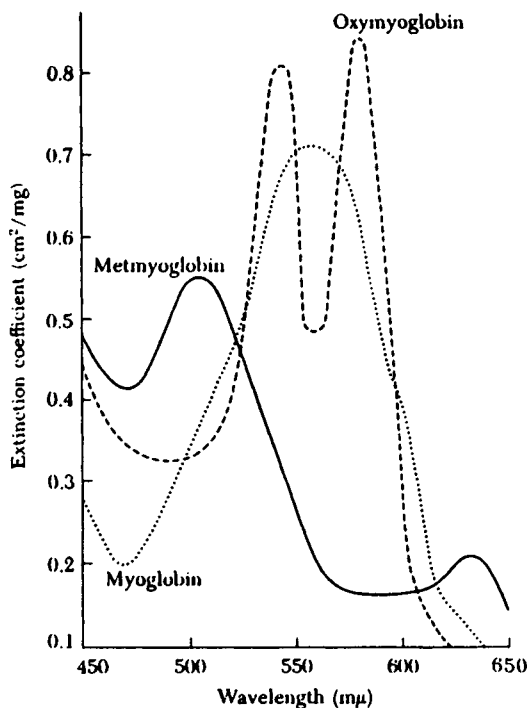

Figure 6-12 Absorption Spectra of Myoglobin, Oxymyoglobin, and Metmyoglobin. *Source:* From C.E. Bodwell and P.E. McClain, Proteins, in *The Sciences of Meat Products*, 2nd ed., J.E. Price and B.S. Schweigert, eds., 1971, W.H. Freeman & Co.

below the critical level of 4 nm. Microorganisms entering the logarithmic growth phase may change the surface color to that of the purplish-red myoglobin (Solberg 1968).

In the presence of sulfhydryl as a reducing agent, myoglobin may form a green pigment, called sulfmyoglobin. The pigment is green because of a strong absorption band in the red region of the spectrum at 616 nm. In the presence of other reducing agents, such as ascorbate, cholemyoglobin is formed. In this pigment, the porphyrin ring is oxidized. The conversion into sulfmyoglobin is reversible; cholemyoglobin formation is irreversible, and this compound is rapidly oxidized to yield globin, iron, and tetrapyrrole. According to Fox (1966), this reaction may happen in the pH range of 5 to 7.

Heating of meat results in the formation of a number of pigments. The globin is denatured. In addition, the iron is oxidized to the ferric state. The pigment of cooked meat is brown and called hemichrome. In the presence of reducing substances such as those that occur in the interior of cooked meat, the iron may be reduced to the ferrous form; the resulting pigment is pink hemochrome.

In the curing of meat, the heme reacts with nitrite of the curing mixture. The nitrite-heme complex is called nitrosomyoglobin, which has a red color but is not particularly stable. On heating the more stable nitrosohemochrome, the major cured meat pigment is formed, and the globin portion of the molecule is denatured. This requires a temperature of 65°C. This molecule has been called nitrosomyoglobin and nitrosylmyoglobin, but Möhler (1974) has pointed out that the only correct name is nitric oxide myoglobin. The first reaction of nitrite with myoglobin is oxidation of the ferrous iron to the ferric form and formation of MetMb. At the same

time, nitrate is formed according to the following reaction (Möhler 1974):

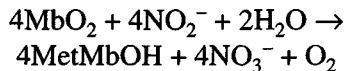

During the formation of the curing pigment, the nitrite content is gradually lowered; there are no definite theories to account for this loss.

The reactions of the heme pigments in meat and meat products have been summarized in the scheme presented in Figure 6-13 (Fox 1966). Bilin-type structures are formed when the porphyrin ring system is broken.

Chlorophylls

The chlorophylls are green pigments responsible for the color of leafy vegetables and some fruits. In green leaves, the chlorophyll is broken down during senescence and the green color tends to disappear. In many fruits, chlorophyll is present in the unripe state and gradually disappears as the yellow and red carotenoids take over during ripening. In plants, chlorophyll is isolated in the chloroplastids. These are microscopic particles consisting of even smaller units, called grana, which are usually less than one micrometer in size and at the limit of resolution of the light microscope. The grana are highly structured and contain laminae between which the chlorophyll molecules are positioned.

The chlorophylls are tetrapyrrole pigments in which the porphyrin ring is in the dihydro form and the central metal atom is magnesium. There are two chlorophylls, *a* and *b*, which occur together in a ratio of about 1:25. Chlorophyll *b* differs from chlorophyll *a* in that the methyl group on carbon 3 is replaced with an aldehyde group. The structural for-

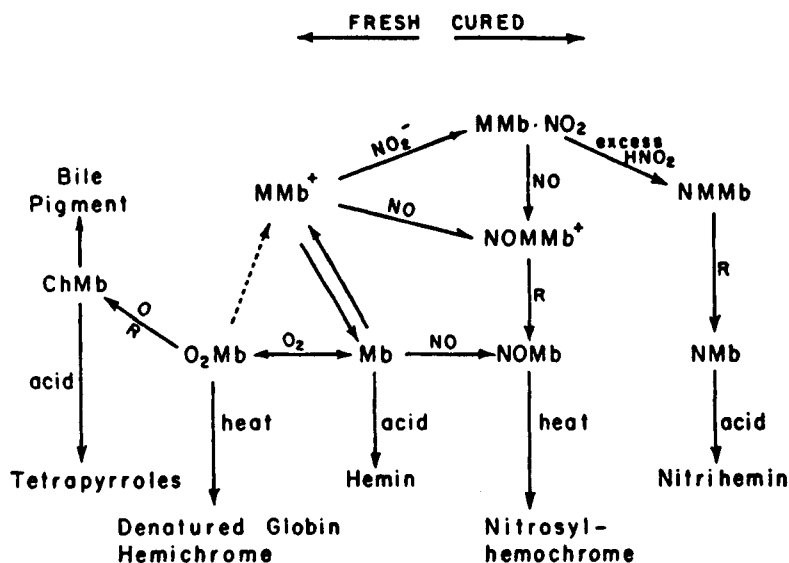

Figure 6-13 Heme Pigment Reactions in Meat and Meat Products. ChMb, cholemyoglobin (oxidized porphyrin ring); O₂Mb, oxymyoglobin (Fe²⁺); MMb metmyoglobin (Fe³⁺); Mb, myoglobin (Fe²⁺); MMb·NO₂, metmyoglobin nitrate; NOMMb, nitrosylmetmyoglobin; NOMb, nitrosylmyoglobin; NMMb, nitrimetmyoglobin; NMb, nitrimyoglobin, the latter two being reaction products of nitrous acid and the heme portion of the molecule; R, reductants; O, strong oxidizing conditions. *Source:* From J.B. Fox, *The Chemistry of Meat Pigments*, *J. Agr. Food Chem.*, Vol. 14, no. 3, pp. 207-210, 1966, American Chemical Society.

mula of chlorophyll *a* is given in Figure 6-14. Chlorophyll is a diester of a dicarboxylic acid (chlorophyllin); one group is esterified with methanol, the other with phytol alcohol. The magnesium is removed very easily by acids, giving pheophytins *a* and *b*. The action of acid is especially important for fruits that are naturally high in acid. However, it appears that the chlorophyll in plant tissues is bound to lipoproteins and is protected from the effect of acid. Heating coagulates the protein and lowers the protective effect. The color of the pheophytins is olive-brown. Chlorophyll is stable in alkaline medium. The phytol chain confers insolubility in water on the chlorophyll molecule. Upon hydrolysis of the phytol group, the water-sol-

uble methyl chlorophyllides are formed. This reaction can be catalyzed by the enzyme chlorophyllase. In the presence of copper or zinc ions, it is possible to replace the magnesium, and the resulting zinc or copper complexes are very stable. Removal of the phytol group and the magnesium results in pheophorbides. All of these reactions are summarized in the scheme presented in Figure 6-15.

In addition to those reactions described above, it appears that chlorophyll can be degraded by yet another pathway. Chichester and McFeeters (1971) reported on chlorophyll degradation in frozen beans, which they related to fat peroxidation. In this reaction, lipoxidase may play a role, and no

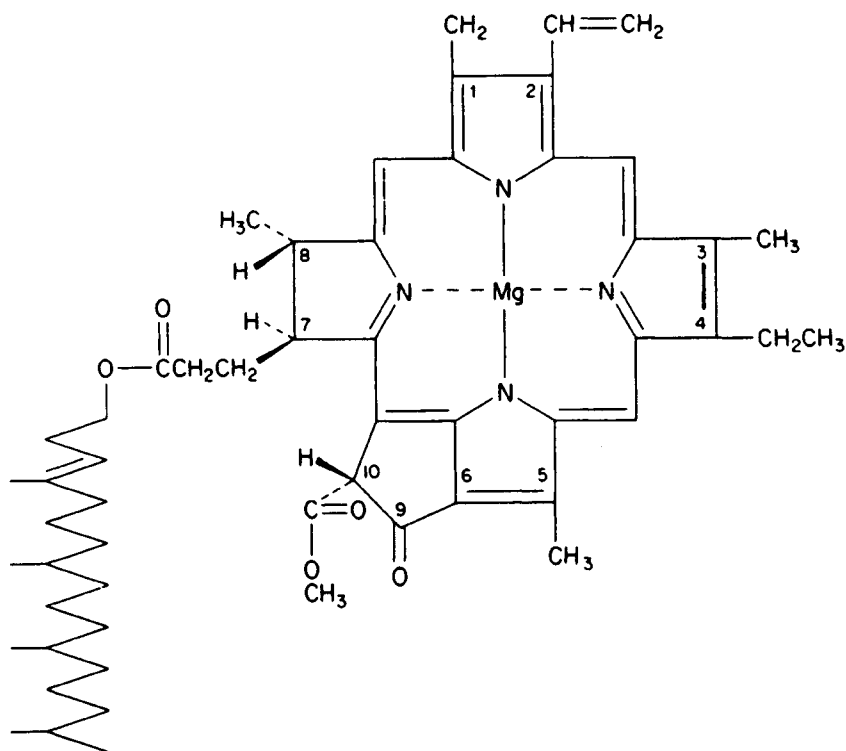

Figure 6-14 Structure of Chlorophyll *a*. (Chlorophyll *b* differs in having a formyl group at carbon 3).
Source: Reprinted with permission from J.R. Whitaker, *Principles of Enzymology for the Food Sciences*, 1972, by courtesy of Marcel Dekker, Inc.

pheophytins, chlorophyllides, or pheophorbides are detected. The reaction requires oxygen and is inhibited by antioxidants.

Carotenoids

The naturally occurring carotenoids, with the exception of crocetin and bixin, are tetraterpenoids. They have a basic structure of eight isoprenoid residues arranged as if two 20-carbon units, formed by head-to-tail condensation of four isoprenoid units, had joined tail to tail. There are two possible ways of classifying the carotenoids. The first system recognizes two main classes, the car-

otenes, which are hydrocarbons, and the xanthophylls, which contain oxygen in the form of hydroxyl, methoxyl, carboxyl, keto, or epoxy groups. The second system divides the carotenoids into three types (Figure 6-16), acyclic, monocyclic, and bicyclic. Examples are lycopene (I)—acyclic, γ -carotene (II)—monocyclic, and α -carotene (III) and β -carotene (IV)—bicyclic.

The carotenoids take their name from the major pigments of carrot (*Daucus carota*). The color is the result of the presence of a system of conjugated double bonds. The greater the number of conjugated double bonds present in the molecule, the further the major absorption bands will be shifted to the

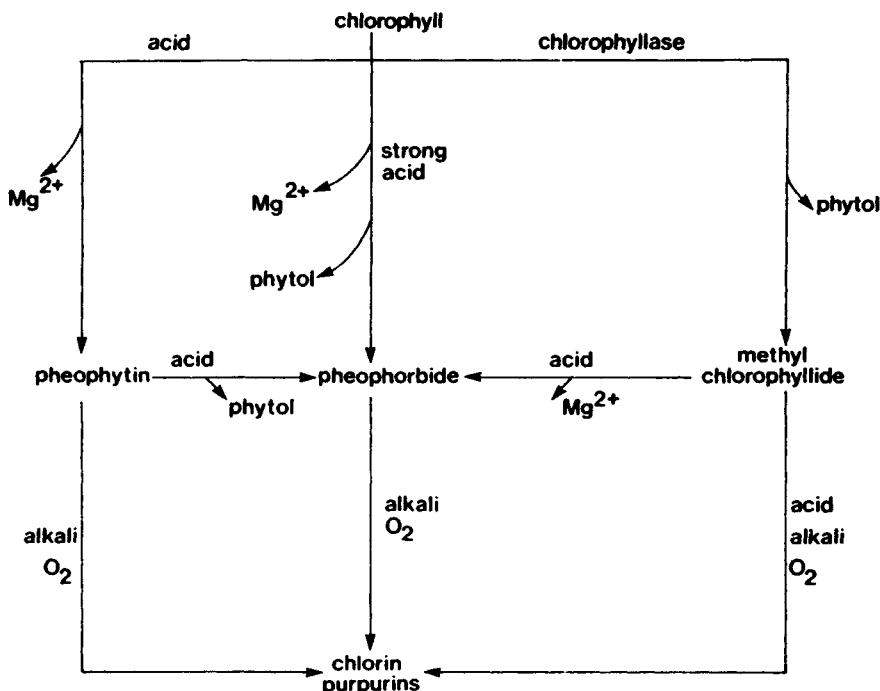

Figure 6-15 Reactions of Chlorophylls

region of longer wavelength; as a result, the hue will become more red. A minimum of seven conjugated double bonds are required before a perceptible yellow color appears. Each double bond may occur in either *cis* or *trans* configuration. The carotenoids in foods are usually of the all-*trans* type and only occasionally a mono-*cis* or di-*cis* compound occurs. The prefix *neo-* is used for stereoisomers with at least one *cis* double bond. The prefix *pro-* is for poly-*cis* carotenoids. The effect of the presence of *cis* double bonds on the absorption spectrum of β -carotene is shown in Figure 6-17. The configuration has an effect on color. The all-*trans* compounds have the deepest color; increasing numbers of *cis* bonds result in gradual lightening of the color. Factors that cause change of bonds from *trans* to *cis* are light, heat, and acid.

In the narrower sense, the carotenoids are the four compounds shown in Figure 6-16— α -, β -, and γ -carotene and lycopene—polyene hydrocarbons of overall composition $C_{40}H_{56}$. The relation between these and carotenoids with fewer than 40 carbon atoms is shown in Figure 6-18. The prefix *apo-* is used to designate a carotenoid that is derived from another one by loss of a structural element through degradation. It has been suggested that some of these smaller carotenoid molecules are formed in nature by oxidative degradation of C_{40} carotenoids (Grob 1963).

Several examples of this possible relationship are found in nature. One of the best known is the formation of retinoin and vitamin A from β -carotene (Figure 6-19). Another obvious relationship is that of lycopene and bixin (Figure 6-20). Bixin is a food

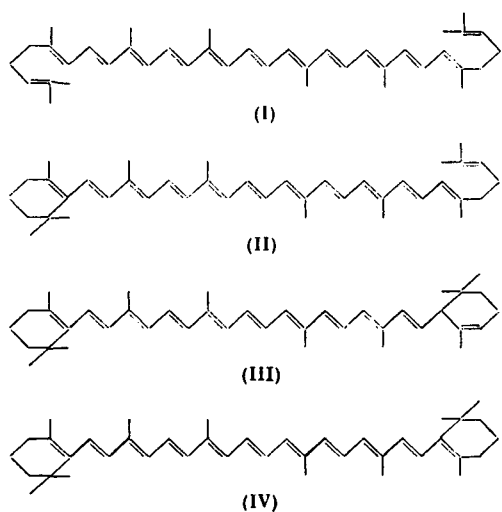

Figure 6-16 The Carotenoids: (I) Lycopene, (II) γ -carotene, (III) α -Carotene, and (IV) β -Carotene. Source: From E.C. Grob, *The Biogenesis of Carotenes and Carotenoids*, in *Carotenes and Carotenoids*, K. Lang, ed., 1963, Steinkopff Verlag.

color additive obtained from the seed coat of the fruit of a tropical brush, *Bixa orellana*. The pigment bixin is a dicarboxylic acid esterified with one methanol molecule. A pigment named crocin has been isolated from saffron. Crocin is a glycoside containing two molecules of gentiobiose. When these are removed, the dicarboxylic acid crocetin is formed (Figure 6-21). It has the same general structure as the aliphatic chain of the carotenes. Also obtained from saffron is the bitter compound picrocrocin. It is a glycoside and, after removal of the glucose, yields saffronal. It is possible to imagine a combination of two molecules of picrocrocin and one of crocin; this would yield protocrocin. Protocrocin, which is directly related to zeaxanthin, has been found in saffron (Grob 1963).

The structure of a number of important xanthophylls as they relate to the structure of β -carotene is given in Figure 6-22. Carotenoids may occur in foods as relatively simple mixtures of only a few compounds or as very complex mixtures of large numbers of carotenoids. The simplest mixtures usually exist in animal products because the animal organism has a limited ability to absorb and deposit carotenoids. Some of the most complex mixtures are found in citrus fruits.

Beta-carotene as determined in fruits and vegetables is used as a measure of the provitamin A content of foods. The column chromatographic procedure, which determines this content, does not separate α -carotene, β -carotene, and cryptoxanthin. Provitamin A values of some foods are given in Table 6-3. Carotenoids are not synthesized by animals, but they may change ingested carotenoids into animal carotenoids—as in, for example, salmon, eggs, and crustaceans. Usually carotenoid content of foods does not exceed 0.1 percent on a dry weight basis.

In ripening fruit, carotenoids increase at the same time chlorophylls decrease. The ratio of carotenes to xanthophylls also increases. Common carotenoids in fruits are α - and γ -carotene and lycopene. Fruit xanthophylls are usually present in esterified form. Oxygen, but not light, is required for carotenoid synthesis and the temperature range is critical. The relative amounts of different carotenoids are related to the characteristic color of some fruits. In the sequence of peach, apricot, and tomato, there is an increasing proportion of lycopene and increasing redness. Many peach varieties are devoid of lycopene. Apricots may have about 10 percent and tomatoes up to 90 percent. The lycopene content of tomatoes increases during ripening. As the chlorophyll breaks down during ripening, large amounts of carot-

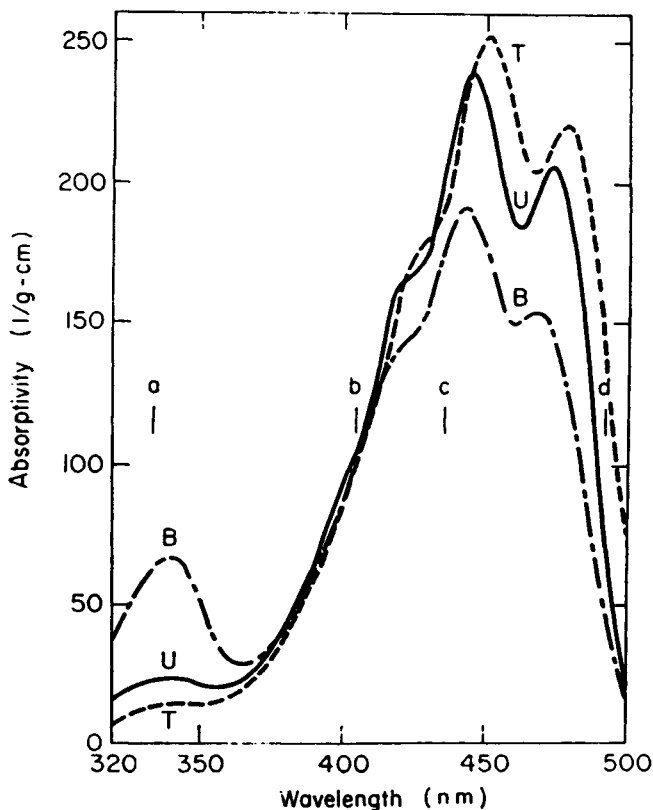

Figure 6-17 Absorption Spectra of the Three Stereoisomers of Beta Carotene. *B* = neo- β -carotene; *U* = neo- β -carotene-U; *T* = all-trans- β -carotene. *a*, *b*, *c*, and *d* indicate the location of the mercury arc lines 334.1, 404.7, 435.8 and 491.6 nm, respectively. Source: From F. Stitt et al., Spectrophotometric Determination of Beta Carotene Stereoisomers in Alfalfa, *J. Assoc. Off. Agric. Chem.* Vol. 34, pp. 460-471, 1951.

enoids are formed (Table 6-4). Color is an important attribute of citrus juice and is affected by variety, maturity, and processing methods. The carotenoid content of oranges is used as a measure of total color. Curl and Bailey (1956) showed that the 5,6-epoxides of fresh orange juice isomerize completely to 5,8-epoxides during storage of canned juice. This change amounts to the loss of one double bond from the conjugated double bond system and causes a shift in the wavelength of maximum absorption as well as a decrease

in molar absorbance. In one year's storage at 70°F, an apparent carotenoid loss of 20 to 30 percent occurs.

Peaches contain violaxanthin, cryptoxanthin, β -carotene, and persicaxanthin as well as 25 other carotenoids, including neoxanthin. Apricots contain mainly β - and γ -carotene, lycopene, and little if any xanthophyll. Carrots have been found to have an average of 54 ppm of total carotene (Borenstein and Bunnell 1967), consisting mainly of α -, β , and ζ -carotene and some lycopene and xan-

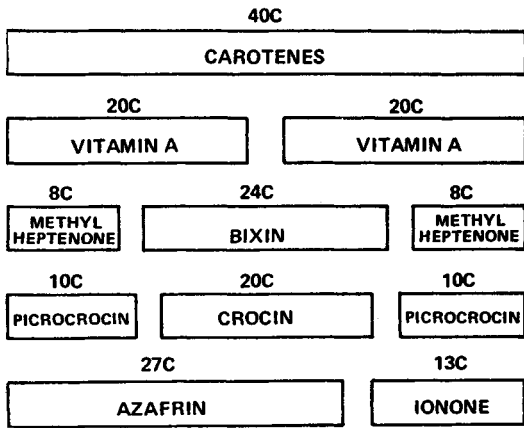

Figure 6-18 Relationship Between the Carotene and Carotenoids with Fewer than 40 Carbons

thophyll. Canning of carrots resulted in a 7 to 12 percent loss of provitamin A activity because of *cis-trans* isomerization of α - and β -carotene (Weckel et al. 1962). In dehy-

drated carrots, carotene oxidation and off-flavor development have been correlated (Falconer et al. 1964). Corn contains about one-third of the total carotenoids as carotenes and two-thirds xanthophylls. Compounds found in corn include zeaxanthin, cryptoxanthin, β -carotene, and lutein.

One of the highest known concentrations of carotenoids occurs in crude palm oil. It contains about 15 to 300 times more retinol equivalent than carrots, green leafy vegetables, and tomatoes. All of the carotenoids in crude palm oil are destroyed by the normal processing and refining operations. Recently, improved gentler processes have been developed that result in a "red palm oil" that retains most of the carotenoids. The composition of the carotenes in crude palm oil with a total carotene concentration of 673 mg/kg is shown in Table 6-5.

Milkfat contains carotenoids with seasonal variation (related to feed conditions) ranging from 2 to 13 ppm.

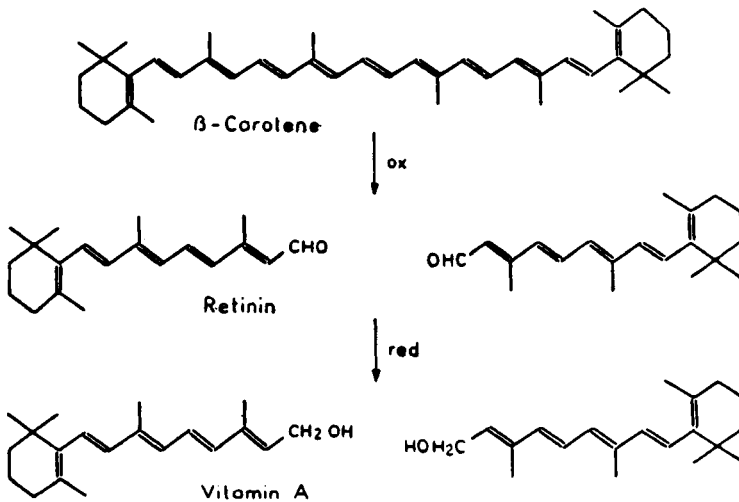

Figure 6-19 Formation of Retinin and Vitamin A from β -Carotene. *Source:* From E.C. Grob, *The Biogenesis of Carotenes and Carotenoids*, K. Lang, ed., 1963, Steinkopff Verlag.

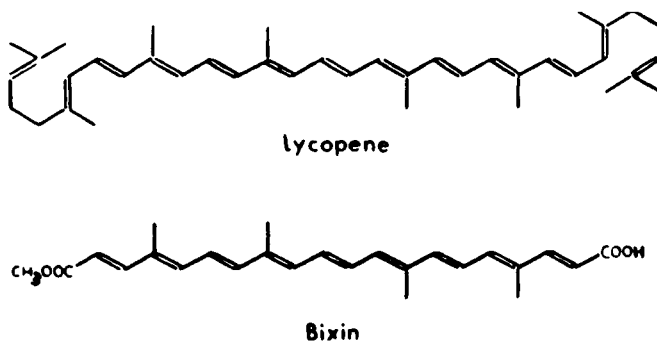

Figure 6-20 Relationship Between Lycopene and Bixin. *Source:* From E.C. Grob, *The Biogenesis of Carotenes and Carotenoids*, in *Carotenes and Carotenoids*, K. Lang, ed., 1963, Steinkopff Verlag.

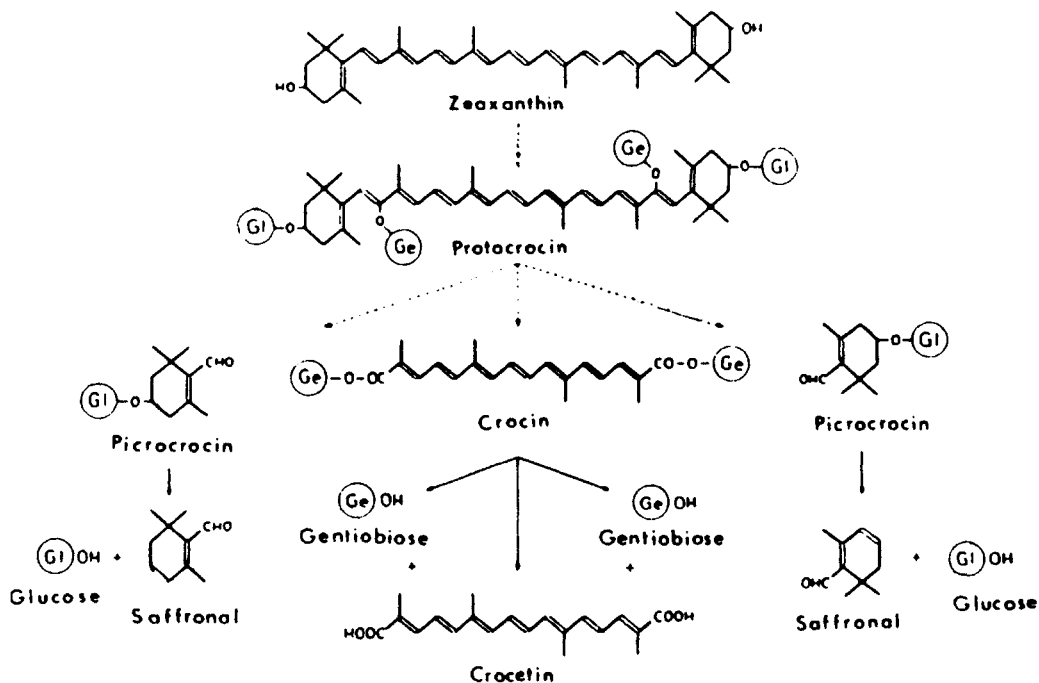

Figure 6-21 Relationship Between Crocin and Picrocrocin and the Carotenoids. *Source:* From E.C. Grob, *The Biogenesis of Carotenes and Carotenoids*, in *Carotenes and Carotenoids*, K. Lang, ed., 1963, Steinkopff Verlag.

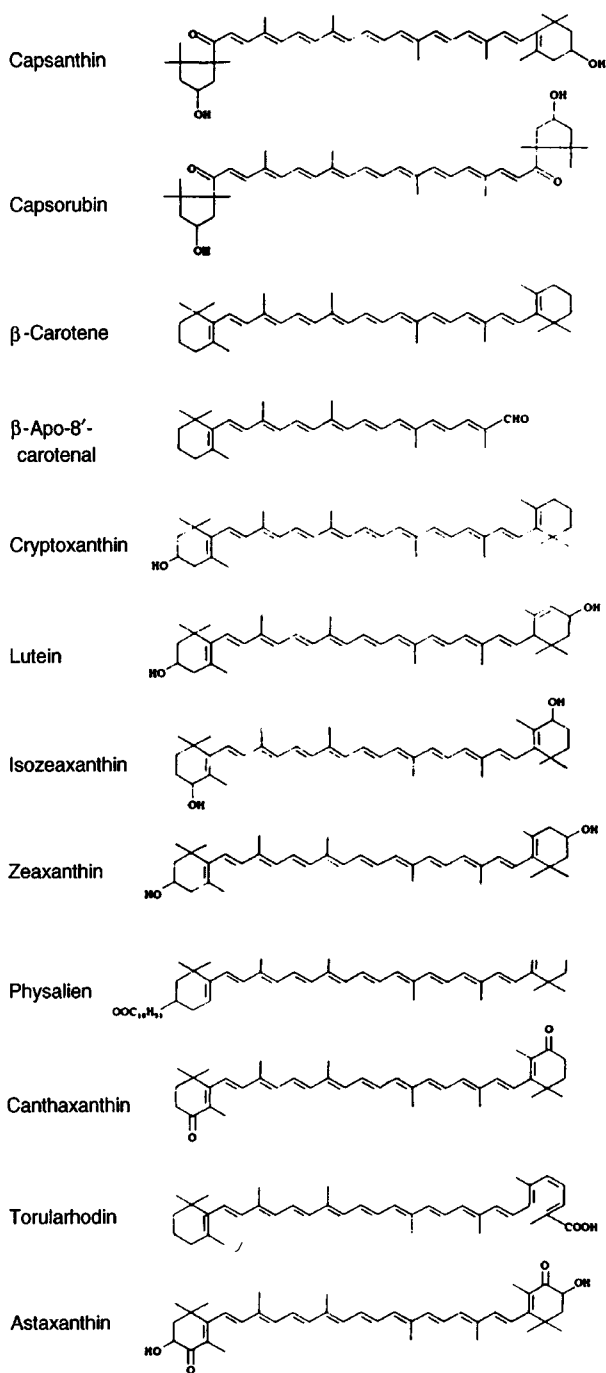

Figure 6-22 Structure of Some of the Important Carotenoids. *Source:* From B. Borenstein and R.H. Bunnell, Carotenoids: Properties, Occurrence, and Utilization in Foods, in *Advances in Food Research*, Vol. 15, C.O. Chichester et al., eds., 1967, Academic Press.

Table 6-3 Provitamin A Value of Some Fruits and Vegetables

<i>Product</i>	<i>IU/100 g</i>
Carrots, mature	20,000
Carrots, young	10,000
Spinach	13,000
Sweet potato	6,000
Broccoli	3,500
Apricots	2,000
Lettuce	2,000
Tomato	1,200
Asparagus	1,000
Bean, french	1,000
Cabbage	500
Peach	800
Brussels sprouts	700
Watermelon	550
Banana	400
Orange juice	200

Source: From B. Borenstein and R.H. Bunnell, Carotenoids: Properties, Occurrence, and Utilization in Foods, in *Advances in Food Research*, Vol. 15, C.O. Chichester et al., eds., 1967, Academic Press.

Egg yolk contains lutein, zeaxanthin, and cryptoxanthin. The total carotenoid content ranges from 3 to 89 ppm.

Crustaceans contain carotenoids bound to protein resulting in a blue or blue-gray color. When the animal is immersed in boiling water, the carotenoid-protein bond is broken and the orange-red color of the free car-

otenoid appears. Widely distributed in crustaceans is astaxanthin. Red fish contain astaxanthin, lutein, and taraxanthin.

Common unit operations of food processing are reported to have only minor effects on the carotenoids (Borenstein and Bunnell 1967). The carotenoid-protein complexes are generally more stable than the free carotenoids. Because carotenoids are highly unsaturated, oxygen and light are major factors in their breakdown. Blanching destroys enzymes that cause carotenoid destruction. Carotenoids in frozen or heat-sterilized foods are quite stable. The stability of carotenoids in dehydrated foods is poor, unless the food is packaged in inert gas. A notable exception is dried apricots, which keep their color well. Dehydrated carrots fade rapidly.

Several of the carotenoids are now commercially synthesized and used as food colors. A possible method of synthesis is described by Borenstein and Bunnell (1967). Beta-ionone is obtained from lemon grass oil and converted into a C14 aldehyde. The C14 aldehyde is changed to a C16 aldehyde, then to a C19 aldehyde. Two moles of the C19 aldehyde are condensed with acetylene dimagnesium bromide and, after a series of reactions, yield β -carotene.

Three synthetically produced carotenoids are used as food colorants, β -carotene, β -apo-8'-carotenal (apocarotenal), and canthaxanthin. Because of their high tinctorial power, they are used at levels of 1 to 25 ppm

Table 6-4 Development of Pigments in the Ripening Tomato

<i>Pigment</i>	<i>Green (mg/100 g)</i>	<i>Half-ripe (mg/100 g)</i>	<i>Ripe (mg/100 g)</i>
Lycopene	0.11	0.84	7.85
Carotene	0.16	0.43	0.73
Xanthophyll	0.02	0.03	0.06
Xanthophyll ester	0	0.02	0.10

in foods (Dziezak 1987). They are unstable in light but otherwise exhibit good stability in food applications. Although they are fat soluble, water-dispersible forms have been developed for use in a variety of foods. Beta-carotene imparts a light yellow to orange color, apocarotenal a light orange to reddish-orange, and canthaxanthin, orange-red to red. The application of these compounds in a variety of foods has been described by Counsell (1985). Natural carotenoid food colors are annatto, oleoresin of paprika, and unrefined palm oil.

Anthocyanins and Flavonoids

The anthocyanin pigments are present in the sap of plant cells; they take the form of glycosides and are responsible for the red, blue, and violet colors of many fruits and vegetables. When the sugar moiety is re-

moved by hydrolysis, the aglucone remains and is called anthocyanidin. The sugar part usually consists of one or two molecules of glucose, galactose, and rhamnose. The basic structure consists of 2-phenyl-benzopyrylium or flavylium with a number of hydroxy and methoxy substituents. Most of the anthocyanidins are derived from 3,5,7-trihydroxyflavylium chloride (Figure 6-23) and the sugar moiety is usually attached to the hydroxyl group on carbon 3. The anthocyanins are highly colored, and their names are derived from those of flowers. The structure of some of the more important anthocyanidins is shown in Figure 6-24, and the occurrence of anthocyanidins in some fruits and vegetables is listed in Table 6-6. Recent studies have indicated that some anthocyanins contain additional components such as organic acids and metals (Fe, Al, Mg).

Substitution of hydroxyl and methoxyl groups influences the color of the anthocyanins. This effect has been shown by Braverman (1963) (Figure 6-25). Increase in the number of hydroxyl groups tends to deepen the color to a more bluish shade. Increase in the number of methoxyl groups increases redness. The anthocyanins can occur in different forms. In solution, there is an equilibrium between the colored cation R^+ or oxonium salt and the colorless pseudobase ROH, which is dependent on pH.

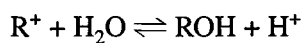

As the pH is raised, more pseudobase is formed and the color becomes weaker. However, in addition to pH, other factors influence the color of anthocyanins, including metal chelation and combination with other flavonoids and tannins.

Anthocyanidins are highly colored in strongly acid medium. They have two absorption maxima—one in the visible spec-

Table 6-5 Composition of the Carotenes in Crude Palm Oil

Carotene	% of Total Carotenes
Phytoene	1.27
Cis- β -carotene	0.68
Phytofluene	0.06
β -carotene	56.02
α -carotene	35.06
ζ -carotene	0.69
γ -carotene	0.33
δ -carotene	0.83
Neurosporene	0.29
β -zeacarotene	0.74
α -zeacarotene	0.23
Lycopene	1.30

Source: Reprinted with permission from Choo Yuen May, Carotenoids from Palm Oil, *Palm Oil Developments*, Vol. 22, pp. 1-6, Palm Oil Research Institute of Malaysia.

trum at 500–550 nm, which is responsible for the color, and a second in the ultraviolet (UV) spectrum at 280 nm. The absorption maxima relate to color. For example, the relationship in 0.01 percent HCl in methanol is as follows: at 520 nm pelargonidin is scarlet, at 535 nm cyanidin is crimson, and at 546 nm delphinidin is blue-mauve (Macheix et al. 1990).

About 16 anthocyanidins have been identified in natural products, but only the following six of these occur frequently and in many different products: pelargonidin, cyanidin, delphinidin, peonidin, malvidin, and petunidin. The anthocyanin pigments of Red Delicious apples were found to contain mostly cyanidin-3-galactoside, cyanidin-3-arabioside, and cyanidin-7-arabioside (Sun and Francis 1968). Bing cherries contain primarily cyanidin-3-rutinoside, cyanidin-3-glucoside, and small amounts of the pigments cyanidin, peonidin, peonidin-3-glucoside, and peonidin-3-ruti-

nose (Lynn and Luh 1964). Cranberry anthocyanins were identified as cyanidin-3-monogalactoside, peonidin-3-monogalactoside, cyanidin monoarabioside, and peonidin-3-monoarabioside (Zapsalis and Francis 1965). Cabernet Sauvignon grapes contain four major anthocyanins: delphinidin-3-monoglucoside, petunidin-3-monoglucoside, malvidin-3-monoglucoside, and malvidin-3-monoglucoside acetylated with chlorogenic acid. One of the major pigments is petunidin (Somaatmadja and Powers 1963).

Anthocyanin pigments can easily be destroyed when fruits and vegetables are processed. High temperature, increased sugar level, pH, and ascorbic acid can affect the rate of destruction (Daravingas and Cain 1965). These authors studied the change in anthocyanin pigments during the processing and storage of raspberries. During storage, the absorption maximum of the pigments shifted, indicating a change in color. The

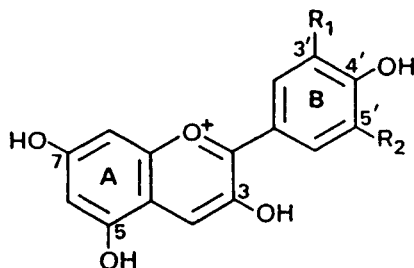

$R_1 = H$	$R_2 = H$	PELARGONIDIN
$R_1 = OH$	$R_2 = H$	CYANIDIN
$R_1 = OH$	$R_2 = OH$	DELPHINIDIN
$R_1 = OCH_3$	$R_2 = H$	PEONIDIN
$R_1 = OCH_3$	$R_2 = OH$	PETUNIDIN
$R_1 = OCH_3$	$R_2 = OCH_3$	MALVIDIN

Figure 6–23 Chemical Structure of Fruit Anthocyanidins

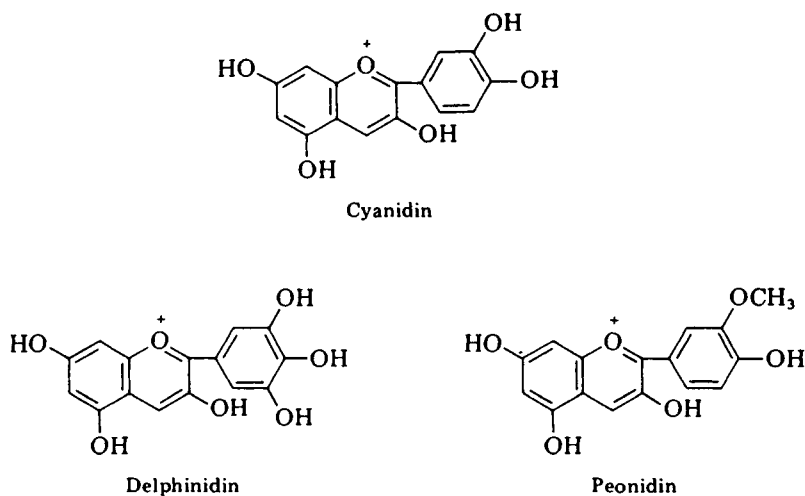

Figure 6-24 Structure of Some Important Anthocyanidins

Table 6-6 Anthocyanidins Occurring in Some Fruits and Vegetables

<i>Fruit or Vegetable</i>	<i>Anthocyanidin</i>
Apple	Cyanidin
Black currant	Cyanidin and delphinidin
Blueberry	Cyanidin, delphinidin, malvidin, petunidin, and peonidin
Cabbage (red)	Cyanidin
Cherry	Cyanidin and peonidin
Grape	Malvidin, peonidin, delphinidin, cyanidin, petunidin, and pelargonidin
Orange	Cyanidin and delphinidin
Peach	Cyanidin
Plum	Cyanidin and peonidin
Radish	Pelargonidin
Raspberry	Cyanidin
Strawberry	Pelargonidin and a little cyanidin

Source: From P. Markakis, Anthocyanins, in *Encyclopedia of Food Technology*, A.H. Johnson and M.S. Peterson, eds., 1974, AVI Publishing Co.

level of pigments was lowered by prolonged times and higher temperatures of storage. Higher concentration of the ingoing sugar syrup and the presence of oxygen resulted in greater pigment destruction.

The stability of anthocyanins is increased by acylation (Dougall et al. 1997). These acylated anthocyanins may occur naturally as in the case of an anthocyanin from the purple yam (Yoshida et al. 1991). This anthocyanin has one sinapic residue attached through a disaccharide and was found to be stable at pH 6.0 compared to other anthocyanins without acylation. Dougall et al. (1977) were able to produce stable anthocyanins by acylation of carrot anthocyanins in cell cultures. They found that a wide range of aromatic acids could be incorporated into the anthocyanin.

Anthocyanins can form purplish or slate-gray pigments with metals, which are called lakes. This can happen when canned foods take up tin from the container. Anthocyanins

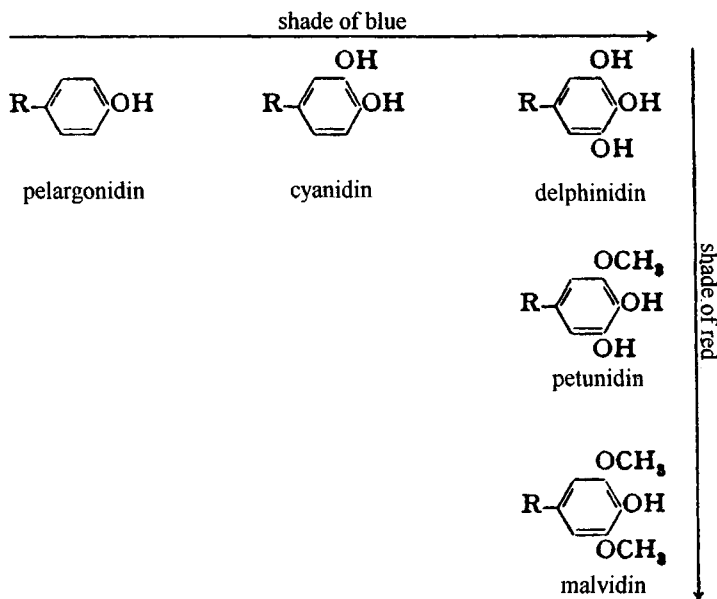

Figure 6-25 Effect of Substituents on the Color of Anthocyanidins. *Source:* Reprinted with permission from J.B.S. Braverman, *Introduction to the Biochemistry of Foods*, © 1963, Elsevier Publishing Co.

can be bleached by sulfur dioxide. According to Jurd (1964), this is a reversible process that does not involve hydrolysis of the glycosidic linkage, reduction of the pigment, or addition of bisulfite to a ketonic, chalcone derivative. The reactive species was found to be the anthocyanin carbonium ion (R^+), which reacts with a bisulfite ion to form a colorless chromen-2(or 4)-sulfonic acid ($\text{R}-\text{SO}_3\text{H}$), similar in structure and properties to an anthocyanin carbinol base ($\text{R}-\text{OH}$). This reaction is shown in Figure 6-26.

The colors of the anthocyanins at acid pH values correspond to those of the oxonium salts. In slightly alkaline solutions (pH 8 to 10), highly colored ionized anhydro bases are formed. At pH 12, these hydrolyze rapidly to fully ionized chalcones (Figure 6-27). Leuco bases are the reduced form of the anthocyanins. They are usually without much color but are widely distributed in fruits and vegetables. Under the influence of oxygen and acid hydrolysis, they may develop the characteristic color of the car-

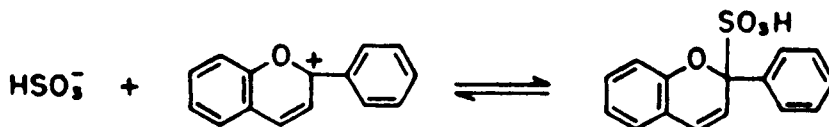

Figure 6-26 Reaction of Bisulfite with the Anthocyanin Carbonium Ion



Figure 6-27 Structure of Anhydro Base (I) and Chalcone (II)

bonium ion. Canned pears, for example, may show “pinking”—a change from the leuco base to the anthocyanin.

The flavonoids or anthoxanthins are glycosides with a benzopyrone nucleus. The flavones have a double bond between carbons 2 and 3. The flavonols have an additional hydroxyl group at carbon 3, and the flavanones are saturated at carbons 2 and 3 (Figure 6-28). The flavonoids have low col-

oring power but may be involved in discolorations; for example, they can impart blue and green colors when combined with iron. Some of these compounds are also potential substrates for enzymic browning and can cause undesirable discoloration through this mechanism. The most ubiquitous flavonoid is quercetin, a 3,5,7,3',4'-pentahydroxy flavone (Figure 6-29). Many flavonoids contain the sugar rutinose, a disaccharide of glucose

(1) flavones (positions 2:3 unsaturated)

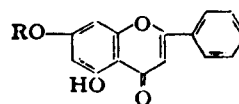

(2) flavonols (an additional OH at position 3)

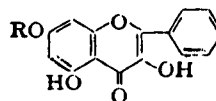

(3) flavanones (saturated at positions 2:3)

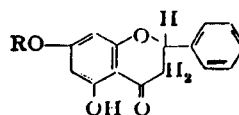

(4) flavanonols (position 3 saturated and extra hydroxyl group)

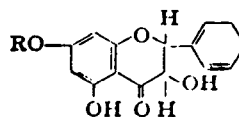

(5) isoflavones (phenol ring B at position 3)

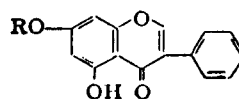

Figure 6-28 Structure of Flavones, Flavonols, Flavanones, Flavanonols, and Isoflavones

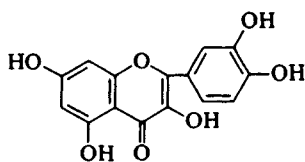

Figure 6-29 Structure of Quercetin

and rhamnose. Hesperidin is a flavanone occurring in citrus fruits and, at pH 12, the inner ring opens to form a chalcone in a similar way as shown for the anthocyanins. The chalcones are yellow to brown in color.

Tannins

Tannins are polyphenolic compounds present in many fruits. They are important as color compounds and also for their effect on taste as a factor in astringency (see Chapter 7). Tannins can be divided into two classes—hydrolyzable tannins and nonhydrolyzable or condensed tannins. The tannins are characterized by the presence of a large number of hydroxyl groups, which provide the ability to form reversible bonds with other macromolecules, polysaccharides, and proteins, as well as other substances such as alkaloids. This bond formation may occur during the development of the fruit or during the mechanical damage that takes place during processing.

Hydrolyzable tannins are composed of phenolic acids and sugars that can be broken down by acid, alkaline, or enzymic hydroly-

sis. They are polyesters based on gallic acid and/or hexahydroxydiphenic acid (Figure 6-30). The usual sugar is D-glucose and molecular weights are in the range of 500 to 2,800. Gallotannins release gallic acid on hydrolysis, and ellagitannins produce ellagic acid. Ellagic acid is the lactone form of hexahydroxydiphenic acid, which is the compound originally present in the tannin (Figure 6-30).

Nonhydrolyzable or condensed tannins are also named proanthocyanidins. These are polymers of flavan-3-ols, with the flavan bonds most commonly between C4 and C8 or C6 (Figure 6-23) (Macheix et al. 1990). Many plants contain tannins that are polymers of (+)-catechin or (-)-epicatechin. These are hydrogenated forms of flavonoids or anthocyanidins. Other monomers occupying places in condensed fruit tannins have trihydroxylation in the B-ring: (+)-gallo catechin and (-)-epigallocatechin. Oligomeric and polymeric procyanidins are formed by addition of more flavan-3-ol units and result in the formation of helical structures. These structures can form bonds with proteins.

Tannins are present in the skins of red grapes and play an important part in the flavor profile of red wine. Tannins in grapes are usually estimated in terms of the content of gallic acid (Amerine and Joslyn 1970).

Oxidation and polymerization of phenolic compounds as a result of enzymic activity of phenoloxidases or peroxidases may result in

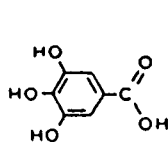

GALLIC ACID

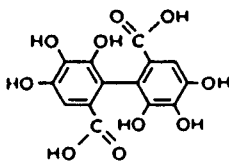

HEXAHYDROXYDIPHENIC ACID

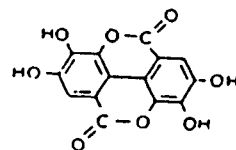

ELLAGIC ACID

Figure 6-30 Structure of Components of Hydrolyzable Tannins

the formation of brown pigments. This can take place during the growth of fruits (e.g., in dates) or during mechanical damage in processing.

Betalains

Table beets are a good source of red pigments; these have been increasingly used for food coloring. The red and yellow pigments

obtained from beets are known as betalains and consist of the red betacyanins and the yellow betaxanthins (Von Elbe and Maing 1973). The structures of the betacyanins are shown in Figure 6-31. The major betacyanin is betanin, which accounts for 75 to 95 percent of the total pigments of beets. The remaining pigments contain isobetanin, prebetanin, and isoprebetanin. The latter two are sulfate monoesters of betanin and isobetanin,

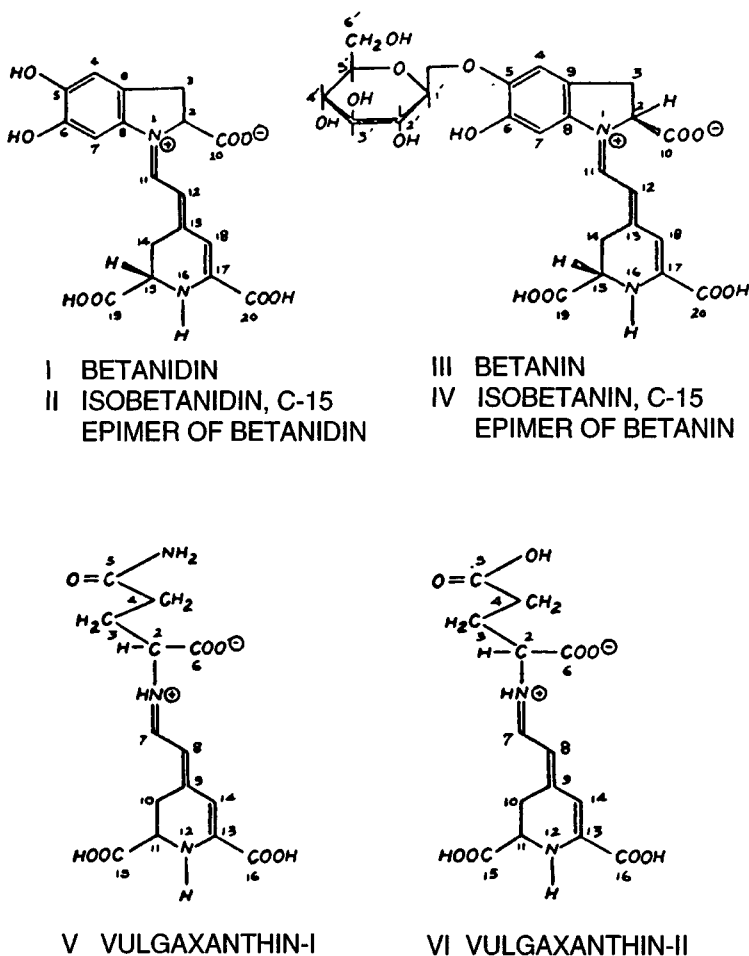

Figure 6-31 Structure of Naturally Occurring Betalains in Red Beets. *Source:* From J.H. Von Elbe and I.-Y. Maing, Betalains as Possible Food Colorants of Meat Substitutes, *Cereal Sci. Today*, Vol. 18, pp. 263-264, 316-317, 1973.

respectively. The major yellow pigments are vulgaxanthin I and vulgaxanthin II. Betanin is the glucoside of betanidin, and isobetanin is the C-15 epimer of betanin.

Betanidin has three carboxyl groups ($pK_a = 3.4$), two phenol groups ($pH_a = 8.5$), and asymmetric carbons at positions 2 and 15. The 15-position is easily isomerized under acid or basic conditions in the absence of oxygen to yield isobetanidin. Under alkaline conditions and in the presence of glutamine or glutamic acid, betanin can be converted to vulgaxanthin (Mabry 1970).

The color of betanin solutions is influenced by pH. In the range of 3.5 to 7.0, the spectrum shows a maximum of 537 nm (Figure 6-32). Below pH 3, the intensity of this maximum decreases and a slight increase in the region of 570 to 640 nm occurs and the color shifts toward violet. At pH values over

7, a shift of the maximum occurs to longer wavelength. At pH 9, the maximum is about 544 nm and the color shifts toward blue. Von Elbe et al. (1974) found that the color of betanin is most stable between pH 4.0 and 6.0. The thermostability is greatest between pH 4.0 and 5.0. Light and air have a degrading effect on betanin, and the effect is cumulative.

Caramel

Caramel color can be produced from a variety of carbohydrate sources, but usually corn sugar syrup is used. Corn starch is first hydrolyzed with acid to a DE of 8 to 9, followed by hydrolysis with bacterial α -amylase to a DE of 12 to 14, then with fungal amyloglucosidase up to a DE of 90 to 95. Several types of caramel are produced. The largest amount is

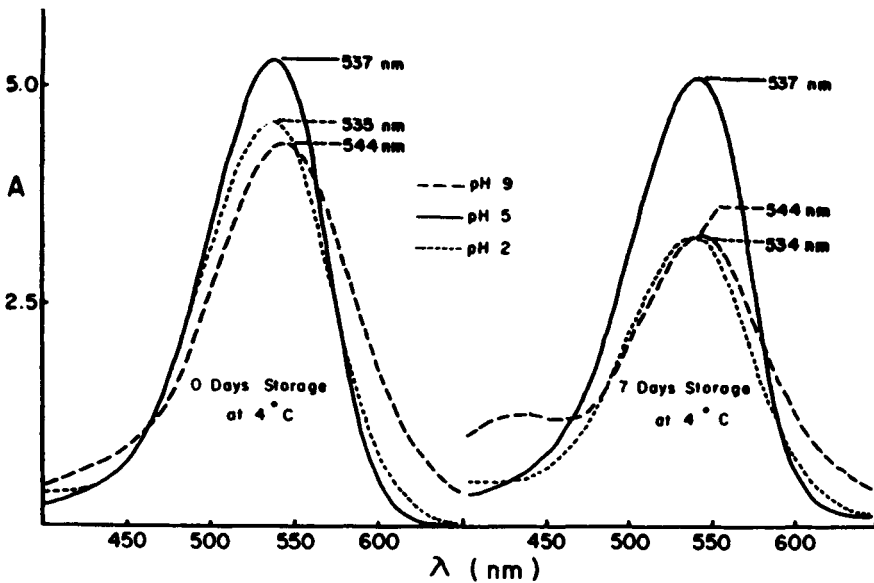

Figure 6-32 Visible Spectra of Betanin at pH Values of 2.0, 5.0, and 9.0. *Source:* From J.H. Von Elbe, I.-Y. Maing, and C.H. Amundson, *Color Stability of Betanin*, *Journal of Food Science*, Vol. 39, pp. 334-337, 1974, Institute of Food Technologists.

electropositive or positive caramel, which is made with ammonia. Electronegative or negative caramel is made with ammonium salts. A slightly electronegative caramel is soluble in alcohol and is used for coloring beverages (Greenshields 1973). The composition and coloring power of caramel depends on the type of raw materials and the process used. Both Maillard-type reactions and pure caramelizing reactions are thought to be involved, and the commercial product is extremely complex in composition. Caramels contain high and low molecular weight colored compounds, as well as a variety of volatile components.

Other Colorants

Synthetic colorants, used commercially, are also known as certified color additives. There are two types, FD&C dyes and FD&C lakes. FD&C indicates substances approved for use in food, drug, and cosmetic use by U.S. federal regulations. Dyes are water-soluble compounds that produce color in solution. They are manufactured in the form of powders, granules, pastes, and dispersions. They are used in foods at concentrations of less than 300 ppm (Institute of Food Technologists 1986). Lakes are made by combining dyes with alumina to form insoluble colorants, which have dye contents in the range of 20 to 25 percent (Pearce 1985). The lakes produce color in dispersion and can be used in oil-based foods when insufficient water is present for the solubilization of the dye. The list of approved water-soluble colorants has changed frequently; the current list is given in Chapter 11.

The uncertified color additives (Institute of Food Technologists 1986) include a number of natural extracts as well as inorganic substances such as titanium dioxide. Some of these can be used only with certain restrictions (Table 6-7). The consumer demand for more natural colorants has provided an impetus for examining many natural coloring substances. These have been described in detail by Francis (1987). The possibility of using plant tissue culture for the production of natural pigments has also been considered (Ilker 1987).

Table 6-7 Color Additives Not Requiring Certification

<i>Colorant</i>	<i>Restriction</i>
Annatto extract	—
Beta-apo-8'-carotenal	33 mg/kg
Beta-carotene	—
Beet powder	—
Canthaxanthin	66 mg/kg
Caramel	—
Carrot oil	—
Cochineal extract (carmine)	—
Ferrous gluconate	Ripe olives only
Fruit juice	—
Grape color extract	Nonbeverage foods only
Grape skin extract (enocianina)	Beverages
Paprika and its oleoresin	—
Riboflavin	—
Saffron	—
Titanium dioxide	1%
Turmeric and its oleo- resin	—
Vegetable juice	—

REFERENCES

- Amerine, M.A., and M.A. Joslyn. 1970. *Table wines. The technology of their production*. Berkeley, CA: University of California Press.
- Bodwell, C.E., and P.E. McClain. 1971. Proteins. In *The sciences of meat products*, ed. J. Price and B.S. Schweigert. San Francisco: W.H. Freeman and Co.
- Borenstein, B., and R.H. Bunnell. 1967. Carotenoids: Properties, occurrence and utilization in foods. In *Advances in food research*, Vol. 15, ed. C.O. Chichester, E.M. Mrak, and G.F. Stewart. New York: Academic Press.
- Braverman, J.B.S. 1963. *Introduction to the biochemistry of foods*. New York: Elsevier Publishing Co.
- Chichester, C.O., and R. McFeeters. 1971. Pigment degeneration during processing and storage. In *The biochemistry of fruits and their products*, ed. A.C. Hulme. New York: Academic Press.
- Clydesdale, F.M., and F.J. Francis. 1970. Color scales. *Food Prod. Dev.* 3: 117-125.
- Counsell, J.N. 1985. Uses of carotenoids in foods. *IFST Proceedings* 18: 156-162.
- Curl, A.L., and G.F. Bailey. 1956. Carotenoids of aged canned Valencia orange juice. *J. Agr. Food Chem.* 4: 159-162.
- Daravingas, G., and R.F. Cain. 1965. Changes in the anthocyanin pigments of raspberries during processing and storage. *J. Food Sci.* 30: 400-405.
- Dougall, D.K., et al. 1997. Biosynthesis and stability of monoacylated anthocyanins. *Food Technol.* 51, no. 11: 69-71.
- Dziedzic, J.D. 1987. Applications of food colorants. *Food Technol.* 41, no. 4: 78-88.
- Falconer, M.E., et al. 1964. Carotene oxidation and off-flavor development in dehydrated carrot. *J. Sci. Food Agr.* 15: 897-901.
- Fox, J.B. 1966. The chemistry of meat pigments. *J. Agr. Food Chem.* 14: 207-210.
- Francis, F.J. 1987. Lesser known food colorants. *Food Technol.* 41, no. 4: 62-68.
- Greenshields, R.N. 1973. Caramel—Part 2. Manufacture, composition and properties. *Process Biochem.* 8, no. 4: 17-20.
- Grob, E.C. 1963. The biogenesis of carotenes and carotenoids. In *Carotenes and carotenoids*, ed. K. Lang. Darmstadt, Germany: Steinkopff Verlag.
- Ilker, R. 1987. In-vitro pigment production: An alternative to color synthesis. *Food Technol.* 41, no. 4: 70-72.
- Institute of Food Technologists. 1986. Food colors: Scientific status summary. *Food Technol.* 40, no. 7: 49-56.
- Jurd, L. 1964. Reactions involved in sulfite bleaching of anthocyanins. *J. Food Sci.* 29: 16-19.
- Landrock, A.H., and G.A. Wallace. 1955. Discoloration of fresh red meat and its relationship to film oxygen permeability. *Food Technol.* 9: 194-196.
- Lynn, D.Y.C., and B.S. Luh. 1964. Anthocyanin pigments in Bing cherries. *J. Food Sci.* 29: 735-743.
- Mabry, T.J. 1970. Betalains, red-violet and yellow alkaloids of *Centrospermae*. In *Chemistry of the Alkaloids*, ed. S.W. Pelletier. New York: Van Nostrand Reinhold Co.
- Macheix, J.J., et al. 1990. *Fruit phenolics*. Boca Raton, FL: CRC Press.
- MacKinney, G., and A.C. Little. 1962. Color of foods. Westport, CT: AVI Publishing Co.
- Maes, P.J.A., et al. 1997. Converting spectra into color indices. *Inform* 8: 1245-1252.
- Möhler, K. 1974. Formation of curing pigments by chemical, biochemical or enzymatic reactions. In *Proceedings of the International Symposium on Nitrite in Meat Products*. Wageningen, The Netherlands: Center for Agricultural Publishing and Documentation.
- Pearce, A. 1985. Current synthetic food colors. *IFST Proceedings* 18: 147-155.
- Solberg, M. 1968. Factors affecting fresh meat color. *Proc. Meat Ind. Research Conference*, Chicago. March 21, 22.
- Solberg, M. 1970. The chemistry of color stability in meat: A review. *Can. Inst. Food Technol. J.* 3: 55-62.
- Somaatmadja, D., and J.J. Powers. 1963. Anthocyanins, IV: Anthocyanin pigments of Cabernet Sauvignon grapes. *J. Food Sci.* 28: 617-622.
- Sun, B.H., and F.J. Francis. 1968. Apple anthocyanins: Identification of cyanidin-7-arabinoside. *J. Food Sci.* 32: 647-649.

- Von Elbe, J.H., and I.-Y. Maing. 1973. Betalains as possible food colorants of meat substitutes. *Cereal Sci. Today* 18: 263–264, 316–317.
- Von Elbe, J.H., I.-Y. Maing, and C.H. Amundson. 1974. Color stability of betanin. *J. Food Sci.* 39: 334–337.
- Weckel, K.G., et al. 1962. Carotene components of frozen and processed carrots. *Food Technol.* 16, no. 8: 91–94.
- Yoshida, K., et al. 1991. Unusually stable monoacylated anthocyanin from purple yam *Dioscorea alata*. *Tetrahedron Lett.* 32: 5579–5580.
- Zapsalis, C., and F.J. Francis. 1965. Cranberry anthocyanins. *J. Food Sci.* 30: 396–399.

Flavor

INTRODUCTION

Flavor has been defined by Hall (1968) as follows: "Flavor is the sensation produced by a material taken in the mouth, perceived principally by the senses of taste and smell, and also by the general pain, tactile and temperature receptors in the mouth. Flavor also denotes the sum of the characteristics of the material which produce that sensation."

This definition makes clear that flavor is a property of a material (a food) as well as of the receptor mechanism of the person ingesting the food. The study of flavor includes the composition of food compounds having taste or smell, as well as the interaction of these compounds with the receptors in the taste and smell sensory organs. Following an interaction, the organs produce signals that are carried to the central nervous system, thus creating what we understand as flavor. This process is probably less well understood than the processes occurring in other organs (O'Mahony 1984). Beidler (1957) has represented the taste process schematically (Figure 7-1).

Although flavor is composed mainly of taste and odor, other qualities contribute to the overall sensation. Texture has a very definite effect. Smoothness, roughness, granularity, and viscosity can all influence

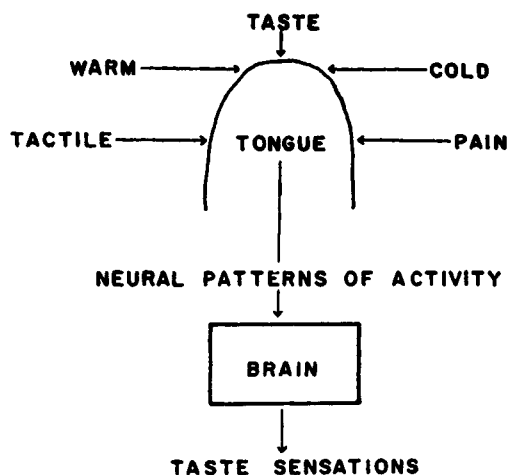

Figure 7-1 Schematic Representation of the Taste Process. *Source:* From L.M. Beidler, *Facts and Theory on the Mechanism of Taste and Odor Perception*, in *Chemistry of Natural Food Flavors*, 1957, Quartermaster Food and Container Institute for the Armed Forces.

flavor, as can hotness of spices, coolness of menthol, brothiness or fullness of certain amino acids, and the tastes described as metallic and alkaline.

TASTE

It is generally agreed that there are only four basic, or *true*, tastes: sweet, bitter, sour,

and salty. The sensitivity to taste is located in taste buds of the tongue. The taste buds are grouped in papillae, which appear to be sensitive to more than one taste. There is undoubtedly a regional distribution of the four kinds of receptors at the tongue, creating areas of sensitivity—the sweet taste at the tip of the tongue, bitter at the back, sour at the edges, and salty at both edges and tip (Figure 7-2). The question of how the four types of receptors are able to respond this specifically has not been resolved. According to Teranishi et al. (1971), perception of the basic taste qualities results from a pattern of nerve activity coming from many taste cells; specific receptors for sweet, sour, bitter, and salty do not exist. It may be envisioned that a single taste cell possesses multiple receptor sites, each of which may have specificity.

The mechanism of the interaction between the taste substance and the taste receptor is not well understood. It has been suggested

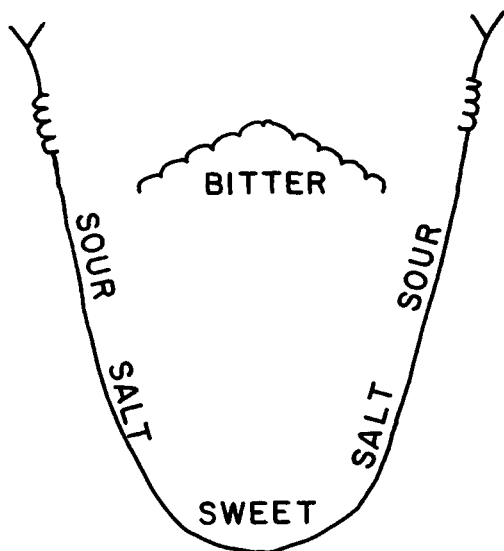

Figure 7-2 Areas of Taste Sensitivity of the Tongue

that the taste compounds interact with specific proteins in the receptor cells. Sweet- and bitter-sensitive proteins have been reported. Dastoli and Price (1966) isolated a protein from bovine tongue epithelium that showed the properties of a sweet taste receptor molecule. Dastoli et al. (1968) reported isolating a protein that had the properties of a bitter receptor.

We know that binding between stimulus and receptor is a weak one because no irreversible effects have been observed. A mechanism of taste stimulation with electrolytes has been proposed by Beidler (1957); it is shown in Figure 7-3. The time required for taste response to take place is in the order of 25 milliseconds. The taste molecule is weakly adsorbed, thereby creating a disturbance in the molecular geography of the surface and allowing an interchange of ions across the surface. This reaction is followed by an electrical depolarization that initiates a nerve impulse.

The taste receptor mechanism has been more fully described by Kurihara (1987). The process from chemical stimulation to transmitter release is schematically presented in Figure 7-4. The receptor membranes contain voltage-dependent calcium channels. Taste compounds contact the taste cells and depolarize the receptor membrane; this depolarization spreads to the synaptic area, activating the voltage-dependent calcium channels. Influx of calcium triggers the release of the transmitter norepinephrine.

The relationship between stimulus concentration and neural response is not a simple one. As the stimulus concentration increases, the response increases at a decreasing rate until a point is reached where further increase in stimulus concentration does not produce a further increase in response. Beidler (1954) proposed the following equa-

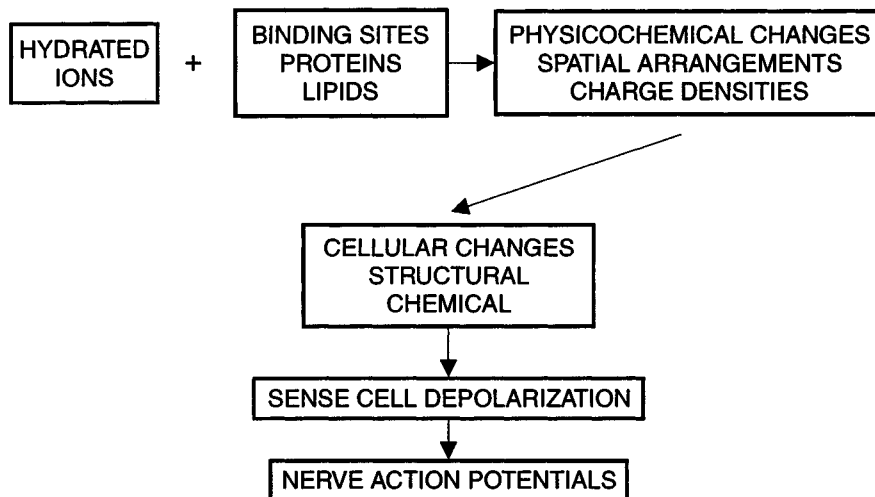

Figure 7-3 Mechanism of Taste Stimulation as Proposed by Beidler. *Source:* From L.M. Beidler, Facts and Theory on the Mechanism of Taste and Odor Perception, in *Chemistry of Natural Food Flavors*, 1957, Quartermaster Food and Container Institute for the Armed Forces.

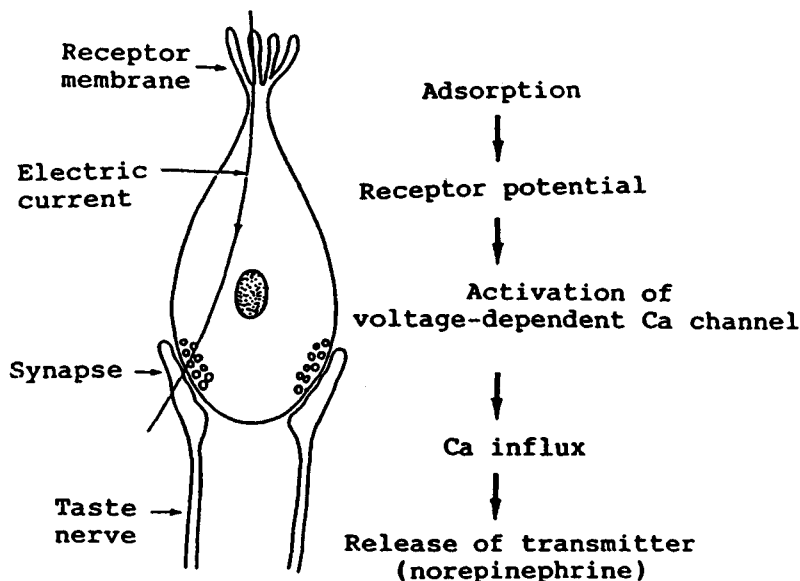

Figure 7-4 Diagram of a Taste Cell and the Mechanism of Chemical Stimulation and Transmitter Release. *Source:* Reprinted with permission from Y. Kawamura and M.R. Kare, *Umami: A Basic Taste*, © 1987, Marcel Dekker, Inc.

tion relating magnitude of response and stimulus concentration:

$$\frac{C}{R} = \frac{C}{R_s} + \frac{1}{KR_s}$$

where

C = stimulus concentration

R = response magnitude

R_s = maximum response

K = equilibrium constant for the stimulus-receptor reaction

K values reported by Beidler for many substances are in the range of 5 to 15.

It appears that the initial step in the stimulus-receptor reaction is the formation of a weak complex, as evidenced by the small values of K . The complex formation results in the initiation of the nerve impulse. Taste responses are relatively insensitive to changes in pH and temperature. Because of the decreasing rate of response, we know that the number of receptor sites is finite. The taste response is a function of the proportion of sites occupied by the stimulus compound.

According to Beidler (1957), the threshold value of a substance depends on the equilibrium constant and the maximum response. Since K and R_s both vary from one substance to another and from one species to another, the threshold also varies between substances and species. The concentration of the stimulus can be increased in steps just large enough to elicit an increase in response. This amount is called the just noticeable difference (JND).

There appear to be no significant age- or sex-related differences in taste sensitivity (Fisher 1971), but heavy smoking (more than 20 cigarettes per day) results in a deterioration in taste responsiveness with age.

Differences in taste perception between individuals seem to be common. Peryam

(1963) found that sweet and salt are usually well recognized. However, with sour and bitter taste some difficulty is experienced. Some tasters ascribe a bitter quality to citric acid and a sour quality to caffeine.

Chemical Structure and Taste

A first requirement for a substance to produce a taste is that it be water soluble. The relationship between the chemical structure of a compound and its taste is more easily established than that between structure and smell. In general, all acid substances are sour. Sodium chloride and other salts are salty, but as constituent atoms get bigger, a bitter taste develops. Potassium bromide is both salty and bitter, and potassium iodide is predominantly bitter. Sweetness is a property of sugars and related compounds but also of lead acetate, beryllium salts, and many other substances such as the artificial sweeteners saccharin and cyclamate. Bitterness is exhibited by alkaloids such as quinine, picric acid, and heavy metal salts.

Minor changes in chemical structure may change the taste of a compound from sweet to bitter or tasteless. For example, Beidler (1966) has examined saccharin and its substitution compounds. Saccharin is 500 times sweeter than sugar (Figure 7-5). Introduction of a methyl group or of chloride in the *para* position reduces the sweetness by half. Placing a nitro group in the *meta* position makes the compound very bitter. Introduction of an amino group in the *para* position retains the sweetness. Substitutions at the imino group by methyl, ethyl, or bromoethyl groups all result in tasteless compounds. However, introduction of sodium at this location yields sodium saccharin, which is very sweet.

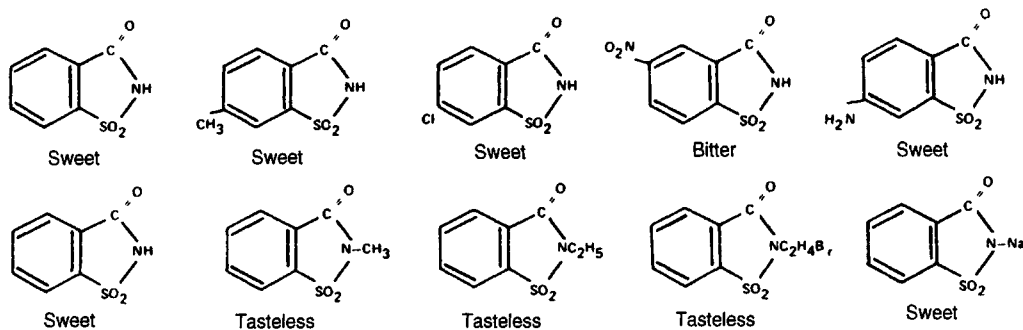

Figure 7-5 The Effect of Substitutions in Saccharin on Sweetness. *Source:* From L.M. Beidler, Chemical Excitation of Taste and Odor Receptors, in *Flavor Chemistry*, I. Hornstein, ed., 1966, American Chemistry Society.

The compound 5-nitro-*o*-toluidine is sweet. The positional isomers 3-nitro-*o*-toluidine and 3-nitro-*p*-toluidine are both tasteless (Figure 7-6). Teranishi et al. (1971) provided another example of change in taste resulting from the position of substituent group: 2-amino-4-nitro-propoxybenzene is 4,000 times sweeter than sugar, 2-nitro-4-amino-propoxybenzene is tasteless, and 2,4-dinitro-propoxybenzene is bitter (Figure 7-7). Dulcin (*p*-ethoxyphenylurea) is extremely sweet, the thiourea analog is bitter, and the *o*-ethoxyphenylurea is tasteless (Figure 7-8).

Just as positional isomers affect taste, so do different stereoisomers. There are eight amino acids that are practically tasteless. A group of three has varying tastes; except for glutamic acid, these are probably derived from sulfur-containing decomposition prod-

ucts. Seven amino acids have a bitter taste in the L form or a sweet taste in the D form, except for L-alanine, which has a sweet taste (Table 7-1). Solms et al. (1965) reported on the taste intensity, especially of aromatic amino acids. L-tryptophan is about half as bitter as caffeine; D-tryptophan is 35 times sweeter than sucrose and 1.7 times sweeter than calcium cyclamate. L-phenylalanine is about one-fourth as bitter as caffeine; the D form is about seven times sweeter than sucrose. L-tyrosine is about one-twentieth as bitter as caffeine, but D-tyrosine is still 5.5 times sweeter than sucrose.

Some researchers claim that differences exist between the L and D forms of some sugars. They propose that L-glucose is slightly salty and not sweet, whereas D-glucose is sweet. There is even a difference in taste

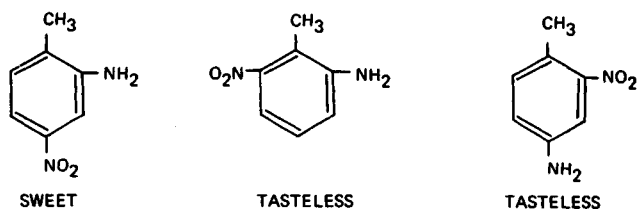

Figure 7-6 Taste of Nitrotoluidine Isomers

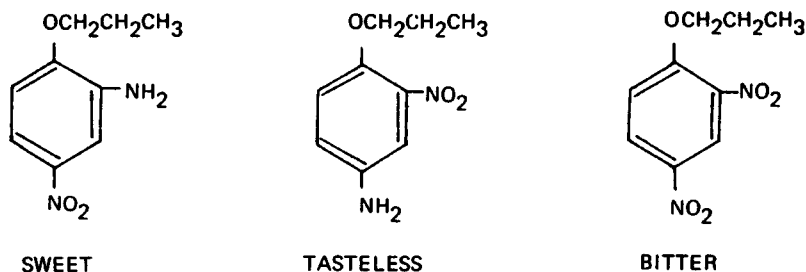
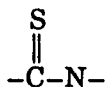

Figure 7-7 Taste of Substituted Propoxybenzenes

between the two anomers of D-mannose. The α form is sweet as sugar, and the β form is bitter as quinine.

Optical isomers of carvone have totally different flavors. The D+ form is characteristic of caraway; the L- form is characteristic of spearmint.

The ability to taste certain substances is genetically determined and has been studied with phenylthiourea. At low concentrations, about 25 percent of subjects tested do not taste this compound; for the other 75 percent, the taste is bitter. The inability to taste phenylthiourea is probably due to a recessive gene. The compounds by which tasters and nontasters can be differentiated all contain the following isothiocyanate group:



These compounds—phenylthiourea, thio-urea, and thiouracil—are illustrated in Figure

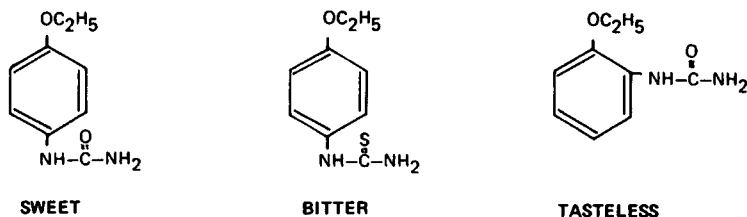
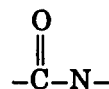

Figure 7-8 Taste of Substituted Ethoxybenzenes

7-9. The corresponding compounds that contain the group,



phenylurea, urea, and uracil, do not show this phenomenon. Another compound containing the isothiocyanate group has been found in many species of the Cruciferae family; this family includes cabbage, turnips, and rapeseed and is well known for its goitrogenic effect. The compound is goitrin, 5-vinylloxazolidine-2-thione (Figure 7-10).

Sweet Taste

Many investigators have attempted to relate the chemical structure of sweet tasting compounds to the taste effect, and a series of theories have been proposed (Shallenberger 1971). Shallenberger and Acree (1967, 1969) pro-

Table 7-1 Difference in Taste Between the L- and D-Forms of Amino Acids

Amino Acid	Taste of L Isomer	Taste of D Isomer
Asparagine	Insipid	Sweet
Glutamic acid	Unique	Almost tasteless
Phenylalanine	Faintly bitter	Sweet, bitter aftertaste
Leucine	Flat, faintly bitter	Strikingly sweet
Valine	Slightly sweet, bitter	Strikingly sweet
Serine	Faintly sweet, stale aftertaste	Strikingly sweet
Histidine	Tasteless to bitter	Sweet
Isoleucine	Bitter	Sweet
Methionine	Flat	Sweet
Tryptophane	Bitter	Very sweet

posed a theory that can be considered a refinement of some of the ideas incorporated in previous theories. According to this theory, called the AH,B theory, all compounds that bring about a sweet taste response possess an electronegative atom A, such as oxygen or nitrogen. This atom also possesses a proton attached to it by a single covalent bond; therefore, AH can represent a hydroxyl group, an imine or amine group, or a methine group.

Within a distance of about 0.3 nm from the AH proton, there must be a second electronegative atom B, which again can be oxygen or nitrogen (Figure 7-11). Investigators have recognized that sugars that occur in a favored chair conformation yield a glycol unit conformation with the proton of one hydroxyl group at a distance of about 0.3 nm from the oxygen of the next hydroxyl group; this unit can be considered as an AH,B system. It was also found that the π bonding cloud of the benzene ring could serve as a B moiety. This explains the sweetness of benzyl alcohol and the sweetness of the *anti* isomer of anisaldehyde oxime, as well as the lack of sweetness of the *syn* isomer. The structure of these compounds is given in Figure 7-12. The AH,B system present in sweet compounds is, according to Shallenberger, able to react with a similar AH,B unit that exists at the taste bud receptor site through the formation of simultaneous hydrogen bonds. The relatively strong nature of such bonds could explain why the sense of sweetness is a lingering sensation. According to the AH,B theory, there should not be a difference in sweetness between the L and D isomers of sugars. Experiments by Shallenberger (1971) indicated that a panel could not distinguish among the sweet taste of the enantiomorphic forms of glucose, galactose, mannose, arabinose, xylose, rhamnose, and glucoheptulose. This suggests that the notion that L sugars are tasteless is a myth.

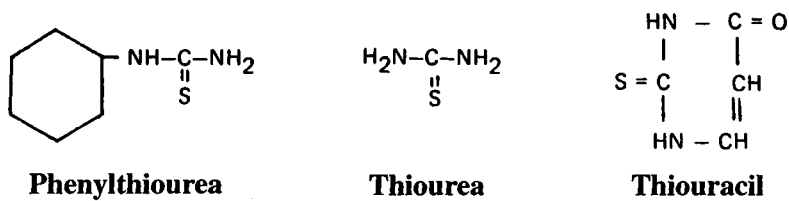

Figure 7-9 Compounds Containing the $\begin{matrix} \text{S} \\ || \\ -\text{C}-\text{N}- \end{matrix}$ Group by Which Tasters and Nontasters Can Be Differentiated

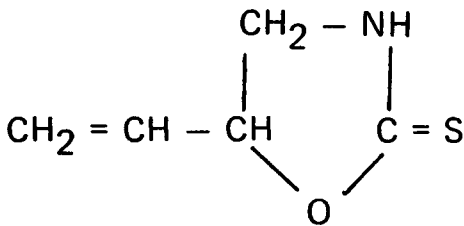

Figure 7-10 5-Vinyloxazolidine-2-thione

Spillane (1996) has pointed out that the AH,B theory appears to work quite well, although spatial, hydrophobic/hydrophilic, and electronic effects are also important. Shallenberger (1998) describes the initiation of sweetness as being due to a concerted intermolecular, antiparallel hydrogen-bonding interaction between the glycochore (Greek *glyks*, sweet; *phoros*, to carry) and receptor dipoles. The difficulty in explaining the sweetness of compounds with different chemical structures is also covered by Shallenberger (1998) and how this has resulted in alternative taste theories. The application of sweetness theory is shown to have important applications in the food industry.

Extensive experiments with a large number of sugars by Birch and Lee (1971) support Shallenberger's theory of sweetness and indicate that the fourth hydroxyl group of glucopyranosides is of unique importance in determining sweetness, possibly by donating the proton as the AH group. Ap-

parently the primary alcohol group is of little importance for sweetness. Substitution of acetyl or azide groups confers intense bitterness to sugars, whereas substitution of benzoyl groups causes tastelessness.

As the molecular weight of saccharides increases, their sweetness decreases. This is best explained by the decrease in solubility and increase in size of the molecule. Apparently, only one sugar residue in each oligosaccharide is involved in the interaction at the taste bud receptor site.

The relative sweetness of a number of sugars and other sweeteners has been reported by Solms (1971) and is given in Table 7-2. These figures apply to compounds tasted singly and do not necessarily apply to sugars in foods, except in a general sense. The relative sweetness of mixtures of sugars changes with the concentration of the components. Synergistic effects may increase the sweetness by as much as 20 to 30 percent in such mixtures (Stone and Oliver 1969).

Sour Taste

Although it is generally recognized that sour taste is a property of the hydrogen ion, there is no simple relationship between sourness and acid concentration. Acids have different tastes; the sourness as experienced in the mouth may depend on the nature of the acid group, pH, titratable acidity, buffering

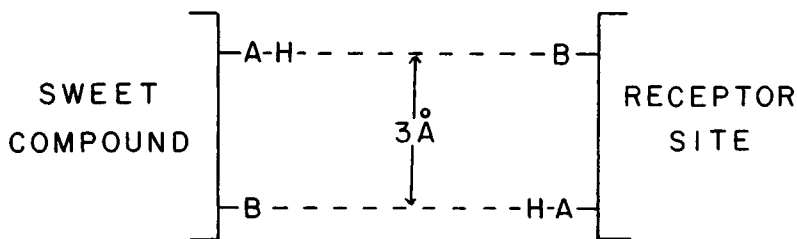

Figure 7-11 The AH,B Theory of Sweet Taste Perception

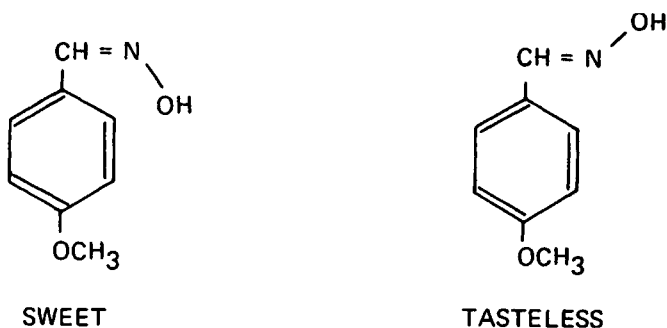

Figure 7-12 *Anti*-Anisaldehyde Oxime, Sweet; and *Syn*-Anisaldehyde Oxime, Tasteless

effects and the presence of other compounds, especially sugars. Organic acids have a greater taste effect than inorganic acids (such as hydrochloric acid) at the same pH. Information on a number of the most common acids found in foods and phosphoric acid (which is also used in soft drinks) has been collected by Solms (1971) and compared with hydrochloric acid. This information is presented in Table 7-3.

According to Beatty and Cragg (1935), relative sourness in unbuffered solutions of acids is not a function of molarity but is proportional to the amount of phosphate buffer required to bring the pH to 4.4. Ough (1963) determined relative sourness of four organic acids added to wine and also preference for these acids. Citric acid was judged the most sour, fumaric and tartaric about equal, and adipic least sour. The tastes of citric and tartaric acids were preferred over those of fumaric and adipic acids.

Pangborn (1963) determined the relative sourness of lactic, tartaric, acetic, and citric acid and found no relation between pH, total acidity, and relative sourness. It was also found that there may be considerable differences in taste effects between sugars and acids when they are tested in aqueous solutions and in actual food products.

Table 7-2 Relative Sweetness of Sugars and Other Sweeteners

<i>Compound</i>	<i>Relative Sweetness</i>
Sucrose	1
Lactose	0.27
Maltose	0.5
Sorbitol	0.5
Galactose	0.6
Glucose	0.5-0.7
Mannitol	0.7
Glycerol	0.8
Fructose	1.1-1.5
Cyclamate	30-80
Glycyrrhizin	50
Aspartyl-phenylalanine methylester	100-200
Stevioside	300
Naringin dihydrochalcone	300
Saccharin	500-700
Neohesperidin dihydrochalcone	1000-1500

Source: From J. Solms, *Nonvolatile Compounds and the Flavor of Foods*, in *Gustation and Olfaction*, G. Ohloff and A.F. Thomas, eds., 1971, Academic Press.

Table 7-3 Properties of Some Acids, Arranged in Order of Decreasing Acid Taste and with Tartaric Acid as Reference*Properties of 0.05N Solutions*

<i>Acid</i>	<i>Taste</i>	<i>Total Acid g/L</i>	<i>pH</i>	<i>Ionization Constant</i>	<i>Taste Sensation</i>	<i>Found In</i>
Hydrochloric	+1.43	1.85	1.70	—	—	—
Tartaric	0	3.75	2.45	1.04×10^{-3}	Hard	Grape
Malic	-0.43	3.35	2.65	3.9×10^{-4}	Green	Apple, pear, prune, grape, cherry, apricot
Phosphoric	-1.14	1.65	2.25	7.52×10^{-3}	Intense	Orange, grapefruit
Acetic	-1.14	3.00	2.95	1.75×10^{-5}	Vinegar	—
Lactic	-1.14	4.50	2.60	1.26×10^{-4}	Sour, tart	—
Citric	-1.28	3.50	2.60	8.4×10^{-4}	Fresh	Berries, citrus, pineapple
Propionic	-1.85	3.70	2.90	1.34×10^{-5}	Sour, cheesy	—

Source: From J. Solms, *Nonvolatile Compounds and the Flavor of Foods*, in *Gustation and Olfaction*, G. Ohloff and A.F. Thomas, eds., 1971, Academic Press.

Buffering action appears to help determine the sourness of various acids; this may explain why weak organic acids taste more sour than mineral acids of the same pH. It is suggested that the buffering capacity of saliva may play a role, and foods contain many substances that could have a buffering capacity.

Wucherpennig (1969) examined the sour taste in wine and found that alcohol may decrease the sourness of organic acids. He examined the relative sourness of 17 organic acids and found that the acids tasted at the same level of undissociated acid have greatly different intensities of sourness. Partially neutralized acids taste more sour than pure acids containing the same amount of undissociated acids. The change of malic into lactic acid during the malolactic fermentation of wines leads to a decrease in sourness, thus making the flavor of the wine milder.

Salty Taste

The salty taste is best exhibited by sodium chloride. It is sometimes claimed that the taste of salt by itself is unpleasant and that the main purpose of salt as a food component is to act as a flavor enhancer or flavor potentiator. The taste of salts depends on the nature of both cation and anion. As the molecular weight of either cation or anion—or both—increases, salts are likely to taste bitter. The lead and beryllium salts of acetic acid have a sweet taste. The taste of a number of salts is presented in Table 7-4.

The current trend of reducing sodium intake in the diet has resulted in the formulation of low-sodium or reduced-sodium foods. It has been shown (Gillette 1985) that sodium chloride enhances mouthfeel, sweetness, balance, and saltiness, and also masks

Table 7-4 Taste Sensations of Salts

<i>Taste</i>	<i>Salts</i>
Salty	LiCl, LiBr, LiI, NaNO ₃ , NaCl, NaBr, NaI, KNO ₃ , KCl
Salty and bitter	KBr, NH ₄ I
Bitter	CsCl, CsBr, KI, MgSO ₄
Sweet	Lead acetate, ¹ beryllium acetate ¹

¹Extremely toxic

or decreases off-notes. Salt substitutes based on potassium chloride do not enhance mouthfeel or balance and increase bitter or metallic off-notes.

Bitter Taste

Bitter taste is characteristic of many foods and can be attributed to a great variety of inorganic and organic compounds. Many substances of plant origin are bitter. Although bitter taste by itself is usually considered to be unpleasant, it is a component of the taste of many foods, usually those foods that are sweet or sour. Inorganic salts can have a bitter taste (Table 7-4). Some amino acids may be bitter (Table 7-1). Bitter peptides may be formed during the partial enzymic hydrolysis of proteins—for example, during the ripening of cheese. Solms (1969) has given a list of peptides with different taste sensations (Table 7-5).

The compounds best known for their bitter taste belong to the alkaloids and glycosides. Alkaloids are basic nitrogen-containing organic compounds that are derived from pyridine, pyrrolidine, quinoline, isoquinoline, or purine. Quinine is often used as a standard for testing bitterness (Figure 7-13).

The bitterness of quinine hydrochloride is detectable in a solution as dilute as 0.00004 molar, or 0.0016 percent. If 5 mL of this solution is tasted, the amount of substance a person detects would be 0.08 mg (Moncrieff 1951). Our sensitivity to bitterness is more extreme than our sensitivity to other tastes; the order of sensitivity is from bitter to sour to salty and our least sensitivity is to sweet taste. Threshold values reported by Moncrieff are as follows: sour—0.007 percent HCl; salt—0.25 percent NaCl; and sweet—0.5 percent sucrose. If the artificial sweeteners such as saccharine are considered, the sweet sensitivity is second to bitter. Quinine is used as a component of some soft drinks to produce bitterness. Other alkaloids occurring as natural bitter constituents of foods are caffeine and theobromine (Figure 7-14), which are derivatives of purine. Another naturally occurring bitter substance is the glycoside naringin, which occurs in grapefruit and some other citrus fruits. Naringin in pure form is more bitter than quinine and can be detected in concen-

Table 7-5 Taste of Some Selected Peptides

<i>Taste</i>	<i>Composition of Peptides</i>
Flat	L-Lys-L-Glu, L-Phe-L-Phe, Gly-Gly-Gly-Gly
Sour	L-Ala-L-Asp, γ -L-Glu-L-Glu, Gly-L-Asp-L-Ser-Gly
Bitter	L-Leu-L-Leu, L-Arg-L-Pro, L-Val-L-Val-L-Val
Sweet	L-Asp-L-Phe-OMe, L-Asp-L-Met-OMe
Biting	γ -L-Glutamyl-S-(prop-1-enyl)-L-cystein

Source: From J. Solms, *Nonvolatile Compounds and the Flavor of Foods*, in *Gustation and Olfaction*, G. Ohloff and A.F. Thomas, eds., 1971, Academic Press.

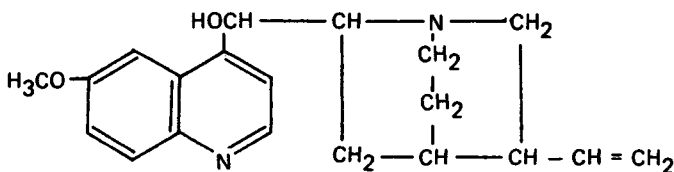

Figure 7-13 Structure of Quinine. This has an intensely bitter taste.

trations of less than 0.002 percent. Naringin (Figure 7-15) contains the sugar moiety rutinose (L-rhamnose-D-glucose), which can be removed by hydrolysis with boiling mineral acid. The aglucone is called naringenin, and it lacks the bitterness of naringin. Since naringin is only slightly soluble in water (0.05 percent at 20°C), it may crystallize out when grapefruit is subjected to below-freezing temperatures. Hesperidin (Figure 7-15) occurs widely in citrus fruits and is also a rutinose glycoside. It occurs in oranges and lemons. Dried orange peel may contain as much as 8 percent hesperidin. The aglycone of hesperidin is called hesperetin. The sugar moiety is attached to carbon 7. Horowitz and Gentili (1969) have studied the relationship between bitterness and the structure of 7-rhamnoglucosides of citrus fruits; they found that the structure of the disaccharide moiety plays an important role in bitterness. The point of attachment of rhamnose to glucose determines whether the substance will be bitter or tasteless. Thus, neohesperidin contains the disaccharide neohesperidose, which contains rham-

nose linked 1→2 to glucose; therefore, the sugar moiety is 2-O-α-L-rhamnopyranosyl-D-glucose. Glycosides containing this sugar, including neohesperidin, have a bitter taste. When the linkage between rhamnose and glucose is 1→6, the compound is tasteless as in hesperidin, where the sugar part, rutinose, is 6-O-α-L-rhamnopyranosyl-D-glucose.

Bitterness occurs as a defect in dairy products as a result of casein proteolysis by enzymes that produce bitter peptides. Bitter peptides are produced in cheese because of an undesirable pattern of hydrolysis of milk casein (Habibi-Najafi and Lee 1996). According to Ney (1979), bitterness in amino acids and peptides is related to hydrophobicity. Each amino acid has a hydrophobicity value (Δf), which is defined as the free energy of transfer of the side chains and is based on solubility properties (Table 7-6). The average hydrophobicity of a peptide, Q , is obtained as the sum of the Δf of component amino acids divided by the number of amino acid residues. Ney (1979) reported that bitterness is found only in peptides with molecular weights

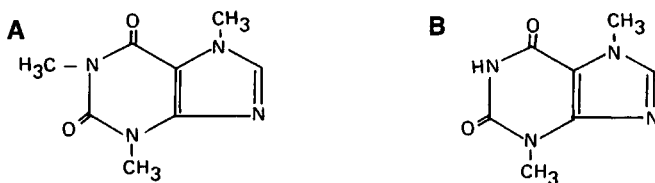

Figure 7-14 (A) Caffeine and (B) Theobromine

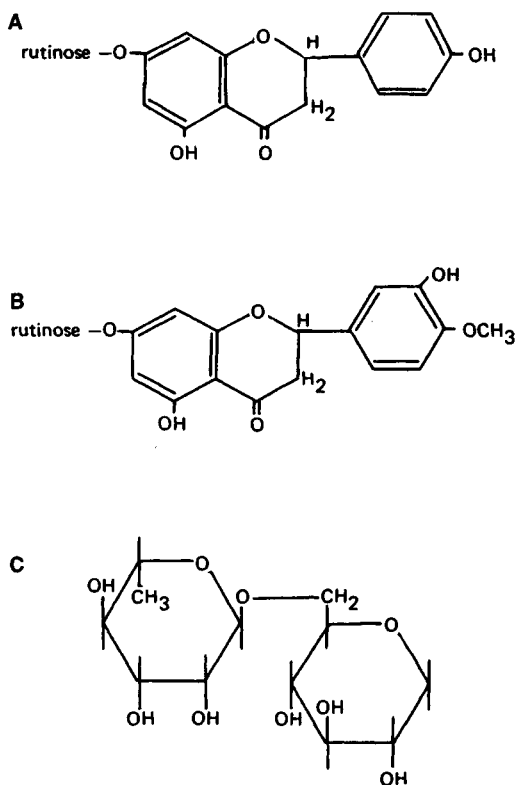

Figure 7-15 (A) Naringin; (B) Hesperidin; (C) Rutinose, 6-*O*- α -L-Rhamnopyranosyl-D-Glucopyranose

below 6,000 Da when their Q value is greater than 1,400. These findings indicate the importance of molecular weight and hydrophobicity. In a more detailed study of the composition of bitter peptides, Kanehisa (1984) reported that at least six amino acids are required for strong bitterness. A bitter peptide requires the presence of a basic amino acid at the N-terminal position and a hydrophobic one at the C-terminal position. It appears that at least two hydrophobic amino acids are required in the C-terminal area of the peptide to produce intense bitterness. The high hydrophobicity of leucine and the number of leu-

Table 7-6 Hydrophobicity Values (Δf) of the Side Chains of Amino Acids

Amino Acid	Abbreviation	Δf (cal/mol)
Glycine	Gly	0
Serine	Ser	40
Threonine	Thr	440
Histidine	His	500
Aspartic acid	Asp	540
Glutamic acid	Glu	550
Arginine	Arg	730
Alanine	Ala	730
Methionine	Met	1,300
Lysine	Lys	1,500
Valine	Val	1,690
Leucine	Leu	2,420
Proline	Pro	2,620
Phenylalanine	Phe	2,650
Tyrosine	Tyr	2,870
Isoleucine	Ile	2,970
Tryptophan	Trp	3,000

Source: Reprinted with permission from K.H. Ney, Bitterness of Peptides: Amino Acid Composition and Chain Length, in *Food Taste Chemistry*, J.C. Boudreau, ed., ACS Symp. Ser. 115, © 1979, American Chemical Society.

cine and possibly proline residues in the peptide probably play a role in the bitterness.

Other Aspects of Taste

The basic sensations—sweet, sour, salty, and bitter—account for the major part of the taste response. However, it is generally agreed that these basic tastes alone cannot completely describe taste. In addition to the four individual tastes, there are important interrelationships among them. One of the most important in foods is the interrelationship between sweet and sour. The sugar-acid

ratio plays an important part in many foods, especially fruits. Kushman and Ballinger (1968) have demonstrated the change in sugar-acid ratio in ripening blueberries (Table 7-7). Sugar-acid ratios play an important role in the flavor quality of fruit juices and wines (Ough 1963). Alkaline taste has been attributed to the hydroxyl ion. Caustic compounds can be detected in solutions containing only 0.01 percent of the alkali. Probably the major effect of alkali is irritation of the general nerve endings in the mouth. Another effect that is difficult to describe is astringency. Borax is known for its ability to produce this effect, as are the tannins present in foods, especially those that occur in tea. Even if astringency is not considered a part of the taste sense, it must still be considered a feature of food flavor.

Another important taste sensation is coolness, which is a characteristic of menthol. The cooling effect of menthol is part of the mint flavor complex and is exhibited by only some of the possible isomeric forms. Only (-) and (+) menthol show the cooling effect, the former to a higher degree than the latter, but

the isomers isomenthol, neomenthol, and neoisomenthol do not give a cooling effect (Figure 7-16) (Kulka 1967). Hotness is a property associated with spices and is also referred to as pungency. The compound primarily responsible for the hotness of black pepper is piperine (Figure 7-17). In red pepper or capsicum, nonvolatile amides are responsible for the heat effect. The heat effect of spices and their constituents can be measured by an organoleptic threshold method (Rogers 1966) and expressed in heat units. The pungent principle of capsicum is capsaicin. The structure of capsaicin is given in Figure 7-18. Capsaicin shows similarity to the compound zingerone, the pungent principle of ginger (Figure 7-19).

Govindarajan (1979) has described the relationship between pungency and chemical structure of pungent compounds. There are three groups of natural pungent compounds—the capsaicinoids, piperine, and the gingerols. These have some common structural aspects, including an aromatic ring and an alkyl side chain with a carbonyl function (Figures 7-18 and 7-19). Structural variations in these compounds affect the intensity of the pungent response. These structural variations include the length of the alkyl side chain, the position of the amide group near the polar aromatic end, the nature of the groupings at the alkyl end, and the unsaturation of the alkyl chain.

The metallic taste has been described by Moncrieff (1964). There are no receptor sites for this taste or for the alkaline and meaty tastes. However, according to Moncrieff, there is no doubt that the metallic taste is a real one. It is observable over a wide area of the surface of the tongue and mouth and, like irritation and pain, appears to be a modality of the common chemical sense. The metallic taste can be generated by salts of metals such

Table 7-7 Change in Sugar-Acid Ratio During Ripening of Blueberries*

	<i>Unripe</i>	<i>Ripe</i>	<i>Overripe</i>
Total sugar (%)	5.8	7.9	12.4
pH	2.83	3.91	3.76
Titration acidity (mEq/100 g)	23.9	12.9	7.5
Sugar-acid ratio	3.8	9.5	25.8

*The sugars are mainly glucose and fructose, and the acidity is expressed as citric acid.

Source: From L.J. Kushman and W.E. Ballinger, Acid and Sugar Changes During Ripening in Wolcott Blueberries, *Proc. Amer. Soc. Hort. Soc.*, Vol. 92, pp. 290-295, 1968.

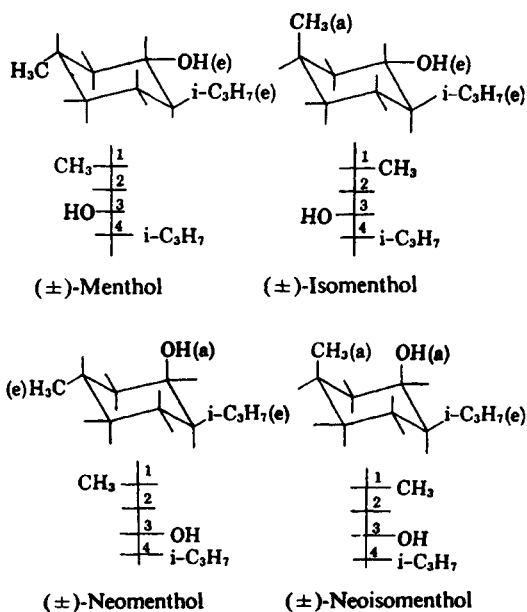

Figure 7-16 Isomeric Forms of Menthol

as mercury and silver (which are most potent) but normally by salts of iron, copper, and tin. The threshold concentration is in the order of 20 to 30 ppm of the metal ion. In canned foods, considerable metal uptake may occur and the threshold could be

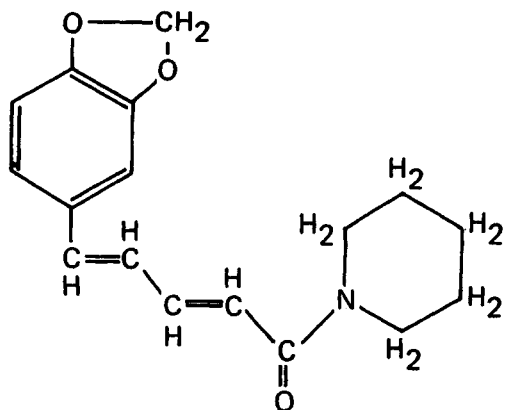

Figure 7-17 Piperine, Responsible for the Hotness of Pepper

exceeded in such cases. Moncrieff (1964) also mentions the possibility of metallic ion exchange between the food and the container. The threshold concentration of copper is increased by salt, sugar, citric acid, and alcohol. Tannin, on the other hand, lowers the threshold value and makes the copper taste more noticeable. The metallic taste is frequently observed as an aftertaste. The lead salt of saccharin gives an impression of intense sweetness, followed by a metallic aftertaste. Interestingly, the metallic taste is frequently associated with oxidized products. Tressler and Joslyn (1954) indicate that 20 ppm of copper is detectable by taste in orange juice. Copper is well known for its ability to catalyze oxidation reactions. Stark and Forss (1962) have isolated and identified oct-1-en-3-one as the compound responsible for the metallic flavor in dairy products.

Taste Inhibition and Modification

Some substances have the ability to modify our perception of taste qualities. Two such compounds are gymnemagenin, which is able to suppress the ability to taste sweetness, and the protein from miracle fruit, which changes the perception of sour to sweet. Both compounds are obtained from tropical plants.

The leaves of the tropical plant *Gymnema sylvestre*, when chewed, suppress the ability to taste sweetness. The effect lasts for hours, and sugar seems like sand in the mouth. The ability to taste other sweeteners such as saccharin is equally suppressed. There is also a decrease in the ability to taste bitterness. The active principle of leaves has been named gymnemic acid and has been found (Stöcklin et al. 1967) to consist of four components, designated as gymnemic acids, A₁, A₂, A₃, and A₄. These are D-glucuronides of acety-

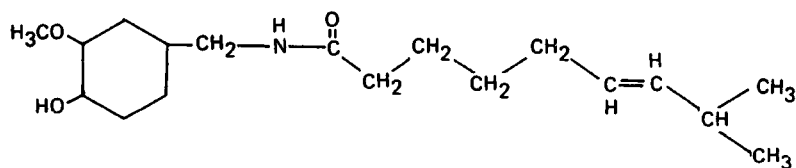

Figure 7-18 Capsaicin, the Pungent Principle of Red Pepper

lated gymnemagenins. The unacetylated gymnemagenin is a hexahydroxy pentacyclic triterpene; its structure is given in Figure 7-20.

The berries of a West African shrub (*Synsepalum dulcificum*) contain a substance that has the ability to make sour substances taste sweet. The berry, also known as miracle fruit, has been shown to contain a taste-modifying protein (Kurihara and Beidler 1968; 1969). The protein is a basic glycoprotein with a molecular weight of 44,000. It is suggested that the protein binds to the receptor membrane near the sweet receptor site. The low pH changes the conformation of the membrane so that the sugar part of the protein fits into the sweet receptor site. The taste-modifying protein was found to contain 6.7 percent of arabinose and xylose.

These taste-modifying substances provide an insight into the mechanism of the production of taste sensations and, therefore, are a valuable tool in the study of the interrelationship between taste and chemical structure.

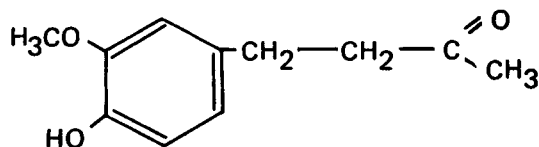

Figure 7-19 Zingerone, the Pungent Principle of Ginger

Flavor Enhancement—Umami

A number of compounds have the ability to enhance or improve the flavor of foods. It has often been suggested that these compounds do not have a particular taste of their own. Evidence now suggests that there is a basic taste response to amino acids, especially glutamic acid. This taste is sometimes described by the word *umami*, derived from the Japanese for deliciousness (Kawamura and Kare 1987). It is suggested that a primary taste has the following characteristics:

- The receptor site for a primary taste chemical is different from those of other primary tastes.
- The taste quality is different from others.
- The taste cannot be reproduced by a mixture of chemicals of different primary tastes.

From these criteria, we can deduce that the glutamic acid taste is a primary taste for the following reasons:

- The receptor for glutamic acid is different from the receptors for sweet, sour, salty, and bitter.
- Glutamic acid does not affect the taste of the four primary tastes.
- The taste quality of glutamic acid is different from that of the four primary tastes.

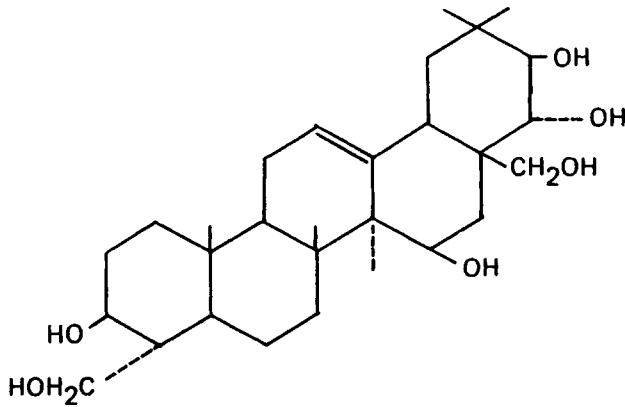

Figure 7-20 Structure of Gymnemagenin

- Umami cannot be reproduced by mixing any of the four primary tastes.

Monosodium glutamate has long been recognized as a flavor enhancer and is now being considered a primary taste, umami. The flavor potentiation capacity of monosodium glutamate in foods is not the result of an intensifying effect of the four primary tastes. Glutamate may exist in the L and D forms and as a racemic mixture. The L form is the naturally occurring isomer that has a flavor-enhancing property. The D form is inert. Although glutamic acid was first isolated in 1866, the flavor-enhancing properties of the sodium salt were not discovered until 1909 by the Japanese chemist Ikeda. Almost immediately, commercial production of the compound started and total production for the year 1954 was estimated at 13,000,000 pounds. The product as first described by Ikeda was made by neutralizing a hydrolysate of the seaweed *Laminaria japonica* with soda. Monosodium glutamate is now produced from wheat gluten, beet sugar waste, and soy protein and is used in the form of the pure crystallized compound. It can also be used in the form of protein

hydrolysates derived from proteins that contain 16 percent or more of glutamic acid. Wheat gluten, casein, and soy flour are good sources of glutamic acid and are used to produce protein hydrolysates. The glutamic acid content of some proteins is listed in Table 7-8 (Hall 1948). The protein is hydrolyzed with hydrochloric acid, and the neutralized hydrolysate is used in liquid form or as a dry powder. Soy sauce, which is similar to these hydrolysates, is produced wholly or partially by enzymic hydrolysis. This results in the formation of ammonia from acid amides; soy sauce contains ammonium complexes of amino acids, including ammonium glutamate.

The flavor of glutamate is difficult to describe. It has sometimes been suggested that glutamate has a meaty or chickeny taste, but it is now generally agreed that glutamate flavor is unique and has no similarity to meat. Pure sodium glutamate is detectable in concentrations as low as 0.03 percent; at 0.05 percent the taste is very strong and does not increase at higher concentrations. The taste has been described (Crocker 1948) as a mixture of the four tastes. At about 2 threshold values of glutamate concentration, it could

Table 7-8 Glutamic Acid Content of Some Proteins

<i>Protein Source</i>	<i>Glutamic Acid (%)</i>
Wheat gluten	36.0
Corn gluten	24.5
Zein	36.0
Peanut flour	19.5
Cottonseed flour	17.6
Soybean flour	21.0
Casein	22.0
Rice	24.1
Egg albumin	16.0
Yeast	18.5

Source: From L.A. Hall, Protein Hydrolysates as a Source of Glutamate Flavors, in *Monosodium Glutamate—A Symposium*, 1948, Quartermaster Food and Container Institute for the Armed Forces.

be well matched by a solution containing 0.6 threshold of sweet, 0.7 of salty, 0.3 of sour, and 0.9 of bitter. In addition, glutamate is said to cause a tingling feeling and a marked persistency of taste sensation. This feeling is present in the whole of the mouth and provides a feeling of satisfaction or fullness. Apparently glutamate stimulates our tactile sense as well as our taste receptors. The presence of salt is required to produce the glutamate effect. Glutamate taste is most effective in the pH range of 6 to 8 and decreases at lower pH values. Sugar content also affects glutamate taste. The taste in a complex food, therefore, depends on a complex interaction of sweet, sour, and salty, as well as the added glutamate.

Monosodium glutamate improves the flavor of many food products and is therefore widely used in processed foods. Products benefiting from the addition of glutamate

include meat and poultry, soups, vegetables, and seafood.

For many years glutamate was the only known flavor enhancer, but recently a number of compounds that act similarly have been discovered. The 5'-nucleotides, especially 5'-inosinate and 5'-guanylate, have enhancement properties and also show a synergistic effect in the presence of glutamate. This synergistic effect has been demonstrated by determining the threshold levels of the compounds alone and in mixtures. The data in Table 7-9 are quoted from Kuninaka (1966). The 5'-nucleotides were discovered many years ago in Japan as components of dried bonito (a kind of fish). However, they were not produced commercially and used as flavor enhancers until recently, when technical problems in their production were solved. The general structure of the nucleotides with flavor activity is presented in Figure 7-21. There are three types of inosinic acid, 2', 3', and 5'-isomers; only the 5'-isomer has flavor activity. Both riboside and 5'-phosphomonoester linkages are required for flavor activity, which is also the case for the OH group at the 6-position of the ring. Replacing the OH group with other groups, such as an amino group, sharply reduces flavor activity but this is not true for the group at the 2-position. Hydrogen at the 2-position corresponds with inosinate and an amino group with guanylate; both have comparable flavor activity, and the effect of the two compounds is additive.

The synergistic effect of umami substances is exceptional. The subjective taste intensity of a blend of monosodium glutamate and disodium 5'-inosinate was found to be 16 times stronger than that of the glutamate by itself at the same total concentration (Yamaguchi 1979).

Table 7-9 Threshold Levels of Flavor Enhancers Alone and in Mixtures in Aqueous Solution

Solvent	Threshold Level (%)		
	Disodium 5'-Inosinate	Disodium 5'-Guanylate	Monosodium L-Glutamate
Water	0.012	0.0035	0.03
0.1% glutamate	0.0001	0.00003	—
0.01% inosinate	—	—	0.002

Source: From A. Kuninaka, Recent Studies of 5'-Nucleotides as New Flavor Enhancers, in *Flavor Chemistry*, I. Hornstein, ed., 1966, American Chemical Society.

5'-nucleotides can be produced by degradation of ribonucleic acid. The problem is that most enzymes split the molecule at the 3'-phosphodiester linkages, resulting in nucleotides without flavor activity. Suitable enzymes were found in strains of *Penicillium* and *Streptomyces*. With the aid of these enzymes, the 5'-nucleotides can be manufactured industrially from yeast ribonucleic

acid. Another process produces the nucleoside inosine by fermentation, followed by chemical phosphorylation to 5'-inosinic acid (Kuninaka 1966).

The search for other flavor enhancers has brought to light two new amino acids, tricholomic acid and ibotenic acid, obtained from fungi (Figure 7-22). These amino acids have flavor activities similar to that of monosodium glutamate. Apparently, the flavor enhancers can be divided into two groups; the first consists of 5'-inosinate and 5'-guanylate with the same kind of activity and an additive relationship. The other group consists of glutamate, tricholomic, and ibotenic acid, which are additive in action. Between the members of the two groups, the activity is synergistic.

A different type of flavor enhancer is maltol, which has the ability to enhance sweetness produced by sugars. Maltol is formed during roasting of malt, coffee, cacao, and grains. During the baking process, maltol is formed in the crust of bread. It is also found in many dairy products that have been heated, as a product of decomposition of the casein-lactose system. Maltol (Figure 7-23) is formed from di-, tri-, and tetrasaccharides including isomaltose, maltotetraose, and

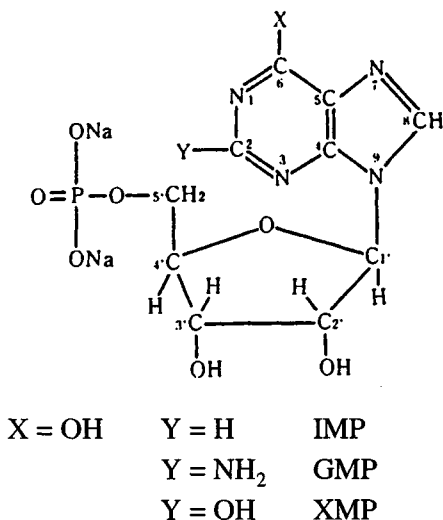

Figure 7-21 Structure of Nucleotides with Flavor Activity

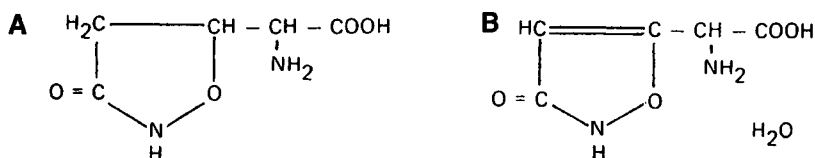

Figure 7-22 (A) Tricholomic and (B) Ibotenic Acid

panose but not from maltotriose. Formation of maltol is brought about by high temperatures and is catalyzed by metals such as iron, nickel, and calcium.

Maltol has antioxidant properties. It has been found to prolong storage life of coffee and roasted cereal products. Maltol is used as a flavor enhancer in chocolate and candies, ice cream, baked products, instant coffee and tea, liqueurs, and flavorings. It is used in concentrations of 50 to 250 ppm and is commercially produced by a fermentation process.

ODOR

The olfactory mechanism is both more complex and more sensitive than the process of gustation. There are thousands of odors, and the sensitivity of the smell organ is about 10,000 times greater than that of the taste organ. Our understanding of the odor receptor's mechanism is very limited, and there is no single, generally accepted theory accounting for the relationship between molecular structure and odor. The odorous substance arrives at the olfactory tissue in the nasal cavity, contained in a stream of air. This method of sensing requires that the odorous compound be volatile. Most odorous compounds are soluble in a variety of solvents, but it appears that solubility is less important than type of molecular arrangement, which confers both solubility and chemical reactiv-

ity (Moncrieff 1951). The number of volatile compounds occurring in foods is very high. Maarse (1991) has given the following numbers for some foods: beef (boiled, cooked)—486; beer—562; butter—257; coffee—790; grape—466; orange—203; tea—541; tomato—387; and wine (white)—644. Not all of these substances may be essential in determining the odor of a product. Usually, the relative amounts of a limited number of these volatile compounds are important in establishing the characteristic odor and flavor of a food product.

The sensitivity of the human olfactory organ is inferior to that of many animals. Dogs and rats can detect odorous compounds at threshold concentrations 100 times lower than man. When air is breathed in, only a small part of it is likely to flow over the olfactory epithelium in the upper nasal cavity. When a smell is perceived, sniffing may increase the amount reaching the olfactory tissue. When foods are eaten, the passage of breath during exhalation reaches the nasal cavity from the back. Döving (1967) has quoted the threshold concentrations of odorous substances listed in Table 7-10. Apparently, it is possible to change odor thresholds by a factor of 100 or more by stimulating the sympathetic nervous system so that more odor can reach the olfactory tissue. What is remarkable about the olfactory mechanism is not only that thousands of odors can be recognized, but that it is possible to store the

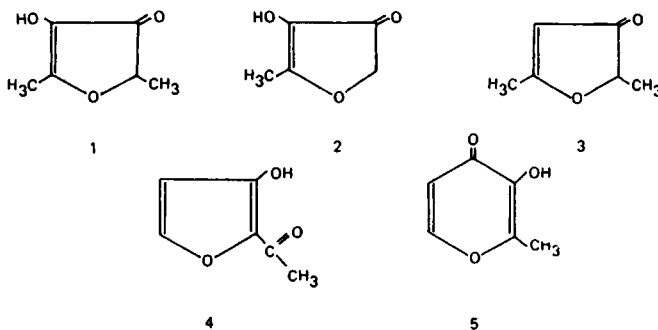

Figure 7-23 Some Furanones (1,2,3), Isomaltol (4), and Maltol (5)

information in the brain for retrieval after long periods of time. The ability to smell is affected by several conditions, such as colds, menstrual cycle, and drugs such as penicillin. Odors are usually the result of the presence of mixtures of several, sometimes many, different odorous compounds. The combined effect creates an impression that may be very

different from that of the individual components. Many food flavors, natural as well as artificial, are of this compound nature.

Odor and Molecular Structure

M. Stoll wrote in 1957: "The whole subject of the relation between molecular structure and odor is very perplexing, as there is no doubt that there exist as many relationships of structure and odor as there are structures of odorous substances." In 1971 (referring to Stoll 1957), Teranishi wrote: "The relation between molecular structure and odor was perplexing then. It is now." We can observe a number of similarities between the chemical structure of compounds and their odors. However, the field of food flavors, as is the field of perfumery, is still very much an art, albeit one greatly supported by scientists' advancing ability to classify structures and identify the effect of certain molecular configurations. The odor potency of various compounds ranges widely. Table 7-11 indicates a range of about eight orders of magnitude (Teranishi 1971). This indicates that volatile flavor compounds may be present in greatly differing quantities, from traces to relatively large amounts.

The musks are a common illustration of compounds with different structures that all

Table 7-10 Odor Threshold Concentrations of Odorous Substances Perceived During Normal Inspiration

Compound	Threshold Concentration (Molecules/cc)
Allyl mercaptan	6×10^7
Sec. butyl mercaptan	1×10^8
Isopropyl mercaptan	1×10^8
Isobutyl mercaptan	4×10^8
Tert. butyl mercaptan	6×10^8
Thiophenol	8×10^8
Ethyl mercaptan	1×10^9
1,3-Xylen-4-ol	2×10^{12}
μ -Xylene	2×10^{12}
Acetone	6×10^{13}

Source: From K.B. Döving, Problems in the Physiology of Olfaction, in *Symposium on Foods: The Chemistry and Physiology of Flavors*, H.W. Schultz et al., eds., 1967, AVI Publishing.

Table 7-11 Odor Thresholds of Compounds Covering a Wide Range of Intensity

Odorant	Threshold ($\mu\text{g/L}$ of Water)
Ethanol	100,000
Butyric acid	240
Nootkatone	170
Humulene	160
Myrcene	15
<i>n</i> -Amyl acetate	5
<i>n</i> -Decanal	0.0
α - and β -Sinensal	0.05
Methyl mercaptan	0.02
β -Ionone	0.007
2-methoxy-3-isobutylpyrazine	0.002

Source: From R. Teranishi, *Odor and Molecular Structure*, in *Gustation and Olfaction*, G. Ohloff and A.F. Thomas, eds., 1971, Academic Press.

give similar odors. These may include tricyclic compounds, macrocyclic ketones and lactones, steroids, nitrocyclohexanes, indanes, tetrahydronaphthalenes, and acetophenoses. Small changes in the structure of these molecules may significantly change in potency but will not affect quality, since all are musky. There are also some compounds that have similar structures and very different odors, such as nootkatone and related compounds (Teranishi 1971). Nootkatone is a flavor compound from grapefruit oil. This compound and 1,10-dihydronootkatone have a grapefruity flavor (Figure 7-24). Several other related compounds have a woody flavor. The odor character of stereoisomers may be quite different. The case of menthol has already been described. Only menthol isomers have peppermint aroma. The iso-, neo-, and neoisomenthols have an unpleasant musty flavor. Naves (1957) describes the

difference between the *cis*- and *trans*- forms of 3-hexenol ($\text{CH}_2\text{OH}-\text{CH}_2-\text{CH}=\text{CH}-\text{CH}_2\text{CH}_3$). The *cis*-isomer has a fresh green odor, whereas the *trans*-isomer has a scent reminiscent of chrysanthemum. The 2-*trans*-6-*cis* nonadienal smells of cucumber and is quite different from the smell of the 2-*trans*-6-*trans* isomer (nonadienal, $\text{CHO}-\text{CH}=\text{CH}-(\text{CH}_2)_2-\text{CH}=\text{CH}-\text{CH}_2-\text{CH}_3$). Lengthening of the carbon chain may affect odorous properties. The odor of saturated acids changes remarkably as chain length increases. The lower fatty acids, especially butyric, have very intense and unpleasant flavors, because an increased chain length changes flavor character (Table 7-12) and lessens intensity. The fatty acids with 16 or 18 carbon atoms have only a faint flavor.

Another example is given by Kulka (1967). Gamma-nonolactone has a strong coconut-like flavor; γ -undecalactone has a peach aroma. As the chain length is increased by one more carbon atom, the flavor character becomes peach-musk. The lactones are compounds of widely differing structure and odor quality and are found as components of many food flavors. Gamma- and δ -lactones with 10 to 16 carbon atoms have been reported (Juriens and Oele 1965) as flavor components of butter, contributing to the butter flavor in concentrations of only parts per million. The flavor character and chemical structure of some γ -lactones as reported by Teranishi (1971) are shown in Figure 7-25. One of these, the γ -lactone with a total chain length of 10 carbons, has peach flavor. The α -hydroxy- β -methyl- γ -carboxy- $\Delta^{\alpha-\beta}$ - γ -hexeno-lactone occurs in protein hydrolysate and has very strong odor and flavor of beef bouillon. Gold and Wilson (1963) found that the volatile flavor compounds of celery contain a number of phthalides (phthalides are lactones of phthalic acid, lactones are inter-

nal esters of hydroxy acids). These include the following:

- 3-isobutyliden-3a,4-dihydrophthalide (Figure 7-26)
- 3-isovalidene-3a,4-dihydrophthalide
- 3-isobutylidene phthalide
- 3-isovalidene phthalide

These compounds exhibit celery-like odors at levels of 0.1 ppm in water. Pyrazines have been identified as the compounds giving the characteristic intense odor of green peppers (Seifert et al. 1970). A number of pyrazine derivatives were tested and, within this single class of compounds, odor potencies showed a range of eight orders of magnitude equal to that of the widely varying compounds listed in Table 7-11. The compounds examined by Seifert et al. (1970) are listed in Table 7-13. 2-methoxy-3-isobutylpyrazine appears to be the compound responsible for the green pepper odor. Removal of the methoxy- or alkyl-

groups reduces the odor potency by 10^5 to 10^6 times, as is the case with 2-methoxypyrazine, 2-isobutylpyrazine, and 2,5-dimethylpyrazine. Thus, small changes in molecular structure may greatly affect flavor potency. The odors of isobutyl, propyl, and hexyl methoxypyrazines are similar to that of green peppers. The isopropyl compound is moderately similar to peppers and its odor is somewhat similar to raw potato. The ethyl compound is even more similar to raw potato and less to pepper. In fact, this compound can be isolated from potatoes. The methyl compound has an odor like roasted peanuts. The structure of some of the pyrazines is shown in Figure 7-27. Pyrazines have been identified as flavor components in a number of foods that are normally heated during processing. Rizzi (1967) demonstrated the presence of seven alkyl-substituted pyrazines in chocolate aroma. These were isolated by steam distillation, separated by gas-liquid chromatography, and identified by mass spectrometry. The components are methyl pyra-

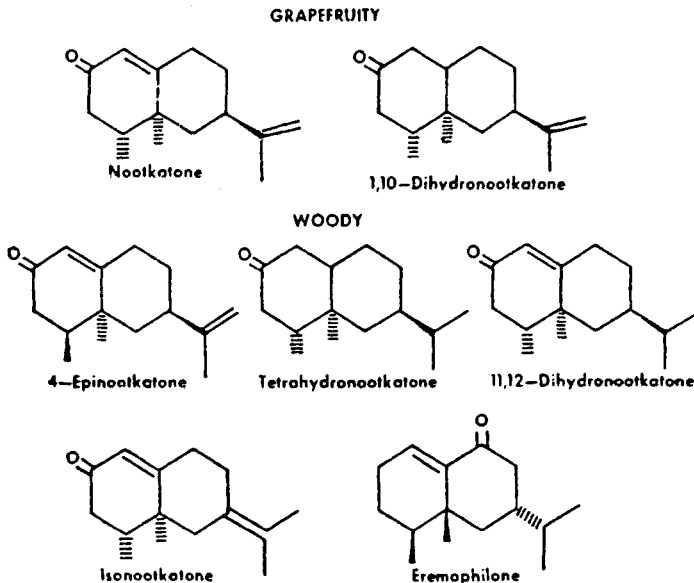

Figure 7-24 Odor Character of Nootkatone and Related Compounds

Table 7-12 Flavor Character of Some N-Carboxylic Acids

Acid	Flavor Character
Formic	Acid, pungent
Acetic	Acid, vinegary, pungent
Propionic	Acid, pungent, rancid, cheesy
Butyric	Acid, rancid
Hexanoic	Sweaty, goaty
Octanoic	Rancid
Decanoic	Waxy
Lauric	Tallowy
Myristic	Soapy, cardboard
Palmitic	Soapy

zine; 2,3-dimethylpyrazine; 2-ethyl-5-methylpyrazine; trimethylpyrazine; 2,5-dimethyl-3-ethylpyrazine; 2,6-dimethyl-3-ethylpyrazine; and tetramethylpyrazine. Other researchers (Flament et al. 1967; Marion et al. 1967) have isolated these and other pyrazines from the aroma components of cocoa. Pyrazines are also aroma constituents of coffee. Goldman et al. (1967) isolated and identified 24 pyrazines and pyridines and revealed the presence of possibly 10 more. Bondarovich et al. (1967) isolated and identified a large number of pyrazines from coffee aroma and drew

attention to the importance of pyrazines and dihydropyrazines to the flavor of roasted or otherwise cooked foods. These authors also drew attention to the instability of the dihydropyrazines. This instability not only makes their detection and isolation difficult, but may help explain why flavors such as that of roasted coffee rapidly change with time. Another roasted product from which pyrazines have been isolated is peanuts. Mason et al. (1966) found methylpyrazine; 2,5-dimethylpyrazine; trimethylpyrazine; methylethylpyrazine; and dimethylethylpyrazine in the flavor of roasted peanuts. The pyrazines appear to be present in unprocessed as well as in heated foods.

Another group of compounds that have been related to the aroma of heated foods is the furanones. Teranishi (1971) summarized the findings on several of the furanones (see Figure 7-23). The 4-hydroxy-2,5-dimethyl-3-dihydrofuranone (1) has a caramel or burnt pineapple odor. The 4-hydroxy-5-methyl-3-dihydrofuranone (2) has a roasted chicory root odor. Both compounds may contribute to beef broth flavor. The 2,5-dimethyl-3-dihydrofuranone (3) has the odor of freshly baked bread. Isomaltol (4) and maltol (5) are products of the caramelization and pyrolysis of carbohydrates.

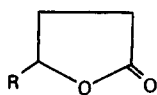

R = C₅H₁₁ (coconut)

R = C₆H₁₃ (peach)

R = C₇H₁₅ (peach)

R = C₈H₁₇ (peach-musk)

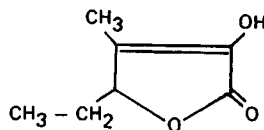

Beef bouillon

Figure 7-25 Flavor Character of Some Lactones. *Source:* From R. Teranishi, *Odor and Molecular Structure*, in *Gustation and Olfaction*, G. Ohloff and A.F. Thomas, eds., 1971, Academic Press.

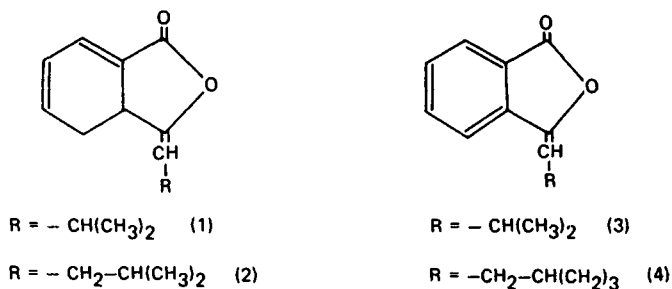

Figure 7-26 Phthalides of Celery Volatiles

Theories of Olfaction

When an odoriferous compound, or *odorivector*, arrives at the olfactory organ, a reaction takes place between the odor molecules and the chemoreceptors; this reaction pro-

duces a neural pulse, which eventually reaches the brain. The exact nature of the interaction between odorivector and chemoreceptor is not well known. The number of olfactory receptors in the smell organs is in the order of 100 million, and Moncrieff (1951) has calculated that the number of molecules at the threshold concentration of one of the powerful mercaptans in a sniff (about 20 mL) of air would be 1×10^{10} molecules. Obviously, only a fraction of these would interact with the receptors, but undoubtedly numerous interactions are required to produce a neural response. Dravnieks (1966) has indicated that according to information theory, 13 types of sensors are needed to distinguish 10,000 odors on a yes-or-no basis, but more than 20 might be required to respond rapidly and without error. Many attempts have been made to classify odors into a relatively small number of groups of related odors. These so-called primary odors have been used in olfaction theories to explain odor quality. One theory, the stereochemical site theory (Amoore et al. 1964; Amoore 1967), is based on molecular size and shape. Amoore compared the various odor qualities that have been used to characterize odors and concluded that seven primary odors would suffice to cover them all: camphoraceous, pungent, ethereal, floral,

Table 7-13 Odor Threshold of Pyrazine and Derivatives

Compound	Odor Threshold (Parts per 10^{12} Parts of Water)
2-methoxy-3-hexylpyrazine	1
2-methoxy-3-isobutylpyrazine	2
2-methoxy-3-propylpyrazine	6
2-methoxy-3-isopropylpyrazine	2
2-methoxy-3-ethylpyrazine	400
2-methoxy-3-methylpyrazine	4000
2-methoxypyrazine	700,000
2-isobutylpyrazine	400,000
2-5-dimethylpyrazine	1,800,000
pyrazine	175,000,000

Source: From R.M. Seifert et al., Synthesis of Some 2-Methoxy-3-Alkylpyrazines with Strong Bell Pepper-Like Odors, *J. Agr. Food Chem.*, Vol. 18, pp. 246-249, 1970, American Chemical Society.

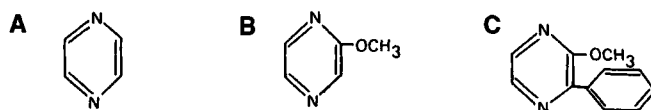

Figure 7-27 (A) Pyrazine, (B) 2-Methoxypyrazine, and (C) 2-Methoxy-3-Hexylpyrazine

pepperminty, musky, and putrid. Table 7-14 lists some of the chemical compounds that can be used to demonstrate these primary odors. The theory is based on the assumption that all odorous compounds have a distinctive molecular shape and size that fit into a socket on the receptor site. This would be similar to the "lock-and-key" concept of enzyme action. Five of the receptor sites would accept the flavor compound according to shape and size, and two (pungent and putrid) on the basis of electronic status (Figure 7-28). The site-fitting concept as initially proposed was inadequate because it assessed only one-half of the molecule; subsequent refinements considered all aspects of molecular surface in a "shadow-matching" technique (Amoore 1967). It was also suggested that there may be more than seven primaries. The primary odors may have to be split into subgroups and others added as new primaries. Molecular model silhouettes as developed for five primary odors are reproduced in Figure 7-29.

A membrane-puncturing theory has been proposed by Davis (Dravnieks 1967). According to this theory, the odorous substance molecules are adsorbed across the interface of the thin lipid membrane, which forms part of the cylindrical wall of the neuron in the chemoreceptor and the aqueous phase that surrounds the neuron. Adsorbed molecules orient themselves with the hydrophilic end toward the aqueous phase. When the adsorbed molecules are desorbed, they move into the aqueous phase, leaving a defect. Ions

may adsorb into this puncture and cause a neural response. This theory could be considered a thermodynamic form of the profile functional group concept, since the free energy of adsorption of the odor substance at the interface is related to shape, size, functional groups and their distribution, and position. The adsorption is a dynamic process with a free energy of adsorption of about 1 to 8 kcal/mole for different substances. Davies prepared a plot of molecular cross-sectional area versus free energy of adsorption and obtained a diagram (Figure 7-30) in which groups of related odors occupy distinct areas.

The suggestion that odorous character is related to vibrational specificity of odor molecules has led to the vibrational theory of olfaction (Wright 1957). Vibrational energy levels can be derived from the infrared or Raman spectra. The spectral area of greatest interest is that below 700 cm^{-1} , which is related to vibrations of chains and flexing or twisting of bonds between groups of atoms in the molecule. Wright and others have demonstrated that correlations exist between spectral properties and odor quality in a number of cases, but inconsistencies in other cases have yet to be explained.

Obviously, none of the many theories of olfaction proposed so far have been entirely satisfactory. It might be better to speak of hypotheses rather than of theories. Most of these theories deal with the explanation of odor quality and do not account for the quantitative aspects of the mechanism of olfaction. The classification of odor and the

Table 7-14 Primary Odors for Humans and Compounds Eliciting These Odors

Primary Odor	Odor Compounds
Camphoraceous	Borneol, <i>tert</i> -butyl alcohol <i>d</i> -camphor, cineol, pentamethyl ethyl alcohol
Pungent	Allyl alcohol, cyanogen, formaldehyde, formic acid, methylisothiocyanate
Ethereal	Acetylene, carbon tetrachloride, chloroform, ethylene dichloride, propyl alcohol
Floral	Benzyl acetate, geraniol, α -ionone, phenylethyl alcohol, terpineol
Pepperminty	<i>tert</i> -butylcarbinol, cyclohexanone, menthone, piperitol, 1,1,3-trimethylcyclo-5-hexanone
Musky	Androstan-3 α -ol (strong), cyclohexadecanone, ethylene cebacate, 17-methylandrostan-3 α -ol, pentadecanolactone
Putrid	Amylmercaptan, cadaverine, hydrogen sulfide, indole (when concentrated, floral when dilute), skatole

Source: From J.E. Amoore et al., *The Stereochemical Theory of Odor*, *Sci. Am.*, Vol. 210, No. 2, pp. 42-49, 1964.

correlation of chemical structure and odor remain difficult to resolve.

Odor Description

An odor can be described by the combination of threshold value and odor quality. The threshold value, the lowest concentration that creates an odor impression, can be considered the intensity factor, whereas the odor quality describes the character of the aroma. As has been mentioned under olfactory theories, attempts at reducing the number of characteristic odor qualities to a small number have not been successful. In many cases, the aroma and flavor of a food can be related to the presence of one or a few compounds that create an impression of a particular food when smelled alone. Such compounds have been named *contributory flavor compounds* by Jennings and Sevenants (1964). Some such compounds are the pyrazines, which give the odor quality of green bell peppers; nootkatone for grapefruit; esters for fruits;

and nona-2-*trans*-6-*cis*-dienal for cucumbers (Forss et al. 1962). In a great number of other cases, there are no easily recognizable contributory flavor compounds, but the flavor seems to be the integrated impression of a large number of compounds.

Determining the threshold value is difficult because subthreshold levels of one compound may affect the threshold levels of another. Also, the flavor quality of a compound may be different at threshold level and at suprathreshold levels. The total range of perception can be divided into units that represent the smallest additional amount that can be perceived. This amount is called just noticeable difference (JND). The whole intensity scale of odor perception covers about 25 JNDs; this is similar to the number of JNDs that comprise the scale of taste intensity. Flavor thresholds for some compounds depend on the medium in which the compound is dispersed or dissolved. Patton (1964) found large differences in the threshold values of saturated fatty acids dissolved in water and in oil.

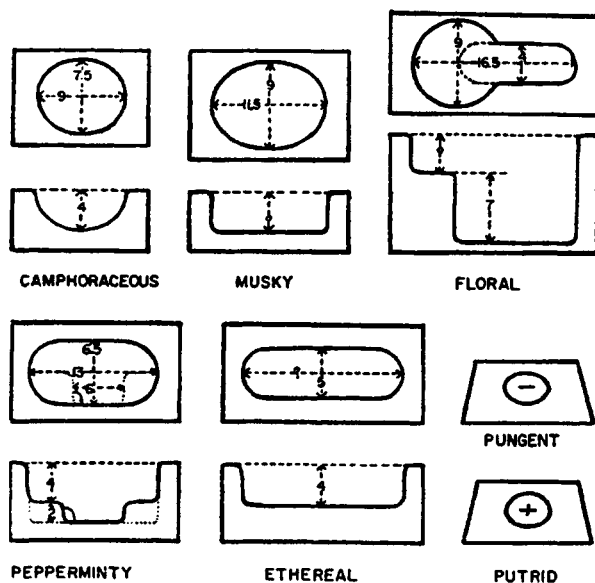

Figure 7-28 Olfactory Receptor Sites According to the Stereochemical Theory of Odor

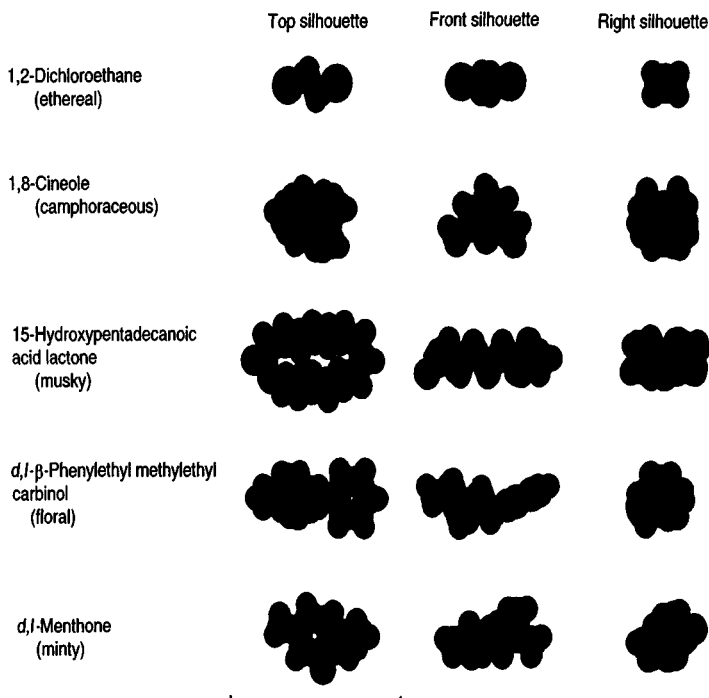

Figure 7-29 Molecular Model Silhouettes of Five Standard Odorants. *Source:* From J. Amoore, Stereochemical Theory of Olfaction, in *Symposium on Foods: The Chemistry and Physiology of Flavors*, H.W. Schultz et al., eds., 1967, AVI Publishing Co.

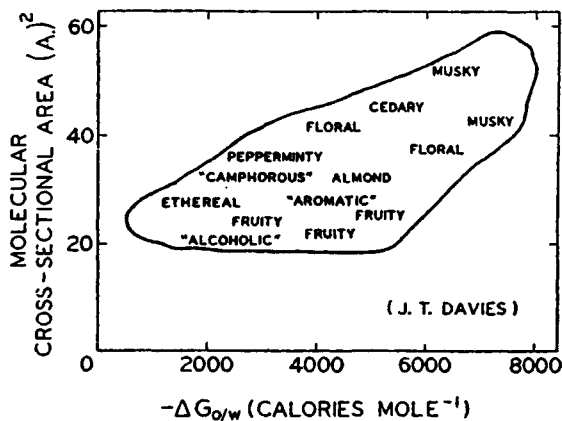

Figure 7-30 Plot of Molecular Cross-Sectional Area Versus Free Energy of Adsorption for Davies' Theory of Olfaction

DESCRIPTION OF FOOD FLAVORS

The flavor impression of a food is influenced by compounds that affect both taste and odor. The analysis and identification of many volatile flavor compounds in a large variety of food products have been assisted by the development of powerful analytical techniques. Gas-liquid chromatography was widely used in the early 1950s when commercial instruments became available. Introduction of the flame ionization detector increased sensitivity by a factor of 100 and, together with mass spectrometers, gave a method for rapid identification of many components in complex mixtures. These methods have been described by Teranishi et al. (1971). As a result, a great deal of information on volatile flavor components has been obtained in recent years for a variety of food products. The combination of gas chromatography and mass spectrometry can provide identification and quantitation of flavor compounds. However, when the flavor consists of many compounds, sometimes several hun-

dred, it is impossible to evaluate a flavor from this information alone. It is then possible to use pattern recognition techniques to further describe the flavor. The pattern recognition method involves the application of computer analysis of complex mixtures of compounds. Computer multivariate analysis has been used for the detection of adulteration of orange juice (Page 1986) and Spanish sheries (Maarse et al. 1987).

Flavors are often described by using the human senses on the basis of widely recognized taste and smell sensations. A proposed wine aroma description system is shown in Figure 7-31 (Noble et al. 1987). Such systems attempt to provide an orderly and reliable basis for comparison of flavor descriptions by different tasters.

The aroma is divided into first-, second-, and third-tier terms, with the first-tier terms in the center. Examination of the descriptors in the aroma wheel shows that they can be divided into two types, flavors and off-flavors. Thus, it would be more useful to divide the flavor wheel into two tables—one for fla-

Texture

INTRODUCTION

Food texture can be defined as the way in which the various constituents and structural elements are arranged and combined into a micro- and macrostructure and the external manifestations of this structure in terms of flow and deformation.

Most of our foods are complex physico-chemical structures and, as a result, the physical properties cover a wide range—from fluid, Newtonian materials to the most complex disperse systems with semisolid character. There is a direct relationship between the chemical composition of a food, its physical structure, and the resulting physical or mechanical properties; this relationship is presented in Figure 8–1. Food texture can be evaluated by mechanical tests (instrumental methods) or by sensory analysis. In the latter case, we use the human sense organs as analytical tools. A proper understanding of textural properties often requires study of the physical structure. This is most often accomplished by light and electron microscopy, as well as by several other physical methods. X-ray diffraction analysis provides information about crystalline structure, differential scanning calorimetry provides information about melting and solidification and other phase transitions, and particle size analysis

and sedimentation methods provide information about particle size distribution and particle shape.

In the study of food texture, attention is given to two interdependent areas: the flow and deformation properties and the macro- and microstructure. The study of food texture is important for three reasons:

1. to evaluate the resistance of products against mechanical action, such as in mechanical harvesting of fruits and vegetables
2. to determine the flow properties of products during processing, handling, and storage
3. to establish the mechanical behavior of a food when consumed

There is sometimes a tendency to restrict texture to the third area. The other two are equally important, although the first area is generally considered to belong in the domain of agricultural engineering.

Because most foods are complex disperse systems, there are great difficulties in establishing objective criteria for texture measurement. It is also difficult in many cases to relate results obtained by instrumental techniques of measurement to the type of response obtained by sensory panel tests.

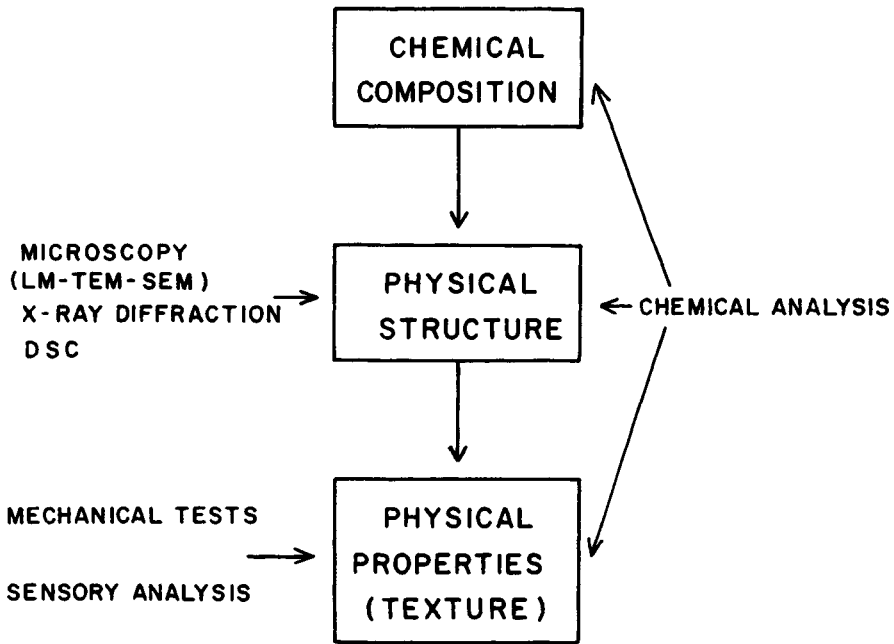

Figure 8-1 Interrelationships in Texture Studies. *Source:* From P. Sherman, A Texture Profile of Food-stuffs Based upon Well-Defined Rheological Properties, *J. Food Sci.*, Vol. 34, pp. 458-462, 1969.

The terms for the textural properties of foods have a long history. Many of the terms are accepted but are often poorly defined descriptive terms. Following are some examples of such terms:

- *Consistency* denotes those aspects of texture that relate to flow and deformation. It can be said to encompass all of the rheological properties of a product.
- *Hardness* has been defined as resistance to deformation.
- *Firmness* is essentially identical to hardness but is occasionally used to describe the property of a substance able to resist deformation under its own weight.
- *Brittleness* is the property of fracturing before significant flow has occurred.

- *Stickiness* is a surface property related to the adhesion between material and adjoining surface. When the two surfaces are of identical material, we use the term *cohesion*.

A variety of other words and expressions are used to describe textural characteristics, such as body, crisp, greasy, brittle, tender, juicy, mealy, flaky, crunchy, and so forth. Many of these terms have been discussed by Szczesniak (1963) and Sherman (1969); most have no objective physical meaning and cannot be expressed in units of measurement that are universally applicable. Kokini (1985) has attempted to relate some of these ill-defined terms to the physical properties involved in their evaluation. Through the

years, many types of instruments have been developed for measuring certain aspects of food texture. Unfortunately, the instruments are often based on empirical procedures, and results cannot be compared with those obtained with other instruments. Recently, instruments have been developed that are more widely applicable and are based on sound physical and engineering principles.

TEXTURE PROFILE

Texture is an important aspect of food quality, sometimes even more important than flavor and color. Szczesniak and Kleyn (1963) conducted a consumer-awareness study of texture and found that texture significantly influences people's image of food. Texture was most important in bland foods and foods that are crunchy or crisp. The characteristics most often referred to were hardness, cohesiveness, and moisture content. Several attempts have been made to develop a classification system for textural characteristics. Szczesniak (1963) divided textural characteristics into three main classes, as follows:

1. mechanical characteristics
2. geometrical characteristics
3. other characteristics, related mainly to moisture and fat content

Mechanical characteristics include five basic parameters.

1. *Hardness*—the force necessary to attain a given deformation.
2. *Cohesiveness*—the strength of the internal bonds making up the body of the product.
3. *Viscosity*—the rate of flow per unit force.

4. *Elasticity*—the rate at which a deformed material reverts to its undeformed condition after the deforming force is removed.
5. *Adhesiveness*—the work necessary to overcome the attractive forces between the surface of the food and the surface of other materials with which the food comes in contact (e.g., tongue, teeth, and palate).

In addition, there are in this class the three following secondary parameters:

1. *Brittleness*—the force with which the material fractures. This is related to hardness and cohesiveness. In brittle materials, cohesiveness is low, and hardness can be either low or high. Brittle materials often create sound effects when masticated (e.g., toast, carrots, celery).
2. *Chewiness*—the energy required to masticate a solid food product to a state ready for swallowing. It is related to hardness, cohesiveness, and elasticity.
3. *Gumminess*—the energy required to disintegrate a semisolid food to a state ready for swallowing. It is related to hardness and cohesiveness.

Geometrical characteristics include two general groups: those related to size and shape of the particles, and those related to shape and orientation. Names for geometrical characteristics include smooth, cellular, fibrous, and so on. The group of other characteristics in this system is related to moisture and fat content and includes qualities such as moist, oily, and greasy. A summary of this system is given in Table 8-1.

Based on the Szczesniak system of textural characteristics, Brandt et al. (1963) devel-

Table 8-1 Classification of Textural Characteristics**MECHANICAL CHARACTERISTICS**

<i>Primary Parameters</i>	<i>Secondary Parameters</i>	<i>Popular Terms</i>
Hardness		Soft → Firm → Hard
Cohesiveness	Brittleness	Crumbly → Crunchy → Brittle
	Chewiness	Tender → Chewy → Tough
	Gumminess	Short → Mealy → Pasty → Gummy
Viscosity		Thin → Viscous
Elasticity		Plastic → Elastic
Adhesiveness		Sticky → Tacky → Goopy

GEOMETRICAL CHARACTERISTICS

<i>Class</i>	<i>Examples</i>
Particle size and shape	Gritty, Grainy, Coarse, etc.
Particle shape and orientation	Fibrous, Cellular, Crystalline, etc.

OTHER CHARACTERISTICS

<i>Primary Parameters</i>	<i>Secondary Parameters</i>	<i>Popular Terms</i>
Moisture content		Dry → Moist → Wet → Watery
Fat content	Oiliness	Oily
	Greasiness	Greasy

Source: From A.S. Szczesniak, Classification of Textural Characteristics, *J. Food Sci.*, Vol. 28, pp. 385-389, 1963.

oped a method for profiling texture so that a sensory evaluation could be given that would assess the entire texture of a food. The texture profile method was based on the earlier development of the flavor profile (Cairncross and Sjöström 1950).

The Szczesniak system was critically examined by Sherman (1969), who proposed some modifications. In the improved system, no distinction is drawn among analytical, geometrical, and mechanical attributes. Instead, the only criterion is whether a charac-

teristic is a fundamental property or derived by a combination of two or more attributes in unknown proportions. The Sherman system contains three groups of characteristics (Figure 8-2). The primary category includes analytical characteristics from which all other attributes are derived. The basic rheological parameters, elasticity, viscosity, and adhesion form the secondary category; the remaining attributes form the tertiary category since they are a complex mixture of these secondary parameters. This system is

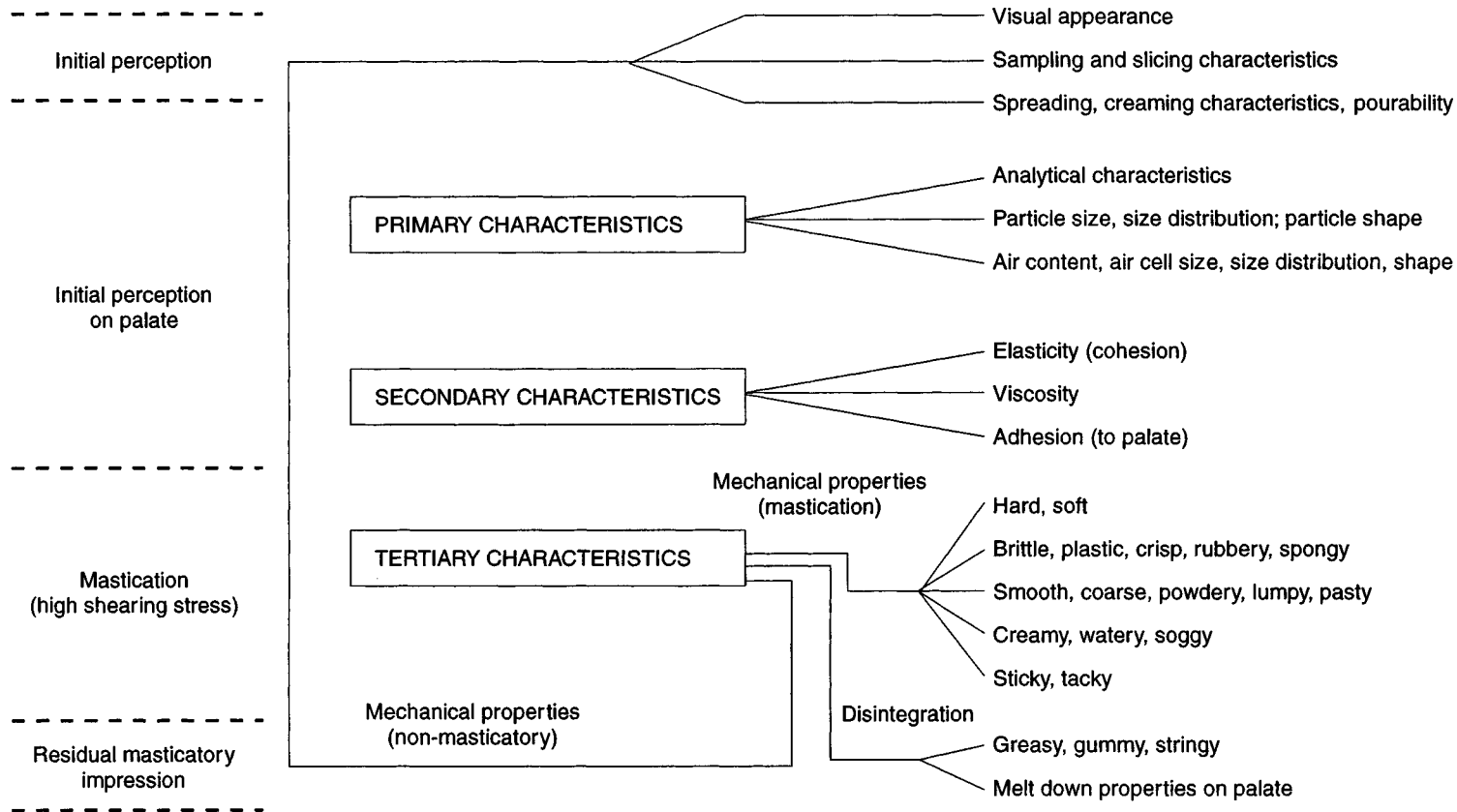

Figure 8-2 The Modified Texture Profile. *Source:* From P. Sherman, A Texture Profile of Foodstuffs Based upon Well-Defined Rheological Properties, *J. Food Sci.*, Vol. 34, pp. 458-462, 1969.

interesting because it attempts to relate sensory responses with mechanical strain-time tests. Sensory panel responses associated with masticatory tertiary characteristics of the Sherman texture profile for solid, semi-solid, and liquid foods are given in Figure 8-3.

OBJECTIVE MEASUREMENT OF TEXTURE

The objective measurement of texture belongs in the area of rheology, which is the science of flow and deformation of matter. Determining the rheological properties of a food does not necessarily mean that the complete texture of the product is determined. However, knowledge of some of the rheological properties of a food may give important clues as to its acceptability and may be important in determining the nature and design of processing methods and equipment.

Food rheology is mainly concerned with forces and deformations. In addition, time is an important factor; many rheological phenomena are time-dependent. Temperature is another important variable. Many products show important changes in rheological behavior as a result of changes in temperature. In addition to flow and deformation of cohesive bodies, food rheology includes such phenomena as the breakup or rupture of solid materials and surface phenomena such as stickiness (adhesion).

Deformation may be of one or both of two types, irreversible deformation, called flow, and reversible deformation, called elasticity. The energy used in irreversible deformation is dissipated as heat, and the body is permanently deformed. The energy used in reversible deformation is recovered upon release of

the deforming stress, when the body regains its original shape.

Force and Stress

When a force acts externally on a body, several different cases may be distinguished: tension, compression, and shear. Bending involves tension and compression, torque involves shear, and hydrostatic compression involves all three. All other cases may involve one of these three factors or a combination of them. In addition, the weight or inertia of a body may constitute a force leading to deformation. Generally, however, the externally applied forces are of much greater magnitude and the effect of weight is usually neglected. The forces acting on a body can be expressed in grams or in pounds. Stress is the intensity factor of force and is expressed as force per unit area; it is similar to pressure. There are several types of stress: compressive stress (with the stress components directed at right angles toward the plane on which they act); tensile stress (in which the stress components are directed away from the plane on which they act); and shearing stress (in which the stress components act tangentially to the plane on which they act). A uniaxial stress is usually designated by the symbol σ , a shearing stress by τ . Shear stress is expressed in dynes/cm² when using the metric system of measurement; in the SI system it is expressed in N/m² or pascal (P).

Deformation and Strain

When the dimensions of a body change, we speak of deformation. Deformation can be linear, as in a tensile test when a body of original length L is subjected to a tensile stress. The linear deformation ΔL can then be expressed as strain $\epsilon = \Delta L/L$. Strain can be

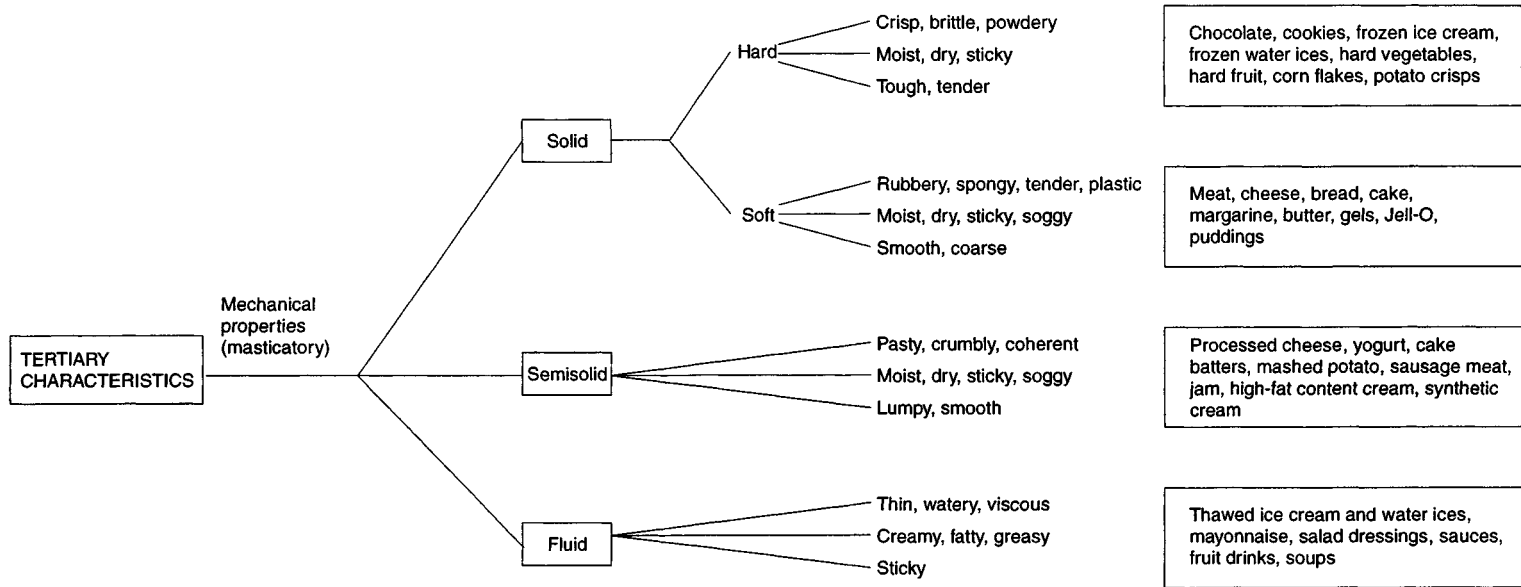

Figure 8-3 Panel Responses Associated with Masticatory Tertiary Characteristics of the Modified Texture Profile

expressed as a ratio or percent; inches per inch or centimeters per centimeter. In addition to linear deformations, there are other types of deformation, such as in a hydrostatic test where there will be a volumetric strain $\Delta V/V$.

For certain materials the deformation resulting from an applied force can be very large; this indicates the material is a liquid. In such cases, we deal with rate of deformation, or shear rate; dy/dt or $\dot{\gamma}$. This is the velocity difference per unit thickness of the liquid. $\dot{\gamma}$ is expressed in units of s^{-1} .

Viscosity

Consider a liquid contained between two parallel plates, each of area A cm^2 (Figure 8-4). The plates are h cm apart and a force of P dynes is applied on the upper plate. This shearing stress causes it to move with respect to the lower plate with a velocity of v $cm\ s^{-1}$. The shearing stress τ acts throughout the liquid contained between the plates and can be defined as the shearing force P divided by the area A , or P/A dynes/ cm^2 . The deformation can be expressed as the mean rate of shear $\dot{\gamma}$ or velocity gradient and is equal to the velocity difference divided by the distance between the plates $\dot{\gamma} = v/h$, expressed in units of s^{-1} .

The relationship between shearing stress and rate of shear can be used to define the flow properties of materials. In the simplest case, the shearing stress is directly proportional to the mean rate of shear $\tau = \eta \dot{\gamma}$ (Figure 8-5). The proportionality constant η is called the viscosity coefficient, or *dynamic viscosity*, or simply the viscosity of the liquid. The metric unit of viscosity is the dyne.s cm^{-2} , or Poise (P). The commonly used unit is 100 times smaller and called centiPoise (cP). In the SI system, η is expressed in $N.s/m^2$. or

Pa.s. Therefore, 1 Pa.s = 10 P = 1000 cP. Some instruments measure kinematic viscosity, which is equal to dynamic viscosity \times density and is expressed in units of Stokes. The viscosity of water at room temperature is about 1 cP. Mohsenin (1970) has listed the viscosities of some foods; these, as well as their SI equivalents, are given in Table 8-2.

Materials that exhibit a direct proportionality between shearing stress and rate of shear are called Newtonian materials. These include water and aqueous solutions, simple organic liquids, and dilute suspensions and emulsions. Most foods are non-Newtonian in character, and their shearing stress-rate-of-shear curves are either not straight or do not go through the origin, or both. This introduces a considerable difficulty, because their flow behavior cannot be expressed by a single value, as is the case for Newtonian liquids.

The ratio of shearing stress and rate of shear in such materials is not a constant value, so the value is designated *apparent viscosity*. To be useful, a reported value for apparent viscosity of a non-Newtonian material should be given together with the value of rate of shear or shearing stress used in the determination. The relationship of shearing stress and rate of shear of non-Newtonian materials such as the dilatant and pseudoplastic bodies of Figure 8-5 can be represented by a power law as follows:

$$\tau = A\dot{\gamma}^n$$

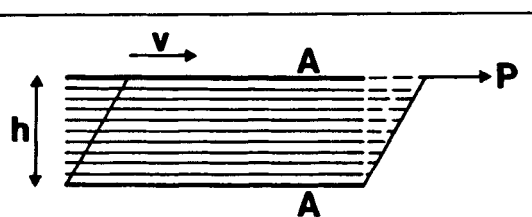

Figure 8-4 Flow Between Parallel Plates

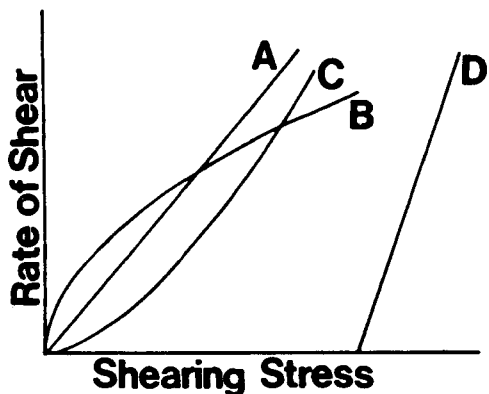

Figure 8-5 Shearing Stress-Rate of Shear Diagrams. (A) Newtonian liquid, viscous flow, (B) dilatant flow, (C) pseudoplastic flow, (D) plastic flow.

where A and n are constants. A is the consistency index or apparent viscosity and n is the flow behavior index. The exponent is $n = 1$ for Newtonian liquids; for dilatant materials, it is greater than 1; and for pseudoplastic

materials, it is less than 1. In its logarithmic form,

$$\log \tau = \log A + n \log \dot{\gamma}$$

A plot of $\log \tau$ versus $\log \dot{\gamma}$ will yield a straight line with a slope of n .

For non-Newtonian materials that have a yield stress, the Casson or Hershel-Bulkley models can be used. The Casson model is represented by the equation,

$$\sqrt{\tau} = \sqrt{\tau_0} + A \sqrt{\dot{\gamma}}$$

where τ_0 = yield stress.

This model has been found useful for several food products, especially chocolate (Kleinert 1976).

The Hershel-Bulkley model describes material with a yield stress and a linear relationship between \log shear stress and \log shear rate:

$$\tau = \tau_0 + A \dot{\gamma}^n$$

Table 8-2 Viscosity Coefficients of Some Foods

Product	Temperature (°C)	Viscosity	
		(cP)	(Pa.s)
Water	0	1.79	0.00179
Water	20	1.00	0.00100
Skim milk	25	1.37	0.00137
Milk, whole	0	4.28	0.00428
Milk, whole	20	2.12	0.00212
Cream (20% fat)	4	6.20	0.00620
Cream (30% fat)	4	13.78	0.01378
Soybean oil	30	40.6	0.0406
Sucrose solution (60%)	21	60.2	0.0602
Olive oil	30	84.0	0.0840
Cottonseed oil	16	91.0	0.0910
Molasses	21	6600.0	6.600

Source: Reprinted with permission from N.N. Mohsenin, *Physical Properties of Plant and Animal Materials, Vol. 1, Structure, Physical Characteristics and Mechanical Properties*, © 1970, Gordon and Breach Science Publisher.

The value of n indicates how close the linear plot of shear stress and shear rate is to being a straight line.

Principles of Measurement

For Newtonian fluids, it is sufficient to measure the ratio of shearing stress and rate of shear from which the viscosity can be calculated. This can be done in a viscometer, which can be one of various types, including capillary, rotational, falling ball, and so on. For non-Newtonian materials, such as the dilatant, pseudoplastic, and plastic bodies shown in Figure 8-5, the problem is more difficult. With non-Newtonian materials, several methods of measurement involve the ratio of shear stress and rate of shear, the relationship of stress to time under constant strain (relaxation), and the relationship of strain to time under constant stress (creep). In relaxation measurements, a material is subjected to a sudden deformation ϵ_0 , which is held constant. In many materials, the stress will decay with time according to the curve of Figure 8-6. The point at which the stress has decayed to σ/e , or 36.7 percent of the original value of σ_0 , is called the relaxation time. When the strain is removed at time T , the stress returns to zero. In a creep experiment, a material is subjected to the instantaneous application of a constant load or stress and the strain measured as a function of time. The resulting creep curve has the shape indicated in Figure 8-7. At time zero, the applied load results in a strain ϵ_0 , which increases with time. When the load is removed at time T , the strain immediately decreases, as indicated by the vertical straight portion of the curve at T ; the strain continues to decrease thereafter with time. In many materials, the value of ϵ never reaches zero, and we know, therefore, a permanent deformation ϵ_p has

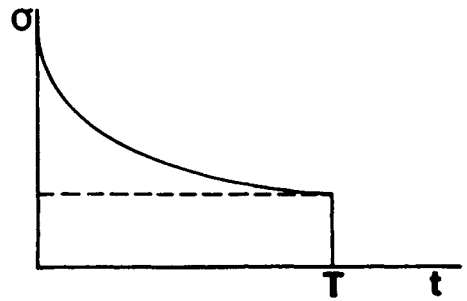

Figure 8-6 Relaxation Curve (Relationship of Stress to Time under Constant Strain)

resulted. The ratio of strain to applied stress in a creep experiment is a function of time and is called the creep compliance (J). Creep experiments are sometimes plotted as graphs relating J to time.

DIFFERENT TYPES OF BODIES

The Elastic Body

For certain solid bodies, the relationship between stress and strain is represented by a straight line through the origin (Figure 8-8)

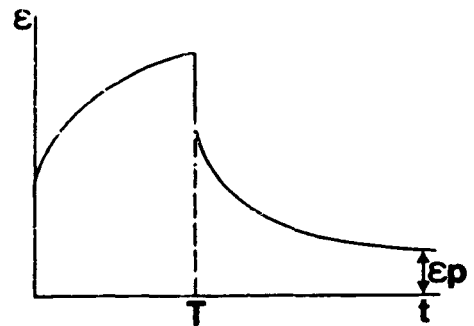

Figure 8-7 Creep Curve (Relationship of Strain to Time under Constant Stress)

up to the so-called limit of elasticity, according to the law of Hooke, $\sigma = E\epsilon$. The proportionality factor E for uniaxial stress is called *modulus of elasticity*, or Young's modulus. For a shear stress, the modulus is G , or Coulomb modulus. Note that a modulus is the ratio of stress to strain, $E = \sigma/\epsilon$. The behavior of a Hookean body is further exemplified by the stress-time and strain-time curves of Figure 8-9. When a Hookean body is subjected to a constant strain ϵ_0 , the stress σ will remain constant with time and will return to zero when the strain is removed at time T . The strain ϵ will follow the same pattern when a constant stress is applied and released at time T .

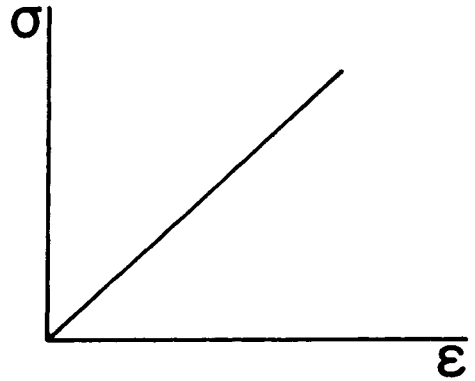

Figure 8-8 Stress-Strain Curve for a Perfectly Elastic Body

The Retarded Elastic Body

In bodies showing retarded elasticity, the deformation is a function of time as well as stress. Such a stress-strain curve is shown in Figure 8-10. The upward part of the curve represents increasing values of stress; when the stress is reduced, the corresponding strains are greater on the downward part of the curve. When the stress reaches 0, the strain has a finite value, which will slowly return to zero. There is no permanent deformation. The corresponding relaxation (stress-time) and creep (strain-time) curves

for this type of body are given in Figure 8-11.

The Viscous Body

A viscous or Newtonian liquid is one showing a direct proportionality between stress and rate of shear, as indicated by curve A in Figure 8-5.

The Viscoelastic Body

Certain bodies combine the properties of both viscous and elastic materials. The elas-

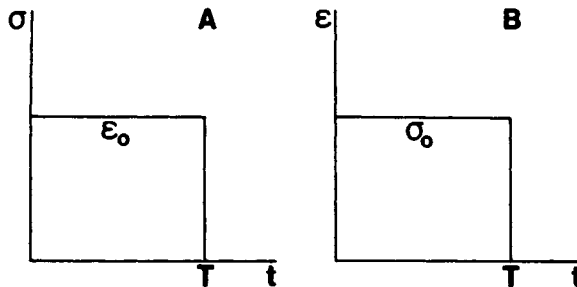

Figure 8-9 (A) Stress-Time and (B) Strain-Time Curves of a Hookean Body

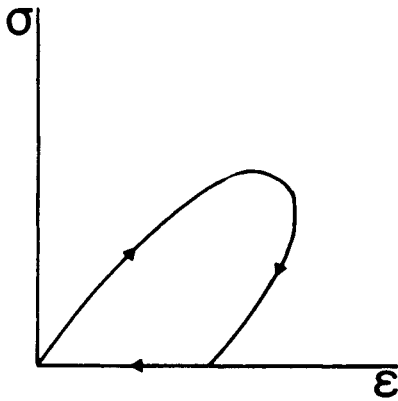

Figure 8-10 Stress-Strain Curve of a Retarded Elastic Body

tic component can be partially retarded elasticity. Viscoelastic bodies may flow slowly and nonreversibly under the influence of a small stress. Under larger stresses the elastic component becomes apparent. The relaxation curve of viscoelastic materials has the shape indicated in Figure 8-12A. The curve has the tendency to approach the time axis. The creep curve indicates that the strain increases for as long as the stress is applied (Figure 8-12B). The magnitude of the permanent deformation of the body increases with the applied stress and with the length of application.

Mechanical models can be used to visualize the behavior of different bodies. Thus, a spring denotes a Hookean body, and a dash-pot denotes a purely viscous body or Newtonian fluid. These elements can be combined in a variety of ways to represent the rheological behavior of complex substances. Two basic viscoelastic models are the Voigt-Kelvin and the Maxwell bodies. The Voigt-Kelvin model employs a spring and dashpot in parallel, the Maxwell model a spring and dashpot in series (Figure 8-13). In the Voigt-Kelvin body, the stress is the sum of two components where one is proportional to the strain and the other to the rate of shear. Because the elements are in parallel, they must move together. In the Maxwell model the deformation is composed of two parts—one purely viscous, the other purely elastic. Although both the Voigt-Kelvin and Maxwell bodies represent viscoelasticity, they react differently in relaxation and creep experiments. When a constant load is applied in a creep test to a Voigt-Kelvin model, a final steady-state deformation is obtained because the compressed spring element resists further movement. The Maxwell model will give continuing flow under these conditions because the viscous element is not limited by the spring element. When the load is removed, the Voigt-Kelvin model recovers

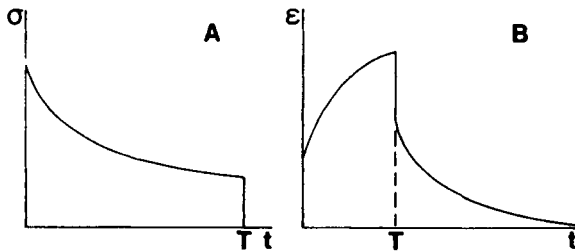

Figure 8-11 (A) Stress-Time and (B) Strain-Time Curves of a Retarded Elastic Body

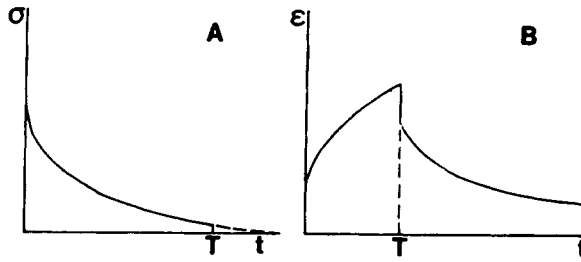

Figure 8-12 (A) Stress-Time and (B) Strain-Time Curves of a Viscoelastic Body

completely, but not instantaneously. The Maxwell body does not recover completely but, rather, instantly. The Voigt-Kelvin body, therefore, shows no stress relaxation but the Maxwell body does. A variety of models can be constructed to represent the rheological behavior of viscoelastic materials. By placing a number of Kelvin models in series, a so-called generalized Kelvin model is obtained. Similarly, a generalized Maxwell model is obtained by placing a number of Maxwell models in parallel. The combination of a Kelvin and a Maxwell model in

series (Figure 8-13C) is called a Burgers model.

For ideal viscoelastic materials, the initial elastic deformation at the time the load is applied should equal the instantaneous elastic deformation when the load is removed (Figure 8-14). For most food products, this is not the case. As is shown by the example of butter in Figure 8-14, the initial deformation is greater than the elastic recovery at time t . This may result from the fact that these foods are plastic as well as viscoelastic, which means they have a yield value. There-

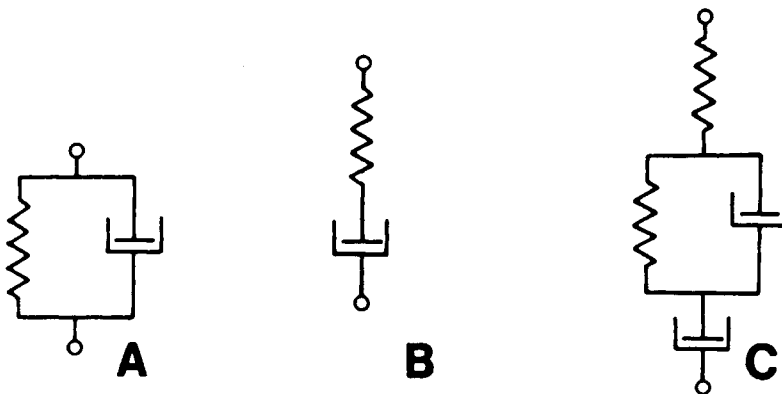

Figure 8-13 (A) Voigt-Kelvin, (B) Maxwell, and (C) Burgers Models

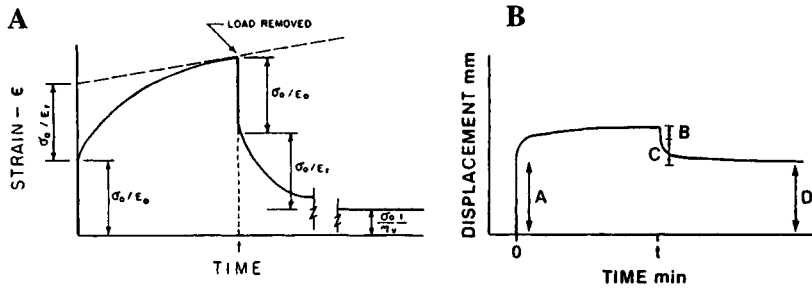

Figure 8-14 (A) Creep Curve for an Ideal Viscoelastic Body and (B) Creep Curve for Butter

fore, the initial deformation consists of both an instantaneous elastic deformation and a permanent deformation (viscous flow component). It has also been found (deMan et al. 1985) that the magnitude of the instantaneous elastic recovery in fat products is time dependent and decreases as the time of application of the load increases. It appears that the fat crystal network gradually collapses as the load remains on the sample.

The Plastic Body

A plastic material is defined as one that does not undergo a permanent deformation until a certain yield stress has been exceeded. A perfectly plastic body showing no elasticity would have the stress-strain behavior depicted in Figure 8-15. Under influence of a small stress, no deformation occurs; when the stress is increased, the material will suddenly start to flow at applied stress σ_0 (the yield stress). The material will then continue to flow at the same stress until this is removed; the material retains its total deformation. In reality, few bodies are perfectly plastic; rather, they are plasto-elastic or plasto-viscoelastic. The mechanical model used to represent a plastic body, also called a St. Venant body, is a friction element. The

model is analogous to a block of solid material that rests on a flat horizontal surface. The block will not move when a force is applied to it until the force exceeds the friction existing between block and surface. The models for ideal plastic and plasto-elastic bodies are shown in Figure 8-16A and 8-16B.

A more common body is the plasto-viscoelastic, or Bingham body. Its mechanical model is shown in Figure 8-16C. When a stress is applied that is below the yield stress, the Bingham body reacts as an elastic body. At stress values beyond the yield stress, there are two components, one of which is constant and is represented by the friction ele-

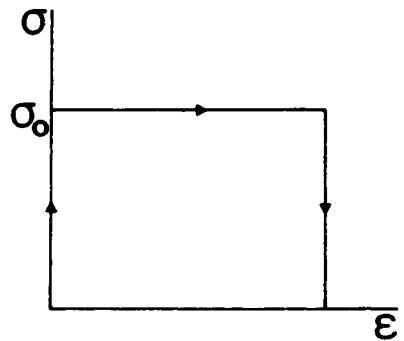

Figure 8-15 Stress-Strain Curve of an Ideal Plastic Body

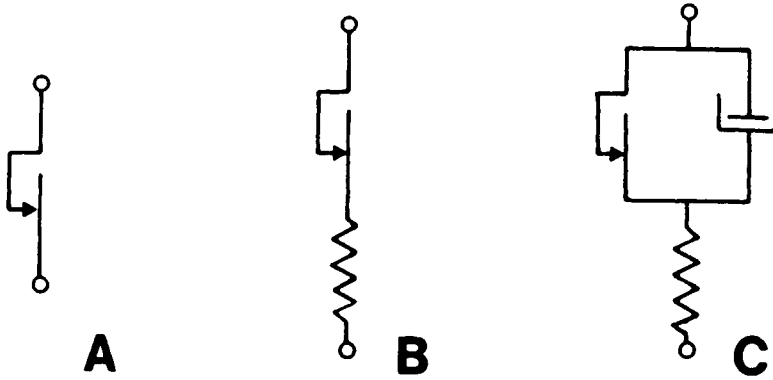

Figure 8-16 Mechanical Models for a Plastic Body. (A) St. Venant body, (B) plasto-elastic body, and (C) plasto-viscoelastic or Bingham body.

ment, and the other, which is proportional to the shear rate and represents the viscous flow element. In a creep experiment with stress not exceeding the yield stress, the creep curve would be similar to the one for a Hookean body (Figure 8-9B). When the shear stress is greater than the yield stress, the strain increases with time, similar to the behavior of a Maxwell body (Figure 8-17). Upon removal of the stress at time T , the strain decreases instantaneously and remains constant thereafter. The decrease represents the elastic component; the plastic deformation is permanent. The relationship of rate of shear and shear stress of a Bingham body would have the form shown in Figure 8-18A. When flow occurs, the relationship between shearing stress and rate of shear is given by

$$\sigma - \sigma_o = UD$$

where

- σ_o = yield stress
- U = proportionality constant
- D = mean rate of shear

The constant U can be named plastic viscosity and its reciprocal $1/U$ is referred to as mobility.

In reality, plastic materials are more likely to have a curve similar to the one in Figure 8-18B. The yield stress or yield value can be taken at three different points—the lower yield value at the point where the curve starts on the stress axis; the upper yield value

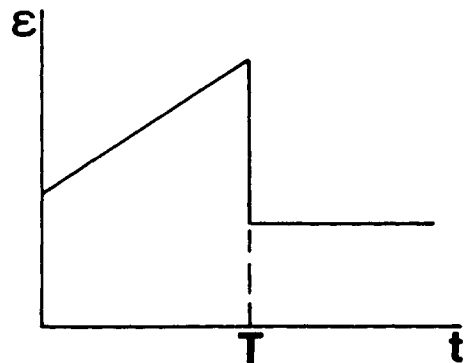

Figure 8-17 Creep Curve of a Bingham Body Subjected to a Stress Greater Than the Yield Stress

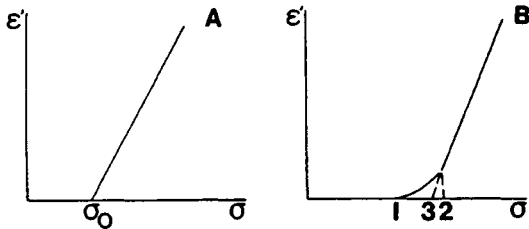

Figure 8–18 Rate-of-Shear–Shear Stress Diagrams of Bingham Bodies. (A) Ideal case, and (B) practical case. The yield values are as follows: lower yield value (1), upper yield value (2), and Bingham yield value (3).

where the curve becomes straight; and the Bingham yield value, which is found by extrapolating the straight portion of the curve to the stress axis.

The Thixotropic Body

Thixotropy can be defined as an isothermal, reversible, sol-gel transformation and is a behavior common to many foods. Thixotropy is an effect brought about by mechanical action, and it results in a lowered apparent viscosity. When the body is allowed sufficient time, the apparent viscosity will return to its original value. Such behavior would result in a shear stress–rate-of-shear diagram, as given in Figure 8–19. Increasing shear rate results in increased shear stress up to a maximum; after the maximum is reached, decreasing shear rates will result in substantially lower shear stress.

Dynamic Behavior

Viscoelastic materials are often characterized by their dynamic behavior. Because vis-

coelastic materials are subject to structural breakdown when subjected to large strains, it is useful to analyze them by small amplitude sinusoidal strain. The relationship of stress and strain under these conditions can be evaluated from Figure 8–20 (Bell 1989). The applied stress is alternating at a selected frequency and is expressed in cycles s^{-1} , or ω in radians s^{-1} . The response of a purely elastic material will show a stress and strain response that is in phase, the phase angle $\delta = 0^\circ$. A purely viscous material will show the stress being out of phase by 90° , and a viscoelastic material shows intermediate behavior, with δ between 0° and 90° . The viscoelastic dynamic response is composed of an in-phase component ($\sin \omega t$) and an out-of-phase component ($\cos \omega t$). The energy used for the viscous component is lost as heat; that used for the elastic component is retained as stored energy. This results in two moduli, the storage modulus (G') and the loss modulus (G''). The ratio of the two moduli is known as $\tan \delta$ and is given by $\tan \delta = G''/G'$.

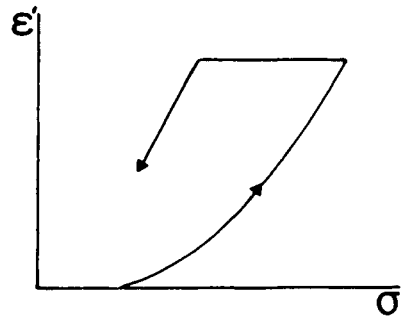
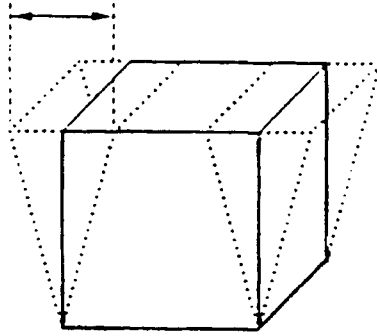
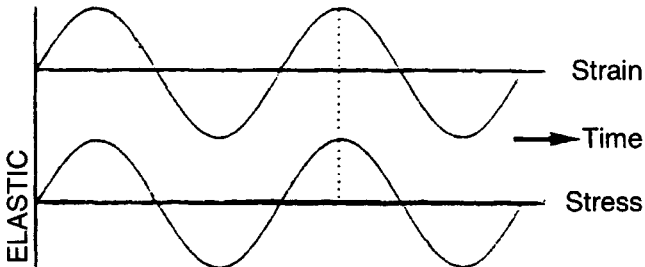

Figure 8–19 Shear Stress–Rate-of-Shear Diagram of a Thixotropic Body. *Source:* From J.M. deMan and F.W. Wood, *Hardness of Butter. II. Influence of Setting*, *J. Dairy Sci.* Vol. 42, pp. 56–61, 1959.



$\delta = 0^\circ$



$\delta = 90^\circ$

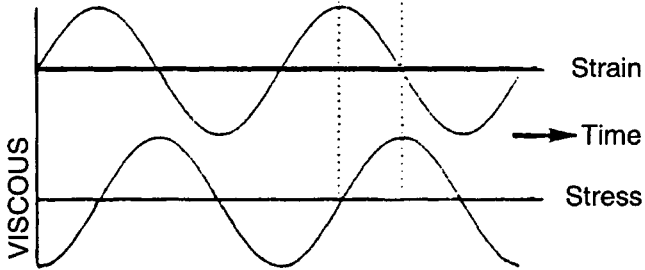

$\delta < 90^\circ$

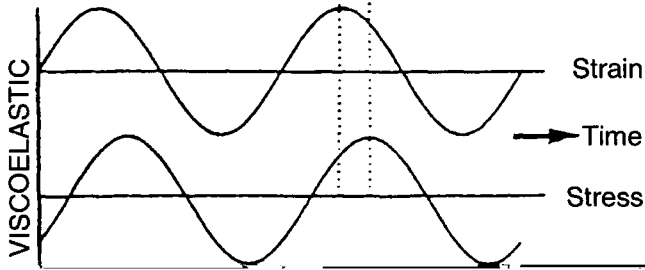

APPLICATION TO FOODS

Many of the rheological properties of complex biological materials are time-dependent, and Mohsenin (1970) has suggested that many foods can be regarded as viscoelastic materials. Many foods are disperse systems of interacting nonspherical particles and show thixotropic behavior. Such particles may interact to form a three-dimensional network that imparts rigidity to the system. The interaction may be the result of ionic forces in aqueous systems or of hydrophobic or van der Waals interactions in systems that contain fat crystals in liquid oil (e.g., butter, margarine, and shortening). Mechanical action, such as agitation, kneading, or working results in disruption of the network structure and a corresponding loss in hardness. When the system is then left undisturbed, the bonds

between particles will reform and hardness will increase with time until maximum hardness is reached. The nature of thixotropy was demonstrated with butter by deMan and Wood (1959). Hardness of freshly worked butter was determined over a period of three weeks (Figure 8-21). The same butter was frozen and removed from frozen storage after three weeks. No thixotropic change had occurred with the frozen sample. The freezing had completely immobilized the crystal particles. Thixotropy is important in many food products; great care must be exercised that measurements are not influenced by thixotropic changes.

The viscosity of Newtonian liquids can be measured simply, by one-point determinations with viscometers, such as rotational, capillary, or falling ball viscometers. For non-Newtonian materials, measurement of

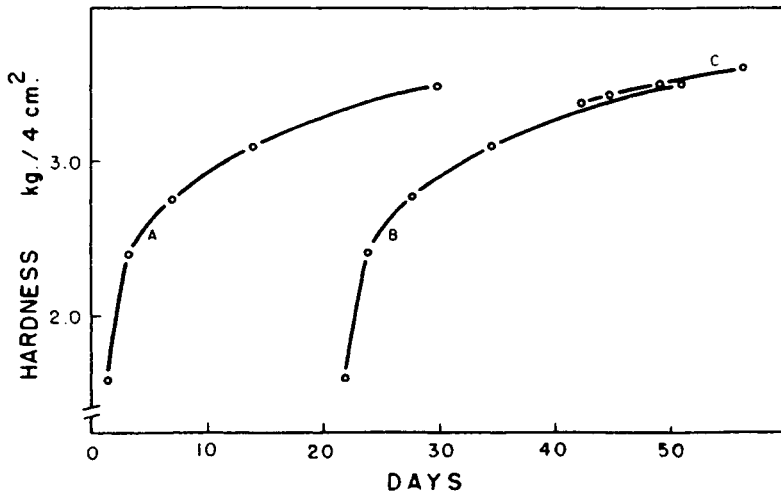

Figure 8-21 Thixotropic Hardness Change in Butter. (A) Freshly worked butter left undisturbed for four weeks at 5°C. (B) The same butter stored at -20°C for three weeks then left at 5°C. (C) The same butter left at 5°C for three weeks, then frozen for three weeks and again placed at 5°C. Source: From J.M. deMan and F.W. Wood, Hardness of Butter. II. Influence of Setting, *J. Dairy Sci.*, Vol. 42, pp. 56-61, 1959.

rheological properties is more difficult because single-point determinations (i.e., at one single shearing stress) will yield no useful information. We can visualize the rate of shear dependence of Newtonian fluids by considering a diagram of two fluids, as shown in Figure 8-22 (Sherman 1973). The behavior of these fluids is represented by two straight lines parallel to the shear-rate axis. With non-Newtonian fluids, a situation as shown in Figure 8-23 may arise. The fluids 3 and 4 have curves that intersect. Below this point of intersection, fluid 4 will appear more viscous; beyond the intersection, fluid 3 will appear more viscous. Fluids 5 and 6 do not intersect and the problem does not arise. In spite of the possibility of such problems, many practical applications of rheological measurements of non-Newtonian fluids are carried out at only one rate of shear. Note that results obtained in this way should be interpreted with caution. Shoemaker et al.

(1987) have given an overview of the application of rheological techniques for foods.

Probably the most widely used type of viscometer in the food industry is the Brookfield rotational viscometer. An example of this instrument's application to a non-Newtonian food product is given in the work of Saravacos and Moyer (1967) on fruit purees. Viscometer scale readings were plotted against rotational speed on a logarithmic scale, and the slope of the straight line obtained was taken as the exponent n in the following equation for pseudoplastic materials:

$$\tau = K\dot{\gamma}^n$$

where

τ = shearing stress (dyne/cm²)

K = constant

$\dot{\gamma}$ = shear rate (s⁻¹)

The instrument readings were converted into shear stress by using an oil of known viscos-

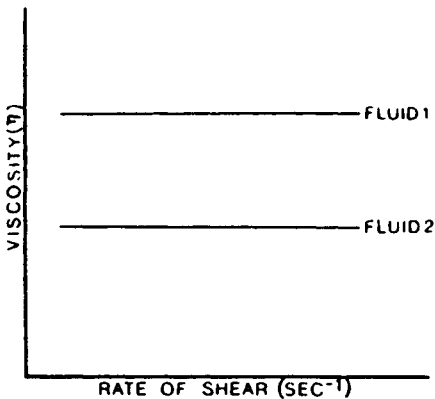

Figure 8-22 Rate of Shear Dependence of the Viscosity of Two Newtonian Fluids. *Source:* From P. Sherman, Structure and Textural Properties of Foods, in *Texture Measurement of Foods*, A. Kramer and A.S. Szczesniak, eds., 1973, D. Reidel Publishing Co.

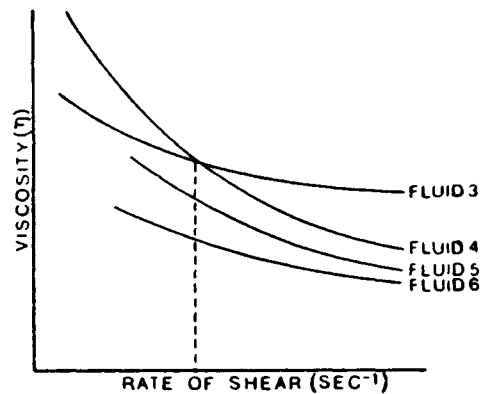

Figure 8-23 Rate of Shear Dependence of the Apparent Viscosity of Several Non-Newtonian Fluids. *Source:* From P. Sherman, Structure and Textural Properties of Foods, in *Texture Measurement of Foods*, A. Kramer and A.S. Szczesniak, eds., 1973, D. Reidel Publishing Co.

ity. The shear rate at a given rotational speed N was calculated from

$$\dot{\gamma} = 4\pi N/n$$

When shear stress τ was plotted against shear rate $\dot{\gamma}$ on a double logarithmic scale, the intercept of the straight line on the τ axis at $\dot{\gamma} = 1 \text{ s}^{-1}$ was taken as the value of the constant K . The apparent viscosity μ_{app} at a given shear rate was then calculated from the equation

$$\mu_{\text{app}} = K\dot{\gamma}^{n-1}$$

Apparent viscosities of fruit purees determined in this manner are shown in Figure 8-24.

Factors have been reported in the literature (Johnston and Brower 1966) for the conversion of Brookfield viscometer scale readings to yield value or viscosity. Saravacos (1968) has also used capillary viscometers for rheological measurements of fruit purees.

For products not sufficiently fluid to be studied with viscometers, a variety of texture-measuring devices is available. These range from simple penetrometers such as the Magness-Taylor fruit pressure tester to complex universal testing machines such as the Instron. All these instruments either apply a known and constant stress and measure deformation or cause a constant deformation and measure stress. Some of the more sophisticated instruments can do both. In the Instron Universal Testing Machine, the crosshead moves at a speed that can be selected by changing gears. The drive is by rotating screws, and the force measurement is done with load cells. Mohsenin (1970) and coworkers have developed a type of universal testing machine in which the movement is achieved by air pressure. The Kramer shear

press uses a hydraulic system for movement of the crosshead.

Texture-measuring instruments can be classified according to their use of penetration, compression, shear, or flow.

Penetrometers come in a variety of types. One of the most widely used is the Precision penetrometer, which is used for measuring consistency of fats. The procedure and cone dimensions are standardized and described in the Official and Tentative Methods of the American Oil Chemists' Society. According to this method, the results are expressed in mm/10 of penetration depth. Haighton (1959) proposed the following formula for the conversion of depth of penetration into yield value:

$$C = KW/p^{1.6}$$

where

C = yield value

K = constant depending on the angle of the cone

p = penetration depth

W = weight of cone

Vasic and deMan (1968) suggested conversion of the depth of penetration readings into hardness by using the formula

$$H = G/A$$

where

H = hardness

G = total weight of cone assembly

A = area of impression

The advantage of this conversion is that changes in hardness are more uniform than changes in penetration depth. With the latter, a difference of an equal number of units at

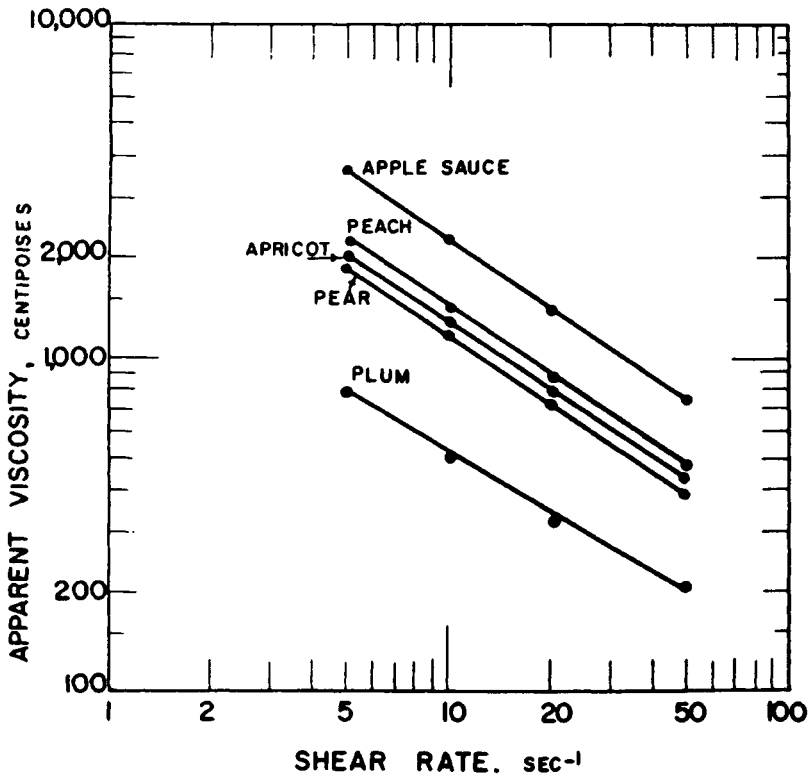

Figure 8-24 Apparent Viscosities of Fruit Purees Determined at 86°C. Source: From G.D. Saravacos and J.C. Moyer, Heating Rates of Fruit Products in an Agitated Kettle, *Food Technol.*, Vol. 21, pp. 372-376, 1967.

the tip of the cone and higher up on the cone is not at all comparable.

Many penetrometers use punches of various shapes and sizes as penetrating bodies. Little was known about the relationship between shape and size and penetrating force until Bourne's (1966) work. He postulated that when a punch penetrates a food, both compression and shear occur. Shear, in this case, is defined as the movement of interfaces in opposite directions. Bourne suggested that compression is proportional to the area under the punch and to the compressive strength of the food and also that the

shear force is proportional to the perimeter of the punch and to the shear strength of the food (Figure 8-25). The following equation was suggested:

$$F = K_c A + K_s P + C$$

where

F = measured force

K_c = compression coefficient of tested food

K_s = shear coefficient of tested food

A = area of punch

P = perimeter of punch

C = constant

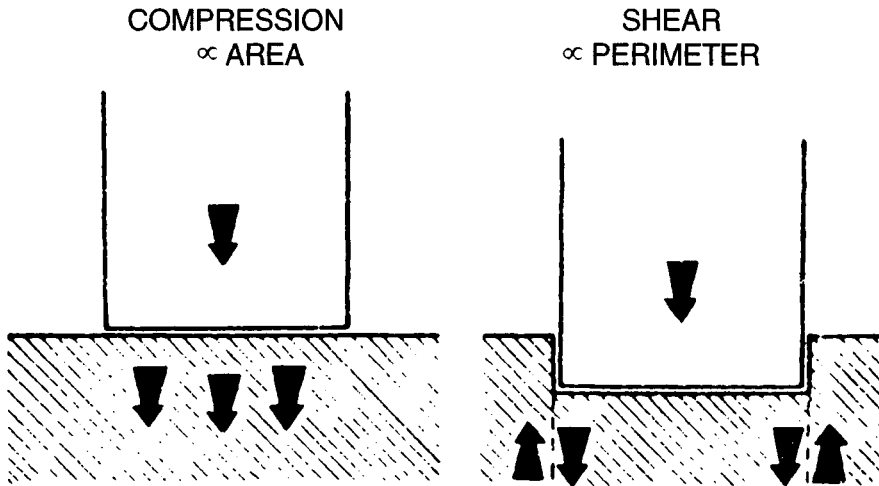

Figure 8-25 Compression and Shear Components in Penetration Tests. *Source:* From M.C. Bourne, Measure of Shear and Compression Components of Puncture Tests, *J. Food Sci.*, Vol. 31, pp. 282-291, 1966.

The relationship between penetration force and cross-sectional area of cylindrical punches has been established by Kamel and deMan (1975).

Bourne did show that, for a variety of foods, the relationships between punch area and force and between punch perimeter and force were represented by straight lines. DeMan (1969) later showed that for certain products, such as butter and margarine, the penetrating force was dependent only on area and was not influenced by perimeter. deMan suggested that in such products flow is the only factor affecting force readings. It appears that useful conclusions can be drawn regarding the textural characteristics of a food by using penetration tests.

A variation on the penetration method is the back extrusion technique, where the sample is contained in a cylinder and the penetrating body leaves only a small annular gap

for the product to flow. The application of the back extrusion method to non-Newtonian fluids has been described by Steffe and Osorio (1987).

Many instruments combine shear and compression testing. One of the most widely used is the Kramer shear press. Based on the principle of the shear cell used in the pea tenderometer, the shear press was designed to be a versatile and widely applicable instrument for texture measurement of a variety of products. The shear press is essentially a hydraulically driven piston, to which the standard 10-blade shear cell or a variety of other specialized devices can be attached. Force measurement is achieved either by a direct reading proving ring or by an electronic recording device. The results obtained with the shear press are influenced by the weight of the sample and the speed of the crosshead. These factors have been exhaus-

tively studied by Szczesniak et al. (1970). The relationship between maximum force values and sample weight was found to be different for different foods. Products fitted into three categories—those having a constant force-to-weight ratio (e.g., white bread, sponge cake); those having a continuously decreasing force-to-weight ratio (e.g., raw apples, cooked white beans); and those giving a constant force, independent of sample weight beyond a certain fill level (e.g., canned beets, canned and frozen peas). This is demonstrated by the curves of Figure 8-26. Some of the attachments to the shear press are the succulometer cell, the single-blade meat shear cell, and the compression cell.

Based on the Szczesniak classification of textural characteristics, a new instrument was developed in the General Foods Research Laboratories; it is called the General Foods Texturometer. This device is an improved version of the MIT denture tenderometer (Proctor et al. 1956). From the reciprocating motion of a deforming body on the sample, which is contained in a tray provided with strain gages, a force record called a texture profile curve (Figure 8-27) is obtained. From this texturometer curve, a variety of rheological parameters can be obtained. Hardness is measured from the height of the first peak. Cohesiveness is expressed as the ratio of the areas under the second and first peaks. Elasticity is measured as the difference between

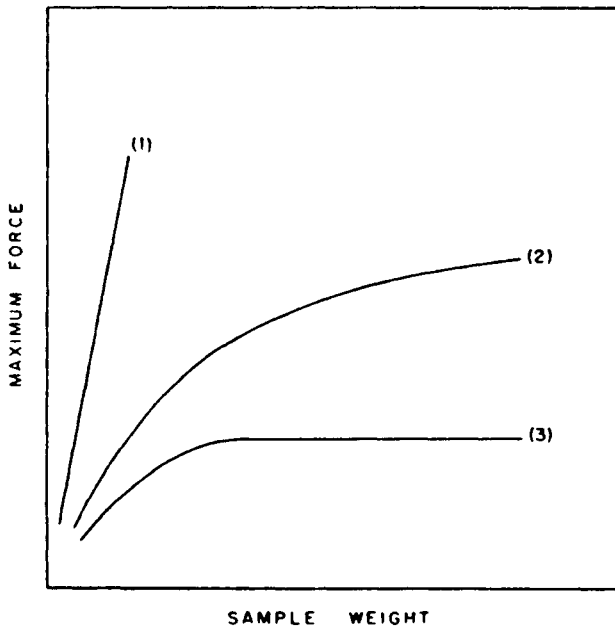

Figure 8-26 Effect of Sample Weight on Maximum Force Registered with the Shear Press and Using the 10-Blade Standard Cell. (1) White bread and sponge cake, (2) raw apples and cooked white beans, (3) canned beets and peas and frozen peas. *Source:* From A.S. Szczesniak, *Instrumental Methods of Texture Measurements*, in *Texture Measurement of Foods*, A. Kramer and A.S. Szczesniak, eds., 1973, D. Reidel Publishing Co.

distance B , measured from initial sample contact to sample contact on the second "chew," and the same distance (distance B) measured with a completely inelastic material such as clay. Adhesiveness is measured as the area of the negative peak A_3 beneath the baseline. In addition, other parameters can be derived from the curve such as brittleness, chewiness, and gumminess.

TEXTURAL PROPERTIES OF SOME FOODS

Meat Texture

Meat texture is usually described in terms of tenderness or the lack of it—toughness. This obviously is related to the ease with which a piece of meat can be cut with a knife or with the teeth. The oldest and most widely

used device for measuring meat tenderness is the Warner-Bratzler shear device (Bratzler 1932). In this device, a cylindrical core of cooked meat is subjected to the shearing action of a steel blade and the maximum force is indicated by a springloaded mechanism. A considerable improvement was the shear apparatus described by Voisey and Hansen (1967). In this apparatus, the shearing force is sensed by a strain gage transducer and a complete shear-force time curve is recorded on a strip chart. The Warner-Bratzler shear method has several disadvantages. It is very difficult to obtain uniform meat cores. Cores from different positions in one cut of meat may vary in tenderness, and cooking method may affect tenderness.

Meat tenderness has been measured with the shear press. This can be done with the 10-blade universal cell or with the single-

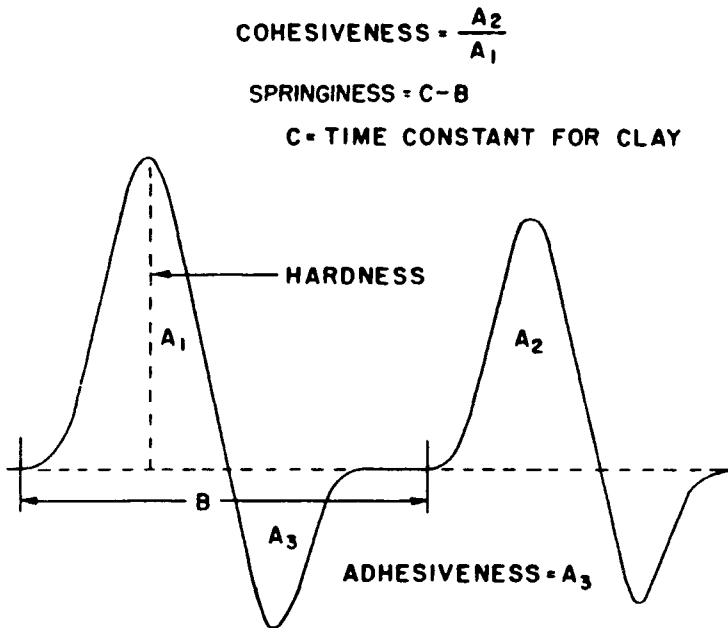

Figure 8-27 Typical Texturometer Curve

blade meat shear attachment. There is no standard procedure for measuring meat tenderness with the shear press; sample size, sample preparation, and rate of shear are factors that may affect the results.

A pressure method for measuring meat tenderness has been described by Sperring et al. (1959). A sample of raw meat is contained in a cylinder that has a small hole in its bottom. A hydraulic press forces a plunger into the cylinder, and the pressure required to squeeze the meat through the hole is taken as a measure of tenderness.

A portable rotating knife tenderometer has been described by Bjorksten et al. (1967). A rotating blunt knife is forced into the meat sample, and a tracing of the area traversed by a recording pen is used as a measure of tenderness.

A meat grinder technique for measuring meat tenderness was reported by Miyada and Tappel (1956); in this method, power consumption of the meat grinder motor was used as a measure of meat tenderness. The electronic recording food grinder described by Voisey and deMan (1970) measures the torque exerted on a strain gage transducer. This apparatus has been used successfully for measuring meat tenderness.

Other methods used for meat tenderness evaluation have included measurement of sarcomere length (Howard and Judge 1968) and determination of the amount of connective tissue present.

Stoner et al. (1974) have proposed a mechanical model for postmortem striated muscle; it is shown in Figure 8-28. The model is a combination of the Voigt model with a four-element viscoelastic model. The former includes a contractile element (CE), which is the force generator. The element SE is a spring that is passively elongated by the shortening of the CE and thus develops an

internal force. The parallel elastic component (PE) contributes to the resting tension of the muscle. The combination of elements PE, CE, and SE represents the purely elastic properties of the muscle as the fourth component of a four-element model (of which E_2 , η_3 , and η_2 are the other three components).

Dough

The rheological properties of dough are important in determining the baking quality of flour. For many years the Farinograph was used to measure the physical properties of dough. The Farinograph is a dough mixer hooked up to a dynamometer for recording

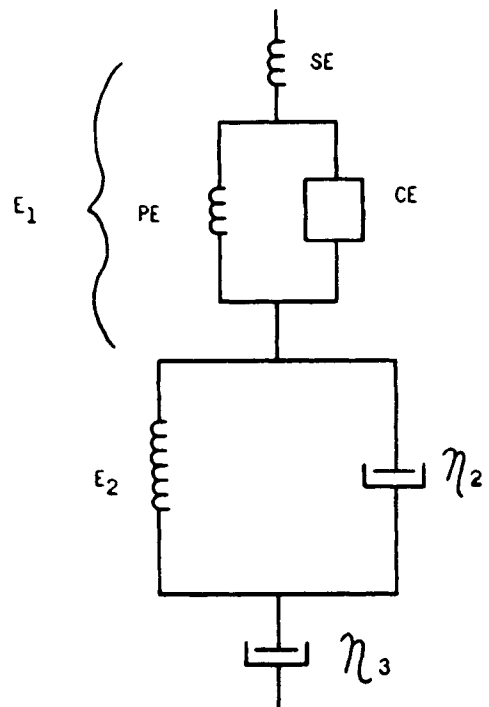
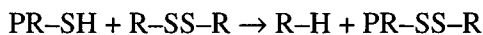

Figure 8-28 Mechanical Model for Postmortem Striated Muscle. *Source:* From C.W. Brabender Instruments, Inc., South Hackensack, New Jersey.

torque. The instrument can measure water absorption of flour. A typical Farinograph curve is presented in Figure 8-29. The amount of water required to bring the middle of the curve to 500 units, added from a buret, is a measure of the water absorption of the dough. The measurement from zero to the point where the top of the curve first intersects the 500 line on the chart is called arrival time; the measurement from zero to maximum consistency is called peak time; the point where the top of the curve leaves the 500 line is called departure time; the difference between departure and arrival time is stability. The elasticity of dough is measured with the extensigraph, which records the force required to stretch a piece of dough of standard dimensions.

The peculiar viscoelastic properties of wheat dough are the result of the presence of a three-dimensional network of gluten proteins. The network is formed by thiol-disulfide exchange reactions among gluten proteins. Peptide disulfides can interfere in a thiol-disulfide exchange system by reacting with a protein (PR)-thiol to liberate a peptide (R)-thiol and form a mixed disulfide, as follows:



Disulfide bonds between proteins have an energy of 49 kcal/mole and are not broken at room temperature except as the result of a chemical reaction. The effects of oxidizing agents on the rheological properties of dough

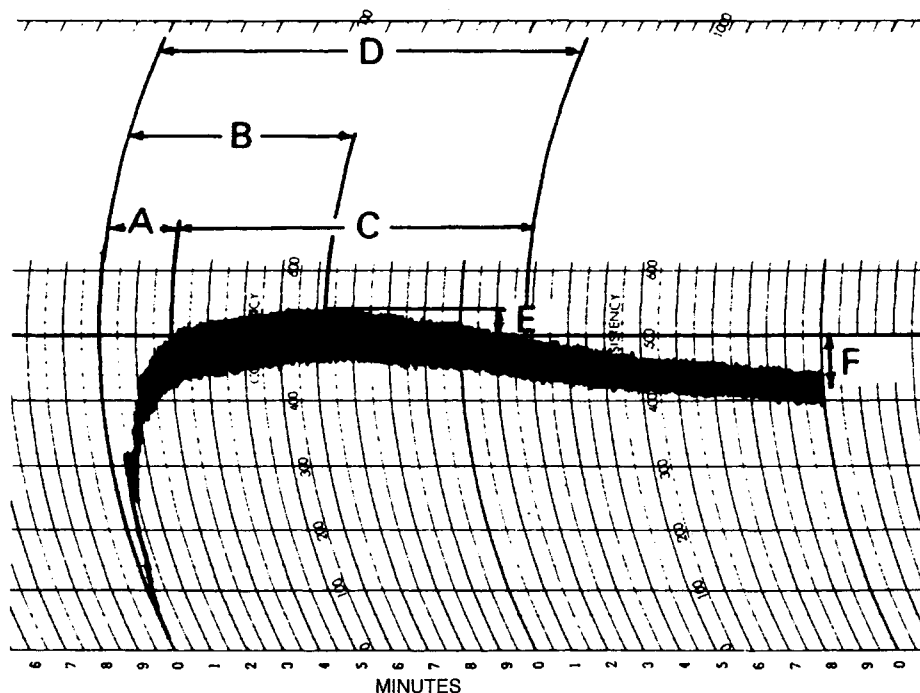

Figure 8-29 Typical Farinograph Curve. (A) Arrival time, (B) peak time, (C) stability, (D) departure, (E) mixing tolerance index, (F) 20-minute drop. *Source:* From H.P. Wehrli and Y. Pomeranz, *The Role of Chemical Bonds in Dough*, *Baker's Digest*, Vol. 43, no. 6, pp. 22-26, 1969.

may be quantitatively explained as the breaking of disulfide cross-links; their reformation may be explained as exchange reactions with sulfhydryl groups (Wehrli and Pomeranz 1969). The baking quality of wheat is strongly influenced by protein content and the disulfide/sulfhydryl ratio. A schematic diagram of the bonds within and between polypeptide chains in dough is given in Figure 8-30.

Fats

Consistency of fats is commonly determined with the cone penetrometer, as specified in the Official and Tentative Methods of the American Oil Chemists' Society (Method Cc 16-60). Other methods that have frequently been employed involve extrusion; they include the extrusion attachment to the shear press (Vasic and deMan 1967), an extrusion rheometer used with the Instron universal testing machine (Scherr and Wittnauer 1967), and the FIRA-NIRD extruder (Prentice 1954).

Other devices used for fat consistency measurements include wire-cutting instru-

ments (sectilometers), penetration of a probe when the sample is contained in a small cup, and compression of cylindrical samples between two parallel plates. The compression method reveals detailed information about plastic fats (deMan et al., 1991) such as elasticity, viscous flow, and degree of brittleness. These characteristics are important in shortenings destined for cakes and puff pastries. Compression curves of a variety of shortenings are displayed in Figure 8-31. Temperature treatment of a fat has profound effect on its texture. deMan and deMan (1996) studied the effect of crystallization temperature and tempering temperature on the texture of palm oil and hydrogenated fats using the compression method and found that lowering the crystallization temperature from 10 to 0°C resulted in softer texture, especially for palm oil. Increasing the tempering temperature from 25° to 30°C also resulted in softer texture, especially for hydrogenated fats.

The hardness or consistency of fats is the result of the presence of a three-dimensional network of fat crystals. All fat products such

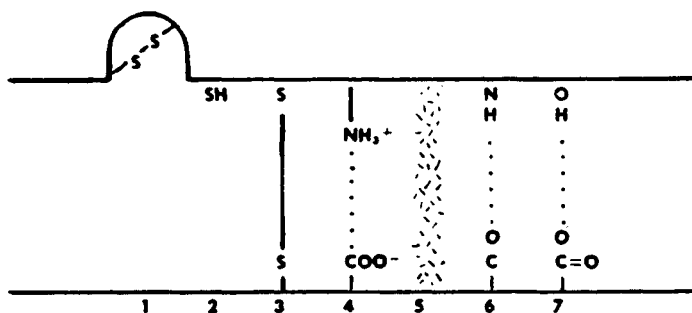

Figure 8-30 Schematic Diagram of Bonds Within and Between Polypeptide Chains in Dough. Solid lines represent covalent bonds, dotted lines other bonds. (1) Intramolecular disulfide bond, (2) free sulfhydryl group, (3) intermolecular disulfide bond, (4) ionic bond, (5) van der Waals bond, (6) interpeptide hydrogen bond, (7) side chain hydrogen bond. *Source:* From A.H. Bloksma, *Rheology of Wheat Flour Dough*, *J. Texture Studies*, Vol. 3, pp. 3-17, 1972.

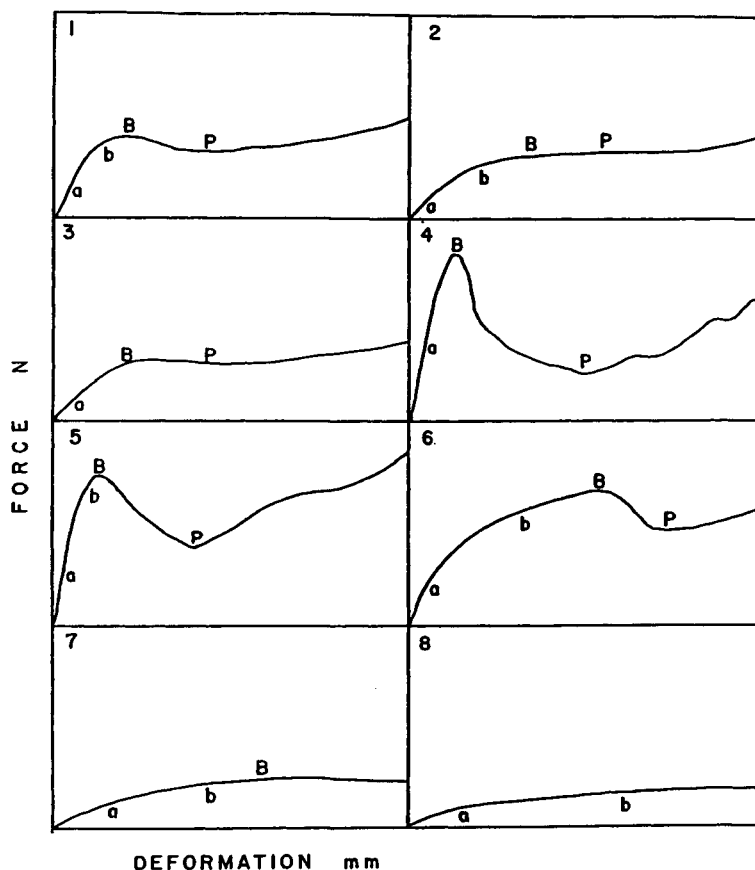

Figure 8-31 Examples of Compression Curves of Shortenings. (1) and (2) soy-palm; (3) soy-canola-palm; (4) soy only; (5) tallow-lard; (6) lard; (7) palm-vegetable; (8), palm-palm kernel. a = elastic non-recoverable deformation; b = viscous flow; B = breaking force; P = plateau force; distance between B and P is an indication of brittleness.

as margarine, shortening, and butter are mixtures of solid fat in crystallized form and liquid oil. Because the individual glycerides in fats have a wide range of melting points, the ratio of solid to liquid fat is highly temperature dependent. The crystal particles are linked by weak van der Waals forces. These bonds are easily broken by mechanical action during processing, and the consistency may be greatly influenced by such mechanical forces. After a rest period, some

of these bonds are reformed and the reversible sol-gel transformation taking place is called thixotropy. There appear to be two types of bonds in fats—those that are reformed after mechanical action, and those that do not reform. The latter result in a portion of the hardness loss that is irreversible. The nature of these bonds has not been established with certainty, but it is assumed to mainly involve van der Waals forces. The hardness loss of fats as a result of working is

called work softening and can be expressed as follows:

$$WS = \frac{H_o - H_w}{H_o} \times 100\%$$

where H_o and H_w are the hardness before and after working.

The work softening is influenced not only by the nature of the mechanical treatment but also by temperature conditions and the size and quantity of fat crystals.

Tanaka et al. (1971) have used a two-element mechanical model (Figure 8-32) to represent fats as viscoplastic materials. The model consists of a dashpot representing the viscous element in parallel with a friction element that represents the yield value.

The theory of bond formation between the crystal particles in plastic fats needs revision. Recently, it has been proposed that a process of "sintering"—the formation of solid bridges between fat crystals—occurs during

postcrystallization hardening (Heertje et al., 1987; Johansson and Bergenstahl 1995). The use of the word *sintering* is unfortunate since it describes the fusion of small particles into a solid block; this is not the case, however, because the fat crystals in fats can be suspended in a solvent such as isobutanol (Chawla and deMan 1990) without showing any sign of fusion into larger aggregates. At the solid fat level found in plastic fats (15 to 35 percent), the crystals are tightly packed together and exist in a state of entanglement (deMan 1997). Entanglement of crystals is a more realistic description of the structure formation in fats. The sintering process described above can be considered a form of entanglement.

Many interrelated factors influence the texture of plastic fats. Fatty acid and glyceride composition are basic factors in establishing the properties of a fat. These factors, in turn, are related to solid fat content, crystal size and shape, and polymorphic behavior. Once the crystal network is formed, mechanical treatment and temperature history may influence the texture.

The network systems in plastic fats differ from those in protein or carbohydrate systems. Fat crystals are embedded in liquid oil and the crystals have no ionized groups. Therefore, the interactive forces in fat crystal networks are low. The minimum concentration of solid particles in a fat to provide a yield value is in the range of 10 to 15 percent.

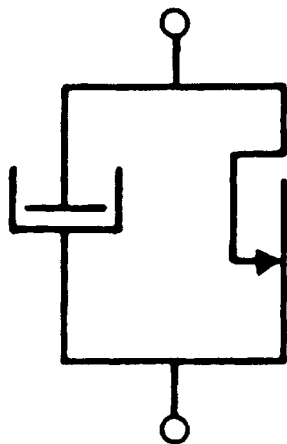

Figure 8-32 Mechanical Model for Foods as Viscoplastic Materials. *Source:* From M. Tanaka, et al., *Measurement of Textural Properties of Foods with a Constant Speed Cone Penetrometer*, *J. Texture Studies*, Vol. 2, pp. 301-315, 1971.

Fruits and Vegetables

Much of the texture work with fruits and vegetables has been done with the Kramer shear press. The shear press was developed because of the tenderometer's limitations and has been widely used for measuring tender-

ness of peas for processing (Kramer 1961). The shear press is also used, for example, in the quality method suggested for raw and canned sweet corn (Kramer and Cooler 1962). This procedure determines shear force with the standard shear cell and amount of juice pressed out with the juice extraction cell. It is possible to relate quality of the corn to these parameters. In addition to the shear press, the Instron universal testing machine and others based on the same principle are popular for fruit and vegetable products. A special testing machine has been developed by Mohsenin (1970). This machine uses an air motor for movement of the crosshead but is otherwise similar to other universal testing machines. A mechanically driven test system has been developed by Voisey (1971). Voisey (1970) has also described a number of test cells that are simpler in design than the standard shear cell of the shear press.

The texture of fruit and vegetable products is related to the cellular structure of these materials. Reeve and Brown (1968a,b) studied the development of cellular structure in the green bean pod as it relates to texture and eating quality. Sterling (1968) studied the effect of solutes and pH on the structure and firmness of cooked carrot. Sterling also related histological changes such as cellular separation and collapse to the texture of the product. In fruits and vegetables the relationship between physical structure and physical properties is probably more evident than in many other products.

Morrow and Mohsenin (1966) have studied the physical properties of a variety of vegetables; they assumed these products to behave as viscoelastic materials and to behave according to the three-element model represented in Figure 8-33A. Such viscoelastic materials are characterized by the

strain-time and stress-time relationships, as given in Figure 8-33B,C.

Starch

The texture of starch suspensions is determined by the source of the starch, the chemical and/or physical modification of the starch granule, and the cooking conditions of the starch (Kruger and Murray 1976). The texture of starch suspensions is measured by means of the viscoamylograph. The viscosity is recorded while the temperature of the suspension is raised from 30° to 95°C, held at 95°C for 30 minutes, lowered to 25°C, and held at that temperature for 30 minutes. The viscosity of a 5 percent suspension of waxy corn is shown in Figure 8-34. Initially the viscosity is low, but it increases rapidly at the gelatinization temperature of about 73°C. As the granules swell, they become weaker and start to disintegrate causing the viscosity to drop. When the temperature is lowered to 25°C, there is another increase in viscosity caused by the interaction of the broken and deformed granules. This phenomenon is demonstrated by the width and irregularity of the recorded line, which is indicative of the cohesiveness of the starch particles.

Modification of the starch has a profound effect on the texture of the suspensions. Introduction of as little as 1 cross-bond per 100,000 glucose units slows the breakdown of the swollen granules during and after cooking (Figure 8-35). This results in a higher final viscosity. Increasing the cross-bonding to 1, 3, or 6 cross-bonds per 10,000 glucose units will result in no breakdown during the heating cycle (Figure 8-36). As the cross-bonding increases, the granule is strengthened and does not swell much during heating, but viscosity is decreased. Most food starches used at pH values of 4 to 8

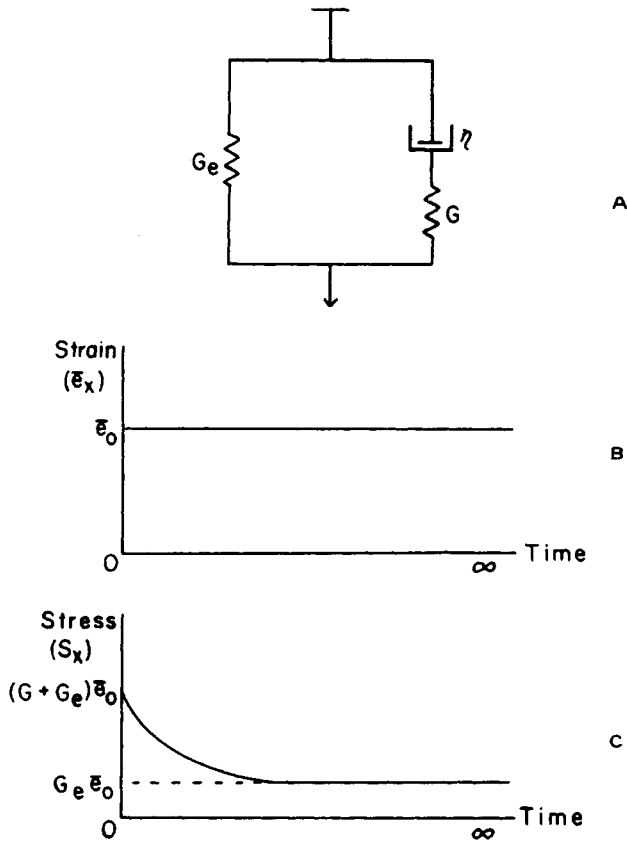

Figure 8-33 Mechanical Model Proposed by Morrow and Mohsenin. (A) Viscoelastic foods, (B) the strain time, (C) stress time, characteristics of the system.

have 2 to 3 cross-bonds per 10,000 glucose units.

Waxy corn starch contains only amylopectin; corn starch contains both amylopectin and amylose. This results in a different viscosity profile (Figure 8-37). Corn starch shows a lower peak viscosity and less breakdown during heating. After cooling, the viscosity continues to increase, probably because the amylose interlinks with the amylopectin. On further storage at 25°C, the slurry sets to a firm gel. Tapioca starch is intermediate between corn and waxy corn starch (Figure 8-37). This is explained by the

fact that tapioca amylose molecules are larger than those in corn starch.

Starches can be substituted by nonionic or ionic groups. The latter can be made anionic by introduction of phosphate or succinate groups. These have lower gelatinization temperature, higher peak viscosity, and higher final cold viscosity than nonionic starches (Figure 8-38).

MICROSTRUCTURE

With only a few exceptions, food products are non-Newtonian and possess a variety of

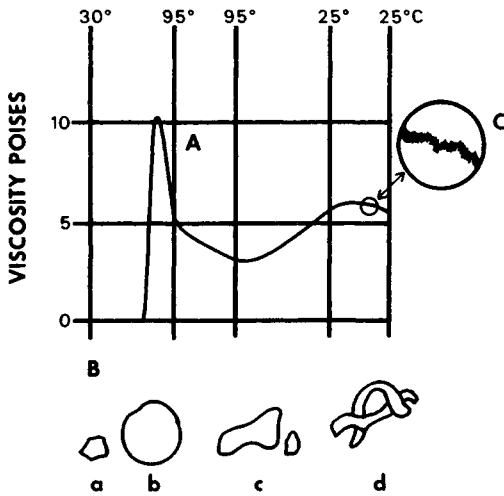

Figure 8-34 Viscosity and Granule Appearance in the Viscoamylograph Test of a 5% Suspension of Waxy Corn in Water. A = viscosity curve, B = granule shape and size, C = magnified portion of curve to indicate cohesiveness, a = unswollen granule, b = swollen granule, c = collapsed granule, d = entwined collapsed granules. *Source:* Reprinted from L.H. Kruger and R. Murray, Starch Texture, in *Rheology and Texture in Food Quality*, J.M. deMan, P.W. Voisey, V.F. Raspar, and D.W. Stanley, eds., © 1976, Aspen Publishers, Inc.

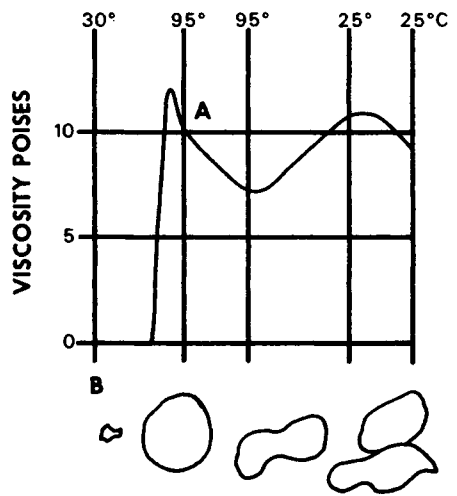

Figure 8-35 Viscosity and Granule Appearance in the Viscoamylograph Test of a 5% Suspension in Water of Waxy Corn with 1 Cross-Bond per 100,000 Glucose Units. A = viscosity curve, B = granule appearance. *Source:* Reprinted from L.H. Kruger and R. Murray, Starch Texture, in *Rheology and Texture in Food Quality*, J.M. deMan, P.W. Voisey, V.F. Raspar, and D.W. Stanley, eds., © 1976, Aspen Publishers, Inc.

internal structures. Cellular and fibrous structures are found in fruits and vegetables; fibrous structures are found in meat; and many manufactured foods contain protein, carbohydrate, or fat crystal networks.

Many of these food systems are dispersions that belong in the realm of colloids. Colloids are defined as heterogeneous or dispersed systems that contain at least two phases—the dispersed phase and the continuous phase. Colloids are characterized by their ability to exist in either the sol or the gel form. In the former, the dispersed particles

exist as independent entities; in the latter, they associate to form network structures that may entrap large volumes of the continuous phase. The isothermal reversible sol-gel transformation exhibited by many foods is called thixotropy. Disperse systems can be classified on the basis of particle size. Coarse dispersions have particle size greater than 0.5 μm . They can be seen in the light microscope, can be filtered over a paper filter, and will sediment rapidly. Colloidal dispersions have particles in the range of 0.5 μm to 1 nm. These particles remain in suspension by Brownian movement and can run through a paper filter but cannot run through a membrane filter. Particles smaller than these are

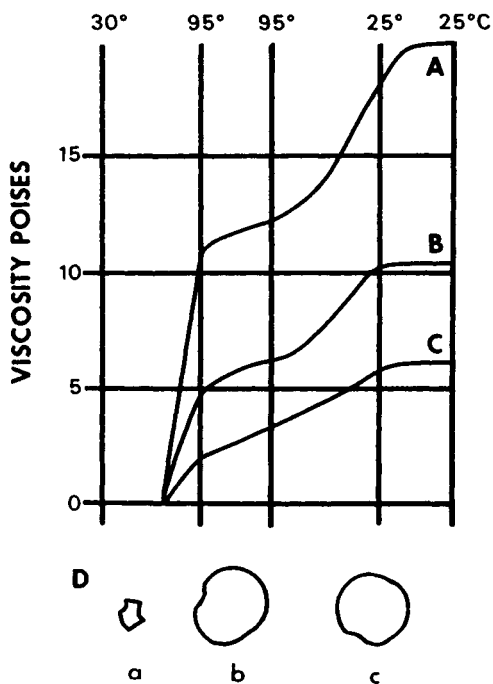

Figure 8-36 Viscosity and Granule Appearance in the Viscoamylograph of 5% Suspension in Water of Cross-Bonded Waxy Corn. A = 1 cross-bond per 10,000 glucose units, B = 3 cross-bonds, C = 6 cross-bonds, and D = granule appearance. *Source:* Reprinted from L.H. Kruger and R. Murray, Starch Texture, in *Rheology and Texture in Food Quality*, J.M. deMan, P.W. Voisey, V.F. Raspar, and D.W. Stanley, eds., © 1976, Aspen Publishers, Inc.

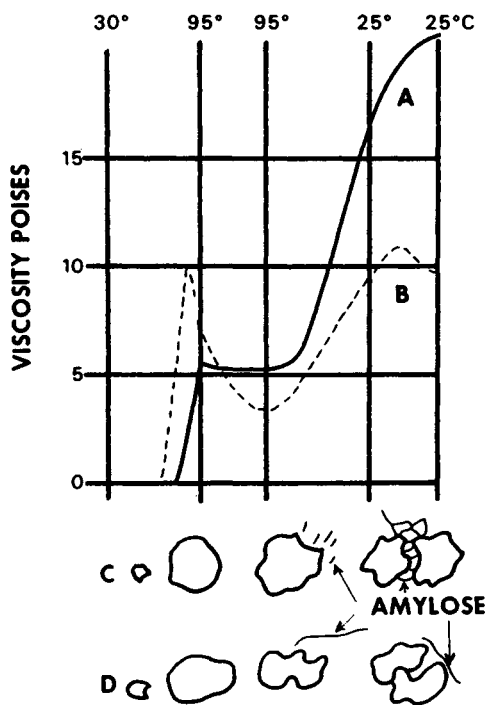

Figure 8-37 Viscosity and Granule Appearance in the Viscoamylograph of Suspensions in Water of Corn and Tapioca Starch. A = 6% corn starch, B = 5% tapioca starch, C = corn granule appearance, and D = tapioca granule appearance. *Source:* Reprinted from L.H. Kruger and R. Murray, Starch Texture, in *Rheology and Texture in Food Quality*, J.M. deMan, P.W. Voisey, V.F. Raspar, and D.W. Stanley, eds., © 1976, Aspen Publishers, Inc.

molecular dispersions or solutions. Depending on the nature of the two phases, disperse systems can be classified into a number of types. A solid dispersed in a liquid is called a sol; for example, margarine, which has solid fat crystals dispersed in liquid oil, is a sol. Dispersions of liquid in liquid are emulsions; many examples of these are found among foods such as milk and mayonnaise. Dispersions of gas in liquid are foams (e.g., whipped cream). In many cases, these dis-

persions are more complex than one disperse phase. Many foods have several dispersed phases. For instance, in chocolate, solid cocoa particles as well as fat crystals are dispersed phases.

The production of disperse systems is often achieved by dispersion methods in which the disperse phase is subdivided into small particles by mechanical means. Liq-

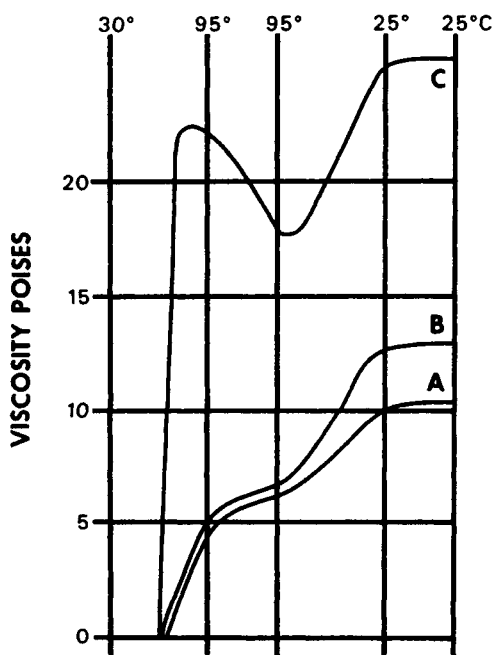

Figure 8-38 Viscoamylograph Viscosity Curves of Substituted Waxy Corn Starch. A = cross-bonded waxy corn, B = nonionic substituted cross-bonded waxy corn, and C = anionic substituted cross-bonded waxy corn. Source: Reprinted from L.H. Kruger and R. Murray, *Starch Texture, in Rheology and Texture in Food Quality*, J.M. deMan, P.W. Voisey, V.F. Raspar, and D.W. Stanley, eds., © 1976, Aspen Publishers, Inc.

uids are emulsified by stirring and homogenization; solids are subdivided by grinding, as, for instance, roller mills are used in chocolate making and colloid mills are used in other food preparations.

An important aspect of the subdivision of the disperse phase is the enormous increase in specific surface area. If a sphere with a radius $R = 1$ cm is dispersed into particles with radius $r = 10^{-6}$ cm, the area of the interface will increase by a factor of 10^6 . The

mechanical work dA needed to increase the interfacial area is proportional to the area increase, as follows:

$$dA = \sigma dO$$

where O = total interfacial area. The proportionality factor σ is the surface tension. In the production of emulsions, the surface tension is reduced by using surface active agents (see Chapter 2).

As particle size is reduced to colloidal dimensions, the particles are subject to Brownian movement. Brownian movement is the result of the random thermal movement of molecules, which impact on colloidal particles to give them a random movement as well (Figure 8-39). The size of dispersed particles has a profound effect on the properties of dispersions (Schubert 1987). Figure 8-40 shows the qualitative relationship of particle size and system properties. As particle size decreases, fracture resistance increases. The particles become increasingly uniform, which results in a grinding limit below which particles cannot be further reduced in size. The terminal settling rate, illustrated by a flour particle falling through the air, increases rapidly as a function of increasing particle size. According to Schubert (1987), a flour particle of $1 \mu\text{m}$ in size takes more than 6 hours to fall a distance of 1 meter in still air. Wetting becomes more difficult as size decreases. The specific surface area (the surface per unit volume) increases rapidly with decreasing particle size.

Colloidal systems, because of their large number of dispersed particles, show non-Newtonian flow behavior. For a highly dilute dispersion of spherical particles, the following equation has been proposed by Einstein:

$$\eta = \eta_0 (1 + 2.5 \phi)$$

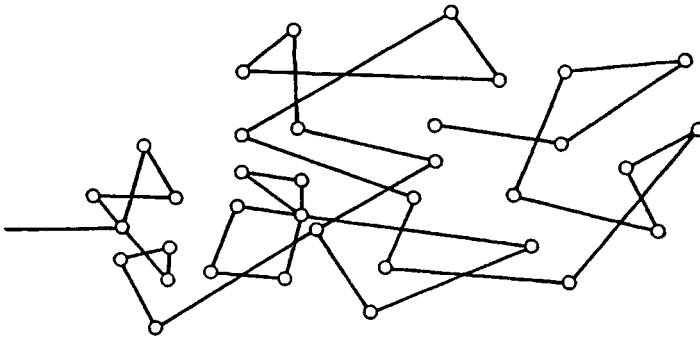

Figure 8-39 Flat Plane Projection of the Location of a Colloidal Particle Subject to Brownian Movement. *Source:* From H. Schubert, *Food Particle Technology. Part 1: Properties of Particles and Particulate Food Systems*, *J. Food Eng.*, Vol. 6, pp. 1-32, 1987, Elsevier Applied Science Publishers, Ltd.

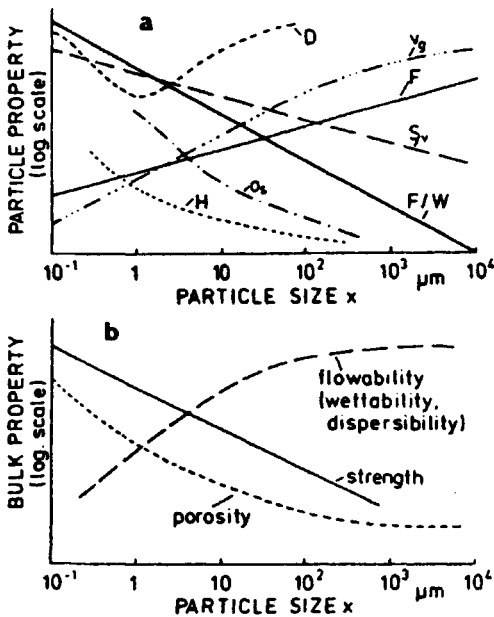

Figure 8-40 Relationship Between Particle Size and System Properties. D = particle deposition in fibrous fillers, F = adhesion force, H = homogeneity of a particle, S_v = surface area per unit volume, W = particle weight, V_g = terminal setting rate, σ_s = particle fracture resistance. *Source:* From H. Schubert, *Food Particle Technology. Part 1: Properties of Particles and Particulate Food Systems*, *J. Food Eng.*, Vol. 6, pp. 1-32, 1987, Elsevier Applied Science Publishers, Ltd.

where

η_0 = viscosity of the continuous phase

ϕ = ratio of volumes of disperse and continuous phases

In this equation, viscosity is independent of the degree of dispersion. As soon as the ratio of disperse and continuous phases increases to the point where particles start to interact, the flow behavior becomes more complex. The effect of increasing the concentration of the disperse phase on the flow behavior of a disperse system is shown in Figure 8-41. The disperse phase, as well as the low solids dispersion (curves 1 and 2), shows Newtonian flow behavior. As the solids content increases, the flow behavior becomes non-Newtonian (curves 3 and 4). Especially with anisotropic particles, interaction between them will result in the formation of three-dimensional network structures. These network structures usually show non-Newtonian flow behavior and viscoelastic properties and often have a yield value. Network structure formation may occur in emulsions (Figure 8-42) as well as in particulate systems. The forces between particles that result in the formation of networks may be

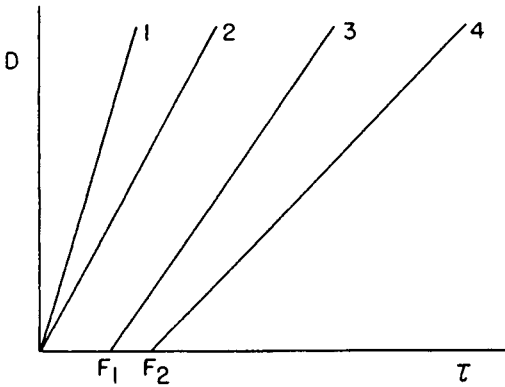

Figure 8-41 Effect of Increasing the Concentration of the Disperse Phase on the Flow Behavior of a Disperse System. 1—continuous phase, 2—low solids content, 3—medium solids content, 4—high solids content.

van der Waals forces, hydrophobic interactions, or covalent bonds. Network formation may result from heating or from chemical reactions that occur spontaneously either from components already present in the food or from added enzymes or coagulants. The formation of networks requires a minimal fraction of particles to be present, the critical

fraction α_c , and the larger the number of sites f , used for bond formation, the sooner a network is formed. These two quantities are related as follows:

$$\alpha_c = 1/(f - 1)$$

At particle concentrations below 10 percent, numerous contact points are required to form a network structure (Table 8-3). This means that only certain types of molecules or particles can form networks at this concentration. As the network is formed, the viscosity increases until, at a certain point, the product acquires plastic and/or viscoelastic properties. Network formation thus depends on particle concentration, reactive sites on the particles, and particle size and shape. Heertje et al. (1985) investigated structure formation in acid milk gels and found that the final texture of the products was influenced by many factors including heat, salt balance, pH, culture, and thickening agents. Structure formation in soy milk, induced by coagulants in the form of calcium or magnesium salts, results in a semisolid food called tofu, which has a fine internal protein network structure (Figure 8-43). Hermansson

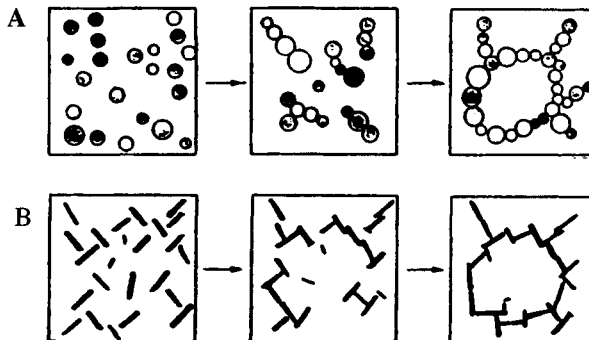

Figure 8-42 Structure Formation in Particulate Systems. (A) Flocculation of an emulsion. (B) Network formation in crystallized fat.

Table 8-3 Relationship Between Critical Particle Fraction (α_c) and Number of Bond Sites (f)

α_c	f
0.05	21
0.10	11
0.15	8
0.20	6
0.30	4
0.50	3

and Larsson (1986) reported on the structure of gluten gels and concluded that these gels consist of a continuous phase of densely packed protein units.

DeMan and Beers (1987) have reviewed the factors that influence the formation of three-dimensional fat crystal networks. The fat crystal networks in plastic fats (Figure 8-44) are highly thixotropic, and mechanical action on these products will result in a drastic reduction of hardness.

A variety of rheological tests can be used to evaluate the nature and properties of different network structures in foods. The strength of bonds in a fat crystal network can be evaluated by stress relaxation and by the decrease in elastic recovery in creep tests as a function of loading time (deMan et al. 1985). Van Kleef et al. (1978) have reported on the determination of the number of cross-links in a protein gel from its mechanical and swelling properties. Oakenfull (1984) used shear modulus measurements to estimate the size and thermodynamic stability of junction zones in noncovalently cross-linked gels.

Dynamic measurements of gels can provide information on the extent of cross-linking (Bell 1989). Systems with a relatively high storage modulus G' show a low value for G''/G' , which indicates a highly cross-linked system such as an agar gel.

WATER ACTIVITY AND TEXTURE

Water activity (a_w) and water content have a profound influence on textural properties of foods. The three regions of the sorption isotherm can be used to classify foods on the basis of their textural properties (Figure 8-45). Region 3 is the high moisture area, which includes many soft foods. Foods in the intermediate moisture area (region 2) appear dry and firm. At lowest values of a_w (region 1), most products are hard and crisp (Bourne 1987).

Katz and Labuza (1981) examined the relationship between a_w and crispness in a study of the crispness of popcorn (Figure 8-46). They found a direct relationship between crispness and a_w .

Many foods contain biopolymers and low molecular weight carbohydrates. These can be present in a metastable amorphous state that is sensitive to temperature and the state

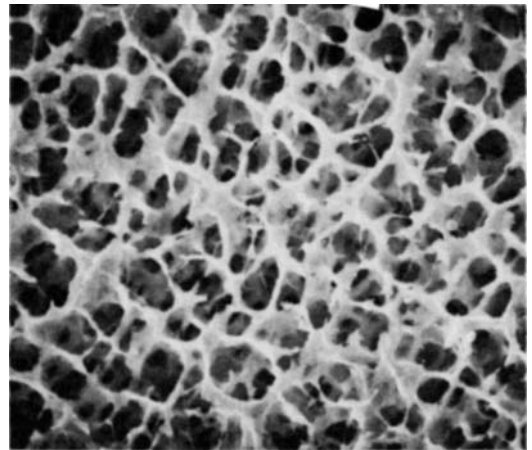

Figure 8-43 Microstructure of Soybean Curd (Tofu) as Seen in the Scanning Electron Microscope

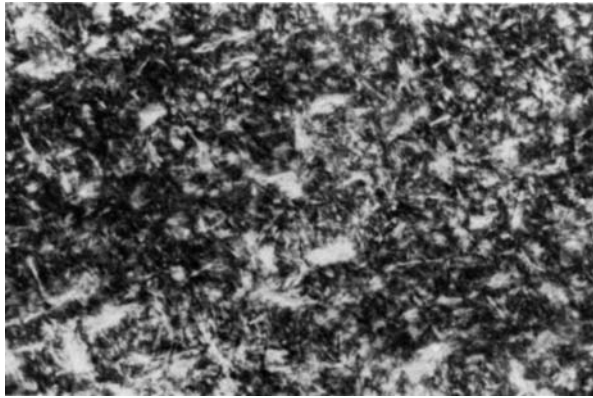

Figure 8-44 Fat Crystals in a Partially Crystallized Fat as Seen in the Polarizing Microscope

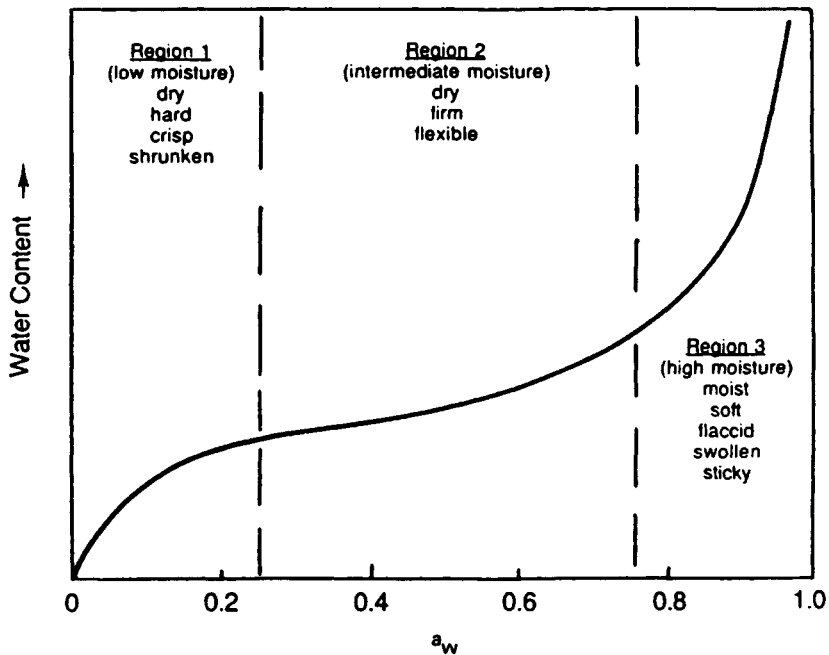

Figure 8-45 The Three Regions of the Sorption Isotherm Related to the Textural Properties of Food Systems. *Source:* Reprinted with permission from M.C. Bourne, Effects of Water Activity on Textural Properties of Food, in *Water Activity: Theory and Applications to Food*, L.B. Rockland and L.R. Beuchat, eds., p. 76, 1987, by courtesy of Marcel Dekker, Inc.

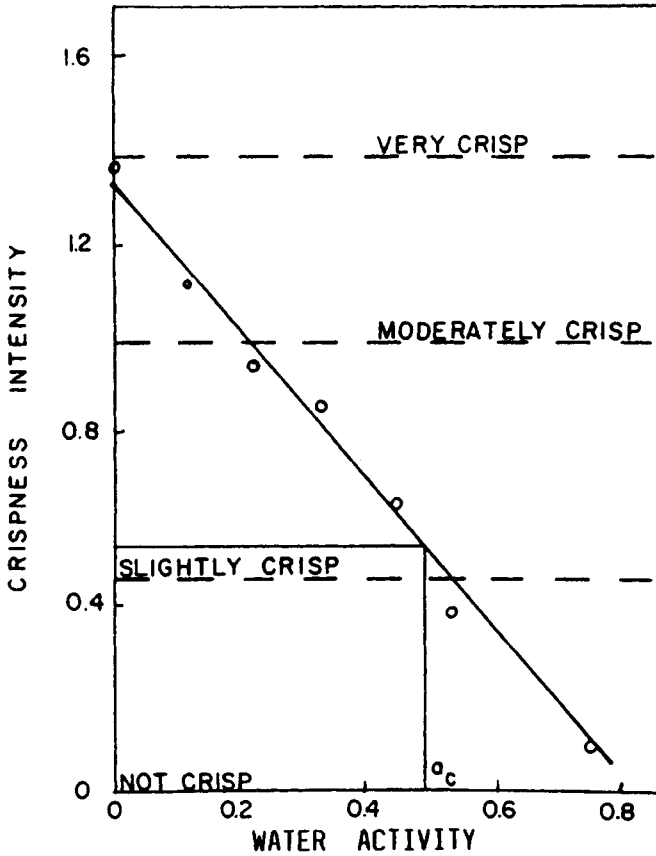

Figure 8-46 Relationship Between Water Activity and Crispness of Popcorn. *Source:* Reprinted with permission from E.E. Katz and T.P. Labuza, Effect of Water Activity on the Sensory Crispness and Mechanical Deformation of Snack Food Properties, *J. Food Sci.*, Vol. 46, p. 403, © 1981, Institute of Food Technologists.

of water. The amorphous state can be in the form of a rubbery structure or a very viscous glass, as shown in Figure 8-47 (Slade and Levine 1991; Levine and Slade 1992; Roos and Karel 1991). A more detailed analysis of the effect of temperature on textural properties expressed as modulus is presented in Figure 8-48. Below the melting temperature, the material enters a state of rubbery flow. As the temperature is lowered further, a leathery state is observed. In

the leathery region the modulus increases sharply, until the glass transition temperature (T_g) is reached and the material changes to a glass.

Kapsalis et al. (1970) reported on a study of the textural properties of freeze-dried beef at different points of the moisture sorption isotherm over the complete range of water activity. Important changes in textural properties were observed at a_w values of 0.85 and at 0.15 to 0.30.

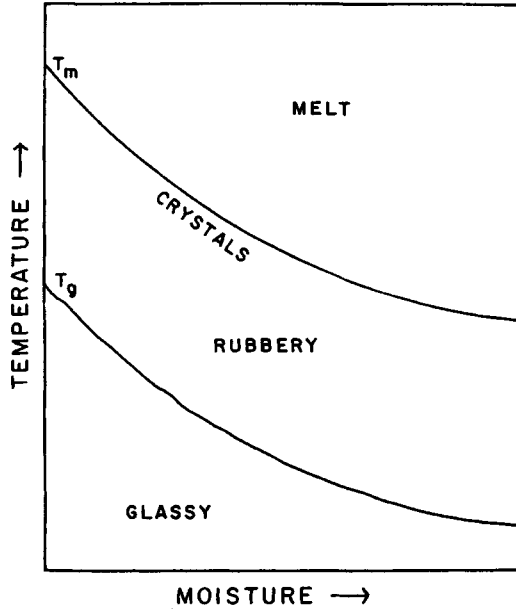

Figure 8-47 Rubbery and Glassy State of Moisture-Containing Foods as Affected by Temperature. T_m = melting point; T_g = glass transition temperature.

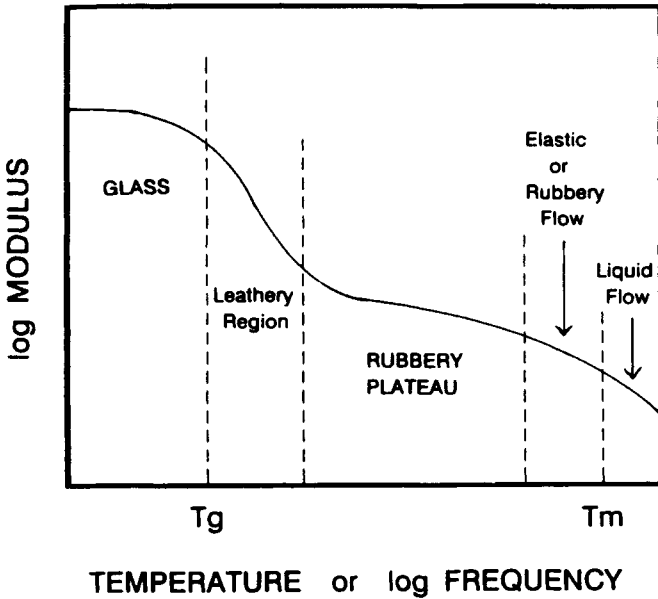

Figure 8-48 Effect of Temperature on the Texture as Expressed by Modulus. T_m = melting temperature, T_g = glass transition temperature.

REFERENCES

- Bell, A.E. 1989. Gel structure and food biopolymers. In *Water and food quality*, ed. T.M. Hardman. New York: Elsevier Science.
- Bjorksten, J., et al. 1967. A portable rotating knife tenderometer. *Food Technol.* 21: 84–86.
- Bourne, M.C. 1966. Measure of shear and compression components of puncture tests. *J. Food Sci.* 31: 282–291.
- Bourne, M.C. 1987. Effects of water activity on textural properties of food. In *Water activity: Theory and applications to food*, ed. L.B. Rockland and L.R. Beuchat. New York: Marcel Dekker.
- Brandt, M.A., et al. 1963. Texture profile method. *J. Food Sci.* 28: 404–409.
- Bratzler, L.J. 1932. Measuring the tenderness of meat by means of a mechanical shear. Master's thesis, Kansas State College.
- Cairncross, S.E., and L.B. Sjöström. 1950. Flavor profiles—A new approach to flavor problems. *Food Technol.* 4: 308–311.
- Chawla, P., and J.M. deMan. 1990. Measurement of the size distribution of fat crystals using a laser particle counter. *J. Am. Oil Chem. Soc.* 67: 329–332.
- deMan, J.M. 1969. Food texture measurements with the penetration method. *J. Texture Studies* 1: 114–119.
- deMan, J.M. 1997. Relationship between chemical, physical and textural properties of fats. Paper presented at International Conference on Physical Properties of Fats, Oils, Emulsifiers, September, Chicago.
- deMan, J.M., and A.M. Beers. 1987. Fat crystal networks: Structure and rheological properties. *J. Texture Studies* 18: 303–318.
- deMan, J.M., and F.W. Wood. 1959. Hardness of butter. II. Influence of setting. *J. Dairy Sci.* 42: 56–61.
- deMan, J.M., et al. 1985. Viscoelastic properties of plastic fat products. *J. Am. Oil Chem. Soc.* 62: 1672–1675.
- deMan, L., et al. 1991. Physical and textural characteristics of some North American shortenings. *J. Am. Oil Chem. Soc.* 68: 63–69.
- deMan, L., and J.M. deMan. 1996. Textural measurements of some plastic fats: Oils, fats, lipids. *Proceedings of the International Society for Fat Research (ISF), the Hague 1995*, 3: 543–546. Bridgewater, UK: P.J. Barnes & Assoc.
- Haighton, A.J. 1959. The measurement of hardness of margarine and fats with the penetrometers. *J. Am. Oil Chem. Soc.* 36: 345–348.
- Heertje, I., et al. 1985. Structure formation in acid milk gels. *Food Microstructure* 4: 267–278.
- Heertje, I., et al. 1987. Product morphology of fat products. *Food Microstructure* 6: 1–8.
- Hermansson, A.M., and K. Larsson. 1986. The structure of gluten gels. *Food Microstructure* 5: 233–240.
- Howard, R.D., and M.D. Judge. 1968. Comparison of sarcomere length to other predictors of beef tenderness. *J. Food Sci.* 33: 456–460.
- Johansson, D., and B. Bergenstahl. 1995. Sintering of fat crystals in oil during post-crystallization processes. *J. Am. Oil Chem. Soc.* 72: 911–920.
- Johnston, C.W., and C.H. Brower. 1966. Rheological and gelation measurements of plastisols. *Soc. Plastics Eng. J.* 22, no. 11: 45–52.
- Kamel, B.S., and J.M. deMan. 1975. Evaluation of gelatin gel texture by penetration tests. *Lebensm. Wiss. Technol.* 8: 123–127.
- Kapsalis, J.G., et al. 1970. A physico-chemical study of the mechanical properties of low and intermediate moisture foods. *J. Texture Studies* 1: 464–483.
- Katz, E.E., and T.P. Labuza. 1981. Effect of water activity on the sensory crispness and mechanical deformation of snack food properties. *J. Food Sci.* 46: 403–409.
- Kleinert, J. 1976. Rheology of chocolate. In *Rheology and texture in food quality*, ed. J.M. deMan et al. Westport, CT: AVI Publishing Co.
- Kokini, J.L. 1985. Fluid and semi-solid food texture and texture-taste interactions. *Food Technol.* 11: 86–94.
- Kramer, A. 1961. The Shear-Press, a basic tool for the food technologist. *Food Scientist* 5: 7–16.
- Kramer, A., and J.C. Cooler. 1962. An instrumental method for measuring quality of raw and canned sweet corn. *Proc. Am. Soc. Hort. Sci.* 81: 421–427.
- Kruger, L.H., and R. Murray. 1976. Starch texture. In *Rheology and texture in food quality*, ed. J.M. deMan et al. Westport, CT: AVI Publishing Co.
- Levine, H., and L. Slade. 1992. Glass transitions in foods. In *Physical chemistry of foods*, ed. H.G. Schwartzberg and R.W. Hartel. New York: Marcel Dekker.

- Miyada, D.S., and A.L. Tappel. 1956. Meat tenderization. I. Two mechanical devices for measuring texture. *Food Technol.* 10: 142-145.
- Mohsenin, N.N. 1970. *Physical properties of plant and animal materials*, Vol. 1, *Structure, physical characteristics and mechanical properties*. New York: Gordon and Breach Science Publisher.
- Morrow, C.T., and N.N. Mohsenin. 1966. Consideration of selected agricultural products as viscoelastic materials. *J. Food Sci.* 31: 686-698.
- Oakenfull, D. 1984. A method for using measurements of shear modulus to estimate the size and thermodynamic stability of junction zones in non-covalently cross linked gels. *J. Food Sci.* 49: 1103-1110.
- Prentice, J.H. 1954. An instrument for estimating the spreadability of butter. *Lab. Practice* 3: 186-189.
- Proctor, B.E., et al. 1956. A recording strain-gage denture tenderometer for foods. II. Studies on the masticatory force and motion and the force penetration relationship. *Food Technol.* 10: 327-331.
- Reeve, R.M., and M.S. Brown. 1968a. Histological development of the bean pod as related to culinary texture. 1. Early stages of pod development. *J. Food Sci.* 33: 321-326.
- Reeve, R.M., and M.S. Brown. 1968b. Histological development of the bean pod as related to culinary texture. 2. Structure and composition of edible maturity. *J. Food Sci.* 33: 326-331.
- Roos, Y., and M. Karel. 1991. Plasticizing effect of water on thermal behavior and crystallization of amorphous food models. *J. Food Sci.* 56: 38-43.
- Saravacos, G.D. 1968. Tube viscometry of fruit purees and juices. *Food Technol.* 22: 1585-1588.
- Saravacos, G.D., and J.C. Moyer. 1967. Heating rates of fruit products in an agitated kettle. *Food Technol.* 21: 372-376.
- Scherr, H.J., and L.P. Wittnauer. 1967. The application of a capillary extrusion rheometer to the determination of the flow characteristics of lard. *J. Am. Oil Chem. Soc.* 44: 275-280.
- Schubert, H. 1987. Food particle technology. Part 1: Properties of particles and particulate food systems. *J. Food Eng.* 6: 1-32.
- Sherman, P. 1969. A texture profile of foodstuffs based upon well-defined rheological properties. *J. Food Sci.* 34: 458-462.
- Sherman, P. 1973. Structure and textural properties of foods. In *Texture measurement of foods*, ed. A. Kramer and A.S. Szczesniak. Dordrecht, The Netherlands: D. Reidel Publishing Co.
- Shoemaker, C.F., et al. 1987. Instrumentation for rheological measurements of food. *Food Technol.* 41, no. 3: 80-84.
- Slade, L., and H. Levine. 1991. A food polymer science approach to structure-property relationships in aqueous food systems. In *Water relationships in foods*, ed. H. Levine and L. Slade. New York: Plenum Press.
- Sperring, D.D., et al. 1959. Tenderness in beef muscle as measured by pressure. *Food Technol.* 13: 155-158.
- Steffe, J.F., and F.A. Osorio. 1987. Back extrusion of non-Newtonian fluids. *Food Technol.* 41, no. 3: 72-77.
- Sterling, C. 1968. Effect of solutes and pH on the structure and firmness of cooked carrot. *J. Food Technol.* 3: 367-371.
- Stoner, D.L., et al. 1974. A mechanical model for post-mortem striated muscle. *J. Texture Studies* 4: 483-493.
- Szczesniak, A.S. 1963. Classification of textural characteristics. *J. Food Sci.* 28: 385-389.
- Szczesniak, A.S., and D.H. Kleyn. 1963. Consumer awareness of texture and other food attributes. *Food Technol.* 17: 74-77.
- Szczesniak, A.S., et al. 1970. Behavior of different foods in the standard shear compression cell of the shear press and the effect of sample weight on peak area and maximum force. *J. Texture Studies* 1: 356-378.
- Tanaka, M., et al. 1971. Measurement of textural properties of foods with a constant speed cone penetrometer. *J. Texture Studies* 2: 301-315.
- Van Kleef, F.S.M., et al. 1978. Determination of the number of crosslinks in a protein gel from its mechanical and swelling properties. *Biopolymers* 17: 225-235.
- Vasic, I., and J.M. deMan. 1967. Measurement of some rheological properties of plastic fat with an extrusion modification of the shear press. *J. Am. Oil Chem. Soc.* 44: 225-228.
- Vasic, I., and J.M. deMan. 1968. Effect of mechanical treatment on some rheological properties of butter. In *Rheology and texture of foodstuffs*, 251-264. London: Society of Chemical Industry.
- Voisey, P.W. 1970. Test cells for objective textural measurements. *Can. Inst. Food Sci. Technol. J.* 4: 91-103.
- Voisey, P.W. 1971. The Ottawa texture measuring system. *Can. Inst. Food Sci. Technol. J.* 4: 91-103.
- Voisey, P.W., and J.M. deMan. 1970. A recording food grinder. *Can. Inst. Food Sci. Technol. J.* 3: 14-18.

Voisey, P.W., and H. Hansen. 1967. A shear apparatus for meat tenderness evaluation. *Food Technol.* 21: 37A-42A.

Wehrl, H.P., and Y. Pomeranz. 1969. The role of chemical bonds in dough. *Bakers' Digest* 43: no. 6: 22-26.

Vitamins

INTRODUCTION

Vitamins are minor components of foods that play an essential role in human nutrition. Many vitamins are unstable under certain conditions of processing and storage (Table 9-1), and their levels in processed foods, therefore, may be considerably reduced. Synthetic vitamins are used extensively to compensate for these losses and to restore vitamin levels in foods. The vitamins are usually divided into two main groups, the water-soluble and the fat-soluble vitamins. The occurrence of the vitamins in the various food groups is related to their water- or fat-solubility. The relative importance of certain types of foods in supplying some of the important vitamins is shown in Table 9-2. Some vitamins function as part of a coenzyme, without which the enzyme would be ineffective as a biocatalyst. Frequently, such coenzymes are phosphorylated forms of vitamins and play a role in the metabolism of fats, proteins, and carbohydrates. Some vitamins occur in foods as provitamins—compounds that are not vitamins but can be changed by the body into vitamins. Vitamins are members of the same vitamin family.

Lack of vitamins has long been recognized to result in serious deficiency diseases.

It is now also recognized that overdoses of certain vitamins, especially some of the fat-soluble ones, may result in serious toxic effects. For this reason, the addition of vitamins to foods should be carefully controlled.

The sources of vitamins in significant amounts by food groups have been listed by Combs (1992) as follows:

- Meats, poultry, fish, and beans provide thiamin, riboflavin, niacin, pyridoxine, pantothenic acid, biotin, and vitamin B₁₂.
- Milk and milk products provide vitamins A and D, riboflavin, pyridoxine, and vitamin B₁₂.
- Bread and cereals provide thiamin, riboflavin, niacin, pyridoxine, folate, pantothenic acid, and biotin.
- Fruits and vegetables provide vitamins A and K, ascorbic acid, riboflavin, and folate.
- Fats and oils provide vitamins A and E.

FAT-SOLUBLE VITAMINS

Vitamin A (Retinol)

The structural formula of vitamin A is shown in Figure 9-1. It is an alcohol that occurs in nature predominantly in the form

Table 9-1 Stability of Vitamins under Different Conditions

Vitamin	Vitamin	Unstable To:						Most Stable
		UV Light	Heat ^a	O ₂	Acid	Base	Metals ^b	
vitamin A	retinol	+		+	+		+	dark, seal
	retinal			+	+		+	seal
	retinoic acid							good stability
	dehydroret.			+				seal
	ret. esters							good stability
	β-carotene			+				seal
vitamin D	D ₂	+	+	+	+		+	dark, cool, seal
	D ₃	+	+	+	+		+	dark, cool, seal
vitamin E	tocopherols		+	+	+	+	+	cool, neutral pH
	tocopherol esters				+	+		good stability
vitamin K	K	+		+		+	+	avoid reductants ^c
	MK	+		+		+	+	avoid reductants ^c
	menadione	+				+	+	avoid reductants ^c
vitamin C	ascorbic acid			+ ^b		+	+	seal, neutral pH
thiamine	disulfide form		+	+	+	+	+	neutral pH ^c
	hydrochloride ^d		+	+	+	+	+	seal, neutral pH ^c
riboflavin	riboflavin	+ ^e	+			+	+	dark, pH 1.5–4 ^c
niacin	nicotinic acid							good stability
	nicotinamide							good stability
	pyridoxal	+	+					cool
	pyridoxol (HCl)							good stability
biotin	biotin			+		+		seal, neutral pH
pantothenic acid	free acid ^f	+		+		+		cool, neutral pH
	Ca salty ^d		+					seal, pH 6–7
folate	FH ₄	+	+	+	+ ^g		+	good stability ^c
vitamin B ₁₂	CN-B ₁₂	+			+ ^h		+ ⁱ	good stability ^c

^ai.e., 100°C^bin solution with Fe⁺⁺⁺ and Cu⁺⁺^cunstable to reducing agents^dslightly hygroscopic^eespecially in alkaline solution^fvery hygroscopic^gpH < 5^hpH < 3ⁱpH > 9

Source: Reprinted with permission from G.F. Combs, *The Vitamins: Fundamental Aspects in Nutrition and Health*, p. 449, © 1992, Academic Press.

Table 9-2 Contributions (%) of Various Food Groups to the Vitamin Intake of Americans

Foods	Vitamin A	Vitamin C	Thiamin	Riboflavin	Niacin	Vitamin B ₆	Vitamin B ₁₂
vegetables	39.4	51.8	11.7	6.9	12.0	22.2	—
legumes	—	—	5.4	—	8.2	5.4	—
fruits	8.0	39.0	4.4	2.2	2.5	8.2	—
grain products	—	—	41.2	22.1	27.4	10.2	1.6
meats	22.5	2.0	27.1	22.2	45.0	40.0	69.2
milk products	13.2	3.7	8.1	39.1	1.4	11.6	20.7
eggs	5.8	—	2.0	4.9	—	2.1	8.5
fats and oils	8.2	—	—	—	—	—	—
other	2.7	3.4	—	—	3.3	—	—

Source: Reprinted with permission from G.F. Combs, *The Vitamins: Fundamental Aspects in Nutrition and Health*, p. 441, © 1992, Academic Press.

of fatty acid esters. Highest levels of vitamin A are found in certain fish liver oils, such as cod and tuna. Other important sources are mammalian liver, egg yolk, and milk and milk products. The levels of vitamin A and its provitamin carotene in some foods are listed in Table 9-3.

The structural formula of Figure 9-1 shows the unsaturated character of vitamin A. The all-*trans* form is the most active biologically. The 13-*cis* isomer is known as neo-vitamin A; its biological activity is only about 75 percent of that of the all-*trans* form. The amount of neo-vitamin A in natural vitamin A preparations is about one-third of the

total. The amount is usually much less in synthetic vitamin A. The synthetic vitamin A is made as acetate or palmitate and marketed commercially in the form of oil solutions, stabilized powders, or aqueous emulsions. The compounds are insoluble in water but soluble in fats, oils, and fat solvents.

Table 9-3 Vitamin A and Carotene Content of Some Foods

Product	Vitamin A (IU/100 g)	Carotene (mg/100 g)
Beef (grilled sirloin)	37	0.04
Butter (May–November)	2363–3452	0.43–0.77
Cheddar cheese	553–1078	0.07–0.71
Eggs (boiled)	165–488	0.01–0.15
Herring (canned)	178	0.07
Milk	110–307	0.01–0.06
Tomato (canned)	0	0.5
Peach	0	0.34
Cabbage	0	0.3
Broccoli (boiled)	0	2.5
Spinach (boiled)	0	6.0

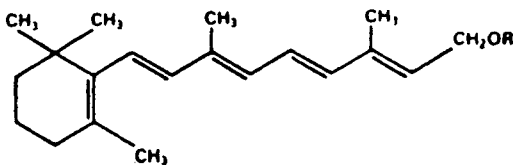

Figure 9-1 Structural Formula of Vitamin A. Acetate: R = CO·CH₃, Palmitate: R = CO·(CH₂)₁₄·CH₃.

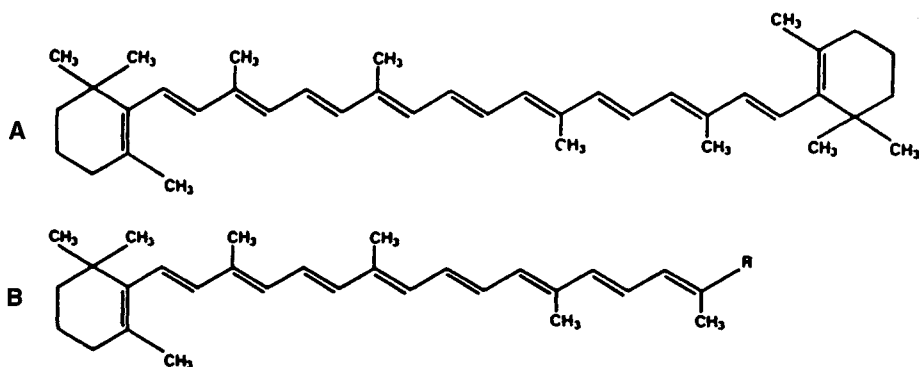

Figure 9-2 Structural Formulas of Some Provitamins A. (A) β -carotene, and (B) apocarotenal (R = CHO) and apocarotenoic acid ester (R = COOC₂H₅).

There are several provitamins A; these belong to the carotenoid pigments. The most important one is β -carotene, and some of the pigments that can be derived from it are of practical importance. These are β -apo-8'-carotenal and β -apo-8'-carotenoic acid ethyl ester (Figure 9-2). Other provitamins are α - and γ -carotene and cryptoxanthin.

Beta-carotene occurs widely in plant products and has a high vitamin A activity. In theory, one molecule of β -carotene could yield two molecules of vitamin A. The enzyme 15-15'-dioxygenase is able to cleave a β -carotene molecule symmetrically to produce two molecules of vitamin A (Figure 9-3). This enzyme occurs in intestinal mucosa, but the actual conversion is much less efficient. As shown in Figure 9-3, there are other reactions that may cause the yield of retinol to be less than 2. After cleavage of the β -carotene, the first reaction product is retinal, which is reduced to retinol (Rouseff and Nagy 1994). A general requirement for the conversion of a carotenoid to vitamin A is an unsubstituted β -ionone ring. Citrus fruits are a good source of provitamin A, which results mostly from

the presence of β -cryptoxanthin, β -carotene, and α -carotene. Gross (1987) reported a total of 16 carotenoids with provitamin A activity in citrus fruits.

Vitamin A levels are frequently expressed in International Units (IU), although this unit is officially no longer accepted. One IU equals 0.344 μ g of crystalline vitamin A acetate, or 0.300 μ g vitamin A alcohol, or 0.600 μ g β -carotene. The recommended daily allowance (RDA) of vitamin A of the National Research Council Food and Nutrition Board is 5000 IU for an adult. Other sources quote the human requirement at about 1 μ g/day. Conditions of rapid growth, pregnancy, or lactation increase the need for vitamin A.

Vitamin A, or retinol, is also known as vitamin A₁. Another form, vitamin A₂, is found in fish liver oils and is 3-dehydroretinol.

The Food and Agriculture Organization and the World Health Organization of the United Nations (FAO/WHO) and the National Academy of Sciences of the United States (1974a) have recommended that vitamin A activity be reported as the equivalent weight of retinol. To calculate total retinol equiva-

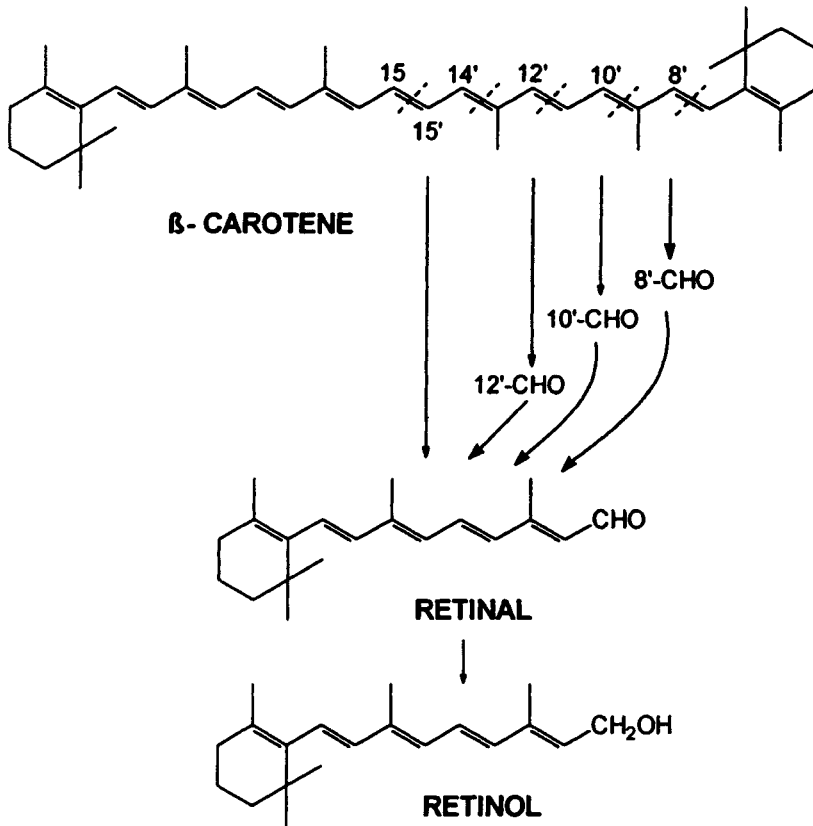

Figure 9-3 Conversion of Beta-Carotene to Vitamin A. *Source:* Reprinted with permission from R.R. Rouseff and S. Nagy, Health and Nutritional Benefits of Citrus Fruit Components, *Food Technology*, Vol. 48, No. 11, p. 125, © 1994, Institute of Food Technologists.

lents, it is proposed that food analyses list retinol, carotene, and other provitamin A carotenoids separately. It is also desirable to distinguish between the *cis*- and *trans*- forms of the provitamins in cooked vegetables. By definition, 1 retinol equivalent is equal to 1 μg of retinol, or 6 μg of β-carotene, or 12 μg of other provitamin A carotenoids. The National Academy of Sciences (1974a) states that 1 retinol equivalent is equal to 3.3 IU of retinol or 10 IU of β-carotene.

Vitamin A occurs only in animals and not in plants. The A₁ form occurs in all animals

and fish, the A₂ form in freshwater fish and not in land animals. The biological value of the A₂ form is only about 40 percent of that of A₁. Good sources of provitamin A in vegetable products are carrots, sweet potatoes, tomatoes, and broccoli. In milk and milk products, vitamin A and carotene levels are subject to seasonal variations. Hartman and Dryden (1965) report the levels of vitamin A in fluid whole milk in winter at 1,083 IU/L and in summer at 1,786 IU/L. Butter contains an average of 2.7 μg of carotene and 5.0 μg of vitamin A per g during winter and 6.1 μg

Table 9-4 Vitamin A and Carotene Stability in Foods

<i>Product</i>	<i>Nutrient Content</i>	<i>Storage Conditions</i>	<i>Retention (%)</i>
Vitamin A			
Butter	17,000–30,000 IU/lb	12 mo @ 5°C	66–98
		5 mo @ 28°C	64–68
Margarine	15,000 IU/lb	6 mo @ 5°C	89–100
		6 mo @ 23°C	83–100
Nonfat dry milk	10,000 IU/lb	3 mo @ 37°C	94–100
		12 mo @ 23°C	69–89
Fortified ready-to-eat cereal	4000 IU/oz	6 mo @ 23°C	83
Fortified potato chips	700 IU/100 g	2 mo @ 23°C	100
Carotene			
Margarine	3 mg/lb	6 mo @ 5°C	98
		6 mo @ 23°C	89
Lard	3.3 mg/lb	6 mo @ 5°C	100
		6 mo @ 23°C	100
Dried egg yolk	35.2 mg/100 g	3 mo @ 37°C	94
		12 mo @ 23°C	80
Carbonated beverage	7.6 mg/29 oz	2 mo @ 30°C	94
		2 mo @ 23°C	94
Canned juice drinks	0.6–1.3 mg/8 fl oz	12 mo @ 23°C	85–100

Source: From E. deRitter, Stability Characteristics of Vitamins in Processed Foods, *Food Technol.*, Vol. 30, pp. 48–51, 54, 1976.

of carotene and 7.6 μg of vitamin A per g during summer.

Vitamin A is used to fortify margarine and skim milk. It is added to margarine at a level of 3,525 IU per 100 g. Some of the carotenoids (provitamin A) are used as food colors.

Vitamin A is relatively stable to heat in the absence of oxygen (Table 9-4). Because of the highly unsaturated character of the molecule, it is quite susceptible to oxidation—especially under the influence of light, whether sunlight or artificial light. Vitamin A is unstable in the presence of mineral acids but stable in alkali. Vitamin A and the carotenoids have good stability during various

food processing operations. Losses may occur at high temperatures in the presence of oxygen. These compounds are also susceptible to oxidation by lipid peroxides, and conditions favoring lipid oxidation also result in vitamin A breakdown. The prooxidant copper is especially harmful, as is iron to a lesser extent. Pasteurization of milk does not result in vitamin A loss, but exposure to light does. It is essential, therefore, that sterilized milk be packaged in light-impervious containers. Possible losses during storage of foods are more affected by duration of storage than by storage temperature. Blanching of fruits and vegetables helps prevent losses during frozen storage.

Vitamin A added to milk is more easily destroyed by light than the native vitamin A. This is not because natural and synthetic vitamin A are different, but because these two types of vitamin A are dispersed differently in the milk (deMan 1981). The form in which vitamin A is added to food products may influence its stability. Vitamin A in beadlet form is more stable than that added as a solution in oil. The beadlets are stabilized by a protective coating. If this coating is damaged by water, the stability of the vitamin is greatly reduced (de Man et al. 1986).

Vitamin D

This vitamin occurs in several forms; the two most important are vitamin D₂, or ergocalciferol, and vitamin D₃, or cholecalciferol. The structural formulas of these compounds are presented in Figure 9-4. Vitamin D does

not occur in plant products. Vitamin D₂ occurs in small amounts in fish liver oils; vitamin D₃ is widely distributed in animal products, but large amounts occur only in fish liver oils. Smaller quantities of vitamin D₃ occur in eggs, milk, butter, and cheese (Table 9-5).

The precursors of vitamins D₂ and D₃ are ergosterol and 7-dehydrocholesterol, respectively. These precursors or provitamins can be converted into the respective D vitamins by irradiation with ultraviolet light. In addition to the two major provitamins, there are several other sterols that can acquire vitamin D activity when irradiated. The provitamins can be converted to vitamin D in the human skin by exposure to sunlight. Because very few foods are good sources of vitamin D, humans have a greater likelihood of vitamin D deficiency than of any other vitamin deficiency. Enrichment of some foods with vitamin D has significantly helped to eradicate rickets, which is a vitamin D deficiency disease. Margarine and milk are the foods commonly used as carrier for added vitamin D.

The unit of activity of vitamin D is the IU, which is equivalent to the activity of 1 mg of a standard preparation issued by the WHO. One IU is also equivalent to the activity of 0.025 µg of pure crystalline vitamin D₂ or D₃. The human requirement amounts to 400

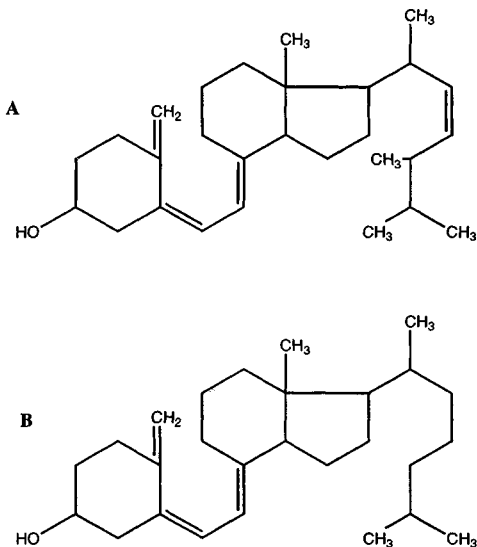

Figure 9-4 Structural Formulas of (A) Vitamin D₂ and (B) Vitamin D₃

Table 9-5 Vitamin D Content of Some Foods

<i>Product</i>	<i>Vitamin D (µg/1000 g Edible Portion)</i>
Liver (beef, pork)	2-5
Eggs	44
Milk	0.9
Butter	2-40
Cheese	12-47
Herring oil	2,500

to 500 IU but increases to 1,000 IU during pregnancy and lactation. Adults who are regularly exposed to sunlight are likely to have a sufficient supply of vitamin D. Excessive intakes are toxic.

Vitamin D is extremely stable, and little or no loss is experienced in processing and storage. Vitamin D in milk is not affected by pasteurization, boiling, or sterilization (Hartman and Dryden 1965). Frozen storage of milk or butter also has little or no effect on vitamin D levels, and the same result is obtained during storage of dry milk.

The vitamin D potency of milk can be increased in several ways: by feeding cows substances that are high in vitamin D activity, such as irradiated yeast; by irradiating milk; and by adding vitamin D concentrates. The latter method is now the only commonly used procedure. The practice of irradiating milk to increase the vitamin D potency has been discontinued, undoubtedly because of the deteriorative action of the radiation on other milk components. Vitamin D is added to milk to provide a concentration of 400 IU

per quart. Addition of vitamin D to margarine is at a level of 550 IU per 100 g.

Tocopherols (Vitamin E)

The tocopherols are derivatives of tocol, and the occurrence of a number of related substances in animal and vegetable products has been demonstrated. Cottonseed oil was found to contain α -, β -, and γ -tocopherol, and a fourth, δ -tocopherol, was isolated from soybean oil. Several other tocopherols have been found in other products, and Morton (1967) suggests that there are four tocopherols and four tocotrienols. The tocotrienols have three unsaturated isoprenoid groups in the side chain. The structure of tocol is given in Figure 9-5 and the structures of the tocopherols and tocotrienols in Figure 9-6. The four tocopherols are characterized by a saturated side chain consisting of three isoprenoid units. The tocotrienols have three double bonds at the 3', 7', and 11' carbons of the isoprenoid side chain (Figure

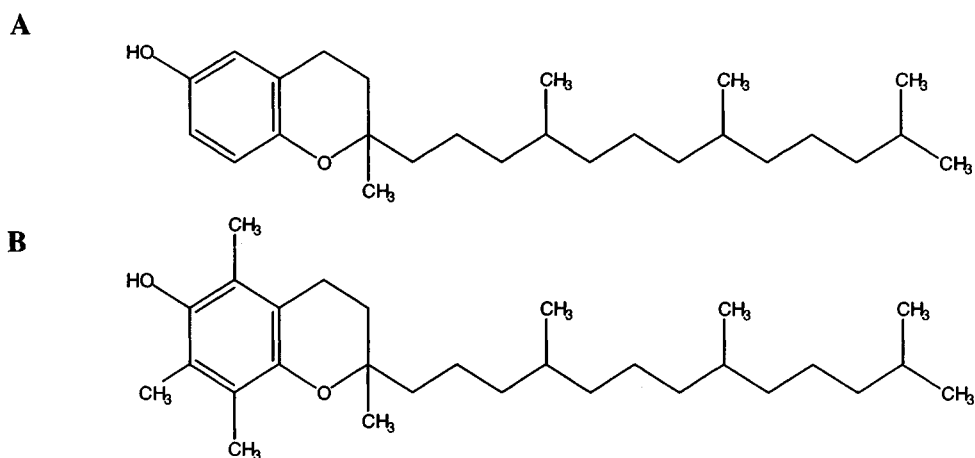
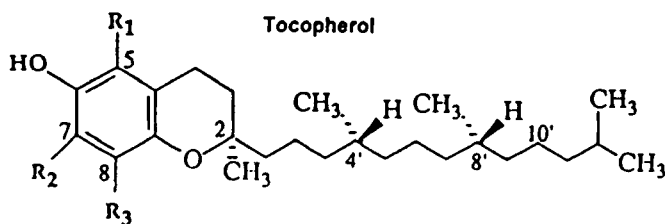
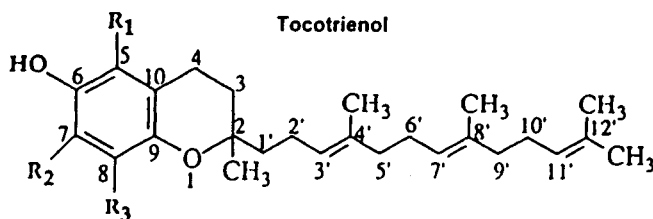

Figure 9-5 Structural Formula of (A) Tocol and (B) α -Tocopherol



Tocopherol	Tocopherol	R ₁	R ₂	R ₃
α	5,7,8 - Trimethyl	CH ₃	CH ₃	CH ₃
β	5,8 - Dimethyl	CH ₃	H	CH ₃
γ	7,8 - Dimethyl	H	CH ₃	CH ₃
δ	8 - Methyl	H	H	CH ₃



Tocotrienol	Tocotrienol	R ₁	R ₂	R ₃
α	5,7,8 - Trimethyl	CH ₃	CH ₃	CH ₃
β	5,8 - Dimethyl	CH ₃	H	CH ₃
γ	7,8 - Dimethyl	H	CH ₃	CH ₃
δ	8 - Methyl	H	H	CH ₃

Figure 9-6 Chemical Structure of the Tocopherols and Tocotrienols

9-6). The carbons at locations 4' and 8' in the side chains of the tocopherols are asymmetric, as is the number 2 carbon in the chromanol ring. The resulting possible isomers are described as having R or S rotation. The natural tocopherols and tocotrienols are predominantly RRR isomers. Morton (1967) has summarized the chemistry of the tocopherols as shown in Figure 9-7.

On oxidation, α -tocopherol can form a meta-stable epoxide that can be irreversibly converted to α -tocopherolquinone. Reduc-

tion of the quinone yields a quinol. Tocopherolquinones occur naturally. Oxidation with nitric acid yields the *o*-quinone or tocopherol red, which is not found in nature. Alpha-tocopheronic acid and α -tocopheronolactone are some of the products of metabolism of tocopherol. Much of the biological activity of the tocopherols is related to their antioxidant activity. Because α -tocopherol is the most abundant of the different tocopherols, and because it appears to have the greatest biological activity, the α -

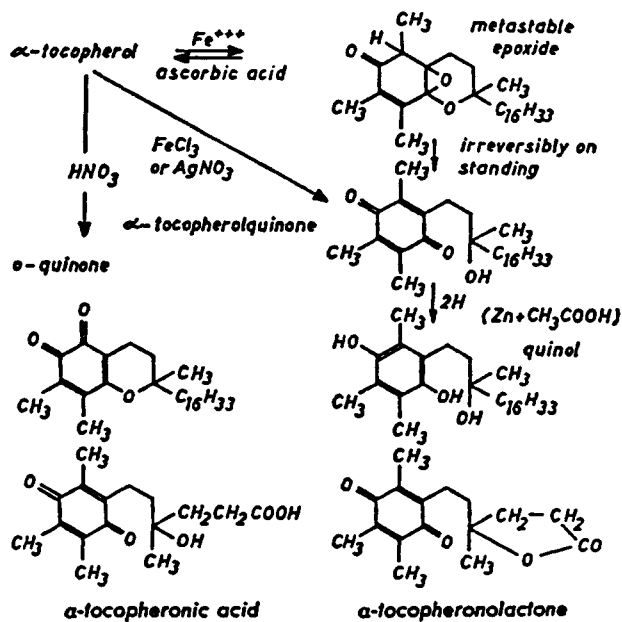

Figure 9-7 Chemistry of the Tocopherols. Source: From R.A. Morton, *The Chemistry of Tocopherols*, in *Tocopherole*, K. Lang, ed., 1967, Steinkopff Verlag, Darmstadt, Germany.

Table 9-6 Vitamin E Activity of α -Tocopherol Isomers and Synthetic Tocopherols

Name	IU/mg
d- α -tocopherol (2R4'R8'R) RRR- α -tocopherol	1.49
1- α -tocopherol (2S4'R8'R)	0.46
dl- α -tocopherol all-rac- α -tocopherol	1.10
2R4'R8'S- α -tocopherol	1.34
2S4'R8'S- α -tocopherol	0.55
2S4'S8'S- α -tocopherol	1.09
2S4'S8'R- α -tocopherol	0.31
2R4'S8'R- α -tocopherol	0.85
2S4'S8'S- α -tocopherol	1.10
d- α -tocopheryl acetate RRR- α -tocopheryl acetate	1.36
dl- α -tocopherol all-rac- α -tocopherol acetate	1.00

Source: Reprinted with permission from R.R. Eitenmiller, Vitamin E Content of Fats and Oils: Nutritional Implications, *Food Technol.*, Vol. 51, no. 5, p. 79, © 1997, Institute of Food Technologists.

portion of the tocopherols, and these steam-volatile compounds accumulate in the fatty acid distillate (Ong 1993). This product is an important source of natural vitamin E preparations. Baltes (1967) carried out tests in which two easily oxidizable fats, lard and partially hydrogenated whale oil, were stabilized with α -tocopherol and ascorbylpalmitate and citric acid as synergists. Without antioxidants, these fats cannot be used in the commercial food chain. Amounts of α -tocopherol ranging from 0.5 to 10 mg/100 g were effective in prolonging the storage life of some samples up to two years.

The tocopherol content of some animal and vegetable products as reported by Thaler (1967) is listed in Table 9-8. Cereals and

cereal products are good sources of tocopherol (Table 9-9). The distribution of tocopherol throughout the kernels is not uniform, and flour of different degrees of extraction can have different tocopherol levels. This was shown by Menger (1957) in a study of wheat flour (Table 9-10).

Processing and storage of foods can result in substantial tocopherol losses. An example is given in Table 9-11, where the loss of tocopherol during frying of potato chips is reported. After only two weeks' storage of the chips at room temperature, nearly half of the tocopherol was lost. The losses were only slightly smaller during storage at freezer temperature. Boiling of vegetables in water for up to 30 minutes results in only minor losses of tocopherol. Baking of white bread results in a loss of about 5 percent of the tocopherol in the crumb.

The human daily requirement of vitamin E is estimated at 30 IU. Increased intake of polyunsaturated fatty acids increases the need for this vitamin.

Vitamin K

This vitamin occurs in a series of different forms, and these can be divided into two groups. The first is vitamin K₁ (Figure 9-8), characterized by one double bond in the side chain. The vitamins K₂ have a side chain consisting of a number of regular units of the type

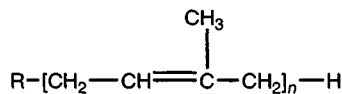

where n can equal 4, 5, 6, 7, and so forth.

Vitamin K₁ is slowly decomposed by atmospheric oxygen but is readily destroyed by light. It is stable against heat, but unstable against alkali.

Table 9-7 Tocopherol (T) and Tocotrienol (T3) Content of Vegetable Oils and Their Primary Homologs

<i>Fats and Oils</i>	<i>Total T+T3 (mg/100g)</i>	<i>α-TE/ 100g</i>	<i>%T</i>	<i>%T3</i>	<i>Primary Homologs</i>
Sunflower	46-67	35-63	100	0	α-T, γ-T
Cottonseed	78	43	100	0	α-T, γ-T
Safflower	49-80	41-46	100	0	α-T, δ-T, γ-T, β-T
Safflower—high linolenic	41	41	100	0	α-T, β-T
Safflower—high oleic	32	31	100	0	α-T, β-T, γ-T
Palm	89-117	21-34	17-55	45-83	α-T, α-T3, δ-T3, α-T, δ-T3
Canola	65	25	100	0	γ-T, α-T, δ-T, α-T3(Tr), β-T(Tr)
Corn	78-109	20-34	95	5	γ-T, α-T, δ-T, γ-T3, δ-T3
Soybean	96-115	17-20	100	0	γ-T, δ-T, α-T
Rice bran	9-160	0.9-41	19-49	51-81	γ-T3, α-T, α-T3, β-T, β-T3
Peanut	37	16	100	0	γ-T, α-T, δ-T
Olive	5.1	5.1	100	0	α-T
Cocoa butter	20	3.0	99	1	γ-T, δ-T, α-T, α-T3
Palm kernel	3.4	1.9	38	62	α-T3, α-T
Butter	1.1-2.3	1.1-2.3	100	0	α-T
Lard	0.6	0.6	100	0	α-T
Coconut	1.0-3.6	0.3-0.7	31	69	γ-T3, α-T3, δ-T, α-T, β-T3

Source: Reprinted with permission from R.R. Eitenmiller, Vitamin E Content of Fats and Oils: Nutritional Implications, *Food Technol.*, Vol. 51, no. 5, p. 80, © 1997, Institute of Food Technologists.

The human adult requirement is estimated at about 4 mg per day. Menadione (2-methyl 1,4-naphthoquinone) is a synthetic product and has about twice the activity of naturally occurring vitamin K.

Vitamin K occurs widely in foods and is also synthesized by the intestinal flora. Good sources of vitamin K are dark green vegetables such as spinach and cabbage leaves, and also cauliflower, peas, and cereals. Animal products contain little vitamin K₁, except for pork liver, which is a good source.

The Vitamin K levels in some foods, expressed in menadione units, are given in Table 9-12.

WATER-SOLUBLE VITAMINS

Vitamin C (L-Ascorbic Acid)

This vitamin occurs in all living tissues, where it influences oxidation-reduction reactions. The major source of L-ascorbic acid in foods is vegetables and fruits (Table 9-13).

Table 9-8 Tocopherol Content of Some Animal and Vegetable Food Products

<i>Product</i>	<i>Total Tocopherol as α-Tocopherol (mg/100 g)</i>
Beef liver	0.9–1.6
Veal, lean	0.9
Herring	1.8
Mackerel	1.6
Crab, frozen	5.9
Milk	0.02–0.15
Cheese	0.4
Egg	0.5–1.5
Egg yolk	3.0
Cabbage	2–3
Spinach	0.2–6.0
Beans	1–4
Lettuce	0.2–0.8 (0.06)
Peas	4–6
Tomato	0.9 (0.4)
Carrots	0.2 (0.11)
Onion	0.3 (0.22)
Potato	? (0.12)
Mushrooms	0.08

Source: From H. Thaler, Concentration and Stability of Tocopherols in Foods, in *Tocopherols*, K. Lang, ed., 1967, Steinkopff Verlag, Darmstadt, Germany.

L-ascorbic acid (Figure 9-9) is a lactone (internal ester of a hydroxycarboxylic acid) and is characterized by the enediol group, which makes it a strongly reducing compound. The D form has no biological activity. One of the isomers, D-isoascorbic acid, or erythorbic acid, is produced commercially for use as a food additive. L-ascorbic acid is readily and reversibly oxidized to dehydro-L-ascorbic acid (Figure 9-10), which retains vitamin C activity. This compound can be further oxidized to diketo-L-gulonic acid, in a

Table 9-9 Tocopherol Content of Cereals and Cereal Products

<i>Product</i>	<i>Total Tocopherol as α-Tocopherol (mg/100 g)</i>
Wheat	7–10
Rye	2.2–5.7
Oats	1.8–4.9
Rice (with hulls)	2.9
Rice (polished)	0.4
Corn	9.5
Whole wheat meal	3.7
Wheat flour	2.3–5.4
Whole rye meal	2.0–4.5
Oat flakes	3.85
Corn grits	1.17
Corn flakes	0.43
White bread	2.15
Whole rye bread	1.3
Crisp bread	4.0

Source: From H. Thaler, Concentration and Stability of Tocopherols in Foods, in *Tocopherols*, K. Lang, ed., 1967, Steinkopff Verlag, Darmstadt, Germany.

nonreversible reaction. Diketo-L-gulonic acid has no biological activity, is unstable, and is further oxidized to several possible compounds, including 1-threonic acid. Dehydration and decarboxylation can lead to the formation of furfural, which can polymerize to form brown pigments or combine with amino acids in the Strecker degradation.

Humans and guinea pigs are the only primates unable to synthesize vitamin C. The human requirement of vitamin C is not well defined. Figures ranging from 45 to 75 mg/day have been listed as daily needs. Continued stress and drug therapy may increase the need for this vitamin.

Vitamin C is widely distributed in nature, mostly in plant products such as fruits (espe-

Table 9-10 Tocopherol Content of Wheat and Its Milling Products

Product	Ash (%)	Tocopherol mg/100 g (Dry Basis)
Whole wheat	2.05	5.04
Flour 1 (fine)	1.68	5.90
Flour 2	1.14	4.27
Flour 3	0.84	3.48
Flour 4	0.59	2.55
Flour 5	0.47	2.35
Flour 6 (coarse)	0.48	2.13
Germ	4.10	25.0

Source: From A. Menger, Investigation of the Stability of Vitamin E in Cereal Milling Products and Baked Goods, *Brot. Gebäck*, Vol. 11, pp. 167-173, 1957 (German).

Table 9-11 Tocopherol Losses During Processing and Storage of Potato Chips

	Tocopherol (mg/100 g)	Loss (%)
Oil before use	82	—
Oil after use	73	11
Oil from fresh chips	75	—
After two weeks at room temperature	39	48
After one month at room temperature	22	71
After two months at room temperature	17	77
After one month at -12°C	28	63
After two months at -12°C	24	68

cially citrus fruits), green vegetables, tomatoes, potatoes, and berries. The only animal sources of this vitamin are milk and liver. Although widely distributed, very high levels of the vitamin occur only in a few products, such as rose hips and West Indian cherries. The concentration varies widely in different tissues of fruits; for example, in apples, the concentration of vitamin C is two to three times as great in the peel as in the pulp.

Vitamin C is the least stable of all vitamins and is easily destroyed during processing and storage. The rate of destruction is increased by the action of metals, especially copper

and iron, and by the action of enzymes. Exposure to oxygen, prolonged heating in the presence of oxygen, and exposure to light are all harmful to the vitamin C content of foods. Enzymes containing copper or iron in their prosthetic groups are efficient catalysts of ascorbic acid decomposition. The most important enzymes of this group are ascorbic acid oxidase, phenolase, cytochrome oxidase, and peroxidase. Only ascorbic acid oxidase involves a direct reaction among enzyme, substrate, and molecular oxygen. The other enzymes oxidize the vitamin indirectly. Phenolase catalyzes the oxidation of mono-

**Figure 9-8** Structural Formula of Vitamin K₁

Table 9-12 Vitamin K in Some Foods (Expressed as Menadione Units per 100 g of Edible Portion)

Product	Units/100 g
Cabbage, white	70
Cabbage, red	18
Cauliflower	23
Carrots	5
Honey	25
Liver (chicken)	13
Liver (pork)	111
Milk	8
Peas	50
Potatoes	10
Spinach	161
Tomatoes (green)	24
Tomatoes (ripe)	12
Wheat	17
Wheat bran	36
Wheat germ	18

Table 9-13 Vitamin C Content of Some Foods

Product	Ascorbic Acid (mg/100 g)
Black currants	200
Brussels sprouts	100
Cauliflower	70
Cabbage	60
Spinach	60
Orange	50
Orange juice	40-50
Lemon	50
Peas	25
Tomato	20
Apple	5
Lettuce	15
Carrots	6
Milk	2.1-2.7
Potatoes	30

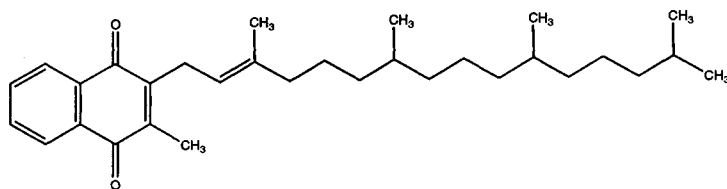
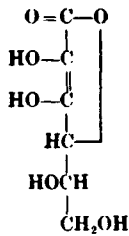

L-ASCORBIC ACID

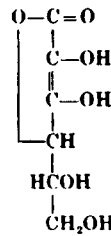

D-ASCORBIC ACID

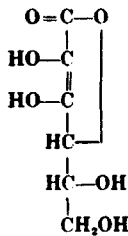

D-ISOASCORBIC ACID
(ERYTHORBIC ACID)

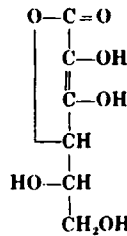

L-ARABOASCORBIC ACID

Figure 9-9 Structural Formulas of L-Ascorbic Acid and Its Stereoisomers

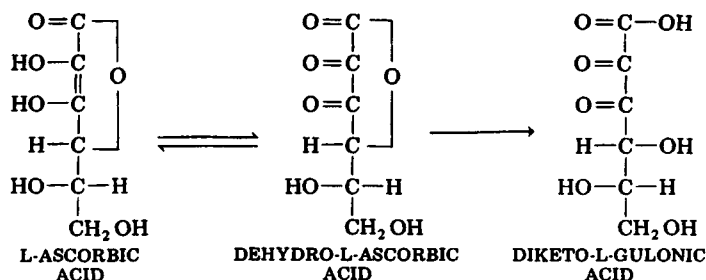

Figure 9-10 Oxidation of L-Ascorbic Acid

and dihydroxy phenols to quinones. The quinones react directly with the ascorbic acid. Cytochrome oxidase oxidizes cytochrome to the oxidized form and this reacts with L-ascorbic acid.

Peroxidase, in combination with phenolic compounds, utilizes hydrogen peroxide to bring about oxidation. The enzymes do not act in intact fruits because of the physical separation of enzyme and substrate. Mechanical damage, rot, or senescence lead to cellular disorganization and initiate decomposition. Inhibition of the enzymes in vegetables is achieved by blanching with steam or by

electronic heating. Blanching is necessary before vegetables are dried or frozen. In fruit juices, the enzymes can be inhibited by pasteurization, deaeration, or holding at low temperature for a short period. The effect of blanching methods on the ascorbic acid content of broccoli was reported by Odland and Eheart (1975). Steam blanching was found to result in significantly smaller losses of ascorbic acid (Table 9-14). The retention of ascorbic acid in frozen spinach depends on storage temperature. At a very low temperature (-29°C), only 10 percent of the initially present ascorbic acid was lost after one year. At -12° , the loss after one year was much higher, 55 percent. The presence of metal chelating compounds stabilizes vitamin C. These compounds include anthocyanins and flavonols, polybasic or polyhydroxy acids such as malic and citric acids, and polyphosphates.

Ascorbic acid is oxidized in the presence of air under neutral and alkaline conditions. At acid pH (for example, in citrus juice), the vitamin is more stable. Because oxygen is required for the breakdown, removal of oxygen should have a stabilizing effect. For the production of fruit drinks, the water should be deaerated to minimize vitamin C loss. The type of container may also affect the extent

Table 9-14 Effect of Blanching Method on Ascorbic Acid Levels of Broccoli

Factor Effect	Ascorbic Acid (mg/100 g)		
	Reduced	Dehydro	Total
Raw	94.0	4.0	98.2
Water blanch	45.3	5.7	51.0
Steam blanch	48.8	7.4	56.2

Source: From D. Odland and M.S. Eheart, Ascorbic Acid, Mineral and Quality Retention in Frozen Broccoli Blanched in Water, Steam, and Ammonia-Steam, *J. Food Sci.*, Vol. 40, pp. 1004-1007, 1975.

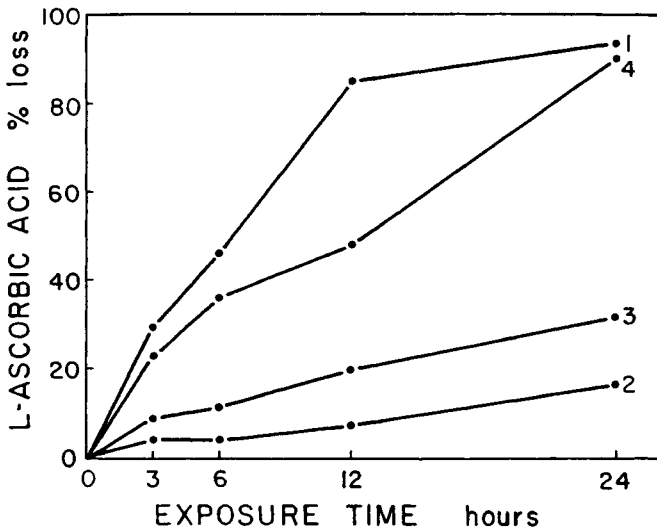

Figure 9-11 Effect of Exposure Time at Light Intensity of 200 Ft-C on the Loss of Ascorbic Acid in Milk. Packaging materials: (1) clear plastic pouch, (2) laminated nontransparent pouch, (3) carton, (4) plastic 3-quart jug. *Source:* From A. Sattar and J.M. deMan, Effect of Packaging Material on Light-Induced Quality Deterioration of Milk, *Can. Inst. Food Sci. Technol. J.*, Vol. 6, pp. 170-174, 1973.

of ascorbic acid destruction. Use of tin cans for fruit juices results in rapid depletion of oxygen by the electrochemical process of corrosion. In bottles, all of the residual oxygen is available for ascorbic acid oxidation. To account for processing and storage losses, it is common to allow for a loss of 7 to 14 mg of ascorbic acid per 100 mL of fruit juice. Light results in rapid destruction of ascorbic acid in milk. It has been shown (Sattar and deMan 1973) that transparent packaging materials permit rapid destruction of vitamin C (Figure 9-11). The extent of ascorbic acid destruction is closely parallel to the development of off-flavors. The destruction of ascorbic acid in milk by light occurs under the influence of riboflavin as a sensitizer. The reaction occurs in the presence of light and oxygen, and the riboflavin is converted to lumichrome.

Factors that affect vitamin C destruction during processing include heat treatment and leaching. The severity of processing conditions can often be judged by the percentage of ascorbic acid that has been lost. The extent of loss depends on the amount of water used. During blanching, vegetables that are covered with water may lose 80 percent; half covered, 40 percent; and quarter covered, 40 percent of the ascorbic acid. Particle size affects the size of the loss; for example, in blanching small pieces of carrots, losses may range from 32 to 50 percent, and in blanching large pieces, only 22 to 33 percent. Blanching of cabbage may result in a 20 percent loss of ascorbic acid, and subsequent dehydration may increase this to a total of 50 percent. In the processing of milk, losses may occur at various stages. From an initial level of about 22 mg/L in raw milk,

the content in the product reaching the consumer may be well below 10 mg/L. Further losses may occur in the household during storage of the opened container.

The processing of milk into various dairy products may result in vitamin C losses. Ice cream contains no vitamin C, nor does cheese. The production of powdered milk involves a 20 to 30 percent loss, evaporated milk a 50 to 90 percent loss. Bullock et al. (1968) studied the stability of added vitamin C in evaporated milk and found that adding 266 mg of sodium ascorbate per kg was sufficient to ensure the presence of at least 140 mg/L of ascorbic acid during 12 months of storage at 21°C. Data on the stability of vitamin C in fortified foods have been assembled by deRitter (1976) (Table 9–15).

There are many technical uses of ascorbic acid in food processing. It is used to prevent browning and discoloration in vegetables and fruit products; as an antioxidant in fats, fish products, and dairy products; as a stabilizer of color in meat; as an improver of flour; as an oxygen acceptor in beer processing; as a reducing agent in wine, partially replacing sulfur dioxide; and as an added nutrient. The vitamin is protected by sulfur dioxide, presumably by inhibiting polyphenolase.

Vitamin B₁ (Thiamin)

This vitamin acts as a coenzyme in the metabolism of carbohydrates and is present in all living tissues. It acts in the form of thiamin diphosphate in the decarboxylation of α -keto acids and is referred to as cocarboxylase. Thiamin is available in the form of its chloride or nitrate, and its structural formula is shown in Figure 9–12. The molecule contains two basic nitrogen atoms; one is in the primary amino group, the other in the quater-

Table 9–15 Vitamin C Stability in Fortified Foods and Beverages after Storage at 23°C for 12 Months, Except as Noted

Product	No. of Samples	Retention	
		Mean (%)	Range (%)
Ready-to-eat cereal	4	71	60–87
Dry fruit drink mix	3	94	91–97
Cocoa powder	3	97	80–100
Dry whole milk, air pack	2	75	65–84
Dry whole milk, gas pack	1	93	—
Dry soy powder	1	81	—
Potato flakes ¹	3	85	73–92
Frozen peaches	1	80	—
Frozen apricots ²	1	80	—
Apple juice	5	68	58–76
Cranberry juice	2	81	78–83
Grapefruit juice	5	81	73–86
Pineapple juice	2	78	74–82
Tomato juice	4	80	64–93
Vegetable juice	2	68	66–69
Grape drink	3	76	65–94
Orange drink	5	80	75–83
Carbonated beverage	3	60	54–64
Evaporated milk	4	75	70–82

¹Stored for 6 months at 23°C.

²Thawed after storage in freezer for 5 months.

Source: From E. deRitter, Stability Characteristics of Vitamins in Processed Foods, *Food Technol.*, Vol. 30, pp. 48–51, 54, 1976.

nary ammonium group. It forms salts with inorganic and organic acids. The vitamin contains a primary alcohol group, which is usually present in the naturally occurring vitamin in esterified form with ortho-, di-, or

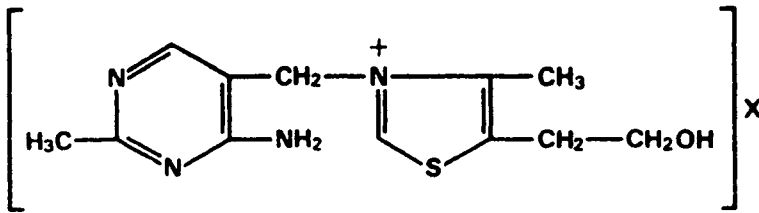

Figure 9-12 Structural Formula of Thiamin. Hydrochloride: X = Cl⁻, HCl; Mononitrate: X = NO₃⁻.

triphosphoric acid. In aqueous solution, the compound may occur in different forms, depending on pH. In acid solution, the equilibrium favors the formation of positive ions (Figure 9-13). The thiol- form is favored in alkaline medium. This form can react with compounds containing sulfhydryl groups to form disulfide bridges. It has been suggested that thiamin occurs in some foods linked to protein by disulfide bridges.

Small quantities of thiamin are present in almost all foods of plant and animal origin. Good sources are whole cereal grains; organ meats such as liver, heart, and kidney; lean pork; eggs; nuts; and potatoes (Table 9-16). Although thiamin content is usually mea-

sured in mg per 100 g of a food, another unit has been used occasionally, the IU corresponding to 3 μg of thiamin-hydrochloride. The human daily requirement is related to the carbohydrate level of the diet. A minimum intake of 1 mg per 2,000 kcal is considered essential. Increased metabolic activity, such as that which results from heavy work, pregnancy, or disease, requires higher intake.

Thiamin is one of the more unstable vitamins. Various food processing operations may considerably reduce thiamin levels. Heat, oxygen, sulfur dioxide, leaching, and neutral or alkaline pH may all result in destruction of thiamin. Light has no effect. The enzyme is stable under acid conditions;

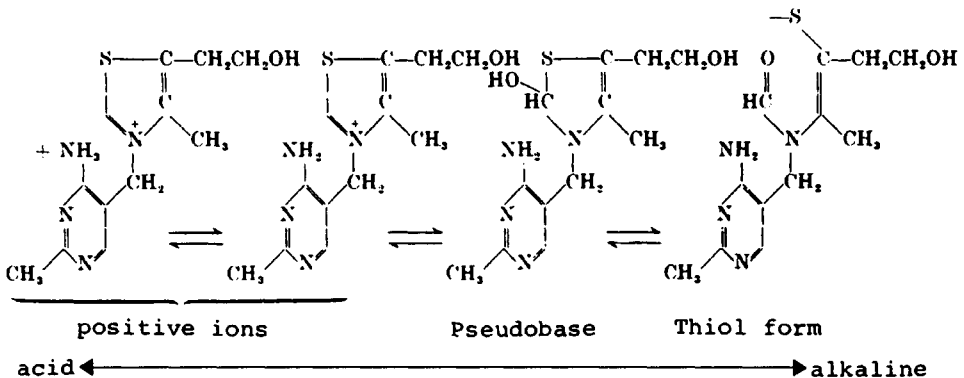

Figure 9-13 Behavior of Thiamin in Aqueous Solutions. *Source:* Reprinted with permission from J. Schormuller, *The Composition of Foods*, © 1965, Springer.

Table 9–16 Thiamin Content of Some Foods

<i>Product</i>	<i>Thiamin (mg/100 g) Edible Portion</i>
Almonds	0.24
Corn	0.37
Egg	0.11
Filberts	0.46
Beef heart	0.53
Beef liver	0.25
Macaroni (enriched)	0.88
Macaroni (not enriched)	0.09
Milk	0.03
Peas	0.28
Pork, lean	0.87
Potatoes	0.10
Wheat (hard red spring)	0.57
Wheat flour (enriched)	0.44
Wheat flour (not enriched)	0.08

at pH values of 3.5 or below, foods can be autoclaved at 120°C with little or no loss of thiamin. At neutral or alkaline pH, the vitamin is destroyed by boiling or even by storage at room temperature. Even the slight alkalinity of water used for processing may have an important effect. Bender (1971) reports that cooking rice in distilled water reduced thiamin content negligibly, whereas cooking in tap water caused an 8 to 10 percent loss, and cooking in well water caused a loss of up to 36 percent.

Some fish species contain an enzyme that can destroy thiamin. Sulfur dioxide rapidly destroys thiamin. For this reason, sulfur dioxide is not permitted as an additive in foods that contain appreciable amounts of thiamin.

Baking of white bread may result in thiamin loss of 20 percent. Thiamin loss in milk

processing is as follows: pasteurization, 3 to 20 percent; sterilization, 30 to 50 percent; spray drying, 10 percent; and roller drying, 20 to 30 percent. Cooking of meat causes losses that are related to size of cut, fat content, and so on. Boiling loss is 15 to 40 percent; frying, 40 to 50 percent; roasting, 30 to 60 percent; and canning, 50 to 75 percent. Similar losses apply to fish. Because thiamin and other vitamins are located near the bran of cereal grains, there is a great loss during milling. White flour, therefore, has a greatly reduced content of B vitamins and vitamin E (Figure 9–14). Not only is thiamin content lowered by milling, but also storage of whole grain may result in losses. This depends on moisture content. At normal moisture level of 12 percent, five months' storage results in a 12 percent loss; at 17 percent moisture, a 30 percent loss; and at 6 percent moisture, no loss at all. Because of the losses that are likely to occur in cereal grain processing and in the processing of other foods, a program of fortification of flour is an important factor in preventing vitamin deficiencies. Table 9–17 lists the nutrients and recommended levels for grain products fortification (National Academy of Sciences 1974b). A summary of data relating processing treatment to thiamin stability has been given by deRitter (1976) (Table 9–18).

Vitamin B₂ (Riboflavin)

The molecule consists of a d-ribitol unit attached to an isoalloxazine ring (Figure 9–15). Anything more than a minor change in the molecule results in a loss of vitamin activity. Aqueous solutions of riboflavin are yellow with a yellowish-green fluorescence. The vitamin is a constituent of two coenzymes, flavin mononucleotide (FMN) and flavin adenine dinucleotide (FAD). FMN is

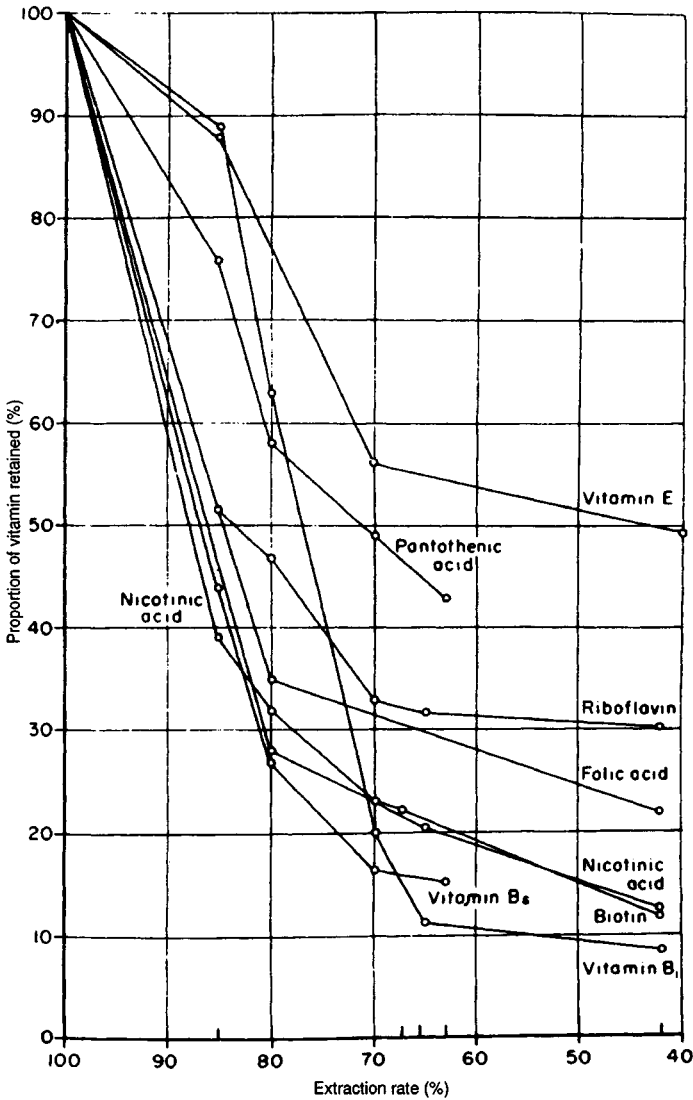

Figure 9-14 Relation Between Extraction Rate and Proportion of Total Vitamins of the Grains Retained in Flour. Source: Reprinted with permission from W.R. Aykroyd and J. Doughty, *Wheat in Human Nutrition*, © 1970, Food and Agriculture Organization of the United Nations.

riboflavin-5'-phosphate and forms part of several enzymes, including cytochrome c reductase. The flavoproteins serve as electron carriers and are involved in the oxidation of glucose, fatty acids, amino acids, and purines.

Very good sources of riboflavin are milk and milk products; other sources are beef muscle, liver, kidney, poultry, tomatoes, eggs, green vegetables, and yeast (Table 9-19).

Riboflavin is stable to oxygen and acid pH but is unstable in alkaline medium and is

Table 9-17 Nutrients and Levels Recommended for Inclusion in Fortification of Cereal-Grain Products¹

Nutrient	Level	
	(mg/lb)	(mg/100 g)
Vitamin A ²	2.2	0.48
Thiamin	2.9	0.64
Riboflavin	1.8	0.40
Niacin	24.0	5.29
Vitamin B ₆	2.0	0.44
Folic acid	0.3	0.07
Iron	40	8.81
Calcium	900	198.2
Magnesium	200	44.1
Zinc	10	2.2

¹Wheat flour, corn grits, cornmeal, rice. Other cereal-grain products in proportion to their cereal-grain content.

²Retinol equivalent.

Source: Reprinted with permission from National Academy of Sciences, *Recommended Dietary Allowances*, 8th rev. ed., © 1974, National Academy of Sciences.

very sensitive to light. When exposed to light, the rate of destruction increases as pH and temperature increase. Heating under neutral or acidic conditions does not destroy the vitamin.

The human requirement for riboflavin varies with metabolic activity and body weight and ranges from 1 to 3 mg per day. Normal adult requirement is 1.1 to 1.6 mg per day. In most cases, the riboflavin of foods is present in the form of the dinucleotide, the phosphoric acid ester, or is bound to protein. Only in milk does riboflavin occur mostly in the free form.

Under the influence of light and alkaline pH, riboflavin is transformed into lumiflavin,

Table 9-18 Thiamin Stability in Foods

Product	Treatment	Retention (%)
Nine canned vegetables	Processing	31-89
Four canned vegetables	Storage, 2-3 mo @ room temperature	73-94
Cereals	Extrusion cooking	48-90
Fortified ready-to-eat cereal	Storage, 12 mo @ 23°C	100
Bread (white, whole wheat)	Commercial baking	74-79
Devil's food cake (pH 9)	Baking	0-7

Source: From E. deRitter, Stability Characteristics of Vitamins in Processed Foods, *Food Technol.*, Vol. 30, pp. 48-51, 54, 1976.

an inactive compound with a yellowish-green fluorescence. Under acid conditions, riboflavin is transformed into another inactive derivative, lumichrome, and ribitol. This compound has a blue fluorescence. The trans-

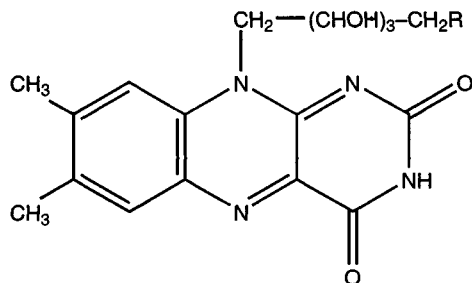

Figure 9-15 Structural Formula of Riboflavin. Riboflavin: R = OH; Riboflavin phosphate: R = PO₃NaOH.

Table 9-19 Riboflavin Content of Some Foods

<i>Product</i>	<i>Riboflavin (mg/100 g) Edible Portion</i>
Beef	0.16
Cabbage	0.05
Eggs	0.30
Chicken	0.19
Beef liver	3.26
Chicken liver	2.49
Beef kidney	2.55
Peas	0.29
Spinach	0.20
Tomato	0.04
Yeast (dry)	5.41
Milk	0.17
Nonfat dry milk	1.78

formation into lumiflavin in milk results in the destruction of ascorbic acid.

The light sensitivity of riboflavin results in losses of up to 50 percent when milk is exposed to sunlight for two hours. The nature of the packaging material significantly affects the extent of riboflavin destruction. It appears that the wavelengths of light responsible for the riboflavin destruction are in the visible spectrum below 500 to 520 nm. Ultraviolet light has been reported to have no destructive effect on riboflavin (Hartman and Dryden 1965). Riboflavin is stable in dry milk for storage periods of up to 16 months. Pasteurization of milk causes only minor losses of riboflavin.

Vitamin B₆ (Pyridoxine)

There are three compounds with vitamin B₆ activity. The structural formula of pyri-

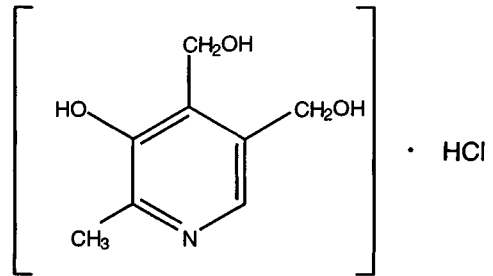
**Figure 9-16** Structural Formula of Pyridoxine

doxine is presented in Figure 9-16. The other two forms of this vitamin are different from pyridoxine—they have another substituent on carbon 4 of the benzene ring. Pyridoxal has a $-\text{CHO}$ group in this position and pyridoxamine has a $-\text{CH}_2\text{NH}_2$ group. All three compounds can occur as salts. Vitamin B₆ plays an important role in the metabolism of amino acids, where it is active in the coenzyme form pyridoxal-5-phosphate. The three forms of vitamin B₆ are equally active in rats; although it can be expected that the same applies for humans, this has not been definitely established.

Vitamin B₆ is widely distributed in many foods (Table 9-20), and deficiencies of this vitamin are uncommon. The recommended allowance for adults has been established at 2 mg per day. The requirement appears to increase with the consumption of high-protein diets.

Vitamin B₆ occurs in animal tissues in the form of pyridoxal and pyridoxamine or as their phosphates. Pyridoxine occurs in plant products.

Pyridoxine is stable to heat and strong alkali or acid; it is sensitive to light, especially ultraviolet light and when present in alkaline solutions. Pyridoxal and pyridoxam-

Table 9-20 Vitamin B₆ Content of Some Foods

Product	Vitamin B ₆ (μg/g)
Wheat	3.2-6.1
Whole wheat bread	4.2
White bread	1.0
Orange juice	0.52-0.60
Apple juice	0.35
Tomatoes	1.51
Beans, canned	0.42-0.81
Peas, canned	0.44-0.53
Beef muscle	0.8-4.0
Pork muscle	1.23-6.8
Milk, pasteurized	0.5-0.6
Yeast	50

ine are rapidly destroyed when exposed to air, heat, or light. Pyridoxamine is readily destroyed in food processing operations.

Because it is difficult to determine this vitamin in foods, there is a scarcity of information on its occurrence. Recent data establish the level in milk as 0.54 mg per liter. Other sources are meats, liver, vegetables, whole grain cereals, and egg yolk.

The effects of processing on pyridoxine levels in milk and milk products have been reviewed by Hartman and Dryden (1965). No significant losses have been reported to

result from pasteurization, homogenization, or production of dried milk. Heat sterilization of milk, however, has been reported to result in losses ranging from 36 to 49 percent. Losses occur not only during the heat treatment but also during subsequent storage of milk. These storage losses have been attributed to a conversion of pyridoxal to pyridoxamine and then to a different form of the vitamin. Wendt and Bernhart (1960) have identified this compound as *bis*-4-pyridoxal disulfide (Figure 9-17). This compound is formed by reaction of pyridoxal and active sulfhydryl groups. The latter are formed during heat treatment of milk proteins. Exposure of milk to daylight in clear glass bottles for eight hours resulted in a vitamin B₆ loss of 21 percent.

Food canning results in losses of vitamin B₆ of 20 to 30 percent. Milling of wheat may result in losses of up to 80 to 90 percent. Baking of bread may result in losses of up to 17 percent.

A review of some stability data of vitamin B₆ as prepared by deRitter (1976) is given in Table 9-21.

Niacin

The term *niacin* is used in a generic sense for both nicotinic acid and nicotinamide

**Figure 9-17** Structural Formula of *bis*-4-Pyridoxal Disulfide

Table 9-21 Vitamin B₆ Stability in Foods

Product	Treatment	Retention (%)		
		<i>Saccharomyces Carlsbergensis</i>	Chick	Rat
Bread (added B ₆)	Baking		100	
Enriched corn meal	12 mo @ 38°C + 50% relative humidity		90-95	
Enriched macaroni	12 mo @ 38°C + 50% relative humidity		100	
Whole milk	Evaporation and sterilization	30	55	65
	Evaporation and sterilization + 6 mo @ room temperature	18	44	41
Infant formula, liquid	Processing and sterilization	33-50 (natural)		
		84 (added)		
Infant formula, dry	Spray drying		69-83	
Boned chicken	Canning		57	
	Irradiation (2.79 megarads)		68	

Source: From E. deRitter, Stability Characteristics of Vitamins in Processed Foods, *Food Technol.*, Vol. 30, pp. 48-51, 54, 1976.

(Figure 9-18). Nicotinamide acts as a component of two important enzymes, NAD and NADP, which are involved in glycolysis, fat synthesis, and tissue respiration. Niacin is also known as the pellagra preventive factor. The incidence of pellagra has declined but is still a serious problem in parts of the Near East, Africa, southeastern Europe, and in North American populations that subsist on

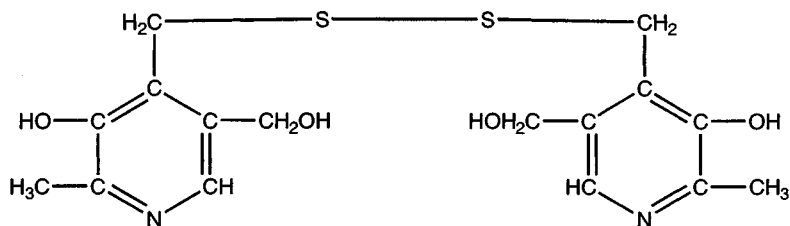
corn diets. When corn is treated with alkali or lime, as for the tortilla preparation in Central America, the amount of available niacin can be greatly increased. Tryptophan can be converted by the body into niacin. Many diets causing pellagra are low in good-quality protein as well as in vitamins. Corn protein is low in tryptophan. The niacin of corn and other cereals may occur in a bound form,

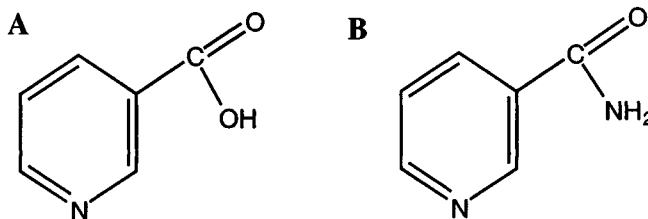

Figure 9-18 Structural Formulas of (A) Nicotinic Acid and (B) Nicotinamide

called niacytin, that can be converted into niacin by alkali treatment.

The human requirement of niacin is related to the intake of tryptophan. Animal proteins contain approximately 1.4 percent of tryptophan, vegetable proteins about 1 percent. A dietary intake of 60 mg of tryptophan is considered equivalent to 1 mg of niacin. When this is taken into account, average diets in the United States supply 500 to 1,000 mg tryptophan per day and 8 to 17 mg niacin for a total niacin equivalent of 16 to 33 mg. The RDA for adults, expressed as niacin, is 6.6 mg per 1,000 kcal, and not less than 13 mg when caloric intake is less than 2,000 kcal.

Good dietary sources of this vitamin are liver, kidney, lean meat, chicken, fish, wheat, barley, rye, green peas, yeast, peanuts, and leafy vegetables. In animal tissues, the predominant form of niacin is the amide. Niacin content of some foods are listed in Table 9-22.

Niacin is probably the most stable of the B vitamins. It is unaffected by heat, light, oxygen, acid, or alkali. The main loss resulting from processing involves leaching into the process water. Blanching of vegetables may cause a loss of about 15 percent. Processes in which brines are used may cause losses of up to 30 percent. Processing of milk, such as pasteurization, sterilization, evaporation, and drying have little or no effect on nicotinic acid level. Virtually all the niacin in milk occurs in the form of nicotinamide. In many foods, application of heat, such as roasting or baking, increases the amount of available niacin. This results from the change of bound niacin to the free form.

Table 9-22 Niacin Content of Some Foods

<i>Product</i>	<i>Niacin (mg/100 g) Edible Portion</i>
Barley (pearled)	3.1
Beans (green, snap)	0.5
Beans (white)	2.4
Beef (total edible)	4.4
Beef kidney	6.4
Beef liver	13.6
Chicken (dark meat)	5.2
Chicken (light meat)	10.7
Corn (field)	2.2
Haddock	3.0
Milk	0.1
Mushrooms	4.2
Peanuts	17.2
Peas	2.9
Potatoes	1.5
Spinach	0.6
Wheat	4.3
Yeast (dry)	36.7

Vitamin B₁₂ (Cyanocobalamine)

This vitamin possesses the most complex structure of any of the vitamins and is unique in that it has a metallic element, cobalt, in the molecule (Figure 9-19). The molecule is a coordination complex built around a central trivalent cobalt atom and consists of two major parts—a complex cyclic structure that closely resembles the porphyrins and a nucleotide-like portion, 5,6-dimethyl-1-(α -D-ribofuranosyl) benzimidazole-3'-phosphate. The phosphate of the nucleotide is esterified with 1-amino-2-propanol; this, in turn, is joined by means of an amide bond with the propionic acid side chain of the large cyclic structure. A second linkage with the large structure is through the coordinate bond between the cobalt atom and one of the nitro-

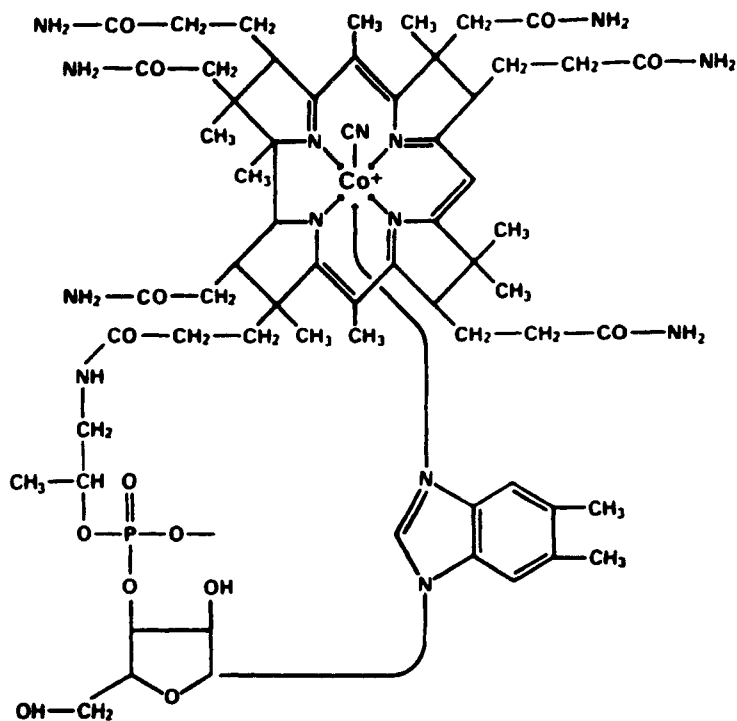

Figure 9-19 Structural Formula of Cyanocobalamin

gen atoms of the benzimidazole. The cyanide group can be split off relatively easily, for example, by daylight. This reaction can be reversed by removing the light source. The cyano group can also be replaced by other groups such as hydroxo, aquo, and nitro. Treatment with cyanide will convert these groups back to the cyano form. The different forms all have biological activity.

Cyanocobalamin is a component of several coenzymes and has an effect on nucleic acid formation through its action in cycling 5-methyl-tetrahydrofolate back into the folate pool. The most important dietary sources of the vitamin are animal products. Vitamin B₁₂ is also produced by many microorganisms. It is not surprising that vitamin B₁₂ deficiency of dietary origin only occurs in vegetarians.

The average diet in the United States is considered to supply between 5 and 15 µg/day. In foods, the vitamin is bound to proteins via peptide linkages but can be readily absorbed in the intestinal tract. The RDA is 3 µg for adults and adolescents.

Few natural sources are rich in vitamin B₁₂. However, only very small amounts are required in the diet. Good sources are lean meat, liver, kidney, fish, shellfish, and milk (Table 9-23). In milk, the vitamin occurs as cobalamin bound to protein.

Vitamin B₁₂ is not destroyed to a great extent by cooking, unless the food is boiled in alkaline solution. When liver is boiled in water for 5 minutes, only 8 percent of the vitamin B₁₂ is lost. Broiling of meat may result in higher losses. Pasteurization causes

Table 9-23 Vitamin B₁₂ Content of Some Foods

Product	Vitamin B ₁₂
Beef muscle	0.25–3.4 µg/100 g
Beef liver	14–152 µg/100 g
Milk	3.2–12.4 µg/L
Shellfish	600–970 µg/100 g (dry wt)
Egg yolk	0.28–1.556 µg/100 g

only a slight destruction of vitamin B₁₂ in milk; losses range from 7 to 10 percent depending on pasteurization method. More drastic heat treatment results in higher losses. Boiling milk for two to five minutes causes a 30 percent loss, evaporation about 50 percent, and sterilization up to 87 percent. The loss in drying of milk is smaller; in the production of dried skim milk, the vitamin B₁₂ loss is about 30 percent. Ultra-high-temperature sterilization of milk does not cause more vitamin B₁₂ destruction than does pasteurization.

Folic Acid (Folacin)

Folic acid is the main representative of a series of related compounds that contain three moieties: pterin, *p*-aminobenzoic acid, and glutamic acid (Figure 9-20). The commercially available form contains one glutamic

acid residue and is named pteroylglutamic acid (PGA). The naturally occurring forms are either PGA or conjugates with varying numbers of glutamic acid residues, such as tri- and heptaglutamates. It has been suggested that folic acid deficiency is the most common vitamin deficiency in North America and Europe. Deficiency is especially likely to occur in pregnant women.

The vitamin occurs in a variety of foods, especially in liver, fruit, leafy vegetables, and yeast (Table 9-24) (Hurdle et al. 1968; Streiff 1971). The usual form of the vitamin in these products is a polyglutamate. The action of an enzyme (conjugase) is required to liberate the folic acid for metabolic activity; this takes place in the intestinal mucosa. The folacin of foods can be divided into two main groups on the basis of its availability to *L. casei*: (1) the so-called free folate, which is available to *L. casei* without conjugase treatment; and (2) the total folate, which also includes the conjugates that are not normally available to *L. casei*. About 25 percent of the dietary folacin occurs in free form. The folate in vegetables occurs mainly in the conjugated form; the folate in liver occurs in the free form.

The RDA for folacin is 400 µg for adults. There is an additional requirement of 400 µg/day during pregnancy and 200 µg/day during breastfeeding.

**Figure 9-20** Structural Formula of Folic Acid

Table 9–24 Folate Content of Some Foods

<i>Product</i>	<i>Folate (μg/g)</i>
Beef, boiled	0.03
Chicken, roasted	0.07
Cod, fried	0.16
Eggs, boiled	0.30
Brussels sprouts, boiled	0.20
Cabbage, boiled	0.11
Lettuce	2.00
Potato, boiled	0.12
Spinach, boiled	0.29
Tomato	0.18
Orange	0.45
Milk	0.0028
Bread, white	0.17
Bread, brown	0.38
Orange juice, frozen reconstituted	0.50
Tomato juice, canned	0.10

Many of the naturally occurring folates are extremely labile and easily destroyed by cooking. Folic acid itself is stable to heat in an acid medium but is rapidly destroyed under neutral and alkaline conditions. In solution, the vitamin is easily destroyed by light. Folate may occur in a form more active

than PGA; this is called folinic acid or citrovorum factor, which is N⁵-formyl-5, 6, 7, 8-tetrahydro PGA (Figure 9–21). The folate of milk consists of up to 20 percent of folinic acid. It has been reported that pasteurization and sterilization of milk involve only small losses or no loss. Hurdle et al. (1968) reported that boiling of milk causes no loss in folate; however, boiling of potato results in a 90 percent loss and boiling of cabbage a 98 percent loss. Reconstitution of dried milk followed by sterilization as can occur with baby formulas may lead to significant folacin losses. Fermentation of milk and milk products may result in greatly increased folate levels. Blanching of vegetables and cooking of meat do not appear to cause folic acid losses. Table 9–25 contains a summary of folate stability data prepared by deRitter (1976). Citrus fruit and juices are relatively good sources of folic acid, which is present mostly as the reduced 5-methyl tetrahydro-folate (monoglutamate form). There are also polyglutamate derivatives present (White et al. 1991).

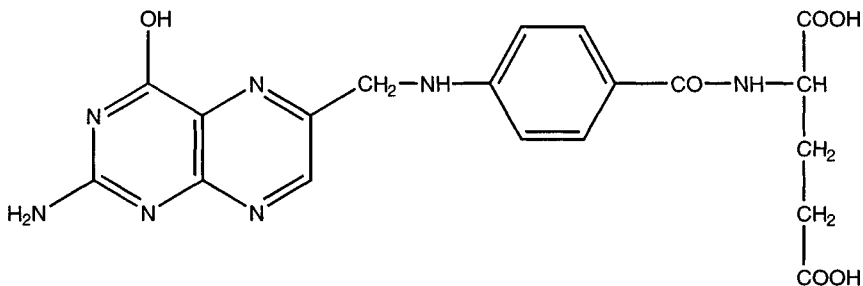
Pantothenic Acid

The free acid (Figure 9–22) is very unstable and has the appearance of a hygroscopic

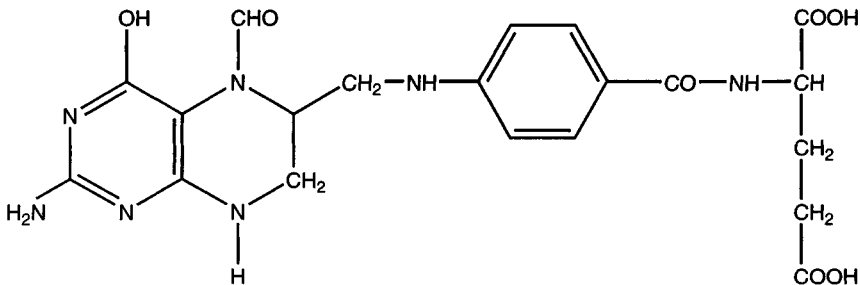

Figure 9–21 Structural Formula of Folinic Acid

Table 9-25 Folic Acid Stability in Foods

Product	Treatment	Retention of Folic Acid	
		Free (%)	Total (%)
Cabbage	Boiled 5 min	32	54
Potatoes	Boiled 5 min	50	92
Rice	Boiled 15 min	—	10
Beef, pork, and chicken	Boiled 15 min	<50	<50
Various foods	Cooked	27	55

Source: From E. deRitter, Stability Characteristics of Vitamins in Processed Foods, *Food Technol.*, Vol. 30, pp. 48-51, 54, 1976.

Table 9-26 Pantothenic Acid Content of Some Foods

Product	Pantothenic Acid (μg/g)
Beef, lean	10
Wheat	11
Potatoes	6.5
Split peas	20-22
Tomatoes	1
Orange	0.7
Walnuts	8
Milk	1.3-4.2
Beef liver	25-60
Eggs	8-48
Broccoli	46

oil. The calcium and sodium salts are more stable. The alcohol (panthenol) has the same biological activity as the acid. Only the dextrorotatory or D form of these compounds has biological activity. Pantothenic acid plays an important role as a component of coenzyme A, and this is the form in which it occurs in most foods.

Pantothenic acid occurs in all living cells and tissues and is, therefore, found in most food products. Good dietary sources include meats, liver, kidney, fruits, vegetables, milk, egg yolk, yeast, whole cereal grains, and nuts (Table 9-26). In animal products, most of the pantothenic acid is present in the bound

form, but in milk only about one-fourth of the vitamin is bound.

There is no recommended dietary allowance for this vitamin because of insufficient evidence to base one on. It is estimated that adult dietary intake in the United States ranges from 5 to 20 mg/day, and 5 to 10 mg/day probably represents an adequate intake.

The vitamin is stable to air, and labile to dry heat. It is stable in solution in the pH range of 5 to 7 and less stable outside this range. Pasteurization and sterilization of milk result in very little or no loss. The production and storage of dried milk involves little or no loss of pantothenic acid. Manu-

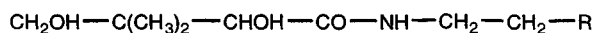

Figure 9-22 Structural Formula of Pantothenic Acid. Pantothenic acid: R = COOH; Panthenol: R = CH₂OH.

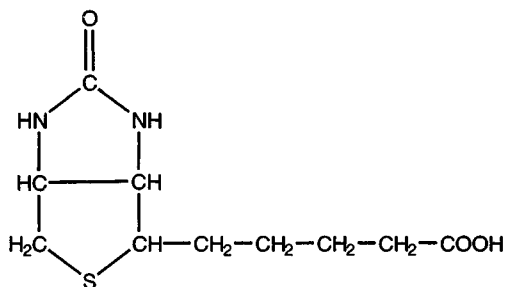

Figure 9-23 Structural Formula of Biotin

facture of cheese involves large losses during processing, but during ripening the pantothenic acid content increases, due to synthesis by microorganisms. Blanching of vegetables may involve losses of up to 30 percent. Boiling in water involves losses that depend on the amount of water used.

Biotin

The structural formula (Figure 9-23) contains three asymmetric carbon atoms, and eight different stereoisomers are possible. Only the dextrorotatory D-biotin occurs in nature and has biological activity. Biotin occurs in some products in free form (vegetables, milk, and fruits) and in other products is bound to protein (organ meats, seeds, and yeast). Good sources of the vitamin are meat, liver, kidney, milk, egg yolk, yeast, vegetables, and mushrooms (Table 9-27).

Biotin is important in a number of metabolic reactions, especially in fatty acid synthesis. The biotin supply of the human organism is only partly derived from the diet.

An important factor in biotin's availability is that some of the vitamin is derived from synthesis by intestinal microorganisms; this is demonstrated by the fact that three to six

Table 9-27 Biotin Content of Some Foods

<i>Product</i>	<i>Biotin (µg/100 g)</i>
Milk	1.1-3.7
Tomatoes	1
Broad beans	3
Cheese	1.1-7.6
Wheat	5.2
Beef	2.6
Beef liver	96
Lettuce	3.1
Mushrooms	16
Potatoes	0.6
Spinach	6.9
Apples	0.9
Oranges	1.9
Peanuts	34

times more biotin is excreted in the urine than is ingested with the food. The daily intake of biotin is between 100 and 300 µg. No recommended dietary allowance has been established. Biotin is deactivated by raw egg white. This is caused by the glycoprotein avidin. Heating of avidin will destroy the inactivator capacity for biotin.

Data on the stability of biotin are limited. The vitamin appears to be quite stable. Heat treatment results in relatively small losses. The vitamin is stable to air and is stable at neutral and acid pH. Pasteurization and sterilization of milk result in losses of less than 10 percent. In the production of evaporated and dried milk, losses do not exceed 15 percent.

VITAMINS AS FOOD INGREDIENTS

In addition to their role as essential micro-nutrients, vitamins may serve as food ingre-

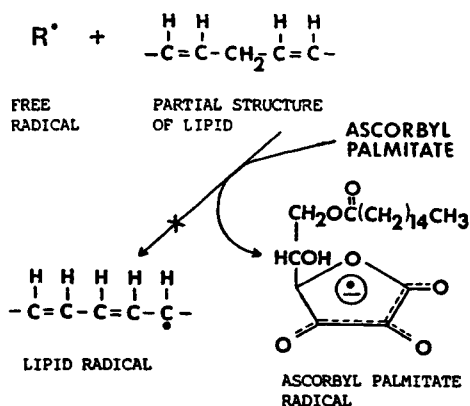

Figure 9-24 Prevention of Lipid Free Radical Formation by Ascorbyl Palmitate. *Source:* From M.L. Liao and P.A. Seib, Selected Reactions of L-Ascorbic Acid Related to Foods, *Food Technol.*, Vol. 41, no. 11, pp. 104-107, 1987.

diets for their varied functional properties (Institute of Food Technologists 1987). Vitamin C and vitamin E have found widespread use as antioxidants. In lipid systems, vitamin

E may be used as an antioxidant in fats that have little or no natural tocopherol content. Ascorbic acid in the form of its palmitic acid ester, ascorbyl palmitate, is an effective antioxidant in lipid systems. Ascorbyl palmitate prevents the formation of lipid free radicals (Figure 9-24) and thereby delays the initiation of the chain reaction that leads to the deterioration of the fat (Liao and Seib 1987). Ascorbyl palmitate is used in vegetable oils because it acts synergistically with naturally occurring tocopherols. The tocopherols are fat-soluble antioxidants that are used in animal fats. Ascorbic acid reduces nitrous acid to nitric oxide and prevents the formation of N-nitrosamine. The reaction of nitrous acid and ascorbic acid is given in Figure 9-25 (Liao and Seib 1987). Ascorbic acid is also widely used to prevent enzymic browning in fruit products. Phenolic compounds are oxidized by polyphenoloxidase to quinones. The quinones rapidly polymerize to form brown pigments. This reaction is easily reversed by ascorbic acid (Figure 9-26).

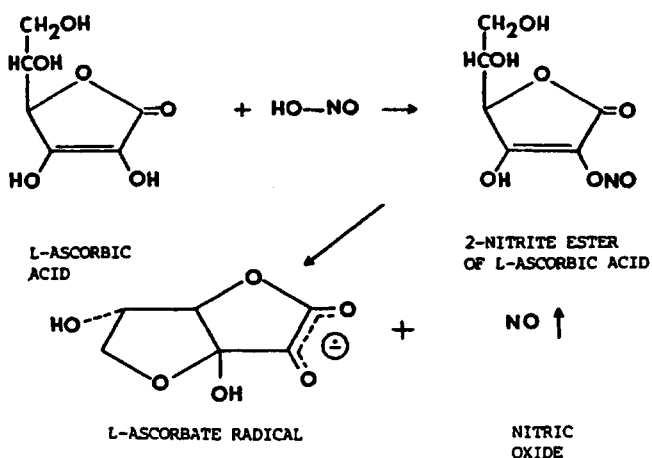

Figure 9-25 Reaction Between Nitrous Acid and Ascorbic Acid. *Source:* From M.L. Liao and P.A. Seib, Selected Reactions of L-Ascorbic Acid Related to Foods, *Food Technol.*, Vol. 41, no. 11, pp. 104-107, 1987.

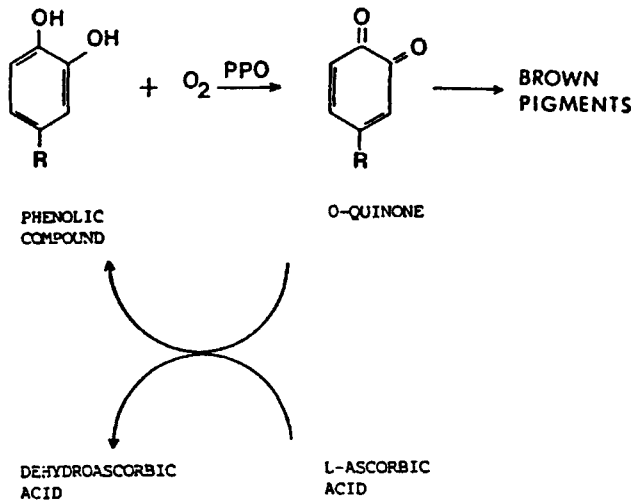

Figure 9-26 Reduction of Ortho-Quinone by Ascorbic Acid During Enzymic Browning. *Source:* From M.L. Liao and P.A. Seib, Selected Reactions of L-Ascorbic Acid Related to Foods, *Food Technol.*, Vol. 41, no. 11, pp. 104-107, 1987.

The carotenoids β -carotene and β -apo-8-carotenal are used as colorants in fat-based as well as water-based foods.

Other functions of ascorbic acid are inhibition of can corrosion in canned soft drinks,

protection of flavor and color of wine, prevention of black spot formation in shrimp, stabilization of cured meat color, and dough improvement in baked goods (Institute of Food Technologists 1987).

REFERENCES

- Baltes, J. 1967. Tocopherols as fat stabilizers. In *Tocopherol*, K. Lang, ed. Darmstadt, Germany: Steinkopff Verlag.
- Bender, A.E. 1971. The fate of vitamins in food processing operations. In *Vitamins*, ed. M. Stein. London: Churchill Livingstone.
- Bullock, D.H., et al. 1968. Stability of vitamin C in enriched commercial evaporated milk. *J. Dairy Sci.* 51: 921-923.
- Combs, G.F. 1992. *The vitamins: Fundamental aspects in nutrition and health*. San Diego: Academic Press.
- deMan, J.M. 1981. Light-induced destruction of vitamin A in milk. *J. Dairy Sci.* 64: 2031-2032.
- deMan, J.M., et al. 1986. Stability of vitamin A beadlets in nonfat dry milk. *Milchwissenschaft* 41: 468-469.
- deRitter, E. 1976. Stability characteristics of vitamins in processed foods. *Food Technol.* 30: 48-51, 54.
- Eitenmiller, R.R. 1997. Vitamin E content of fats and oils: Nutritional implications. *Food Technol.* 51, no. 5: 78-81.
- Gross, J. 1987. *Pigments in fruits*. London: Harcourt Brace Jovanovich.
- Hartman, A.M., and Dryden, L.P. 1965. Vitamins in milk and milk products. *Am. Dairy Sci. Assoc. Champaign, IL.*
- Hurdle, A.D.F., et al. 1968. A method for measuring folate in food and its application to a hospital diet. *Am. J. Clin. Nutr.* 21: 1202-1207.
- Institute of Food Technologists. 1987. Use of vitamins as additives in processed foods. *Food Technol.* 41, no. 9: 163-168.

- Liao, M.-L., and P.A. Seib. 1987. Selected reactions of L-ascorbic acid related to foods. *Food Technol.* 41, no. 11: 104–107, 111.
- Menger, A. 1957. Investigation of the stability of vitamin E in cereal milling products and baked goods. *Brot. Gebäck* 11: 167–173 (German).
- Morton, R.A. 1967. The chemistry of tocopherols. In *Tocopherol*, ed. K. Lang. Darmstadt, Germany: Steinkopff Verlag.
- National Academy of Sciences. 1974a. *Recommended dietary allowances*, 8th rev. ed. Washington, DC.
- National Academy of Sciences. 1974b. *Proposed fortification policy for cereal-grain products*. Washington, DC.
- Odland, D., and M.S. Eheart. 1975. Ascorbic acid, mineral and quality retention in frozen broccoli blanched in water, steam and ammonia-steam. *J. Food Sci.* 40: 1004–1007.
- Ong, A.S.H. 1993. Natural sources of tocotrienols. In *Vitamin E in health and disease*, ed. L. Packer and J. Fuchs. New York: Marcel Dekker.
- Rouseff, R.L., and S. Nagy. 1994. Health and nutritional benefits of citrus fruit components. *Food Technol.* 48, no. 11: 126–132.
- Sattar, A., and J.M. deMan. 1973. Effect of packaging material on light-induced quality deterioration of milk. *Can. Inst. Food Sci. Technol. J.* 6: 170–174.
- Streiff, R.R. 1971. Folate levels in citrus and other juices. *Am. J. Clin. Nutr.* 24: 1390–1392.
- Thaler, H. 1967. Concentration and stability of tocopherols in foods. In *Tocopherol*, ed. K. Lang. Darmstadt, Germany: Steinkopff Verlag.
- Wendt, G., and E.W. Bernhart. 1960. The structure of a sulfur-containing compound with vitamin B₆ activity. *Arch. Biochem. Biophys.* 88: 270–272.
- White, D.R., et al. 1991. Reverse phase HPLC/EC determination of folate in citrus juice by direct injection with column switching. *J. Agr. Food Chem.* 39: 714–717.

Enzymes

INTRODUCTION

Enzymes, although minor constituents of many foods, play a major and manifold role in foods. Enzymes that are naturally present in foods may change the composition of those foods; in some cases, such changes are desirable but in most instances are undesirable, so the enzymes must be deactivated. The blanching of vegetables is an example of an undesirable change that is deactivated. Some enzymes are used as indicators in analytical methods; phosphatase, for instance, is used in the phosphatase test of pasteurization of milk. Enzymes are also used as processing aids in food manufacturing. For example, rennin, contained in extract of calves' stomachs, is used as a coagulant for milk in the production of cheese.

Food science's emphasis in the study of enzymes differs from that in biochemistry. The former deals mostly with decomposition reactions, hydrolysis, and oxidation; the latter is more concerned with synthetic mechanisms. Whitaker (1972) has prepared an extensive listing of the uses of enzymes in food processing (Table 10-1) and this gives a good summary of the many and varied possible applications of enzymes.

NATURE AND FUNCTION

Enzymes are proteins with catalytic properties. The catalytic properties are quite specific, which makes enzymes useful in analytical studies. Some enzymes consist only of protein, but most enzymes contain additional nonprotein components such as carbohydrates, lipids, metals, phosphates, or some other organic moiety. The complete enzyme is called *holoenzyme*; the protein part, *apoenzyme*; and the nonprotein part, *cofactor*. The compound that is being converted in an enzymic reaction is called *substrate*. In an enzyme reaction, the substrate combines with the holoenzyme and is released in a modified form, as indicated in Figure 10-1. An enzyme reaction, therefore, involves the following equations:

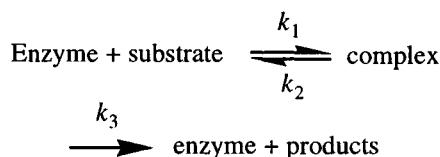

The equilibrium for the formation of the complex is given by

$$K_m = \frac{[E][S]}{[ES]}$$

Table 10–1 Uses and Suggested Uses of Enzymes in Food Processing

<i>Enzyme</i>	<i>Food</i>	<i>Purpose or Action</i>
Amylases	Baked goods	Increase sugar content for yeast fermentation
	Brewing	Conversion of starch to maltose for fermentation; removal of starch turbidities
	Cereals	Conversion of starch to dextrins, sugar; increase water absorption
	Chocolate-cocoa	Liquidification of starches for free flow
	Confectionery	Recovery of sugar from candy scraps
	Fruit juices	Remove starches to increase sparkling properties
	Jellies	Remove starches to increase sparkling properties
	Pectin	An aid in preparation of pectin from apple pomace
	Syrups and sugars	Conversion of starches to low molecular weight dex- trins (corn syrup)
Cellulase	Vegetables	Hydrolysis of starch as in tenderization of peas
	Brewing	Hydrolysis of complex carbohydrate cell walls
	Coffee	Hydrolysis of cellulose during drying of beans
	Fruits	Removal of graininess of pears; peeling of apricots, tomatoes
Dextran-sucrase	Sugar syrups	Thickening of syrup
	Ice cream	Thickening agent, body
Invertase	Artificial honey	Conversion of sucrose to glucose and fructose
	Candy	Manufacture of chocolate-coated, soft, cream can- dies
Lactase	Ice Cream	Prevent crystallization of lactose, which results in grainy, sandy texture
	Feeds	Conversion of lactose to galactose and glucose
	Milk	Stabilization of milk proteins in frozen milk by removal of lactose
Tannase	Brewing	Removal of polyphenolic compounds
Pentosanase	Milling	Recovery of starch from wheat flour
Naringinase	Citrus	Debitting citrus pectin juice by hydrolysis of the glucoside, naringin
Pectic enzymes (use- ful)	Chocolate-cocoa	Hydrolytic activity during fermentation of cocoa
	Coffee	Hydrolysis of gelatinous coating during fermentation of beans
	Fruits	Softening
	Fruit juices	Improve yield of press juices, prevent cloudiness, improve concentration processes
	Olives	Extraction of oil
	Wines	Clarification

continues

Table 10-1 continued

<i>Enzyme</i>	<i>Food</i>	<i>Purpose or Action</i>
Pectic enzymes (deteriorative)	Citrus juice	Destruction and separation of pectic substances of juices
	Fruits	Excessive softening action
Proteases (useful)	Baked goods	Softening action in doughs; cut mixing time, increase extensibility of doughs; improvement in grain, texture, loaf volume; liberate β -amylase
	Brewing	Body, flavor and nutrients development during fermentation; aid in filtration and clarification, chill-proofing
	Cereals	Modify proteins to increase drying rate, improve product handling characteristics; manufacture of miso and tofu
	Cheese	Casein coagulation; characteristic flavors during aging
	Chocolate-cocoa	Action on beans during fermentation
	Eggs, egg products	Improve drying properties
	Feeds	Use in treatment of waste products for conversion to feeds
	Meats and fish	Tenderization; recovery of protein from bones, trash fish; liberation of oils
	Milk	In preparation of soybean milk
	Protein hydrolysates	Condiments such as soy sauce and tamar sauce; specific diets; bouillon, dehydrated soups, gravy powders, processed meats
Proteases (deteriorative)	Wines	Clarification
	Eggs	Shelf life of fresh and dried whole eggs
	Crab, lobster	Overtenderization if not inactivated rapidly
Lipase (useful)	Flour	Influence on loaf volume, texture if too active
	Cheese	Aging, ripening, and general flavor characteristics
	Oils	Conversion of lipids to glycerol and fatty acids
Lipase (deteriorative)	Milk	Production of milk with slightly cured flavor for use in milk chocolate
	Cereals	Overbrowning of oat cakes; brown discoloration of wheat bran
	Milk and dairy products	Hydrolytic rancidity
Phosphatases	Oils	Hydrolytic rancidity
	Baby foods	Increase available phosphate
	Brewing	Hydrolysis of phosphate compounds
Nucleases	Milk	Detection of effectiveness of pasteurization
	Flavor enhancers	Production of nucleotides and nucleosides
Peroxidases (useful)	Vegetables	Detection of effectiveness of blanching
	Glucose determinations	In combination with glucose oxidase

continues

Table 10-1 continued

<i>Enzyme</i>	<i>Food</i>	<i>Purpose or Action</i>
Peroxidases (deteriorative)	Vegetables	Off-flavors
	Fruits	Contribution to browning action
Catalase	Milk	Destruction of H ₂ O ₂ in cold pasteurization
	Variety of products	To remove glucose and/or oxygen to prevent browning and/or oxidation; used in conjunction with glucose oxidase
Glucose oxidase	Variety of products	Removal of oxygen and/or glucose from products such as beer, cheese, carbonated beverages, dried eggs, fruit juices, meat and fish, milk powder, wine to prevent oxidation and/or browning; used in conjunction with catalase
	Glucose determination	Specific determination of glucose; used in conjunction with peroxidase
Polyphenol oxidase (useful)	Tea, coffee, tobacco	Development of browning during ripening, fermentation, and/or aging process
Polyphenol oxidase (deteriorative)	Fruits, vegetables	Browning, off-flavor development, loss of vitamins
Lipoxygenase	Vegetables	Destruction of essential fatty acids and vitamin A; development of off-flavors
Ascorbic acid oxidase	Vegetables, fruits	Destruction of vitamin C (ascorbic acid)
Thiaminase	Meats, fish	Destruction of thiamine

Source: Reprinted with permission from J.R. Whitaker, *Principles of Enzymology for the Food Sciences*, 1972, by courtesy of Marcel Dekker, Inc.

where

E , S , and ES are the enzyme, substrate, and complex, respectively

K_m is the equilibrium constant

This can be expressed in the form of the Michaelis-Menten equation, as follows:

$$v = V \frac{[S]}{[S] + K_m}$$

where

v is the initial short-time velocity of the reaction at substrate concentration $[S]$

V is the maximum velocity that can be attained at a high concentration of the substrate where all of the enzyme is in the form of the complex

This equation indicates that when v is equal to one-half of V , the equilibrium constant K_m is numerically equal to S . A plot of the reaction rates at different substrate concentrations can be used to determine K_m . Because it is not always possible to attain the maximum reaction rate at varying substrate concentrations, the Michaelis-Menten equation has been modified by using reciprocals and in this

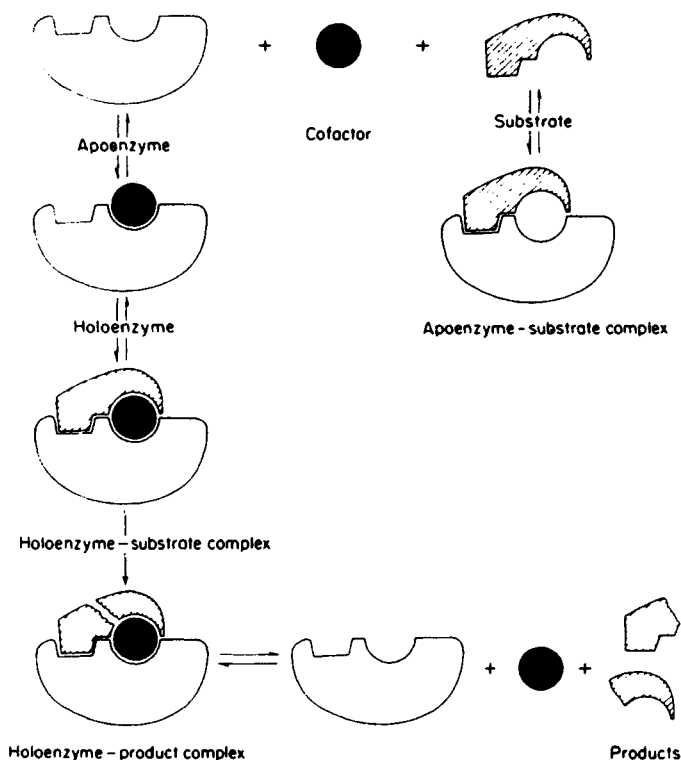

Figure 10-1 The Nature of Enzymes—Substrate Reactions

form is known as the Lineweaver-Burke equation,

$$\frac{1}{v} = \frac{1}{V} + \frac{K_m}{V[S]}$$

Plots of $1/v$ as a function of $1/[S]$ result in straight lines; the intercept on the Y-axis represents $1/V$; the slope equals K_m/V ; and from the latter, K_m can be calculated.

Enzyme reactions follow either zero-order or first-order kinetics. When the substrate concentration is relatively high, the concentration of the enzyme-substrate complex will be maintained at a constant level and the

amount of product formed is a linear function of the time interval. Zero-order reaction kinetics are characteristic of catalyzed reactions and can be described as follows:

$$\frac{d[S]}{dt} = k^{\circ}$$

where

S is substrate and k° is the zero-order reaction constant

First-order reaction kinetics are characterized by a graduated slowdown of the formation of product. This is because the rate of its formation is a function of the concentration

of unreacted substrate, which decreases as the concentration of product increases. First-order reaction kinetics follow the equation,

$$\frac{d[S]}{dt} = k^1 ([S] - [P])$$

where

P is product and k^1 is the first-order reaction constant

For relatively short reaction times, the amount of substrate converted is proportional to the enzyme concentration.

Each enzyme has one—and some enzymes have more—optimum pH values. For most enzymes this is in the range of 4.5 to 8.0. Examples of pH optima are amylase, 4.8; invertase, 5.0; and pancreatic α -amylase, 6.9. The pH optimum is usually quite narrow, although some enzymes have a broader optimum range; for example, pectin methyl-esterase has a range of 6.5 to 8.0. Some enzymes have a pH optimum at very high or very low values, such as pepsin at 1.8 and arginase at 10.0.

Temperature has two counteracting effects on the activity of enzymes. At lower temperatures, there is a Q_{10} of about 2, but at temperatures over 40°C, the activity quickly decreases because of denaturation of the protein part of the enzymes. The result of these factors is a bell-shaped activity curve with a distinct temperature optimum.

Enzymes are proteins that are synthesized in the cells of plants, animals, or microorganisms. Most enzymes used in industrial applications are now obtained from microorganisms. Cofactors or coenzymes are small, heat-stable, organic molecules that may readily dissociate from the protein and can often be removed by dialysis. These coenzymes frequently contain one of the B vitamins; examples are tetrahydrofolic acid and thiamine pyrophosphate.

Specificity

The nature of the enzyme-substrate reaction as explained in Figure 10–1 requires that each enzyme reaction is highly specific. The shape and size of the active site of the enzyme, as well as the substrate, are important. But this complementarity may be even further expanded to cover amino acid residues in the vicinity of the active site, hydrophobic areas near the active site, or the presence of a positive electrical charge near the active site (Parkin 1993). Types of specificity may include group, bond, stereo, and absolute specificity, or some combination of these. An example of the specificity of enzymes is given in Figure 10–2, which illustrates the specificity of proline-specific peptidases (Habibi-Najafi and Lee 1996). The amino acid composition of casein is high in proline, and the location of this amino acid in the protein chain is inaccessible to common aminopeptidases and the di- and tripeptidases with broad specificity. Hydrolysis of the proline bonds requires proline-specific peptidases, including several exopeptidases and an endopeptidase. Figure 10–2 illustrates that this type of specificity is related to the type of amino acid in a protein as well as its location in the chain. Neighboring amino acids also determine the type of peptidase required to hydrolyze a particular peptide bond.

Classification

Enzymes are classified by the Commission on Enzymes of the International Union of Biochemistry. The basis for the classification is the division of enzymes into groups according to the type of reaction catalyzed. This, together with the name or names of substrate(s), is used to name individual enzymes. Each well-defined enzyme can be

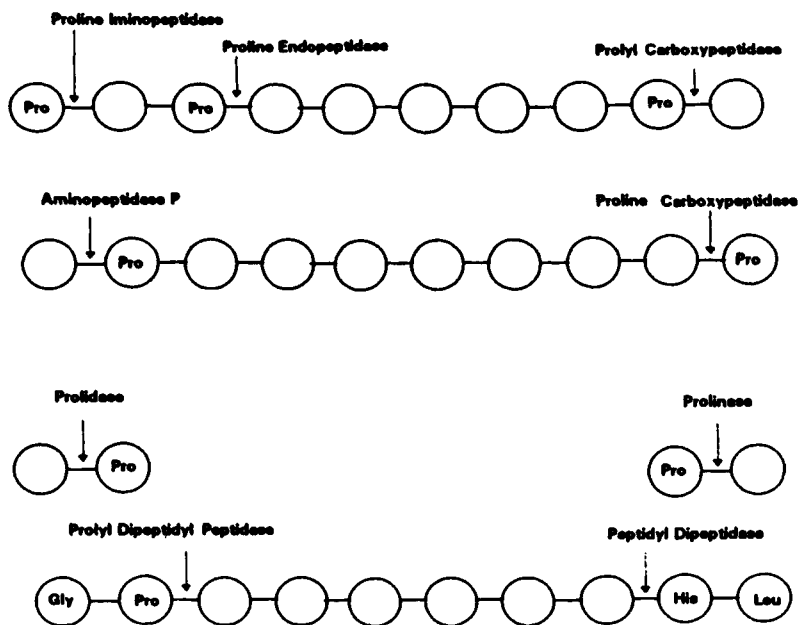

Figure 10-2 Mode of Action of Proline-Specific Peptidases. *Source:* Reprinted with permission from M.B. Habibi-Najafi and B.H. Lee, Bitterness in Cheese: A Review, *Crit. Rev. Food Sci. Nutr.*, Vol. 36, No. 5, p. 408. Copyright CRC Press, Boca Raton, Florida.

described in three ways—by a systematic name, by a trivial name, and by a number of the Enzyme Commission (EC). Thus, the enzyme α -amylase (trivial name) has the systematic name α -1,4-glucan-4-glucanohydrolase, and the number EC 3.2.1.1. The system of nomenclature has been described by Whitaker (1972; 1974) and Parkin (1993).

Enzyme Production

Some of the traditionally used industrial enzymes (e.g., rennet and papain) are prepared from animal and plant sources. Recent developments in industrial enzyme production have emphasized the microbial enzymes (Frost 1986). Microbial enzymes are very heat stable and have a broader pH optimum. Most of these enzymes are made by submerged cultivation of highly developed strains of microorganisms. Developments in

biotechnology will make it possible to transfer genes for the elaboration of specific enzymes to different organisms. The major industrial enzyme processes are listed in Table 10-2.

HYDROLASES

The hydrolases as a group include all enzymes that involve water in the formation of their products. For a substrate AB , the reaction can be represented as follows:

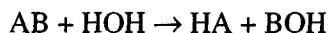

The hydrolases are classified on the basis of the type of bond hydrolyzed. The most important are those that act on ester bonds, glycosyl bonds, peptide bonds, and C-N bonds other than peptides.

Table 10–2 Major Industrial Enzymes and the Process Used for Their Production

Enzyme	Source	Submerged Fermentation	Surface Fermentation	Intracellular	Extracellular	Concentration	Precipitation	Drying	Pelleting	Further Purification	Solid Product	Solution Product	Immobilized Product
Proteases													
Rennet	Calf stomach	—	—	—	✓	—	—	✓	—	—	✓	✓	—
Trypsin	Animal pancreas	—	—	—	✓	✓	✓	✓	—	✓	✓	—	—
Papain	Carica papaya fruit	—	—	—	✓	—	—	✓	—	—	✓	✓	—
Fungal	<i>Aspergillus oryzae</i>	✓	✓	—	✓	✓	✓	✓	—	—	✓	—	—
Fungal (rennins)	<i>Mucor</i> spp.	✓	✓	—	✓	✓	—	✓	—	—	✓	✓	—
Bacterial	<i>Bacillus</i> spp.	✓	—	—	✓	✓	✓	✓	✓	—	✓	✓	—
Glycosidases													
Bacterial α -amylase	<i>Bacillus</i> spp.	✓	—	—	✓	✓	—	✓	—	—	✓	✓	—
Fungal α -amylase	<i>Aspergillus oryzae</i>	✓	—	—	✓	✓	—	✓	—	—	✓	✓	—
β -amylase	Barley	—	—	—	✓	✓	✓	✓	—	—	✓	—	—
Amyloglucosidase	<i>Aspergillus niger</i>	✓	—	—	✓	✓	—	—	—	—	—	✓	—
Pectinase	<i>Aspergillus niger</i>	—	✓	—	✓	✓	—	✓	—	—	✓	✓	—
Cellulase	Molds	✓	—	—	✓	✓	✓	—	—	✓	✓	—	—
Yeast lactase	<i>Kluyveromyces</i> spp.	✓	—	✓	—	—	✓	✓	—	—	✓	✓	—
Mold lactase	<i>Aspergillus</i> spp.	✓	✓	—	✓	—	✓	✓	—	—	✓	—	✓
Others													
Glucose isomerase	Various microbial sources	✓	—	✓	—	✓	✓	✓	—	—	—	—	✓
Glucose oxidase	<i>Aspergillus niger</i>	✓	—	✓	—	—	✓	—	—	✓	✓	✓	—
Mold catalase	<i>Aspergillus niger</i>	✓	—	✓	—	—	✓	—	—	—	—	✓	—
Animal catalase	Liver	—	—	✓	—	✓	✓	✓	—	✓	✓	✓	—
Lipase	Molds	✓	—	—	✓	✓	✓	✓	—	—	✓	—	—

Source: From G.M. Frost, Commercial Production of Enzymes, in *Developments in Food Proteins*, B.J.F. Hudson, ed., 1986, Elsevier Applied Science Publishers Ltd.

Esterases

The esterases are involved in the hydrolysis of ester linkages of various types. The products formed are acid and alcohol. These enzymes may hydrolyze triglycerides and include several lipases; for instance, phospholipids are hydrolyzed by phospholipases, and cholesterol esters are hydrolyzed by cholesterol esterase. The carboxylesterases are enzymes that hydrolyze triglycerides such as tributyrin. They can be distinguished from lipases because they hydrolyze soluble substrates, whereas lipases only act at the water-lipid interfaces of emulsions. Therefore, any condition that results in increased surface area of the water-lipid interface will increase the activity of the enzyme. This is the reason that lipase activity is much greater in homogenized (not pasteurized) milk than in the non-homogenized product. Most of the lipolytic enzymes are specific for either the acid or the alcohol moiety of the substrate, and, in the case of esters of polyhydric alcohols, there may also be a positional specificity.

Lipases are produced by microorganisms such as bacteria and molds; are produced by plants; are present in animals, especially in the pancreas; and are present in milk. Lipases may cause spoilage of food because the free fatty acids formed cause rancidity. In other cases, the action of lipases is desirable and is produced intentionally. The boundary between flavor and off-flavor is often a very narrow range. For instance, hydrolysis of milk fat in milk leads to very unpleasant off-flavors at very low free fatty acid concentration. The hydrolysis of milk fat in cheese contributes to the desirable flavor. These differences are probably related to the background upon which these fatty acids are superimposed and to the specificity for particular groups of fatty acids of each enzyme.

In seeds, lipases may cause fat hydrolysis unless the enzymes are destroyed by heat. Palm oil produced by primitive methods in Africa used to consist of more than 10 percent of free fatty acids. Such spoilage problems are also encountered in grains and flour. The activity of lipase in wheat and other grains is highly dependent on water content. In wheat, for example, the activity of lipase is five times higher at 15.1 percent than at 8.8 percent moisture. The lipolytic activity of oats is higher than that of most other grains.

Lipases can be divided into those that have a positional specificity and those that do not. The former preferentially hydrolyze the ester bonds of the primary ester positions. This results in the formation of mono- and diglycerides, as represented by the following reaction:

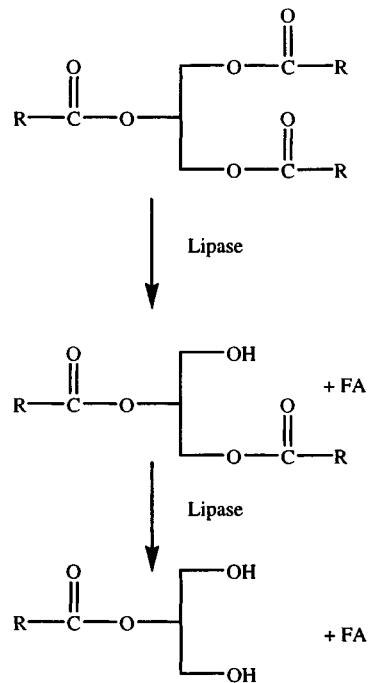

During the progress of the reaction, the concentration of diglycerides and monoglycerides increases, as is shown in Figure 10-3.

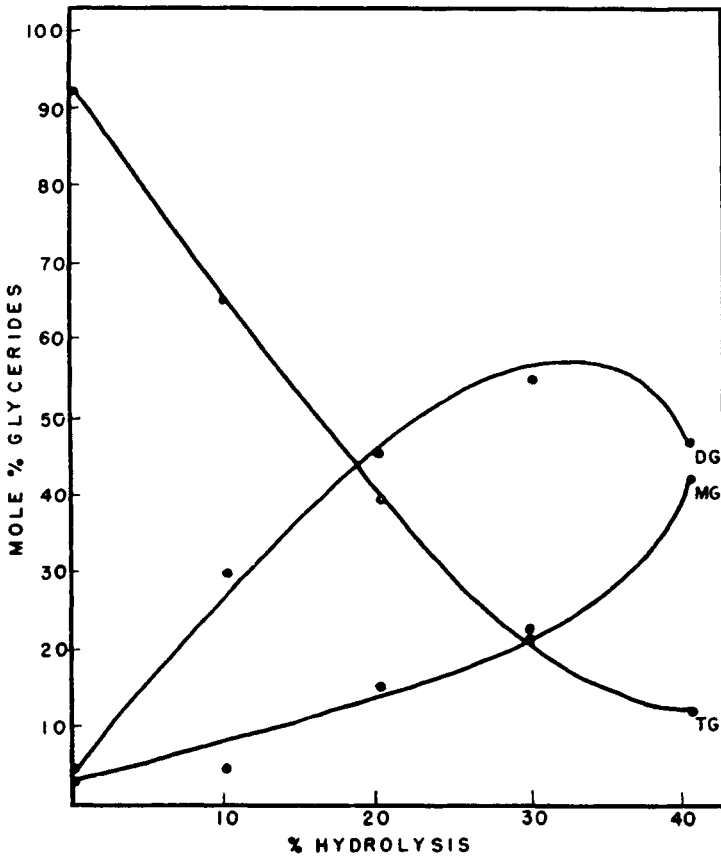

Figure 10-3 The Course of Pancreatic Lipase Hydrolysis of Tricaprylin. MG = monoglycerides, DG = diglycerides, TG = triglycerides. *Source:* From A. Boudreau and J.M. deMan, *The Mode of Action of Pancreatic Lipase on Milkfat Glycerides*, *Can. J. Biochem.*, Vol. 43, pp. 1799-1805, 1965.

The β -monoglycerides formed are resistant to further hydrolysis. This pattern is characteristic of pancreatic lipase and has been used to study the triglyceride structure of many fats and oils.

The hydrolysis of triglycerides in cheese is an example of a desirable flavor-producing process. The extent of free fatty acid formation is much higher in blue cheese than in Cheddar cheese, as is shown in Table 10-3. This is most likely the result of lipases elabo-

rated by organisms growing in the blue cheese, such as *P. roqueforti*, *P. camemberti*, and others. The extent of lipolysis increases with age, as is demonstrated by the increasing content of partial glycerides during the aging of cheese (Table 10-4). In many cases, lipolysis is induced by the addition of lipolytic enzymes. In the North American chocolate industry, it is customary to induce some lipolysis in chocolate by means of lipase. In the production of Italian cheeses, lipolysis is

Table 10-3 Free Fatty Acids in Some Dairy Products

Product	Free Fatty Acids (mg/kg)
Fresh milk	415
Moderately rancid cream	1,027
Butter	2,733
Cheddar cheese	1,793 (avg of 12 samples)
Blue cheese	23,500 to 66,700 (range 3 samples)

Source: From E.A. Day, Role of Milk Lipids in Flavors of Dairy Products, in *Flavor Chemistry*, R.F. Gould, ed., 1966, American Chemical Society.

induced by the use of pregastric esterases. These are lipolytic enzymes obtained from the oral glands located at the base of the tongue in calves, lambs, or kids.

Specificity for certain fatty acids by some lipolytic enzymes has been demonstrated. Pancreatic lipase and milk lipase are broad-spectrum enzymes and show no specificity for any of the fatty acids found in fats. Instead, the fatty acids that are released from

Table 10-4 Formation of Partial Glycerides in Cheddar Cheese

Product Type	Diglycerides (wt %)	Mono-glycerides (wt %)
Mild	7.4-7.6	1.0-2.0
Medium	7.6-9.7	0.5-1.4
Old	11.9-15.6	1.1-3.2

the glycerides occur in about the same ratio as they are present in the original fat. Specificity was shown by Nelson (1972) in calf esterase and in a mixed pancreatin-esterase preparation (Table 10-5). Pregastric esterases and lipase from *Aspergillus* species primarily hydrolyze shorter chain-length fatty acids (Arnold et al. 1975).

Specificity of lipases may be expressed in a number of different ways—substrate specific, regiospecific, nonspecific, fatty acyl specific, and stereospecific. Examples of these specificities have been presented by Villeneuve and Foglia (1997) (Table 10-6).

Substrate specificity is the ability to hydrolyze a particular glycerol ester, such as when

Table 10-5 Free Fatty Acids Released from Milkfat by Several Lipolytic Enzymes

Fatty Acid	Milk Lipase	Steapsin	Pancreatic Lipase	Calf Esterase	Esterase Pancreatin
4:0	13.9	10.7	14.4	35.00	15.85
6:0	2.1	2.9	2.1	2.5	3.6
8:0	1.8	1.5	1.4	1.3	3.0
10:0	3.0	3.7	3.3	3.1	5.5
12:0	2.7	4.0	3.8	5.1	4.4
14:0	7.7	10.7	10.1	13.2	8.5
16:0	21.6	21.6	24.0	15.9	19.3
18:1 and 18:2	29.2	24.3	25.5	14.2	21.1
18:0	10.5	13.4	9.7	3.2	10.1

Source: From J.H. Nelson, Enzymatically Produced Flavors for Fatty Systems, *J. Am. Oil Chem. Soc.*, Vol. 49, pp. 559-562, 1972.

Table 10–6 Examples of Lipase Specificities

Specificity	Lipase
Substrate specific	
Monoacylglycerols	Rat adipose tissue
Mono- and diacylglycerols	<i>Penicillium camembertii</i>
Triacylglycerols	<i>Penicillium</i> sp.
Regiospecific	
1,3-regioselective	<i>Aspergillus niger</i> <i>Rhizopus arrhizus</i> <i>Mucor miehei</i>
sn-2-regioselective	<i>Candida antarctica</i> A
Nonspecific	
	<i>Penicillium expansum</i> <i>Aspergillus</i> sp. <i>Pseudomonas cepacia</i>
Fatty acylspecific	
Short-chain fatty acid (FA)	<i>Penicillium roqueforti</i> Premature infant gastric
cis-9 unsaturated FA	<i>Geotrichum candidum</i>
Long-chain unsaturated FA	<i>Botrytis cinerea</i>
Stereospecific	
sn-1 stereospecific	<i>Humicola lanuginosa</i> <i>Pseudomonas aeruginosa</i>
sn-3 stereospecific	<i>Fusarium solani</i> cutinase Rabbit gastric

Source: Reprinted with permission from P. Ville-neuve and T.A. Foglia, Lipase Specificities: Potential Application in Lipid Bioconversions, *J. Am. Oil Chem. Soc.*, Vol. 8, p. 641, © 1997, AOCS Press.

a lipase can rapidly hydrolyze a triacylglycerol, but acts on a monoacylglycerol only slowly. Regiospecificity involves a specific action on either the sn-1 and sn-3 positions or reaction with only the sn-2 position. The

1,3-specific enzymes have been researched extensively, because it is now recognized that lipases in addition to hydrolysis can catalyze the reverse reaction, esterification or transesterification. This has opened up the possibility of tailor-making triacylglycerols with a specific structure, and this is especially important for producing high-value fats such as cocoa butter equivalents. The catalytic activity of lipases is reversible and depends on the water content of the reaction mixture. At high water levels, the hydrolytic reaction prevails, whereas at low water levels the synthetic reaction is favored. A number of lipase catalyzed reactions are possible, and these have been summarized in Figure 10–4 (Ville-neuve and Foglia 1997). Most of the lipases used for industrial processes have been developed from microbes because these usually exhibit high temperature tolerance. Lipases from *Mucor miehei* and *Candida antarctica* have been cloned and expressed in industry-friendly organisms. Lipases from genetically engineered strains will likely be of major industrial importance in the future (Godtfredsen 1993). Fatty acid-specific lipases react with either short-chain fatty acids (*Penicillium roqueforti*) or some long-chain fatty acids such as cis-9-unsaturated fatty acids (*Geotrichum candidum*). Stereospecific lipases react with only fatty acids at the sn-1 or sn-3 position.

The applications of microbial lipases in the food industry involve the hydrolytic as well as the synthetic capabilities of these enzymes and have been summarized by Godtfredsen (1993) in Table 10–7.

The lipase-catalyzed interesterification process can be used for the production of triacylglycerols with specific physical properties, and it also opens up possibilities for making so-called structured lipids. An example is a triacylglycerol that carries an essen-

Hydrolysis

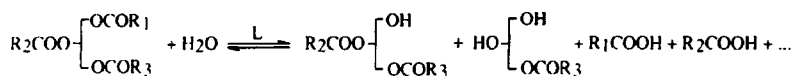

Esterification



Interesterification

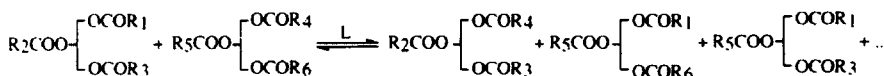

Transesterification

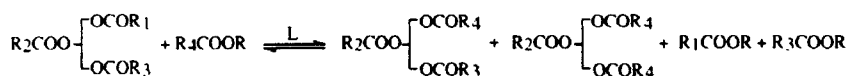

Alcoholysis

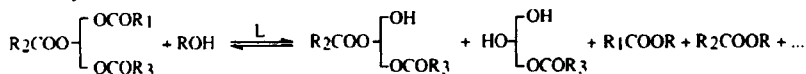

Acidolysis

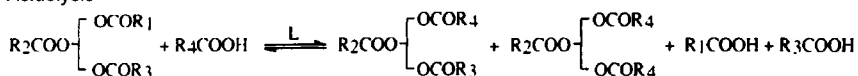

Figure 10-4 Lipase Catalyzed Reactions Used in Oil and Fat Modification. *Source:* Reprinted with permission from P. Villeneuve and T.A. Foglia, *Lipase Specificities: Potential Application in Lipid Bioconversions*, *J. Am. Oil Chem. Soc.*, Vol. 8, p. 642, © 1997, AOCs Press.

tial fatty acid (e.g., DHA-docosahexaenoic acid) in the sn-2 position and short-chain fatty acids in the sn-1 and sn-3 positions. Such a structural triacylglycerol would rapidly be hydrolyzed in the digestive tract and provide an easily absorbed monoacylglycerol that carries the essential fatty acid (Godtfredsen 1993).

The lipases that have received attention for their ability to synthesize ester bonds have been obtained from yeasts, bacteria, and fungi. Lipases can be classified into three

groups according to their specificity (Macrae 1983). The first group contains nonspecific lipases. These show no specificity regarding the position of the ester bond in the glycerol molecule, or the nature of the fatty acid. Examples of enzymes in this group are lipases of *Candida cylindracea*, *Corynebacterium acnes*, and *Staphylococcus aureus*. The second group contains lipases with position specificity for the 1- and 3-positions of the glycerides. This is common among microbial lipases and is the result of the steri-

Table 10-7 Application of Microbial Lipases in the Food Industry

Industry	Effect	Product
Dairy	Hydrolysis of milk fat	Flavor agents
	Cheese ripening	Cheese
	Modification of butter fat	Butter
Bakery	Flavor improvement and shelf-life prolongation	Bakery products
Beverage	Improved aroma	Beverages
Food dressing	Quality improvement	Mayonnaise, dressing, and whipped toppings
Health food	Transesterification	Health foods
Meat and fish	Flavor development and fat removal	Meat and fish products
Fat and oil	Transesterification	Cocoa butter, margarine
	Hydrolysis	Fatty acids, glycerol, mono- and diglycerides

Source: Reprinted with permission from S.E. Godtfredsen, Lipases, Enzymes in Food Processing, T. Nagodawithana and G. Reed, eds., p. 210, © 1993, Academic Press.

cally hindered ester bond of the 2-position's inability to enter the active site of the enzyme. Lipases in this group are obtained from *Aspergillus niger*, *Mucor javanicus*, and *Rhizopus arrhizus*. The third group of lipases show specificity for particular fatty acids. An example is the lipase from *Geotrichum candidum*, which has a marked specificity for long-chain fatty acids that contain a *cis* double bond in the 2-position. The knowledge of the synthetic ability of lipases has opened a whole new area of study in the modification of fats. The possibility of modifying fats and oils by immobilized lipase technology may result in the production of food fats that have a higher essential fatty acid content and lower *trans* levels than is possible with current methods of hydrogenation.

Amylases

The amylases are the most important enzymes of the group of glycoside hydro-

lases. These starch-degrading enzymes can be divided into two groups, the so-called debranching enzymes that specifically hydrolyze the 1,6-linkages between chains, and the enzymes that split the 1,4-linkages between glucose units of the straight chains. The latter group consists of endoenzymes that cleave the bonds at random points along the chains and exoenzymes that cleave at specific points near the chain ends. This behavior has been represented by Marshall (1975) as a diagram of the structure of amylopectin (Figure 10-5). In this molecule, the 1,4- α -glucan chains are interlinked by 1,6- α -glucosidic linkages resulting in a highly branched molecule. The molecule is composed of three types of chains; the *A* chains carry no substituent, the *B* chains carry other chains linked to a primary hydroxyl group, and the molecule contains only one *C* chain with a free reducing glucose unit. The chains are 25 to 30 units in length in starch and only 10 units in glycogen.

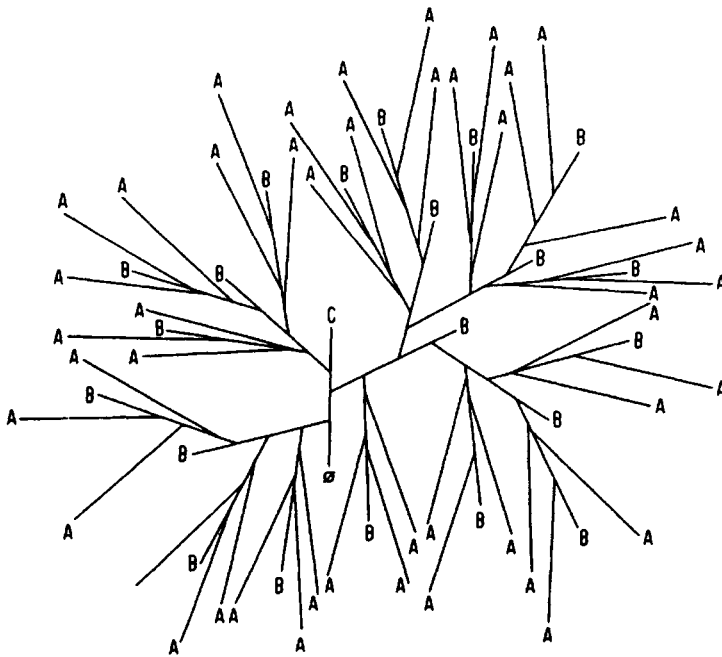

Figure 10-5 Diagrammatic Representation of Amylopectin Structure. Lines represent α -D-glucan chains linked by 1,4-bonds. The branch points are 1,6- α glucosidic bonds. *Source:* From J.J. Marshall, *Starch Degrading Enzymes, Old and New, Starke*, Vol. 27, pp. 377-383, 1975.

Alpha-amylase (α -1,4-Glucan 4-Glucanohydrolase)

This enzyme is distributed widely in the animal and plant kingdoms. The enzyme contains 1 gram-atom of calcium per mole. Alpha-amylase (α -1,4-glucan-4-glucanohydrolase) is an endoenzyme that hydrolyzes the α -1,4-glycosidic bonds in a random fashion along the chain. It hydrolyzes amylopectin to oligosaccharides that contain two to six glucose units. This action, therefore, leads to a rapid decrease in viscosity, but little monosaccharide formation. A mixture of amylose and amylopectin will be hydrolyzed into a mixture of dextrans, maltose, glucose, and

oligosaccharides. Amylose is completely hydrolyzed to maltose, although there usually is some maltotriose formed, which hydrolyzes only slowly.

Beta-amylase (α -1,4-Glucan Maltohydrolase)

This is an exoenzyme and removes successive maltose units from the nonreducing end of the glucosidic chains. The action is stopped at the branch point where the α -1,6 glycosidic linkage cannot be broken by α -amylase. The resulting compound is named *limit dextrin*. Beta-amylase is found only in

higher plants. Barley malt, wheat, sweet potatoes, and soybeans are good sources. Beta-amylase is technologically important in the baking, brewing, and distilling industries, where starch is converted into the fermentable sugar maltose. Yeast ferments maltose, sucrose, invert sugar, and glucose but does not ferment dextrans or oligosaccharides containing more than two hexose units.

Glucoamylase (α -1,4-Glucan Glucohydrolase)

This is an exoenzyme that removes glucose units in a consecutive manner from the non-reducing end of the substrate chain. The product formed is glucose only, and this differentiates this enzyme from α - and β -amylase. In addition to hydrolyzing the α -1,4 linkages, this enzyme can also attack the α -1,6 linkages at the branch point, albeit at a slower rate. This means that starch can be completely degraded to glucose. The enzyme is present in bacteria and molds and is used industrially in the production of corn syrup and glucose.

A problem in the enzymic conversion of corn starch to glucose is the presence of transglucosidase enzyme in preparations of α -amylase and glucoamylase. The transglucosidase catalyzes the formation of oligosaccharides from glucose, thus reducing the yield of glucose.

Nondamaged grains such as wheat and barley contain very little α -amylase but relatively high levels of β -amylase. When these grains germinate, the β -amylase level hardly changes, but the α -amylase content may increase by a factor of 1,000. The combined action of α - and β -amylase in the germinated grain greatly increases the production of fermentable sugars. The development of α -amylase activity during malting of barley is shown in Table 10-8. In wheat flour, high α -

amylase activity is undesirable, because too much carbon dioxide is formed during baking.

Raw, nondamaged, and ungelatinized starch is not susceptible to β -amylase activity. In contrast, α -amylase can slowly attack intact starch granules. This differs with the type of starch; for example, waxy corn starch is more easily attacked than potato starch. In general, extensive hydrolysis of starch requires gelatinization. Damaged starch granules are more easily attacked by amylases, which is important in bread making. Alpha-amylase can be obtained from malt, from fungi (*Aspergillus oryzae*), or from bacteria (*B. subtilis*). The bacterial amylases have a higher temperature tolerance than the malt amylases.

Beta-galactosidase (β -D-Galactoside Galactohydrolase)

This enzyme catalyzes the hydrolysis of β -D-galactosides and α -L-arabinosides. It is best known for its action in hydrolyzing lactose and is, therefore, also known as lactase. The enzyme is widely distributed and occurs in higher animals, bacteria, yeasts, and

Table 10-8 Development of α -Amylase During Malting of Barley at 20°C

<i>Days of Steeping and Germination</i>	<i>α-Amylase (20° Dextrose Units)</i>
0	0
3	55
5	110
7	130
8	135

Source: From S.R. Green, *New Use of Enzymes in the Brewing Industry*, MBAA Tech. Quar., Vol. 6, pp. 33-39, 1969.

plants. Beta-galactosidase or lactase is found in humans in the cells of the intestinal mucous membrane. A condition that is widespread in non-Caucasian adults is characterized by an absence of lactase. Such individuals are said to have lactose intolerance, which is an inability to digest milk properly.

The presence of galactose inhibits lactose hydrolysis by lactase. Glucose does not have this effect.

Pectic Enzymes

The pectic enzymes are capable of degrading pectic substances and occur in higher plants and in microorganisms. They are not found in higher animals, with the exception of the snail. These enzymes are commercially important for the treatment of fruit juices and beverages to aid in filtration and clarification and increasing yields. The enzymes can also be used for the production of low methoxyl pectins and galacturonic acids. The presence of pectic enzymes in fruits and vegetables can result in excessive softening. In tomato and fruit juices, pectic enzymes may cause "cloud" separation.

There are several groups of pectic enzymes, including pectinesterase, the enzyme that hydrolyzes methoxyl groups, and the depolymerizing enzymes polygalacturonase and pectate lyase.

Pectinesterase (Pectin Pectyl-Hydrolase)

This enzyme removes methoxyl groups from pectin. The enzyme is referred to by several other names, including pectase, pectin methoxylase, pectin methyl esterase, and pectin demethylase. Pectinesterases are found in bacteria, fungi, and higher plants, with very large amounts occurring in citrus fruits and tomatoes. The enzyme is specific for galacturonide esters and will not attack non-galacturonide methyl esters to any large extent. The reaction catalyzed by pectin esterase is presented in Figure 10-6. It has been suggested that the distribution of methoxyl groups along the chain affects the reaction velocity of the enzyme (MacMillan and Sheiman 1974). Apparently, pectinesterase requires a free carboxyl group next to an esterified group on the galacturonide chain to act, with the pectinesterase moving down the chain linearly until an obstruction is reached.

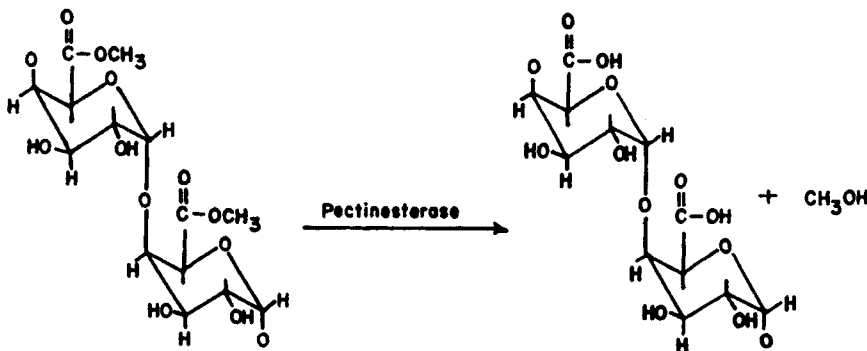

Figure 10-6 Reaction Catalyzed by Pectinesterase

To maintain cloud stability in fruit juices, high-temperature–short-time (HTST) pasteurization is used to deactivate pectolytic enzymes. Pectin is a protective colloid that helps to keep insoluble particles in suspension. Cloudiness is required in commercial products to provide a desirable appearance. The destruction of the high levels of pectinesterase during the production of tomato juice and puree is of vital importance. The pectinesterase will act quite rapidly once the tomato is broken. In the so-called hot-break method, the tomatoes are broken up at high temperature so that the pectic enzymes are destroyed instantaneously.

Polygalacturonase (Poly- α -1,4-Galacturonide Glycanohydrolase)

This enzyme is also known as pectinase, and it hydrolyzes the glycosidic linkages in pectic substances according to the reaction pattern shown in Figure 10–7. The polygalacturonases can be divided into endoenzymes that act within the molecule on α -1,4 linkages and exoenzymes that catalyze the stepwise hydrolysis of galacturonic acid

molecules from the nonreducing end of the chain. A further division can be made by the fact that some polygalacturonases act principally on methylated substrates (pectins), whereas others act on substrates with free carboxylic acid groups (pectic acids). These enzymes are named polymethyl galacturonases and polygalacturonases, respectively. The preferential mode of hydrolysis and the preferred substrates are listed in Table 10–9. Endopolygalacturonases occur in fruits and in filamentous fungi, but not in yeast or bacteria. Exopolygalacturonases occur in plants (for example, in carrots and peaches), fungi, and bacteria.

Pectate Lyase (Poly- α -1,4-D-Galacturonide Lyase)

This enzyme is also known as *trans*-eliminase; it splits the glycosidic bonds of a glucuronide chain by *trans* elimination of hydrogen from the 4- and 5-positions of the glucuronide moiety. The reaction pattern is presented in Figure 10–8. The glycosidic bonds in pectin are highly susceptible to this reaction. The pectin lyases are of the endo-type and are obtained exclusively from fila-

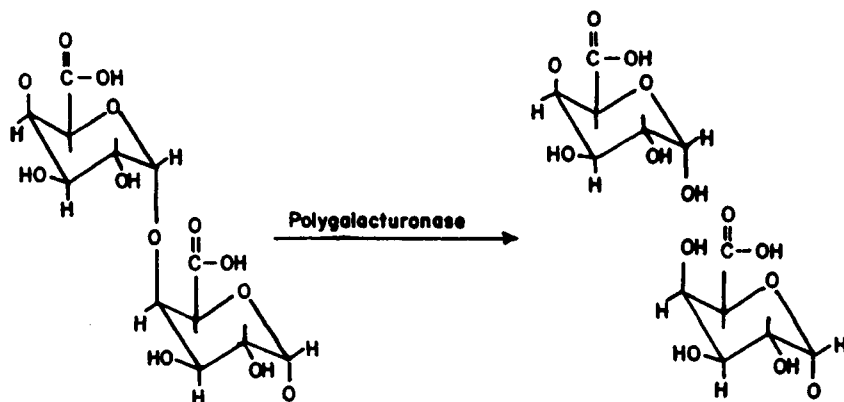

Figure 10–7 Reaction Catalyzed by Polygalacturonase

Table 10-9 Action of Polygalacturonases

Type of Attack	Enzyme	Preferred Substrate
Random	Endo-polymethylgalacturonase	Pectin
Random	Endo-polygalacturonase	Pectic acid
Terminal	Exo-polymethylgalacturonase	Pectin
Terminal	Exo-polygalacturonase	Pectic acid

mentous fungi, such as *Aspergillus niger*. The purified enzyme has an optimum pH of 5.1 to 5.2 and isoelectric point between 3 and 4 (Albersheim and Kilius 1962).

Commercial Use

Pectic enzymes are used commercially in the clarification of fruit juices and wines and for aiding the disintegration of fruit pulps. By reducing the large pectin molecules into smaller units and eventually into galacturonic acid, the compounds become water soluble and lose their suspending power; also, their viscosity is reduced and the insoluble pulp particles rapidly settle out.

Most microorganisms produce at least one but usually several pectic enzymes. Almost all fungi and many bacteria produce these enzymes, which readily degrade the pectin layers holding plant cells together. This leads to separation and degradation of the cells, and the plant tissue becomes soft. Bacterial degradation of pectin in plant tissues is responsible for the spoilage known as "soft rot" in fruits and vegetables. Commercial food grade pectic enzyme preparations may contain several different pectic enzymes. Usually, one type predominates; this depends on the intended use of the enzyme preparation.

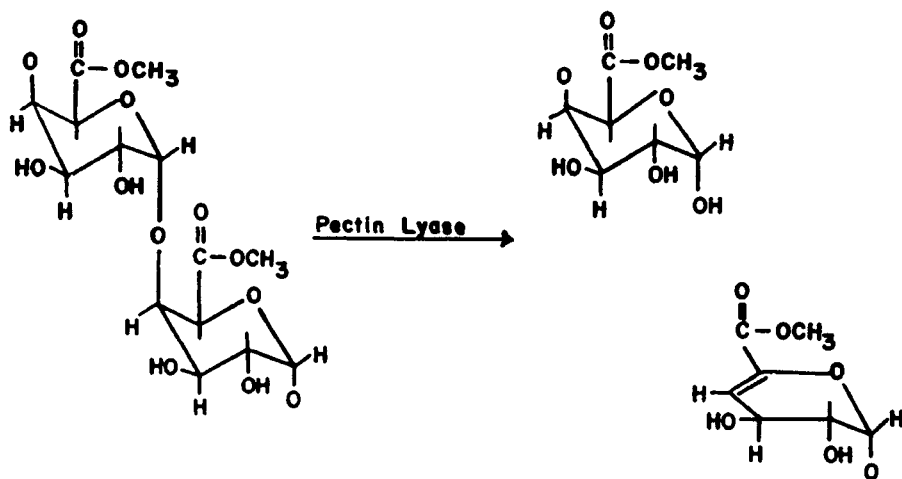
**Figure 10-8** Reaction Catalyzed by Pectin Lyase

Proteases

Proteolytic enzymes are important in many industrial food processing procedures. The reaction catalyzed by proteolytic enzymes is the hydrolysis of peptide bonds of proteins; this reaction is shown in Figure 10-9. Whittaker (1972) has listed the specificity requirements for the hydrolysis of peptide bonds by proteolytic enzymes. These include the nature of R_1 and R_2 groups, configuration of the amino acid, size of substrate molecule, and the nature of the X and Y groups. A major distinguishing factor of proteolytic enzymes is the effect of R_1 and R_2 groups. The enzyme α -chymotrypsin hydrolyzes peptide bonds readily only when R_1 is part of a tyrosyl, phenylalanyl, or tryptophanyl residue. Trypsin requires R_1 to belong to an arginyl or lysyl residue. Specific requirement for the R_2 groups is exhibited by pepsin and the carboxypeptidases; both require R_2 to belong to a phenylalanyl residue. The enzymes require the amino acids of proteins to be in the L-configuration but frequently do not have a strict requirement for molecular size. The nature of X and Y permits the division of proteases into endopeptidases and exopeptidases. The former split peptide bonds in a random way in the interior of the substrate molecule and show maximum activity when X and Y are derived. The carboxypeptidases require that Y be a hydroxyl group, the aminopeptidases require that X be a hydrogen,

and the dipeptidases require that X and Y both be underived.

Proteolytic enzymes can be divided into the following four groups: the acid proteases, the serine proteases, the sulfhydryl proteases, and the metal-containing proteases.

Acid Proteases

This is a group of enzymes with pH optima at low values. Included in this group are pepsin, rennin (chymosin), and a large number of microbial and fungal proteases. Rennin, the pure enzyme contained in rennet, is an extract of calves' stomachs that has been used for thousands of years as a coagulating agent in cheese making. Because of the scarcity of calves' stomachs, rennet substitutes are now widely used, and the coagulants used in cheese making usually contain mixtures of rennin and pepsin and/or microbial proteases. Some of the microbial proteases have been used for centuries in the Far East in the production of fermented foods such as soy sauce.

Rennin is present in the fourth stomach of the suckling calf. It is secreted in an inactive form, a zymogen, named prorennin. The crude extract obtained from the dried stomachs (vells) contains both rennin and prorennin. The conversion of prorennin to rennin can be speeded up by addition of acid. This conversion involves an autocatalytic process, in which a limited proteolysis of the proren-

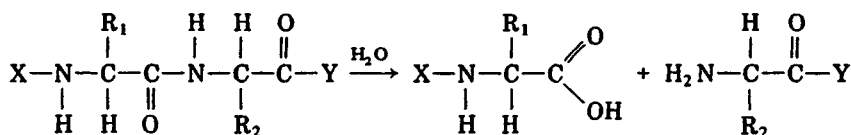

Figure 10-9 Reaction Catalyzed by Proteases

nin occurs, thus reducing the molecular weight about 14 percent. The conversion can also be catalyzed by pepsin. The process involves the release of peptides from the N-terminal end of prorennin, which reduces the molecular weight from about 36,000 to about 31,000. The molecule of prorennin consists of a single peptide chain joined internally by three disulfide bridges. After conversion to rennin, the disulfide bridges remain intact. As the calves grow older and start to eat other feeds as well as milk, the stomach starts to produce pepsin instead of rennin. The optimum activity of rennin is at pH 3.5, but it is most stable at pH 5; the clotting of cheese milk is carried out at pH values of 5.5 to 6.5.

The coagulation or clotting of milk by rennin occurs in two stages. In the first, the enzymic stage, the enzyme acts on κ -casein so that it can no longer stabilize the casein micelle. The second, or nonenzymic stage, involves the clotting of the modified casein micelles by calcium ions. The enzymic stage involves a limited and specific action on the κ -casein, resulting in the formation of insoluble *para*- κ -casein and a soluble macropeptide. The latter has a molecular weight of 6,000 to 8,000, is extremely hydrophilic, and contains about 30 percent carbohydrate. The glycomacropptide contains galactosamine, galactose, and N-acetyl neuraminic acid (sialic acid). The splitting of the glycomacropptide from κ -casein involves the breaking of a phenylalanine-methionine bond in the peptide chain. Other clotting enzymes—including pepsin, chymotrypsin, and microbial proteases—break the same bond and produce the same glycomacropptide.

Pepsin is elaborated in the mucosa of the stomach lining in the form of pepsinogen. The high acidity of the stomach aids in the autocatalytic conversion into pepsin. This

conversion involves splitting several peptide fragments from the N-terminal end of pepsinogen. The fragments consist of one large peptide and several small ones. The large peptide remains associated with pepsinogen by noncovalent bonds and acts as an inhibitor. The inhibitor dissociates from pepsin at a pH of 1 to 2. In the initial stages of the conversion of pepsinogen to pepsin, six peptide bonds are broken, and continued action on the large peptide (Figure 10-10) results in three more bonds being hydrolyzed. In this process, the molecular weight changes from 43,000 to 35,000 and the isoelectric point changes from 3.7 to less than 1. The pepsin molecule consists of a single polypeptide chain that contains 321 amino acids. The tertiary structure is stabilized by three disulfide bridges and a phosphate linkage. The phosphate group is attached to a seryl residue and is not essential for enzyme activity. The pH optimum of pepsin is pH 2 and the enzyme is stable from pH 2 to 5. At higher pH values, the enzyme is rapidly denatured and loses its activity. The primary specificity of pepsin is toward the R_2 group (see the equation shown in Figure 10-9), and it prefers this to be a phenylalanyl, tyrosyl, or tryptophanyl group.

The use of other acid proteases as substitutes for rennin in cheese making is determined by whether bitter peptides are formed during ripening of the cheese and by whether initial rapid hydrolysis causes excessive protein losses in the whey. Some of the acid proteases used in cheese making include preparations obtained from the organisms *Endothia parasitica*, *Mucor miehei*, and *Mucor pusillus*. Rennin contains the enzyme chymosin, and the scarcity of this natural enzyme preparation for cheese making resulted in the use of pepsin for this purpose. Pepsin and chymosin have primary structures that have about 50 percent homology

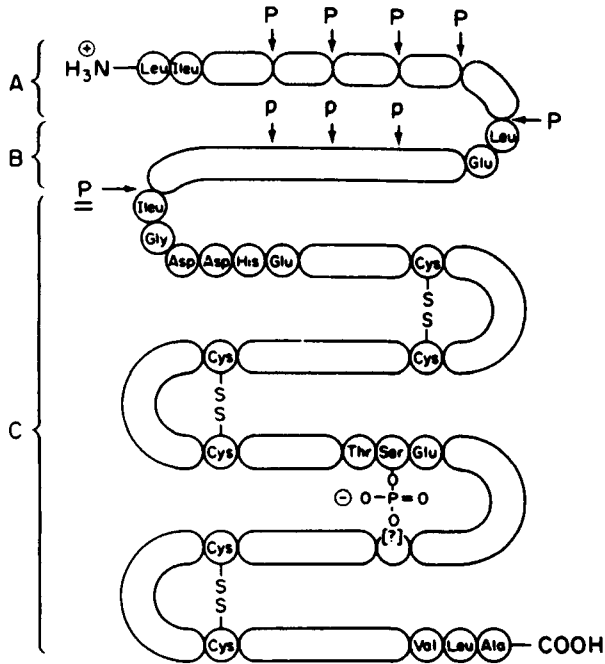

Figure 10–10 Structure of Pepsinogen and Its Conversion to Pepsin. *Source:* From F.A. Bovey and S.S. Yanari, Pepsin, in *The Enzymes*, Vol. 4, P.D. Boyer et al., eds., 1960, Academic Press.

and quite similar tertiary structures. The molecular mass of the two enzymes is similar, 35 kDa, but chymosin has a higher pI. Much of the chymosin used in cheese making is now obtained by genetic engineering processes. In the production of soy sauce and other eastern food products, such as miso (an oriental fermented food) and ketjap (Indonesian type soy sauce), the acid proteases of *Aspergillus oryzae* are used. Other products involve the use of the fungus *Rhizopus oligosporus*. Acid proteases also play a role in the ripening process of a variety of soft cheeses. This includes the *Penicillia* used in the blue cheeses, such as Roquefort, Stilton, and Danish blue, and in Camembert and Brie. The molds producing the acid proteases

may grow either on the surface of the cheese or throughout the body of the cheese.

Serine Proteases

This group includes the chymotrypsins, trypsin, elastase, thrombin, and subtilisin. The name of this group of enzymes refers to the seryl residue that is involved in the active site. As a consequence, all of these enzymes are inhibited by diisopropylphosphorofluoridate, which reacts with the hydroxyl group of the seryl residue. They also have an imidazole group as part of the active site and they are all endopeptidases. The chymotrypsins, trypsin and elastase, are pancreatic enzymes that carry out their function in the intestinal

tract. They are produced as inactive zymogens and are converted into the active form by limited proteolysis.

Sulphydryl Proteases

These enzymes obtain their name from the fact that a sulphydryl group in the molecule is essential for their activity. Most of these enzymes are of plant origin and have found widespread use in the food industry. The only sulphydryl proteases of animal origin are two of the cathepsins, which are present in the tissues as intracellular enzymes. The most important enzymes of this group are papain, ficin, and bromelain. Papain is an enzyme present in the fruit, leaves, and trunk of the papaya tree (*Carica papaya*). The commercial enzyme is obtained by purification of the exudate of full-grown but unripe papaya fruits. The purification involves use of affinity chromatography on a column containing an inhibitor (Liener 1974). This process leads to the full activation of the enzyme, which then contains 1 mole of sulphydryl per mole of protein. The crude papain is not fully active and contains only 0.5 mole of sulphydryl per mole of protein. Bromelain is obtained from the fruit or stems of the pineapple plant (*Ananas comosus*). The stems are pressed and the enzyme precipitated from the juice by acetone. Ficin is obtained from the latex of tropical fig trees (*Ficus glabrata*). The enzyme is not homogeneous and contains at least three different proteolytic components.

The active sites of these plant enzymes contain a cysteine and a histidine group that are essential for enzyme activity. The pH optimum is fairly broad and ranges from 6 to 7.5. The enzymes are heat stable up to temperatures in the range of 60 to 80°C. The papain molecule consists of a single polypep-

ptide chain of 212 amino acids. The molecular weight is 23,900. Ficin and bromelain contain carbohydrate in the molecule; papain does not. The molecular weights of the enzymes are quite similar; that of ficin is 25,500 and that of bromelain, 20,000 to 33,200. These enzymes catalyze the hydrolysis of many different compounds, including peptide, ester, and amide bonds. The variety of peptide bonds split by papain appears to indicate a low specificity. This has been attributed (Liener 1974) to the fact that papain has an active site consisting of seven subsites that can accommodate a variety of amino acid sequences in the substrate. The specificity in this case is not determined by the nature of the side chain of the amino acid involved in the susceptible bond but rather by the nature of the adjacent amino acids.

Commercial use of the sulphydryl proteases includes stabilizing and chill proofing of beer. Relatively large protein fragments remaining after the malting of barley may cause haze in beer when the product is stored at low temperatures. Controlled proteolysis sufficiently decreases the molecular weight of these compounds so that they will remain in solution. Another important use is in the tenderizing of meat. This can be achieved by injecting an enzyme solution into the carcass or by applying the enzyme to smaller cuts of meat. The former method suffers from the difficulty of uneven proteolysis in different parts of the carcass with the risk of over-tenderizing some parts of the carcass.

Metal-Containing Proteases

These enzymes require a metal for activity and are inhibited by metal-chelating compounds. They are exopeptidases and include carboxypeptidase A (peptidyl-L-amino-acid hydrolase) and B (peptidyl-L-lysine hydro-

lase), which remove amino acids from the end of peptide chains that carry a free α -carboxyl group. The aminopeptidases remove amino acids from the free α -amino end of the peptide chain. The metalloexopeptidases require a divalent metal as a cofactor; the carboxypeptidases contain zinc. These enzymes are quite specific in the action; for example, carboxypeptidase B requires the C-terminal amino acid to be either arginine or lysine; the requirement for carboxypeptidase A is phenylalanine, tryptophan, or isoleucine. These specificities are compared with those of some other proteolytic enzymes in Figure 10–11. The carboxypeptidases are relatively small molecules; molecular weight of carboxypeptidase A is 34,600. The amino peptidases have molecular weights around 300,000. Although many of the aminopeptidases are found in animal tissues, several are present in microorganisms (Riordan 1974).

Protein Hydrolysates

Protein hydrolysates is the name given to a family of protein breakdown products obtained by the action of enzymes. It is also possible to hydrolyze proteins by chemical means, acids, or alkali, but the enzymatic

method is preferred. Many food products such as cheese and soy sauce are obtained by enzymatic hydrolysis. The purpose of the production of protein hydrolysates is to improve nutritional value, cost, taste, antigenicity, solubility, and functionality. The proteins most commonly selected for producing hydrolysates are casein, whey protein, and soy protein (Lahl and Braun 1994). Proteins can be hydrolyzed in steps to yield a series of proteoses, peptones, peptides, and finally amino acids (Table 10–10). These products should not be confused with hydrolyzed vegetable proteins, which are intended as flavoring substances.

The extent of hydrolysis of protein hydrolysates is measured by the ratio of the amount of amino nitrogen to the total amount of nitrogen present in the raw material (AN/TN ratio). Highly hydrolyzed materials have AN/TN ratios of 0.50 to 0.60. To obtain the desired level of hydrolysis in a protein, a combination of proteases is selected. Serine protease prepared from *Bacillus licheniformis* has broad specificity and some preference for terminal hydrophobic amino acids. Peptides containing terminal hydrophobic amino acids cause bitterness. Usually a mixture of different proteases is employed. The hydrolysis reaction is terminated by adjust-

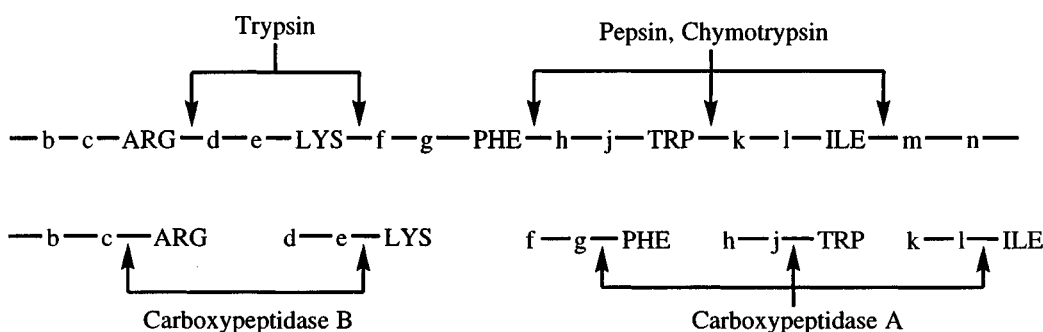

Figure 10–11 Specificity of Some Proteolytic Enzymes

Table 10–10 Protein Hydrolysate Products Produced from Casein and Whey Protein Concentrate (WPC)

<i>Hydrolysate</i> ^a	<i>Protein Source</i>	<i>Average Molecular Weight</i> ^b	<i>AN/TN</i> ^c
Intact protein	Casein	28,500	0.07
	WPC	25,000	0.06
Proteose	Casein	6,000	0.13
	WPC	6,800	0.11
Peptone	Casein	2,000	0.24
	WPC	1,400	0.24
Peptides	Casein	400	0.48
	WPC	375	0.43
Peptides and free amino acids	Casein	260	0.55
	WPC	275	0.58

^a Commercial hydrolysates produced by Deltown Specialties, Fraser, NY.

^b Determined by reverse-phase HPLC.

^c Ratio of amino nitrogen present in the hydrolysate to the total amount of nitrogen present in the substrate.

Source: Reprinted with permission from W.J. Lahl and S.D. Braun, *Enzymatic Production of Protein Hydrolysates for Food Use*, *Food Technology*, Vol. 48, No. 10, p. 69, © 1994, Institute of Food Technologists.

ing the pH and increasing the temperature to inactivate the enzymes. The process for producing hydrolysates is shown in Figure 10–12 (Lahl and Braun 1994). Protein hydrolysates can be used as food ingredients with specific functional properties or for physiological or medical reasons. For example, hydrolyzed proteins may lose allergenic properties by suitably arranged patterns of hydrolysis (Cordle 1994).

OXIDOREDUCTASES

Phenolases

The enzymes involved in enzymic browning are known by the name polyphenoloxidase and are also called polyphenolase or phenolase. It is generally agreed (Mathew

and Parpia 1971) that these terms include all enzymes that have the capacity to oxidize phenolic compounds to *o*-quinones. This can be represented by the conversion of *o*-dihydroxyphenol to *o*-quinone,

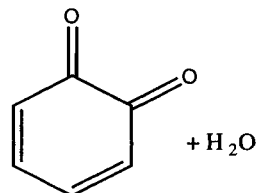
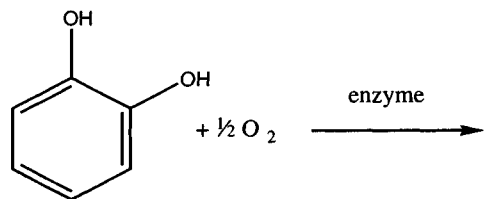

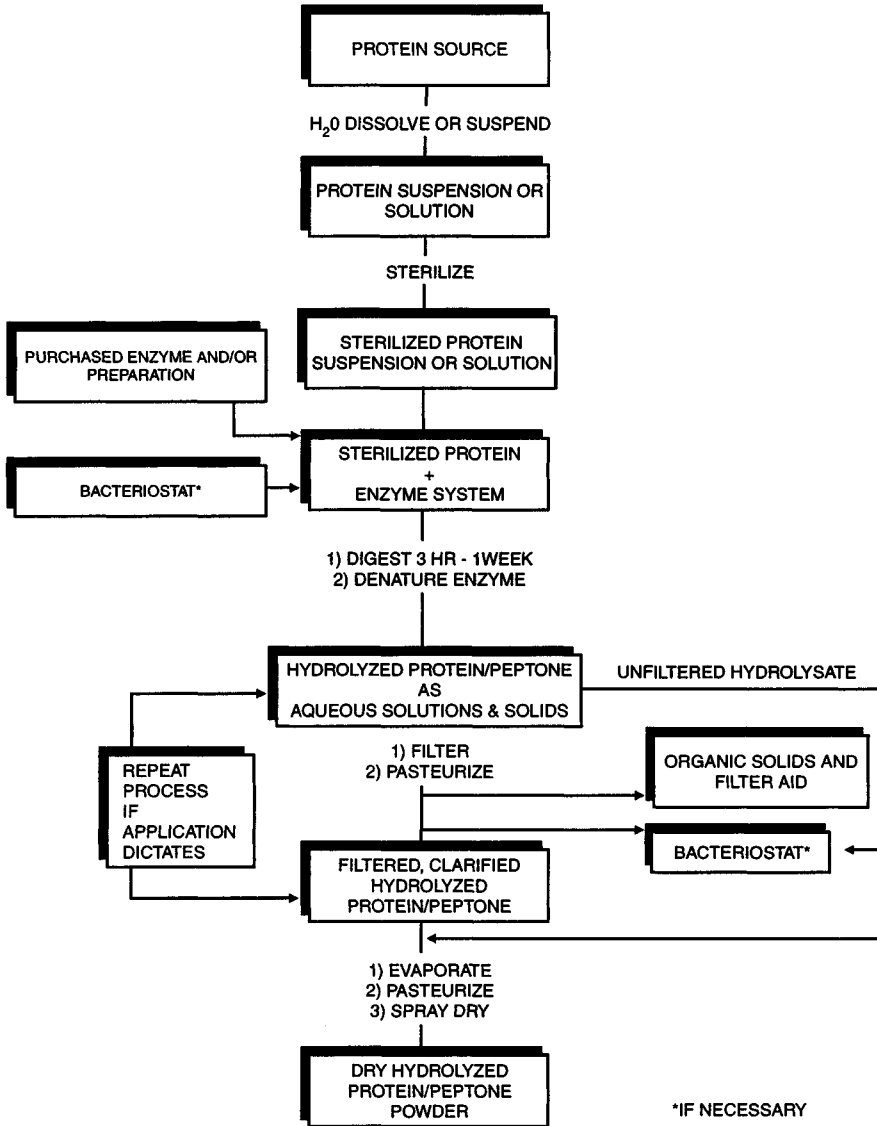
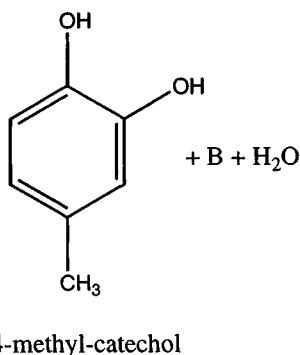
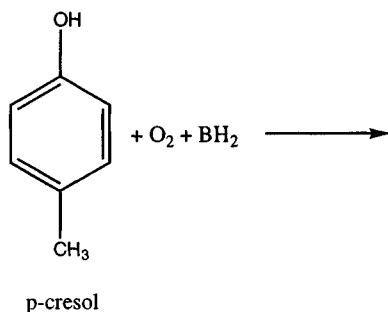

Figure 10-12 Process for the Production of Protein Hydrolysates. *Source:* Reprinted with permission from W.J. Lahl and S.D. Braun, *Enzymatic Production of Protein Hydrolysates for Food Use*, *Food Technology*, Vol. 48, No. 10, p. 70, © 1994, Institute of Food Technologists.

The action of polyphenolases is detrimental when it leads to browning in bruised and broken plant tissue but is beneficial in the processing of tea and coffee. The enzyme occurs in almost all plants, but relatively high levels are found in potatoes, mush-

rooms, apples, peaches, bananas, avocados, tea leaves, and coffee beans.

In addition to changing *o*-diphenols into *o*-quinones, the enzymes also catalyze the conversion of monophenols into *o*-diphenols, as follows:



where BH_2 stands for an *o*-diphenolic compound.

To distinguish this type of activity from the one mentioned earlier, it is described as cresolase activity, whereas the other is referred to as catecholase activity. For both types of activity, the involvement of copper is essential. Copper has been found as a component of all polyphenolases. The activity of cresolase involves three steps, which can be represented by the following overall equation (Mason 1956):

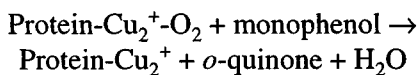

The protein copper-oxygen complex is formed by combining one molecule of oxygen with the protein to which two adjacent cuprous atoms are attached.

Catecholase activity involves oxidizing two molecules of *o*-diphenols to two molecules of *o*-quinones, resulting in the reduction of one molecule of oxygen to two molecules of water. The action sequence as presented in Figure 10-13 has been proposed by Mason (1957). The enzyme-oxygen complex serves as the hydroxylating or dehydroxylating intermediate, and $(\text{Cu})_n$ represents the actual charge designation of the copper at the active site. In preparations high in cresolase activity, $n = 2$, and in preparations high in catecholase activity, $n = 1$. The overall reaction involves the use of one molecule of oxygen, one atom of which goes into the formation of the diphenol, and the other, which is reduced to water. This can be expressed in the following equation given by Mathew and Parpia (1971):

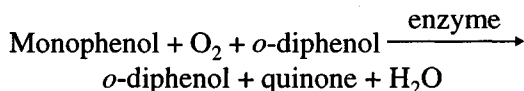

The substrates of the polyphenol oxidase enzymes are phenolic compounds present in plant tissues, mainly flavonoids. These include catechins, anthocyanidins, leucoanthocyanidins, flavonols, and cinnamic acid derivatives. Polyphenol oxidases from different sources show distinct differences in their activity for different substrates. Some specific examples of polyphenolase substrates are chlorogenic acid, caffeic acid, dicatechol, protocatechuic acid, tyrosine, catechol, dihydroxyphenylalanine, pyrogallol, and catechins.

To prevent or minimize enzymic browning of damaged plant tissue, several approaches are possible. The first and obvious one, although rarely practical, involves the exclusion of molecular oxygen. Another approach is the addition of reducing agents that can prevent the accumulation of *o*-quinones.

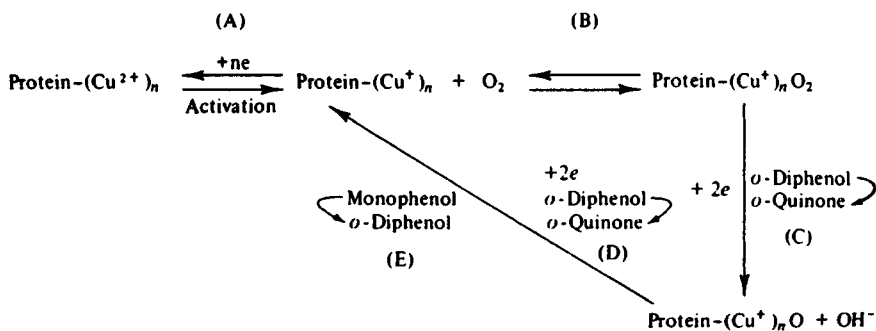

Figure 10-13 Phenolase Catalyzed Reactions. (A) activation of phenolase. (B,C,D) Two-step four-electron reduction of oxycuprophensolase, and the associated hydroxylation of monophenols. *Source:* From H.S. Mason, *Mechanisms of Oxygen Metabolism*, *Adv. Enzymol.*, Vol. 19, pp. 79-233, © 1957.

Heat treatment is effective in deactivating the enzymes. Metal complexing agents may deactivate the enzyme by making the copper unavailable.

One of the most useful methods involves the use of L-ascorbic acid as a reducing agent. This is practiced extensively in the commercial production of fruit juices and purees. The ascorbic acid reacts with the *o*-quinones and changes them back into *o*-diphenols (Figure 10-14).

Glucose Oxidase (β -D-Glucose: Oxygen Oxidoreductase)

This enzyme catalyzes the oxidation of D-glucose to δ -D-gluconolactone and hydrogen peroxide in the presence of molecular oxygen, as follows:

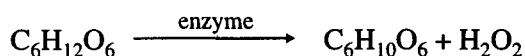

The enzyme is present in many fungi and is highly specific for β -D-glucopyranose. It has been established that the enzyme does

not oxidize glucose by direct combination with molecular oxygen. The mechanism as described by Whitaker (1972) involves the oxidized form of the enzyme, flavin adenine dinucleotide (FAD), which serves as a dehydrogenase. Two hydrogen atoms are removed from the glucose to form the reduced state of the enzyme, FADH₂, and δ -D-gluconolactone. The enzyme is then reoxidized by molecular oxygen. The gluconolactone is hydrolyzed in the presence of water to form D-gluconic acid.

In food processing, glucose oxidase is used to remove residual oxygen in the head space of bottled or canned products or to remove glucose. Light has a deteriorative effect on citrus beverages. Through the catalytic action of light, peroxides are formed that lead to oxidation of other components, resulting in very unpleasant off-flavors. Removing the oxygen by the use of a mixture of glucose oxidase and catalase will prevent these peroxides from forming. The glucose oxidase promotes the formation of gluconic acid with uptake of one molecule of oxygen. The cata-

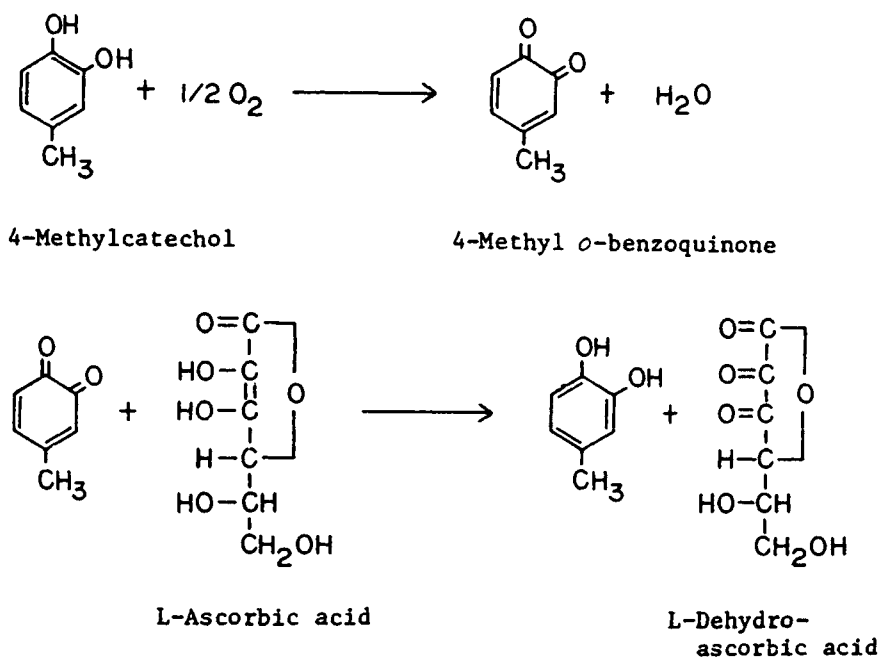
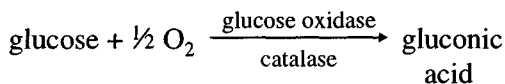

Figure 10-14 Reaction of L-Ascorbic Acid with *o*-Quinone in the Prevention of Enzymic Browning

lase decomposes the hydrogen peroxide formed into water and one half-molecule of oxygen. The net result is the uptake of one half-molecule of oxygen. The overall reaction can be written as follows:



Recent information suggests that this application is not effective because of reversible inhibition of the glucose oxidase by the dyes used in soft drinks below pH 3 (Hammer 1993).

This enzyme mixture can also remove glucose from eggs before drying to prevent Maillard type browning reactions in the dried product.

Catalase (Hydrogen Peroxide: Hydrogen Peroxide Oxidoreductase)

Catalase catalyzes the conversion of two molecules of hydrogen peroxide into water and molecular oxygen as follows:

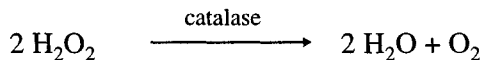

This enzyme occurs in plants, animals, and microorganisms. The molecule has four subunits; each of these contains a protohemin group, which forms part of four independent active sites. The molecular weight is 240,000. Catalase is less stable to heat than is peroxidase. At neutral pH, catalase will rapidly lose activity at 35°C. In addition to catalyzing the reaction shown above (catalytic activity), catalase can also have peroxidatic

activity. This occurs at low concentrations of hydrogen peroxide and in the presence of hydrogen donors (e.g., alcohols).

In plants, catalase appears to have two functions. First is the ability to dispose of the excess H_2O_2 produced in oxidative metabolism, and second is the ability to use H_2O_2 in the oxidation of phenols, alcohols, and other hydrogen donors. The difference in heat stability of catalase and peroxidase was demonstrated by Lopez et al. (1959). They found that blanching of southern peas for one minute in boiling water destroys 70 to 90 percent of the peroxidase activity and 80 to 100 percent of the catalase activity.

The combination of glucose oxidase and catalase is used in a number of food processing applications, including the removal of trace glucose or oxygen from foods and in the production of gluconic acid from glucose. Greenfield and Lawrence (1975) have studied the use of these enzymes in their immobilized form on an inorganic support.

Peroxidase (Donor: Hydrogen Peroxide Oxidoreductase)

The reaction type catalyzed by peroxidase involves hydrogen peroxide as an acceptor, and a compound AH_2 as a donor of hydrogen atoms, as shown:

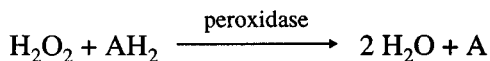

In contrast to the action of catalase, no molecular oxygen is formed.

The peroxidases can be classified into the two groups, iron-containing peroxidases and flavoprotein peroxidases. The former can be further subdivided into ferriprotoporphyrin peroxidases and verdoperoxidases. The first group contains ferriprotoporphyrin III (prothemin) as the prosthetic group (Figure

10–15). The common plant peroxidases (horseradish, fig, and turnip) are in this group and the enzymes are brown when highly purified. The second group includes the peroxidases of animal tissue and milk (lactoperoxidase). In these enzymes, the prosthetic group is an iron porphyrin nucleus but not protohemin. When highly purified, these enzymes are green in color. Flavoprotein peroxidases occur in microorganisms and animal tissues. The prosthetic group is FAD.

The linkage between the iron-containing prosthetic group and the protein can be stabilized by bisulfite (Embs and Markakis 1969). It is suggested that the bisulfite forms a complex with the peroxidase iron, which stabilizes the enzyme.

Because of the widespread occurrence of peroxidase in plant tissues, Nagle and Haard (1975) have suggested that it plays an important role in the development and senescence of plant tissues. It plays a role in biogenesis of ethylene; in regulating ripening and senescence; in the degradation of chlorophyll; and in the oxidation of indole-3-acetic acid.

The enzyme can occur in a variety of multiple molecular forms, named isoenzymes or isozymes. Such isoenzymes have the same enzymatic activity but can be separated by electrophoresis. Nagle and Haard (1975) separated the isoperoxidases of bananas into six anionic and one cationic component by gel electrophoresis. By using other methods of separation, an even greater number of isoenzymes was demonstrated.

Peroxidase has been implicated in the formation of the "grit cells" or "stone cells" of pears (Ranadive and Haard 1972). Bound peroxidase but not total peroxidase activity was higher in the fruit that contained excessive stone cells. The stone cells or sclereids are lignocellulosic in nature. The presence

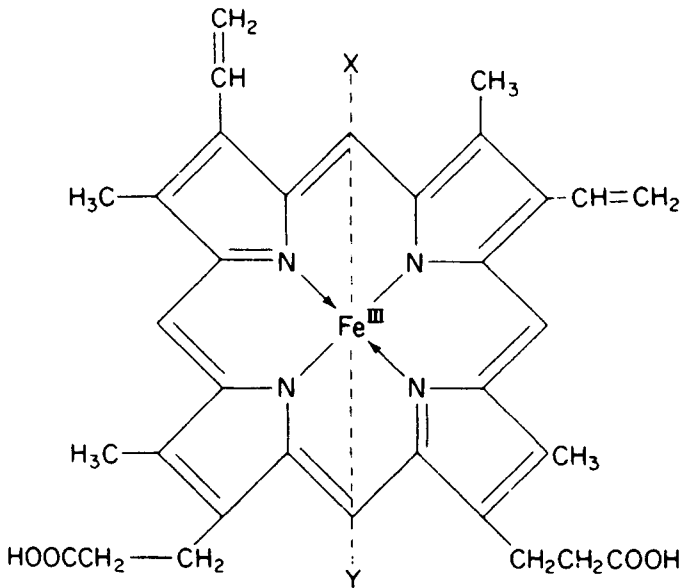

Figure 10-15 Structural Formula of Ferriprotoporphyrin III (Protohemin). *Source:* From J.R. Whitaker, *Food Related Enzymes*, 1974, American Chemical Society.

of calcium ions causes the release of wall bound peroxidase and a consequent decrease in the deposition of lignin.

The peroxidase test is used as an indicator of satisfactory blanching of fruits and vegetables. However, it has been found that the enzymes causing off-flavors during frozen storage can, under some conditions, be regenerated. Regeneration of enzymes is a relatively common phenomenon and is more likely to occur the faster the temperature is raised to a given point in the blanching process. The deactivation and reactivation of peroxidase by heat was studied by Lu and Whitaker (1974). The rate of reactivation was at a maximum at pH 9 and the extent of reactivation was increased by addition of hematin.

The deactivation of peroxidase is a function of heating time and temperature. Lactoperoxidase is completely deactivated by heating at 85°C for 13 seconds. The effect of heating time at 76°C on the deactivation of

lactoperoxidase is represented in Figure 10-16, and the effect of heating temperature on the deactivation constant is shown in Figure 10-17. Lactoperoxidase can be regenerated under conditions of high temperature short time (HTST) pasteurization. Figure 10-18 shows the regeneration of lactoperoxidase activity in milk that is pasteurized for 10 seconds at 85°C. The regeneration effect depends greatly on storage temperature; the lower the storage temperature, the smaller the regeneration effect.

Lactoperoxidase is associated with the serum proteins of milk. It has an optimum pH of 6.8 and a molecular weight of 82,000.

Lipoxygenase (Linoleate: Oxygen Oxidoreductase)

This enzyme, formerly named lipoxidase, is present in plants and catalyzes the oxidation of unsaturated fats. The major source of

lipoxygenase is legumes, soybeans, and other beans and peas. Smaller amounts are present in peanuts, wheat, potatoes, and radishes. Lipoxygenase is a metallo-protein with an iron atom in its active center. In plants two types of lipoxygenase exist: type I lipoxygenase peroxidizes only free fatty acids with a high stereo- and regioselectivity; type II lipoxygenase is less specific for free linoleic acid and acts as a general catalyst for autoxidation. Type I reacts with fats in a food only after free fatty acids have been formed by lipase action; type II acts directly on triacylglycerols.

Lipoxygenase is highly specific and attacks the *cis-cis*-1,4-pentadiene group contained in the fatty acids linoleic, linolenic, and arachidonic, as follows:



The specificity of this enzyme requires that both double bonds are in the *cis* configura-

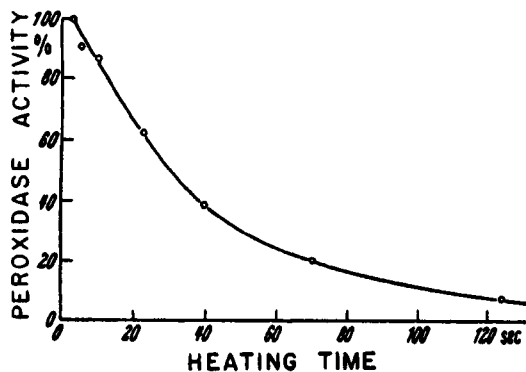

Figure 10-16 Deactivation of Lactoperoxidase as a Function of Heating Time. *Source:* From F. Kiermeier and C. Kayser, Heat Inactivation of Lactoperoxidase (in German), *Z. Lebensm. Untersuch. Forsch.*, Vol. 113, 1960.

tion; in addition, there is a requirement that the central methylene group of the 1,4-pentadiene group occupies the ω -8 position on the fatty acid chain and also that the hydrogen to be removed from the central methylene group be in the L-position. Although the exact mechanism of the reaction is still in some doubt, there is agreement that the essential steps are as represented in Figure 10-19. Initially, a hydrogen atom is abstracted from the ω -8 methylene group to produce a free radical. The free radical isomerizes, causing conjugation of the double bond and isomerization to the *trans* configuration. The free radical then reacts to form the ω -6 hydroperoxide.

Lipoxygenase is reported to have a pH optimum of about 9. However, these values are determined with linoleic acid as substrate, and in natural systems the substrate is usually present in the form of triglycerides. The enzyme has a molecular weight of

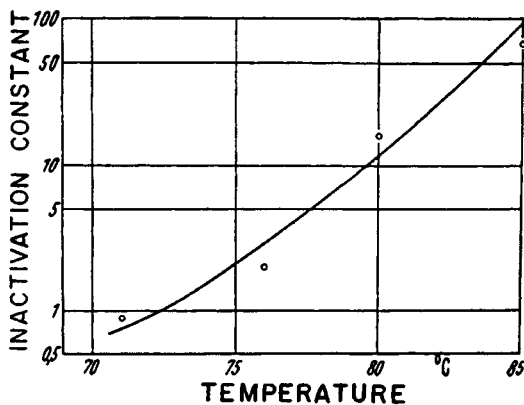

Figure 10-17 Dependence of the Rate Constant of Heat Deactivation of Lactoperoxidase on the Heating Temperature. *Source:* From F. Kiermeier and C. Kayser, Heat Inactivation of Lactoperoxidase (in German), *Z. Lebensm. Untersuch. Forsch.*, Vol. 113, 1960.

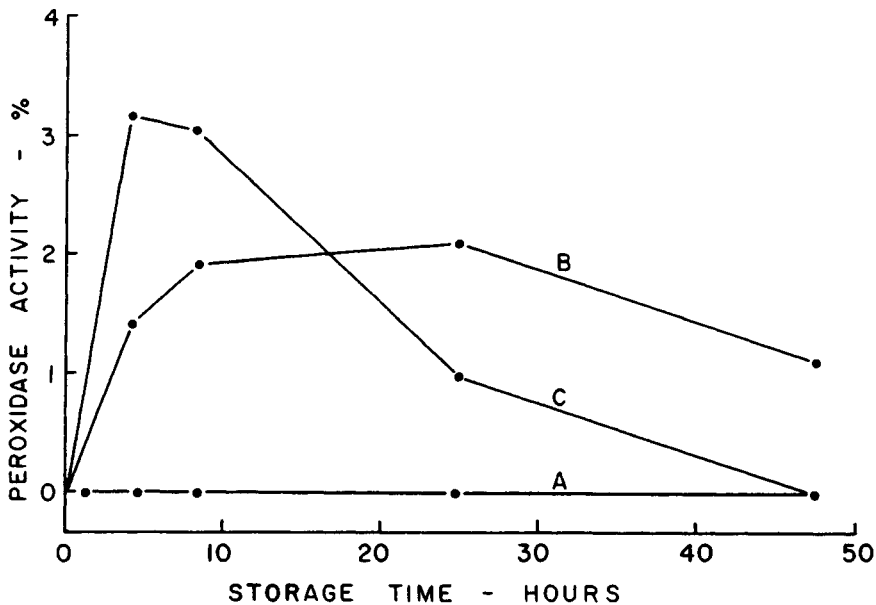

Figure 10-18 Regeneration in Ultra High Temperature Treated Milk as a Function of Storage Temperature. (A) 2°C; (B) 20°C; (C) 37°C. Source: From F. Kiermeier and C. Kayser, Heat Inactivation of Lactoperoxidase (in German), *Z. Lebensm. Untersuch. Forsch.*, Vol. 113, 1960.

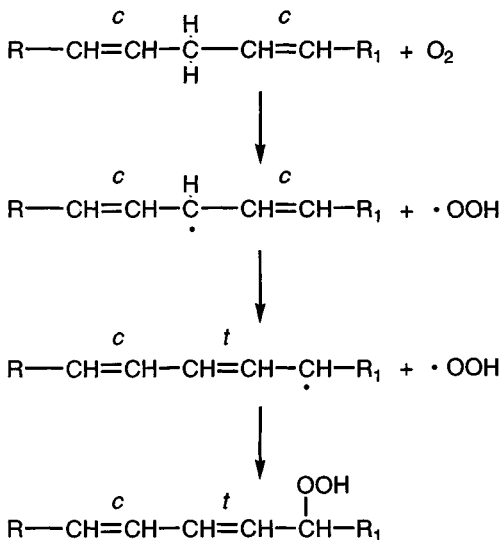

Figure 10-19 Essential Steps in the Mechanism of the Lipoxygenase-Catalyzed Oxidation of the 1,4-Pentadiene Group

102,000 and an isoelectric point of 5.4. The peroxide formation by lipoxygenase is inhibited by the common lipid antioxidants. The antioxidants are thought to react with the free radicals and interrupt the oxidation mechanism.

Most manifestations of lipoxygenase in foods are undesirable. However, it is used in baking to bring about desirable changes. Addition of soybean flour to wheat flour dough results in a bleaching effect, because of oxidation of the xanthophyll pigments. In addition, there is an effect on the rheological and baking properties of the dough. It has been suggested that lipoxygenase acts indirectly in the oxidation of sulfhydryl groups in the gluten proteins to produce disulfide bonds. When raw soybeans are ground with water to produce soy milk, a strong and unpleasant flavor develops that is called

painty, green, or beany. Carrying out the grinding in boiling water instantly deactivates the enzyme, and no off-flavor is formed. Blanching of peas and beans is essential in preventing the lipoxygenase-catalyzed development of off-flavor. In addition to the development of off-flavors, the enzyme may be responsible for destruction of carotene and vitamin A, chlorophyll, bixin, and other pigments.

In some cases the action of lipoxygenase leads to development of a characteristic aroma. Galliard et al. (1976) found that the main aroma compounds of cucumber, 2-*trans* hexenol and 2-*trans*, 6-*cis*-nonadienal, are produced by reaction of linolenic acid and lipoxygenase to form hydroperoxide

(Figure 10–20); these are changed into *cis* unsaturated aldehydes by hydroperoxide lyase. The *cis* unsaturated aldehydes are transformed by isomerase into the corresponding *trans* isomers. These same substances in another matrix would be experienced as off-flavors. The use of lipoxygenase as a versatile biocatalyst has been described by Gardner (1996).

Xanthine Oxidase (Xanthine: Oxygen Oxidoreductase)

This enzyme catalyzes the conversion of xanthine and hypoxanthine to uric acid. The reaction equation is given in Figure 10–21; heavy arrows indicate the reactions catalyzed

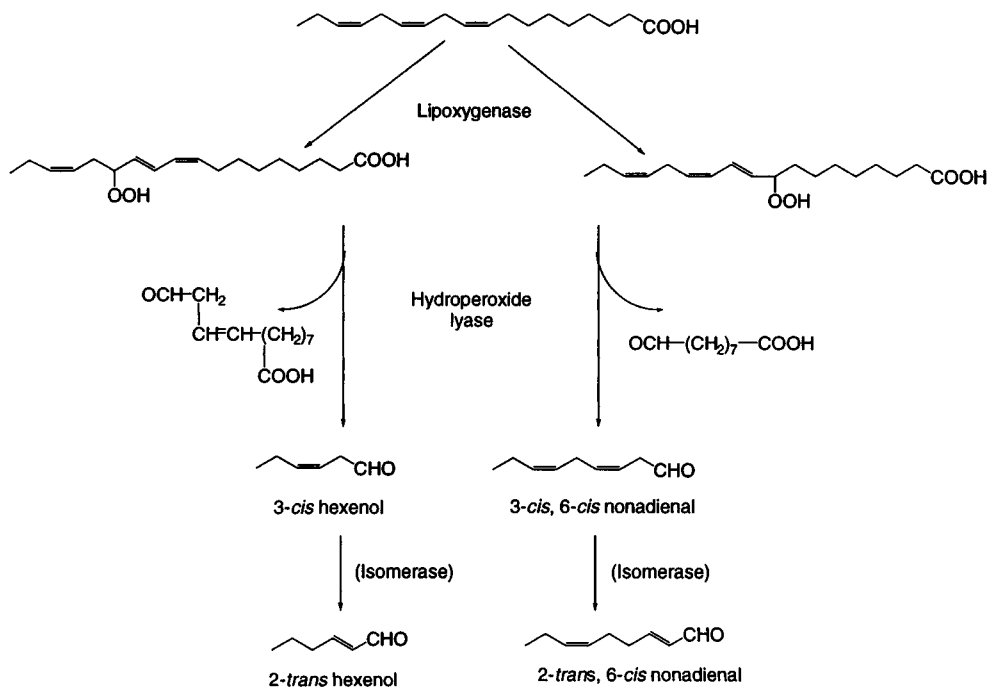

Figure 10–20 Lipoxygenase Catalyzed Formation of Aroma Compounds in Cucumber. *Source:* Reprinted from *Biochim. Biophys. Acta.*, Vol. 441, T. Galliard, D.R. Phillips, and J. Reynolds, The Formation of *cis*-3-nonenal, *trans*-2-nonenal and Hexanol from Linoleic Acid Hydroperoxide Isomers by a Hydroperoxide Cleavage Enzyme System in Cucumber (*Cucumis Sativus*) Fruits, p. 184, Copyright 1976, with permission from Elsevier Science.

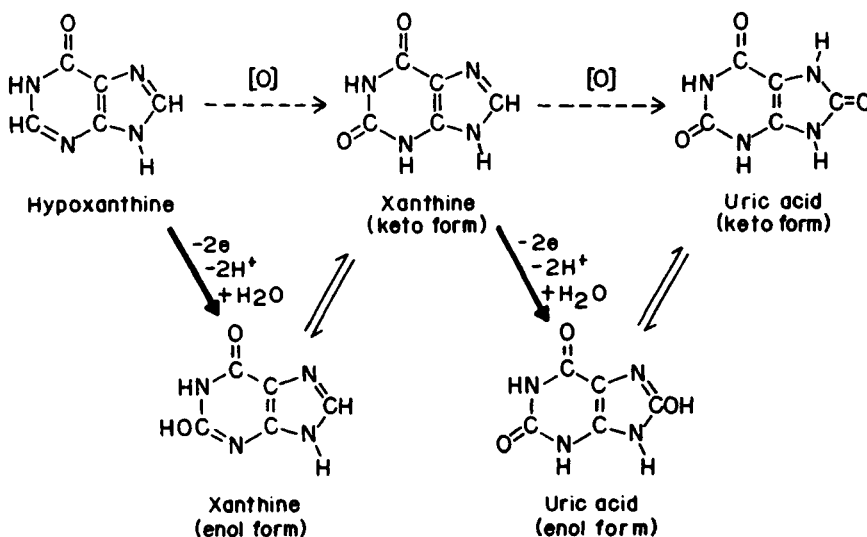

Figure 10-21 Oxidation of Hypoxanthine and Xanthine to Uric Acid by Xanthine Oxidase. *Source:* From J.R. Whitaker, *Principles of Enzymology for the Food Sciences*, 1972, Marcel Dekker, Inc.

by the enzyme and the dashed arrows represent the net result of the catalytic process (Whitaker 1972). Although xanthine oxidase is a nonspecific enzyme and many substances can serve as substrate, the rate of oxidation of xanthine and hypoxanthine is many times greater than that of other substrates.

Xanthine oxidase has been isolated from milk and obtained in the crystalline state. The molecular weight is 275,000. One mole of the protein contains 2 moles of FAD, 2 gram-atoms of molybdenum, 8 gram-atoms of nonheme iron, and 8 labile sulfide groups. The 8 labile sulfide groups are liberated in the form of H_2S upon acidification or boiling at pH 7. The optimum pH for activity is 8.3. The xanthine oxidase in milk is associated with the fat globules and, therefore, follows the fat into the cream when milk is separated. It seems to be located in small particles (microsomes) that are attached to the fat

globules. The microsomes also contain the enzyme alkaline phosphatase. The microsomes can be dislodged from the fat globules by mechanical treatment such as pumping and agitation and by heating and cooling. The enzyme is moderately stable to heat but no less so than peroxidase.

IMMOBILIZED ENZYMES

One of the most important recent developments in the use of enzymes for industrial food processing is the fixing of enzymes on water-insoluble inert supports. The fixed enzymes retain their activity and can be easily added to or removed from the reaction mixture. The use of immobilized enzymes permits continuous processing and greatly increased use of the enzyme. Various possible methods of immobilizing enzymes have been listed by Weetall (1975) and Hultin (1983). A schematic representation of the

available methods is given in Figure 10-22. The immobilizing methods include adsorption on organic polymers, glass, metal oxides, and siliceous materials such as bentonite and silica; entrapment in natural or synthetic polymers, usually polyacrylamide; microencapsulation in polymer membranes; ion exchange; cross-linking; adsorption and

cross-linking combined; copolymerization; and covalent attachment to organic polymers. The chemistry of immobilizing enzymes has been covered in detail by Stanley and Olson (1974).

A summary of immobilization methods has been provided by Adlercreutz (1993) and is presented in Exhibit 10-1. In membrane

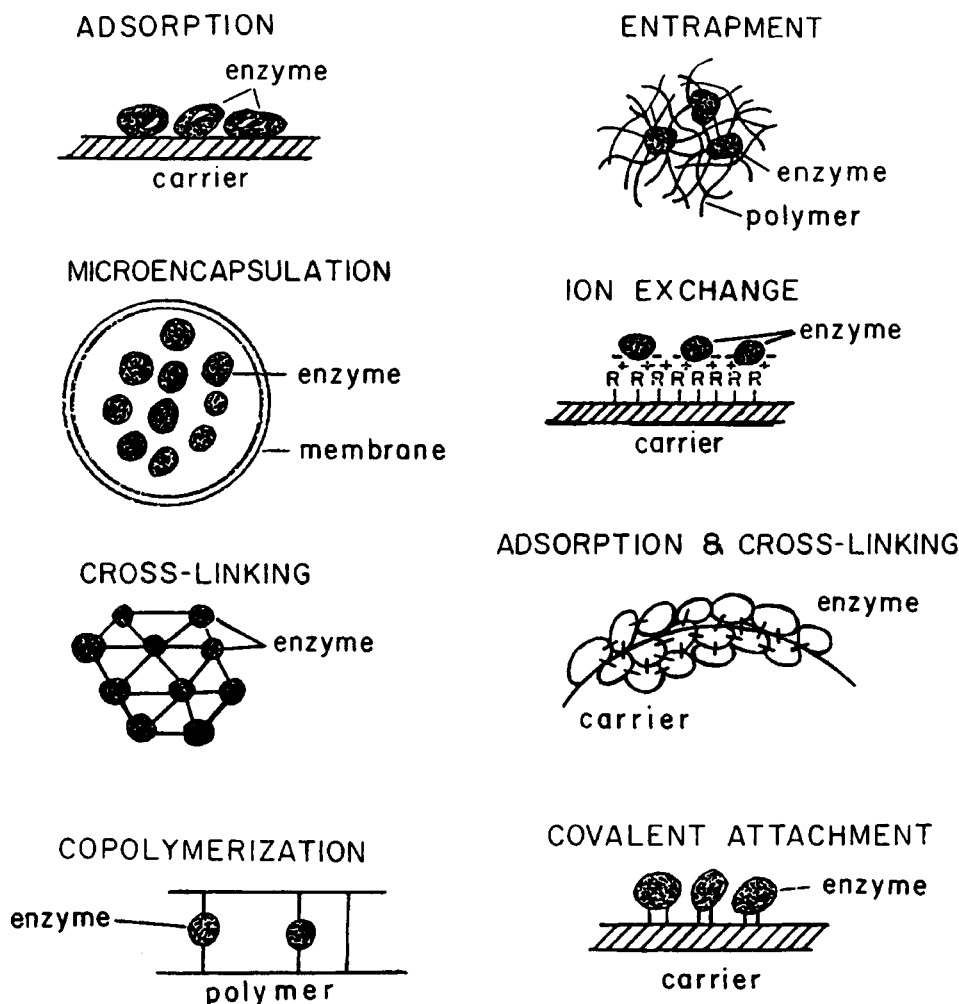

Figure 10-22 Methods of Immobilizing Enzymes. *Source:* From H.H. Weetall, *Immobilized Enzymes and Their Application in the Food and Beverage Industry*, *Process Biochem.*, Vol. 10, pp. 3-6, 1975.

Exhibit 10-1 Summary of Enzyme Immobilization Methods

1. chemical methods
 - covalent binding
 - cross-linking
2. physical methods
 - adsorption
 - physical deposition
 - entrapment
 - in polymer gels
 - in microcapsules
 - membranes
3. two-phase systems
 - organic-aqueous
 - aqueous-aqueous

reactors, the reaction product is separated from the reaction mixture by a semipermeable membrane. In two-phase systems, a hydrophobic reaction product can be separated from the aqueous reaction mixture by transfer to the organic solvent phase. In aqueous-aqueous systems, two incompatible polymers in aqueous solution form a two-phase system.

Immobilizing enzymes is likely to change their stability, and the method of attachment to the carrier also affects the degree of stability. When a high molecular weight substrate is used, the immobilizing should not be done by entrapment, microencapsulation, or copolymerization, because enzyme and substrate cannot easily get in contact. One of the promising methods appears to be covalent coupling of enzymes to inorganic carriers such as porous silica glass particles. Not all of the immobilized enzyme is active, due to either inactivation or steric hindrance. Usually, only about 30 to 50 percent of the bound enzyme is active.

Immobilized enzymes can be used in one of two basic types of reactor systems. The first is the stirred tank reactor where the immobilized enzyme is stirred with the substrate solution. This is a batch system and, after the reaction is complete, the immobilized enzyme is separated from the product. The other system employs continuous flow columns in which the substrate flows through the immobilized enzyme contained in a column or similar device. A simplified flow diagram of such a system is given in Figure 10-23.

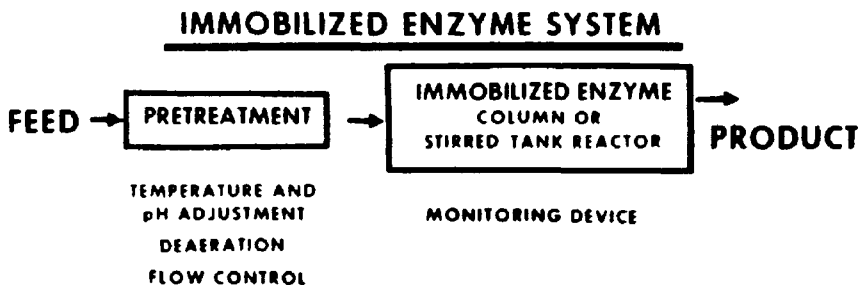

Figure 10-23 Flow Diagram of an Immobilized Enzyme System (Column Operation of Lactase Immobilized on Phenol-Formaldehyde Resin with Glutaraldehyde). *Source:* From W.L. Stanley and A.C. Olson, *The Chemistry of Immobilizing Enzymes*, *J. Food Sci.*, Vol. 39, pp. 660-666, 1974.

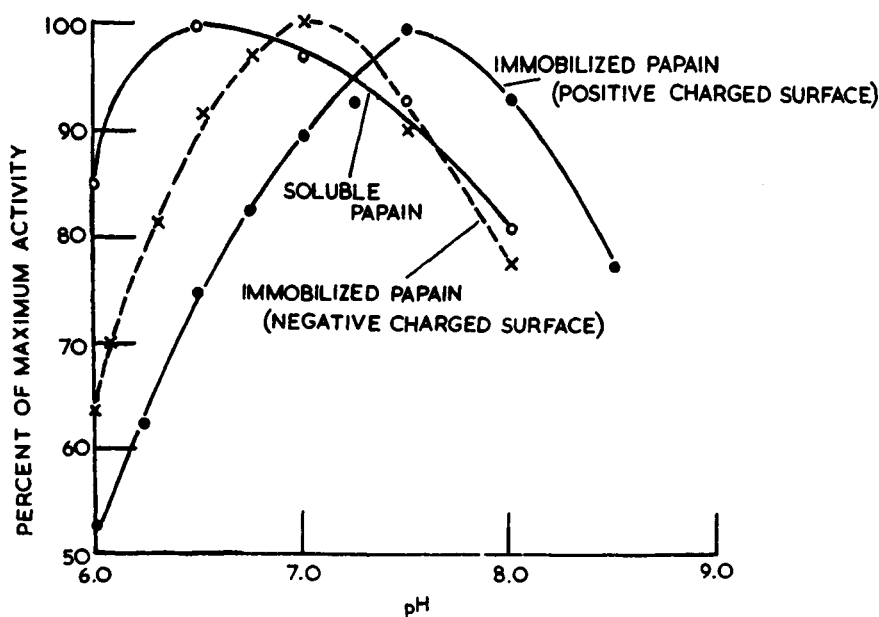

Figure 10-24 Effect of Immobilizing on the pH Optimum of Papain. *Source:* From H.H. Weetall, *Immobilized Enzymes and Their Application in the Food and Beverage Industry*, *Process Biochem.*, Vol. 10, pp. 3-6, 1975.

The characteristics of immobilized enzymes are likely to be somewhat different than those of the original enzyme. The pH optimum can be shifted; this depends on the surface charge of the carrier (Figure 10-24). Another property that can be changed is the Michaelis constant, K_m . This value can become either larger or smaller. Immobilizing may result in increased thermal stability (Figure 10-25), but in some cases the thermal stability is actually decreased.

Many examples of the use of immobilized enzymes in food processing have been reported. One of the most important of these is the use of immobilized glucose isomerase obtained from *Streptomyces* for the production of high-fructose corn syrup (Mermelstein 1975). In this process, the enzyme is bound to an insoluble carrier such as diethyl amino ethyl cellulose or a slurry of the fixed

enzyme coated onto a pressure-leaf filter. The filter then serves as the continuous reactor through which the corn syrup flows. The product obtained by this process is a syrup with 71 percent solids that contains about 42 percent fructose and 50 percent glucose; it has high sweetening power, high fermentability, high humectancy, reduced tendency to crystallize, low viscosity, and good flavor.

Examples of the use of immobilized enzymes in food processing and analysis have been listed by Olson and Richardson (1974) and Hultin (1983). L-aspartic acid and L-malic acid are produced by using enzymes contained in whole microorganisms that are immobilized in a polyacrylamide gel. The enzyme aspartase from *Escherichia coli* is used for the production of aspartic acid. Fumarase from *Brevibacterium ammoniagenes* is used for L-malic acid production.

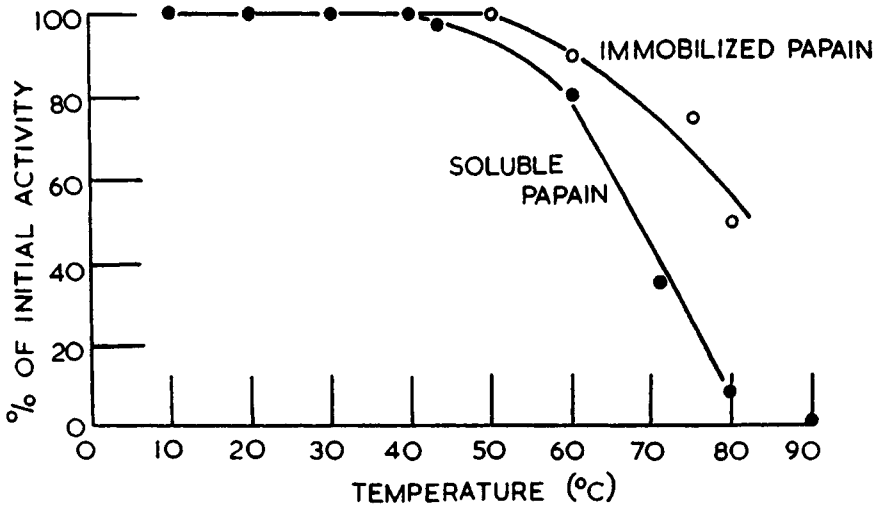

Figure 10-25 Effect of Immobilizing of the Thermal Stability of Papain. *Source:* From H.H. Weetall, *Immobilized Enzymes and Their Application in the Food and Beverage Industry, Process Biochem.*, Vol. 10, pp. 3-6, 1975.

The most widely used immobilized enzyme process involves the use of the enzyme glucose isomerase for the conversion of glucose to fructose in corn syrup (Carasik and Carroll 1983). The organism *Bacillus coagulans* has been selected for the production of glucose isomerase. The development of the immobilized cell slurry has not proceeded to the point where half-lives of the enzyme are more than 75 days. A half-life is defined as the time taken for a 50 percent decrease in activity. Such immobilized enzyme columns can be operated for periods of over three half-lives.

The second important application of immobilized enzymes is the hydrolysis of lactose to glucose and galactose in milk and milk products by lactase (Sprössler and Plainer 1983). Several lactase sources are available; from yeast, *Saccharomyces lactis* and *S. fragilis*, or from fungi, *Aspergillus oryzae* or *A. niger*. The enzymes vary in their optimum pH and optimum temperature, as well as other conditions.

It is to be expected that the use of immobilized enzymes in food processing will continue to grow rapidly in the near future.

REFERENCES

- Adlercreutz, P. 1993. Immobilized enzymes. In *Enzymes in food processing*, ed. T. Nagodaurithana and G. Reed. San Diego, CA: Academic Press, Inc.
- Albersheim, P., and U. Kilias. 1962. Studies relating to the purification and properties of pectin transeliminase. *Arch. Biochem. Biophys.* 97: 107-115.
- Arnold, R.G., et al. 1975. Application of lipolytic enzymes to flavor development in dairy products. *J. Dairy Sci.* 58: 1127-1143.
- Carasik, W., and J.O. Carroll. 1983. Development of immobilized enzymes for production of high-fructose corn syrup. *Food Technol.* 37, no. 10: 85-91.

- Cordle, C.T. 1994. Control of food allergies using protein hydrolysates. *Food Technol.* 48, no. 10: 72–76.
- Embs, R.J., and P. Markakis. 1969. Bisulfite effect on the chemistry and activity of horseradish peroxidase. *J. Food Sci.* 34: 500–501.
- Frost, G.M. 1986. Commercial production of enzymes. In *Developments in food proteins*, Vol. 4, ed. B.J.F. Hudson. New York: Elsevier Applied Science Publishers.
- Galliard, T., et al. 1976. The formation of *cis*-3-nonenal, *trans*-2-nonenal and hexanal from linoleic acid hydroperoxide isomers by a hydroperoxide cleavage enzyme system in cucumber (*Cucumis sativus*) fruits. *Biochim. Biophys. Acta* 441: 181–192.
- Gardner, H.W. 1996. Lipoxygenase as a versatile biocatalyst. *J. Am. Oil Chem. Soc.* 73: 1347–1357.
- Godtfredsen, S.E. 1993. Lipases. In *Enzymes in food processing*, ed. T. Nagodawithana and G. Reed. San Diego, CA: Academic Press, Inc.
- Greenfield, P.F., and R.L. Lawrence. 1975. Characterization of glucose oxidase and catalase on inorganic supports. *J. Food Sci.* 40: 906–910.
- Habibi-Najafi, M.B., and B.H. Lee. 1996. Bitterness in cheese: A review. *Crit. Rev. Food Sci. Nutr.* 36: 397–411.
- Hammer, F.E. 1993. Oxidoreductases. In *Enzymes in food processing*, ed. T. Nagodawithana and G. Reed. San Diego, CA: Academic Press, Inc.
- Hultin, H.O. 1983. Current and potential uses of immobilized enzymes. *Food Technol.* 37, no. 10: 66–82, 176.
- Lahl, W.J., and S.D. Braun. 1994. Enzymatic production of protein hydrolysates for food use. *Food Technol.* 48, no. 10: 68–71.
- Liener, I.E. 1974. The sulfhydryl proteases. In *Food related enzymes*, ed. J.R. Whitaker. Advances in Chemistry Series 136. Washington, DC: American Chemical Society.
- Lopez, A., et al. 1959. Catalase and peroxidase activity in raw and blanched southern peas, *Vigna senensis*. *Food Res.* 24: 548–551.
- Lu, A.T., and J.R. Whitaker. 1974. Some factors affecting rates of heat inactivation and reactivation of horseradish peroxidase. *J. Food Sci.* 39: 1173–1178.
- MacMillan, J.D., and M.I. Sheiman. 1974. Pectic enzymes. In *Food related enzymes*, ed. J.R. Whitaker. Advances in Chemistry Series 136. Washington, DC: American Chemical Society.
- Macrae, A.R. 1983. Lipase catalyzed interesterification of oils and fats. *J. Am. Oil Chem. Soc.* 60: 291–294.
- Marshall, J.J. 1975. Starch degrading enzymes, old and new. *Starke* 27: 377–383.
- Mason, H.S. 1956. Structures and functions of the phenolase complex. *Nature* 177: 79–81.
- Mason, H.S. 1957. Mechanisms of oxygen metabolism. *Adv. Enzymol.* 19: 79–233.
- Mathew, A.G., and H.A.B. Parpia. 1971. Food browning as a polyphenol reaction. *Adv. Food Res.*, 19: 75–145.
- Mermelstein, N.H. 1975. Immobilized enzymes produce high-fructose corn syrup. *Food Technol.* 29, no. 6: 20–26.
- Nagle, N.E., and N.F. Haard. 1975. Fractionation and characterization of peroxidase from ripe banana fruit. *J. Food Sci.* 40: 576–579.
- Nelson, J.H. 1972. Enzymatically produced flavors for fatty systems. *J. Am. Oil Chem. Soc.* 49: 559–562.
- Olson, N.F., and T. Richardson. 1974. Immobilized enzymes in food processing and analysis. *J. Food Sci.* 39: 653–659.
- Parkin, K.L. 1993. General characteristics of enzymes. In *Enzymes in food processing*, ed. T. Nagodawithana and G. Reed. San Diego, CA: Academic Press, Inc.
- Ranadive, A.S., and N.F. Haard. 1972. Peroxidase localization and lignin formation in developing pear fruit. *J. Food Sci.* 37: 381–383.
- Riordan, J.F. 1974. Metal-containing exopeptidases. In *Food related enzymes*, ed. J.R. Whitaker. Advances in Chemistry Series 136. Washington, DC: American Chemical Society.
- Sprössler, B., and H. Plainer. 1983. Immobilized lactase for processing whey. *Food Technol.* 37, no. 10: 93–95.
- Stanley, W.L., and A.C. Olson. 1974. The chemistry of immobilizing enzymes. *J. Food Sci.* 39: 660–666.
- Villeneuve, P., and T.A. Foglia. 1997. Lipase specificities: Potential application in lipid bioconversions. *J. Am. Oil Chem. Soc.* 8: 640–650.
- Weetall, H.H. 1975. Immobilized enzymes and their application in the food and beverage industry. *Process Biochem.* 10: 3–6.
- Whitaker, J.R. 1972. *Principles of enzymology for the food sciences*. New York: Marcel Dekker.
- Whitaker, J.R. 1974. *Food related enzymes*. Advances in Chemistry Series 136. Washington, DC: American Chemical Society.

Additives and Contaminants

INTRODUCTION

The possibility of harmful or toxic substances becoming part of the food supply concerns the public, the food industry, and regulatory agencies. Toxic chemicals may be introduced into foods unintentionally through direct contamination, through environmental pollution, and as a result of processing. Many naturally occurring food compounds may be toxic. A summary of the various toxic chemicals in foods (Exhibit 11-1) was presented in a scientific status summary of the Institute of Food Technologists (1975). Many toxic substances present below certain levels pose no hazard to health. Some substances are toxic and at the same time essential for good health (such as vitamin A and selenium). An understanding of the properties of additives and contaminants and how these materials are regulated by governmental agencies is important to the food scientist. Regulatory controls are dealt with in Chapter 12.

Food additives can be divided into two major groups, intentional additives and incidental additives. Intentional additives are chemical substances that are added to food for specific purposes. Although we have little control over unintentional or incidental additives, intentional additives are regulated

by strict governmental controls. The U.S. law governing additives in foods is the Food Additives Amendment to the Federal Food, Drug and Cosmetic Act of 1958. According to this act, a food additive is defined as follows:

The term food additive means any substance the intended use of which results, or may reasonably be expected to result, directly or indirectly in its becoming a component or otherwise affecting the characteristics of any food (including any substance intended for use in producing, manufacturing, packing, processing, preparing, treating, packaging, transporting, or holding food; and including any source of radiation intended for any such use), if such a substance is not generally recognized, among experts qualified by scientific training and experience to evaluate its safety, as having been adequately shown through scientific procedures (or, in the case of a substance used in food prior to January 1, 1958, through either scientific procedures or experience based on common use in food) to be safe under the condition of its intended use; except that such a term does not include pesticides, color

Exhibit 11-1 Toxic Chemicals in Foods**NATURAL**

- normal components of natural food products
- natural contaminants of natural food products
 - microbiological origin: toxins
 - nonmicrobiological origin: toxicants (e.g., Hg, Se) consumed in feeds by animals used as food sources

MAN-MADE

- agricultural chemicals (e.g., pesticides, fertilizers)

- food additives
- chemicals derived from food packaging materials
- chemicals produced in processing of foods (e.g., by heat, ionizing radiation, smoking)
- inadvertent or accidental contaminants
 - food preparation accidents or mistakes
 - contamination from food utensils
 - environmental pollution
 - contamination during storage or transport

additives and substances for which prior sanction or approval was granted.

The law of 1958 thus recognizes the following three classes of intentional additives:

1. additives generally recognized as safe (GRAS)
2. additives with prior approval
3. food additives

Coloring materials and pesticides on raw agricultural products are covered by other laws. The GRAS list contains several hundred compounds, and the concept of such a list has been the subject of controversy (Hall 1975).

Before the enactment of the 1958 law, U.S. laws regarding food additives required that a food additive be nondeceptive and that an added substance be either safe and therefore permitted, or poisonous and deleterious and

therefore prohibited. This type of legislation suffered from two main shortcomings: (1) it equated poisonous with harmful, and (2) the onus was on the government to demonstrate that any chemical used by the food industry was poisonous. The 1958 act distinguishes between toxicity and hazard. *Toxicity* is the capacity of a substance to produce injury. *Hazard* is the probability that injury will result from the intended use of the substance. It is now well recognized that many components of our foods, whether natural or added, are toxic at certain levels but harmless or even nutritionally essential at lower levels. The ratio between effective dose and toxic dose of many compounds, including such common nutrients as amino acids and salts, is of the order of 1 to 100. It is now mandatory that any user of an additive must petition the government for permission to use the material and must supply evidence that the compound is safe.

An important aspect of the act is the so-called Delaney clause, which specifies that no additive shall be deemed safe if it is found to induce cancer in man or animal. Such special consideration in the case of cancer-producing compounds is not incorporated in the food laws of many other countries.

INTENTIONAL ADDITIVES

Chemicals that are intentionally introduced into foods to aid in processing, to act as preservatives, or to improve the quality of the food are called intentional additives. Their use is strictly regulated by national and international laws. The National Academy of Sciences (1973) has listed the purposes of food additives as follows:

- to improve or maintain nutritional value
- to enhance quality
- to reduce wastage
- to enhance consumer acceptability
- to improve keeping quality
- to make the food more readily available
- to facilitate preparation of the food

The use of food additives is in effect a food processing method, because both have the same objective—to preserve the food and/or make it more attractive. In many food processing techniques, the use of additives is an integral part of the method, as is smoking, heating, and fermenting. The National Academy of Sciences (1973) has listed the following situations in which additives should *not* be used:

- to disguise faulty or inferior processes
- to conceal damage, spoilage, or other inferiority
- to deceive the consumer

- if use entails substantial reduction in important nutrients
- if the desired effect can be obtained by economical, good manufacturing practices
- in amounts greater than the minimum necessary to achieve the desired effects

There are several ways of classifying intentional food additives. One such method lists the following three main types of additives:

1. complex substances such as proteins or starches that are extracted from other foods (for example, the use of caseinate in sausages and prepared meats)
2. naturally occurring, well-defined chemical compounds such as salt, phosphates, acetic acid, and ascorbic acid
3. substances produced by synthesis, which may or may not occur in nature, such as coal tar dyes, synthetic β -carotene, antioxidants, preservatives, and emulsifiers

Some of the more important groups of intentional food additives are described in the following sections.

Preservatives

Preservatives or antimicrobial agents play an important role in today's supply of safe and stable foods. Increasing demand for convenience foods and reasonably long shelf life of processed foods make the use of chemical food preservatives imperative. Some of the commonly used preservatives—such as sulfites, nitrate, and salt—have been used for centuries in processed meats and wine. The choice of an antimicrobial agent has to be based on a knowledge of the antimicrobial

spectrum of the preservative, the chemical and physical properties of both food and preservative, the conditions of storage and handling, and the assurance of a high initial quality of the food to be preserved (Davidson and Juneja 1990).

Benzoic Acid

Benzoic acid occurs naturally in many types of berries, plums, prunes, and some spices. As an additive, it is used as benzoic acid or as benzoate. The latter is used more often because benzoic acid is sparsely soluble in water (0.27 percent at 18°C) and sodium benzoate is more soluble (66.0 g/100 mL at 20°C). The undissociated form of benzoic acid is the most effective antimicrobial agent. With a pK_a of 4.2, the optimum pH range is from 2.5 to 4.0. This makes it an effective antimicrobial agent in high-acid foods, fruit drinks, cider, carbonated beverages, and pickles. It is also used in margarines, salad dressings, soy sauce, and jams.

Parabens

Parabens are alkyl esters of *p*-hydroxybenzoic acid. The alkyl groups may be one of the following: methyl, ethyl, propyl, butyl, or heptyl. Parabens are colorless, tasteless, and odorless (except the methyl paraben). They are nonvolatile and nonhygroscopic. Their solubility in water depends on the nature of the alkyl group; the longer the alkyl chain length, the lower the solubility. They differ from benzoic acid in that they have antimicrobial activity in both acid and alkaline pH regions.

The antimicrobial activity of parabens is proportional to the chain length of the alkyl group. Parabens are more active against molds and yeasts than against bacteria, and

more active against gram-positive than gram-negative bacteria. They are used in fruit-cakes, pastries, and fruit fillings. Methyl and propyl parabens can be used in soft drinks. Combinations of several parabens are often used in applications such as fish products, flavor extracts, and salad dressings.

Sorbic Acid

Sorbic acid is a straight-chain, *trans-trans* unsaturated fatty acid, 2,4-hexadienoic acid. As an acid, it has low solubility (0.15 g/100 mL) in water at room temperature. The salts, sodium, or potassium are more soluble in water. Sorbates are stable in the dry form; they are unstable in aqueous solutions because they decompose through oxidation. The rate of oxidation is increased at low pH, by increased temperature, and by light exposure.

Sorbic acid and sorbates are effective against yeasts and molds. Sorbates inhibit yeast growth in a variety of foods including wine, fruit juice, dried fruit, cottage cheese, meat, and fish products. Sorbates are most effective in products of low pH including salad dressings, tomato products, carbonated beverages, and a variety of other foods.

The effective level of sorbates in foods is in the range of 0.5 to 0.30 percent. Some of the common applications are shown in Table 11-1. Sorbates are generally used in sweetened wines or wines that contain residual sugars to prevent refermentation. At the levels generally used, sorbates do not affect food flavor. However, when used at higher levels, they may be detected by some people as an unpleasant flavor. Sorbate can be degraded by certain microorganisms to produce off-flavors. Molds can metabolize sorbate to produce 1,3 pentadiene, a volatile compound with an odor like kerosene. High levels of microorganisms can result in the

Table 11-1 Applications of Sorbates as Antimicrobial Agents

Products	Levels (%)
<i>Dairy products:</i> aged cheeses, processed cheeses, cottage cheese, cheese spreads, cheese dips, sour cream, yogurt	0.05-0.30
<i>Bakery products:</i> cakes, cake mixes, pies, fillings, mixes, icings, fudges, toppings, doughnuts	0.03-0.30
<i>Vegetable products:</i> fermented vegetables, pickles, olives, relishes, fresh salads	0.02-0.20
<i>Fruit products:</i> dried fruit, jams, jellies, juices, fruit salads, syrups, purees, concentrates	0.02-0.25
<i>Beverages:</i> still wines, carbonated and noncarbonated beverages, fruit drinks, low-calorie drinks	0.02-0.10
<i>Food emulsions:</i> mayonnaise, margarine, salad dressings	0.05-0.10
<i>Meat and fish products:</i> smoked and salted fish, dry sausages	0.05-0.30
<i>Miscellaneous:</i> dry sausage casings, semimoist pet foods, confectionery	0.05-0.30

Source: Reprinted with permission from J.N. Sofos and F.F. Busta, Sorbic Acid and Sorbates, in *Antimicrobials in Foods*, P.M. Davidson and A.L. Branen, eds., p. 62, 1993, by courtesy of Marcel Dekker, Inc.

degradation of sorbate in wine and result in the off-flavor known as geranium off-odor (Edinger and Splittstoesser 1986). The compounds responsible for the flavor defect are ethyl sorbate, 4-hexenoic acid, 1-ethoxyhexa-2,4-diene, and 2-ethoxyhexa-3,5-diene. The same problem may occur in fermented vegetables treated with sorbate.

Sulfites

Sulfur dioxide and sulfites have long been used as preservatives, serving both as antimicrobial substance and as antioxidant. Their use as preservatives in wine dates back to Roman times. Sulfur dioxide is a gas that can be used in compressed form in cylinders. It is liquid under pressure of 3.4 atm and can be injected directly in liquids. It can also be used to prepare solutions in ice cold water. It dissolves to form sulfurous acid. Instead of sulfur dioxide solutions, a number of sulfites can be used (Table 11-2) because, when dissolved in water, they all yield active SO_2 .

The most widely used of these sulfites is potassium metabisulfite. In practice, a value of 50 percent of active SO_2 is used. When sulfur dioxide is dissolved in water, the following ions are formed:

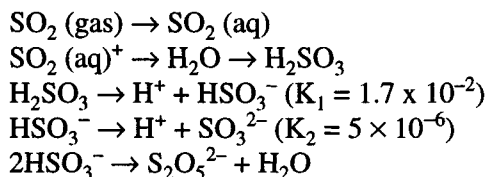

All of these forms of sulfur are known as free sulfur dioxide. The bisulfite ion (HSO_3^-) can react with aldehydes, dextrans, pectic substances, proteins, ketones, and certain sugars to form addition compounds.

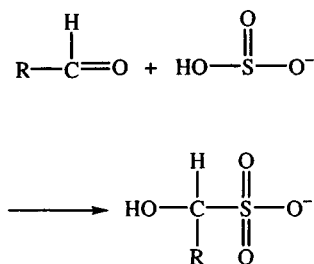

Table 11-2 Sources of SO₂ and Their Content of Active SO₂

<i>Chemical</i>	<i>Formula</i>	<i>Content of Active SO₂</i>
Sulfur dioxide	SO ₂	100.00%
Sodium sulfite, anhydrous	Na ₂ SO ₃	50.82%
Sodium sulfite, heptahydrate	Na ₂ SO ₃ ·7 H ₂ O	25.41%
Sodium hydrogen sulfite	NaHSO ₃	61.56%
Sodium metabisulfite	Na ₂ S ₂ O ₅	67.39%
Potassium metabisulfite	K ₂ S ₂ O ₅	57.63%
Calcium sulfite	CaSO ₃	64.00%

The addition compounds are known as bound sulfur dioxide. Sulfur dioxide is used extensively in wine making, and in wine acetaldehyde reacts preferentially with bisulfite. Excess bisulfite reacts with sugars. It is possible to classify bound SO₂ into three forms: aldehyde sulfurous acid, glucose sulfurous acid, and rest sulfurous acid. The latter holds the SO₂ in a less tightly bound form. Sulfites in wines serve a dual purpose: (1) antiseptic or bacteriostatic and (2) antioxidant. These activities are dependent on the form of SO₂ present. The various forms of SO₂ in wine are represented schematically in Figure 11-1. The free SO₂ includes the water-soluble SO₂ and the undissociated H₂SO₃ and constitutes about 2.8 percent of the total. The bisulfite form constitutes 96.3 percent and the sulfite form 0.9 percent (all at pH 3.3 and 20°C). The bound SO₂ is mostly (80 percent) present as acetaldehyde SO₂, 1 percent as glucose SO₂, and 10 to 20 percent as rest SO₂. The various forms of sulfite have different activities. The two free forms are the only ones with antiseptic activity. The antioxidant activity is limited to the SO₃²⁻ ion (Figure 11-1). The antiseptic activity of SO₂ is highly dependent on the pH, as indicated in Table 11-3. The lower the pH the greater the

antiseptic action of SO₂. The effect of pH on the various forms of sulfur dioxide is shown in Figure 11-2.

Sulfurous acid inhibits molds and bacteria and to a lesser extent yeasts. For this reason, SO₂ can be used to control undesirable bacteria and wild yeast in fermentations without affecting the SO₂-tolerant cultured yeasts. According to Chichester and Tanner (1968), the undissociated acid is 1,000 times more active than HSO₃⁻ for *Escherichia coli*, 100 to 500 times for *Saccharomyces cerevisiae*, and 100 times for *Aspergillus niger*.

The amount of SO₂ added to foods is self-limiting because at levels from 200 to 500 ppm the product may develop an unpleasant off-flavor. The acceptable daily intake (ADI) is set at 1.5 mg/kg body weight. Because large intakes can result from consumption of wine, there have been many studies on reducing the use of SO₂ in wine making. Although some other compounds (such as sorbic acid and ascorbic acid) may partially replace SO₂, there is no satisfactory replacement for SO₂ in wine making.

The use of SO₂ is not permitted in foods that contain significant quantities of thiamine, because this vitamin is destroyed by SO₂. In the United States, the maximum per-

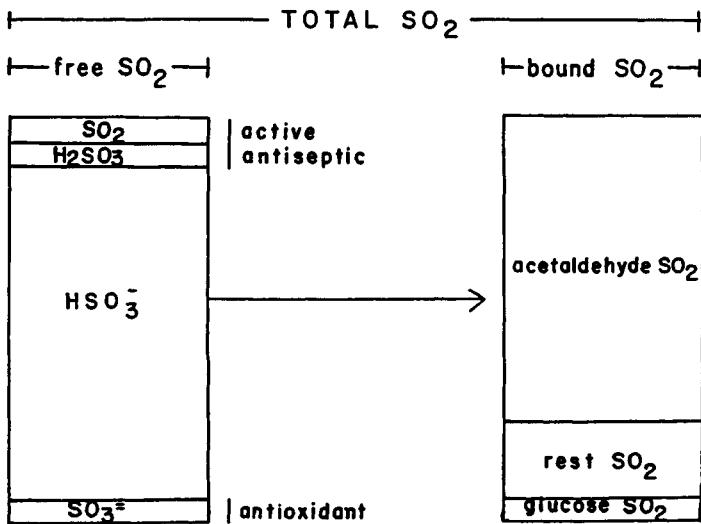

Figure 11-1 The Various Forms of SO₂ in Wine and Their Activity. *Source:* Reprinted with permission from J.M. deMan, 500 Years of Sulfite Use in Winemaking, *Am. Wine Soc. J.*, Vol. 20, pp. 44-46, © 1988, American Wine Society.

mitted level of SO₂ in wine is 350 ppm. Modern practices have resulted in much lower levels of SO₂. In some countries SO₂ is used in meat products; such use is not permitted in North America on the grounds that this would result in consumer deception. SO₂ is also widely used in dried fruits, where levels may be up to 2,000 ppm. Other applications are in dried vegetables and dried potato

products. Because SO₂ is volatile and easily lost to the atmosphere, the residual levels may be much lower than the amounts originally applied.

Nitrates and Nitrites

Curing salts, which produce the characteristic color and flavor of products such as bacon and ham, have been used throughout history. Curing salts have traditionally contained nitrate and nitrite; the discovery that nitrite was the active compound was made in about 1890. Currently, nitrate is not considered to be an essential component in curing mixtures; it is sometimes suggested that nitrate may be transformed into nitrite, thus forming a reservoir for the production of nitrite. Both nitrates and nitrites are thought to have antimicrobial action. Nitrate is used in the production of Gouda cheese to prevent gas formation by butyric acid-forming bacteria. The action of nitrite in meat curing is

Table 11-3 Effect of pH on the Proportion of Active Antiseptic SO₂ of Wine Containing 100 mg/L Free SO₂

pH	Active SO ₂ (mg/L)
2.2	37.0
2.8	8.0
3.0	5.0
3.3	3.0
3.5	1.8
3.7	1.2
4.0	0.8

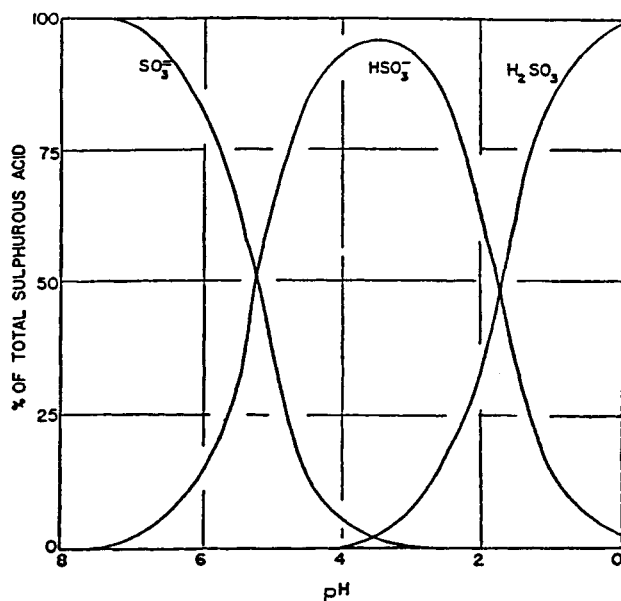
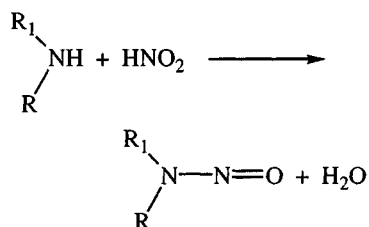

Figure 11-2 Effect of pH on the Ionization of Sulphurous Acid in Water

considered to involve inhibition of toxin formation by *Clostridium botulinum*, an important factor in establishing safety of cured meat products. Major concern about the use of nitrite was generated by the realization that secondary amines in foods may react to form nitrosamines, as follows:



The nitrosamines are powerful carcinogens, and they may be mutagenic and teratogenic as well. It appears that very small amounts of nitrosamines can be formed in certain cured meat products. These levels are in the ppm or the ppb range and, because

analytical procedures are difficult, there is as yet no clear picture of the occurrence of nitrosamines. The nitrosamines may be either volatile or nonvolatile, and only the latter are usually included in analysis of foods. Nitrosamines, especially dimethyl-nitrosamine, have been found in a number of cases when cured meats were surveyed at concentrations of a few $\mu\text{g}/\text{kg}$ (ppb). Nitrosamines are usually present in foods as the result of processing methods that promote their formation (Havery and Fazio 1985). An example is the spray drying of milk. Suitable modifications of these process conditions can drastically reduce the nitrosamine levels. Considerable further research is necessary to establish why nitrosamines are present only in some samples and what the toxicological importance of nitrosamines is at these levels. There appears to be no suitable replacement for nitrite in the production of cured meats such

as ham and bacon. The ADI of nitrite has been set at 60 mg per person per day. It is estimated that the daily intake per person in Canada is about 10 mg.

Cassens (1997) has reported a dramatic decline in the residual nitrite levels in cured meat products in the United States. The current residual nitrite content of cured meat products is about 10 ppm. In 1975 an average residual nitrite content in cured meats was reported as 52.5 ppm. This reduction of nitrite levels by about 80 percent has been attributed to lower ingoing nitrite, increased use of ascorbates, improved process control, and altered formulations.

The nitrate-nitrite intake from natural sources is much higher than that from processed foods. Fassett (1977) estimated that the nitrate intake from 100 g of processed meat might be 50 mg and from 100 g of high-nitrate spinach, 200 mg. Wagner and Tannenbaum (1985) reported that nitrate in cured meats is insignificant compared to nitrite produced endogenously. Nitrate is produced in the body and recirculated to the oral cavity, where it is reduced to nitrite by bacterial action.

Hydrogen Peroxide

Hydrogen peroxide is a strong oxidizing agent and is also useful as a bleaching agent. It is used for the bleaching of crude soya lecithin. The antimicrobial action of hydrogen peroxide is used for the preservation of cheese milk. Hydrogen peroxide decomposes slowly into water and oxygen; this process is accelerated by increased temperature and the presence of catalysts such as catalase, lacto-peroxidase and heavy metals. Its antimicrobial action increases with temperature. When hydrogen peroxide is used for cheese making, the milk is treated with 0.02

percent hydrogen peroxide followed by catalase to remove the hydrogen peroxide. Hydrogen peroxide can be used for sterilizing food processing equipment and for sterilizing packaging material used in aseptic food packaging systems.

Sodium Chloride

Sodium chloride has been used for centuries to prevent spoilage of foods. Fish, meats, and vegetables have been preserved with salt. Today, salt is used mainly in combination with other processing methods. The antimicrobial activity of salt is related to its ability to reduce the water activity (a_w), thereby influencing microbial growth. Salt has the following characteristics: it produces an osmotic effect, it limits oxygen solubility, it changes pH, sodium and chloride ions are toxic, and salt contributes to loss of magnesium ions (Banwart 1979). The use of sodium chloride is self-limiting because of its effect on taste.

Bacteriocins

Nisin is an antibacterial polypeptide produced by some strains of *Lactococcus lactis*. Nisin-like substances are widely produced by lactic acid bacteria. These inhibitory substances are known as bacteriocins. Nisin has been called an antibiotic, but this term is avoided because nisin is not used for therapeutic purposes in humans or animals. Nisin-producing organisms occur naturally in milk. Nisin can be used as a processing aid against gram-positive organisms. Because its effectiveness decreases as the bacterial load increases, it is unlikely to be used to cover up unhygienic practices.

Nisin is a polypeptide with a molecular weight of 3,500, which is present as a dimer

of molecular weight 7,000. It contains some unusual sulfur amino acids, lanthionine and β -methyl lanthionine. It contains no aromatic amino acids and is stable to heat.

The use of nisin as a food preservative has been approved in many countries. It has been used effectively in preservation of processed cheese. It is also used in the heat treatment of nonacid foods and in extending the shelf life of sterilized milk.

A related antibacterial substance is natamycin, identical to pimaricin. Natamycin is effective in controlling the growth of fungi but has no effect on bacteria or viruses. In fermentation industries, natamycin can be used to control mold or yeast growth. It has a low solubility and therefore can be used as a surface treatment on foods. Natamycin is used in the production of many varieties of cheese.

Acids

Acids as food additives serve a dual purpose, as acidulants and as preservatives. Phosphoric acid is used in cola soft drinks to reduce the pH. Acetic acid is used to provide tartness in mayonnaise and salad dressings. A similar function in a variety of other foods is served by organic acids such as citric, tartaric, malic, lactic, succinic, adipic, and fumaric acid. The properties of some of the common food acids are listed in Table 11-4 (Peterson and Johnson 1978). Members of the straight-chain carboxylic acids, propionic and sorbic acids, are used for their antimicrobial properties. Propionic acid is mainly used for its antifungal properties. Propionic acid applied as a 10 percent solution to the surface of cheese and butter retards the growth of molds. The fungistatic effect is higher at pH 4 than at pH 5. A 5 percent solution of calcium propionate acidified with lactic acid

to pH 5.5 is as effective as a 10 percent unacidified solution of propionic acid. The sodium salts of propionic acid also have antimicrobial properties.

Antioxidants

Food antioxidants in the broadest sense are all of the substances that have some effect on preventing or retarding oxidative deterioration in foods. They can be classified into a number of groups (Kochhar and Rossell 1990).

Primary antioxidants terminate free radical chains and function as electron donors. They include the phenolic antioxidants, butylated hydroxyanisole (BHA), butylated hydroxytoluene (BHT), tertiary butyl hydroquinone (TBHQ), alkylgalates, usually propylgallate (PG), and natural and synthetic tocopherols and tocotrienols.

Oxygen scavengers can remove oxygen in a closed system. The most widely used compounds are vitamin C and related substances, ascorbyl palmitate, and erythorbic acid (the D-isomer of ascorbic acid).

Chelating agents or sequestrants remove metallic ions, especially copper and iron, that are powerful prooxidants. Citric acid is widely used for this purpose. Amino acids and ethylene diamine tetraacetic acid (EDTA) are other examples of chelating agents.

Enzymic antioxidants can remove dissolved or head space oxygen, such as glucose oxidase. Superoxide dismutase can be used to remove highly oxidative compounds from food systems.

Natural antioxidants are present in many spices and herbs (Lacroix et al. 1997; Six 1994). Rosemary and sage are the most potent antioxidant spices (Schuler 1990). The active principles in rosemary are carnosic acid and carnosol (Figure 11-3). Anti-

Table 11-4 Properties of Some Common Food Acids

Property	Acetic Acid	Adipic Acid	Citric Acid	Fumaric Acid	Glucono-Delta-Lactone	Lactic Acid	Malic Acid	Phosphoric Acid	Tartaric Acid
Structure	CH ₃ COOH	$\begin{array}{c} \text{COOH} \\ \\ \text{CH}_2 \\ \\ \text{CH}_2 \\ \\ \text{CH}_2 \\ \\ \text{CH}_2 \\ \\ \text{COOH} \end{array}$	$\begin{array}{c} \text{COOH} \\ \\ \text{CH}_2 \\ \\ \text{HO}-\text{C}-\text{COOH} \\ \\ \text{CH}_2 \\ \\ \text{COOH} \end{array}$	$\begin{array}{c} \text{HOOCCH} \\ \\ \text{HCCOOH} \end{array}$	$\begin{array}{c} \text{O}=\text{C} \\ \\ \text{HOCH} \\ \\ \text{HOCH} \quad \text{O} \\ \\ \text{HOCH} \\ \\ \text{HC} \\ \\ \text{CH}_2\text{OH} \end{array}$	$\begin{array}{c} \text{CH}_3 \\ \\ \text{H}-\text{C}-\text{OH} \\ \\ \text{COOH} \end{array}$	$\begin{array}{c} \text{COOH} \\ \\ \text{HO}-\text{C}-\text{H} \\ \\ \text{CH}_2 \\ \\ \text{COOH} \end{array}$	H ₃ PO ₄	$\begin{array}{c} \text{COOH} \\ \\ \text{H}-\text{C}-\text{OH} \\ \\ \text{HO}-\text{C}-\text{H} \\ \\ \text{COOH} \end{array}$
Empirical formula	C ₂ H ₄ O ₂	C ₆ H ₁₀ O ₄	C ₆ H ₈ O ₇	C ₄ H ₄ O ₄	C ₆ H ₁₀ O ₆	C ₃ H ₆ O ₃	C ₄ H ₆ O ₅	H ₃ PO ₄	C ₄ H ₆ O ₆
Physical form	Oily Liquid	Crystalline	Crystalline	Crystalline	Crystalline	85% Water Solution	Crystalline	85% Water Solution	Crystalline
Molecular weight	60.05	146.14	192.12	116.07	178.14	90.08	134.09	82.00	150.09
Equivalent weight	60.05	73.07	64.04	58.04	178.14	90.08	67.05	27.33	75.05
Sol. in water (g/100 mL solv.)	∞	1.4	181.00	0.63	59.0	∞	144.0	∞	147.0
Ionization constants									
K ₁	8 × 10 ⁻⁵	3.7 × 10 ⁻⁵	8.2 × 10 ⁻⁴	1 × 10 ⁻³	2.5 × 10 ⁻⁴ (gluconic acid)	1.37 × 10 ⁻⁴	4 × 10 ⁻⁴	7.52 × 10 ⁻³	1.04 × 10 ⁻³
K ₂		2.4 × 10 ⁻⁶	1.77 × 10 ⁻⁵	3 × 10 ⁻⁵			9 × 10 ⁻⁶	6.23 × 10 ⁻⁸	5.55 × 10 ⁻⁵
K ₃			3.9 × 10 ⁻⁶					3 × 10 ⁻¹³	

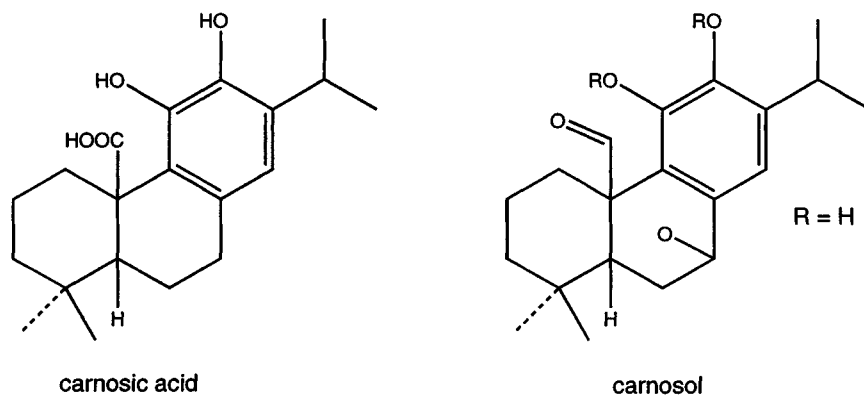

Figure 11-3 Chemical Structure of the Active Antioxidant Principles in Rosemary

oxidants from spices can be obtained as extracts or in powdered form by a process described by Bracco et al. (1981).

The level of phenolic antioxidants permitted for use in foods is limited. U.S. regulations allow maximum levels of 0.02 percent based on the fat content of the food.

Sometimes the antioxidants are incorporated in the packaging materials rather than in the food itself. In this case, a larger number of antioxidants is permitted, provided that no more than 50 ppm of the antioxidants become a component of the food.

Emulsifiers

With the exception of lecithin, all emulsifiers used in foods are synthetic. They are characterized as ionic or nonionic and by their hydrophile/lipophile balance (HLB). All of the synthetic emulsifiers are derivatives of fatty acids.

Lecithin is the commercial name of a mixture of phospholipids obtained as a byproduct of the refining of soybean oil. Phosphatidylcholine is also known as lecithin, but the commercial product of that name contains several phospholipids including phos-

phatidylcholine. Crude soybean lecithin is dark in color and can be bleached with hydrogen peroxide or benzoyl peroxide. Lecithin can be hydroxylated by treatment with hydrogen peroxide and lactic or acetic acid. Hydroxylated lecithin is more hydrophilic, and this makes for a better oil-in-water emulsifier. The phospholipids contained in lecithin are insoluble in acetone.

Monoglycerides are produced by transesterification of glycerol with triglycerides. The reaction proceeds at high temperature, under vacuum and in the presence of an alkaline catalyst. The reaction mixture, after removal of excess glycerol, is known as commercial monoglyceride, a mixture of about 40 percent monoglyceride and di- and triglycerides. The di- and triglycerides have no emulsifying properties. Molecular distillation can increase the monoglyceride content to well over 90 percent. The emulsifying properties, especially HLB, are determined by the chain length and unsaturation of the fatty acid chain.

Hydroxycarboxylic and fatty acid esters are produced by esterifying organic acids to monoglycerides. This increases their hydrophilic properties. Organic acids used are ace-

tic, citric, fumaric, lactic, succinic, or tartaric acid. Succinylated monoglycerides are synthesized from distilled monoglycerides and succinic anhydride. They are used as dough conditioners and crumb softeners (Krog 1981). Acetic acid esters can be produced from mono- and diglycerides by reaction with acetic anhydride or by transesterification. They are used to improve aeration in foods high in fat content and to control fat crystallization. Other esters may be prepared: citric, diacetyl tartaric, and lactic acid. A product containing two molecules of lactic acid per emulsifier molecule, known as stearyl-2-lactylate, is available as the sodium or calcium salt. It is used in bakery products.

Polyglycerol esters of fatty acids are produced by reacting polymerized glycerol with edible fats. The degree of polymerization of the glycerol and the nature of the fat provide a wide range of emulsifiers with different HLB values.

Polyethylene or propylene glycol esters of fatty acids are more hydrophilic than monoglycerides. They can be produced in a range of compositions.

Sorbitan fatty acid esters are produced by polymerization of ethylene oxide to sorbitan fatty acid esters. The resulting polyoxyethylene sorbitan esters are nonionic hydrophilic emulsifiers. They are used in bakery products as antistaling agents. They are known as polysorbates with a number as indication of the type of fatty acid used (e.g., lauric, stearic, or oleic acid).

Sucrose fatty acid esters can be produced by esterification of fatty acids with sucrose, usually in a solvent system. The HLB varies, depending on the number of fatty acids esterified to a sucrose molecule. Monoesters have an HLB value greater than 16, triesters less than 1. When the level of esterification increases to over five molecules of fatty acid,

the emulsifying property is lost. At high levels of esterification the material can be used as a fat replacer because it is not absorbed or digested and therefore yields no calories.

Bread Improvers

To speed up the aging process of wheat flour, bleaching and maturing agents are used. Benzoyl peroxide is a bleaching agent that is frequently used; other compounds—including the oxides of nitrogen, chlorine dioxide, nitrosyl chloride, and chlorine—are both bleaching and improving (or maturing) agents. Improvers used to ensure that dough will ferment uniformly and vigorously include oxidizing agents such as potassium bromate, potassium iodate, and calcium peroxide. In addition to these agents, there may be small amounts of other inorganic compounds in bread improvers, including ammonium chloride, ammonium sulfate, calcium sulfate, and ammonium and calcium phosphates. Most of these bread improvers can only be used in small quantities, because excessive amounts reduce quality. Several compounds used as bread improvers are actually emulsifiers and are covered under that heading.

Flavors

Included in this group is a wide variety of spices, oleoresins, essential oils, and natural extractives. A variety of synthetic flavors contain mostly the same chemicals as those found in the natural flavors, although the natural flavors are usually more complex in composition. For legislative purposes, three categories of flavor compounds have been proposed.

1. *Natural flavors and flavoring substances* are preparations or single substances obtained exclusively by phys-

ical processes from raw materials in their natural state or processed for human consumption.

2. *Nature-identical flavors* are produced by chemical synthesis or from aromatic raw materials; they are chemically identical to natural products used for human consumption.
3. *Artificial flavors* are substances that are not present in natural products.

The first two categories require considerably less regulatory control than the latter one (Vodoz 1977). The use of food flavors covers soft drinks, beverages, baked goods, confectionery products, ice cream, desserts, and so on. The amounts of flavor compounds used in foods are usually small and generally do not exceed 300 ppm. Spices and oleoresins are used extensively in sausages and prepared meats. In recent years, because of public perception, the proportion of natural flavors has greatly increased at the expense of synthetics (Sinki and Schlegel 1990). Numerous flavoring substances are on the generally recognized as safe (GRAS) list. Smith et al. (1996) have described some of the recent developments in the safety evaluation of flavors. They mention a significant recent development in the flavor industry—the production of flavor ingredients using biotechnology—and describe their safety assessment.

Flavor Enhancers

Flavor enhancers are substances that carry the property of umami (see Chapter 7) and comprise glutamates and nucleotides. Glutamic acid is a component amino acid of proteins but also occurs in many protein-containing foods as free glutamic acid. In spite of their low protein content, many vegetables

have high levels of free glutamate, including mushrooms, peas, and tomatoes. Sugita (1990) has listed the level of bound and free glutamate in a variety of foods. Glutamate is an element of the natural ripening process that results in fullness of taste, and it has been suggested as the reason for the popularity of foods such as tomatoes, cheese, and mushrooms (Sugita 1990).

The nucleotides include disodium 5'-inosinate (IMP), adenosine monophosphate (AMP), disodium 5'-guanylate (GMP), and disodium xanthylate (XMP). IMP is found predominantly in meat, poultry, and fish; AMP is found in vegetables, crustaceans, and mollusks; GMP is found in mushrooms, especially shiitake mushrooms.

Monosodium glutamate (MSG) is the sodium salt of glutamic acid. The flavor-enhancing property is not limited to MSG. Similar taste properties are found in the L-forms of α -amino dicarboxylates with four to seven carbon atoms. The intensity of flavor is related to the chemical structure of these compounds. Other amino acids that have similar taste properties are the salts of ibotenic acid, tricholomic acid, and L-theanine.

The chemical structure of the nucleotides is shown in Figure 7-21. They are purine ribonucleotides with a hydroxyl group on carbon 6 of the purine ring and a phosphate ester group on the 5'-carbon of the ribose. Nucleotides with the ester group at the 2' or 3' position are tasteless. When the ester group is removed by the action of phosphomonoesterases, the taste activity is lost. It is important to inactivate such enzymes in foods before adding 5'-nucleotide flavor enhancers.

The taste intensity of MSG and its concentration are directly related. The detection threshold for MSG is 0.012 g/100 mL; for

sodium chloride it is 0.0037 g/100 mL; and for sucrose it is 0.086 g/100 mL. There is a strong synergistic effect between MSG and IMP. The mixture of the two has a taste intensity that is 16 times stronger than the same amount of MSG. MSG contains 12.3 percent sodium; common table salt contains three times as much sodium. By using flavor enhancers in a food, it is possible to reduce the salt level without affecting the palatability or food acceptance. The mode of action of flavor enhancers has been described by Nagodawithana (1994).

Sweeteners

Sweeteners can be divided into two groups, nonnutritive and nutritive sweeteners. The nonnutritive sweeteners include saccharin, cyclamate, aspartame, acesulfame K, and sucralose. There are also others, mainly plant extracts, which are of limited importance. The nutritive sweeteners are sucrose; glucose; fructose; invert sugar; and a variety of polyols including sorbitol, mannitol, maltitol, lactitol, xylitol, and hydrogenated glucose syrups.

The chemical structure of the most important nonnutritive sweeteners is shown in Figure 11-4. Saccharin is available as the sodium or calcium salt of orthobenzosulfimide. The cyclamates are the sodium or calcium salts of cyclohexane sulfamic acid or the acid itself. Cyclamate is 30 to 40 times sweeter than sucrose, and about 300 times sweeter than saccharin. Organoleptic comparison of sweetness indicates that the medium in which the sweetener is tasted may affect the results. There is also a concentration effect. At higher concentrations, the sweetness intensity of the synthetic sweeteners increases at a lower rate than that which occurs with sugars. This has been ascribed to the bitter-

ness and strong aftertaste that appears at these relatively high concentrations.

Cyclamates were first synthesized in 1939 and were approved for use in foods in the United States in 1950. Continued tests on the safety of these compounds resulted in the 1967 finding that cyclamate can be converted by intestinal flora into cyclohexylamine, which is a carcinogen. Apparently, only certain individuals have the ability to convert cyclamate to cyclohexylamine (Collings 1971). In a given population, a portion are nonconverters, some convert only small amounts, and others convert large amounts.

Aspartame is a dipeptide derivative, L-aspartyl-L-phenylalanine methyl ester, which was approved in the United States in 1981 for use as a tabletop sweetener, in dry beverage mixes, and in foods that are not heat processed. This substance is metabolized in the body to phenylalanine, aspartic acid, and methanol. Only people with phenylketonuria cannot break down phenylalanine. Another compound, diketopiperazine, may also be formed. However, no harmful effects from this compound have been demonstrated. The main limiting factor in the use of aspartame is its lack of heat stability (Homler 1984).

A new sweetener, approved in 1988, is acesulfame K. This is the potassium salt of 6-methyl-1,2,3-oxathiazine-4(3H)-one-2, 2-dioxide (Figure 11-4). It is a crystalline powder that is about 200 times sweeter than sugar. The sweetening power depends to a certain degree on the acidity of the food it is used in. Acesulfame K is reportedly more stable than other sweeteners. The sweet taste is clean and does not linger. Sucralose is a trichloroderivative of the C-4 epimer galactosucrose. It is about 600 times sweeter than sucrose and has a similar taste profile. One of its main advantages is heat stability, so it can be used in baking.

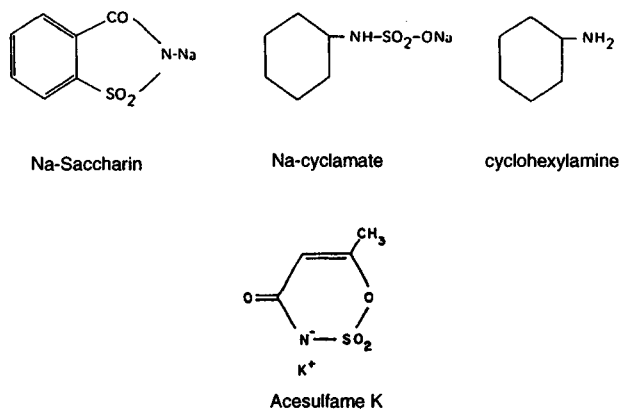

Figure 11-4 Chemical Structure of Sodium Saccharin, Sodium Cyclamate, Cyclohexylamine, and Acesulfame K

Blending of nonnutritive sweeteners may lead to improved taste, longer shelf life, lower production cost, and reduced consumer exposure to any single sweetener (Verdi and Hood 1993). The dihydrochalcone sweeteners are obtained from phenolic glycosides present in citrus peel. Such compounds can be obtained from naringin of grapefruit or from the flavonoid neohesperidin. The compound neohesperidin dihydrochalcone is rated 1,000 times sweeter than sucrose (Inglett 1971). Horowitz and Gentili (1971) investigated the relationship between chemical structure and sweetness, bitterness, and tastelessness. Several other natural compounds having intense sweetness have been described by Inglett (1971); these include glycyrrhizin (from licorice root) and a taste-modifying glycoprotein named miraculin that is obtained from a tropical fruit known as miracle berry. Stevioside is an extract from the leaves of a South American plant that is 300 times sweeter than sugar. Thaumatin, a protein mixture from a West African

fruit, is 2,000 times sweeter than sugar, but its licorice-like aftertaste limits its usefulness.

It has been suggested that sugars from the L series could be used as low-calorie sweeteners. These sugars cannot be metabolized in the normal way, as D sugars would, and therefore pass through the digestive system unaltered. Their effect on the body has not been sufficiently explored.

Possible new sweeteners have been described by Gelardi (1987).

Phosphates

These compounds are widely used as food additives, in the form of phosphoric acid as acidulant, and as monophosphates and polyphosphates in a large number of foods and for a variety of purposes. Phosphates serve as buffering agents in dairy, meat, and fish products; anticaking agents in salts; firming agents in fruits and vegetables; yeast food in bakery products and alcoholic beverages;

and melting salts in cheese processing. Phosphorus oxychloride is used as a starch-modifying agent.

The largest group of phosphates and the most important in the food industry is the orthophosphates (Figure 11-5). The phosphate group has three replaceable hydrogens, giving three possible sodium orthophosphates—monosodium, disodium, and trisodium phosphate. The phosphates can be divided into orthophosphates, polyphosphates, and metaphosphates, the latter having little practical importance. Polyphosphates have two or more phosphorus atoms joined by an oxygen bridge in a chain structure. The first members of this series are the pyrophosphates, which have one P-O-P linkage. The condensed phosphate with two linkages is tripolyphosphate. Alkali metal phosphates with chain lengths greater than three are usu-

ally mixtures of polyphosphates with varied chain lengths. The best known is sodium hexametaphosphate. The longer chain length salts are glasses. Hexametaphosphate is not a real metaphosphate, since these are ring structures and hexametaphosphate is a straight-chain polyphosphate. Sodium hexametaphosphate has an average chain length of 10 to 15 phosphate units.

Phosphates are important because they affect the absorption of calcium and other elements. The absorption of inorganic phosphorus depends on the amount of calcium, iron, strontium, and aluminum present in the diet. Chapman and Pugsley (1971) have suggested that a diet containing more phosphorus than calcium is as detrimental as a simple calcium deficiency. The ratio of calcium to phosphorus in bone is 2 to 1. It has been recommended that in early infancy, the ratio should be 1.5 to 1; in older infants, 1.2 to 1; and for adults, 1 to 1. The estimated annual per capita intake in the United States is 1 g Ca and 2.9 g P, thus giving a ratio of 0.35. The danger in raising phosphorus levels is that calcium may become unavailable.

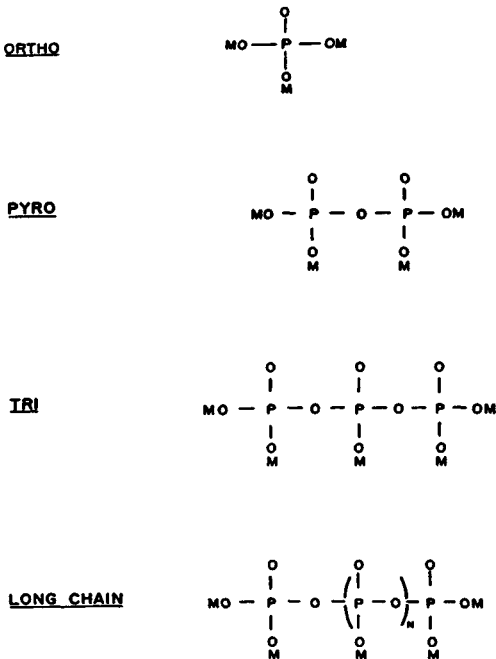

Figure 11-5 Structure of Ortho- and Polyphosphate Salts

Coloring Agents

In the United States two classes of color additives are recognized: colorants exempt from certification and colorants subject to certification. The former are obtained from vegetable, animal, or mineral sources or are synthetic forms of naturally occurring compounds. The latter group of synthetic dyes and pigments is covered by the Color Additives Amendment of the U.S. Food, Drug and Cosmetic Act. In the United States these color compounds are not known by their common names but as FD&C colors (Food, Drug and Cosmetic colors) with a color and a number (Noonan 1968). As an example,

FD&C red dye no. 2 is known as amaranth outside the United States. Over the years the originally permitted fat-soluble dyes have been removed from the list of approved dyes, and only water-soluble colors remain on the approved list.

According to Newsome (1990) only nine synthetic colors are currently approved for food use and 21 nature-identical colors are exempt from certification. The approved FD&C colors are listed in Exhibit 11-2. Citrus red no. 2 is only permitted for external use on oranges, with a maximum level of 2 ppm on the weight of the whole orange. Its use is not permitted on oranges destined for processing.

Lakes are insoluble forms of the dyes and are obtained by combining the color with aluminum or calcium hydroxide. The dyes provide color in solution, and the lakes serve as insoluble pigments.

The average per capita consumption of food colors is about 50 mg per day. Food colors have been suspect as additives for many years, resulting in many deletions from the approved list. An example is the removal of FD&C red no. 2 or amaranth in 1976. In the United States, it was replaced by FD&C red no. 40. The removal from the approved list was based on the observation of reproductive problems in test animals that consumed amaranth at levels close to the ADI. As a consequence, the Food and Agriculture Organization (FAO)/World Health Organization (WHO) reduced the ADI to 0.75 mg/kg body weight from 1.5 mg/kg. Other countries, including Canada, have not delisted amaranth.

The natural or nature-identical colors are less stable than the synthetic ones, more variable, and more likely to introduce undesirable flavors. The major categories of natural food colors and their sources are listed in Table 11-5.

Exhibit 11-2 Color Additives Permitted for Food Use in the United States and Their Common Names

- FD&C red no. 3 (erythrosine)
- FD&C red no. 40 (allura red)
- FD&C orange B
- FD&C yellow no. 6 (sunset yellow)
- FD&C yellow no. 5 (tartrazine)
- FD&C green no. 3 (fast green)
- FD&C blue no. 1 (brilliant blue)
- FD&C blue no. 2 (indigotine)
- Citrus red no. 2

Source: Reprinted with permission from R.L. Newsome, Natural and Synthetic Coloring Agents, in *Food Additives*, A.L. Branen, P.M. Davidson, and S. Salminen, eds., p. 344, 1990, by courtesy of Marcel Dekker, Inc.

Food Irradiation

Food irradiation is the treatment of foods by ionizing radiation in the form of beta, gamma, or X-rays. The purpose of food irradiation is to preserve food and to prolong shelf life, as other processing techniques such as heating or drying have done. For regulatory purposes irradiation is considered a process, but in many countries it is considered to be an additive. This inconsistency in the interpretation of food irradiation results in great obstacles to the use of this process and has slowed down its application considerably. Several countries are now in the process of reconsidering their legislation regarding irradiation. Depending on the radiation dose, several applications can be distinguished. The unit of radiation is the Gray

Table 11-5 Major Categories of Natural Food Colors and Their Sources

<i>Colorant</i>	<i>Sources</i>
Anthocyanins	Grape skins, elderberries
Betalains	Red beets, chard, cactus fruits, pokeberries, bougainvillea, amaranthus
Caramel	Modified sugar
Carotenoids	
Annatto (bixin)	Seeds of <i>Bixa orellana</i>
Canthaxanthin	Mushrooms, crustaceans, fish, seaweed
β -apocarotenal	Oranges, green vegetables
Chlorophylls	Green vegetables
Riboflavin	Milk
Others	
Carmine (cochineal extract)	<i>Coccus cacti</i> insect
Turmeric (curcuma)	<i>Curcuma longa</i>
Crocin, crocin	Saffron

Source: Reprinted with permission from R.L. Newsome, Natural and Synthetic Coloring Agents, in *Food Additives*, A.L. Branen, P.M. Davidson, and S. Salminen, eds., p. 333, 1990, by courtesy of Marcel Dekker, Inc.

(Gy), which is a measure of the energy absorbed by the food. It replaced the older unit rad (1 Gy = 100 rad).

Radiation sterilization produces foods that are stable at room temperature and requires a dose of 20 to 70 kGy. At lower doses, longer shelf life may be obtained, especially with perishable foods such as fruits, fish, and shellfish. The destruction of *Salmonella* in poultry is an application for radiation treatment. This requires doses of 1 to 10 kGy. Radiation disinfestation of spices and cereals may replace chemical fumigants, which have come under increasing scrutiny in recent years. Dose levels of 8 to 30 kGy would be required. Other possible applications of irradiation processing are inhibition of sprouting in potatoes and onions and delaying of the ripening of tropical fruits.

Nutrition Supplements

There are two fundamental reasons for the addition of nutrients to foods consumed by the public: (1) to correct a recognized deficiency of one or more nutrients in the diets of a significant number of people when the deficit actually or potentially adversely affects health; and (2) to maintain the nutritional quality of the food supply at a level deemed by modern nutrition science to be appropriate to ensure good nutritional health, assuming only that a reasonable variety of foods are consumed (Augustin and Scarbrough 1990).

A variety of compounds are added to foods to improve the nutritional value of a product, to replace nutrients lost during processing, or to prevent deficiency diseases. Most of the additives in this category are

vitamins or minerals. Enrichment of flour and related products is now a well-recognized practice. The U.S. Food and Drug Administration (FDA) has established definitions and standards of identity for the enrichment of wheat flour, farina, corn meal, corn grits, macaroni, pasta products, and rice. These standards define minimum and maximum levels of addition of thiamin, riboflavin, niacin, and iron. In some cases, optional addition of calcium and vitamin D is allowed. Margarine contains added vitamins A and D, and vitamin D is added to fluid and evaporated milk. The addition of the fat-soluble vitamins is strictly controlled, because of the possible toxicity of overdoses of these vitamins. The vitamin D enrichment of foods has been an important measure in the elimination of rickets. Another example of the beneficial effect of enrichment programs is the addition of iodine to table salt. This measure has virtually eliminated goiter.

One of the main potential deficiencies in the diet is calcium. Lack of calcium is associated with osteoporosis and possibly several other diseases. The recommended daily allowance for adolescents/young adults and the elderly has increased from the previous recommendation of 800 to 1,200 mg/day to 1,500 mg/day. This level is difficult to achieve, and the use of calcium citrate in fortified foods has been recommended by Labin-Goldscher and Edelstein (1996). Sloan and Stiedemann (1996) highlighted the relationship between consumer demand for fortified products and complex regulatory issues.

Migration from Packaging Materials

When food packaging materials were mostly glass or metal cans, the transfer of packaging components to the food consisted predominantly of metal (iron, tin, and lead)

uptake. With the advent of extensive use of plastics, new problems of transfer of toxicants and flavor and odor substances became apparent. In addition to polymers, plastics may contain a variety of other chemicals, catalysts, antioxidants, plasticizers, colorants, and light absorbers. Depending on the nature of the food, especially its fat content, any or all of these compounds may be extracted to some degree into the food (Bieber et al. 1985).

Awareness of the problem developed in the mid 1970s when it was found that mineral waters sold in polyvinyl chloride (PVC) bottles contained measurable amounts of vinyl chloride monomer. Vinyl chloride is a known carcinogen. The Codex Alimentarius Committee on Food Additives and Contaminants has set a guideline of 1 ppm for vinyl chloride monomer in PVC packaging and 0.01 ppm of the monomer in food (Institute of Food Technologists 1988). Another additive found in some PVC plastics is octyl tin mercaptoacetate or octyl tin maleate. Specific regulations for these chemicals exist in the Canadian Food and Drugs Act.

The use of plastic netting to hold and shape meat during curing resulted in the finding of N-nitrosodiethylamine and N-nitrosodibutylamine in hams up to levels of 19 ppb (parts per billion) (Sen et al. 1987). Later research established that the levels of nitrosamines present were not close to violative levels (Marsden and Pesselman 1993).

Plasticizers, antioxidants, and colorants are all potential contaminants of foods that are contained in plastics made with these chemicals. Control of potential migration of plastic components requires testing the containers with food simulants selected to yield information relevant to the intended type of food to be packaged (DeKruyf et al. 1983; Bieber et al. 1984).

Other Additives

In addition to the aforementioned major groups of additives, there are many others including clarifying agents, humectants, glazes, polishes, anticaking agents, firming agents, propellants, melting agents, and enzymes. These intentional additives present considerable scientific and technological problems as well as legal, health, and public relations challenges. Future introduction of new additives will probably become increasingly difficult, and some existing additives may be disallowed as further toxicological studies are carried out and the safety requirements become more stringent.

INCIDENTAL ADDITIVES OR CONTAMINANTS

Radionuclides

Natural radionuclides contaminate air, food, and water. The annual per capita intake of natural radionuclides has been estimated to range from 2 Becquerels (Bq) for ^{232}Th to about 130 Bq for ^{40}K (Sinclair 1988). The Bq is the International System of Units (SI) unit of radioactivity; 1 Bq = 1 radioactive disintegration per second. The previously used unit of radioactivity is the Curie (Ci); 1 Ci = 3.7×10^{10} disintegrations per second, and 1 Bq = 27×10^{-12} Ci. The quantity of radiation or energy absorbed is expressed in Sievert (Sv), which is the SI unit of dose equivalent. The absorbed dose (in Gy) is multiplied by a quality factor for the particular type of radiation. Rem is the previously used unit for dose equivalent; 100 rem = 1 Sv.

The effective dose of Th and K radionuclides is about 400 μSv per capita per year, with half of it resulting from ^{40}K . The total

exposure of the U.S. population to natural radiation has been estimated at about 3 mSv. In addition, 0.6 mSv is caused by man-made radiation (Sinclair 1988).

Radioactive Fallout

Major concern about rapidly increasing levels of radioactive fallout in the environment and in foods developed as a result of the extensive testing of nuclear weapons by the United States and the Soviet Union in the 1950s. Nuclear fission generates more than 200 radioisotopes of some 60 different elements. Many of these radioisotopes are harmful to humans because they may be incorporated into body tissues. Several of these radioactive isotopes are absorbed efficiently by the organism because they are related chemically to important nutrients; for example, strontium-90 is related to calcium and cesium-137 to potassium. These radioactive elements are produced by the following nuclear reactions, in which the half-life is given in parentheses:

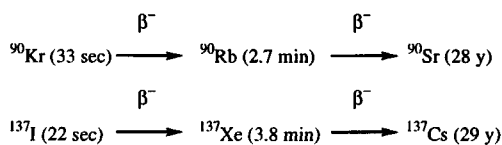

The long half-life of the two end products makes them especially dangerous. In an atmospheric nuclear explosion, the tertiary fission products are formed in the stratosphere and gradually come down to earth. Every spring about one-half to two-thirds of the fission products in the stratosphere come down and are eventually deposited by precipitation. Figure 11-6 gives a schematic outline of the pathways through which the fallout may reach us.

Regulatory Control of Food Composition, Quality, and Safety

HISTORICAL OVERVIEW

Attempts at regulating the composition of foods go back to the Middle Ages. Primarily restricted to certain food items such as bread or beer, these ancient regulations were intended to protect the consumer from fraudulent practices. The original Bavarian beer purity law dating from the Middle Ages is still quoted today to indicate that nothing but water, malt, yeast, and hops have been used in the production of beer. The foundations for many of our modern food laws were laid in the last quarter of the 19th century. Increasing urbanization and industrialization meant that many people had less control over the food that had to be brought into the urban centers. Foodstuffs were deliberately contaminated to increase bulk or improve appearance. Chalk was mixed with flour, and various metal salts were added to improve color (Reilly 1991). Some of these added substances were highly toxic. One practice leading to disastrous results was the distillation of rum in stills constructed of lead.

The first food laws in the United Kingdom were enacted in 1860 and 1875, and the first Canadian food law was passed in 1875. In the United States the first comprehensive federal food law came into effect in 1906. This

law prohibited the use of certain harmful chemicals in foods and the interstate commerce of misbranded or adulterated foods. Public concern about adulteration and false health claims during the 1930s led to the federal Food, Drug and Cosmetic Act (FDCA) in 1938. A major weakness of this law was that the burden of proof of the toxicity of a chemical was entirely upon the government. Any substance could be used until such time when it was proven in a court of law that the substance was harmful to health. A select committee of the U.S. House of Representatives, the Delaney committee, studied the law and recommended its revision. The revised law, which went into effect in 1958, is known as the Food Additives Amendment of the federal Food, Drug and Cosmetic Act. Under this act, no chemical can be used in food until the manufacturer can demonstrate its safety. The U.S. Food and Drug Administration (FDA) is responsible only for evaluating the safety evidence submitted by the applicant. The principle of establishing the safety of chemicals before they can be used is now becoming widely accepted in U.S. and international food laws.

A peculiar aspect of the federal act of 1958 is the so-called Delaney clause, which stipulates that any substance that is found to cause

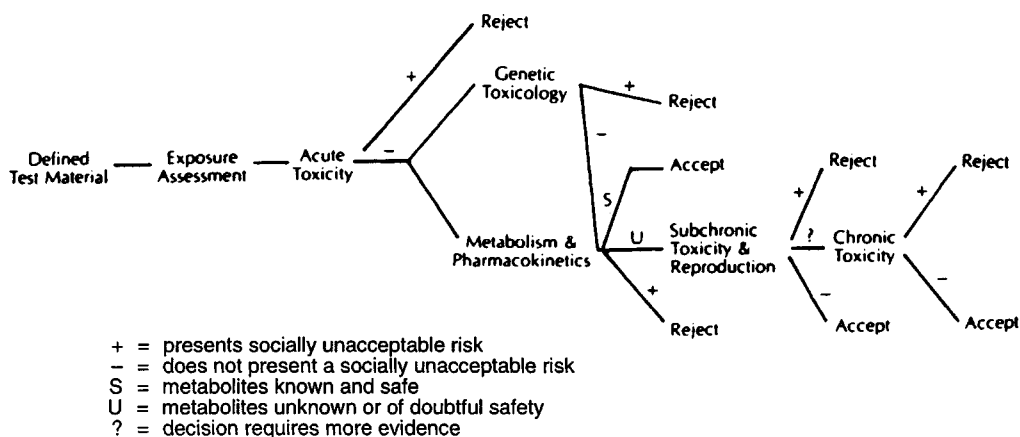

Figure 12-1 Proposed System for Food Safety Assessment. From Food Safety Council, 1982.

cancer in humans or animals is banned from use in food at any level. This controversial clause has been the subject of much discussion over the years. Suspected carcinogens can be dealt with in other food law systems under the general provisions of safety.

The establishment of the safety of a chemical has become more and more difficult over the years. There are several reasons for this. First, analytical instrumentation can detect ever smaller levels of a substance. Where it was once common to have levels of detection of parts per million, now levels of detection can be as low as parts per billion or parts per trillion. At these levels, chemicals become toxicologically insignificant. Second, the requirements for safety have become more complex. Initially, the safety of a chemical was determined by its acute toxicity measured on animals and expressed as LD_{50} , the dose level that results in a 50 percent mortality in a given test population. As the science of toxicology has matured, safety requirements have increased; safety testing now follows a standard pattern as exemplified by the proposed system for food safety assessment shown in Figure 12-1. Third, new process-

ing techniques and novel foods have been developed. Many years of research were required to demonstrate the safety of radiation pasteurization of foods, and even now only limited use is made of radiation treatment of food and food ingredients. The issue of the safety of novel foods has gained new importance since the introduction of genetically modified crops. In addition to the requirements of the safety decision tree of Figure 12-1, the issue of allergenicity has arisen. Toxicity is assumed to affect everyone in a similar way, but allergic reactions affect only certain individuals. Allergic reactions can be of different degrees of severity. A major allergic reaction can result in anaphylactic shock and even death. Regulations are now being developed in several countries related to placing warning labels on foods containing certain allergens. One example of possible transfer of allergenicity to another food occurred when a company explored the genetic modification of soybeans to improve protein content. A Brazil nut storage protein gene was selected for transfer into the soybean genetic makeup. When it was found that people who were allergic to nuts also

became allergic to the genetically altered soybean, the commercial development of this type of genetically modified soybean was abandoned. A fourth difficulty in regulatory control of food composition and quality is the often overlapping authority of different agencies. In many countries, the basic food law is the responsibility of the health department. However, control of meat products, animal health, and veterinary drug residues may reside in agriculture departments. Some countries such as Canada have a separate department dealing with fish and fisheries. Environmental issues sometimes come under the jurisdiction of industry departments. In addition, countries may have a federal structure where individual states or provinces exercise complete or partial control. Before the enactment of the FDCA in the United States, it was argued that food safety should be under the control of individual states. Canada is a federation, but the Canadian Food and Drugs Act is federal legislation that applies to all provinces and territories. In contrast, the situation in Australia, also a federation, makes each state responsible for its own food laws. Recent efforts there have tried to harmonize state food laws by introduction in each state of a "model food act" (Norris and Black 1989).

Usually, food laws are relatively short and simple documents that set out the general principles of food control. They are accompanied by regulations that provide specific details of how the principles set out in the food law should be achieved. In the United States the law deals with food, drugs, and cosmetics; in Canada the regulations deal with food and drugs. The tendency today is to provide laws that specifically deal with food. The separation of food laws and regulations makes sense because the regulations can be constantly updated without going

through the difficult process of changing the law.

Food and drugs have traditionally been considered separate categories in the legislative process. Until relatively recently, health claims on foods were prohibited in many countries. However, in recent years consumers have been deluged with health information relating to their foods. Some of this information has been negative, such as information about the effect of fat on the incidence of heart disease; other information has been positive as for instance the beneficial effect of dietary fiber.

There is increasing interest in a group of substances known as nutraceuticals or functional foods and food supplements. A nutraceutical can be defined as any food or food ingredient that provides medical or health benefits, including the prevention and treatment of disease. These materials cover a gray area between foods and drugs and present difficulties in developing proper regulatory controls. It has been stated (Camire 1996) that dietary supplements in the United States of America enjoy a favored status. They do not require proof of either efficacy or safety. Dietary supplements include a large variety of substances such as vitamins, minerals, phytochemicals, and herbal or botanical extracts (Pszczola 1998).

SAFETY

The safety of foods—including food additives, food contaminants, and even some of the major natural components of foods—is becoming an increasingly complex issue. Prior to the enactment of the Food Additives Amendment to the FDCA, food additive control required that a food additive be non-deceptive and that an added substance be

either safe and therefore permitted, or poisonous and deleterious and therefore prohibited. This type of legislation suffered from two main shortcomings: (1) it equated poisonous with harmful and (2) the onus was on the government to demonstrate that any chemical used by the food industry was poisonous. The 1958 act distinguishes between toxicity and hazard: *Toxicity* is the capacity of a substance to produce injury, and *hazard* is the probability that injury will result from the intended use of a substance. It is now well recognized that many components of our foods, whether natural or added, are toxic at certain levels but harmless or even nutritionally essential at lower levels. Some of the fat-soluble vitamins are in this category. The ratio between effective dose and toxic dose of many compounds, including such common nutrients as amino acids and salts, is of the order of 1 to 100. Today any user of an additive must petition the government for permission to use the material and supply evidence that the compound is safe.

The public demand for absolute safety is incompatible with modern scientific understanding of the issues. Safety is not absolute but rather a point on a continuum; the exact position involves judgments based on scientific evidence and other important factors including societal, political, legal, and economic issues. Modern legislation moves away as much as possible from the non-science factors. Several recent issues have demonstrated how difficult this can be. In some cases scientific knowledge is unavailable, and decision making is difficult. In addition, we now know that food safety relates to all parts of the food chain, not merely the industrial processing of foods. What happens on the farm in terms of use of particular animal feeds or use of agricultural chemicals up to the handling of foods in food

service establishments are all part of the food safety problem.

Scheuplein and Flamm (1989) stated that the assurance of safety by the FDA has moved away from a comfortable assurance of absolute safety to an assurance of some very small yet distinctly uncomfortable level of risk. It appears that the public is less inclined to accept even a very low level of risk related to the food supply than the often much greater risks of many of our daily activities.

In the United States, safety is often expressed as the principle of "reasonable certainty of no harm." This principle has replaced the earlier idea of "zero tolerance" for toxic substances. The idea of zero tolerance is incorporated in the Delaney clause of the Food Additives Amendment.

As the science of toxicology developed, the requirements for establishing safety became more demanding. At one time the LD_{50} was sufficient to establish safety. The effect of dose level is very important in toxicology. The effects, which vary from no effect dose (NED) levels to fatal effect, have been summarized in Figure 12-2 (Concon 1988). Two types of substances exist; type I shows no beneficial effects and type II shows nutritional and/or therapeutic beneficial effects.

LD_{50} is a measure of acute toxicity. Over time, many other test requirements have been added to establish safety as shown in the safety decision tree developed by the Food Safety Council (1982). In this system an organized sequence of tests is prescribed (see Figure 12-1). Other tests in this system involve genetic toxicity, metabolism, pharmacokinetics (the pathways of chemicals in the system and their possible accumulation in organs), subchronic toxicity, teratogenicity (birth defects), and chronic toxicity. To all this are added tests for carcinogenicity and

Type I:

No Effect (harmless) → Toxic Effects → Fatal Effects

Increasing Dose

**Type II:**

No Effect → Beneficial Effects (nutritional and/or therapeutic) → Toxic Effects → Fatal Effects

Figure 12-2 Relationship Between Dose Level and Toxic Effects. *Source:* Reprinted with permission from J.M. Concon, *Food Toxicology. Part A—Principles and Concepts. Part B—Contaminants and Additives*, p. 16, 1988, by courtesy of Marcel Dekker, Inc.

allergenicity. Most of these tests are performed on animals. The no-effect level ascertained with animals is then divided by a safety factor of 100 to arrive at a safe level for humans. The idea of establishing a safety margin for chronic toxicity was accepted by the FDA in 1949.

The sequence of events leading from toxicological investigations to the formulation of regulations is shown in Figure 12-3 (Vettorazi 1989). The important part of this procedure is the interpretation. This is carried out by qualified experts who develop recommendations based on the scientific data produced. It is sometimes possible for different groups of experts (such as groups in different countries) to come up with differing recommendations based essentially on the same data.

U.S. FOOD LAWS

The basic U.S. law dealing with food safety and consumer protection is the Food, Drug and Cosmetic Act (FDCA) of 1938 as

amended by the Food Additives Amendment of 1958. The FDCA applies to all foods distributed in the United States, including foods imported from other countries. A number of other acts are important for the production and handling of foods. Some of the more important ones include the following:

- *The Meat Inspection Act of 1906.* The responsibility for the safety and wholesomeness of meat and meat products falling under the provisions of this act is delegated to the U.S. Department of Agriculture (USDA). The USDA's responsibilities include inspection of meat-processing facilities and animals before and after slaughter, inspection of meat products and meat-processing laboratories, and premarket clearance of meat product labels. When a food product contains less than 3 percent meat, the product comes under the jurisdiction of the FDA. Similar laws are the Poultry Products Inspection Act and the Egg

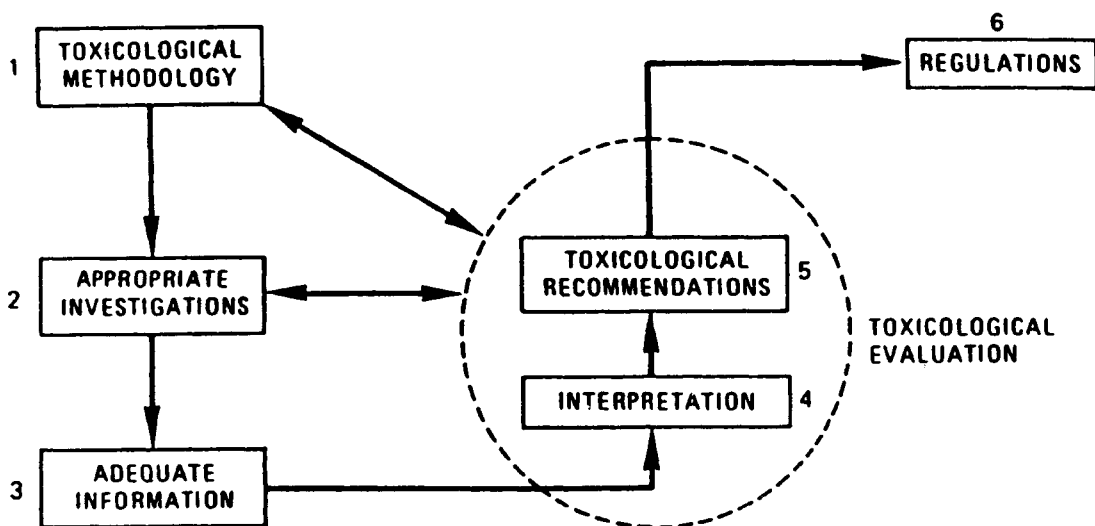

Figure 12-3 Critical Points and Objectives of Toxicological Evaluation of Food Additives. *Source:* Reprinted with permission from G. Vettorazi, Role of International Scientific Bodies, in *International Food Regulation Handbook*, R.D. Middlekauff and P. Shubik, eds., p. 489, 1989, by courtesy of Marcel Dekker, Inc.

Product Inspection Act. Both of these are the responsibility of USDA.

- *The Safe Drinking Water Act.* Passed in 1974, this law gives the FDA authority to regulate bottled drinking water and the Environmental Protection Agency authority to set standards for drinking water supplies.
- *The Nutrition Labeling and Education Act of 1990 (NLEA).* This is an extension of the FDCA and requires that all foods intended for retail sales are provided with nutrition labeling. Mandatory nutrition labeling is not required in most other countries unless a health claim is made.
- Alcoholic beverages come under the authority of the Bureau of Alcohol, Tobacco and Firearms (BATF), an organization unique to the United States. It is noteworthy that some of the labeling requirements for other foods do not apply to alcoholic beverages.

The various U.S. agencies involved in food control and their responsibilities are summarized in Table 12-1. The FDA is the agency primarily responsible for the control of food, and its authority derives from the U.S. Department of Health and Human Services. The USDA is responsible for meat, poultry, and egg products. These activities are carried out by a number of organizations within USDA. The Food Safety and Inspection Service (FSIS), the Food and Nutrition Service (FNS), and the Agricultural Marketing Service (AMS) are all part of this activity.

The Food Additives Amendment to the FDCA (see Chapter 11) recognizes the following three classes of intentional additives:

1. those generally recognized as safe (GRAS)
2. those with prior approval
3. food additives

Table 12–1 Food Safety Responsibilities of 12 U.S. Agencies

<i>Agency</i>	<i>Responsibilities</i>
Food and Drug Administration (FDA)	Ensures safety of all foods except meat, poultry, and egg products. Also, ensures safety of animal drugs and feeds.
Food Safety and Inspection Service (FSIS)	Ensures safety of meat, poultry, and egg products.
Animal and Plant Health Inspection Service (APHIS)	Protects animals and plants from disease and pests or when human health may be affected.
Grain Inspection, Packers and Stockyard Administration (GIPSA) ^a	Inspects grain, rice, and related products for quality and aflatoxin contamination.
Agricultural Marketing Service (AMS)	Grades quality of egg, dairy, fruit, vegetable, meat, and poultry products.
Agricultural Research Service (ARS)	Performs food safety research.
National Marine Fisheries Service (NMFS)	Conducts voluntary seafood inspection program.
Environmental Protection Agency (EPA)	Establishes pesticide tolerance levels.
Centers for Disease Control and Prevention (CDC)	Investigates foodborne disease problems.
Federal Trade Commission (FTC)	Regulates advertising of food products.
U.S. Customs Service (Customs)	Examines/collects food import samples.
Bureau of Alcohol, Tobacco and Firearms (ATF)	Regulates alcoholic beverages.

^a GIPSA replaced USDA's Grain Inspection Service.

Coloring materials and pesticides on raw agricultural products are covered by other laws. The GRAS list contains several hundred compounds, and the concept of such a list has been the subject of a good deal of controversy (Hall 1975). The concept of a GRAS list is unique to the U.S. regulatory system; there is no equivalent in the legislation of other countries.

An important aspect of U.S. food laws is mandatory nutritional labeling. Nutritional labeling in Canada and Europe is voluntary and only becomes mandatory if a health claim is made.

Another trend in food legislation is the change from prescriptive regulations to the requirement of total quality assurance sys-

tems. This means that food industries will be required to adopt HACCP systems (hazard analysis critical control points).

CANADIAN FOOD LAWS

In May 1997 a completely reorganized system of food control in Canada went into effect with the creation of the Canadian Food Inspection Agency (CFIA). The CFIA combines into a single organization food control functions of at least four federal departments. This major change was intended to simplify a complex and fragmented system.

Prior to the formation of CFIA, food control responsibilities were shared by the fol-

lowing federal departments: Health Canada (HC), Agriculture and Agri-food Canada (AAFC), Fisheries and Oceans Canada (FOC), and Industry Canada (IC).

The major law relating to food safety is the Food and Drugs Act and regulations. Until May 1997 HC was responsible for food, health, safety, and nutrition as well as for administering the Food and Drugs Act and regulations (Smith and Jukes 1997). Food labeling regulations are part of Food and Drugs Act and regulations, but enforcement was shared with AAFC. AAFC administered the Meat Inspection Act and the Canadian Agricultural Products Act. FOC administered the Fish Inspection Act. The Consumer Packaging and Labeling Act standardizes the form and manner of essential information on the label of all prepackaged consumer products including foods. The required information includes the common name of the product, the net quantity, and name and address of the company or person responsible for the product. Canadian regulations require this information to be provided in both official languages, English and French.

Because the Food and Drugs Act is criminal law, it applies to all foods sold in Canada. The laws administered by AAFC and FOC are not criminal law and, therefore, do not apply to foods produced and sold within the same province. This is similar to the situation in the United States.

Provinces and municipalities have a certain level of involvement with food control. Provincial regulations are mainly concerned with health issues and the control of certain commodities such as dairy products.

The establishment of the CFIA in 1997 significantly changed the system. CFIA is responsible for the enforcement and/or administration of 11 statutes regulating food,

animal and plant health, and related products. This involves a consolidation of the inspection and animal and plant health services of HC, AAFC, and FOC. A single body, the CFIA, is now responsible for the federal control of all food products.

The establishment of the CFIA is only the first step in a complete overhaul of the Canadian food control system. One of the immediate goals is the development of a Canadian Food Act, and the harmonization of federal and provincial acts. Approximately 77 different federal, provincial, and territorial acts regulate food in Canada. Through the Canadian Food Inspection System (CFIS), a common regulatory base will be developed, as depicted in Figure 12-4. An important aspect of future food regulations will be the reliance on HACCP for safety assurance.

EUROPEAN UNION (EU) FOOD LAWS

The EU at this time involves 15 independent states, and one of the aims of the union is to facilitate trade among member states. To achieve the harmonization of food laws, a program was instituted to develop a common set of food laws. The EU food laws apply in all of the 15 member nations, but the enforcement remains with the individual member states. The EU is governed by three bodies, the European Council (the Council), which consists of ministers from the member countries; the European Parliament, which is formed from members elected in the member countries; and the European Commission (the Commission). The Commission is the working organization that develops laws. The Council approves the laws, and the Parliament has an advisory function. The EU laws, adopted by the Council, may take the following forms:

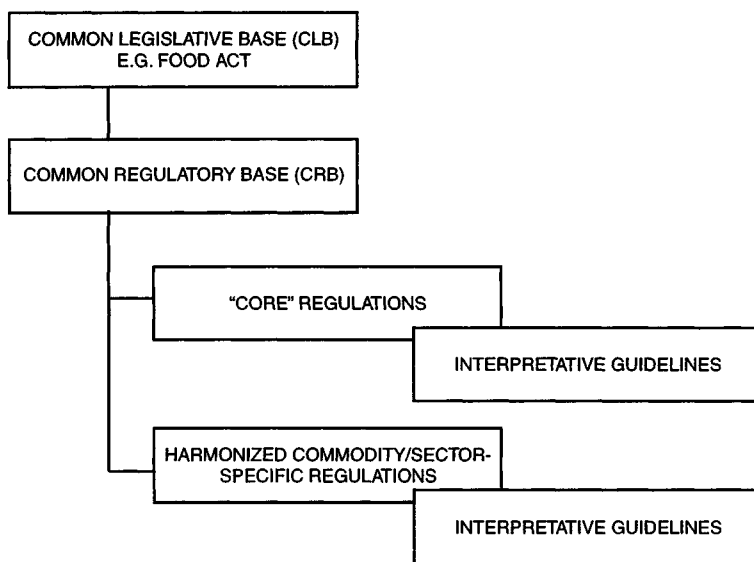

Figure 12-4 Common Regulatory Base Suggested for the Canadian Food System

- *Regulations.* These are directly applied without the need for national measures to implement them.
- *Directives.* These bind member states as to the objectives to be achieved while leaving the national authorities the power to choose the form and means to be used.
- *Decisions.* These are binding in all their aspects upon those to whom they are addressed. A decision may be addressed to any or all member states, to undertakings, or to individuals.
- *Recommendations and opinions.* These are not binding.

The Commission began preparing a comprehensive directive on food additives in 1988. The comprehensive directive on food additives will have two major parts: (1) a list of all the additives and their conditions of use, and (2) the purity criteria of these addi-

tives, together with other specifications such as sampling methods and methods of analysis.

An interesting development in EU food laws is the decision of the Commission to discontinue issuing vertical directives (vertical relates to commodity-specific issues) and to concern itself with horizontal regulations (horizontal relates to general issues across commodities).

An important recent issue concerns the Novel Food Regulation, which is a system of formal, mandatory, premarket evaluation and approval for most innovative foods and food production processes (Huggett and Conzelmann 1997). Novel foods are all foods and food ingredients that have not hitherto been used for human consumption to a significant degree in the EU. The Novel Food Regulation requires additional specific labeling of any characteristic, food property (such as composition, nutritional value, or nutritional

effects), or intended use that renders the food no longer equivalent to its conventional counterpart. This regulation, therefore, requires specific labeling for foods produced through genetic engineering. U.S. regulations do not require labeling to describe the use of genetic engineering in developing a new variety of food.

A food safety crisis developed in Europe beginning in the late 1980s and early 1990s. The disease in cattle known as bovine spongiform encephalopathy (BSE), popularly known as mad cow disease, assumed epidemic proportions in England, and more than a million head of cattle had to be destroyed. The problem with BSE is twofold: the pathogenic agent(s) has not been identified, and the transmission to humans is suspected but not proven. There is a human spongiform encephalopathy, Creutzfeldt-Jakob disease (CJD), which is rare and usually affects older people; a new variant (vCJD) affects younger persons (Digulio et al. 1997). Many unanswered questions about the disease and its possible effect on humans as well as incompetent handling of the issue by politicians created a great deal of unease by the public in Europe. The possibility of transfer of the pathogenic agent via rendered meat and bone meal (MBM) has been suggested.

The BSE scare reinforced the importance of involving consumers and other groups in the consultative process in the development of EU legislation (Figure 12-5).

The EU passed a directive in 1993 requiring all food companies in the EU to implement an effective HACCP system by December 1995. The directive covers not only large and medium-sized businesses but also small companies and even small bakery shops and catering establishments. This directive makes the food manufacturer liable for damages suffered as a result of product defects.

INTERNATIONAL FOOD LAW: CODEX ALIMENTARIUS

The Codex Alimentarius Commission is a joint effort by two organizations of the United Nations—the Food and Agriculture Organization (FAO), headquartered in Rome, and the World Health Organization (WHO), headquartered in Geneva. The Codex Alimentarius Commission is responsible for developing a set of rules known as the Codex Alimentarius (CA). The CA has no legal status, and its adoption is voluntary. Its purpose is to serve as a reference for food safety and standardization on a worldwide basis and to serve as a model for adoption by nations that do not have the resources to develop their own standards. Working under the commission are worldwide general subject committees, a series of worldwide commodity committees, and regional coordinating committees (Figure 12-6).

The fact that CA is a joint effort of FAO and WHO is fortunate and meaningful. Even today in the United States, the FDA is constantly searching to serve both the consuming public and the food industry without creating an impression of being partial to one side or the other.

Since its inception, the CA Commission has produced a large volume of standards, codes of practice, and guidelines. It has developed more than 220 commodity standards, more than 40 codes of practice, a model food law, a code of ethics, and limits for more than 500 food additives. In addition, the commission scrutinized 2,000 pesticides and established limits on 200 of them (Mendez 1993). The work on pesticide residues has resulted in establishing maximum residue limits (MRLs) for a wide range of pesticides in many food commodities. The

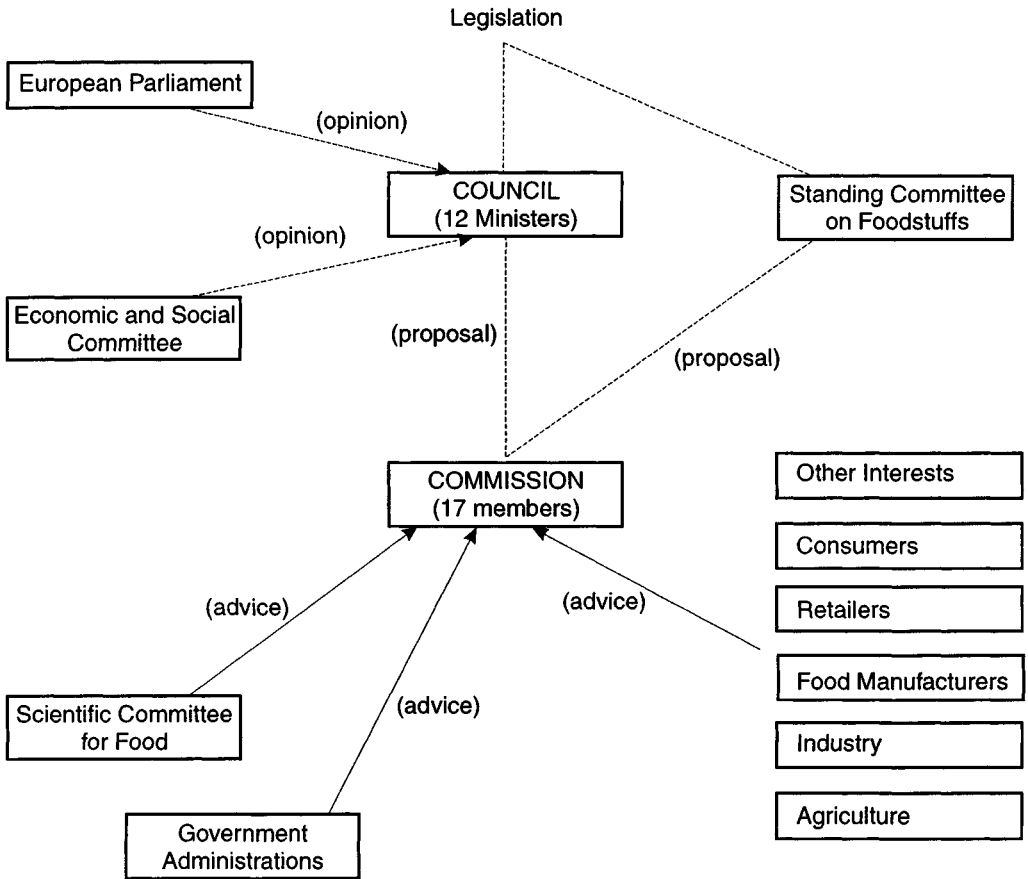

Figure 12-5 The Consultative Process Used in the Development of EU Food Legislation. *Source:* Reprinted with permission from R. Haigh and P. Deboysier, *Food Additives and the European Economic Community*, in *International Food Regulation Handbook*, R.D. Middlekauff and P. Shubik, eds., 1989, by courtesy of Marcel Dekker, Inc.

commission has studied the safety of a large variety of food additives, considering both toxicology and efficacy. The commission has also been active in the area of the safe use of veterinary drugs and has set maximum residue levels for these compounds. The codes of hygienic/technological practice have been developed for a wide range of food commodities.

An important recent development in the work of the CA is its change in emphasis. It is gradually moving away from the vertical

approach to laws (that is, laws relating to a single commodity) to horizontal laws (more broadly based laws that apply across all foods and food commodities). The CA procedure for the elaboration of standards is a complex process involving eight steps. Recently, the CA Commission decided to discontinue work on a standard for mayonnaise. This trend of moving away from vertical standards is not confined to CA. It is also taking place in EU legislation and in many national systems.

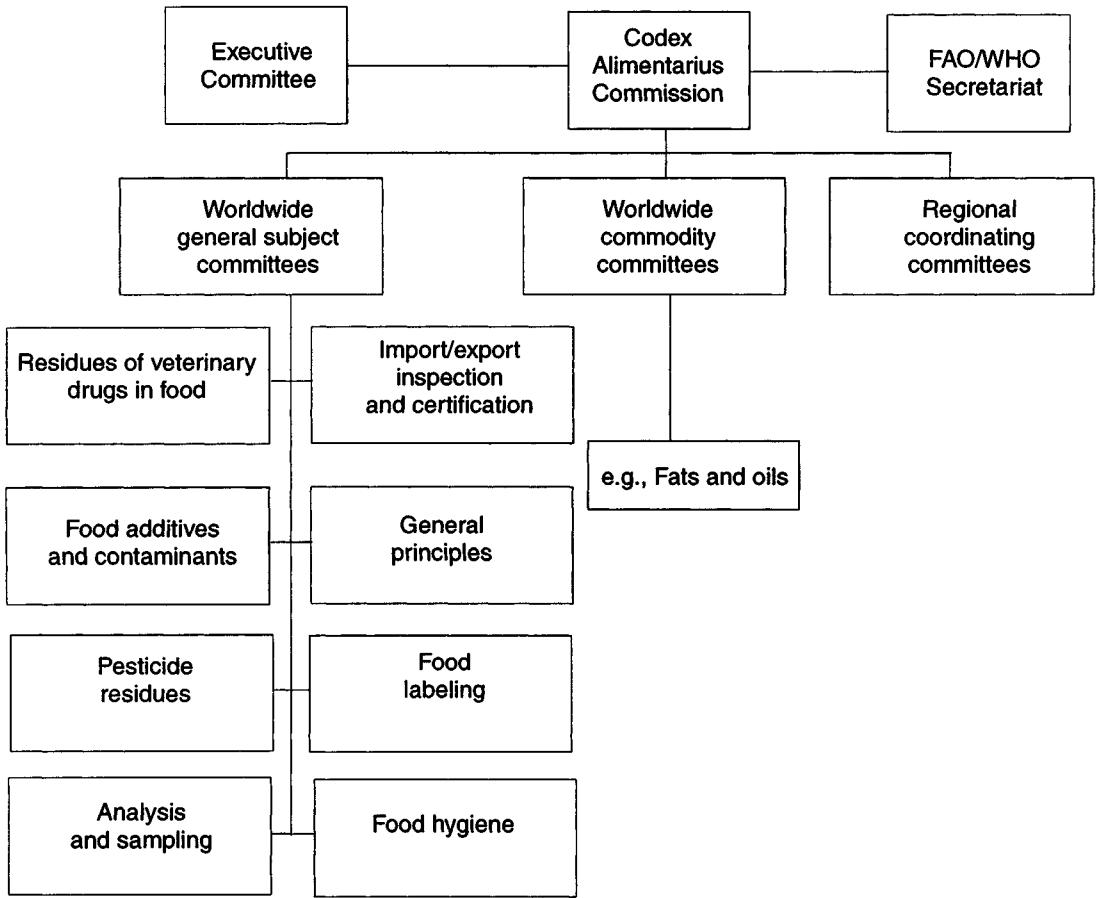

Figure 12-6 Structure of the Codex Alimentarius Commission

The importance of CA standards for international trade increased significantly as a result of the formation in 1995 of the World Trade Organization (WTO), headquartered in Geneva. The WTO is the successor to the General Agreement on Tariffs and Trade (GATT), and most trading nations of the world are members of WTO. One of the main purposes of WTO is to promote trade through the elimination of nontariff trade barriers. In the area of food trade, "health requirements" often were used as a trade barrier. To improve

the rules that were in effect during the GATT period, WTO established the Agreement on Sanitary and Phytosanitary Measures, known as the S&P Agreement. This agreement deals with trade in agricultural products of animal and plant origin. Under this agreement, member states of WTO agree to settle trade disputes on the basis of scientific facts and use of the CA standards. A recent case that was brought before the WTO panel involved the refusal by the EU to allow importation of beef originating in the United States that is

produced using growth hormones. The United States argued on the basis of scientific evidence that this practice did not result in any detectable residue of the hormones in the beef. The WTO panel has ruled in favor of the U.S. position.

The labeling of food causing severe allergic reaction in some people has resulted in the draft list of foods in May 1996. Severe allergic reactions may cause anaphylaxis and possible death in sensitive persons. The list includes the following foods:

- cereals containing gluten (wheat, rye, barley, oats, spelt, or their hybridized strains and products of these)
- crustacea and products of these
- eggs and egg products

- fish and fish products
- peanuts, soybeans, and products of these
- milk and milk products (lactose included)
- tree nuts and nut products
- sulfite in concentrations of 10 mg/kg or more

This CA proposal is likely to be adopted for inclusion in the food laws of many countries.

The possibility of transfer of allergenicity from an existing food to a new genetically engineered variety is one of the major concerns relating to novel foods produced by genetic engineering. Assessment of the allergenic potential is a critical component of the safety assessment of crops developed by using plant biotechnology (Fuchs and Astwood 1996).

Table 12-2 Comparison of Flour Enrichment Requirements in Canada and the United States

Nutrient	Canada (Flour, White Flour, Enriched Flour, or Enriched White Flour)		United States (Enriched Flour)
	Minimum per 100 g	Maximum per 100 g	Amount per 100 g
Mandatory			
Thiamine	0.44 mg	0.77 mg	0.64 mg
Riboflavin	0.27 mg	0.48 mg	0.40 mg
Niacin	3.5 mg	6.4 mg	5.29 mg
Folic acid	—	—	0.15 mg
Iron	2.9 mg	4.3 mg	4.40 mg
Optional			
Vitamin B ₆	0.25 mg	0.31 mg	—
Folic acid	0.04 mg	0.05 mg	—
Pantothenic acid	1.0 mg	1.3 mg	—
Magnesium	150 mg	190 mg	—
Calcium	110 mg	140 mg	211 mg

Source: Reprinted from Health Canada, Health Protection Branch consultative document on draft proposals-subjects: (1) fortification of flour and pasta with folic acid, (2) harmonization of flour enrichment with the United States of America, (3) optional enrichment of flour.

HARMONIZATION

Harmonization of food laws between nations and trading blocks is important for the promotion of international trade. Harmonization does not necessarily mean that food laws have to become identical in different jurisdictions. It may rather be a case of establishing the principle of equivalency. It can be assumed that if the basic principles of the different laws are essentially the same (the assurance of a safe and wholesome food supply) and their enforcement is satisfactory, then products produced in one country can be accepted as complying with the law in another country. Harmonization of food laws between trading partners in free trade groups is important in promoting free trade. The best example is the efforts of harmonizing food laws in the countries of the EU. The establishment of the WTO has increased the importance of the CA and will have an effect in establishing CA as the worldwide refer-

ence for settling disputes about nontariff trade barriers.

Other efforts at harmonizing food laws occur between partners of the North American Free Trade Agreement (NAFTA) involving the United States, Canada, and Mexico, and between Australia and New Zealand. A suggested approach to legislative harmonization is depicted in Figure 12-4. The existence of a model food act developed by CA should be an incentive in bringing about harmonization within and between countries.

Food laws developed in various countries reflect the way governments are organized and the state of development of the food industry. Different interpretations of scientific and nutritional information can result in establishment of different standards. This is demonstrated by the comparison of Canadian and U.S. rules on flour enrichment (Table 12-2).

The increasing efforts of harmonization of food laws around the world will continue as international trade in food products continues to grow.

REFERENCES

- Camire, M.E. 1996. Blurring the distinction between dietary supplements and foods. *Food Technol.* 50, no. 6: 160.
- Concon, J.M. 1988. *Food toxicology. Part A: Principles and concepts. Part B: Contaminants and additives.* New York: Marcel Dekker.
- Digulio, K., et al. 1997. International symposium on spongiform encephalopathies: Generating rational policy in the face of public fears. *Trends Food Sci. Technol.* 8: 204-206.
- Food Safety Council. 1982. *A proposed food safety evaluation process: Final report of board of trustees.* Washington, DC.
- Fuchs, R.L., and J.D. Astwood. 1996. Allergenicity assessment of foods derived from genetically modified plants. *Food Technol.* 50, no. 2: 83-88.
- Hall, R.L. 1975. GRAS: Concept and application. *Food Technol.* 29: 48-53.
- Huggett, A.C., and C. Conzelmann. 1997. EU regulation on novel foods: Consequences for the food industry. *Trends Food Sci. Technol.* 8: 133-139.
- Mendez, G.R., Jr. 1993. Codex Alimentarius promotes international co-operation. *Food Technol.* 47, no. 6: 14.
- Norris, B., and A.L. Black. 1989. Food administration in Australia. In *International food regulation handbook*, ed. R.D. Middlekauff and P. Shubik. New York: Marcel Dekker.
- Pszczola, D.E. 1998. The ABC's of nutraceutical ingredients. *Food Technol.* 52, no. 3: 30-37.
- Reilly, C. 1991. *Metal contamination of food.* 2nd ed. London: Elsevier Applied Science.

Scheuplein, R.J., and W.G. Flamm. 1989. A historical perspective on FDA's use of risk assessment. In *International food regulation handbook*. ed. R.D. Middlekauff and P. Shubik. New York: Marcel Dekker.

Smith, T.M., and D.J. Jukes. 1997. Food control systems in Canada. *Crit. Rev. Food Sci. Nutr.* 37: 299–251.

Vettorazi, G. 1989. Role of international scientific bodies. In *International food regulation handbook*. ed. R.D. Middlekauff and P. Shubik. New York: Marcel Dekker.

Units and Conversion Factors

The International System (SI) of the Units rests upon seven base units and two supplementary units as shown in Table A-1. From the base units, derived units can be obtained to express various quantities such as area, power, force, etc. Some of these have special names as listed in Table A-2. Multiples and submultiples are obtained by using prefixes as shown in Table A-3.

Older units in the metric system and the avoirdupois system are still widely used in the literature, and the information supplied in this appendix is given for convenience in converting these units, Table A-4.

TEMPERATURE

$$0\text{ }^{\circ}\text{C} = 273\text{ }^{\circ}\text{K}$$

Celsius was formerly called Centigrade

$$100\text{ }^{\circ}\text{C} = (100 \times 1.8) + 32\text{ }^{\circ}\text{F} = 212\text{ }^{\circ}\text{F}$$

$$0\text{ }^{\circ}\text{C} = 32\text{ }^{\circ}\text{F}$$

$$^{\circ}\text{F} = (^{\circ}\text{C} \times 1.8) + 32$$

$$^{\circ}\text{C} = (^{\circ}\text{F} - 32) \div 1.8$$

Table A-1 Base Units and Supplementary Units

<i>Quantity</i>	<i>Unit</i>	<i>Symbol</i>
Base Units		
Length	meter	m
Mass	kilogram	kg
Time	second	s
Electric current	ampere	A
Temperature	kelvin	K
Luminous intensity	candela	cd
Amount of substance	mole	mol
Supplementary Units		
Plane angle	radian	rad
Solid angle	steradian	sr

Table A-2 Derived Units with Special Names

<i>Quality</i>	<i>Unit</i>	<i>Symbol</i>	<i>Formula</i>
Force	newton	N	kg.m/s ²
Energy	joule	J	N.m
Power	watt	W	J/s
Pressure	pascal	Pa	N/m ²
Electrical potential	volt	V	W/A
Electrical resistance	ohm	Ω	V/A
Electrical conductance	siemens	S	1/Ω
Electrical charge	coulomb	C	A.s
Electrical capacitance	farad	F	C/V
Magnetic flux	weber	Wb	V.s
Magnetic flux density	tesla	T	Wb/m ²
Inductance	henry	H	Wb/A
Frequency	hertz	Hz	2π/s
Illumination	lux	lx	cd.sr/m ²
Luminous flux	lumen	lm	cd.sr

Table A-3 Multiples and Submultiples

<i>Multiplier</i>	<i>Exponent Form</i>	<i>Prefix</i>	<i>SI Symbol</i>
1 000 000 000 000	10 ¹²	tera	T
1 000 000 000	10 ⁹	giga	G
1 000 000	10 ⁶	mega	M
1 000	10 ³	kilo	k
1 00	10 ²	hecto	h
10	10 ⁻¹	deca	da
0.1	10 ⁻¹	deci	d
0.01	10 ⁻²	centi	c
0.001	10 ⁻³	milli	m
0.000 001	10 ⁻⁶	micro	μ
0.000 000 001	10 ⁻⁹	nano	n
0.000 000 000 001	10 ⁻¹²	pico	p

Table A-4 Conversion Factors

	<i>To Convert</i> →	<i>Into</i>	<i>Multiply By</i>
0.30480	meters (m)	feet (ft) (= 12 in)	3.28084
0.09290	m ²	ft ²	10.76391
0.02832	m ³	cu ft (ft ³)	35.31467
28.31685	dm ³ - liters (L)	ft ³	0.03531
3.78541	liter (= 1000 cc)	US gal (= 128 US fl. oz)	0.26417
4.54609	liter (= 1000 mL)	Imp gal (= 160 l fl. oz)	0.21997
35.2383	liter (L)	US bushel	0.02838
0.06	m ³ /h	L/min	16.66667
1.69901	m ³ /h	cu ft/min	0.58858
0.22712	m ³ /h	USGPM	4.40287
0.27277	m ³ /h	IGPM	3.66615
0.10197	kg (= 1000 g)	Newton (N)	9.80665
0.45359	kg	lb (av) (= 16 oz)	2.20462
0.90718	Metric ton (MT)	Short ton (= 2000 lbs)	1.10231
1.01605	M ton (= 1000 kg)	Long ton (= 2240 lbs)	0.96421
0.01602	kg/dm ³	lb/ft ³	62.42789
0.06895	bar (= 10 N/cm ²)	psi	14.50377
0.001	bar	mbar (= 100 Pascals)	1.0 10 ³
0.09807	bar	mH ₂ O	10.19716
1.33331	mbar	mmHg (torr)	0.75001
33.77125	mbar	inHg (60°F)	0.02961
4.1868	kJ (kiloJoule)	kcal	0.23885
1.05504	kJ	BTU	0.94783
3.6 10 ³	kJ	kWh	0.27778 10 ⁻³
0.85985 10 ³	kcal	kWh	1.16300 10 ⁻³
1.16300 10 ⁻³	kW	kcal/h	0.85985 10 ³
0.29307 10 ⁻³	kW (kJ/sec)	BTU/h	3.41219 10 ³
0.25199	kcal/h	BTU/h	3.96838
0.746	kW	HP (electr.)	1.34048
0.73550	kW	Metric hp	1.35962
0.0935	foot-candle (ft-c)	lux	10.76
1	centipoise (cp)	mPa.s	1
1	centisokes (cSt)	mm ² /s	1
<i>Multiply By</i>	<i>Into</i> ←	<i>To Convert</i>	

Greek Alphabet

<i>Greek Character</i>	<i>Greek Name</i>	<i>Roman Equivalent</i>
Α α	alpha	A a
Β β	beta	B b
Γ γ	gamma	G g
Δ δ	delta	D d
Ε ε, ε	epsilon	Ē ē
Ζ ζ	zeta	Z z
Η η	eta	Ē ē
Θ θ, θ	theta	Th th
Ι ι	iota	I i
Κ κ, κ	kappa	K k
Λ λ	lambda	L l
Μ μ	mu	M m
Ν ν	nu	N n
Ξ ξ	xi	X x
Ο ο	omicron	Ō ō
Π π, π	pi	P p
Ρ ρ	rho	R r
Σ σ, σ	sigma	S s
Τ τ	tau	T t
Υ υ	upsilon	Y y
Φ φ, φ	phi	Ph ph
Χ χ	chi	Ch ch
Ψ ψ	psi	Ps ps
Ω ω	omega	Ō ō

Index

<u>Index terms</u>	<u>Links</u>
A	
A bands	145
Acesulfame- κ	182
Acetaldehyde	297 303
Acetals	167
Acetic acid	271
Acetophenoses	284
Acetylated sugars	167
Acetylformoin	176
Acetyl glucosamine	172
Achromatic colors	234
Acid detergent fiber	204
Acids	
as acidulants	438
as preservatives	438
Acids, structure and physical properties	438 439
Acidulants, acids	
acetic	438
adipic	438
citric	438
fumaric	438
lactic	438
malic	438
phosphoric	438 444
succinic	438
tartaric	438
Actin	114 144
Active methylene group	59
Active oxygen method	61 67

<u>Index terms</u>	<u>Links</u>		
Actomyosin	28	146	
Acute toxicity	476		
Acyclic aldehyde	165		
Acylglycerols	34		
<i>See also</i> Glycerides			
monoacyl	81	103	104
triacyl. <i>See</i> Triglycerides			
Additives	429		
incidental	449		
intentional	429		
Additives and contaminants	429		
Additives, incidental (contaminants)	449		
antibiotics	460		
asbestos	459		
bacterial and fungal toxins	464		
dioxin	455		
from industry	455		
natural toxins	467		
pesticides	451		
polychlorinated biphenyls	458		
polycyclic aromatic hydrocarbons	463		
radioactive fallout	449		
radionuclides	449		
trace metals	461		
Additives, intentional, classification	431		
<i>See also</i> Food additives			
Additives, intentional, major classes			
acidulants	438		
antimicrobial agents	431		
antioxidants	438		
bleaching agents	438	440	441
bread improvers	441		
coloring agents	445		
emulsifiers	440		
flavor enhancers	442		

Index terms**Links**

Additives, intentional, major classes (<i>Continued</i>)		
flavors	441	
irradiation	446	
nutritional supplements	447	
phosphates	444	
preservatives	431	
spices	442	
sweeteners	443	
Additives, intentional, minor		
classes	449	
anticaking	449	
clarifying agents	449	
firming	449	
glazes	449	
humectants	449	
polishes	450	
propellants	449	
Adenosine triphosphate	29	298
Adhesiveness	313	334
ADI (acceptable daily intake)	434	437
Adipic acid	271	
Adipic anhydride	187	
Adsorption, heat of	11	
Adsorption isotherm	6	28
Aeration	89	
Aftertaste	294	
Agar	200	
Agaricaceae	451	
Agaropectin	201	
Agarose	201	
Agent orange	458	
Aggregated gels	138	
Aggregation, protein	117	
Aglycone	167	
Agreement on Sanitary and Phytosanitary Measures	486	

Index terms**Links**

Agricultural Marketing Service	480	
Agriculture and Agri-food Canada	482	
AH, B theory	269	
Albumins	111	113
Alcoholic beverages	303	
Alcohol, sugars. <i>See</i> Sugar alcohols		
Aldehyde oxidase	221	
Aldehydes	57	
Aldehyde sulfurous acid	434	
Aldehydo-glycerides	59	
Aldoseamine	120	
Aldoses	167	
Aldosylamine	128	
Aldotriose	163	
Aleurone grains	156	
Algin	201	
Alginate	199	
Aliphatic alcohol	51	
Alkali cellulose	203	
Alkaline taste	263	276
Alkaloids	273	305
Alkanones	300	
Allergenicity	476	
Allergenic properties	413	
Allergic reactions	487	
Alliinase	469	
Allium	469	
Alpha amylase	181	
Alpha helix	115	146
Aluminum	223	
Aluminum phosphate	223	
Alzheimer's disease	223	
Amadori rearrangement	120	122 132
Amaranth	446	

Index terms**Links**

Amino acid, composition

beef	113			
casein	121			
corn	113			
egg	113			
gelatin	121	149		
milk	113	139		
millet	113			
peas	113			
rice	113			
serum albumin	121			
sorghum	113			
wheat	113			

Amino acids

111

Amino acids, general

acidic	112			
amides	112			
aromatic	112			
basic	112			
cyclic	112			
essential	111	139		
hydrocarbon	112			
hydroxyl	112			
polar	115			
structure	112			
sulfur	112			

Amino acids, individual

alanine	112			
arginine	112	131		
asparagine	112			
aspartic	112	132		
cysteine	112	121	131	152
cystine	112	121	132	152
glutamic acid	112	132		
glutamine	112			
glycine	112			

Index terms**Links**Amino acids, individua (*Continued*)

histidine	112	132		
hydroxy proline	120			
isoleucine	112			
leucine	112			
lysine	112	120	123	132
	152			
methionine	112	131	132	152
	157			
ornithine	130			
phenylalanine	112			
proline	112	115	120	122
	141			
serine	112			
threonine	112	132		
tryptophane	112	131	132	152
	157			
valine	112			
Amino acids, sulfur	111			
Amino acrylic acid	132			
Amino-nitro-propoxybenzene	267			
Amino-propanol	380			
Amino sugars	167			
Ammonium chloride	441			
Ammonium phosphate	441			
Ammonium sulfate	441			
Amorphous foods	20			
Amphiphilic	134			
Amygdalin	167			
Amylase(s)	139	258	402	
Amyl esters	301			
Amyloglucosidase	259			
Amylopectin	184			
Amylose	184			
Amy lose complexing	105			

<u>Index terms</u>	<u>Links</u>			
Anaphylactic shock	476			
Angle of tilt	88			
Anhydride formation	174			
Anhydro base	255			
Anhydro sugars	167			
Animal depot fat	36			
Animal proteins	138			
Anisaldehyde oxime	269			
Anisidine value	60			
Anisotropic particles	345			
Annatto	252			
Anomers	163			
Anthocyanidins	252			
cyanidin	253	254		
delphinidin	253	254		
destruction	253	255		
lakes	254			
malvidin	253			
pelargonidin	253			
peonidin	253	254		
petunidin	253			
spectrum UV	253			
Anthocyanins	252	295		
Antibiotics	460			
Antibiotics as contaminants				
causing allergies	460			
causing resistant organisms	460			
used in agriculture	460			
Anticaking agents	449			
Antifirming effect	105			
Antimicrobial agents. <i>See</i> preservatives				
Antioxidants	62	386	438	440
ascorbyl palmitate	64			
BHA	62	63		
BHT	62	63		

Index terms**Links**Antioxidants (*Continued*)

chelating agents	438		
enzymic	438		
natural	438		
oxygen scavengers	438		
PG	62	63	
phenolic	438		
spices and herbs	438		
TBHQ	62	63	
tocopherols	62		
Antiparallel hydrogen bonding	270		
Antiparallel sheets	142		
AN/TN ratio	412		
Apo carotenal	251	358	387
Apo carotenoic ethyl ester	358		
Apoenzyme	389		
Apolar molecules	4		
Apparent viscosity	319		
Applesauce	225		
Apricot	246		
Araboxylan	192		
Arachidonic acid	41		
Aroclor	458		
Aroma character	289		
Asbestos	459		
Asbestos			
in filtration beverages	460		
in water supply	460		
Ascorbic acid oxidase	368		
Ascorbic acid	366		
Ascorbic L, acid. <i>See</i> Vitamin C			
Ascorbyl palmitate	365	386	438
Ascorbyl palmitate as synergist	365		
Ashing	209		

<u>Index terms</u>	<u>Links</u>			
Asparagus	226			
Aspartame	182			
Aspergillus flavus	465			
<i>Aspergillus niger</i>	172	402	407	427
	434			
Aspergillus oryzae	404	410	427	
Astaxanthin	251			
Astringency	276	294		
Asymmetric carbon	163	363		
ATP	29	298		
Autoxidation	54			
Avidin	150	385		
Avogadro's number	8			
 B				
β-amino alanine	133			
β-elimination	133			
β-fructofuranosidase	172			
β-furanoside	165			
Bacillus coagulans	427			
Bacillus licheniformis	412			
Bacillus subtilis	404			
Back extrusion	332			
Bacterial growth, a_w	22			
Bacterial toxins	464			
Bacteriocins	437			
as preservative	438			
in milk	438			
natamycin	438			
Nisin	438			
pimaricin	438			
Barbecuing	463			
Barium	140	450		
Bavarian beer purity law	475			

Index terms**Links**

Beans	226		
Beef fat. <i>See</i> Fats and oils, individual			
Beer haze	411		
Bell peppers	306		
Benzidine value	57		
Benzoic acid	432		
Benzoic acid as preservative	432		
Benzopyrene nucleus	256		
Benzoyl peroxide	440	441	
Benzpyrene	463		
Benzyl alcohol	269		
Beryllium salt	266		
Betacyanins	258		
Beta-ionone	251		
Betalains	258		
Betanin	258		
Betaxanthins	258		
BET isotherm	8	9	19
Bifidus factor	172		
Bile acids	51		
Bimolecular lipid layers	104		
Binding energy	3		
Bingham body	324		
Biopolymers	19		
Biotechnology	487		
Biotin	385		
avidin	385		
sources	355	385	
stability	356	385	
structure	385		
Birefringence	185		
Bisulfite	418		
Bitter peptides	300		
Bitter taste	263	273	

<u>Index terms</u>		<u>Links</u>
Bixa orellana	246	
Bixin	244	
Black body	230	
Blanching	360	422
Bleaching	50	
Block copolymer	195	
Blood serum albumin	143	
Bloom	99	
Bond angles	16	
Bonito	280	
Botulinum toxins	464	
Bovine spongiform encephalopathy	484	
Branched chain fatty acids	36	
Branched dextrans	180	
<i>Brassica</i> species	44	
Brassicasterol	51	55
Brazil nut	476	
Bread flavor	297	
Bread improvers	441	
bleaching agents	441	
inorganic compounds	441	
Bread, specific heat	14	
Brevibacterium ammoniagenes	426	
Brittleness	311	334
Brookfield viscometer	329	
Brothy taste	300	
Brownian movement	342	344
Browning, nonenzymatic. <i>See</i> nonenzymatic browning		
Buccal proteins	295	
Buffering capacity	272	
Bulking agent	194	
Bulk sweeteners	183	
Bureau of Alcohol Tobacco and Firearms	480	
Burgers model	323	

Index terms**Links**

Butter	338		
Butter flavor	284	297	
Butter, thixotropic hardness	328		
Butylated hydroxy anisole	62		
Butylated hydroxy toluene	62		
Butyric acid	284		
C			
Cadmium	463		
Caffeine	273	468	469
Calcium	220		
Calcium caseinate phosphate complex	139		
Calcium channels	264		
Calcium-chelate	214		
Calcium saccharate	170		
Calcium sensitive casein	141		
Calcium sulfate	441		
Campesterol	55		
Camphoraceous	287		
Canadian Agricultural Products Act	482		
Canadian food control system	482		
Canadian Food Inspection Agency	481		
Cancer	223		
Candida antarctica	400		
Candida cylindraceae	401		
Canned foods, metal uptake	223		
Canola oil	37	106	
<i>See</i> Fats and oils, individual			
Cantaxanthin	251		
Capillary condensation	12		
Capillary viscometers	330		
Capillary water	7	11	
Capsaicin	276	306	
Capsicum	276		

<u>Index terms</u>	<u>Links</u>
Caramel	259
Caramel color production	259
Caramel flavor	176
Caramelization	127 175
Carbanion	134
Carbinol base	255
Carbohydrates	163
Carbohydrates, classification	163
cellulose	191 206
cyclodextrins	194
dextrins	194
disaccharides	171 182
fiber	203
glycogen	163
gums	197 206
hemicelluloses	191 206
hexoses	165
hydrocolloids	199
lignin	193 206
monosaccharides	163 182
oligosaccharides	169 182
pectins	194 206
pentosans	191
polyols	181
polysaccharides	182 184
starch	179
Carbohydrates, content in foods	164
Carbohydrates, physical properties	
gum gels	197 202
lactose	177 178
pectin gels	206
starch gels	187
starch crystallinity	184
starch paste	187
sucrose	179

<u>Index terms</u>			<u>Links</u>
Carbonates	212		
Carbonic anhydrase	220		
Carbonium ion	256		
Carbon number, glycerides	35	51	
Carbonyls	57		
Carmelan	175		
Carnosic acid	438		
Carnosol	438		
Carotene	245	357	
Carotenoids	244		
annatto	252		
astaxanthin	250		
canthaxanthin	250		
capsanthin	250		
capsorubin	250		
carotene, α , β , γ	245		
cryptoxanthin	250		
in corn	248		
in eggs	246	251	
in milk fat	248		
in oranges	247		
in palm oil	248	252	
in peaches	247		
in salmon	246		
in tomatoes	246		
isozeaxanthin	250		
lutein	250		
lycopene	245	249	251
physalien	250		
stability	251		
synthetic	251		
torularhodin	250		
zeaxanthin	249	250	
Carrageenan	199	201	
Carrots	244		

<u>Index terms</u>	<u>Links</u>		
Carry-through properties	62		
Carvacrol	305		
Carvone	268	305	
Casein	119	139	413
<i>See also</i> Proteins, casein			
Casein, α , α_3 , α_{S2} , κ	141	409	
Casein, genetic variants	141		
Caseinate agglomeration	202		
Caseinate particles, stability tests	213		
Caseinates	143		
Casein hydrolysates	413	414	
Casein micelle	140	141	
Casson model	319		
Catalase heat stability	418		
Catalyst	71		
Catalysts, hydrogenation. <i>See</i> Hydrogenation, fats			
Catalysts, interesterification	80		
Catecholase activity	415		
Celery	284		
Cellobiose	172	191	
Cellular structure	340		
Cellulose	191		
crystallinity	191		
modified	199	203	
molecular weight	191		
molecule	191		
Cephalin	52		
Ceramides	52		
Cereal germ oils	364		
Cereal proteins	112		
Cesium	137	450	
Chain elongation	35		
Chain fission	59		
Chain reaction	56		

<u>Index terms</u>	<u>Links</u>		
Chain shortening, fatty acids	35		
Chalcones	255		
Charcoal broiling	463		
Charge frequency	136		
Cheese flavor	300		
Chelates	210		
Chemisorption	73		
Chemoreceptor	287		
Chernobyl	451		
Chewiness	313	334	
Chicken fat	39		
Chilies	306		
Chiral	45		
Chiral center	363	364	
Chlorine	441		
Chlorine bleaching	458		
Chlorine dioxide	441		
Chlorophyll	26	242	
Chlorophyllase	243		
Chlorophyllin	243		
Chloroplastids	242		
Chocolate	48	95	343
Chocolate aroma	285		
Chocolate microstructure	343		
Chocolate milk	202		
Cholecalciferol	361		
Cholesterol	51	53	54
Cholesterol acetate	53		
Cholesterol esters	53		
Chondrus crispus	201		
Chroma	236		
Chroman ring	364		
Chromaticity coordinates	232		
Chromatogram	39	41	

<u>Index terms</u>	<u>Links</u>		
Chromen sulfonic acid	255		
Chromium	219		
Chromium intake	223		
Chromoproteins	114		
Chronic toxicity	476		
Chrysotile asbestos	460		
CIE system	229		
Cinnamaldehyde	305		
<i>cis-cis</i> -1,4 diene system	68		
Citral	301		
Citrates	212		
Citric acid	271	365	370
Citric acid as synergist	365		
Citronellyl acetate	301		
Citrus flavor	300		
Citrus fruit	246		
Clarifying agents	449		
Clathrates	4		
Clausius Clapeyron law	10		
Clostridium botulinum	436	464	
Cloud separation	405		
Clupein	114		
Coating fats	100		
Cobalt	219	220	
Coccarboxylase	372		
Cocoa butter	45	81	95
isosolids blends	100	101	
polymorphism	99		
solid fat profiles	102		
Cocoa butter equivalents	99		
Cocoa butter improvers	99		
Cocoa butter substitutes	99		
Coconut. <i>See</i> Fats and oils, individual			
Coconut oil	34		

<u>Index terms</u>	<u>Links</u>		
Codex Alimentarius	484		
Cadmium contamination in crustaceans	463		
Coenzyme	355		
Coenzyme A	384		
Cofactor	389		
Coffee	301		
Coffee flavor	301		
Cognac	303		
Cohesion	311		
Cohesiveness	333		
Collagen	114	147	148
Colloidal dispersions	342		
Colloidal particles	212		
Colloids	342		
anisotropic particles	345		
definition	342		
dimensions	344		
particle size	342	345	
Color	229		
beets	258		
Cabernet Sauvignon grapes	253		
corn	248		
crude palm oil	238		
eggs	246	251	
fruits	254		
honey	235		
maple syrup	235		
meat	240	242	243
milk fat	248		
oranges	247		
paprika	252		
peaches	247		
raspberries	253		
red fish	251		
salmon	246		

<u>Index terms</u>	<u>Links</u>			
Color (<i>Continued</i>)				
tomato	246	251		
vegetables	254			
Colorants	239			
Colorants not requiring certification	260			
Colorants, synthetic	260			
Color difference	238			
Coloring agents	445			
Coloring agents, additives	446			
FD&C colors	446			
lakes	446			
nature-identical	446	447		
permitted	446			
synthetic dyes	446			
Color measurements				
chromaticity coordinates	232			
CIE system	229	233	235	
complementary	234			
gloss	239			
Hunter	229	232	237	238
Lovibond	229	238		
Munsell	229	236		
primary colors	231			
spectrophotometry	229	230		
tristimulus values	232			
wavelength	234			
Color, pigments				
anthocyanins	252			
benzopyran	239			
betalains	258			
caramel	259			
carotenoids	244			
chlorophylls	241	244	245	
cholemyoglobin	242			
dyes	260			

Index terms**Links**

Color, pigments (<i>Continued</i>)		
flavonoids	252	
from artifacts	239	
hemoglobin	240	241
isoprenoid	239	
myoglobin	240	241
nitrosohemochrome	242	
nitrosomyoglobin	242	
not requiring certification	260	
oxymyoglobin	240	241
pheophytins	243	
sulfmyoglobin	242	
synthetic	260	
tannins	257	
tetrapyrrole	239	240
titanium dioxide	260	
xanthophylls	244	251
Color purity	234	
Color rendition	230	
Color triangle	231	
Complementary colors	234	
Complex ions	213	
Complex light types	230	
Component fatty acids	36	
Composite foods, a_w	27	
Compression cell	333	
Compression force	316	
Conalbumin	150	
Confectionery fats	94	95
Configurations, sugars		
aldoses	173	
Fischer formula	163	
Haworth formula	163	
tautomeric forms	166	
Congeners	458	

<u>Index terms</u>	<u>Links</u>		
Conglycinin	159		
Coniferaldehyde	304		
Coniferyl alcohol	193		
Conjugase	382		
Conjugated dienes	59	74	
Conjugated double bonds	244		
Conjugation	58		
Connective tissue	147		
Consistency	41	76	311
Consumer Packaging and Labeling Act	482		
Contaminants	429		
<i>See also</i> Additives, incidental			
Continuous phase	101		
Contractile elements	145		
Contraction	147		
Contributory flavor compounds	289	297	
Cooked flavor	142		
Cooling effect	96		
Coolness	84	263	276
Coordination bonds	240		
Copolymerization	424		
Copper	219	220	
Coprecipitates	143		
Corn oil. <i>See</i> Fats and oils, individual			
Corn starch	183		
Corn sweeteners	179		
Corn syrup	179		
Corrosion of tin cans	371		
Corynebacterium acnes	401		
Cottonseed oil. <i>See</i> Fats and oils, individual			
Cottonseed protein	113		
Coumaryl alcohol	193		
Covalent bonds	346		
Creep curve	320		

<u>Index terms</u>	<u>Links</u>		
Cresolase activity	415		
Creutzfeldt-Jakob disease	484		
Critical nucleation temperature	17		
Crocetin	244		
Cross bonding of starch	187	340	
Crosshead, texture measurement	332		
Cross linking	424		
Cross striation	144		
Cruciferae	268		
Crucifera oils	43		
Crustacea	50		
Cryoprotection	20		
Cryptoxanthin	247	358	
Crystal growth water	16	19	
Crystallization, fats	84		
crystal polymorph	86	87	88
crystal formation	88		
crystal size	85		
latent heat	82		
nucleation	84		
super cooling	84		
Crystallization, sugars	176		
lactose	177		
sorbitol	183		
sucrose	176	177	
Crystallization velocity, water	17		
Crystal size of fats	85		
Crystal structure, fats	86		
cocoa butter	99		
double chain	92		
hydrogenated palm oil	94		
hydrogenated sunflower oil	90		
long spacings	89		
melting points, polymorphs	89		
palm oil triglycerides	93		

Index terms**Links**

Crystal structure, fats (<i>Continued</i>)		
PEP	92	93
polymorphism	86	
hexagonal (α)	88	90
orthorombic (β')	88	90
transition	89	92
triclinic (β)	88	90
PSP	92	93
short spacings	88	
triple chain	92	
Crystal structure, water	15	17
Cubic phase	104	
Cubic structure, water	16	
Cucumbers	297	
Cuminaldehyde	305	
Cutin	203	
Cyanidin	253	
Cyanocobalamine	380	
<i>See also</i> Vitamin B ₁₂		
Cyanogenic glycosides	468	
Cyclic diketones	302	
Cyclic monomeric glycerides	68	
Cyclic monomers	69	
Cyclodextrins	194	
Cyclohexylamine	443	
Cyclopentenyl ring	69	
Cysteine sulfoxides	469	
Cytochrome C reductase	375	
Cytochrome oxidase	368	
D		
Dashpot in texture	322	
Decadienal-2,4	59	
Deep frying fats	66	
<i>See also</i> Fat, deep frying		

<u>Index terms</u>	<u>Links</u>	
Deformation in texture	311	316
Dehydrated foods	21	27
Dehydro-ascorbic acid	367	
Dehydrocholesterol	361	
Dehydro retinol	359	
Delaney clause	431	475
Delphinidin	253	
Denaturation	117	
Dental health	221	
Denture tenderometer	333	
Deodorization, oils	50	66
Deoxynivalenol	467	
Deoxyosulose	126	
Deoxyribonucleic acid	167	
Deoxyribose-2	167	
Deoxy sugars	167	
Derived lipids	33	
Desaturation, fatty acids	35	
Desorption, hydrogenation fats	73	
Desorption isotherm	6	
Detinning	463	
Dextrinization	189	
Dextrose equivalent	179	
DHA	401	
Diabetic foods	168	
Diacetyl	303	
Diamino sugar	120	
Diels-Alder reaction	68	
Dienal-2,4	297	
Dietary fiber	203	206
definition	206	
methods	206	
Differential scanning calorimetry	88	311
Diffused reflection	239	

<u>Index terms</u>	<u>Links</u>			
Dihydroperoxides	59			
Dihydropyrazines	286			
Diisopropylphosphorofluoridate	410			
Diketo gulonic acid	367			
Dilatancy	318			
Dilatometry	83			
Dillapiol	305			
Dimethyl mercury	461			
Dimethyl nitrosamine	436			
Dimethyl sulfide	297	299		
Dioxin	455			
Dioxin, contaminants	455	458		
from agent orange	458			
from combustion	458			
from herbicides	458			
from packaging	458			
from pulp and paper	458			
Dioxygenase	358			
Diphenols	414			
Directed interesterification	77			
Disaccharides				
cellobiose	171	172		
lactose	170	171	177	178
maltose	170	171		
melibiose	170			
sucrose	170	171	177	178
Disperse phase	101			
Disperse systems	311			
Distarch adipate	187			
Distarch phosphate	187			
Distilled monoglyceride	81			
Distribution coefficients	232			
Disulfide bonds	111	154	373	
Docosahexaenoic acid	37			

Index terms**Links**

Dominant wavelength, color	234		
Domoic acid	469		
Double bond migration in fatty acids	73		
Double chain length, X-ray diffraction	89		
Double helix	146		
Double helix in starch	185		
Dough	154	193	335
Drip loss, meat	18	214	
Dulcin	267		
Dynamic testing, texture	326		
Dynamic viscosity	318		
E			
EDTA	438		
Effective dose, in toxicity	478		
Egg protein	112	150	
Egg white lysozyme	142		
Egg yolk	42	251	
Egg yolk fat. <i>See</i> Fats and oils, individual			
Eicosapentaenoic acid	37		
Einstein equation	344		
Elaidic acid	34	92	
Elastic body	320		
Elasticity, texture	313		
Elastin	114		
Electron microscopy	156	311	
Electrophoresis	113		
Electroplating	220		
Ellagic acid	257		
Ellagitannins	257		
Emulsification	134		
Emulsifiers	440		
fatty acid esters	441		
HLB	441		

Index terms**Links**

Emulsifiers (<i>Continued</i>)			
hydroxylated lecithin	440		
monoglycerides and esters	441		
polyglycerol esters	441		
Emulsifiers, nonionic	104		
atmul	104		
myrj	104		
span	104		
tween	104		
Emulsion destabilization	18		
Emulsion flocculation	346		
Emulsions	101		
Emulsion stability	137		
Enal-2- <i>trans</i>	297		
Enantiomer	45	47	
Endo- α -amylase	179		
Endothia parasitica	409		
Enediol	174		
Enolization	123	174	
Enrichment Fe	220		
Entanglement	339		
Entrainment	95		
Entropy	3		
Enzymatic activity, a_w	22		
Enzymatic antioxidant superoxide dismutase	438		
Enzymatic browning, flavonoids	256		
Enzyme activity	21	23	24
Enzyme classification	394		
Enzyme deactivation	389		
Enzyme immobilization methods	425		
Enzyme kinetics	393		
Enzyme positional specificity	397		
Enzyme reactors	425		

Index terms**Links**

Enzymes	389			
acid protease	408			
aldehyde oxidase	221			
alkaline phosphatase	423			
alliinase	469			
amino peptidase	412			
amylase	139	390	396	402
amylase α (endo)	179	181	259	
amyloglucosidase	181	259		
ascorbic acid oxidase	368	392		
carbonic anhydrase	220			
carboxypeptidase	408	412		
catalase	392	396	417	437
cellulase	390	396		
chlorophyllase	243			
chymosin	409			
chymotrypsin	408	410		
cocarboxylase	372			
coenzyme A	384			
coenzyme FAD	374			
coenzyme FMN	374			
cytochrome C reductase	375			
cytochrome oxidase	368			
dextran, sucrase	390			
elastase	410			
esterase	397			
ficin	411			
fumarase	426			
galactosidase	171	404		
glucoamylase	404			
glucose isomerase	180	396	426	427
glucose oxidase	392	396	416	
glucosidase, β	191			
glycosidase	396			
glycosyl transferase	194			
hydrolases	395			

Index terms**Links**Enzymes (*Continued*)

invertase	390			
lactase	171	390	396	404
	427			
lactoperoxidase	419	437		
lipase	391	396	400	401
lipoxydase	243			
lipoxygenase	392	419		
lysozyme	115			
naringinase	390			
nuclease	391			
oxidoreductase	413			
pancreatic lipase	398			
papain	396	411		
pectate lyase	405			
pectic	390	396	405	
pectin esterase	405			
pectin methyl esterase	394			
pentosanase	390			
pepsin	408			
peroxidase	139	368	391	418
	423			
phenolase	368	413		
phosphatase	139	389	391	
polygalacturonase	405			
polymethyl galacturonase	406			
polyphenolase	220	371		
polyphenol oxidase	392	413		
pregastric esterase	399			
proline specific peptidase	394			
prorennin	408			
protease	391	408		
proteolytic	115			
pullulanase	181			
rennin	389	396		
serin protease	410			

Index terms**Links**

Enzymes (<i>Continued</i>)			
subtilisin	410		
sulfhydryl protease	411		
sulfite oxidase	221		
superoxide dismutase	438		
tannase	390		
thiaminase	392		
thrombin	410		
<i>trans</i> -eliminase	406		
trypsin	396	408	410
xanthine dehydrogenase	221		
xanthine oxidase	139	221	422
Enzymes groups			
amylases	402		
esterases	397		
hydrolases	395		
lipoxygenases	419		
oxidoreductases	413		
pectic	405		
proteases	408		
Enzymes in food processing	390	396	
Enzyme sources	408		
Enzyme specificity	394	399	400
Epoxide	363		
Equal point	233		
Equatorial hydroxyl	164		
Equilibrium relative humidity	4		
Equivalency	488		
Ergocalciferol	361		
Ergosterol	361		
Erucic acid	37	43	
Erythorbic acid	211	367	438
Escherichia coli	426	434	
Essential amino acids	111	139	
Essential oils	304	441	

Index terms**Links**

Ester interchange, interesterification	77		
Ester phosphate	142		
Ethereal	287		
Ethoxy hexadiene	433		
Ethyl decadienoate	301		
Ethylene	418		
Ethyl sorbate	433		
Eugenol	305		
Euglobulin	142		
European Commission	482		
European Council	482		
European Parliament	482		
European Union			
decisions	483		
directives	483		
food laws	482		
recommendations	483		
regulations	483		
Eutectic	99		
Evaporated milk	372		
Even distribution, glycerides	47		
Evening primrose oil	43		
Excitation purity	234		
Extensigraph	336		
Extractives, natural	441		
F			
Fabricated foods	33		
F-actin	146		
FAO	484		
Farinograph	335		
Fat content	33		
Fat crystallization	15		
Fat crystal network	339	347	348

<u>Index terms</u>	<u>Links</u>		
Fat, deep frying	65		
chemical reactions	68	69	
free fatty acid	66		
oxidation	66		
polymerization	70		
stability of oils	67	69	
<i>trans</i> -formation	66	68	
Fat, hydrogenation	71		
<i>See also</i> Hydrogenation, fats			
Fat microstructure	346		
Fat, oxidation	54		
aldehyde formation	59	60	68
autoxidation	54		
during frying	66		
free radical	59	61	
hydroperoxide formation	58	60	61
light induced	65		
lipoxygenase	62		
oxidized flavor	70	72	
peroxide formation	61		
photooxidation	63		
products	59	68	72
sensitizers	64		
singlet oxygen	63	65	
Fat plasticity	339		
Fat replacers			
olestra	107		
salatrim	107		
Fats and oils	33		
content in foods	35		
Fats and oils, classes			
fruit coat	34	37	
kernel	34		
mammary depot	34	38	

Index terms**Links**Fats and oils, classes (*Continued*)

marine	34	37	44	45
	48	53	77	
milk fat, ruminant	34	37	40	52
	55	94		
seed oils	34	37		

Fats and oils, individual

canola	37	44	46	67
	69	93	106	
chicken	39	49		
cocoa butter	42	46	49	50
	55	69	83	85
	96	99	102	
coconut	42	45	47	55
	94			
corn	53	55	56	66
	69	93		
cottonseed	46	55	69	73
	93			
egg yolk	42	45		
evening primrose	43			
heated	65			
herring	55			
human	38			
lard (pig)	39	48	53	55
	57	63	69	94
	96			
linseed	53	56		
menhaden	44			
mustard	42	44	46	107
novel	106			
olive	42	46	53	56
	69	93		
palm kernel	42	45	47	69
	94	102		
palm oil	42	46	69	93
	94	95	97	

Index terms**Links**Fats and oils, individual (*Continued*)

palm olein	69	97		
palm stearin	69	97	102	
peanut	46	56	69	73
	93			
rapeseed	37	42	44	46
	53	55	56	77
replacer	107			
rice bran	46			
safflower	42			
sesame	43			
sheep	39	40		
soybean	37	42	44	46
	53	55	67	69
	93			
soybean, low linoleic	37			
sunflower	46	67	69	90
	106			
tallow (beef)	39	53	55	69
	84	94		
teaseed	53			
turkey	39			
vegetable	42			
Fats, texture	337			
Fat texture, effect of				
crystallization temperature	337			
temperature treatment	337			
Fatty acid composition				
canola	46			
cocoa butter	46			
coconut	47			
cottonseed	46			
egg yolk	45			
fish oils, blue whiting	45			
capelin	45			
dog fish	45			

Index terms**Links**

Fatty acid composition (<i>Continued</i>)				
menhaden	44			
saith	45			
sprat	45			
milk fats, bovine	40			
goat	40			
sheep	40			
mustard	46			
olive	46			
palm	46			
palm kernel	47			
peanut	46			
rapeseed	46			
rice bran	46			
soybean	46			
sunflower	46			
Fatty acid methyl ester	79			
Fatty acids	33	110		
ante-iso	39			
arachidonic	38	41	60	
branch chain	36			
conjugated	58	59	66	68
	74			
cyclic	71			
DHA	37	38	41	
elaeostearic	38			
elaidic	38			
Environmental Protection Agency	37	38	41	77
erucic	37	38		
even carbon	36			
gadoleic	38			
hydrogenated	36			
hydroxy	36			
iso	39			
isomers	36	39	40	43
	75			

Index terms**Links**

Fatty acids (<i>Continued</i>)				
isomers- <i>cis</i>	43	75		
isomers-geometric	73			
isomers-positional	73			
isomers- <i>trans</i>	43	58	66	68
	73	75		
keto	39			
linolenic	38	58	60	65
linolenic γ	38	43		
long chain	36			
medium chain	36	44		
multibranched	39			
myristoleic	38			
nomenclature	35			
odd carbon	36			
oleic	36	38	60	
palmitic	36	38		
palmitoleic	38			
petroselinic	38			
polyunsaturated	41			
saturated	58			
short chain	36			
stearic	36			
unconjugated	43			
unsaturated	35			
vaccenic	38			
FD & C colors	260	446		
Federal Food Drug and Cosmetic Act	475	479		
Fehling solution	169			
Ferrous sulfate	220			
Fiber	203			
analysis	203			
bulking capacity	206			
components	205			
crude fiber	203			
dietary	203			

<u>Index terms</u>	<u>Links</u>
Fiber (<i>Continued</i>)	
sources	204 205
total dietary	203 205 206
Fibrillar proteins	144
Film formation	200
Filtration of beer	460
Firming agents	449
Firmness, texture	311
Fish	
flavor	299
liver oil	357
protein	131 149
actin	150
actomyosin	150
concentrate	150
myosin	150
tropomyosin	150
Fisher formula	163
Fisheries and Oceans Canada	482
Fish Inspection Act	482
Flatulence	172
Flavin adenine dinucleotide	374 416
Flavin mononucleotide	374
Flavonoids	134 252 415
hesperidin	257
quercetin	256
structures	256
Flavor	263
analysis	291
astringency	276 294
bitter taste	263 273 275 295
chemical structure and taste	266
description	291 295
enhancements	278
enhancers	442

Index terms**Links**Flavor (*Continued*)

interrelationships of taste	275		
odor	282		
odor and molecular structure	283		
odor description	289		
off-flavor	291	296	
of foods	297		
potentiation	279		
profile method	292		
receptor mechanism	263	264	
release	84		
reversion	54	70	71
salty taste	263	272	273
sour taste	263	270	
sweet taste	263	268	
taste	263		
theories of olfaction	287		
threshold	59		
Flavor, additives	441		
artificial	442		
natural	441		
nature identical	442		
Flavor compounds and description			
alcoholic beverages	303	304	
bread	297		
cheese	300		
coffee	301	304	
dairy products	296	297	
fish	299		
fruit	300		
margarine	295		
meat	298		
milk	300		
spices and herbs	304		
tea	301		
unsaturated aldehydes	294		

Index terms**Links**Flavor compounds and description (*Continued*)

vanilla	306			
vegetables	301			
wine	292	293		
Flavor enhancer, additives	442			
ibotenic acid	442			
L-theanine	442			
MSG	442			
nucleotides	442			
tricholomic acid	442			
Flavor enhancers	278			
characteristics	278			
glutamic acid	278			
ibotenic acid	281	282		
maltol	281			
MSG production	279			
nucleotides	280			
synergistic effect	280			
tricholomic acid	281	282		
Umami	278			
Flavylium	252			
Flocculation	18	117		
Floral	287			
Flour enrichment	488			
Flow	311			
Fluidity	187			
Fluorescence	64	126	128	374
	376			
Fluorescent light	230			
Fluorine	219			
Foaming	134			
Folacin. <i>See</i> Folic acid.				
Foliar penetration	220			
Folic acid (folacin)	382			
sources	355	382		

Index terms**Links**

Folic acid (folacin) (<i>Continued</i>)			
stability	356	383	384
structure	382		
Food additives	429		
Food additives, regulations			
Delaney clause	431		
definition	429	480	
food additives	430	480	
GRAS	430	480	
nondeceptive	430	431	
prior approval	430		
purposes	431		
Food and Nutrition Service	480		
Food irradiation	446		
Food Safety and Inspection Service	480		
Food simulants	448		
Food supplements	477		
Formic acid	61		
Fortification	374		
Fortification of cereal grain products	376		
Fractionation, fats	94		
dry	94		
milk fat	49	94	
multistage	98		
palm kernel oil	102		
palm oil	98		
solvent	90	94	96
tallow	94		
Fracture resistance	344		
Free energy of adsorption	288		
Free radical	56	59	
Freeze drying	15		
Freezing	14	18	
Freezing, sucrose solution	18		
Fructooligosaccharides	172		

<u>Index terms</u>		<u>Links</u>
Fructose	167	
Fruit		
brandies	303	
coat fats	34	
flavor	300	
freezing expansion	18	
mineral content	219	
puree	329	
Frying	65	
Fumaric acid	75	
Functional foods	477	
Functionality	87	134
Functional properties of proteins	111	
Fungal toxins	464	
Furanones	286	
Furanose ring	163	
Furans	302	
Furcellaran	199	
Furda method	205	
Furfural	367	
Fusarium	467	
Fusel alcohols	303	
G		
GAB sorption isotherm	8	
G actin	146	
Galactans	192	
Galacto-mannoglycan	200	
Galactopyranose	195	
Galacturonic acid	195	405
Gallic acid	257	
Gallotannins	257	
Gamma linolenic acid	43	
Garlic flavor	301	

<u>Index terms</u>	<u>Links</u>			
Gas liquid chromatography	41	44	285	291
GATT	486			
Gelatin gels	137			
Gelatinization temperature	185	340		
Gelatin types, commercial	149			
Gel electrophoresis	153			
Gel formation	147	149	152	180
	187	347		
Gels	117	138		
Genetic engineering	67	106		
Genetic toxicology	476			
Genetic variants	140			
Gentiobiose	167	175		
Geometrical characteristics	313			
Geotrichum candidum	400	402		
Geranium off-odor	433			
Geranyl geraniol	54	56		
Germination	404			
Gibbs-Donnan equilibrium	216			
Ginger	276	305		
Gingerol	305			
Glass transition	18	19	20	130
	179			
Glass transition temperature	19	20	21	179
	181			
Glassy lactose	177			
Glazed pottery	463			
Glazes	449			
Gliadin	111	114	154	
Globulins	111	114		
Gloss	99	239		
Glucitol	168			
Glucono delta lactone	160			
Glucopyranosides	270			

<u>Index terms</u>	<u>Links</u>		
Glucosamine	151		
Glucosan	175		
Glucose-6-phosphate	186		
Glucose isomerase	180		
Glucose sulfurous acid	434		
Glucose syrup	179		
Glucose units	402		
Glucosinolates	44	469	
Glutamates	442		
Glutamic acid taste	278		
Glutelin	111	114	154
Glutelin subunits	156		
Gluten	153		
Gluten-sorption isotherm	9		
Glyceraldehyde	163		
Glyceride composition			
canola	93		
corn	93		
cottonseed	93		
interesterification	79		
milk fat	51		
monoglycerides	81		
natural fats	45		
olive	93		
palm oil	93	98	
palm olein	98		
peanut	93		
racemic mixture	45		
random	45	47	48
soybean	93		
sunflower	93		
tripalmitin	91		
Glycerides	34		
Glyceride structure	45		
Glycerol esters	34		

<u>Index terms</u>	<u>Links</u>
Glycinin	114
Glycogen	190
Glycogen granules	145
Glycomacropeptide	409
Glycophore	270
Glycoproteins	114
Glycosides	167 273
Glycosylamine	120
Goiter	221
Goitrin	268
Goitrogens	468
Good manufacturing practice	30
Gouda cheese	435
Graininess	88
Grapefruit juice	225
GRAS list	430 480
Green pepper	285
Grit cells	418
Groundstate oxygen	63
Growth hormones	487
Guanylate	280
Guar gum	199
Gum arabic	200
Gumminess	313 334
Gums	197
algin	201
arabic	200
carrageenan	199 201 202
guar	200
locust bean	200
modified celluloses	203
Gymnemagenin	277

Index terms**Links****H**

HACCP	484		
Half-life	449		
Hardness	311		
Hardstock	81		
Harmonization	488		
Haworth formula	163		
Hazard	430	478	
Health Canada	482		
Heat denaturation	117		
Heated fats	65		
Heat of sorption	11	12	
Heavy metal salts	266		
Helix formation in starch	184		
Hemagglutination	150		
Heme pigments	220		
Hemiacetal	163		
Hemicelluloses	191		
Hemochrome	242		
Hemoglobin	240		
Henderson-Hasselbach equation	212		
Herbicides	458		
Herbs	304		
Hershel-Bulkley model	319		
Hesperidin	167	257	274
Heterocyclic compounds	163		
Heteropolysaccharides	192		
Hexadienoic acid	432		
Hexagonal crystal structure	88		
Hexahydroxydiphenic acid	257		
Hexenal	71		
Hexenoic acid	433		
Hexenol	284	422	
Hexitols	168		

<u>Index terms</u>	<u>Links</u>	
Hexoses	165	
Heyns rearrangement	122	
High erucic rapeseed oil	77	
High fructose corn syrup	180	426
High lysine corn	156	
High melting glycerides	89	
High oleic sunflower oil	67	106
Hilum	185	
Histidine	299	
Histones	114	
HLB	440	
Holoenzyme	389	
Honey, color	235	
Hooke's law	321	
Hordenin	114	
Horizontal regulations	483	
Hormones	51	
Hot break method	406	
Hotness	263	276
HTST pasteurization	406	
Hudson equation	173	
Hue	234	236
Human fat. <i>See</i> Fats and oils, individual		
Humectants	449	
Humin	176	
Hunter system of color	237	
Hydrides	3	
Hydrocarbons	51	56
Hydrochloric acid	271	
Hydrocolloids	199	
agar	199	200
application	199	
carboxy methy cellulose	199	
function	199	

<u>Index terms</u>	<u>Links</u>		
Hydrocolloids (<i>Continued</i>)			
gums	197		
pectins	196		
Hydrogenated fats, texture	337		
Hydrogenated starch			
hydrolyzates	182		
Hydrogenation	66	71	
Hydrogenation, fats	71		
canola oil	78		
catalysts	71	76	100
CBS	100		
cottonseed oil	73		
fish oils	77		
frying fats	67		
liquid oil polymorphism	93		
nonselective	72	73	77
olefinic compounds	74		
palm kernel oil	102		
palm oil	93	94	
peanut oil	73		
pressure	72	73	
rapeseed oil	77		
selective	72		
soybean oil	76		
temperature	72	73	
<i>trans</i> -formation	73	77	
Hydrogen bonds	2	3	15
Hydrogen peroxide	437		
Hydrogen sulfide	299		
Hydrolysis, a_w	22		
Hydrolytic reactions	22		
Hydrophile-lipophile balance	103		
Hydrophobic bonds	4		
Hydrophobic interaction	115	346	
Hydrophobicity	117	136	274

<u>Index terms</u>	<u>Links</u>		
Hydrostatic compression	316		
Hydrotactoid	4	6	
Hydroxy benzoic acid	432		
Hydroxy fatty acids	36		
Hydroxylated lecithin	440		
Hydroxymethyl-furfural	123	126	298
Hydroxyproline	111		
Hydroxypropyl starch ether	188		
Hygroscopicity	6	26	
Hypobromite	149		
Hypochlorite	189		
Hypoxanthine	299	422	
Hysteresis	8	11	
H zone	145		
 I			
Ibotenic acid	281	442	
Ice	1		
coefficient of thermal expansion	2		
density	2		
heat capacity	2		
heat of fusion	2		
heat of sublimation	2		
lattice structure	14	16	
specific heat	2		
vapor pressure	2		
Ice cream	372		
Ice crystal size	17		
Ice-like cluster	16		
Ice, physical properties	2		
Ice, structure	14		
Ideal solubility	95		
Illipe butter	100		
Immobilized enzymes	423		

<u>Index terms</u>	<u>Links</u>			
Immobilized lipase	402			
Immune globulins	138	142		
Indole acetic acid	418			
Induced dipole effect	184			
Induction period, fat oxidation	57	64		
Industry Canada	482			
Information theory	287			
Inherent stability	67			
Inhibitors	130			
Initiation	56			
Ink bottle theory	10	11		
Inosinate	280			
Inosine monophosphate	298			
Inositol	218			
Inositol hexaphosphoric acid	217			
Insoluble dietary fiber	204			
Interesterification	77			
catalyst	79			
directed	77			
enzymatic	81			
glycerol	81			
palm kernel oil	81			
palm oil	82			
palm stearin	81			
randomization	78	79	82	96
Interfacial loading	137			
Interfacial tension	101			
Intermediate moisture foods	21	30		
International Units	358			
Invert sugar	171			
Invisible fat	33			
Iodine	219	131	450	133
	450			
reaction	184			
value	40	95		

<u>Index terms</u>	<u>Links</u>			
Ionic equilibria	215			
Ionone ring	358			
Iron	219	220		
Iron bioavailability	211			
Irradiated yeast	362			
Irradiation	446			
<i>See also</i> Food irradiation				
unit of radiation	446			
Irreversible deformation	316			
Isobetanin	258			
Isobutanol	339			
Isoelectric focussing	153			
Isoelectric point	138	157		
Isoelectric point, meat	213	215		
Isomaltol	286			
Isomaltose	180			
Isomenthol	276			
Isomeric fatty acids	34	36	39	40
	43	58	66	68
	73			
Isomerization	81	174		
Isoprebetanin	258			
Isoprenoid side chain	362			
Isosacchrosan	175			
Isosolids diagram	99			
Isothiocyanates	77	469		
Isotropic I bands	145			
Isovalerate	301			
J				
Just noticeable difference	266	289		
K				
Keratin	114	152		
Kestose	172			

<u>Index terms</u>	<u>Links</u>			
Ketones	59			
Ketosamine	120			
Ketoses	167			
Kinematic viscosity	318			
 L				
Lachrymatory factor	301	469		
Lactalbumin	138	142		
Lactase	171			
Lactic acid	271			
Lactitol	182			
Lactobacillus casei	382			
Lactococcus lactis	437			
Lactoglobulin	114	138	142	
Lactones	284	297	301	367
Lactose	17	171		
Lactose β -anhydride	177			
Lactose α -hydrate	177			
Lactose, physical properties	177			
Lakes	254	446		
Lamellar units	86			
Laminaria japonica	279			
Langmuir equation	7			
Lanthionine	438			
Lard	34	48	81	
Lard stearin	98			
Latent heat of crystallization	82			
Laurate canola	106			
Laurie oils	44	94		
LD ₅₀	476			
Lead	220	462		
Lead acetate	266			
Lead and tin contamination				
acid food	463			

Index terms**Links**

Lead and tin contamination (<i>Continued</i>)			
detinning of cans	463		
equipment	462		
gasoline	462		
tin cans	462		
Leaf proteins	152		
Leathery state	349		
Lecithin	52	440	
Legumelin	114		
Leucosin	114		
Leukotrienes	41		
Levogluconan	174	175	
Levulosan	175		
Lewis acid and base	210		
Ligand	210		
Light effect	371		
Light exposure	360		
Lightness	234		
Light sensitive receptors	237		
Light sources	229		
Lignin	193	304	306
Limit dextrin	403		
Limonene	301		
Lineweaver-Burke equation	393		
Linoleic acid oxidation	58		
Linseed oil	38	53	56
Lipase	81		
Lipid oxidation	22	25	
Lipid oxidation, a_w	22		
Lipid peroxides	360		
Lipids	33		
definition	33		
interrelationship	34		
milk	43		

<u>Index terms</u>	<u>Links</u>	
Lipids (<i>Continued</i>)		
nonpolar	101	
phospholipids	50	103
polar	101	
Lipoproteins	114	
Lipovitellenin	152	
Lipovitellin	152	
Lipoxydase	243	419
Lipoxygenase	62	
Liver necrosis	221	
Local isotherm	26	
Locus	233	
Locust bean gum	199	
Long spacing, X-ray diffraction	89	
Loosely bound water	11	
Loss modulus	326	
Lovibond system of color	238	
Low acid foods	30	
Low density lipoprotein	133	
Low linolenic canola oil	106	
Low linolenic linseed oil	106	
Low linolenic soybean oil	106	
Low methoxyl pectin	405	
Lumichrome	371	376
Lumiflavin	376	
Luminosity curves	230	
Lutein	248	
Lycopene	245	
Lysine	130	
Lysine loss	24	
Lysine loss in proteins of		
cottonseed	123	
fish	123	
maillard reaction	120	

Index terms**Links**Lysine loss in proteins of (*Continued*)

milk	123		
peanut	123		
plasma albumin	132		
wheat	123		
Lysinoalanine	133		
Lysosomes	145		
Lysozyme	150		
 M			
Mackarel	50		
Macrocyclic ketones	284		
Macrocystes pyrifera	201		
Magness-Taylor pressure tester	330		
Maillard reaction	120	128	260
<i>See also</i> Nonezymatic browning			
Maize, proteins	154		
glutenin	154		
zein	154		
Malic acid	370	426	
Malolactic fermentation	272		
Malting of barley	411		
Maltodextrins	179		
Maltol	281	286	302
Maltose	171		
Malvidin	253		
Mammal depot fat	34		
Manganese	219		
Mannans	192		
Mannitol	182		
Maple syrup, color	235		
Margarine	17	17	338
crystal structure	89	90	94
no <i>trans</i>	95		
texture	337	338	343

<u>Index terms</u>	<u>Links</u>		
Marine oils	34		
Mass spectrometry	285	291	
Matrix protein	156		
Matte	239		
Maximum residue limits	484		
Maxwell body	322	323	
Mayonnaise	137	343	
Meat and bone meal	484		
Meat, drip loss	214		
Meat flavor	298		
Meat Inspection Act (Canada)	482		
Meat Inspection Act (United States)	479		
Meat minerals	213	220	223
Meat proteins			
actin	144		
actomyosin	146		
collagen	147		
myoalbumin	146		
myosin	120	144	146
stroma	144		
tropomyosin	144		
Meat shear cell	333	334	
Meat tenderizing	411		
Meat texture	334		
Meat-water binding	28	29	
Meaty taste	276		
Mechanical body	322		
Mechanical harvesting	311		
Mechanical properties	311		
Medium chain triglycerides	107		
Melanoidins	120	126	
Melibiose	172		
Meltdown properties	89		
Melting agents	449		

<u>Index terms</u>	<u>Links</u>		
Melting points, fats	82		
cocoa butter	48	99	
high melting glycerides	89		
milk fat	48		
palm oil	97		
palm olein	97		
palm stearin	97		
sheep depot fat	48		
shortening	94		
triglycerides	84	89	93
vegetable fats	44		
Melting range	82		
Membrane effect	16		
Membrane puncturing theory	288		
Menadione	366		
Menthanoids	305		
Mercaptans	287		
Mercury	220	461	
Mercury contamination			
in foods	462		
methylmercury	461		
Minamata disease	461		
pulp and paper	461		
seed spraying	461		
structure Hg, compounds	461		
Meromyosin	146		
Mesomorphism	104		
Metabolism	476		
Metal deactivator	62		
Metallic taste	263	276	
Metal pickup	218		
Metal uptake	223		
Metameric	236		
Methanethiol	299		
Methional	133	300	

<u>Index terms</u>	<u>Links</u>			
Menthol	276	284	305	
Methoxy isobutylpyrazine	285			
Methoxyl content of pectin	196			
Methoxypyrazines	285			
Methyl alphaethyl- <i>n</i> -caproate	301			
Methyl cellulose	203			
Methyl ketones	300			
Methyl lanthionine	438			
Methyl mercaptan	299			
Methyl mercury	461			
Methyl pyrazines	286			
Methyl tetrahydrofolate	381	383		
Metmyoglobin	240			
Michaelis constant	426			
Michaelis-Menten equation	392			
Microencapsulation	424			
Microorganisms, growth	21	23		
Microsomes	422			
Microstructure	311	341		
chocolate	343			
colloidal dispersions	342	345		
dispersed phases	343			
emulsions	343			
fat	346			
soybean curd	347			
Migration from packaging	448			
Milk				
Ca, P content	214			
clotting	409			
fat	34			
flavor	299	300		
minerals	212	218	219	223
powder	25			
protein	138			
serum proteins	138			

<u>Index terms</u>	<u>Links</u>		
Minamata disease	461		
Minerals	209		
abundance of trace	219		
determination	209		
enzyme reactions	220	221	
essential	209		
in fruit	219		
in meat	213		
in milk	212	214	
in plant products	216		
in soybeans	218		
interactions	210		
in wheat grain	216	217	
metal chelates	211		
nonnutritive, nontoxic	209		
nonnutritive, toxic	209		
trace	217		
uptake, canned food	223		
Mint flavor complex	276	284	
Miracle fruit	277		
Mitochondria	145		
Mixed crystals	84		
Mixed gels	202		
Mobility	325		
Model food act	477		
Modified cellulose	203		
Modified starch	187	340	
Molasses	170		
Mold and yeast, growth	21	22	23
Molecular cross-section area	288		
Molecular distillation	81	104	440
Molecular packing	86		
Mollusks	50		
Molybdenum	219		
Monochromatic light	230		

<u>Index terms</u>	<u>Links</u>			
Monoglycerides	81	103	440	
Monomolecular water	7	11		
Monophenols	414			
Monosaccharides				
Fischer formula	163	165	167	
fructose	166	167	172	173
galactose	167	168	173	
glucose	164	167	172	173
	175			
Haworth representation	165			
mannose	167	168	173	
tautomeric form	166			
Monosodium glutamate	279			
Mucins	152			
Mucor javanicus	402			
Mucor miehei	400	409		
Mucor pusillus	409			
Multilayer adsorption	28			
Multiple sclerosis	223			
Multi-stage fractionation	95			
Multivariate analysis	291			
Munsell notations	237			
Munsell system of color	236			
Muscle fiber	146			
Muscle protein	28			
Musks	283			
Musky	288			
Mustard oil	44			
Mutarotation	169	172		
Mycotoxins	465			
Myofibrils	28	144		
Myoglobin	240			
Myosin	114	144		
Myrcene	301			

Index terms**Links****N**

Naringin	167	273
Natamycin	438	
National Academy of Sciences	431	
Natural toxicants	467	
Nature identical colors	446	
Neat phase	104	
Neohesporidose	274	
Neomenthol	276	
Neoisomenthol	276	
Nerve activity	264	
Neural response	264	
Neuraminic acid	172	
Neuron	288	
Neutraceuticals	477	
Neutral detergent fiber	204	
Neutralization	50	
Neutron diffraction	176	
Newtonian fluids	318	320
Newtonian materials	311	318
Niacin	378	
from tryptophan	379	
pellagra factor	379	
sources	355	380
stability	356	380
structures	379	
Niacytin	380	
Nickel	219	
catalyst	222	
content in foods	222	
Nicotinic acid	378	
Nicotinic amide	378	
Nisin	437	461

Index terms**Links**

Nitrates, nitrites			
ADI	437		
applications	437		
curing salts	435		
natural sources	437		
nitrosamines	436		
Nitrite cured meat	211		
Nitrocyclohexanes	284		
Nitrogen closure	225		
Nitrogen oxides	441		
Nitrosamines	386	436	
Nitrosated heme	211		
Nitrosodiethylamine	448		
Nitrosohemochrome	242		
Nitrosyl chloride	441		
Nitro toluidine	267		
No effect dose	478		
Nonadienal	71	284	422
Nonalactone	284		
Noncariogenicity	182		
Nonenal	71	296	
Nonenzymatic browning	21	24	120
a_w	22	24	
Amadori rearrangement	121	122	125
at glass transition temperature	130		
browning reaction	125		
caramelization	127	128	
enolization	123	127	
glycosylamines	125		
Heyns rearrangement	123	126	
hydroxymethylfurfural	123	126	
inhibitors	127	130	131
lysine loss	123	130	
Maillard reaction	120	127	128 129
melanoidins	120	124	126 132

Index terms**Links**

Nonenzymatic browning (<i>Continued</i>)		
pH	131	
products	129	
Schiff base	124	
Strecker degradation	127	
velocity	120	130
Nonfermentable sweeteners	182	
Nonionic emulsifiers	103	
Non-Newtonian fluids		
dilatant	320	
plastic	320	
pseudoplastic	320	
Nonpolar oligomeric glycerides	68	
Nonprotein nitrogen	138	
Nonselective hydrogenation	77	
Nonspectral colors	233	
Nootkatone	284	
Norepinephrine	264	
No- <i>trans</i> margarine	95	
Novel food regulation	483	
Novel oils and fats	106	
Nuclear fission	449	
Nuclear magnetic resonance	12	
Nuclear magnetic resonance pulsed	83	
Nucleation	16	17
Nucleation, heterogeneous	15	
Nucleoproteins	114	
Nucleotides	442	
Nucleotides as flavor enhancers	442	
Nutmeg	305	
Nutrition labeling	481	
Nutrition Labeling and Education Act (United States)	480	
Nutrition supplement	447	
Nystose	172	

Index terms**Links****O**

Oak casks	295	304	
Octenone	277		
Octyl tin maleate	448		
Octyl tin mercaptoacetate	448		
Odd carbon number fatty acids	36		
Odor	263	282	
See also Flavor			
analyses	291		
aroma description of wine	293		
description	289		
intensity factor	289		
just noticeable difference	289		
membrane puncturing theory	288	291	
olfactory organ	282	287	
potency	283	285	
primary odors	287	290	
threshold concentration	282	287	
Odorivector	287		
Off-flavors	291	296	416
Oil absorption	66		
O-inside form	164		
Olefins	72		
Oleic acid oxidation	58		
Olein	94		
Oleoresins	304	441	
Olestra	107		
Olfaction	287		
Olfactory organ	282		
Oligosaccharides	169		
cellobiose	171	175	
fructo	172		
gentiobiose	168	172	
in legumes	172		
in cow's milk	172		

Index terms**Links**

Oligosaccharides (<i>Continued</i>)			
in soy milk	172		
lactose	170	172	
maltose	170	171	175
manninotriose	170		
raffinose	170		
sophorose	175		
stachyose	170	172	
sucrose	170	172	
trehalose	170		
verbascose	170		
Olive oil	34		
Onion flavor	301		
O-outside form	164		
Opaqueness	229		
Opponent colors theory	237		
Optical rotation	165		
Orange	247		
Organic acids	271		
Ornithine	130		
Ornithoalanine	133		
Orthorhombic crystal structure	88		
Oryzenin	114		
Osazones	169		
Osmotic pressure measurement	200	211	
Ovomucin	114	150	
Ovomucoid	150		
Oxalic acid	225		
Oxazoles	303		
Oxidation rate	58		
Oxidized glycerides	68		
Oxidized sterols	68		
Oxonium salts	252	255	
Oxygen permeability	241		

<u>Index terms</u>	<u>Links</u>		
Oxygen scavengers	438		
Oxymyoglobin	240		
 P			
Packaging	26	27	
Packaging materials, migration to			
foods	448		
plastic netting	448		
PVC	448		
PAHs (polycyclic aromatic hydrocarbons)	463		
Palatinose	183		
Palm kernel oil	34	81	
Palm oil	34	252	337
mid fraction	95		
super olein	95		
Palm stearin	81		
Panose	282		
Panthenol	384		
Pantothenic acid	383		
coenzyme A	384		
sources	384		
stability	356	384	
structure	384		
Papain immobilized	426		
Papillae	264		
Paprika oleoresin	252		
Parabens as preservative	432		
Paracasein	140		
Paraffins	54	56	
Parallel sheet structure	115		
Partial glycerides	81	300	398
Particle size analysis	311		
Pastes	187		
Pattern recognition	291		

<u>Index terms</u>	<u>Links</u>		
Patulin	467		
PCBs (polychlorinated biphenyls), contaminants from	458		
aroclor	459		
hydraulic fluids	458		
in fish	458		
transformers	458		
Peach	246		
Peak time, in texture	336		
Peak viscosity	341		
Peanut oil. <i>See</i> Fats and oils, individual			
Peanut protein	113		
Pectic substances	169	194	
acid	196		
content, plants	195		
degree of methylation	196		
gel strength	197		
hairy regions	196		
LM, HM pectin	197		
smooth regions	196		
structure	196		
Pectin	26		
Pelargonidin	253		
Pellagra preventive factor	379		
Penetrometers	330		
Penicillium camemberti	398		
Penicillium roqueforte	300	398	400
Pentadiene group	420	432	
Pentene radical	71		
Pentitols	168	182	
Pentosans	191		
Peonidin	253		
Pepper	276	305	
Pepperminty	288		
Peptides	114	273	

<u>Index terms</u>	<u>Links</u>			
Peptones	114			
Peroxidase	139	257	368	421
Peroxidase test	419			
Peroxides	56			
Peroxide value	60			
Persicaxanthin	247			
Pesticides	451	455		
Pesticides, chlorinated				
hydrocarbon	451			
ADI	457			
Aldrin	451			
classes and names	452			
DDT	452			
Dieldrin	452	454		
Heptachlor	452			
removal	454	456		
stability	452			
structures	453	454		
Pesticides, classes	451			
chlorinated hydrocarbon				
insecticides	451			
organo phosphorous				
insecticides	453			
Pesticides, organophosphorous	453			
ADI	457			
classes and names	455			
structure	456			
water solubility	453			
Petunidin	253			
Pharmacokinetics	476			
Phase angle	326			
Phase diagram	14	19	95	96
Phenolase	368			
Phenolic acid	257			
Phenolic antioxidants	62			

<u>Index terms</u>	<u>Links</u>		
Phenoloxidase	257		
Phenols	62	303	
Phenylketonuria	443		
Phenylthiourea	268		
Pheophorbides	243		
Pheophytin	26	243	
Phosphates	29	212	444
Phosphates, additives	444		
firming agent	444		
in nutrition	445		
Na-hexa	445		
ortho	445		
poly	445		
pyro	445		
structure	445		
Phosphatidylcholine	52		
Phosphatidylethanolamine	52		
Phosphatidylserine	52		
Phosphoinositides	52		
Phospholipids	50	51	52
Phosphopeptone	141		
Phosphoproteins	114		
Phosphoric acid	271		
Phosphorus oxychloride	188	445	
Phosphorus poison	76		
Phosphorylation	140		
Photooxidation	63		
Phtalides	284		
Physical properties			
fats	82	87	
hydrides	3		
ice	2		
volume change, water	18		
water	2		

Index terms**Links**

Physical properties, fats. <i>See also</i> Plastic fats				
hardness	87			
margarines	89	90	94	
shortenings	89	90	94	
texture	87			
Physical refining	66			
Phytate	160	210		
Phytic acid	218			
Phytosterols	51			
Picric acid	266			
Picrocrocin	246			
Pimaricin	438			
Pinking	256			
Piperine	276	305		
Plane of symmetry	45			
Plant breeding	67			
Plant products	19			
Plant proteins	152			
Plasmalogens	52			
Plastic	320	324		
Plastic fats	71	81	86	87
cocoa butter	85			
margarine	71			
melting	84			
shortening	71			
solid fat index	83	84		
solid fat content	82	84	85	100
solidification	84			
tallow	84	85		
Plasticizers	20			
Plastic netting, migration of	448			
Plastic range	81	86		
Plastic viscosity	325			
Polarized light microscopy	89	184	191	

<u>Index terms</u>		<u>Links</u>
Polishes	449	
Polyacrylamide gel	426	
Poly chlorinated biphenyls	458	
Polychlorinated dibenzodioxins	455	
Polychlorinated dibenzofurans	455	
Polycyclic aromatic hydrocarbons (PAHs)		
barbecuing	463	
in smoke, foods	463	
roasted coffee	463	466
structures	464	
unsmoked food	466	
Poly dextrose	194	
Polyglutamate	382	
Polyglycerol esters	441	
Polyhydrons	5	
Polymerization	70	81
Polymerization, sulfhydryl	120	
Polymorphism, fat	86	96
Poly nuclear chelates	223	
Polyols	181	
Polypeptides	141	
Polyphenolase	372	
Polyphenols	134	295
Polyphosphates	370	
Polysaccharides. <i>See also</i> Oligosaccharides		
cellulose	191	
complex	191	
glycogen	190	
gums	197	
hydrocolloids	199	
molecular structure	198	
sources	198	
starch	179	
unit length	169	
Polysorbates	441	

<u>Index terms</u>	<u>Links</u>		
Polyunsaturated fatty acids	365		
Polyvalent ions	210		
Poly vinyl chloride	448		
Popcorn	347		
Popcorn crispness	349		
Porosity, milk powder	26		
Post-hardening	81		
Potassium bromide	266		
Potassium iodide	266		
Potassium metabisulfite	433		
Potato-dehydrated-BET Plot	9		
Potato protein	113		
Potato starch	183	185	404
Powdered milk	372		
Power law	318		
Prebetanin	258		
Preservatives	431		
acids	438		
bacteriocins	437		
benzoic acid	432		
hydrogen peroxide	437		
nitrites	435		
parabens	432		
sodium chloride	437		
sorbic acid	432	433	
sulfites	433		
Primary colors	231		
Primary odors	287		
Primary oxidation products	57		
Processing requirements	30		
Procyanidins	257		
Profile functional group concept	288		
Prolamins	114		
Proline	111		

Index terms**Links**

Proline-rich proteins	295		
Propagation	56		
Propellants	449		
Propionic acid as preservative	438		
Propylene glycol esters	441		
Propyl gallate	62		
Propyl methane-thiosulfonate	301		
Propyl propane-thiosulfonate	301		
Prostanoids	41		
Prosthetic groups	368		
Protamines	114		
Protein biological value	112		
Protein bodies	156		
Protein bonds			
covalent	117		
disulfide	117	154	155
electrostatic	117		
energy	117		
hydrogen	122		
hydrophobic	117	159	
hydrophobicity	118	136	
noncovalent	117		
sulfhydryl	120		
Protein coagulants	160		
Protein content of foods	112	153	154
Protein crosslinking	347		
Protein efficiency ratio	112		
Protein gels	137	138	
bean curd	137	160	
clear	138		
gelatin	149		
isoelectric point	138		
mayonnaise	179		
yogurt	137		
Protein hydrolysates	284	412	

<u>Index terms</u>	<u>Links</u>		
Proteins, changes during			
processing and storage	131		
alkali treatment	132	133	
ammonia treatment	133		
heating	131		
lipid oxidation	132		
Maillard reaction	132		
polyphenol reaction	134		
sunlight	133		
UHT sterilization	132	133	
Proteins, classes			
conjugated	114		
contractile	146		
derived	114	115	
fibrillar	144		
lipo	152		
phospho	138		
serum	138		
simple	113	114	
soluble	146	153	
stroma	144		
Proteins, conjugated	113		
Proteins, derived	113		
Protein, separation			
milk	140		
skim milk	143		
wheat	153		
whey	144		
Proteins, functional properties	134	137	
dispersibility	134		
dough making	134	137	
emulsification	134	137	
foaming	134	135	137
gel formation	137		
solubility	135	136	137

Index terms**Links**Proteins, functional properties (*Continued*)

surface activity	134			
wettability	134			
Proteins of foods				
albumin	120			
casein	114	119	137	143
cereal	112	152		
egg	112	121	137	150
fibrinogen	120			
fish	131	137	149	150
globulin	120			
legume	152			
maize	154			
meat	144			
milk	121	123		
myosin	120	146	150	
ovalbumin	138			
rice	156			
soybean	156			
wheat	153			
whey	119	139	142	143
Proteins, simple	113			
Protein structure	115			
alpha helix	116	146	156	159
antiparallel	116	142	159	
coagulation	118	120		
denaturation	118	119		
double helix	146			
oligomeric	117			
primary	111			
quaternary	159			
secondary	111	116	120	159
stability	119	120		
tertiary	111	115	120	142
	159			
Proteolysis	29	115		

<u>Index terms</u>	<u>Links</u>		
Proteoses	114		
Protocrocin	246		
Protohemin	417		
Protopectin	26		
Provitamin	355		
Provitamin A	246	251	358
Pseudobase	252		
Pseudoglobulin	142		
Pseudoplastic	318		
Pullulanase	181		
Pulsed nuclear magnetic resonance	84		
Punch dimension, texture	332		
Pungency	276	304	
Pungent	287		
Purples	234		
Putrid	288		
PVC bottles, migration of	448		
Pyranose ring	163		
Pyranoside, α and β	165		
Pyrazines	285		
Pyridoxal	377	378	
Pyridoxamine	377		
Pyridoxine	377		
Pyroconversion	189		
Pyrolysis of carbohydrates	302		
Pyrroles	303		
Pyruvic acid	201		
 Q			
Quaternary protein structure	159		
Quenching	64		
Quercetin	256		
Quercetin-3-rutinoside	226		
Quinine	266	273	

Index terms**Links**

Quinones	386	413
R		
Racemic mixture	45	
Racemization	134	
Radiation disinfestation	447	
Radiation pasteurization	476	
Radiation unit	446	
Radioactive fallout	449	
Radioactive isotopes	449	
half-life	449	
in food chain	450	
natural	449	
nuclear fall out	449	
pathway	450	
Radionuclides	449	
Raffmose	172	
Rancidity	54	
Random coil structure	149	
Random distribution, glycerides	47	48 77
Randomization	77	
<i>See also</i> Interesterification		
Raoult's law	4	
Rapeseed oil	37	
Rapid detinning	223	
Raspberries	253	
Reaction rate and a_w	21	
Receptor mechanism	263	
Recommended daily allowance	358	
Refining	50	
Refractive index	145	
Regeneration enzymes	419	
Regiospecificity, enzymes	400	
Relative sweetness	270	

<u>Index terms</u>	<u>Links</u>			
Relaxation, muscle	147			
Relaxation time, texture	320			
Rennet action	139			
Rennet casein	143			
Rennin sources	408			
Replacer fat. <i>See</i> Fats and oils, individual				
Resistant organisms	460			
Resonance hybrids in oxidation	58	61		
Restricted random distribution, glycerides	48			
Rest sulfurous acid	434			
Retarded elasticity, texture	321			
Retinal	358			
Retinin	245			
Retinol	355	358		
Retrogradation	186			
Reverse osmosis	143			
Reversion disaccharides	175			
Rhamnogalacturonan	195			
Rhamnoglycosides	274			
Rheological testing systems				
cone penetrometer (AOCS)	330	337		
denture tenderometer	333			
extensigraph	336			
Farinograph	335			
FIRA-NIRD extruder	337			
General Foods Texturometer	333			
Instron Universal Testing Machine	330			
Kramer shear press	332	339		
Magness-Taylor fruit presser tester	330			
penetrometers	330			
rotating knife tenderometer	335			
viscoamylo graph	340	342	343	344
viscometers	329			
Warner-Bratzler shear	334			
Rheology	316			

Index terms**Links**

Rhizopus arrhizus	402	
Rhizopus oligosporus	410	
Ribitol	376	
Riboflavin	371	374
Ribonucleic acid	281	
Ribosomes	145	
Rice bran	156	
Rice polish	156	
Rice proteins	156	
Rice starch	183	
Ripening	418	
Risk, safety	478	
Roasted peanuts	286	
Rosemary	438	
Rotating knife tenderometer	335	
Rubbery flow	349	
Rubbery state	19	
Rum	303	
Rutin	226	
Rutinose	256	274

S

Saccharification	179	
Saccharin	266	273
Saccharinic acids	174	
Saccharomyces cerevisiae	434	
Saccharomyces fragilis	427	
Saccharomyces lactis	427	
Saccomere length	335	
Safe Drinking Water Act (United States)	480	
Safflower oil. <i>See</i> Fats and oils, individual		
Saffronal	246	
Sage	438	
Sago starch	183	

<u>Index terms</u>	<u>Links</u>		
Salatrim	107		
Salmonella	447		
Salty taste	264	272	
Sandiness	178		
Sarcolemma	144		
Saturation, color	234		
Saxitoxin	469		
Schiff base	124		
Sclerids	418		
Scleroproteins	114		
Scombrin	114		
Seafood toxins	468		
Secondary oxidation products	57		
Sectilometer	337		
Sedimentation methods, microstructure	311		
Seeding	17	179	
Seed oils	34		
Selectivity	72		
Selenite	221		
Selenium	219		
Semipermeable membrane	425		
Senescence	217	370	418
Sensitizer	64		
Sensory panel tests	311		
Sequestrants	438		
Serum albumin	114	138	
Sesame oil. <i>See</i> Fats and oils, individual			
Sewage sludge	220		
Shadow matching	288		
Shea oil	100		
Shear force	316		
Shear press	332		
Sheep depot fat	48		
Short chain fatty acids	300		

<u>Index terms</u>	<u>Links</u>		
Shortening	81	338	
Shortening, crystal structure	89	90	94
Shortening texture	338		
Shortening, trans isomers	77		
Shorthand description fatty acids	35		
Short range order	71	86	
Short spacing, X-ray diffraction	88		
Shrink temperature	147		
Silicon	219		
Sinapaldehyde	304		
Sinapic residue	254		
Sinapyl alcohol	193		
Singlet oxygen	63		
Sinigrin	167		
Sintering fat crystals	339		
Sinusoidal strain, texture	326		
Sitosterol, β	51	55	
Slip melting point	97		
Slow-set pectin	196		
Smoke	463		
Snap	99		
Sodium benzoate. <i>See</i> Benzoic acid			
Sodium chloride	437		
Sodium methoxide	79		
Sodium stearate	105		
Sodium trimetaphosphate	188		
Soft rot	407		
Solder	463		
Solid fat content	82	83	
Solid fat index	84		
Solid fat profile	83	96	102
Solid solutions	84	95	
Solubility diagram	97		
Solvent fractionation	94		

<u>Index terms</u>	<u>Links</u>			
Sophorose	175			
Sorbic acid (sorbates) as preservatives				
applications	432			
off-flavor	433			
yeasts and molds	432			
Sorbitol	168	181		
Sorption	4			
Sorption isotherm	6	7	27	347
Sorption phenomena	4			
Sour taste	263	270		
Southgate method	204			
Soya lecithin	103			
Soybean curd	137			
Soybean flour in wheat flour	421			
Soybean oil	37			
<i>See also</i> Fats and oils, individual				
Soybean proteins	156	158	160	
Soybeans, mineral content	218			
Soy milk	160			
Soy protein isolate	134			
Soy sauce	408	410		
Spatial representation, glyceride	46			
Specialty fats	94			
Specific rotation	171			
Specific surface area, dispersions	344			
Spectral light types	230			
Spectrophotometry	229			
Specular reflection	239			
Spherocrystals, starch	186			
Spices	304	441		
Spinach	437			
Spoilage, water activity	23			
Spring	322			

<u>Index terms</u>			<u>Links</u>
Springer	224		
Squalene	51	56	
Stachyose	172		
Stainless steel	219	222	
Staling	187		
Staphylococcus	464		
Staphylococcus aureus	401		
Starch	179	340	
acid conversion	180		
amylase	184	185	
amylopectin	184		
birefringence	185		
branched	184		
cereal (corn, wheat)	185	187	
crystallinity	184		
double helix	185		
enzymatic conversion	180	181	
gelatinization temp	185	186	
gel formation	187		
granules	183		
hydrolyzates	179	180	
linear	184		
modified	187		
polymorphs	185		
retrogradation	186		
root tuber (potato)	187		
swelling	186		
Starch, glass transition	20		
Starch hydrolyzates	179		
Starch, modified	187		
acid	187	189	
adipate	187		
cross-bonding	187		
dextrinization	189		
gel formation	187	188	190

<u>Index terms</u>	<u>Links</u>			
Starch, modified (<i>Continued</i>)				
oxidation	187	189		
phosphate	187	188		
properties	190			
substitution	187	188		
Starch sodium octenyl succinate	188			
Starch, sorption isotherm	9			
Starch viscosity of suspensions				
corn	343			
tapioca	343			
waxy corn cross-bonded	342	343	344	
Steam flow closure	225			
Stearin	94			
Stearoyl lactylate	441			
Stereochemical site theory, odor	287			
Stereoisomers in taste	267			
Stereospecific analysis, glycerides	48			
Stereospecificity	400			
Stereospecific numbering, glycerides	46	47		
Sterilization flavor	300			
Steroids	284			
Sterols	51	53	68	
Stickiness	20	311		
Stigmasterol	51	55		
Stimulus concentration, taste	266			
Stone cells	418			
Storage modulus, texture	326			
Strain-texture	316			
Strecker degradation	128	298	367	
Streptomyes	426			
Stress	316			
Stress decay	320			
Stroma proteins	144			
Strontium	89	450	90	451

Index terms**Links**

Structural triacylglycerols	401			
Struvite	226			
St. Venant body	324			
Subcell	88			
Subchronic toxicity	476			
Substrate, enzymes	389			
Subunit	117			
Subunit association	115			
Succinylated monoglycerides	441			
Succulometer cell	333			
Sucrose	169			
Sucrose fatty acid esters	441			
Sucrose polyester	107			
Sugar acids	167	276		
Sugar alcohols	167			
arabitol	169			
galactitol	169			
hexitols	168			
lactitol	182			
maltitol	182	183		
mannitol	169	182		
pentitols	168			
polyols	181			
sorbitol (glucitol)	168	169	181	183
xylitol	168	169	182	
Sugar, reactions	174			
caramelization	175			
dehydration	174			
enolization	174			
isomerization	174			
mutarotation	173			
polymerization	174			
Sulfide staining	225			
Sulfite oxidase	221			

Index terms**Links**

Sulfites as preservatives				
activity	433			
ADI	434			
antimicrobial	433			
antioxidant	433			
applications	434			
effect on pH	435			
thiamin and	434			
Sulfmyoglobin	242			
Sulfones	454			
Sulfoxides	454			
Sulfur dioxide	130	255	373	374
	433			
Sulfur modified catalyst	100			
Sulfur poison	76			
Sunflower oil	38			
Sunlight flavor	133			
Supercooling	15	17	19	
Super olein	81			
Supersaturation sucrose	176			
Suprathreshold levels	289			
Surface active proteins	134			
Surface activity	50			
Surface area, emulsions	106			
Surface tension	101	103	344	
Surimi	150			
Sweetened wine	432			
Sweeteners	443	444		
Sweeteners, artificial	182			
acesulfame-K	182			
aspartame	182			
isomalt	183			
maltitol	182			
relative sweetness	183			
sorbitol	182			

<u>Index terms</u>	<u>Links</u>			
Sweeteners, natural	444			
Sweeteners, nonnutritive	443			
acesulfame K	443	444		
aspartame	443			
cyclamate	443	444		
cyclohexylamine	440	444		
saccharine	443	444		
sucralose	443			
Sweetness of sweeteners	443	444		
Swelling temperature	185			
Swordfish	462			
Synaptic area	264			
Synergistic effect in flavors	280			
Synergists in antioxidants	62			
Synsepalum dulcificum	278			
 T				
Tackiness	199			
Tallow	34	84		
Tannins	134	257	276	277
	295			
ellagic acid based	257			
gallic acid based	257			
hexahydroxy diphenic acid based	26			
nonhydrolyzable	257			
Tapioca starch	31	43	45	
Taraxanthin	251			
Tartaric acid	271			
Taste				
ability to	268	269	270	
alkaloids	266	306		
chemical structure	266			
peptides	273			
salts	266			
sensations	263			

Index terms**Links**

Taste (<i>Continued</i>)			
sensitivity of the tongue	264		
stereoisomers	267	269	
stimulas	264	265	266
Taste, bitter	273		
Taste buds	264		
Taste interrelationships	275		
astringency	276	277	
coolness	276	277	
enhancers	278		
hotness	276	277	
meaty	276		
metallic	276		
pungency	276	306	
suppressants	277	278	
sweet-sour	275		
Taste, salty	272		
Taste, sour	270		
Taste, sweet	268		
Tautomers	165		
Tea	301		
Technical monoglyceride	81		
Tempering, cocoa butter	99		
Tension force, texture	316		
Termination in autoxidation	56		
Terpenic alcohols	51		
Terpinyl acetate	301		
<i>Tert</i> -butyl hydroquinone	62		
Tertiary oxidation products	57		
Tetracyclines	460		
Tetrahedral structure	16		
Tetra hydronaphtalenes	284		
Tetrapyrrole pigments	239		
Tetraterpenoids	244		

Index terms**Links**

Textural instruments. <i>See</i> Rheological testing systems				
Textural integrity	18			
Texture	311			
apples	333			
applications	328			
beans	333			
beets	333			
bread	333			
butter	332			
definition	311			
dough	335	336	337	
dynamic behavior	326	327		
fats	330	337	339	
fruit purees	329	331		
fruits and vegetables	339	340		
hydrogenated fats	337			
interrelationships	311			
margarines	332			
meat	334	335		
mechanical properties	314	317		
microstructure	341			
objective measurements	311	316	320	
of foods	334			
palm oil	337			
physical properties	311			
profile	313	314	315	317
rheological parameters	314	316	318	
shortening	337	338		
starch suspensions	340			
terminology	312	313	314	315
types of bodies	320			
viscosity	318			
water activity and	347			
Texture characteristics				
geometrical	314			
measurements	316			

Index terms**Links**

Texture characteristics (<i>Continued</i>)			
mechanical	314		
others	31		
terminology	312	317	
Texture measurements			
by compression	330	337	
by extrusion	332		
by flow	330		
by penetration with punches	330	331	
by shearing	330	333	334
by stretching	336		
creep compliance	320		
deformation and strain	317		
force and stress	316		
relaxation time	320		
shearing stress, rate of shear	318	319	326
sinusoidal strain	326	327	
strain time	321	322	323
stress decay	320		
stress strain	324		
stress time	321	322	323
yield stress	319		
yield value	319	325	326
Texture profile	314		
analysis	334		
geometrical characteristics	313		
mechanical characteristics	313		
other characteristics	313		
Texture, type of bodies			
Bingham	324	325	326
Burgers	323		
elastic	320		
Hookean	321	322	
Maxwell	332	375	
plastic	324		
plasto-elastic	325		

Index terms**Links**Texture, type of bodies (*Continued*)

plasto-viscoelastic	325			
retarded elastic	321	322		
St. Venant	32			
thixotropic	326	328	342	
viscoelastic	321	322	326	
viscous	321			
Voigt-Kelvin	322	323		
Theanine	442			
Theobromine	273			
Theocysteine	133			
Thiamin	131	372	434	
Thiazoles	303			
Thiazolidine	132			
Thin boiling starch	187			
Thiol-disulfide exchange	336			
Thiophenes	303			
Thiophosphates	454			
Thio propanal oxide	301			
Thiouracil	268			
Thiourea	268			
Thixotropy	326	328	338	342
Thomson equation	13			
Three dimensional folding, protein	142			
Three dimensional network, fat	85			
Three-Mile Island	451			
Threonic acid	367			
Threshold value	266			
Thymol	305			
Tin	462			
Tin contamination. <i>See</i> Lead and tin contamination				
Tin-iron couple	223			
Tin plate	225			
Titanium dioxide	260			

<u>Index terms</u>	<u>Links</u>		
Titratable acidity	270		
Tocopherolquinone	363		
Tocopherols	62	362	386
Tocopheronic acid	363		
Tocopheronolactone	363		
Tocotrienols	362		
Tofu	137	160	346
Tomahawk crystal shape	178		
Tomato	246		
Tomato paste	225		
Tongue	264		
Totox value	60		
Toughness of fish	18		
Toxicants, natural			
caffeine	469	470	
domoic acid	469		
gastrogens	468		
glucosinolates	469		
isothiocyanates	469	470	
saxitoxin	469		
seafood	469		
thiosulfmates	469		
Toxic chemicals in food	429		
man made	430		
natural	430		
Toxicity	430		
Toxins, bacterial and fungal			
aflatoxins	465		
botulinum	464	465	
from staphylococcus	464		
in peanuts and foods	465		
mycotoxins	465		
patulin	467	470	
vomitoxin	467	468	
Trace elements	209	217	

<u>Index terms</u>		<u>Links</u>
Trace metals	62	461
cadmium	463	
lead and tin	462	
mercury	461	
Trace minerals	219	
absorption Fe	219	
abundance of	219	
enzyme reactions	220	221
fruit juices, in	225	
vegetables, in	224	
Transglucosidation	189	
Transglycosylation	183	
<i>trans</i> -isomers	34	73
Transition metals	210	
Triacylglycerols	34	
Tricholomic acid	281	442
Trichromatic system	230	
Triclinic crystal structure	88	
Tricyclic compounds	284	
Trimethylamine	299	
Tripalmitin	91	
Triple chain length	89	
Triple helix	147	
Triplet oxygen	63	
Trisaturates	78	
Tristimulus values	232	
Tropocollagen	147	
Tropomyosin	144	
Trypsin digest	141	
Tuna	462	
U		
UHT sterilization	132	
Ultracentrifuge	113	

<u>Index terms</u>	<u>Links</u>			
Ultrafiltration	143			
Ultraviolet light	361			
Umami	278	299	442	
Undecalactone	284			
Unfreezable water	12			
Uniaxial stress	316			
Unit cell	176			
Universal testing machine	330			
Unsaponifiabiles	51	53		
Uric acid	422			
U.S. food laws	479			
 V				
Value, color	236			
VanderWaals forces	115	137	328	338
	346			
Vanilla	306			
Vegetable flavor	301			
Vegetable oils	34			
Vegetables, texture	339			
Vertical directives, food laws	483			
Vibrational theory of olfaction	288			
Vinyl chloride monomer	448			
Violaxanthin	247			
Viscoamylograph	340			
Viscoelastic body	321			
Viscometers	328			
Brookfield	329			
capillary	328			
falling ball	328			
rotational	328			
Viscosity	313	318		
apparent	318			
coefficient	318			

Index terms**Links**

Viscosity (<i>Continued</i>)			
dynamic	318		
kinematic	318		
of some foods	319		
Viscous isotropic phase	104		
Visible fat	33		
Vitamer	355		
Vitamin A (retinol)	245	355	
fortification	360		
IU	358	359	
provitamin	358	359	
sources	355	357	
stability	356	360	361
structure	357	358	
Vitamin B ₁₂ (cyanocobalamine)	220	380	
coenzyme for	381		
sources	355	381	
stability	356	382	
structure	380	381	
Vitamin B ₆ (pyridoxine)	377		
forms	377		
sources	355	377	378
stability	356	379	
structures	377	378	
Vitamin B ₂ (riboflavin)	374		
fluorescence	374	376	
sources	355	377	
stability	356	375	
structure	376		
Vitamin B ₁ (thiamin)	372		
loss of	374		
SO ₂ destruction	374		
sources	355	373	374
stability	356	373	376
structures	373		

<u>Index terms</u>	<u>Links</u>
Vitamin C (L-ascorbic acid)	366
as antioxidant	372
destruction by enzymes	368 370
destruction by light	371
losses in dairy products	372
protective compounds of	370
sources	366
stability	356 370
structure	367 369
technical uses	372
Vitamin D (D ₁ , D ₂ , D ₃)	51 361
fortification	361 362
IU	361
sources	361 362
stability	356 361 362
structures	361
Vitamin E (tocopherols)	362
activity	365
as antioxidants	364 365
sources	355 364
stability	356 368
structures	362 363
tocotrienols	363
Vitamin fortification of flour	374
Vitamin, individual	
A	355
B	372
B ₁₂ , cyanocobalamine	380
biotin	385
B ₆ , pyridoxine	377
B ₂ , riboflavin	374
B ₁ , thiamin	372
folic acid	382
niacin	378
pantothenic acid	383
C	366

Index terms**Links**

Vitamin, individual (<i>Continued</i>)				
D	361			
E	362			
K	365			
Vitamin K (menadione)	365			
sources	366	369		
stability	356	365		
structure	365	368		
Vitamin loss in flour after milling	375			
Vitamins	355			
Vitamins, classification				
fat soluble	355			
water soluble	366			
Vitamins, food ingredients	385			
antioxidants	386			
Vitamin stability, general	356			
Vitellenin	152			
Vitellin	152			
Vodka	303			
Voigt Kelvin body	322			
Volatile compounds				
coffee	302			
spices	205			
Vomitoxin	467			
Vulgaxanthins	259			
W				
Water	1			
activity (a_w)	4	21	22	30
	347	437		
bound loosely	11			
bound tightly	12	28		
bound total	12			
cages	4			
caloric properties	1	13		

Index terms**Links***Water (Continued)*

coefficient of thermal expansion	2			
content	1			
crystallization	15	17		
density	1	2		
dielectric constant	2			
heat of vaporation	2			
hydration of	13	38		
molecular structure	2	3		
phase diagram	15			
physical properties	2			
refractive index	2			
specific heat	2			
structure	3			
surface tension	2			
thermal conductivity	2			
types	11			
unfreezeable	12			
vapor pressure	2			
viscosity	2			
volume charge	18			
Water activity (a_w)	4	20	21	22
	30			
bacterial growth	21			
color change	25			
enzyme activity	1			
food processing	30			
food spoilage	23			
glass transition temperature	12	20		
hygroscopic product	26			
milk powder	25			
mold and yeast growth	21			
packaging	26			
pH	30			
reaction rates in foods	22			

<u>Index terms</u>	<u>Links</u>		
Water activity and texture			
crispness of popcorn	349		
freeze dried beef	349		
sorption isotherm	347	348	
temperature effect	350		
Water cages	4		
Waxy corn	340		
Waxy corn starch	404		
Waxy mouthfeel	84		
Wetting	344		
Wheat, baking quality	337		
Wheat bran	193	205	216
Wheat flour, pentosan	192		
Wheat flour sorption isotherm	10		
Wheat, minerals in	216	221	
Wheat proteins	111	139	152
albumin	153		
gliadin	153	154	
globulin	153		
glutenin	152	154	155
prolamin	153		
Wheat starch	183		
Whey protein concentrate	143		
Whey protein hydrolysates	415		
Whey protein isolate	138		
Whipping	134		
Whiskey	303		
Windscale	451		
Wine aroma	291	293	294
Winterization, oils	94		
Work softening	339		
World Health Organization (WHO)	484		
WTO	486		

Index terms**Links****X**

Xanthine	422			
Xanthine dehydrogenase	221			
Xanthine oxidase	139	221		
Xanthophylls	244			
X-ray diffraction	88	147	176	178
	184	191	311	
Xylans	192			
Xylitol	168	182		
Xyloglucan	195			
Yeast fermentation	404			
Yeast growth, a_w	22			
Yield value	325			
Young's modulus	321			
Zearalenone	467			
Zeaxanthin	246	248		
Zein	114	154		
Zero tolerance	478			
Zinc	219	220		
Zingerone	276			
Zymogen	408	411		