

Manahan, Stanley E. "THE ATMOSPHERE AND ATMOSPHERIC CHEMISTRY"
Fundamentals of Environmental Chemistry
Boca Raton: CRC Press LLC,2001

14 THE ATMOSPHERE AND ATMOSPHERIC CHEMISTRY

14.1 THE ATMOSPHERE AND ATMOSPHERIC CHEMISTRY

The **atmosphere** composes the thin layer of mixed gases covering Earth's surface. Exclusive of water, atmospheric air is 78.1% (by volume) nitrogen, 21.0% oxygen, 0.9% argon, and 0.03% carbon dioxide. Normally, air is 1–3% water vapor by volume. In addition, air contains a large variety of trace level gases at levels below 0.002%, including neon, helium, methane, krypton, nitrous oxide, hydrogen, xenon, sulfur dioxide, ozone, nitrogen dioxide, ammonia, and carbon monoxide.

The atmosphere is divided into several layers on the basis of temperature. Of these, the most significant are the troposphere, extending in altitude from the earth's surface to approximately 11 kilometers (km); and the stratosphere, from about 11 km to approximately 50 km. The temperature of the troposphere ranges from an average of 15°C at sea level to an average of -56°C at its upper boundary. The average temperature of the stratosphere increases from -56°C at its boundary with the troposphere to -2°C at its upper boundary. The reason for this increase is absorption of solar ultraviolet energy by ozone (O₃) in the stratosphere.

Various aspects of the environmental chemistry of the atmosphere are discussed in this chapter and the two that follow. The most significant feature of atmospheric chemistry is the occurrence of **photochemical reactions** resulting from the absorption by molecules of light photons, designated $h\nu$. (The energy, E , of a photon of visible or ultraviolet light is given by the equation $E = h\nu$, where h is Planck's constant and ν is the frequency of light, which is inversely proportional to its wavelength. Ultraviolet radiation has a higher frequency than visible light and is, therefore, more energetic and more likely to break chemical bonds in molecules that absorb it. See the discussion of electromagnetic radiation in Section 3.11.) One of the most significant photochemical reactions is the one responsible for the presence of ozone in the stratosphere (see above), which is initiated when O₂ absorbs highly energetic ultraviolet radiation in the stratosphere to form oxygen atoms, which react further to produce ozone, O₃.

Gaseous Oxides in the Atmosphere

Oxides of carbon, sulfur, and nitrogen are important constituents of the atmosphere and are pollutants at higher levels. Of these, carbon dioxide, CO_2 , is the most abundant. It is a natural atmospheric constituent, and it is required for plant growth. However, as discussed in Chapter 15, the level of carbon dioxide in the atmosphere, now at about 365 parts per million (ppm) by volume, is increasing by about 1 ppm per year, which may well cause general atmospheric warming, the “greenhouse effect,” with potentially very serious consequences for the global atmosphere and for life on earth.

Hydrocarbons and Photochemical Smog

The most abundant hydrocarbon in the atmosphere is methane, CH_4 , released from underground sources as natural gas and produced by the fermentation of organic matter. Methane is one of the least reactive atmospheric hydrocarbons and is produced by diffuse sources, so that its participation in the formation of pollutant photochemical reaction products is minimal. The most significant atmospheric pollutant hydrocarbons are the reactive ones produced as automobile exhaust emissions. In the presence of NO , under conditions of temperature inversion (see Chapter 16), low humidity, and sunlight, these hydrocarbons produce undesirable **photochemical smog**, manifested by the presence of visibility-obscuring particulate matter, oxidants such as ozone, and noxious organic species such as aldehydes.

Particulate Matter

Particles ranging from aggregates of a few molecules to pieces of dust readily visible to the naked eye are commonly found in the atmosphere (Chapter 15). Colloidal-sized particles in the atmosphere are called **aerosols**. Some atmospheric particles, such as sea salt formed by the evaporation of water from droplets of sea spray, are natural and even beneficial atmospheric constituents. Very small particles called **condensation nuclei** serve as bodies for atmospheric water vapor to condense upon and are essential for the formation of rain drops.

14.2 IMPORTANCE OF THE ATMOSPHERE

The atmosphere is a protective blanket that nurtures life on the Earth and protects it from the hostile environment of outer space. The atmosphere is the source of carbon dioxide for plant photosynthesis and of oxygen for respiration. It provides the nitrogen that nitrogen-fixing bacteria and ammonia-manufacturing plants use to produce chemically bound nitrogen, an essential component of life molecules. As a basic part of the hydrologic cycle (Figure 11.1) the atmosphere transports water from the oceans to land, thus acting as the condenser in a vast solar-powered still. Unfortunately, the atmosphere also has been used as a dumping ground for many pollutant materials—ranging from sulfur dioxide to refrigerant Freon—a practice that causes damage to vegetation and materials, shortens human life, and alters the characteristics of the atmosphere itself.

In its essential role as a protective shield, the atmosphere absorbs most of the cosmic rays from outer space and protects organisms from their effects. It also absorbs most of the electromagnetic radiation from the sun, allowing transmission of significant amounts of radiation only in the regions of 300–2500 nm (near-ultraviolet, visible, and near-infrared radiation) and 0.01–40 m (radio waves). By absorbing electromagnetic radiation below 300 nm, the atmosphere filters out damaging ultraviolet radiation that would otherwise be very harmful to living organisms. Furthermore, because it reabsorbs much of the infrared radiation by which absorbed solar energy is re-emitted to space, the atmosphere stabilizes the earth's temperature, preventing the tremendous temperature extremes that occur on planets and moons lacking substantial atmospheres.

14.3 PHYSICAL CHARACTERISTICS OF THE ATMOSPHERE

Atmospheric science deals with the movement of air masses in the atmosphere, atmospheric heat balance, and atmospheric chemical composition and reactions. To understand atmospheric chemistry and air pollution, it is important to have an overall appreciation of the atmosphere, its composition, and physical characteristics as discussed in the first parts of this chapter.

Atmospheric Composition

Dry air within several kilometers of ground level consists of two **major components**

- Nitrogen, 78.08 % (by volume)
- Oxygen, 20.95 %

two **minor components**

- Argon, 0.934 %
- Carbon dioxide, 0.036 %

in addition to argon, four more **noble gases**,

- Neon, 1.818×10^{-3} %
- Helium, 5.24×10^{-4} %
- Krypton, 1.14×10^{-4} %
- Xenon, 8.7×10^{-6} %

and **trace gases**, as given in [Table 14.1](#). Atmospheric air may contain 0.1–5% water by volume, with a normal range of 1–3%.

Variation of Pressure and Density with Altitude

As anyone who has exercised at high altitudes well knows, the density of the atmosphere decreases sharply with increasing altitude as a consequence of the gas laws and gravity. More than 99% of the total mass of the atmosphere is found within approximately 30 km (about 20 miles) of the earth's surface. Such an altitude is minuscule compared with the earth's diameter, so it is not an exaggeration to charac-

terize the atmosphere as a “tissue-thin” protective layer. Although the total mass of the global atmosphere is huge, approximately 5.14×10^{15} metric tons, it is still only about one millionth of the earth’s total mass.

Table 14.1 Atmospheric Trace Gases in Dry Air Near Ground Level

Gas or species	Volume percent ¹	Major sources	Process for removal from the atmosphere
CH ₄	1.6×10^{-4}	Biogenic ²	Photochemical ³
CO	$\sim 1.2 \times 10^{-5}$	Photochemical, anthropogenic ⁴	Photochemical
N ₂ O	3×10^{-5}	Biogenic	Photochemical
NO _x ⁵	10^{-10} – 10^{-6}	Photochemical, lightning, anthropogenic	Photochemical
HNO ₃	10^{-9} – 10^{-7}	Photochemical	Washed out by precipitation
NH ₃	10^{-8} – 10^{-7}	Biogenic	Photochemical, washed out by precipitation
H ₂	5×10^{-5}	Biogenic, photochemical	Photochemical
H ₂ O ₂	10^{-8} – 10^{-6}	Photochemical	Washed out by precipitation
HO· ⁶	10^{-13} – 10^{-10}	Photochemical	Photochemical
HO ₂ · ⁶	10^{-11} – 10^{-9}	Photochemical	Photochemical
H ₂ CO	10^{-8} – 10^{-7}	Photochemical	Photochemical
CS ₂	10^{-9} – 10^{-8}	Anthropogenic, biogenic	Photochemical
OCS	10^{-8}	Anthropogenic, biogenic, photochemical	Photochemical
SO ₂	$\sim 2 \times 10^{-8}$	Anthropogenic, photochemical, volcanic	Photochemical
I ₂	0-trace	—	—
CCl ₂ F ₂ ⁷	2.8×10^{-5}	Anthropogenic	Photochemical
H ₃ CCCl ₃ ⁸	$\sim 1 \times 10^{-8}$	Anthropogenic	Photochemical

¹ Levels in the absence of gross pollution

² From biological sources

³ Reactions induced by the absorption of light energy as described later in this chapter and in Chapters 15–16

⁴ Sources arising from human activities

⁵ Sum of NO, NO₂, and NO₃, of which NO₃ is a major reactive species in the atmosphere at night

⁶ Reactive free radical species with 1 unpaired electron; these are transient species whose concentrations become much lower at night

⁷ A chlorofluorocarbon, Freon F-12

⁸ Methyl chloroform

The fact that atmospheric pressure decreases as an approximately exponential function of altitude largely determines the characteristics of the atmosphere. Figure 14.1 shows the variation of the pressure, P_h , as a function of altitude. This figure shows the extremes of pressure and temperature that occur in the atmosphere. The characteristics of the atmosphere vary widely with altitude, time (season), location (latitude), and even solar activity. At very high altitudes, normally reactive species such as atomic oxygen, O, persist for long periods of time. That occurs because the pressure is very low at these altitudes such that the distance traveled by a reactive species before it collides with a potential reactant—its **mean free path**—is quite high. A particle with a mean free path of 1×10^{-6} cm at sea level has a mean free path greater than 1×10^6 cm at an altitude of 500 km, where the pressure is lower by many orders of magnitude.

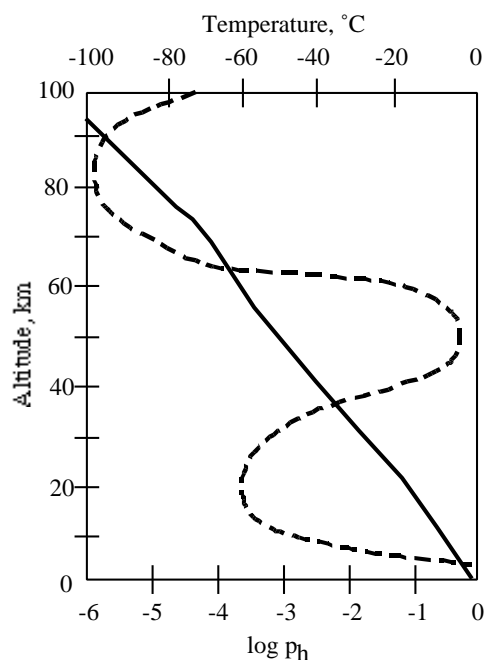

Figure 14.1 Variation of pressure (solid line) and temperature (dashed line) with altitude.

Stratification of the Atmosphere

As shown in Figure 14.2, the atmosphere is stratified on the basis of the temperature/density relationships resulting from interactions between physical and photochemical (light-induced chemical phenomena) processes in air.

The lowest layer of the atmosphere extending from sea level to an altitude of 10–16 km is the **troposphere**, characterized by a generally homogeneous composition of major gases other than water and decreasing temperature with increasing altitude from the heat-radiating surface of the earth. The upper limit of the troposphere, which has a temperature minimum of about -56°C , varies in altitude by a kilometer or more with atmospheric temperature, underlying terrestrial surface, and

time. The homogeneous composition of the troposphere results from constant mixing by circulating air masses. However, the water vapor content of the troposphere is extremely variable because of cloud formation, precipitation, and evaporation of water from terrestrial water bodies.

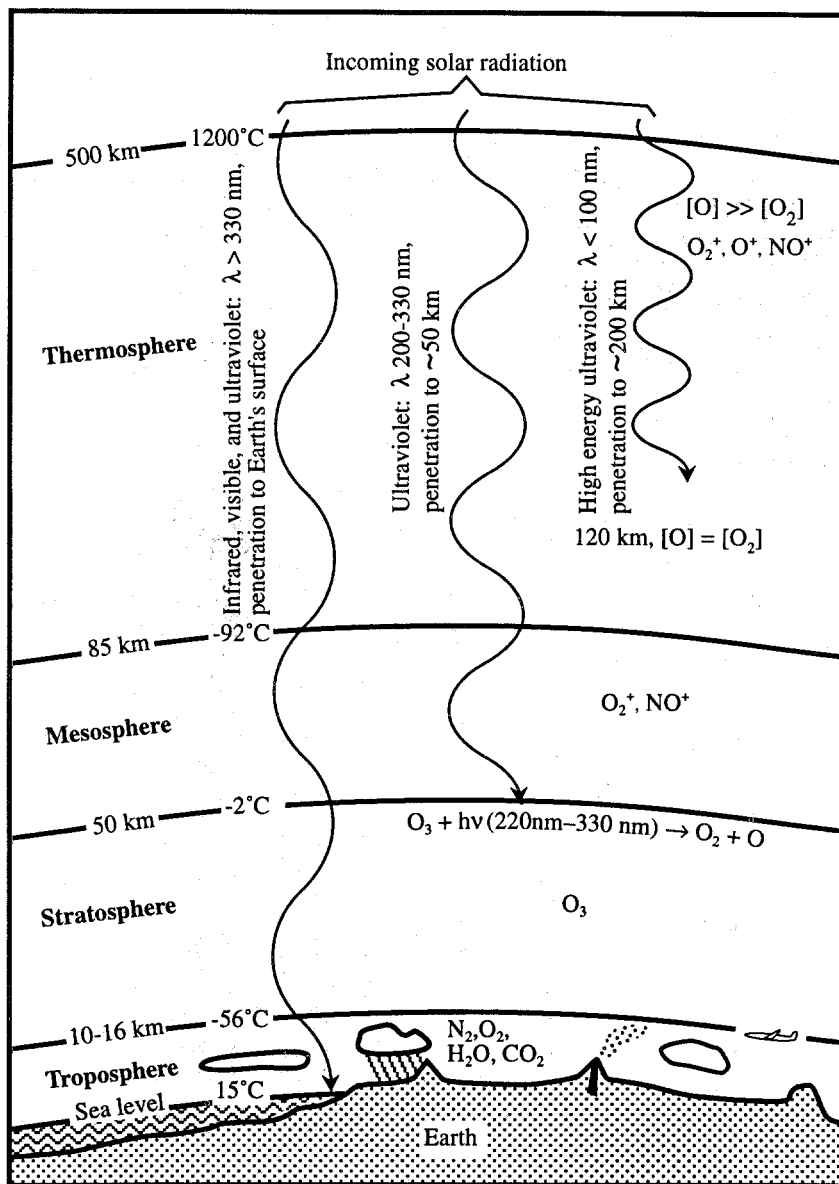

Figure 14.2 Major regions of the atmosphere (not to scale).

The very cold temperature of the **tropopause** layer at the top of the troposphere serves as a barrier that causes water vapor to condense to ice so that it cannot reach altitudes at which it would photodissociate through the action of intense high-energy

ultraviolet radiation. If this happened, the hydrogen produced would escape the earth's atmosphere and be lost. (Much of the hydrogen and helium gases originally present in the earth's atmosphere were lost by this process.)

The atmospheric layer directly above the troposphere is the **stratosphere**, in which the temperature rises to a maximum of about -2°C with increasing altitude. This phenomenon is due to the presence of ozone, O_3 , which can reach a level of around 10 ppm by volume in the mid-range of the stratosphere. The heating effect is caused by the absorption of ultraviolet radiation energy by ozone, a phenomenon discussed later in this chapter.

The absence of high levels of radiation-absorbing species in the **mesosphere** immediately above the stratosphere results in a further temperature decrease to about -92°C at an altitude around 85 km. The upper regions of the mesosphere and higher define a region, called the exosphere, from which molecules and ions can completely escape the atmosphere. Extending to the far outer reaches of the atmosphere is the **thermosphere**, in which the highly rarified gas reaches temperatures as high as 1200°C by the absorption of very energetic radiation of wavelengths less than approximately 200 nm by gas species in this region.

14.4 ENERGY TRANSFER IN THE ATMOSPHERE

The physical and chemical characteristics of the atmosphere and the critical heat balance of the earth are determined by energy and mass transfer processes in the atmosphere. Energy transfer phenomena are addressed in this section and mass transfer in Section 14.5. Incoming solar energy is largely in the visible region of the spectrum. The shorter wavelength blue solar light is scattered relatively more strongly by molecules and particles in the upper atmosphere, which is why the sky is blue as it is viewed by scattered light. Similarly, light that has been transmitted through scattering atmospheres appears red, particularly around sunset and sunrise, and under circumstances in which the atmosphere contains a high level of particles. The solar energy flux reaching the atmosphere is huge, amounting to 1.34×10^3 watts per square meter (114.2 kcal per minute per square meter) perpendicular to the line of solar flux at the top of the atmosphere, as illustrated in [Figure 14.3](#). This value is the **solar constant**, and may be termed **insolation**, which stands for "incoming solar radiation." If all this energy reached the earth's surface and was retained, the planet would have vaporized long ago. As it is, the complex factors involved in maintaining the Earth's heat balance within very narrow limits are crucial to retaining conditions of climate that will support present levels of life on earth. The great changes of climate that resulted in ice ages during some periods, or tropical conditions during others, were caused by variations of only a few degrees in average temperature. Marked climate changes within recorded history have been caused by much smaller average temperature changes. The mechanisms by which the earth's average temperature is retained within its present narrow range are complex and not completely understood, but the main features are explained here.

About half of the solar radiation entering the atmosphere reaches the earth's surface either directly or after scattering by clouds, atmospheric gases, or particles. The remaining half of the radiation is either reflected directly back or absorbed in the atmosphere, and its energy radiated back into space at a later time as infrared

radiation. Most of the solar energy reaching the surface is absorbed and it must be returned to space to maintain heat balance. In addition, a very small amount of energy (less than 1% of that received from the sun) reaches the earth's surface by convection and conduction processes from the earth's hot mantle, and this, too, must be lost.

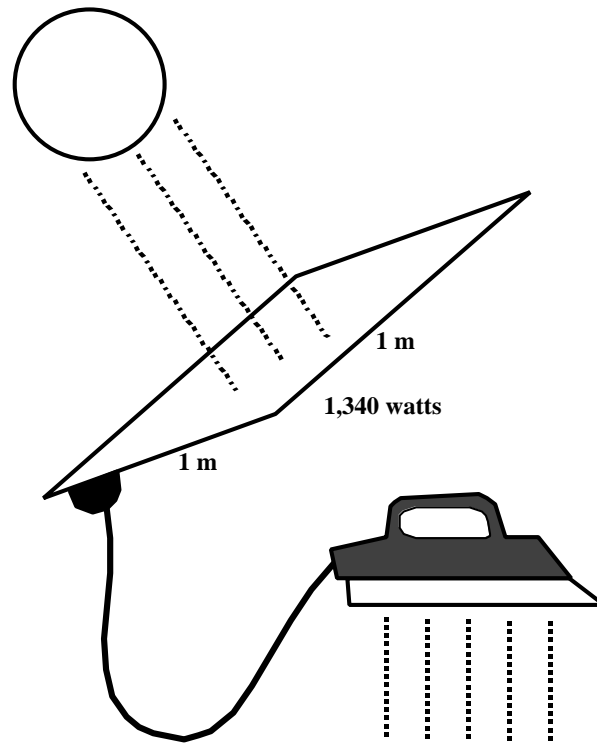

Figure 14.3 The solar flux at the distance of the earth from the sun is 1.34×10^3 watts/m².

Energy transport, which is crucial to eventual reradiation of energy from the earth, is accomplished by three major mechanisms. These are conduction, convection, and radiation. **Conduction** of energy occurs through the interaction of adjacent atoms or molecules without the bulk movement of matter and is a relatively slow means of transferring energy in the atmosphere. **Convection** involves the movement of whole masses of air, which may be either relatively warm or cold. It is the mechanism by which abrupt temperature variations occur when large masses of air move across an area. As well as carrying **sensible heat** due to the kinetic energy of molecules, convection carries **latent heat** in the form of water vapor that releases heat as it condenses. An appreciable fraction of the earth's surface heat is transported to clouds in the atmosphere by conduction and convection before being lost ultimately by radiation.

Radiation of energy in Earth's atmosphere occurs through electromagnetic radiation in the infrared region of the spectrum. Electromagnetic radiation is the only way in which energy is transmitted through a vacuum; therefore, it is the means by which all of the energy that must be lost from the planet to maintain its heat balance is ultimately returned to space. The electromagnetic radiation that carries energy

away from the earth is of a much longer wavelength than the sunlight that brings energy to the earth. This is a crucial factor in maintaining the earth's heat balance, and one susceptible to upset by human activities. The maximum intensity of incoming radiation occurs at 0.5 micrometers (500 nanometers) in the visible region, with essentially none outside the range of 0.2 μm to 3 μm . This range encompasses the whole visible region and small parts of the ultraviolet and infrared adjacent to it. Outgoing radiation is in the infrared region, with maximum intensity at about 10 μm , primarily between 2 μm and 40 μm . Thus the earth loses energy by electromagnetic radiation of a much longer wavelength (lower energy per photon) than the radiation by which it receives energy.

Earth's Radiation Budget

The earth's radiation budget is illustrated in [Figure 14.4](#). The average surface temperature is maintained at a relatively comfortable 15°C because of an atmospheric "greenhouse effect" in which water vapor and, to a lesser extent, carbon dioxide reabsorb much of the outgoing radiation and reradiate about half of it back to the surface. Were this not the case, the surface temperature would be significantly lower, around -18°C. Most of the absorption of infrared radiation is done by water molecules in the atmosphere. Absorption is weak in the regions 7–8.5 μm and 11–14 μm , and nonexistent between 8.5 μm and 11 μm , leaving a "hole" in the infrared absorption spectrum through which radiation may escape. Carbon dioxide, though present at a much lower concentration than water vapor, absorbs strongly between 12 μm and 16.3 μm , and plays a key role in maintaining the heat balance. There is concern that an increase in the carbon dioxide level in the atmosphere could prevent sufficient energy loss to cause a perceptible and damaging increase in the earth's temperature. This phenomenon, discussed in more detail in Section 15.6, is popularly known as the **greenhouse effect** and may occur from elevated CO₂ levels caused by increased use of fossil fuels and the destruction of massive quantities of forests.

An important aspect of solar radiation that reaches Earth's surface is the percentage reflected from the surface, described as **albedo**. Albedo is important in determining Earth's heat balance, in that absorbed radiation heats the surface, and reflected radiation does not. Albedo varies spectacularly with the surface. At the two extremes, freshly fallen snow has an albedo of 90% because it reflects 9/10 of incoming radiation, whereas freshly plowed black topsoil has an albedo of only about 2.5%.

14.5 ATMOSPHERIC MASS TRANSFER, METEOROLOGY, AND WEATHER

Meteorology is the science of atmospheric phenomena, encompassing the study of the movement of air masses as well as physical forces in the atmosphere—heat, wind, and transitions of water, primarily liquid to vapor or vice versa. Meteorological phenomena affect, and in turn are affected by, the chemical properties of the atmosphere. For example, before modern emission controls took effect, meteorological phenomena determined whether power plant stack gas heavily laced with

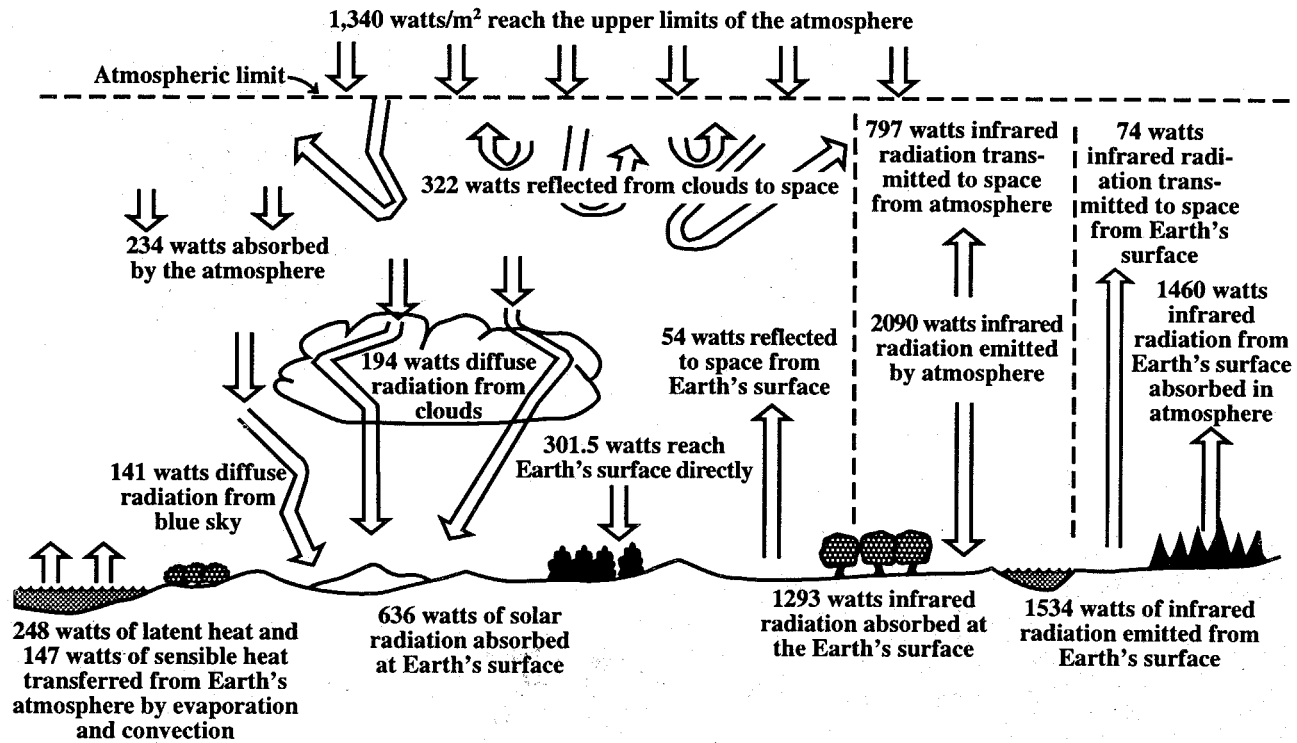

Figure 14.4. Earth's radiation budget expressed on the basis of portions of the 1340 watts/m² composing the solar flux.

fur dioxide would be dispersed high in the atmosphere with little direct effect upon human health, or would settle as a choking chemical blanket in the vicinity of the power plant. Los Angeles largely owes its susceptibility to smog to the meteorology of the Los Angeles basin, which holds hydrocarbons and nitrogen oxides long enough to cook up an unpleasant brew of damaging chemicals under the intense rays of the sun (see the discussion of photochemical smog in Chapter 16). Short-term variations in the state of the atmosphere constitute **weather**. The weather is defined in terms of seven major factors: temperature, clouds, winds, humidity, horizontal visibility (as affected by fog, etc.), type and quantity of precipitation, and atmospheric pressure. All of these factors are closely interrelated. Longer-term variations and trends within a particular geographical region in those factors that compose weather are described as **climate**, a term defined and discussed in Section 14.7.

Atmospheric Water in Energy and Mass Transfer

The driving force behind weather and climate is the distribution and ultimate re-radiation to space of solar energy. A large fraction of solar energy is converted to latent heat by evaporation of water into the atmosphere. As water condenses from atmospheric air, large quantities of heat are released. This is a particularly significant means for transferring energy from the ocean to land. Solar energy falling on the ocean is converted to latent heat by the evaporation of water, then the water vapor moves inland, where it condenses. The latent heat released when the water condenses warms the surrounding land mass.

Atmospheric water can be present as vapor, liquid, or ice. The water vapor content of air can be expressed as **humidity**. **Relative humidity**, expressed as a percentage, describes the amount of water vapor in the air as a ratio of the maximum amount that the air can hold at that temperature. Air with a given relative humidity can undergo any of several processes to reach the saturation point at which water vapor condenses in the form of rain or snow. For this condensation to happen, air must be cooled below a temperature called the **dew point**, and **condensation nuclei** must be present. These nuclei are hygroscopic substances such as salts, sulfuric acid droplets, and some organic materials, including bacterial cells. Air pollution in some forms is an important source of condensation nuclei.

The liquid water in the atmosphere is present largely in **clouds**. Clouds normally form when rising, adiabatically cooling air can no longer hold water in the vapor form, and the water forms very small aerosol droplets. Clouds can be classified in three major forms. Cirrus clouds occur at great altitudes and have a thin feathery appearance. Cumulus clouds are detached masses with a flat base and frequently a “bumpy” upper structure. Stratus clouds occur in large sheets and may cover all of the sky visible from a given point as overcast. Clouds are important absorbers and reflectors of radiation (heat). Their formation is affected by the products of human activities, especially particulate matter pollution and emission of deliquescent gases such as SO_2 and HCl .

The formation of precipitation from the very small droplets of water that compose clouds is a complicated and important process. Cloud droplets normally take somewhat longer than a minute to form by condensation. They average about

0.04 mm across and do not exceed 0.2 mm in diameter. Raindrops range from 0.5–4 mm in diameter. Condensation processes do not form particles large enough to fall as precipitation (rain, snow, sleet, or hail). The small condensation droplets must collide and coalesce to form precipitation-size particles. When droplets reach a threshold diameter of about 0.04 mm, they grow more rapidly by coalescence with other particles than by condensation of water vapor.

Air Masses

Distinct air masses are a major feature of the troposphere. These air masses are uniform and horizontally homogeneous with respect to temperature and water vapor content. These characteristics are determined by the nature of the surface over which a large air mass forms. Polar continental air masses form over cold land regions; polar maritime air masses form over polar oceans. Air masses originating in the tropics may be similarly classified as tropical continental air masses or tropical maritime air masses. The movement of air masses and the conditions in them may have important effects upon pollutant reactions, effects, and dispersal.

Solar energy received by Earth is largely redistributed by the movement of huge masses of air with different pressures, temperatures, and moisture contents separated by boundaries called **fronts**. Horizontally moving air is called **wind**, whereas vertically moving air is referred to as an **air current**. Atmospheric air moves constantly, with behavior and effects that reflect the laws governing the behavior of gases. First of all, gases will move horizontally and/or vertically from regions of *high atmospheric pressure* to those of *low atmospheric pressure*. Furthermore, expansion of gases causes cooling, whereas compression causes warming. A mass of warm air tends to move from Earth's surface to higher altitudes, where the pressure is lower; in so doing, it expands *adiabatically* (that is, without exchanging energy with its surroundings) and becomes cooler. If there is no condensation of moisture from the air, the cooling effect is about 10°C per 1000 meters of altitude, a figure known as the **dry adiabatic lapse rate**. A cold mass of air at a higher altitude does the opposite; it sinks and becomes warmer at about 10°C/1000 m. Often, however, when there is sufficient moisture in rising air, water condenses from it, releasing latent heat. This partially counteracts the cooling effect of the expanding air, giving a **moist adiabatic lapse rate** of about 6°C/1000 m. Parcels of air do not rise and fall, or even move horizontally in a completely uniform way, but exhibit eddies, currents, and various degrees of turbulence.

Wind—air moving horizontally—occurs because of differences in air pressure from high pressure regions to low pressure areas. Air currents (vertically moving air) are largely **convection currents** formed by differential heating of air masses. Air that is over a solar heated land mass is warmed, becomes less dense, and rises, to be replaced by cooler and more dense air. Wind and air currents are strongly involved with air pollution phenomena. Wind carries and disperses air pollutants. In some cases, the absence of wind can enable pollutants to collect in a region and undergo processes that lead to even more (secondary) pollutants. Prevailing wind direction is an important factor in determining the areas most affected by an air pollution source. Wind is an important renewable energy resource (see Chapter 24). Furthermore, wind plays an important role in the propagation of life by dispersing spores, seeds, and organisms, such as spiders.

Topographical Effects

Topography, the surface configuration and relief features of the earth's surface, may strongly affect winds and air currents. Differential heating and cooling of land surfaces and bodies of water can result in **local convective winds**, including land breezes and sea breezes at different times of the day along the seashore, as well as breezes associated with large bodies of water inland. Mountain topography causes complex and variable localized winds. The masses of air in mountain valleys heat up during the day causing upslope winds, and cool off at night, causing downslope winds. Upslope winds flow over ridge tops in mountainous regions. The blocking of wind and of masses of air by mountain formations some distance inland from seashores can trap bodies of air, particularly when temperature inversion conditions occur (see Section 14.6).

Movement of Air Masses

Basically, weather is the result of the interactive effects of (1) redistribution of solar energy, (2) horizontal and vertical movement of air masses with varying moisture contents, and (3) evaporation and condensation of water, accompanied by uptake and release of heat. To see how these factors determine weather—and ultimately climate—on a global scale, first consider the cycle illustrated in [Figure 14.5](#). This figure shows solar energy being absorbed by a body of water and causing some water to evaporate. The warm, moist mass of air thus produced moves from a region of high pressure to one of low pressure, and cools by expansion as it rises in what is called a **convection column**. As the air cools, water condenses from it and energy is released; this is a major pathway by which energy is transferred from the earth's surface to high in the atmosphere. As a result of condensation of water and loss of energy, the air is converted from warm, moist air to cool, dry air. Furthermore, the movement of the parcel of air to high altitudes results in a degree of “crowding” of air molecules and creates a zone of relatively greater pressure high in the troposphere at the top of the convection column. This air mass, in turn, moves from the upper-level region of high pressure to one of low pressure; in so doing, it subsides, thus creating an upper-level low pressure zone, and becomes warm, dry air in the process. The pileup of this air at the surface creates a surface high pressure zone where the cycle described above began. The warm, dry air in this surface high pressure zone again picks up moisture, and the cycle begins again.

Global Weather

The factors discussed above that determine and describe the movement of air masses are involved in the massive movement of air, moisture, and energy that occurs globally. The central feature of global weather is the redistribution of solar energy that falls unequally on earth at different latitudes (relative distances from the equator and poles). Consider [Figure 14.6](#). Sunlight, and the energy flux from it, is most intense at the equator because, averaged over the seasons, solar radiation comes in perpendicular to Earth's surface at the equator. With increasing distance from the

equator (higher latitudes) the angle is increasingly oblique and more of the energy-

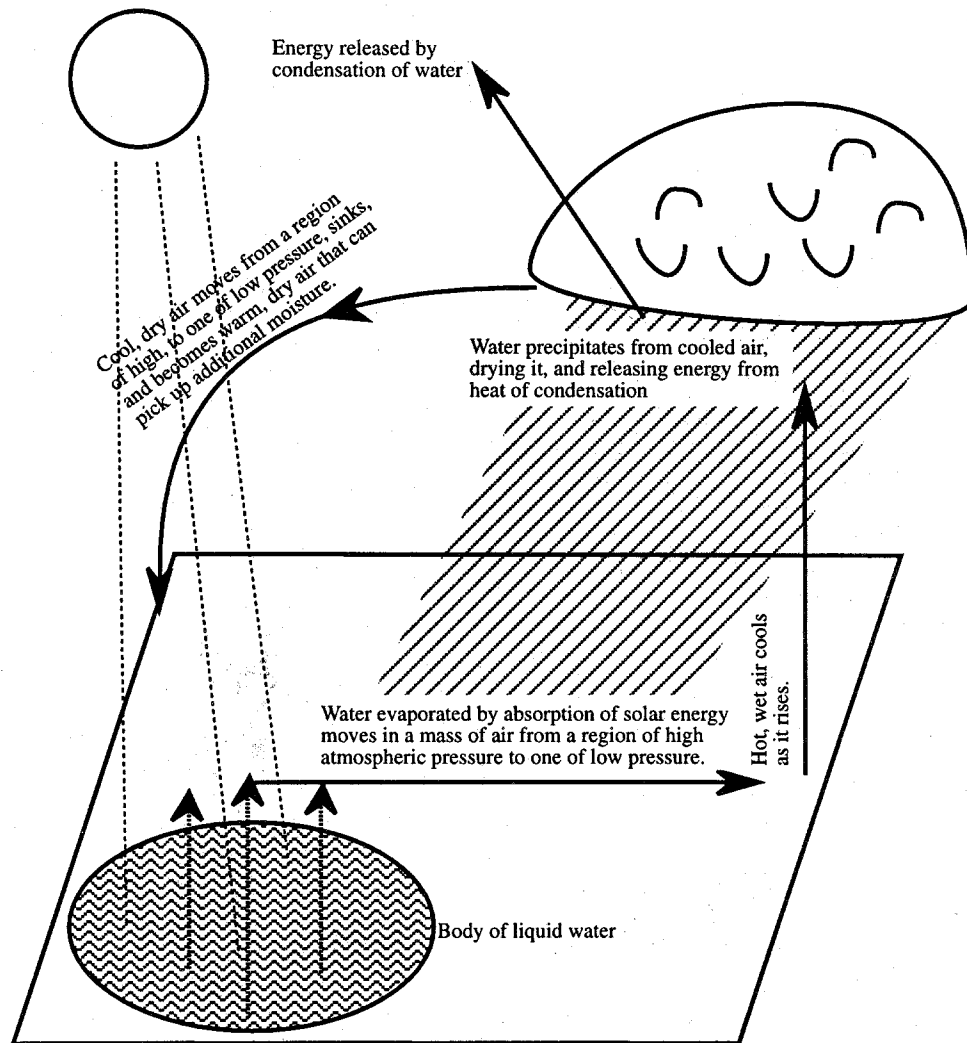

Figure 14.5 Circulation patterns involved with movement of air masses and water; uptake and release of solar energy as latent heat in water vapor.

absorbing atmosphere must be traversed, so that progressively less energy is received per unit area of Earth's surface. The net result is that equatorial regions receive a much greater share of solar radiation, progressively less is received farther from the Equator, and the poles receive a comparatively minuscule amount. The excess heat energy in the equatorial regions causes the air to rise. The air ceases to rise when it reaches the stratosphere because in the stratosphere the air becomes warmer with higher elevation. As the hot equatorial air rises in the troposphere, it cools by expansion and loss of water, then sinks again. The air circulation patterns in which this occurs are called **Hadley cells**. As shown in [Figure 14.6](#), there are three

major groupings of these cells, which result in very distinct climatic regions on Earth's surface. The air in the Hadley cells does not move straight north and south, but is deflected by earth's rotation and by contact with the rotating earth; this is the **Coriolis effect**, which results in spiral-shaped air circulation patterns called cyclonic or anticyclonic, depending upon the direction of rotation. These give rise to different directions of prevailing winds, depending on latitude. The boundaries between the massive bodies of circulating air shift markedly over time and season, resulting in significant weather instability.

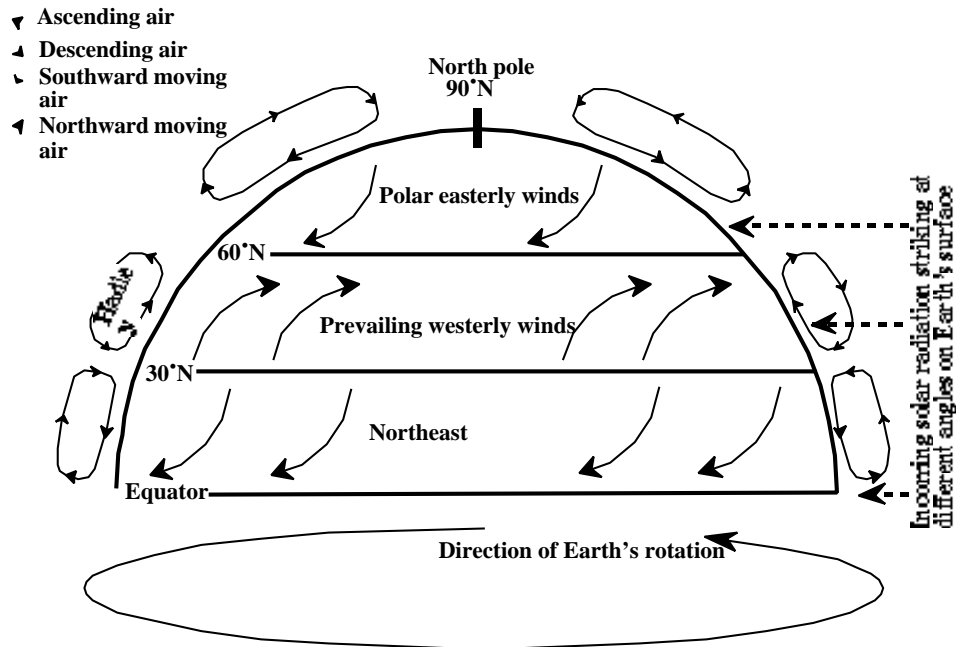

Figure 14.6 Global circulation of air in the northern hemisphere.

The movement of air in Hadley cells combines with other atmospheric phenomena to produce massive **jet streams** that are, in a sense, shifting rivers of air that may be several kilometers deep and several tens of km wide. Jet streams move through discontinuities in the tropopause (see Section 14.2), generally from west to east at velocities around 200 km/hr (well over 100 mph); in so doing, they redistribute huge amounts of air and have a strong influence on weather patterns.

The air and wind circulation patterns described above shift massive amounts of energy over long distances on Earth. If it weren't for this effect, the equatorial regions would be unbearably hot, and the regions closer to the poles intolerably cold. About half of the heat that is redistributed is carried as sensible heat by air circulation, almost 1/3 is carried by water vapor as latent heat, and the remaining approximately 20% is moved by ocean currents.

Weather Fronts and Storms

As noted earlier, the interface between two masses of air that differ in

temperature, density, and water content is called a **front**. A mass of cold air moving such that it displaces one of warm air is a **cold front**, and a mass of warm air displacing one of cold air is a **warm front**. Since cold air is more dense than warm air, the air in a cold mass of air along a cold front pushes under warmer air. This causes the warm, moist air to rise such that water condenses from it. The condensation of water releases energy, so the air rises farther. The net effect can be formation of huge cloud formations (thunderheads) that may reach stratospheric levels. These spectacular thunderheads can produce heavy rainfall and even hail, and sometimes violent storms with strong winds, including tornadoes. Warm fronts cause somewhat similar effects as warm, moist air pushes over colder air. However, the front is usually much broader, and the weather effects milder, typically resulting in widespread drizzle rather than intense rainstorms.

Swirling **cyclonic storms**, such as typhoons, hurricanes, and tornadoes, are created in low pressure areas by rising masses of warm, moist air. As such air cools, water vapor condenses, and the latent heat released warms the air more, sustaining and intensifying its movement upward in the atmosphere. Air rising from surface level creates a low pressure zone into which surrounding air moves. The movement of the incoming air assumes a spiral pattern, thus causing a cyclonic storm.

14.6 INVERSIONS AND AIR POLLUTION

The complicated movement of air across the earth's surface is a crucial factor in the creation and dispersal of air pollution phenomena. When air movement ceases, stagnation can occur, with a resultant buildup of atmospheric pollutants in localized regions. Although the temperature of air relatively near the earth's surface normally decreases with increasing altitude, certain atmospheric conditions can result in the opposite condition—increasing temperature with increasing altitude. Such conditions are characterized by high atmospheric stability and are known as **temperature inversions**. Because they limit the vertical circulation of air, temperature inversions result in air stagnation and the trapping of air pollutants in localized areas.

Inversions can occur in several ways. In a sense, the whole atmosphere is inverted by the warm stratosphere, which floats atop the troposphere with relatively little mixing. An inversion can form from the collision of a warm air mass (warm front) with a cold air mass (cold front). The warm air mass overrides the cold air mass in the frontal area, producing the inversion. **Radiation inversions** are likely to form in still air at night when the earth is no longer receiving solar radiation. The air closest to the earth cools faster than the air higher in the atmosphere, which remains warm, thus less dense. Furthermore, cooler surface air tends to flow into valleys at night, where it is overlain by warmer, less dense air. **Subsidence inversions**, often accompanied by radiation inversions, can become very widespread. These inversions can form in the vicinity of a surface high pressure area when high-level air subsides to take the place of surface air blowing out of the high pressure zone. The subsiding air is warmed as it compresses and can remain as a warm layer several hundred meters above ground level. A **marine inversion** is produced during the summer months when cool air laden with moisture from the ocean blows onshore and under warm, dry inland air.

As noted above, inversions contribute significantly to the effects of air pollution

because, as shown in Figure 14.7, they prevent mixing of air pollutants, thus keeping the pollutants in one area. This not only prevents the pollutants from escaping, but also acts like a container in which additional pollutants accumulate. Furthermore, in the case of secondary pollutants formed by atmospheric chemical processes, such as photochemical smog (see Chapter 16), the pollutants may be kept together such that they react with each other and with sunlight to produce even more noxious products.

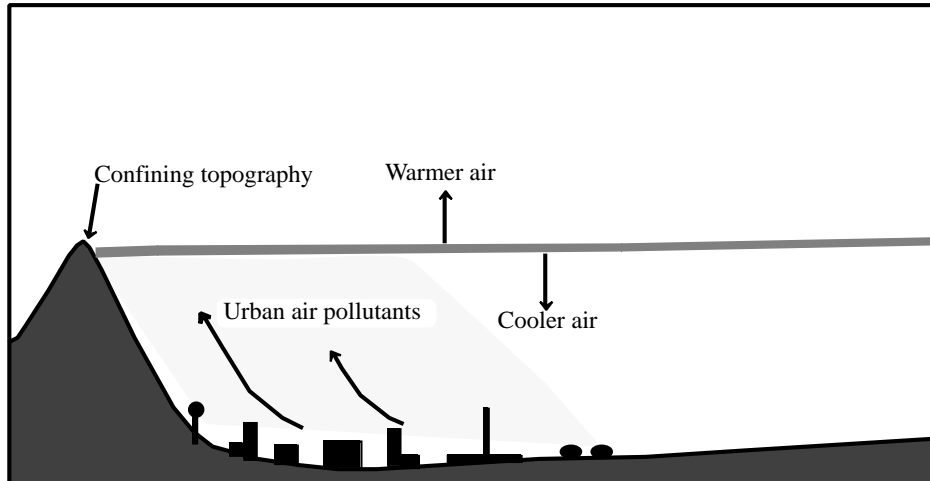

Figure 14.7 Illustration of pollutants trapped in a temperature inversion.

14.7 GLOBAL CLIMATE AND MICROCLIMATE

Perhaps the single most important influence on Earth's environment is **climate**, consisting of long-term weather patterns over large geographical areas. As a general rule, climatic conditions are characteristic of a particular region. This does not mean that climate remains the same throughout the year, of course, because it varies with season. One important example of such variation is the **monsoon**, seasonal variations in wind patterns between oceans and continents. The climates of Africa and the Indian subcontinent are particularly influenced by monsoons. In the latter, for example, summer heating of the Indian land mass causes air to rise, thereby creating a low pressure area that attracts warm, moist air from the ocean. This air rises on the slopes of the Himalayan mountains, which also block the flow of colder air from the north; moisture from the air condenses; and monsoon rains carrying enormous amounts of precipitation fall. Thus, from May until sometime into August, summer monsoon rains fall in India, Bangladesh, and Nepal. Reversal of the pattern of winds during the winter months causes these regions to have a dry season, but produces winter monsoon rains in the Philippine islands, Indonesia, New Guinea, and Australia.

Summer monsoon rains are responsible for tropical rain forests in Central Africa. The interface between this region and the Sahara Desert varies over time. When the boundary is relatively far north, rain falls on the Sahel desert region at the interface, crops grow, and the people do relatively well. When the boundary is more to the south, a condition that may last for several years, devastating droughts and even

starvation may occur.

It is known that there are fluctuations, cycles, and cycles imposed on cycles in climate. The causes of these variations are not completely understood, but they are known to be substantial, and even devastating to civilization. The last **ice age**, which ended only about 10,000 years ago and which was preceded by several similar ice ages, produced conditions under which much of the present land mass of the Northern Hemisphere was buried under thick layers of ice and, thus, uninhabitable. A “mini-ice age” occurred during the 1300s, causing crop failures and severe hardship in northern Europe. In modern times, the El Niño Southern Oscillation occurs with a period of several years when a large, semi-permanent tropical low pressure area shifts into the Central Pacific region from its more common location in the vicinity of Indonesia. This shift modifies prevailing winds, changes the pattern of ocean currents, and affects upwelling of ocean nutrients with profound effects on weather, rainfall, and fish and bird life over a vast area of the Pacific from Australia to the west coasts of South and North America.

Human Modifications of Climate

Although Earth’s atmosphere is huge and has an enormous ability to resist and correct for detrimental change, it is possible that human activities are reaching a point at which they may be adversely affecting climate. One such way is by emission of large quantities of carbon dioxide and other greenhouse gases into the atmosphere, such that global warming may occur and cause substantial climatic change. Another way is through the release of gases, particularly chlorofluorocarbons (Freons) that may cause destruction of vital stratospheric ozone. Human activities that may affect climate are addressed in the next two chapters.

Microclimate

The preceding section described climate on a large scale, ranging up to global dimensions. The climate that organisms and objects on the surface are exposed to close to the ground, under rocks, and surrounded by vegetation, is often quite different from the surrounding macroclimate. Such highly localized climatic conditions are termed the **microclimate**. Microclimate effects are largely determined by the uptake and loss of solar energy very close to Earth’s surface, and by the fact that air circulation due to wind is much lower at the surface. During the day, solar energy absorbed by relatively bare soil heats the surface, but is lost only slowly because of very limited air circulation at the surface. This provides a warm blanket of surface air several cm thick, and an even thinner layer of warm soil. At night, radiative loss of heat from the surface of soil and vegetation can result in surface temperatures several degrees colder than the air about 2 meters above ground level. These lower temperatures result in condensation of **dew** on vegetation and the soil surface, thus providing a relatively more moist microclimate near ground level. Heat absorbed during early morning evaporation of the dew tends to prolong the period of cold experienced right at the surface.

Vegetation substantially affects microclimate. In relatively dense growths, circu-

lation can be virtually zero at the surface because vegetation severely limits convection and diffusion. The crown surface of the vegetation intercepts most of the solar energy, so that maximum solar heating may be a significant distance up from Earth's surface. The region below the crown surface of vegetation thus becomes one of relatively stable temperature. In addition, in a dense growth of vegetation, most of the moisture loss is not from evaporation from the soil surface, but rather from transpiration from plant leaves. The net result is the creation of temperature and humidity conditions that provide a favorable living environment for a number of organisms, such as insects and rodents.

Another factor influencing microclimate is the degree to which the slope of land faces north or south. South-facing slopes of land in the Northern Hemisphere receive greater solar energy. Advantage has been taken of this phenomenon in restoring land strip-mined for brown coal in Germany by terracing the land such that the terraces have broad south slopes and very narrow north slopes. On the south-sloping portions of the terrace, the net effect has been to extend the short summer growing season by several days, thereby significantly increasing crop productivity. In areas where the growing season is longer, better growing conditions may exist on a north slope because it is less subject to temperature extremes and to loss of water by evaporation and transpiration.

Effects of Urbanization on Microclimate

A particularly marked effect on microclimate is that induced by urbanization. In a rural setting, vegetation and bodies of water have a moderating effect, absorbing modest amounts of solar energy and releasing it slowly. The stone, concrete, and asphalt pavement of cities have an opposite effect, strongly absorbing solar energy, and re-radiating heat back to the urban microclimate. Rainfall is not allowed to accumulate in ponds, but is drained away as rapidly and efficiently as possible. Human activities generate significant amounts of heat, and produce large quantities of CO₂ and other greenhouse gases that retain heat. The net result of these effects is that a city is capped by a **heat dome** in which the temperature is as much as 5°C warmer than in the surrounding rural areas, such that large cities have been described as "heat islands." The rising warmer air over a city brings in a breeze from the surrounding area and causes a local greenhouse effect that probably is largely counterbalanced by reflection of incoming solar energy by particulate matter above cities. Overall, compared with climatic conditions in nearby rural surroundings, the city microclimate is warmer, foggier, overlain with more cloud cover a greater percentage of the time, and subject to more precipitation, though generally the city microclimate is less humid.

14.8 CHEMICAL AND PHOTOCHEMICAL REACTIONS IN THE ATMOSPHERE

Figure 14.8 represents some of the major atmospheric chemical processes, which are discussed under the topic of atmospheric chemistry. The study of atmospheric chemical reactions is difficult. One of the primary obstacles encountered in studying atmospheric chemistry is that the chemist generally must deal with

incredibly low concentrations, so that the detection and analysis of reaction products is quite difficult. Simulating high-altitude conditions in the laboratory can be extremely hard because of interferences, such as those from species given off from container walls under conditions of very low pressure. Many chemical reactions that require a third body to absorb excess energy occur very slowly in the upper atmosphere where there is a sparse concentration of third bodies, but occur readily in a container whose walls effectively absorb energy. Container walls may serve as catalysts for some important reactions, or they may absorb important species and react chemically with the more reactive ones.

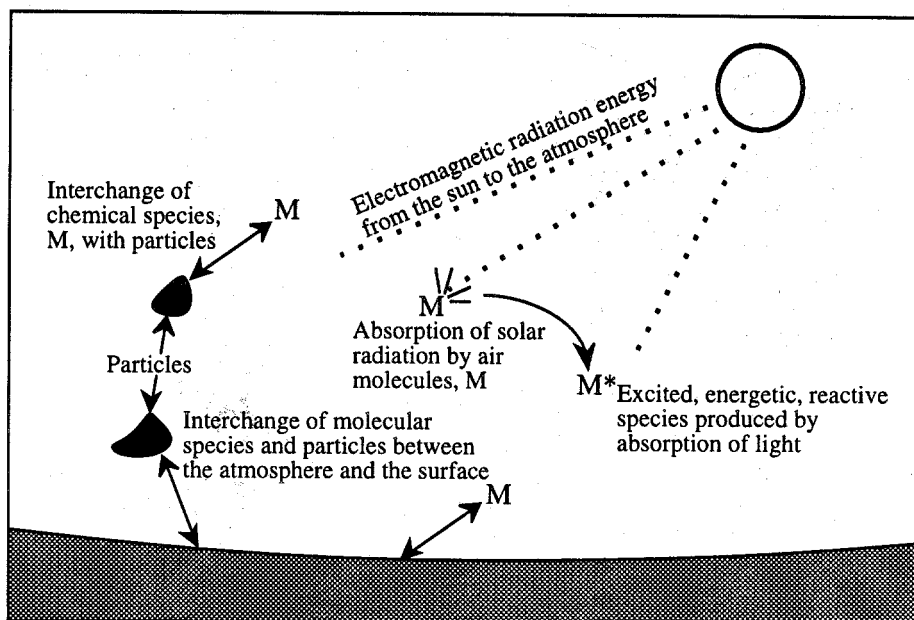

Figure 14.8 Representation of major atmospheric chemical processes.

Atmospheric chemistry involves the unpolluted atmosphere, highly polluted atmospheres, and a wide range of gradations in between. The same general phenomena govern all and produce one huge atmospheric cycle in which there are numerous subcycles. Gaseous atmospheric chemical species fall into the following somewhat arbitrary and overlapping classifications: Inorganic oxides (CO , CO_2 , NO_2 , SO_2), oxidants (O_3 , H_2O_2 , $\text{HO}\cdot$ radical, $\text{HO}_2\cdot$ radical, $\text{ROO}\cdot$ radicals, NO_3), reductants (CO , SO_2 , H_2S), organics (also reductants; in the unpolluted atmosphere, CH_4 is the predominant organic species, whereas alkanes, alkenes, and aryl compounds are common around sources of organic pollution), oxidized organic species (carbonyls, organic nitrates), photochemically active species (NO_2 , formaldehyde), acids (H_2SO_4), bases (NH_3), salts (NH_4HSO_4), and unstable reactive species (electronically excited NO_2 , $\text{HO}\cdot$ radical). Both solid and liquid particles in atmospheric aerosols and clouds serve as sources and sinks for gas-phase species, as sites for surface reactions (solid particles), and as bodies for aqueous-phase reactions (liquid droplets). Two constituents of utmost importance in atmospheric chemistry are radiant energy from the sun, predominantly in the ultraviolet region of the spectrum,

and the hydroxyl radical, HO•. The former provides a way to pump a high level of energy into a single gas molecule to start a series of atmospheric chemical reactions, and the latter is the most important reactive intermediate and “currency” of daytime atmospheric chemical phenomena; NO₃ radicals are important intermediates in nighttime atmospheric chemistry.

Photochemical Processes

The absorption by chemical species of light, broadly defined here to include ultraviolet radiation from the sun, can bring about reactions, called **photochemical reactions**, which do not otherwise occur under the conditions (particularly the temperature) of the medium in the absence of light. Thus, photochemical reactions, even in the absence of a chemical catalyst, occur at temperatures much lower than those that otherwise would be required. Photochemical reactions, which are induced by intense solar radiation, play a very important role in determining the nature and ultimate fate of a chemical species in the atmosphere.

Nitrogen dioxide, NO₂, is one of the most photochemically active species found in a polluted atmosphere and is an essential participant in the smog-formation process. A species such as NO₂ may absorb light of energy $h\nu$, producing an **electronically excited molecule**,



designated in the reaction above by an asterisk, *. The photochemistry of nitrogen dioxide is discussed in greater detail in Chapters 15 and 16.

Electronically excited molecules are one of the three relatively reactive and unstable species that are encountered in the atmosphere and are strongly involved with atmospheric chemical processes. The other two species are atoms or molecular fragments with unshared electrons, called **free radicals**, and **ions** consisting of electrically charged atoms or molecular fragments.

Electronically excited molecules are produced when stable molecules absorb energetic electromagnetic radiation in the ultraviolet or visible regions of the spectrum. A molecule can possess several possible excited states, but generally ultraviolet or visible radiation is energetic enough to excite molecules only to several of the lowest energy levels. The nature of the excited state can be understood by considering the disposition of electrons in a molecule. Most molecules have an even number of electrons. The electrons occupy orbitals (see orbitals of atoms in Chapter 3, Section 3.12), with a maximum of two electrons with opposite spin occupying the same orbital. The absorption of light may promote one of these electrons to a vacant orbital of higher energy. In some cases the electron thus promoted retains a spin opposite to that of its former partner, giving rise to an **excited singlet state**. In other cases the spin of the promoted electron is reversed, such that it has the same spin as its former partner; this gives rise to an **excited triplet state**. These phenomena are illustrated in [Figure 14.9](#).

These excited states generated by the absorption of electromagnetic radiation are relatively energized compared with the ground state and are chemically reactive species. Their participation in atmospheric chemical reactions, such as those

involved in smog formation, will be discussed later in detail.

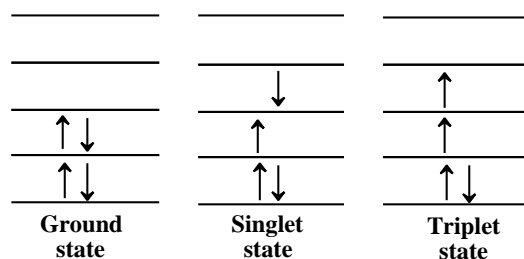
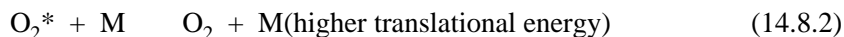

Figure 14.9 Representation of major atmospheric chemical processes.

For a photochemical reaction to occur, light must be absorbed by the reacting species. If the absorbed light is in the visible region of the sun's spectrum, the absorbing species is colored. Colored NO_2 is a common example of such a species in the atmosphere. Normally, the first step in a photochemical process is the activation of the molecule by the absorption of a single unit of photochemical energy characteristic of the frequency of the electromagnetic radiation (commonly ultraviolet radiation or visible light) called a **quantum** of electromagnetic radiation. The energy of one quantum is equal to the product $h\nu$, where h is Planck's constant, 6.63×10^{-27} erg·s (6.63×10^{-34} J·s), and ν is the frequency of the absorbed electromagnetic radiation in s^{-1} (inversely proportional to its wavelength, λ).

The reactions that occur following absorption of a photon of electromagnetic radiation to produce an electronically excited species are largely determined by the way in which the excited species loses its excess energy. This can occur by one of the following processes:

- Loss of energy to another molecule or atom (M) by **physical quenching**, followed by dissipation of the energy as heat



- **Dissociation** of the excited molecule (the process responsible for the predominance of atomic oxygen in the upper atmosphere)



- **Direct reaction** with another species



- **Luminescence** consisting of loss of energy by the emission of electromagnetic radiation



If the re-emission of light is almost instantaneous, luminescence is called

fluorescence, and if it is significantly delayed, the phenomenon is **phosphorescence**. **Chemiluminescence** is said to occur when the excited species (such as NO_2^* below) is formed by a chemical process:

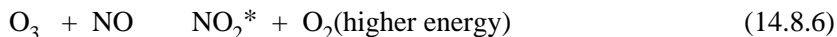

- **Intermolecular energy transfer** in which an excited species transfers energy to another species that then becomes excited



A subsequent reaction by the second species is called a **photosensitized** reaction.

- **Intramolecular transfer** in which energy is transferred within a molecule

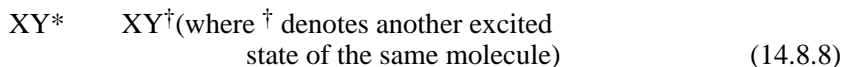

- **Spontaneous isomerization** as in the conversion of *o*-nitrobenzaldehyde to *o*-nitrosobenzoic acid, a reaction used in chemical actinometers to measure exposure to electromagnetic radiation:

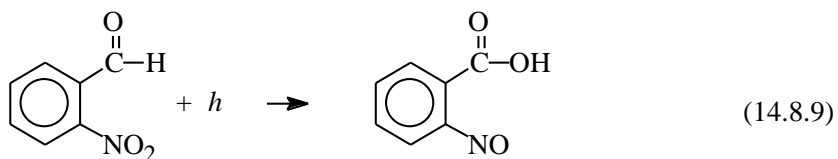

- **Photoionization** through loss of an electron



Electromagnetic radiation absorbed in the infrared region lacks the energy to break chemical bonds, but does cause the receptor molecules to gain vibrational and rotational energy. The energy absorbed as infrared radiation ultimately is dissipated as heat and raises the temperature of the whole atmosphere. As noted in Section 14.3, the absorption of infrared radiation is very important in the earth's acquiring heat from the sun and in the retention of energy radiated from the earth's surface.

Ions and Radicals in the Atmosphere

One of the characteristics of the upper atmosphere that is difficult to duplicate under laboratory conditions is the presence of significant levels of electrons and positive ions. Because of the rarefied conditions, these ions may exist in the upper atmosphere for long periods before recombining to form neutral species.

At altitudes of approximately 50 km and up, ions are so prevalent that the region is called the **ionosphere**. The presence of the ionosphere has been known since about 1901, when it was discovered that radio waves could be transmitted over long dis-

tances where the curvature of the earth makes line-of-sight transmission impossible. These radio waves bounce off the ionosphere.

Ultraviolet light is the primary producer of ions in the ionosphere. In darkness, the positive ions slowly recombine with free electrons. The process is more rapid in the lower regions of the ionosphere, where the concentration of species is relatively high. Thus, the lower limit of the ionosphere lifts at night and makes possible the transmission of radio waves over much greater distances.

The earth's magnetic field has a strong influence upon the ions in the upper atmosphere. Probably the best-known manifestation of this phenomenon is found in the Van Allen belts, discovered in 1958, consisting of two belts of ionized particles encircling the earth. They can be visualized as two doughnuts with the axis of Earth's magnetic field extending through the holes in the doughnuts. The inner belt consists of protons and the outer belt consists of electrons. A schematic diagram of the Van Allen belts is shown in Figure 14.10.

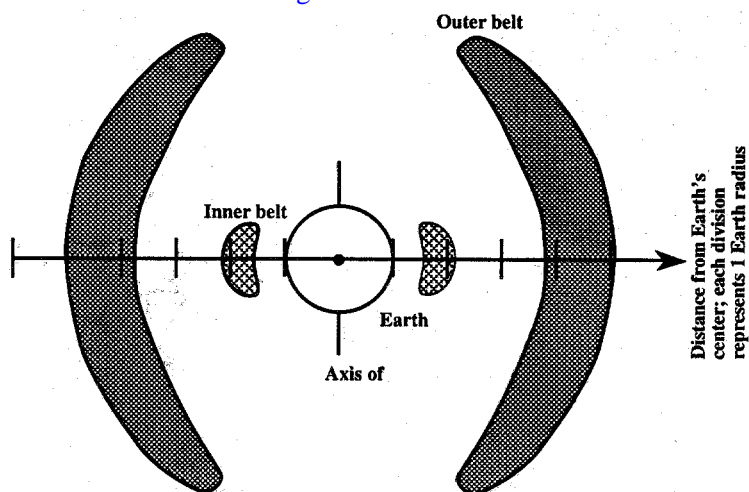
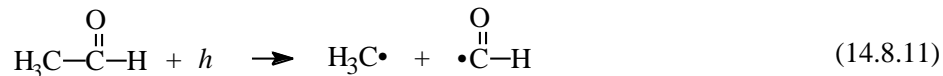

Figure 14.10 Cross section of the Van Allen belts encircling the Earth.

Although ions are produced in the upper atmosphere primarily by the action of energetic electromagnetic radiation, they can also be produced in the troposphere by the shearing of water droplets during precipitation. The shearing may be caused by the compression of descending masses of cold air or by strong winds over hot, dry land masses. The last phenomenon is known as the *foehn*, *sharav* (in the Near East), or Santa Ana (in southern California). These hot, dry winds cause severe discomfort. The ions they produce consist of electrons and positively charged molecular species.

Free Radicals

In addition to forming ions by photoionization, energetic electromagnetic radiation in the atmosphere may produce atoms or groups of atoms with unpaired electrons called **free radicals**:



Free radicals are involved with most significant atmospheric chemical phenomena and are of the utmost importance in the atmosphere. Because of their unpaired electrons and the strong pairing tendencies of electrons under most circumstances, free radicals are highly reactive. The upper atmosphere is so rarefied, however, that at very high altitudes, radicals may have half-lives of several minutes, or even longer. Radicals can take part in chain reactions in which one of the products of each reaction is a radical. Eventually, through processes such as reaction with another radical, one of the radicals in a chain is destroyed and the chain ends, as shown by the reaction of two methyl ($\text{H}_3\text{C}\cdot$) radicals below:



This process is a **chain-terminating reaction**. Reactions involving free radicals are responsible for photochemical smog formation. These processes are discussed in Chapter 16.

Free radicals are quite reactive; therefore, they generally have short lifetimes. It is important to distinguish between high reactivity and instability. A totally isolated free radical or atom would be quite stable. Therefore, free radicals and single atoms from diatomic gases tend to persist under the rarefied conditions of very high altitudes because they can travel long distances before colliding with another reactive species. However, electronically excited species have a finite, generally very short lifetime because they can lose energy through radiation without having to react with another species.

Hydroxyl and Hydroperoxyl Radicals in the Atmosphere

The hydroxyl radical, $\text{HO}\cdot$, is the single most important reactive intermediate species in atmospheric chemical processes. It is formed by several mechanisms. At higher altitudes, it is produced by photolysis of water:



In the presence of organic matter, hydroxyl radical is produced in abundant quantities as an intermediate in the formation of photochemical smog (see Chapter 16). To a certain extent in the atmosphere, and for laboratory experimentation, $\text{HO}\cdot$ is made by the photolysis of nitrous acid vapor:



In the relatively unpolluted troposphere, hydroxyl radical is produced as the result of the photolysis of ozone,



followed by the reaction of a fraction of the excited oxygen atoms with water molecules:



Hydroxyl radical is a key species in chemical transformations of a number of trace species in the atmosphere. Some aspects of the involvement of hydroxyl radical in such transformations are discussed in the next two chapters. Among the important atmospheric trace species that react with hydroxyl radical are carbon monoxide, sulfur dioxide, hydrogen sulfide, methane, and nitric oxide.

Hydroxyl radical is most frequently removed from the troposphere by reaction with methane or carbon monoxide:



The highly reactive methyl radical, $\text{H}_3\text{C}\cdot$, reacts with O_2 ,



to form **methylperoxyl radical**, $\text{H}_3\text{COO}\cdot$. (Further reactions of this species are discussed in Chapter 16.) The hydrogen atom produced in Reaction 14.8.17 reacts with O_2 to produce **hydroperoxyl radical**:



The hydroperoxyl radical can undergo chain termination reactions, such as



or reactions that regenerate hydroxyl radical:



The global concentration of hydroxyl radical, averaged diurnally and seasonally, is estimated to range from 2×10^5 to 1×10^6 radicals per cm^3 in the troposphere. Because of the higher humidity and higher incident sunlight, which result in elevated O^* levels, the concentration of $\text{HO}\cdot$ is higher in tropical regions. The Southern Hemisphere probably has about a 20% higher level of $\text{HO}\cdot$ than does the Northern Hemisphere because of greater production of anthropogenic, $\text{HO}\cdot$ -consuming CO in

the Northern Hemisphere.

The hydroperoxyl radical, $\text{HOO}\cdot$, is an intermediate in some important chemical reactions. In addition to its production by the reactions discussed above, in polluted atmospheres, hydroperoxyl radical is made by the following two reactions, starting with photolytic dissociation of formaldehyde to produce a reactive formyl radical:



The hydroperoxyl radical reacts more slowly with other species than does the hydroxyl radical. The kinetics and mechanisms of hydroperoxyl radical reactions are difficult to study because it is hard to retain these radicals free of hydroxyl radicals.

Chemical and Biochemical Processes in Evolution of the Atmosphere

It is now widely believed that the earth's atmosphere originally was very different from its present state and that the changes were brought about by biological activity and accompanying chemical changes. Approximately 3.5 billion years ago, when the first primitive life molecules were formed, the atmosphere was probably free of oxygen and consisted of a variety of gases such as carbon dioxide, water vapor, and perhaps even methane, ammonia, and hydrogen. The atmosphere was bombarded by intense, bond-breaking ultraviolet light which, along with lightning and radiation from radionuclides, provided the energy to bring about chemical reactions that resulted in the production of relatively complicated molecules, including even amino acids and sugars, which are produced and used by living organisms. From the rich chemical mixture in the sea, life molecules evolved. Initially, these very primitive life forms derived their energy from fermentation of organic matter formed by chemical and photochemical processes, but eventually they gained the capability to produce organic matter, " $\{\text{CH}_2\text{O}\}$," by photosynthesis:

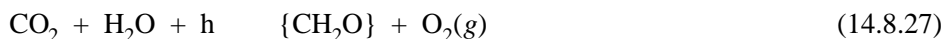

Photosynthesis released oxygen, thereby setting the stage for the massive biochemical transformation that resulted in the production of almost all the atmosphere's O_2 .

The elemental oxygen initially produced by photosynthesis was probably quite toxic to primitive life forms. However, much of this oxygen was converted to iron oxides by reaction with soluble iron(II):



The existence of enormous deposits of iron oxides provides major evidence for the liberation of free O_2 in the primitive atmosphere.

Eventually, enzyme systems developed that enabled organisms to mediate the reaction of waste-product oxygen with oxidizable organic matter in the sea. Later, this mode of waste-product disposal was utilized by organisms to produce energy by respiration, which is now the mechanism by which nonphotosynthetic organisms

obtain energy.

In time, O₂ accumulated in the atmosphere, providing an abundant source of oxygen for respiration. It had an additional benefit in that it enabled the formation of an ozone shield (see Section 14.10). The ozone shield absorbs bond-rupturing ultraviolet light. With the ozone shield protecting tissue from destruction by high-energy ultraviolet radiation, the earth became a much more hospitable environment for life, and life forms were enabled to move from the sea to land.

14.9 ACID-BASE REACTIONS IN THE ATMOSPHERE

Acid-base reactions occur between acidic and basic species in the atmosphere. The atmosphere is normally at least slightly acidic because of the presence of a low level of carbon dioxide, which dissolves in atmospheric water droplets and dissociates slightly:



Atmospheric sulfur dioxide forms a somewhat stronger acid when it dissolves in water:



In terms of pollution, however, strongly acidic HNO₃ and H₂SO₄ formed by the atmospheric oxidation of N oxides, SO₂, and H₂S are much more important because they lead to the formation of damaging acid rain (see Chapter 15).

As reflected by the generally acidic pH of rainwater, basic species are relatively less common in the atmosphere. Particulate calcium oxide, hydroxide, and carbonate can get into the atmosphere from ash and ground rock, and can react with acids such as in the following reaction:

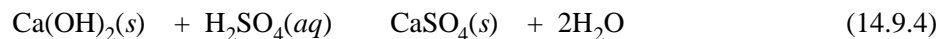

The most important basic species in the atmosphere is gas-phase ammonia, NH₃. The major source of atmospheric ammonia is from biodegradation of nitrogen-containing biological matter and from bacterial reduction of nitrate:



Ammonia is particularly important as a base in the air because it is the only water-soluble base present at significant levels in the atmosphere. When it is dissolved in atmospheric water droplets, ammonia plays a strong role in neutralizing atmospheric acids, as shown by the following reactions:

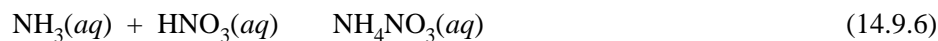

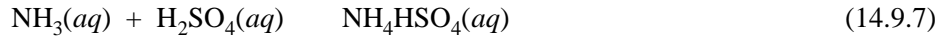

These reactions have three effects: (1) They result in the presence of NH_4^+ ion in the atmosphere as dissolved or solid salts, (2) they serve in part to neutralize acidic constituents of the atmosphere, and (3) they produce relatively corrosive ammonium salts.

14.10 REACTIONS OF ATMOSPHERIC OXYGEN

Some of the primary features of the exchange of oxygen among the atmosphere, geosphere, hydrosphere, and biosphere are summarized in Figure 14.11. The oxygen cycle is critically important in atmospheric chemistry, geochemical transformations, and life processes.

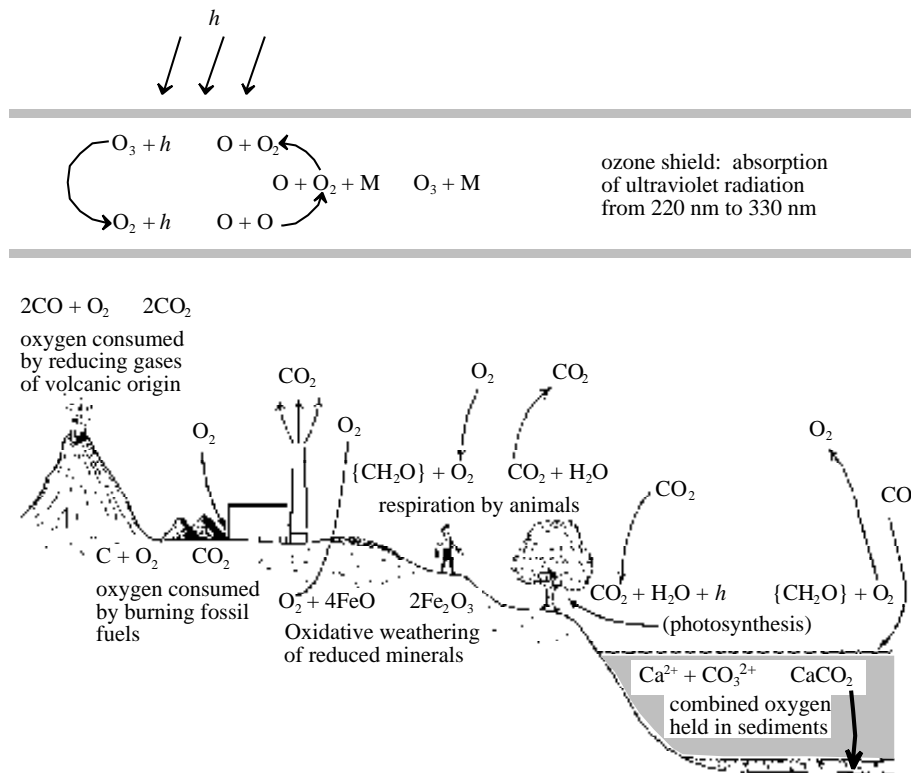
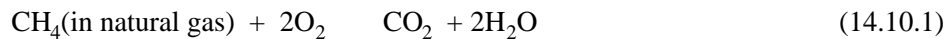

Figure 14.11 Oxygen exchange among the atmosphere, geosphere, hydrosphere, and biosphere.

Oxygen in the troposphere plays a strong role in processes that occur on the earth's surface. Atmospheric oxygen takes part in energy-producing reactions, such as the burning of fossil fuels:



Atmospheric oxygen is utilized by aerobic organisms in the degradation of organic

material. Some oxidative weathering processes consume oxygen, such as



Oxygen is returned to the atmosphere through plant photosynthesis:



All molecular oxygen now in the atmosphere is thought to have originated through the action of photosynthetic organisms, which shows the importance of photosynthesis in the oxygen balance of the atmosphere. It can be shown that most of the carbon fixed by these photosynthetic processes is dispersed in mineral formations as humic material (see Chapter 11, Section 11.9); only a very small fraction is deposited in fossil fuel beds. Therefore, although combustion of fossil fuels consumes large amounts of O_2 , there is no danger of running out of atmospheric oxygen.

Molecular oxygen is somewhat unusual in that its ground state is a triplet state with two unpaired electrons, designated here as $^3\text{O}_2$, which can be excited to singlet molecular oxygen, designated here as $^1\text{O}_2$. The latter can be produced by several processes, including direct photochemical excitation, transfer of energy from other electronically excited molecules, ozone photolysis, and high-energy oxygen-producing reactions.

Because of the extremely rarefied atmosphere and the effects of ionizing radiation, elemental oxygen in the upper atmosphere exists to a large extent in forms other than diatomic O_2 . In addition to O_2 , the upper atmosphere contains oxygen atoms, O ; excited oxygen molecules, O_2^* ; and ozone, O_3 .

Atomic oxygen, O , is stable primarily in the thermosphere, where the atmosphere is so rarefied that the three-body collisions necessary for the chemical reaction of atomic oxygen seldom occur (the third body in this kind of three-body reaction absorbs energy to stabilize the products). Atomic oxygen is produced by a photochemical reaction:



The oxygen-oxygen bond is strong (120 kcal/mole) and ultraviolet radiation in the wavelength regions 135–176 nm and 240–260 nm is most effective in causing dissociation of molecular oxygen. Because of photochemical dissociation, O_2 is virtually nonexistent at very high altitudes and less than 10% of the oxygen in the atmosphere at altitudes exceeding approximately 400 km is present in the molecular form. At altitudes exceeding about 80 km, the average molecular weight of air is lower than the 28.97 g/mole observed at sea level because of the high concentration of atomic oxygen. The resulting division of the atmosphere into a lower section with a uniform molecular weight and a higher region with a nonuniform molecular weight is the basis for classifying these two atmospheric regions as the **homosphere** and **heterosphere**, respectively.

Oxygen atoms in the atmosphere can exist in the ground state (O) and in excited states (O^*). These are produced by the photolysis of ozone, which has a relatively

weak bond energy of 26 kcal/mole at wavelengths below 308 nm,



or by highly energetic chemical reactions such as



Excited atomic oxygen emits visible light at wavelengths of 636 nm, 630 nm, and 558 nm. This emitted light is partially responsible for **airglow**, a very faint electromagnetic radiation continuously emitted by the earth's atmosphere. Although its visible component is extremely weak, airglow is quite intense in the infrared region of the spectrum.

Oxygen ion, O^+ , which may be produced by ultraviolet radiation acting upon oxygen atoms,



is the predominant positive ion in some regions of the ionosphere. Other oxygen-containing ions in the ionosphere are O_2^+ and NO^+ .

Ozone, O_3 , has an essential protective function because it absorbs harmful ultraviolet radiation in the stratosphere and serves as a radiation shield, protecting living beings on the earth from the effects of excessive amounts of such radiation. It is produced by a photochemical reaction,



(where the wavelength of the exciting radiation must be less than 242.4 nm), followed by a three-body reaction,

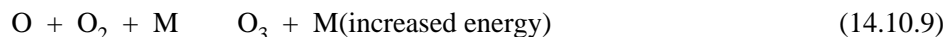

in which M is another species, such as a molecule of N_2 or O_2 , which absorbs the excess energy given off by the reaction and enables the ozone molecule to stay together. The region of maximum ozone concentration is found within the range of 25–30 km high in the stratosphere where it may reach 10 ppm.

Ozone absorbs ultraviolet light very strongly in the region 220–330 nm. If this light were not absorbed by ozone, severe damage would result to exposed forms of life on the earth. Absorption of electromagnetic radiation by ozone converts the radiation's energy to heat and is responsible for the temperature maximum encountered at the boundary between the stratosphere and the mesosphere at an altitude of approximately 50 km. The reason that the temperature maximum occurs at a higher altitude than that of the maximum ozone concentration arises from the fact that ozone is such an effective absorber of ultraviolet light. Therefore, most of the ultraviolet radiation absorbed by ozone is absorbed in the upper stratosphere, where it generates heat, and only a small fraction reaches the lower altitudes, which remain relatively cool.

The overall reaction,



is favored thermodynamically so that ozone is inherently unstable. Its decomposition in the stratosphere is catalyzed by a number of natural and pollutant trace constituents, including NO, NO₂, H, HO•, HOO•, ClO, Cl, Br, and BrO. Ozone decomposition also occurs on solid surfaces, such as metal oxides and salts produced by rocket exhausts.

Despite its essential protective role in the stratosphere, ozone is an undesirable pollutant in the troposphere. It is toxic to animals and plants (see Chapter 23), and it also damages materials, particularly rubber.

14.11 REACTIONS OF ATMOSPHERIC NITROGEN

The 78% by volume of nitrogen contained in the atmosphere constitutes an inexhaustible reservoir of that essential element. The nitrogen cycle and nitrogen fixation by microorganisms were discussed in Chapter 6. A significant amount of nitrogen is fixed in the atmosphere by lightning, which provides the high energy needed to dissociate stable molecules of N₂. Some nitrogen is also fixed by combustion processes, particularly in internal combustion and turbine engines.

Before the use of synthetic fertilizers reached its current high levels, chemists were concerned that denitrification processes in the soil would lead to nitrogen depletion on the Earth. Now, with millions of tons of synthetically fixed nitrogen being added to the soil each year, major concern has shifted to possible excess accumulation of nitrogen in soil, fresh water, and the oceans.

Unlike oxygen, which is almost completely dissociated to the monatomic form in higher regions of the thermosphere, molecular nitrogen is not readily dissociated by ultraviolet radiation. However, at altitudes exceeding approximately 100 km, atomic nitrogen is produced by photochemical reactions:



Nitric oxide, NO, is involved in the removal of stratospheric ozone and is regenerated by the reaction of NO₂ with atomic O, itself a precursor to the formation of ozone. An ion formed from NO, the NO⁺ ion, is one of the predominant ionic species in the so-called E region of the ionosphere.

Pollutant oxides of nitrogen, particularly NO₂, are key species involved in air pollution and the formation of photochemical smog. For example, NO₂ is readily dissociated photochemically to NO and reactive atomic oxygen:



This reaction is the most important primary photochemical process involved in smog formation. The roles played by nitrogen oxides in smog formation and other forms of air pollution are discussed in Chapter 16.

14.12 ATMOSPHERIC WATER

The water vapor content of the troposphere is normally within a range of 1–3% by volume with a global average of about 1%. However, air can contain as little as 0.1% or as much as 5% water. The percentage of water in the atmosphere decreases rapidly with increasing altitude. Water circulates through the atmosphere in the hydrologic cycle as shown in Figure 3.1.

Water vapor absorbs infrared radiation even more strongly than does carbon dioxide, thus greatly influencing the earth's heat balance. Clouds formed from water vapor reflect light from the sun and have a temperature-lowering effect. On the other hand, water vapor in the atmosphere acts as a kind of "blanket" at night, retaining heat from the earth's surface by absorption of infrared radiation.

As discussed in Section 14.5, water vapor and the heat released and absorbed by transitions of water between the vapor state and liquid or solid are strongly involved in atmospheric energy transfer. Condensed water vapor in the form of very small droplets is of considerable concern in atmospheric chemistry. The harmful effects of some air pollutants—for instance, the corrosion of metals by acid-forming gases—requires the presence of water, which may come from the atmosphere. Atmospheric water vapor has an important influence upon pollution-induced fog formation under some circumstances. Water vapor interacting with pollutant particulate matter in the atmosphere may reduce visibility to undesirable levels through the formation of very small atmospheric aerosol particles.

As noted in Section 14.2, the cold tropopause serves as a barrier to the movement of water into the stratosphere. Thus, little water is transferred from the troposphere to the stratosphere, and the main source of water in the stratosphere is the photochemical oxidation of methane:

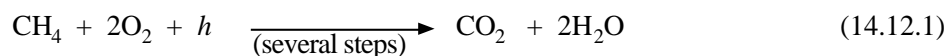

The water thus produced serves as a source of stratospheric hydroxyl radical as shown by the following reaction:

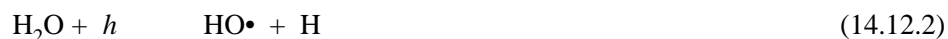

CHAPTER SUMMARY

The chapter summary below is presented in a programmed format to review the main points covered in this chapter. It is used most effectively by filling in the blanks, referring back to the chapter as necessary. The correct answers are given at the end of the summary.

Including water, the five most common gases in the atmosphere listed in decreasing order of their abundance are ¹_____. The bottom layer of the atmosphere is the ²_____ and the next layer up is called the ³_____. The most significant feature of atmospheric chemistry is the occurrence of ⁴_____ resulting from the absorption by molecules of ⁵_____, designated ⁶_____.

In addition to its essential role in protecting organisms from ⁷ _____, the atmosphere serves as a source of carbon dioxide for ⁸ _____ and molecular oxygen used by organisms for ⁹ _____. The important atmospheric trace gases are ¹⁰ _____. At very high altitudes, normally reactive species such as atomic oxygen, O, persist for long periods of time because ¹¹ _____.

The fact that hydrogen has not been lost to outer space from Earth's atmosphere is due to the existence of ¹² _____. The value of the solar constant is ¹³ _____. The three means for moving heat energy through the atmosphere are ¹⁴ _____. The maximum intensity of incoming solar radiation occurs at a wavelength around ¹⁵ _____ and outgoing radiation from Earth has maximum intensity at a wavelength of around ¹⁶ _____. Water and carbon dioxide keep Earth warm by ¹⁷ _____. Albedo refers to ¹⁸ _____. Meteorology is the study of ¹⁹ _____. Short-term variations in the state of the atmosphere constitute ²⁰ _____ defined in terms of ²¹ _____.

Longer-term variations and trends within a particular geographical region in the factors just mentioned are described as ²² _____. Water vapor is particularly important in transferring energy in the atmosphere because it carries energy in the form of ²³ _____. An atmospheric condition that is particularly important for air pollution and sometimes affected by topography is that of ²⁴ _____. A heat dome over cities is an example of ²⁵ _____. Photochemical reactions may be initiated when molecules split apart by absorbing ²⁶ _____ to produce ²⁷ _____. Major categories of gaseous atmospheric chemical species are ²⁸ _____.

An atmospheric molecule designated by an asterisk, such as NO₂^{*}, is ²⁹ _____. An atmospheric species designated with a dot, such as HO[•], is a ³⁰ _____ possessing an ³¹ _____. An electron in an orbital of a molecule promoted to a higher energy level, but still retaining a spin opposite that of its former partner gives a molecule in a ³² _____ state. As applied to photochemistry, the term *h* is the product of ³³ _____ and ³⁴ _____ and is equal to ³⁵ _____.

Having absorbed energy from a photon of electromagnetic radiation, loss of energy by a reaction such as O₂^{*} → O + O is known as ³⁶ _____ whereas loss of energy by the immediate emission of light is ³⁷ _____. A region of the atmosphere that raises at night is the ³⁸ _____ characterized by the presence of ³⁹ _____. The reaction H₃C[•] + H₃C[•] → C₂H₆ showing the combination of two ⁴⁰ _____ is an example

of a ⁴¹ _____. The single most important reactive intermediate species in atmospheric chemical processes is ⁴² _____. A related species containing two oxygen atoms is ⁴³ _____. The atmosphere is normally at least slightly acidic because of the presence of a low level of ⁴⁴ _____. More strongly acidic pollutant acids found in the atmosphere are ⁴⁵ _____. The only water-soluble base present at significant levels in the atmosphere is ⁴⁶ _____. The reaction $O_2 + h\nu \rightarrow O + O$ is of particular importance in the stratosphere because it ⁴⁷ _____. The atmospheric “nonpollutant” species of most concern is ⁴⁸ _____ because of its potential to cause ⁴⁹ _____.

Answers to Chapter Summary

1. $N_2 > O_2 > H_2O > \text{argon} > CO_2$
2. troposphere
3. stratosphere
4. photochemical reactions
5. light photons
6. h
7. ultraviolet radiation
8. photosynthesis
9. respiration
10. those shown in [Figure 14.1](#)
11. the pressure is so low that they travel long distances before colliding with any other species with which they can react
12. the very cold tropopause
13. 1.34×10^3 watts per square meter
14. conduction, convection, and radiation
15. 500 nanometers in the visible region
16. 500 nanometers
17. absorbing outgoing infrared radiation
18. the percentage of solar radiation reflected from Earth’s surface
19. the movement of air masses, heat, wind, and transitions of water in the atmosphere
20. weather
21. temperature, clouds, winds, humidity, horizontal visibility, type and quantity of precipitation, and atmospheric pressure
22. climate
23. latent heat
24. temperature inversion
25. microclimate
26. photons of electromagnetic radiation
27. radicals
28. inorganic oxides, oxidants, reductants, organics, oxidized organic species, photochemically active species, acids, bases, salts, and unstable reactive species such as HO• radical

29. an electronically excited molecule
30. free radical
31. unpaired electron
32. excited singlet
33. Planck's constant, h
34. the frequency of electromagnetic radiation,
35. the energy of a quantum of electromagnetic radiation
36. dissociation
37. fluorescence
38. ionosphere
39. ions
40. (methyl) radicals
41. chain-terminating reaction
42. the hydroxyl radical, HO•
43. the hydroperoxyl radical, HOO•
44. carbon dioxide
45. HNO₃ and H₂SO₄
46. ammonia, NH₃
47. leads to the formation of protective ozone
48. carbon dioxide
49. global warming

SUPPLEMENTAL REFERENCES

Barker, John R., "A Brief Introduction to Atmospheric Chemistry," *Advances Series in Physical Chemistry*, **3**, 1–33 (1995).

Barker, John R., Ed., *Progress and Problems in Atmospheric Chemistry*, World Scientific, 1995.

Berner, Elizabeth Kay, and Robert A. Berner, *Global Environment: Water, Air, and Geochemical Cycles*, Prentice Hall, Upper Saddle River, NJ, 1996.

Birks, John W., Jack G. Calvert, and Robert W. Sievers, Eds., *The Chemistry of the Atmosphere: Its Impact on Global Change*, American Chemical Society, Washington, D.C., 1993.

Board on Atmospheric Sciences and Climate, Commission on Geosciences, Environment, and Resources, National Research Council, *The Atmospheric Sciences: Entering the Twenty-First Century*, National Academy Press, Washington, D.C., 1998.

Boubel, Richard W., Donald L. Fox, and D. Bruce Turner, *Fundamentals of Air Pollution*, 3rd ed., Academic Press, Orlando, FL, 1994.

Bradley, Raymond S., and Philip D. Jones, Eds., *Climate Since A.D. 1500*, Routledge, Chapman and Hall, New York, 1992.

Brasseur, Guy P., John J. Orlando, and Geoffrey S. Tyndall, Eds., *Atmospheric Chemistry and Global Change*, Oxford University Press, New York, 1999.

Crutzen, Paul J. and Veerabhadran Ramanathan, *Clouds, Chemistry and Climate*, Springer, Berlin, 1996.

Finlayson-Pitts, Barbara J. and James N. Pitts, *Atmospheric Chemistry*, John Wiley & Sons, New York, 1986.

Goody, Richard, *Principles of Atmospheric Physics and Chemistry*, Oxford University Press, New York, 1995.

Graedel, Thomas E. and Paul J. Crutzen, *Atmosphere, Climate, and Change*, W.H. Freeman, New York, 1995.

Jacob, Daniel J., *Introduction to Atmospheric Chemistry*, Princeton University Press, Princeton, NJ, 1999.

Lutgens, Frederick K., Edward J. Tarbuck, and Dennis Tasa, *The Atmosphere: An Introduction to Meteorology*, 7th ed., Prentice Hall, Englewood Cliffs, NJ, 1997.

Morawska, L., N. D. Bofinger, and M. Maroni, *Indoor Air, an Integrated Approach*, Elsevier Science, Inc., Tarrytown, NY, 1995.

Neckers, Douglas C., David H. Volman, and Günther von Büнау, Eds., *Advances in Photochemistry*, Vol. 23, John Wiley and Sons, Inc., New York, 1997.

Singh, Hanwant B., Ed., *Composition, Chemistry, and Climate of the Atmosphere*, Van Nostrand Reinhold, New York, 1995.

Soroos, Marvin S., *The Endangered Atmosphere: Preserving a Global Commons*, University of South Carolina Press, Columbia, SC, 1997.

Spellman, Frank R., *The Science of Air: Concepts and Applications*, Technomic Publishing Company, Lancaster, PA, 1999.

Yung, Y. L. and William B. Demore, *Photochemistry of Planetary Atmospheres*, Oxford University Press, New York, 1998.

Zellner, R. and H. Hermann, "Free Radical Chemistry of the Aqueous Atmospheric Phase," *Advances in Spectroscopy*, **24**, 381-451 (1995).

QUESTIONS AND PROBLEMS

1. What phenomenon is responsible for the temperature maximum at the boundary of the stratosphere and the mesosphere?
2. What function does a third body serve in an atmospheric chemical reaction?
3. Why does the lower boundary of the ionosphere lift at night?
4. Considering the total number of electrons in NO_2 , why might it be expected that the reaction of a free radical with NO_2 is a chain-terminating reaction?
5. The average atmospheric pressure at sea level is 1.012×10^6 dynes/m². The value of g (acceleration of gravity) at sea level is 980 cm/sec². What is the mass in kg of the column of air having a cross-sectional area of 1.00 cm² at the earth's

surface and extending to the limits of the atmosphere? (Recall that the dyne is a unit of force, and force = mass \times acceleration of gravity.)

- Suppose that 22.4 liters of air at STP is used to burn 1.50 g of carbon to form CO_2 , and that the gaseous product is adjusted to STP. What is the volume and the average molar mass of the resulting mixture?
- If the pressure is 0.01 atm at an altitude of 38 km and 0.001 at 57 km, what is it at 19 km (ignoring temperature variations)?
- Measured in μm , what are the lower wavelength limits of solar radiation reaching the earth; the wavelength at which maximum solar radiation reaches the earth; and the wavelength at which maximum energy is radiated back into space?
- Of the species O , HO^* , NO_2^* , H_3C^* , and N^+ , which could most readily revert to a nonreactive, "normal" species in total isolation?
- Of the gases neon, sulfur dioxide, helium, oxygen, and nitrogen, which shows the most variation in its atmospheric concentration?
- A 12.0-liter sample of air at 25°C and 1.00 atm pressure was collected and dried. After drying, the volume of the sample was exactly 11.50 L. What was the percentage *by weight* of water in the original air sample?
- The sunlight incident upon a 1 square meter area perpendicular to the line of transmission of the solar flux just above the earth's atmosphere provides energy at a rate most closely equivalent to: (a) that required to power a pocket calculator, (b) that required to provide a moderate level of lighting for a 40-person-capacity classroom illuminated with fluorescent lights, (c) that required to propel a 2500-pound automobile at 55 mph, (d) that required to power a 100-watt incandescent light bulb, (e) that required to heat a 40-person classroom to 70°F when the outside temperature is -10°F .
- At an altitude of 50 km, the average atmospheric temperature is essentially 0°C . What is the average number of air molecules per cubic centimeter of air at this altitude?
- What is the distinction between chemiluminescence and luminescence caused when light is absorbed by a molecule or atom?
- State two factors that make the stratosphere particularly important in terms of acting as a region where atmospheric trace contaminants are converted to other, chemically less reactive, forms.
- What two chemical species are most generally responsible for the removal of hydroxyl radical from the unpolluted troposphere.
- What is the distinction between the symbols $*$ and \bullet in discussing chemically active species in the atmosphere?
- Explain the meaning of " h " when it appears in an atmospheric chemical reaction. What does it have to do with the wavelength of electromagnetic

radiation? What is its relationship to energy?

19. What is the most abundant hydrocarbon in the atmosphere? What is its significance in relation to pollutant formation in the atmosphere?
20. In terms of Earth's heat balance, what is the significance of the wavelengths of electromagnetic radiation by which Earth receives most of its energy and by which it loses the energy that it receives?
21. Look up the diameter of Earth. With that information, justify the statement that Earth's atmosphere is "tissue thin." What does this fact have to do with the vulnerability of Earth's atmosphere to human insult?
22. In what respect is the troposphere homogeneous in respect to composition? With respect to which important constituent is it definitely not homogeneous?
23. Chapter 2 discusses some important properties of water as they relate to heat absorbed and released by water in various states. Discuss what these properties have to do with Earth's climate.
24. What is the tropopause? What crucial protective function does it serve?
25. What is the value of the solar constant? If energy falling on Earth at the top of the atmosphere could be collected with 100% efficiency, estimate how many square meters of solar energy collector would be required to provide the energy needs of a medium-size house. Explain why only a small fraction of this energy could be utilized in practice.
26. After examining [Figure 14.4](#), suggest a class of pollutants that might counteract the effects of greenhouse gases.
27. What is the distinction between wind and air currents? How might these phenomena be involved in air pollution?
28. List and discuss the factors that make the laboratory study of atmospheric chemical phenomena so difficult.
29. List one characteristic of all free radicals. What is a characteristic common to all ions? How are the processes leading to their formation similar?
30. Figure 14.12 shows an annual fluctuation in global CO₂ levels. What causes this fluctuation? Does it have any implications for the potential control of greenhouse warming?
31. Give a reaction that explains why NO₂ is a key species involved in air pollution and the formation of photochemical smog.
32. In the reaction $O + O_2 + M \rightarrow O_3 + M$, what is "M" and why is it important in some atmospheric processes? What would likely happen to O₃ if "M" were not present?